

Economic Map of Europe

Transport, Communication and Energy Infrastructures in a Wider Europe

A. Grübler and N. Nakićenović

Every aspect of mobility has been more or less reshaped by our liberation from the immediate present which the new technologies for transportation and communication have provided.

T. Hägerstrand (1987)

1. Introduction

Transport and communication infrastructures, together with their respective “software” (formal and informal operation rules), are the backbone of complex networks of human interaction and spatial mobility. The development of infrastructures and the increase in mobility are, thus, closely coupled. Mobility is a concept sometimes used in different contexts. It can denote flexibility in the allocation of production factors, or flexibility in moving from one social stratum to another. In the context of transport and communication systems, mobility refers to the movement of people, goods and information to and from spatially separated locations.

The explosive improvement in man’s capabilities to move people, goods and information during the last century, has drastically increased all manifestations of mobility: physical, geographical, social, economic, political, etc. In a wider sense, the mobility of thought and freedom of ideas is a precondition for cultural development and societal capacity to adjust to a changing environment. Modern transport technologies,

such as the automobile or air plane, together with modern communication technologies, such as the telephone or telefax, have dramatically transformed the patterns of economic and social interaction by integrating distinct geographical spaces into mutually and functionally interrelated entities. On a more abstract level *space* can also be defined along a "socio-economic topology". Such an abstract topology of spaces can be represented, for instance, by various density and intensity indicators.

Substantial phenomenological evidence confirms the fact that transport and communication infrastructures can reduce the distance between geographically separated cities by decreasing the "friction of space". Very productive infrastructures sometimes result in the "collapse" of an actual physical separation, yielding a single functional unit. These cases most clearly illustrate the effects of the removal of barriers. For example, a system of bridges and tunnels that is capable of handling a large flux of people and goods can connect separate settlements into a single functional city. A hypothetical maglev transport system of the more distant future, capable of carrying passengers and goods at speeds that exceed those of modern jet transports, could by analogy connect different cities and urban corridors into a continental settlement supercluster (a so-called *ecumenopolis*). In the past, urban clusters have condensed along important transport and communication infrastructures, such as railway lines with telegraph wires running next to them. Current examples include the Tokyo-Osaka corridor served by the Shinkansen train, the Boston-New-York-Washington corridor linked by rapid rail and air shuttles, and the Ruhr area in Germany transversed by *Autobahnen*.

Many aspects of the revolutionary increase in human mobility and interaction, resulting from modern transport and communication infrastructure development, are well known. However, the fundamental impact on mobility of what can be termed the "software" of transport and communication systems has not been studied to such an extent as transport and communication technologies proper. Thus, the effects of organisational aspects, such as formal and informal operation rules, and the institutional and political dimensions that can exert a repulsive or attractive force on mobility, are only partially understood. For example, it is not really known what the potential magnitude and range of effects of removing barriers would be. Similar to physical infrastructures, barrier removal certainly reduces the "friction of space". The difference, however, is that whereas the effects and impacts on the mobility of new infrastructures have been studied, the effects of barrier removal have not and are highly uncertain. Perhaps it could be said that barrier removal is equivalent to creating a potential for mobility,

while only infrastructures allow the conversion of this potential into actual mobility increases. Conversely, an infrastructure built without an "attractor" potential will not be utilised. As an illustration, it is known that national borders in Europe tend to reduce the mobility between cities by a factor of four, compared to similar city sizes and distances within a given country. This means that European integration in 1992, or the effects of *perestroika* in Eastern Europe, could both lead to a reduction of the friction between flows of people, goods and information within a "wider Europe" (West of the Urals).

The objective of this study is to provide a quantitative representation of spatial patterns of present-day mobility in Europe focusing on transport, communication and energy infrastructures. This "quantitative" map of Europe will then be used to determine what the possible effects would be if barriers to mobility were removed. This would include examples of both the development of new physical infrastructures (e.g., a high-speed rail network), and the reduction of institutional and political obstacles (e.g., the iron curtain).

2. Economic and Spatial Characteristics of Europe

The old continent of Europe is often referred to as a single entity. In comparison to the new world and other parts of the globe this indeed may be appropriate. It is, however, a definition that is far removed from the actual demographic, cultural, social or economic conditions that prevail. Europe is very heterogeneous. The spatial distribution with respect to economic development levels is almost unimodal: the highest density of activities being in the "core" and tapering off towards the rim. Moving outwards towards the more distant peripheries in the South and East, this decreases even further. The core almost coincides with the Community countries, but also includes other developed regions in (Southern) Scandinavia and Central Europe (Switzerland and Austria). The gradient between Europe's core, its rim and the more peripheral regions can be represented here as a three-tier structure, providing a conceptual taxonomy of European countries (see box on p.4). This spatial classification of Europe into three regions is mirrored in almost all indicators of economic activity and spatial interaction, as reflected in the flows of people, information and goods.

In terms of economic, human or spatial interaction indicators, the "functional distance" (i.e., the friction of distance intervening in the interaction) defines whether a particular region or country can be considered as part of the core's rim or periphery. Thus, there is no rigid

A Geographical Taxonomy of Europe

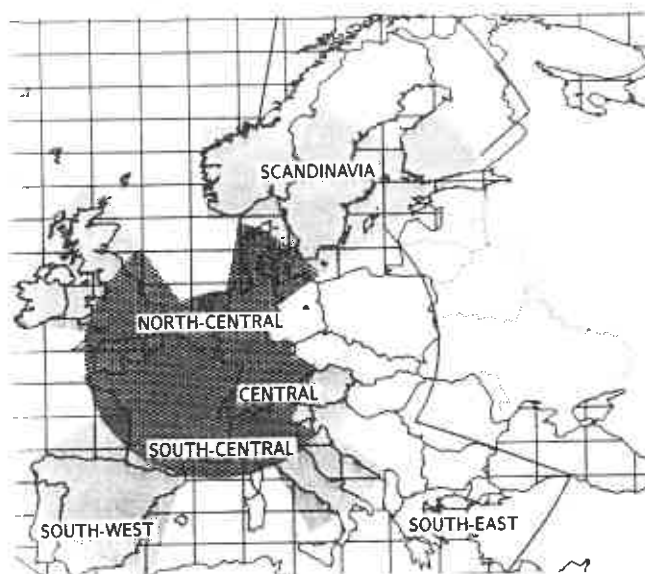

Geographically Europe may be roughly divided into six zones based on geographical latitude: Scandinavia, North-central, Central, South-central, and finally South-western and South-eastern Europe. This geographical classification is used in the economic maps presented in this report, with country specific indicators located on the same latitudes for those countries belonging to a particular geographical "regional belt". In addition to the geographical divisions based on latitude, we also distinguish between a European *core*, *rim* and *periphery*, and the rest of Europe west of the Urals.

The European *core* is characterised by the highest levels of economic activity, mobility and intensity of economic and social interaction and integration. This intensity of activities and interactions thins out towards the European rim and especially towards the periphery. Due to its lack of integration Eastern Europe or the western part of the USSR could to date not even be considered as part of the European periphery, showing instead a level of integration characteristic for distant continents like Africa or Latin America.

Different degrees of interconnectedness define whether a particular country belongs to the European core, rim or periphery. Thus no rigid delineation of the borders of regions following the above spatial taxonomy is possible. Instead it depends on the specific economic, social or cultural integration indicator considered. However, unless otherwise specified the following country breakdown is used, defining zones of decreasing interaction from the European core out to its periphery:

<i>Core</i>	Belgium, Denmark, FRG, France, Italy, Luxembourg, Netherlands, Switzerland, United Kingdom.
<i>Rim</i>	Austria, Ireland, Finland, Norway, Spain, Sweden.
<i>Periphery</i>	Greece, Portugal, Turkey, Yugoslavia.
<i>Eastern EU</i>	Albania, Bulgaria, Czechoslovakia, GDR, Hungary, Poland, Romania.
<i>Western USSR</i>	Belorussia, Estonia, Latvia, Lithuania, Moldavia, Ukraine.
<i>RSFSR</i>	Russian Soviet Federative Socialist Republic (rest of USSR west of Urals and Siberia).

spatial delimitation of rim or periphery, instead there exist fuzzy, interlaced overlaps depending on the particular indicator considered. Therefore, the spatial taxonomy of Europe, as defined above, has to be modified sometimes to reflect better the varying degrees of interconnection within Europe for given classes of indicators.

The only sharp delineation in a European context was represented by the iron curtain. For some 40 years the iron curtain separated Eastern Europe both spatially and functionally from the rest of Europe. Politically and economically Eastern European countries have been so decoupled that apart from a few exceptions (most notably for the export of primary commodities), they could not even be considered as being part of the European periphery, such as, for example, Portugal, Southern Yugoslavia or Turkey. Instead, Eastern Europe's level of integration was more representative of continents like Africa, Asia or Latin America. With the removal of political and institutional barriers this "apartheid" of the two Europes is on the verge of disappearing. The principal question therefore is what are the likely scenarios for the future integration and interaction of Eastern Europe with the Central European core, rim and periphery. The central issue is whether Eastern Europe west of the Urals will emerge as part of the European periphery, or achieve a level of integration characteristic for the European rim as exemplified by Southern Scandinavia and Austria. Finally, some regions and countries (most notably the GDR, but also parts of Czechoslovakia and Hungary) may even evolve in future as part of the European core proper.

Table 1 summarises some of the main macro indicators for 1986 following the above functional distinction between a European core, rim and periphery, and contrasts this with Eastern Europe, the Western USSR, and the RSFSR (the Russian Soviet Federative Socialist Republic). Throughout the study, the latest available year providing consistent data, including Eastern Europe, is presented.

Using gross domestic product (GDP, i.e. the value of all goods and services produced) as proxy for the actual extent of economic activities clearly shows that the highest level of development, with GDP levels well in excess of US \$ 10,000 per capita, has been achieved in the core regions. In comparison, the per capita GDP is only about one-fourth of that amount in Portugal, Yugoslavia and Greece. While the accuracy of the relative assessments of economic development is debatable when measured by a rough and, in many ways, deficient indicator such as GDP, there are serious obstacles to determining any aggregate measure of economic activities in the Eastern European countries. Socialist countries traditionally report only their net material products, which excludes most of the services and also depreciation. This is

Table 1. Area, Population and GDP of European Regional Aggregates in 1986.

	Area 10 ⁶ km ²	Population 10 ⁶	GDP 10 ¹² US \$	Inhabitants per km ²	10 ³ US \$ GDP per capita
Core	1.5	266.9	3.2	178.0	11.9
Rim	1.7	67.2	0.6	38.8	8.8
Periphery	1.3	93.8	0.2	74.4	1.9
Eastern EU	1.0	113.9	0.3	111.8	2.2
Western USSR	1.0	73.3	0.2	71.9	2.4
RSFSR	17.1	145.3	0.4	8.5	2.9

(See box on page 4 for definition of regions.)

compounded by the general problem of a monetary indicator comparison of non-convertible currencies. Our estimates of their per capita GDP, despite a high level of uncertainty, indicate degrees of development characteristic for the Southern European periphery.

In contrast to the relatively low levels of economic development (in terms of estimated per capita GDP), energy consumption per head in Eastern Europe is considerable, even by the standards of the highly affluent European core. Table 2 shows that Russia proper (RSFSR) consumes more primary energy per capita [above 5 ton oil equivalent (toe)] than the European core region (3.7 toe/capita on average). This is not, however, reflected in the final energy delivered, which is about the same level as in the European core. This points at two critical deficiencies in the current energy system of Eastern Europe. Most important is that the efficiency of energy conversion is very low: up to half of the primary energy is used in conversion for the supply of final energy as opposed to about one-fourth in the more efficient European core region.

Furthermore, the value added achieved per unit of final energy consumed is dismally low, even when compared to the European periphery, i.e., Southern Europe. In the European core close to US \$ 5,000 (1986 Dollars) GDP are generated per toe final energy consumed, compared to about US \$ 1,000 in Eastern Europe or in the Soviet Union. Of course, these regional aggregates mask even more dramatic differences in the value generated per unit of final energy consumed, as a result of the different economic structures and efficiency of the energy systems in individual countries. The extremes range from US \$ 7,000 GDP per toe final energy consumed (Switzerland), to as low as US \$ 700 per toe as in Romania.

Thus, Eastern Europe's energy intensity is high and conversion efficiency low. This can be explained both by the structure of the

Table 2. Primary and Final Energy Consumption for European Regional Aggregates in 1987.

Area	Primary Mtoe	Final Mtoe	Final in % of primary	toe Primary per capita	toe Final per capita	10 ³ US \$ GDP per toe final
Core	980.5	710.5	72.5	3.7	2.7	4.5
Rim	225.2	150.1	66.7	3.3	2.2	3.9
Periphery	122.5	82.0	67.0	1.3	0.9	2.2
Eastern EU	431.3	274.4	63.6	3.9	2.5	0.9
Western USSR	293.3	160.1	54.6	4.1	2.2	1.1
RSFSR	831.9	415.6	50.0	5.7	2.9	1.0

energy systems in these countries, which rely mainly on coal, and by the structure of their economies which rely heavily on the so-called primary sector composed mostly of traditional smoke-stack industries. Both the low efficiency of energy use and the coal intensive energy supply mix result in extreme environmental burdens. This is exemplified in all energy-related emissions, which result in environmental impacts ranging from acid rain to global warming. Unfortunately this is one of the few areas in which Europe is fully integrated. The atmosphere does not respect political and national boundaries, so dispersion of air pollutants from regions of Eastern Europe with high coal use pose a heavy burden not only on the local environment but equally on the European core.

The differences in environmental impacts between the European core and Eastern Europe are most vividly exemplified in carbon dioxide (CO₂) emissions: For instance, the highest per capita CO₂ emissions in excess of four tons per capita (5.6 tons carbon/capita in the GDR), are observed in those countries and regions with the highest share of coal in the primary energy mix (GDR, Czechoslovakia and the Ukraine). The largest difference in per capita CO₂ emissions per unit of final energy consumed can be observed between Norway, 0.5 tons carbon per toe final energy and the GDR with 1.5 tons CO₂ per toe (i.e., a factor of three). In terms of carbon emissions per unit of GDP generated, the difference is even larger: up to a factor of about 25 between Switzerland (0.08 tons carbon per US \$ 1,000 GDP) and the Ukrainian SSR (1.88 tons carbon per US \$ 1,000 GDP). The CO₂ emissions are among the indicators that reveal the sharpest distinction between the relatively highly efficient and service-oriented economies of the core, and the energy intensive industrial structure of the Eastern periphery, which resembles the industrialisation path of the European core countries about half a century ago.

3. Infrastructures and Intensities

As with CO₂ emissions, there is a large difference in the structure and level of goods transported per capita between the European core and the rest of Europe. Table 3 shows that these differences are especially pronounced in comparison to the East European countries.

Table 3. Intensity of Goods Transport* for European Regional Aggregates in 1986.

Area	10 ³ t-km per capita	tons per capita	t-km per US \$ GDP	tons per 1,000 US \$ GDP
Core	2.9	35.3	0.25	3.0
Rim	3.9	36.0	0.44	4.1
Periphery	1.5	8.0	0.80	4.2
Eastern EU	4.7	46.8	2.11	21.3
Western USSR	10.9	n.a.	4.59	n.a.
Rest of USSR**	18.2	n.a.	7.24	n.a.
USSR	16.3	41.2	6.59	16.7
USSR***	28.4	46.5	11.48	18.8

* Excluding sea, air and pipeline transportation.

** Data on the RSFSR were not available.

*** All transport modes, including oil and gas pipelines.

Due partly to the vast geographical areas involved, especially in the USSR, the absolute and per capita level of ton-km transported is substantially higher here than in the European core and rim. This is true even for countries with high population densities, such as the GDR, Czechoslovakia and Hungary. The difference in the per capita goods tonnage transported is less pronounced, but Eastern Europe and the USSR still show generally higher intensities than Western Europe. The volume of goods transported in East European economies is particularly large in relation to the value added, illustrating their material intensiveness. The high level of bulk transport, i.e., low-value goods and commodities, such as primary materials and intermediate products, is reflected by the high share of railways in the goods transport system structure. This is in perfect symmetry with the large share of coal in the primary energy balance of these countries; in fact, most railway operations are dedicated to coal transport.

In contrast, the European core has already achieved a higher degree of value and information intensity with a corresponding dematerialisation. High-value goods need good quality and flexible transport systems, and this is provided by modern road infrastructures and truck

delivery. Nevertheless, a number of unique geographical and infrastructural features of the individual countries need to be highlighted. Apart from the fact that countries with vast areas need extensive transport activities, other special features include a substantial share of inland water transport in the Netherlands, France and the FRG, and a high share of pipeline transport for natural gas and oil in the Soviet Union. In fact, because of the enormous quantities and immense distances, energy is now the most important commodity carried in the Soviet Union, accounting for about 35 percent of all ton-kilometers transported.

People and valuable goods need high quality transport systems. Consequently, it is not surprising that the preferred mode of passenger travel throughout Europe is road transport, with air transport growing rapidly. Considering the large differences in the intensity and structure of goods transportation, it is surprising that the per capita passenger travel intensity is quite comparable between the European rim and Eastern Europe. Table 4 shows that the annual per capita travel ranges between 6,000 km in the European rim and Eastern Europe to 10,000 km in the European core. The only exceptions are the Southern periphery and the Soviet Union, which have much lower mobility levels, typically in the order of 3,500 passenger-km per capita. A further similarity is that most of the passenger travel throughout Europe is by road. The only exception again being the USSR with a more evenly balanced modal split in passenger traffic.

Table 4. Passenger Travel Mobility* for European Regional Aggregates (in km per capita per year) in 1986.

Area	Rail	Road	Air	Total
Core	756	9,269	85	10,110
Rim	537	6,317	150	7,004
Periphery	279	3,158	43	3,480
Eastern EU	1,271	4,324	12	5,607
Western USSR	1,312	1,640	n.a.	n.a.
Rest of USSR	1,472	1,395	n.a.	na.
USSR	1,431	1,459	726	3,616

* Only domestic passenger travel.

From the core to the periphery, transport infrastructures are utilised under different regimes that reflect the modal shares in goods and passenger transport. For example, Table 5 shows that the utilisation of railroads per km of network is ten times larger in the USSR than in the European core. Inside the railway network of the USSR, the differences

in the usage intensity vary even more dramatically. In 1978, the last year data were reported, the 1,250 busiest km railway lines carried over 178 billion ton-km: more than the whole railway network of Austria, France, FRG and Switzerland combined. In the meantime, the volume of freight transport has increased throughout the Soviet Union. Contrary to this observation, Table 6 shows that the spatial railway density of the USSR is only about one-tenth of the current densities in the European core. This emphasises the low utilisation of the railway network in the core and indicates why half of the central European railway networks have been decommissioned since the 1930s.

Table 5. Intensity of Railway and Road Infrastructure Use for European Regional Aggregates in 1986.

Area	Per km railway line		Per km road		
	10 ⁶ pass-km	10 ⁶ ton-km	10 ⁶ pass-km	10 ⁶ ton-km	Cars
Core	1.9	3.4	1.1	1.3	46.2
Rim	0.8	1.9	0.7	1.0	36.0
Periphery	1.1	2.7	1.6	2.2	37.2
Eastern EU	1.7	6.3	1.1	1.3	31.6
Western USSR	2.3	18.6	0.4	0.7	11.6
Rest of USSR	2.9	32.2	0.3	0.8	11.6
USSR	2.8	28.9	0.3	0.8	11.6

Table 6. Density of Railway and Road Infrastructures for European Regional Aggregates in 1986.

Area	Per 100 km ²		Per 10,000 capita			Railways as
	Railways	Roads	Railways	Roads	Incl. highways	% of total
Core	7.2	150.3	4.0	84.4	1.1	4.6
Rim	2.6	32.8	6.7	84.4	0.7	7.3
Periphery	1.9	14.4	2.5	19.3	0.1	11.7
Eastern EU	8.5	55.7	7.1	47.1	0.4	9.0
Western USSR	3.4	34.2	4.8	47.6	n.a.	13.2
Rest of USSR	0.5	4.0	5.4	40.8	n.a.	11.6
USSR	0.7	5.3	5.2	42.5	n.a.	10.9

An even larger asymmetry can be seen in the very high ratio of passengers to freight transport on the railways in the USSR and Eastern Europe, as opposed to the structure of rail transport in the

European core. The only remaining market segment that has been maintained by the railways in the European core consists mostly of low-value density goods transport and commuter travel.

Although road transport comprises a major share in passenger transport throughout Europe, road infrastructure endowments are unequal. The core region has the highest road network density both per capita and land area. The core has also the highest automobile ownership rates. Whereas total road infrastructure density per capita or km² in most countries is approaching saturation, one can observe a continuing growth in the extent of high capacity road infrastructure in the form of highways. Particularly noteworthy is the low road infrastructure endowment levels of the Southern European periphery (less than half of the road density of Eastern Europe) resulting in high intensity of use, whereas the road networks of the USSR appear to be underutilised especially for passenger travel. In this context, the very low car density per km road network of the Soviet republics are particularly striking. This indicates that the Soviets have very few cars for the size of the road network already in place, whereas the Southern European periphery appears to be in need of a significant upgrading of its road infrastructure, especially for high capacity links.

The discrepancy between the European core, its periphery and, especially Eastern Europe is even larger considering the high quality of roads and vehicles in the core countries: cars are not only more comfortable and faster but also more fuel efficient. An important issue in this context is the likelihood of the other countries catching-up to the vehicle ownership levels prevailing in the core countries. To a large extent this is also a function of the development strategies taken by these countries. The prevailing economic stagnation has, for example, already reduced the number of cars registered in Poland. It is indeed likely that in the future road transport will continue to increase in Eastern Europe, but any massive diffusion of car ownership cannot happen overnight, it instead will rather take two to three decades. In the meantime, additional growth in mobility will have to rely on buses, railways and aircraft.

Air travel is the premium long-distance transport mode and, as such, reflects the spatial links and density of interaction on a European scale most dramatically. Air travel patterns illustrate how disconnected East European countries are from the European core and its rim. In relative (per capita) terms there are very few arrivals at East European airports from other European countries. The high density of European travel within the core, given the rather small number of air corridors open and distances traveled, gives a pictorial impression of the congestion over European airspace. Although this is not the next step

towards an all European integration, there are only two ways out of this impasse: either to fly over Eastern Europe or North Africa, or to demilitarise (at least the air space) in the core.

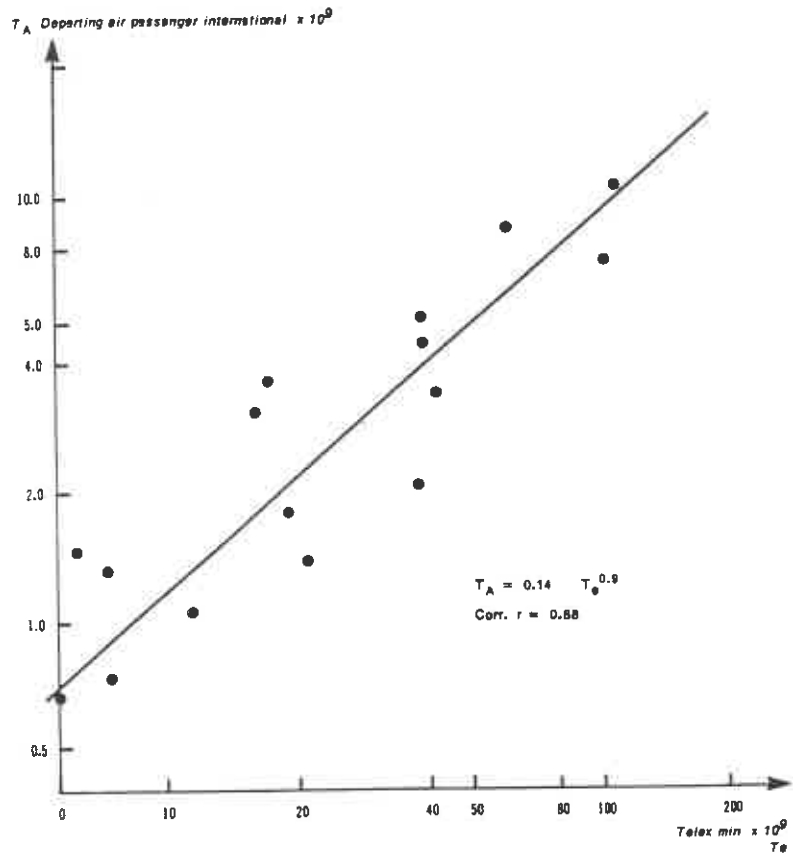

Figure 1. Relationship of Physical Travel and Communication in Europe.

Mobility is not solely a question of physical travel but also one of access to information and interpersonal communication. In fact, mobility and communication are closely related, as illustrated in Figure 1. This is an area where the East European countries particularly lag behind the European core and rim, as illustrated in the low density and availability of communication networks and devices. In Eastern Europe one telephone line is typically shared by 6 parties compared to 2.5 in the European core and rim. In the USSR and the Southern periphery, communication networks are even less developed: between 9 (European periphery) and 11 parties have to share one telephone line. Thus, the North-South, and especially the East-West gap, is particularly large in terms of the number of telephone lines available per capita and is slightly lower in terms of telephone ownership. Nevertheless, no matter how many telephones are connected to a line, this does not necessarily make the network availability better. For example, the

GDR practices a very curious time-sharing arrangement: during the day the lines are reserved for company and official use and only after 7 p.m. do they become available to private parties. The lag in communication systems is so large that free access to and information about the networks is not even considered as vital. For example, the first Moscow telephone book was printed only last year, is not available for purchase and contains only a fraction of the actual telephone numbers in the city.

4. Spatial Interaction

Spatial interaction in Europe is represented by large metropolitan areas that act as gravity centers and are interconnected by flows. The flux of people and goods is the outcome of the mutually attractive force of the gravity centers and an expression of their degree of integration. This representation reveals densely concentrated flows in the European core that thin out towards the periphery. Most of the interaction mass is centered in the pentagon London-Paris-Milan-Frankfurt-Amsterdam. This is the inner core of Europe. This high density of interaction is an expression of the high level of economic activity, integration and resulting interdependence of inner Europe.

The dominance of interaction within the inner European core compared to the rim and periphery is most vividly illustrated by the flow of air passengers between cities, given in Figure 2. We can define three hierarchical levels of interaction, each corresponding to a particular level of air traffic flow. The first one interconnects the pentagon within inner Europe. Most traffic is concentrated in a narrow corridor between England, France and the Benelux countries, West Germany, Switzerland and Northern Italy. Passenger flows are typically in excess of half a million per year. A second hierarchical level shows the strong interaction between the European core, the remaining community countries, Austria and Scandinavia. Passenger flows between 0.25 and 0.5 million are typical for second level hierarchy air connections. The third hierarchical level finally presents the interconnections between the European core to the far remote periphery and Eastern Europe with passenger flows below 0.1 million passengers. It is interesting to note that to date no East European country has achieved a level of integration into the European core characteristic for the second level hierarchy defined above.

Air traffic requires sophisticated infrastructures, such as airports, air traffic control, feeder systems, and equipment. However, most of the infrastructure is not physical in the sense of highways, tunnels and

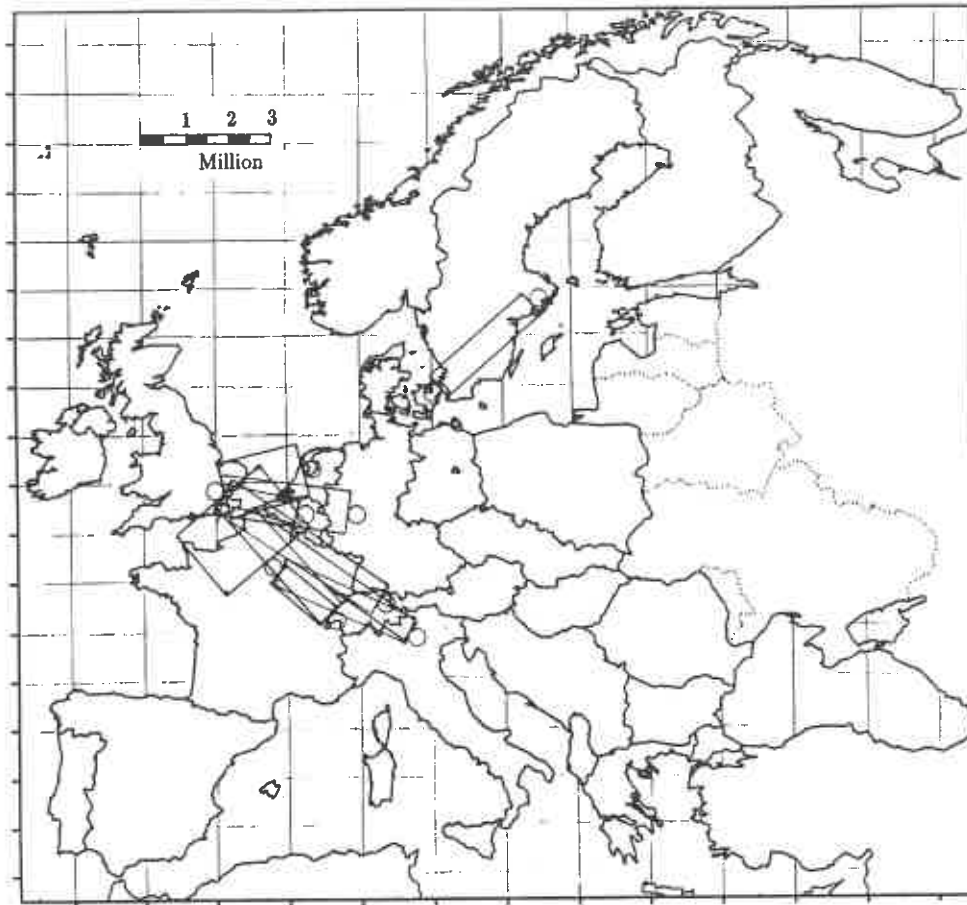

Figure 2. Intercountry Air Passenger Traffic Illustrating the Density of Traffic Within the European "Pentagon" (only routes with more than 0.5 million passengers per year) in 1988.

railways, but rather in the form of regulations, organisations and institutions. This shows that it is not only the lack of physical infrastructures or the existence of insurmountable spatial barriers that impede interaction among gravity centers, but rather the lack of overall social and economic integration. Air traffic patterns illustrate this three-tier structure of Europe in a manner similar to that described for those indicators that depend more on the existence of physical networks such as road and rail transport. This implies that, by and large, physical networks and connections emerged where an interaction potential existed.

The pattern of all passenger transport in Europe reaffirms this finding. Let us define the number of interregional* domestic trips as gravity potential and the international passenger trips as an expression of the mutually attractive force of these gravity centers. Table 7 shows the interregional trips performed within and between 11 European

* Interzonal long-distance trips based on European subregions as defined in the EEC COST 33 model.

Gravity Model of Spatial Interactions

The concept of spatial interaction potential was derived from Newtonian physics where the gravitational attraction between two physical objects varies directly as the product of their masses and inversely as a function of their separation. The interaction attraction between social objects, such as cities, will depend on a more abstract concept of mass, such as the population size, purchasing power, etc. Separation is rarely a direct function of physical distance, it is often measured in terms of interaction time or some other indicator proportional to the "friction" of geographical distance. Gravity models have been used successfully to explain much of the variation in data which describes the movement of people, goods, information and ideas. They provide an excellent tool for representing patterns of spatial interactions. The general expression of the interaction relationship is:

$$I_{ij} = \alpha \frac{M_i^{\beta_i} M_j^{\beta_j}}{d_{ij}^{\delta}}$$

where I_{ij} denotes the intensity (number or flux) of interactions between objects i and j , M_i is the mass (size) of object i and M_j the mass of object j , d_{ij} is the distance (measure of physical separation) between the objects i and j and α , β and δ are the parameters to be estimated from the empirical data.

For example, if we were to measure the interaction between different cities in terms of the number of telephone calls, the masses could be assumed to be directly proportional to the population and their separation to be proportional to the physical distance from centre to centre. Parameter α expresses the inherent propensity to make telephone calls associated with the two given cities. It is an empirically measured magnitude and would take a different value for an alternate set of cities. As the distance increases, the interaction decreases. The exponent δ denotes the "friction" of the distance and is also an empirically measured magnitude. Its value has decreased over time with the advent of more efficient transport and communication systems.

Political and physical boundaries and cultural and language barriers can create discontinuities in patterns of spatial interaction in the same way as efficient infrastructures decrease the interaction friction for a given distance. For example, telephone calls between Montreal and other cities in Quebec, other cities in Canada and the United States are subject to strong discontinuities and do not vary smoothly as a function of distance across these three regions, while they are rather continuous as a function of distance for calls between Montreal and cities within one of the regions. Telephone calls between Montreal and other cities in Canada (outside Quebec province) were five to ten times lower than those cities within Quebec. Thus, judging by the number of telephone calls these cities behaved as if they were five to ten times as distant, while equivalent cities in the United States behaved as if they were fifty times as distant.

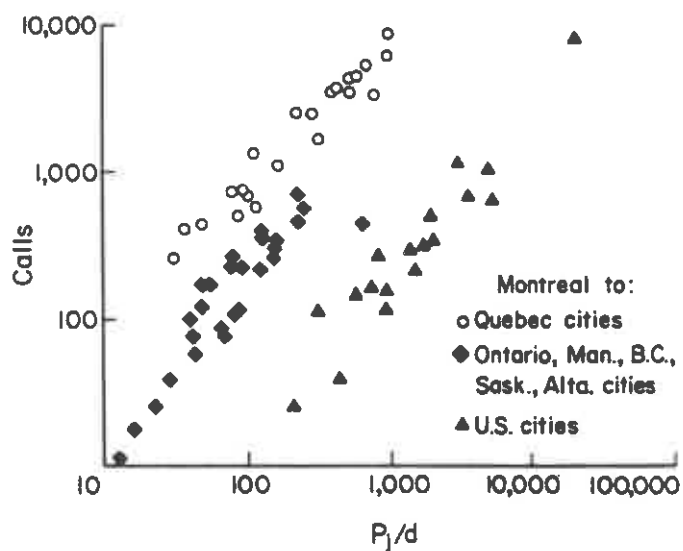

countries in 1982 based on a highly disaggregated European gravity model. The flows between regions represented by the model have been calibrated based on actual city to city passenger trips for the base year. Such gravity models can then be used for the simulation of scenarios of passenger traffic under a European integration or the impacts of the availability of new high speed railway connections.

Table 7. Interregional European Passenger Traffic in 1982 (million).

Area From/To	Domestic	International			Total
		Core	Rim ¹	Total	
Core	1,627	301	85	386	2,013
Rim ¹	49	90	4	94	143
Total	1,676	391	89	480	2,156
In % of all passengers	77.7	18.2	4.1	22.3	100.0
By rail	226	24	8	32	258
By road	1,405	346	77	423	1,828
By air	44	21	4	25	69
Rail %	13.5	6.2	8.8	6.7	12.0
Road %	83.9	88.5	86.4	88.1	84.8
Air %	2.6	5.3	4.8	5.2	3.2

¹ Austria, Denmark, Ireland and Switzerland.

Out of an estimated 2.2 billion interregional trips performed in 11 European countries in 1982 (the lastest year for which interaction matrices have been developed), some 78 percent were domestic, 18 percent international to the inner core, and some 4 percent to the outer core and the rim. The inner European core accounts for two-thirds of all interregional trips performed in 1982 and also accounts for over 80 percent of all international interregional trips (either as source or as destination) of the 11 European countries covered in Table 7. The absolute dominance of road transportation (mostly by private car) also becomes evident: 84 percent of the domestic interregional trips and over 88 percent of all international trips rely on road transport. The share of railways is particularly low for international trips (less than 7 percent), whereas the share of air transport, whilst being rather modest for domestic interregional trips in Europe (less than 3 percent, compared to a market share value of up to 20 percent in large countries like

the USA or the USSR) rises to over 5 percent for international interregional trips and increases rapidly in both absolute and relative market share terms.

Table 8 shows the per capita interregional trips performed in 11 European countries in 1982 (presented as absolute regional aggregates in Table 7 above). The core has a higher "attraction force" than any other international destination for passenger travel from most other European countries. The only exception shown in Table 8 is Ireland. Although no similar data are available on a wider European basis, the interregional trip intensity per capita confirms the dominance of the inner European core as represented by the Benelux countries, the FRG and France.

To some extent it is not surprising that smaller countries are "pulled" by the gravity of large countries in the inner core. For example, the Benelux countries or Austria have generally around four international trips per capita into the inner core area and Switzerland six. In terms of passenger travel, Austria and Switzerland thus belong to the European core, whereas politically they are not part of the central community countries.

Again this kind of analysis demonstrates that the interconnections in Europe, measured in terms of their intensity, do not necessarily follow the current political alliances and divisions within Europe. Austria and Switzerland portray a higher degree of interconnection (measured both in absolute number of trips as well as in per capita trip intensity) with the European core than, for example, the UK or Italy. By analogy, although the data are not available, we speculate that the other countries belonging to the periphery and especially the Eastern European countries, must have levels of integration that are a large factor lower than those of Italy and the UK. Even major rates of annual increases in these flows would have to be sustained for many years to reach the international passenger travel intensities of the European rim or core countries.

Thus, international passenger travel intensity of one to two trips per year per capita is typical for the interconnections of large countries with their European neighbours. Smaller countries have generally a much higher degree of international interconnections, with Switzerland showing the highest total international trip density of above 7 trips per capita, whereas the UK with 0.3 trips per capita remains relatively isolated from the European core.

Border crossing statistics by country of origin are available for Austria, which means that a similar indicator of interconnection as that presented in Table 8 can be derived. Figure 3 shows the number of border crossings per capita of the population of the neighbouring

Barriers and Breakthroughs in Transport and Communication

The conceptual framework of spatial interaction as reflected in a gravity model explains the flows of people, information or goods between "attraction" or gravity centres as a function of their respective "mass" (i.e., their combined mutual "attractive forces") and as an inverse function of the intervening "functional distance". Functional distance implies that the friction of space is not simply a function of distance, but of the ease and costs (time and money) involved in covering a given spatial distance. As a result, lack of appropriate infrastructures compounds the "friction of space", as availability of infrastructures reduces functional distances, thereby increasing the interchange between attraction centres.

However, in addition to distance the existence of barriers may also impede interchange and communication. Barriers may be of a physical, natural (e.g., the English Channel or the Alps), political, institutional (national borders, differences in political and economic systems), or socio-cultural (language or religious differences) nature. The importance of barriers was first recognised in social anthropology, that explained the pattern and intensity of cultural interchanges or migration. Barriers impede communication, i.e., the spread of information, ideas and artifacts (diffusion) as illustrated in the work of Torsten Hägerstrand, in which natural barriers act as half- or zero-contact multipliers for the information flows between individuals. Such contact (reduction) multipliers are not simply model conceptualisations, but can be determined empirically, for instance, by analyzing telephone communication data.

With regard to international passenger travel, the existence of borders within Europe results generally in a "retardation factor" of 4, i.e., the interaction between two cities with a given distance measured in travel time is by a factor 4 smaller if a national border has to be crossed, compared to similar cities and travel time distances within one country. The border "retardation factor" can be significantly higher if additional barrier effects like natural or cultural differences compound the effect of political boundaries. This is clearly illustrated in the interaction patterns within Europe, as measured by the per capita international trip intensity explaining the proportionally low intensity of England and the high intensities of Austria or Switzerland.

Once political and institutional barriers such as the iron curtain fall, the transborder flows of people and information (as opposed to goods) react swiftly: the interaction *potential* between "gravity centres" becomes translated into *actual flows*.

For instance, the fall of the iron curtain between Austria and Hungary and Czechoslovakia has resulted in an 8-fold increase in the number of people and telephone calls crossing the border in 1989 compared to 1975. It is interesting to note that this statement holds true only for "virtual communication", i.e., telephone messages and passenger travel, whereas "batch" communication in the form of letters has only increased slightly and shown no reaction to the disappearance of the iron curtain.

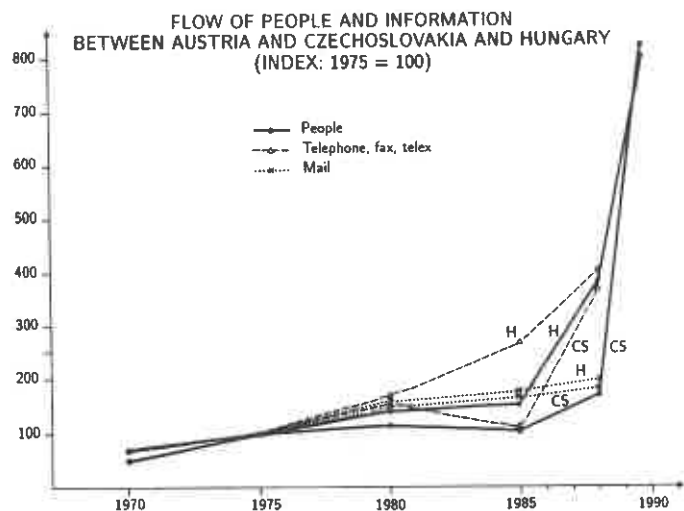

Table 8. European Per Capita Interregional Passenger Traffic in 1982 (trips per capita).

From/To	Domestic	International			Total
		Core	Other	Total	
Austria	2.9	3.7	0.8	4.5	7.3
Belgium	n.a.	4.3	0.3	4.6	n.a.
France	5.5	0.7	0.5	1.2	6.7
FRG	9.9	1.3	1.2	2.5	12.4
Netherlands	5.4	3.4	0.4	3.8	9.2
Switzerland	3.3	6.0	1.4	7.4	10.7
Subtotal	7.1	1.9	0.8	2.7	9.8
Italy	4.2	0.4	0.3	0.7	4.9
UK	7.2	0.2	0.1	0.3	7.5
Denmark	1.0	1.3	0.3	1.6	2.6
Ireland	n.a.	0.2	0.9	1.1	n.a.
Subtotal	5.5	0.4	0.2	0.6	6.1
TOTAL	6.3	1.2	0.5	1.7	8.1

countries as an indicator of their degree of interconnection with Austria. The data show that since the 1985 abandonment of visa requirements between Hungary and Austria, and especially since the fall of the iron curtain along the border with Czechoslovakia in 1989, similar levels of interaction are being achieved as are typical for other neighbouring countries like Yugoslavia, Italy, Switzerland and the FRG, i.e., one border crossing to Austria per capita.

This rapid increase in across-the-border travel is not surprising for countries and regions in such proximity to each other. In addition there are many common historical and cultural roots which lead to an increase in the interaction potential. A much larger fraction of the populations of Hungary and Czechoslovakia speak German than, for instance, in Italy. Thus, the language barrier is also much smaller, which is an additional explicative factor for the rapid increase in personal travel to Austria. The question must still be posed, however, whether this is just a specific regional phenomenon or an indicator of a general increase in international mobility and interconnection to the European rim and core.

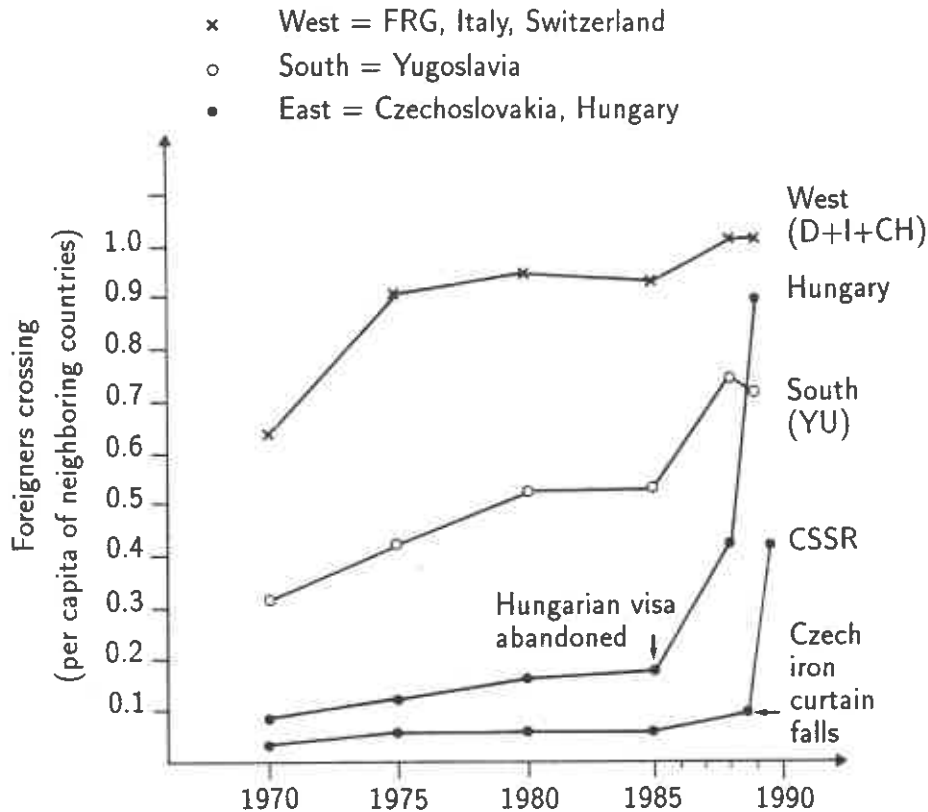

Figure 3. Foreigners Crossing Austrian Border Per Capita of Country of Origin.

Using the above metaphor of gravity centers and their interconnecting flows as expressed in the domestic and international interregional passenger traffic, Figure 4 shows that the pentagon of the European core undergoes a salient transformation. With the very large flux of interchange between Austria and the Federal Republic of Germany, the outer delimiter of the European core is moved East. Most of the interaction though is focussed in the triangle between France, the Benelux countries and the FRG. Compared to the European pentagon, as shown by air passenger flows, the importance of London diminishes as a manifestation of the persistent barrier effect of the Channel and, possibly, also illustrating that even modern transport infrastructures cannot completely overcome the separation of the British Isles from Continental Europe.

Thus the flows between the European gravity centers appear to follow closely a hierarchical structure. This is in fact not surprising considering that urban agglomerations show generally a rank-size distribution pattern. This is illustrated in Figure 5 for the FRG. The rank-size classification shows that there is a mathematical relationship between

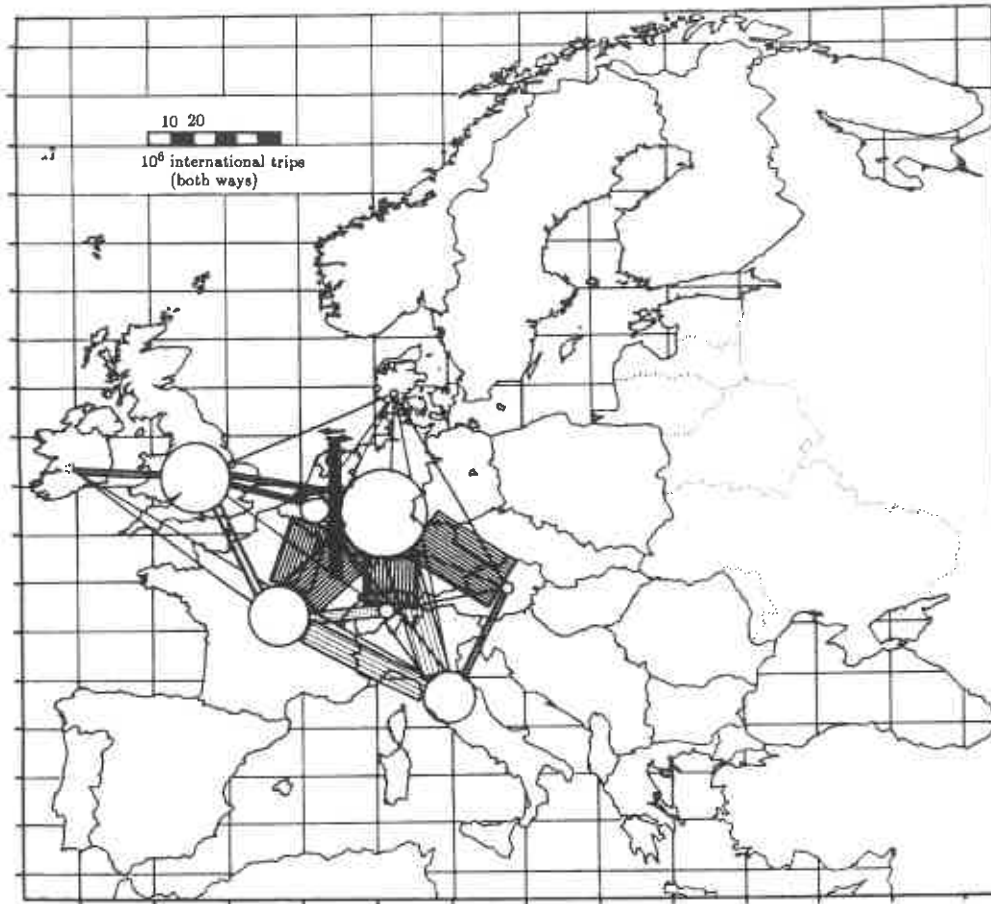

Figure 4. European Interregional Passenger Traffic, Domestic and International in 1982 (in million passengers, domestic proportional to circle area, international trips proportional to thickness of connecting bars).

the magnitude (i.e., the size, usually measured by the resident population) of a given city and its rank within a hierarchy of central places. For example if the coefficients of this rank-size relationship are known, one can determine immediately the size of for instance the 100 largest cities based on the size of the largest city of a country. It is interesting to note that compared to other European countries, the top rank cities of the FRG are below the size expected based on the rank-size distribution, pointing to a polycentric structure of the major cities of the FRG and also to a lack of a national capital comparable to Paris or London. Possibly with the German reunification a Greater Berlin with over 5 million inhabitants could emerge as the city with the highest rank in the system of central places in unified Germany. In such a case a new significant "attraction potential" with resulting dense travel and communication flows is to be expected.

The flows between the gravity centers in the same way as the rank-size relationship orders the gravity centers by their relative

Hierarchies of Central Places: the Rank-Size Distribution

Complex systems are generally hierarchical. The pattern of location and size of cities is explained in regional science by central place theory. Cities can be regrouped into hierarchical levels of central places which constitute economic and service centres for their surrounding or functional hinterlands. Central places at higher hierarchical levels have a correspondingly larger hinterland than cities at lower levels. A nation's capital provides functional services for the whole country, a regional capital for its region, and a village for its surrounding area. Central places at lower hierarchical levels depend increasingly on services provided by central places at higher hierarchical levels. Auerbach discovered in 1913 a simple mathematical relationship between the size of a given city (usually measured in terms of its population) and its rank in the system of central places. This relationship has been known as the "rank-size" distribution.

$$\log S_i = \alpha - \beta \log R_i$$

Thus, the logarithm of the size of a given city S_i is a linear function of the logarithm of its rank R_i , with the intercept α giving the size of the largest city (usually the national capital) and the coefficient β representing the slope of the rank-size distribution, i.e. an indicator of the concentration of the population in larger cities compared to medium and small sized ones. Typical rank-size distributions for cities in the USA and the USSR at various census years empirically confirm the above rule.

The fact that the slope (i.e., β) of the rank-size distribution of US and Soviet cities has not changed significantly over 80 years indicates that population growth rates have been roughly uniform between large and small cities. Equally visible is the noticeable catch-up of the USSR in urbanization between 1930 and 1980 as well as the fact that the largest cities tend to be smaller than expected based on the rank-size distribution of small and medium-sized cities (see e.g., the too small population of rank 1 Moscow in the USSR in 1930). This however, is frequently the result of the definition of cities in terms of their political or administrative boundaries instead of a more appropriate functional delineation as metropolitan areas (including satellite cities and suburbs).

If cities as "attraction potentials" are hierarchically structured it is only logical to expect also the interaction flows between cities to display a hierarchical structure. This is indeed the case as illustrated for instance in the rank-size distribution of city-to-city air passenger traffic in Europe. From the perspective of the European international air passenger traffic the European rank 1 is represented by London, followed by Paris, Frankfurt and Amsterdam.

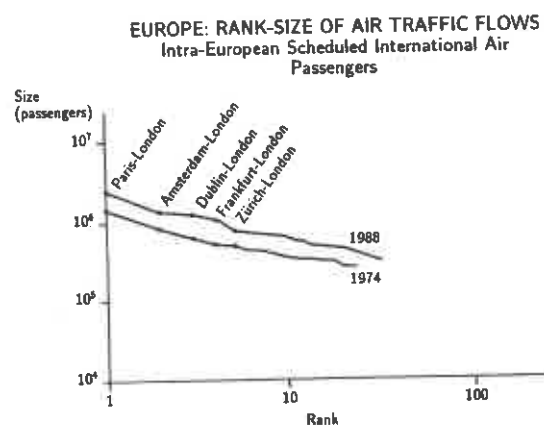
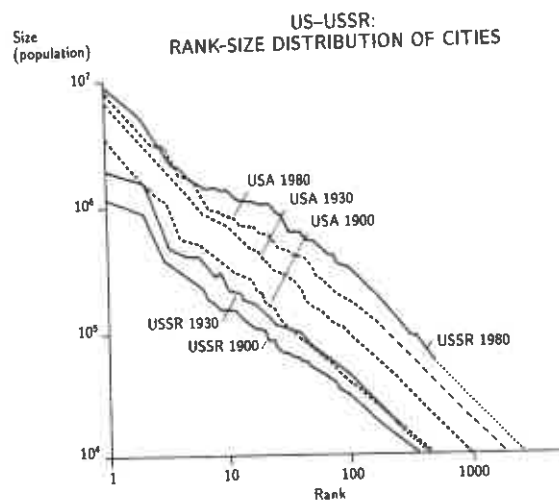

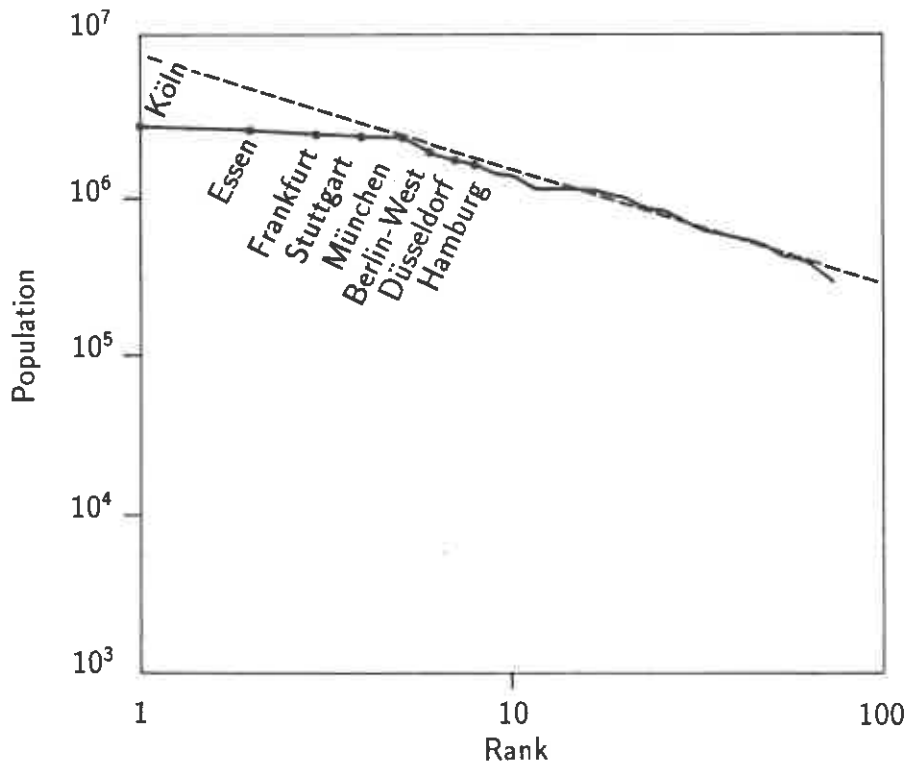

Figure 5. Rank-Size Distribution of 79 Metropolitan Areas in the FRG in 1985 (measured by resident population).

importance; however, the relative positioning of cities and their source-destination traffic flows is different, as exemplified by the example of West-Berlin, which population wise is the 6th largest city of the FRG, whereas in terms of its traffic flows to and from the city it ranks only 67. A curious finding shown in Figure 6 is that the two rank-size distributions have the same shape. This means, that the relationship between the largest and the smallest passenger flows is the same between the largest and the smallest gravity centers. In other words, once the rank-size distribution of the cities of a given country and the traffic flow between any pair of cities are known, it would be easy to determine the rank-size distribution of the intra-city connections and also by integrating the total traffic flow of a country, based on above finding.

The formal relationship in the rank-size distribution of the intra-regional passenger flows also allows the determination of a rule-of-thumb distribution of the traffic flows. In the above example for the FRG, the top 25 percent of the intra-regional relations account for 50 percent of the total long-distance trips of the FRG. Seventy-five

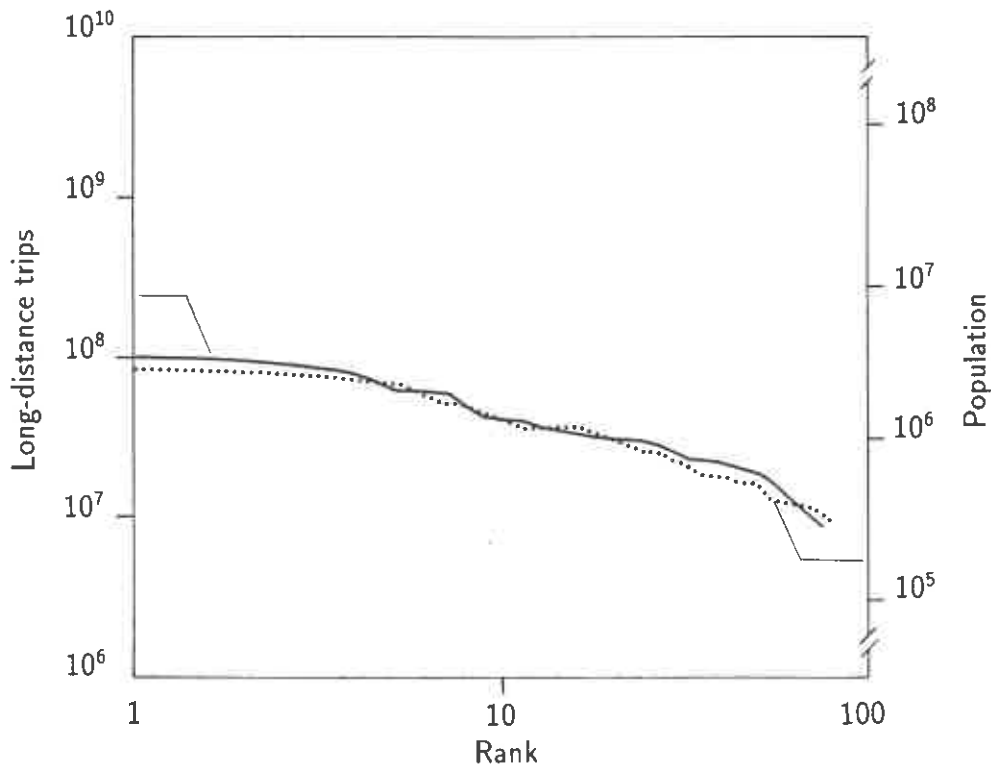

Figure 6. Rank Size Relation of 79 Metropolitan Areas and Their Interregional Passenger Traffic Flows in FRG in 1985.

percent of all traffic is accounted for by 50 percent of intra-city connections based on the above distribution function.

The spatial pattern of goods transport in Europe is given in Table 9 and reveals a similar – yet even more drastic – structure as shown for the European interaction pattern of people: the bulk of the exchange is concentrated in the core, with low interaction intensity towards the periphery, particularly in South-western and South-eastern Europe.

Out of a total of 14 billion tons transported in and between 19 West European countries in 1986, 95 percent was national (domestic) traffic and only some 5 percent was international traffic. In international goods traffic the dominance of the European core countries is particularly noticeable, receiving 87 percent of all international goods tonnage. Also, 75 percent of all international goods transport flows between the core countries indicating that the economy of Europe is basically confined to the central core area. The modal split in domestic goods transport shows the absolute dominance of road transport, accounting for 90 percent of all tonnage transported nationally in the

Table 9. Western Europe Goods¹ Traffic in 1986 (million tons).

Area From/To	Domestic	International			Total	Total
		Core	Rim	Periphery		
Core	9,429	505	12	2	519	9,948
Rim	2,399	33	21	1	55	2,454
Periphery	1,432	7	3	2	12	1,444
Unaccounted	0	43	28	18	89	89
Total	13,260	588	64	23	675	13,935
In % of all tonnage	95.2	4.2	0.4	0.2	4.8	100.0
By waterway	230	205	5	2	212	442
By rail	1,086	110	27	10	147	1,233
By road	11,944	273	273	33	10	316
Waterway %	1.7	34.9	7.7	9.0	31.4	3.2
Rail %	8.2	18.7	41.5	45.5	21.8	8.9
Road %	90.1	46.4	50.8	45.5	46.8	87.9

For definition of regions, see box on page 4.

¹ Excluding sea, pipeline and air transport.

19 Western European countries aggregated in Table 9 (excluding however sea and pipeline transportation; the tonnage transported by air freight can be considered negligible in this discussion). The dominance of road transport decreases in international goods transport, where trucks account for close to 47 percent of the tonnage transported, with inland waterways taking an important share of over 30 percent. The high share of inland waterways in West European international goods traffic is the result of the dense waterway traffic between the Benelux countries, France and the FRG (primarily on the Rhine river).

The share of waterways in goods transport decreases drastically from the core to the rim and periphery. Symmetrical to this, the importance of railways in international goods transport increases further out to the periphery, reaching 45 percent, compared to 19 percent in international goods transport in the European core. The share of road transport in international goods traffic remains, on the other hand, rather constant at 46 to 51 percent between the core and the periphery.

Thus, the European core dominates international goods transport as illustrated graphically in Figure 7, whereas the European periphery is already only marginally connected via intensive goods flows to the core. Only in specialised market segments do the fringe and periphery

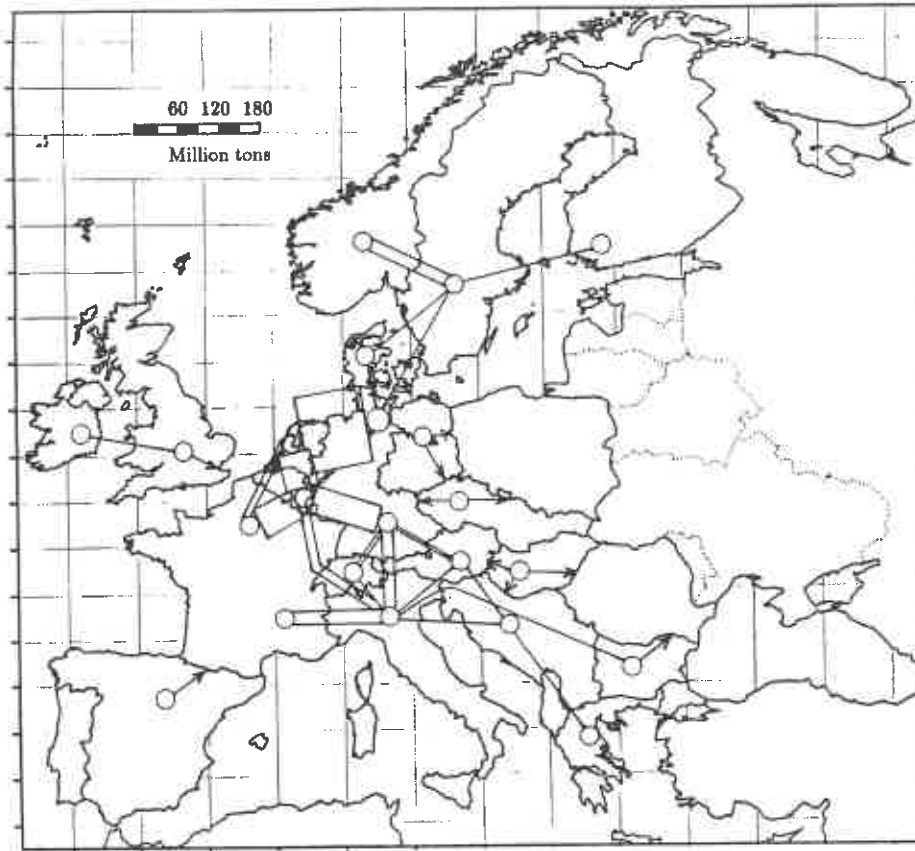

Figure 7. Major International Goods Transport Flows Between 19 European Countries (million tons) in 1986.

regions enter a more intensive exchange relationship with the European core as reflected in the flows of air freight from Scandinavia and Spain to the European core area. Natural infrastructure endowments, like the waterways (Rhine) between the Netherlands and the FRG explain the high density of tonnage transported between these two countries with barges. The modal distribution of international goods traffic shows that the preferred mode for the international exchange of goods within Western Europe is by road. Conversely the importance of railways in the transport systems of Eastern Europe explains why the small (in comparison to inter-Western Europe flows) exchange of goods between Eastern Europe and the core region is largely transported by rail. Although only sparse data on the flows of goods between Eastern and Western Europe are presently available, it seems unlikely that significant growth in export volumes from Eastern Europe to the core can be achieved with such a mismatch in their respective transport systems. In addition, there remains the more general problem of what kind of goods from Eastern Europe could actually find large-scale markets in the highly competitive environment prevailing in Western Europe today and which is certain to increase after 1992.

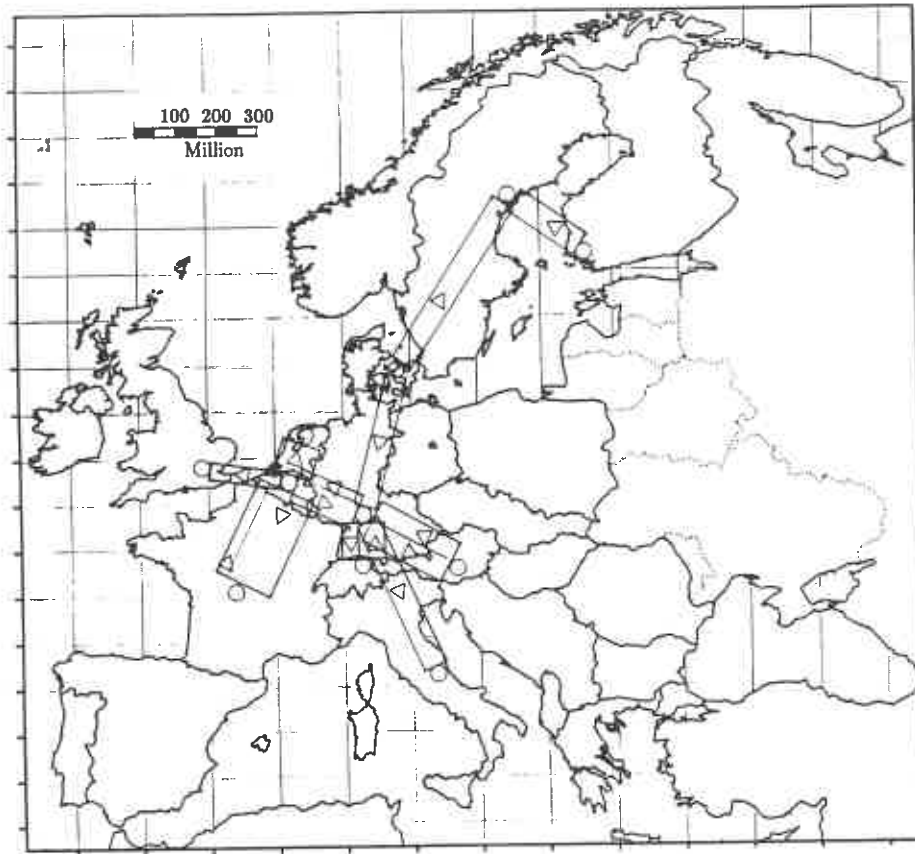

Figure 8. Major Country to Country Telephone Calls in Europe in 1985 (million).

The mismatch in the passenger and goods transport systems between Western and Eastern Europe is becoming even more staggering considering the differences in the efficiencies of telecommunication systems and the lack of communication flows between Eastern and Western Europe as illustrated in Figure 8. Also, the lack of intensive communication is certainly related to the inadequacy of communication infrastructures. Most East European countries have a telephone line density of below 20 lines per 100 inhabitants, which is significantly lower than the communication infrastructure density of the European periphery (with the exception of Turkey) and even more so when compared to the core countries. However, infrastructures are not the only explanation factor, the existence of (e.g., language) barriers and the low density of passenger travel endorse the deficiency of communication between the two Europes. Passenger travel and efficient communication systems can be considered as an important precondition for any improvement in the overall economic integration of Eastern Europe. "First you make friends and then you make business".

A Functional Definition of Cities

Empirical evidence suggests that the time devoted on average by an individual to traveling is close to an anthropological constant, ranging between one to 1.5 hours per day both in industrial as well as in agricultural or neolithic societies. The range that can be traveled by a person within this travel time budget depends on the availability of and accessibility to infrastructures. Consequently it is not surprising that since antiquity cities and settlements have condensed along transport infrastructures.

In pre-industrial societies the range that can be covered by walking within the travel time budget of about 1.5 hours defined the size of even the largest settlements like imperial Rome with its diameter *intra muros* of 6 km. In a similar way, the size of the cultivated zone around agricultural villages is defined by the radius which can be covered within 1.5 hours walking time going to and returning from the fields. Present day cities are not different. The case of the Bosphorus bridge shows that commuting time of about one hour defines functionally an urban agglomeration or a *metropolis*.

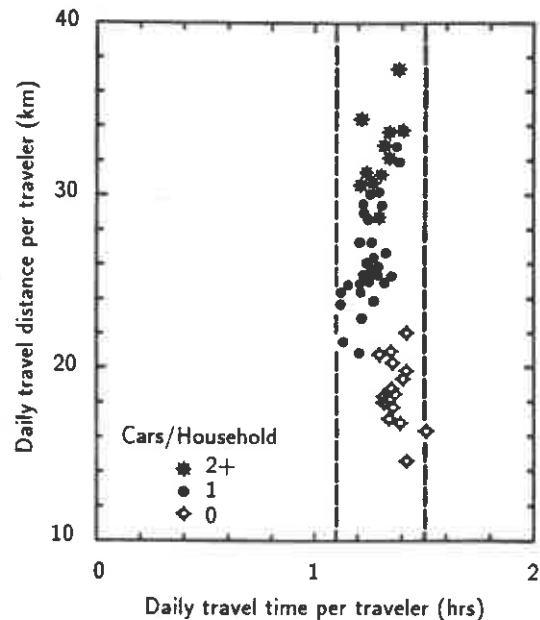

The Bosphorus Bridge

The Bosphorus bridge, built in 1974, was conceived as part of the Asia-Europe motorway linking the European part of Turkey to Asia. Originally the bridge was conceived to speed up truck traffic between Asian Turkey and the Middle East and Europe. Previously, the Bosphorus crossing by ferry (one way) took about one hour. As a result, the city of Istanbul, with close to 6 million inhabitants, was out of reach for daily commuting from the cities of Usküdar and Kadiköy on the Asian side of the Bosphorus, their population exceeding one million.

Before the construction of the bridge, about 5 million vehicles crossed the Bosphorus annually by ferry. Upon opening the bridge in 1974, 12 million vehicles crossed it, while the ferry traffic decreased to some 1 million vehicles annually. Four years later, close to 30 million vehicles crossed the bridge, almost exclusively local traffic, as truck drivers continued to use ferries, which are cheaper than the Bosphorus bridge toll. The six-fold increase in Bosphorus crossings during the first four years demonstrates that the two sides of the Bosphorus were previously functionally separate urban agglomerates connected by long-distance travel only. The bridge reduced travel time to about 15 minutes *connecting* the two sides of the Bosphorus into a single functional metropolis with resulting high daily commuter flows. Case studies of Hong-Kong or Lisbon show an identical pattern.

Transport infrastructures, capable of reducing travel time to about one hour both ways can thus conglomerate strings of preexisting centres into single functional units that provide a much wider range of opportunities for people living there, in terms of jobs, housing, services and entertainment. Previously low levels of interaction increase by a quantum leap, once infrastructures reduce travel time enabling local commuting.

Stars, Galaxies and Great Attractors

The rank-size distribution of world cities portrays an interesting discontinuity in the usually smooth distribution of city sizes following their rank. The 20 or so largest cities of the world appeared to be too small compared to their expected size based on the rank-size relation of smaller cities. This is primarily the result of the definition of cities within administrative boundaries instead of their delineation based on functional criteria. A city or *metropolis* like a national capital is defined functionally by the zone out of which people can access the city by daily commuting. For relatively small cities this zone corresponds well with the administrative city boundaries.

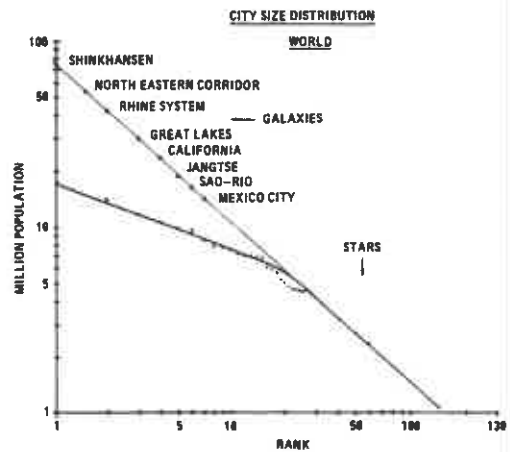

Very large urban agglomerations that act as central places on a world level transgress this functional delineation of a single city. Instead they form an *ecumenopolis*, i.e., an urban cluster in which travel, business and return travel can be completed within one day. These are the galaxies compared to the stars at the lower hierarchical levels of central places. If world urban centres are defined on the basis of such functional criteria they again appear in harmony with the size of cities of lower rank. City galaxies condense along high capacity infrastructures which enable their functioning as a single ecumenopolis. The world's largest urban corridor is the Shinkansen corridor connected by the bullet train on which over 120 million passengers travel annually. For comparison the most dense railway traffic on any route in Continental Europe does not exceed 20 million passengers per year (e.g., Paris-Lyon: 18 million passengers) and in the UK one million passengers (London-Manchester). Kenzo Tange envisioned the extension of the Shinkansen corridor city to a *megalopolis* spanning the whole of the Japanese isles, as the great attractor for whole clusters of settlement galaxies. As night satellite photos suggest, this 20-year old vision of interconnected city strings has become reality.



ECUMENOPOLIS 2100

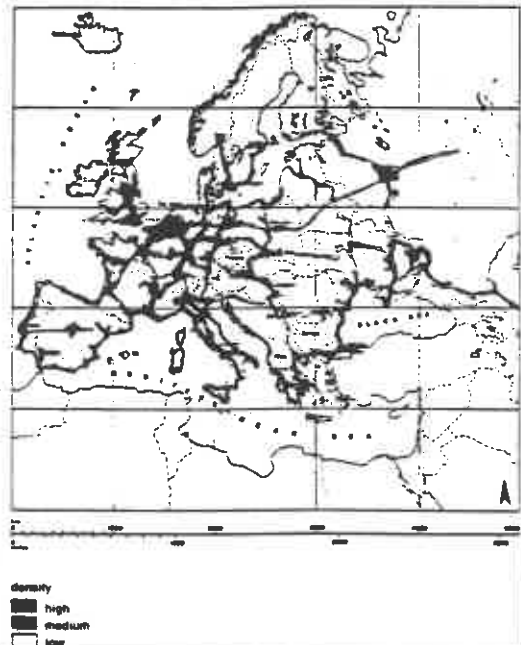

In a similar way the existence of appropriate infrastructures could mesh urban agglomerations of Europe into city corridors in which activities could be performed within a one day trip: a European ecumenopolis. It is the European ecumenopolis that defines the effective core of the United States of Europe. In the very long-term an economically and culturally integrated ecumenopolis could span the whole of Europe.

5. The Future of Europe in Two Scenarios

The analysis of the spatial distribution of economic activities and the spatial interaction patterns as reflected in travel and communication clearly showed the large disparities between the European core and the low levels towards the periphery. Any scenario of possible future development has to reflect the increasing "gravitational pull" of the core, and therefore a further increase in the gradient to the periphery. Such development would be very likely according to the gravity model of spatial interactions. Taking this analogy a step further from the Newtonian physics to present day cosmology, one could speculate about a possible mass collapse of the core and the effects of resulting shock waves on the periphery. "Mass collapse" could be imagined as a situation in which the core develops into a functional entity that can be characterised as a European ecumenopolis. This should *not* be confused with a single high density central European city. The European ecumenopolis would instead consist of a network of interacting centers connected by highly efficient infrastructures. Between these components of the ecumenopolis large "empty" spaces would exist, much like the green belts of 19th century garden cities. Frequently the empty space would take the form of untouched natural parks built on the recultivated industrial areas of the 19th century.

The salient feature of the ecumenopolis would be that the current long-distance travel within the European core would become local commuting, and long-distance communication would be replaced by local communication. It is in this sense that we speculate about the possible collapse of the European core. It would imply international travel densities equal to those of the largest metro stations of London, Paris and New York, and frequency of communication at the rates of present day Paris and London intercity phone calls.

Assuming that one out of two inhabitants commutes every day, as in Hongkong, Paris or London, the population of the European ecumenopolis would make about 200 million "local" trips per day. Most of these trips would extend over distances more typical for present international and long-distance trips. This would correspond to about 70 billion passenger trips per year or about a factor 30 increase over present (1982) international travel densities. Considering that it may take between 50 to 100 years to implement such a new "Eurometro" infrastructure one could assume that by 2010, ten percent of the ultimate potential could be achieved, or about 7 billion trips per year (corresponding to an annual growth rate of 5 percent per year over the next 20 years).

(pass-km per day per capita)

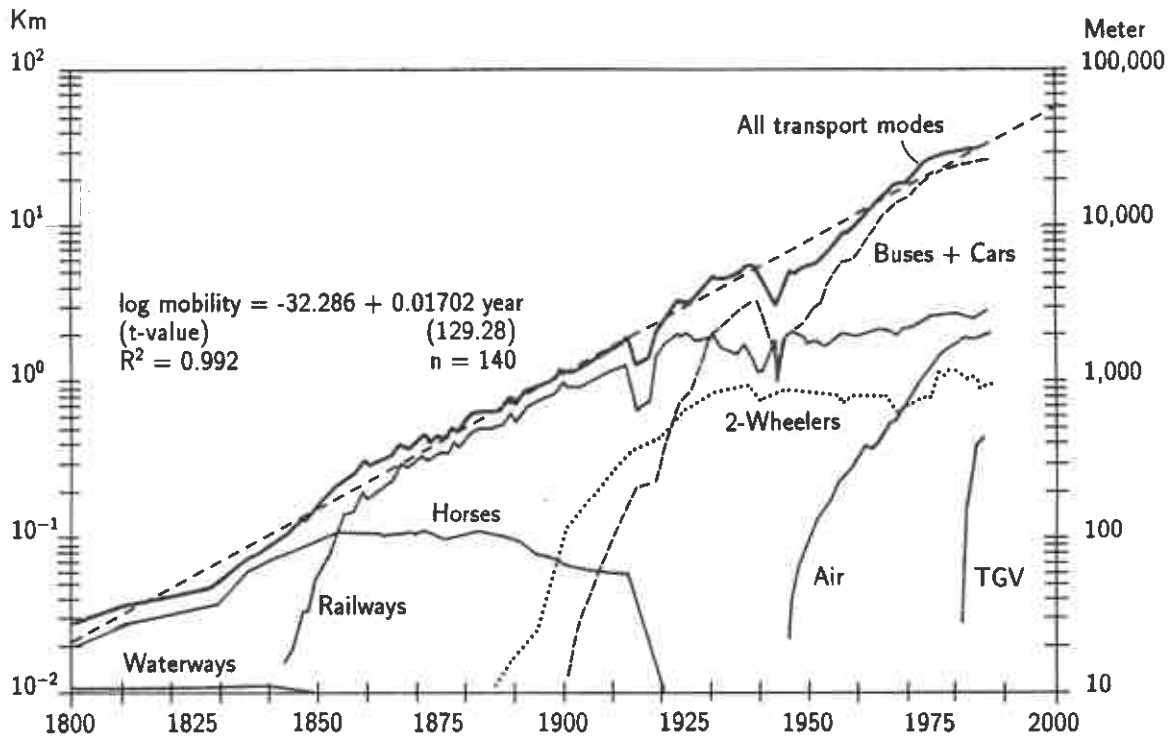

Figure 9. Daily Travel Range in France Since 1800 to Present (passenger-km per day per capita)

Although such a scenario may appear unrealistic with the current technologies and institutions, and in any case infeasible with a further intensification of traditional transport modes such as car or rail travel, it would be consistent with the historical trend towards greater spatial range. Figure 9 shows that the increase in the daily travel range has been a pervasive historical development ever since 1800. Daily travel increased with the process of development throughout the world. For example, the spatial range covered by the population of France appears to grow along a secular trend which increased from about 20 meters per day per capita in 1800 to more than 30 kilometers in 1985. These increases in mobility were primarily achieved by the introduction and growth of new transport modes, railways in the 19th century and buses and cars in the 20th century. Although the increases in mobility may be sustained over several decades by increases in the performance of the dominant transport system, as illustrated by the growth in railway traffic between 1860 and 1920 and by the growth of road traffic ever since, there are obvious limits to the further expansion of traditional transport systems.

Taking the long-term secular trend from Figure 9 as a guide, mobility could increase to some 100 km per day per capita by the year 2010 and to about 300 km by the year 2040. A three-fold increase in passenger travel by the year 2010 would cause serious obstacles from a logistic and also from an environmental viewpoint if based on the growth of car travel. Furthermore, the time budget constraint may even be a more stringent limitation considering that the average travel speed by car does not exceed some 30 km/h. Even larger travel ranges would in any case be infeasible with present day transport systems. Ranges in the order of 300 km per day or more are however, plausible considering a transformation of present local commuting to long-distance commuting within an European ecumenopolis based on a maglev "Eurometro" with speeds over 600 km/h connected to more conventional high speed infrastructures like the TGV running at 300 to 400 km/h. Such a "Eurometro" could also provide the necessary feeder functions and integration to transcontinental travel. Hypersonic air transport connecting the world cities in as little as two hours would, for obvious environmental reasons, have to be removed from the densely populated areas of the European core. A more likely scenario would consider a hypersonic hub located off-shore, building on the considerable engineering expertise available in Europe as a result for example of offshore platform technologies developed for North Sea oil production.

It has to be emphasised however, that the above outlined scenario is not merely a question of technological developments and investments into new infrastructures. Present institutional rigidities impeding a harmonisation of European infrastructures (such as the conflict on compatible design parameters between the French TGV and the West German ICE new rapid rail systems) will have to be overcome. New regulations, organisations and institutions would be required to further "just-in-time" integration and communication within the "gravity strings" of a European ecumenopolis. Finally the question of social adjustments and shifts in employment away from traditional economic activities to new opportunities opened-up by long-term investments into new infrastructures should also be considered. From such a perspective, coal miners could build the tunnels of the "Eurometro" maglev, and North Sea oil workers the new offshore hypersonic hub, once their services in their traditional fields are no longer required due to changing societal and economic preferences in the energy system.

Assuming that the core would undergo such a gravitational collapse the key question is what would happen with Eastern Europe. Of the many possibilities two contrasting alternatives are of special interest in this context. The first describes a future in which the core becomes self-contained through the collapse and closed to the

periphery. Such a closure could include a mixture of institutional and physical barriers such as the lack of efficient and compatible transport and communication systems in Eastern Europe. A second more optimistic future would unfold if the attractive force of the core is not blocked by the existence of various barriers thus enhancing integration and interchange. This would further increase the activities both within the core and periphery, and provide a positive feedback to the intensity of interaction within a wider Europe. In both scenarios, however, there is a stronger increase in density of activities within the core, so that the major difference between the two scenarios is in the steepness of the gradient towards the core.

The metaphor of the "golden curtain" describes the image of the first scenario. This kind of scenario implies a reversal in the polarity of the segmentation barrier between two Europes. Whereas before people could not leave, now they are denied entry. The "golden curtain" has both technical and institutional dimensions. Technically, barrier effects may stem simply from the incompatibility between the new infrastructures in the core and traditional systems in the periphery. For instance the barrier effect could operate very selectively. Imagine a high voltage line. The likelihood of electricity theft (through unauthorised access to infrastructure, say by an illegal connection to a power line) is nil, because the high-voltage kills without appropriate equipment such as well insulated connection, step-down transformers, etc. A tariff paying consumer, equipped with an appropriate transformer has easy access to the infrastructure and services it offers. The situation is not much different with mobile telephone systems. For instance the only possibility of effective telephone calls between the GDR and the FRG is via mobile telephones using the West German and West Berlin mobile telephone network. This access is possible only with an appropriate equipment and a licence from the infrastructure operator in an analogous manner as with electricity networks. Automobile parking in urban areas is sometimes associated with high permit costs. Many cities have considered the introduction of parking permits that are contingent on the availability of a parking place. The value of a parking space (in terms of costs per square meter) in densely populated areas often exceeds the value of most cars that are to be parked. Thus, the parking permits that would recover the true cost in form of an annual payment would restrict the access to urban areas by automobile. Another example is the widespread use of credit cards in the US as a precondition for the availability and use of many services. Similar kinds of access "barriers" could exclude residents of the periphery from effective integration and interaction with the core. A second kind of barriers could be institutional in nature, i.e., visa requirements, residence permits, "entrance

fees" and infrastructure usage tolls based on lump sum (e.g., annual) payments. All of these institutional barriers could be classified under "equal rights for all" in a sense that everyone would have to fulfill the same conditions for access. In practice, this would of course mean that the residents of the periphery could be denied access.

The second scenario would envisage either some extension of infrastructures from the core into the periphery or an effective interface between the traditional modes predominating in the periphery with the advanced systems of the core. This kind of more optimistic scenario would imply a modest degree of integration and thus also higher standards of living, mobility and communication in the periphery. Nevertheless, spatial and social heterogeneity will also continue to prevail in this scenario. This will be especially true with respect to the relatively high access costs to the core for the residents of the periphery. Consequently a two-tier society could emerge in the East, with the elite having a similar lifestyle to people in the core. For instance the elite may travel by air and use telefax machines, whereas the rest of the society would continue to share telephones and continue to travel by bus and conventional rail. The crucial difference between this and the "golden curtain" scenario is that the degree of integration would be higher, and at least the possibility exists for a part of the society of the European periphery to catch up with the core.

In the "golden curtain" scenario, the large gradient between the core and periphery (and especially Eastern Europe) that has prevailed over the last 40 years is basically perpetuated. This means that, while economic exchange relations exist, the periphery is decoupled from emerging development trends of the core. In the transport area, this scenario could imply that electricity-based maglevs and electricity- or hydrogen-based cars could emerge in the core in order to improve both the effectiveness of the systems as well as to alleviate environmental concerns. In contrast, the periphery will continue more in the direction of increasing car and bus utilisation, for instance by importing used equipment from the core.

In the second scenario the number of interchanges between the core and the periphery would improve to such an extent that one could speak of one Europe, however with different degrees of development: a "two speed Europe" instead of "decoupled Europe". With respect to transport systems the periphery would not develop an *interconnected* maglev network, but instead may develop stand alone segments with some connections to the core. For example maglev links could be developed between Leningrad and Moscow or between Berlin-Prague-Munich, or Budapest-Vienna-Munich. The infrastructure development pattern in the European periphery would look like a

mosaic with fragmented resemblance to the core, much like the present day isolated highway links throughout Southern and Eastern Europe.

Even in the more optimistic "two-speed Europe" scenario, this would imply that growth in passenger travel and goods transport from the periphery to the core would not increase more than the interchanges within the European core itself. In the "golden curtain" scenario, the gradient in economic activity and integration between the core and the periphery would become larger. In the "two speed Europe" scenario, the periphery would achieve a higher level of integration to the core, furthering its autonomous economic development potential.

In conclusion we will briefly describe an important infrastructural component of this development, i.e., the emergence of new high-speed rail based transport systems in Europe. The high-speed connections illustrate most vividly the nature of the "gravitational collapse" within the European core. Figure 10 shows the space-time geography of Europe, giving distances in kilometers and travel time in hours by conventional and high-speed rail. In comparison to the conventional rail system, the high-speed trains generate substantial travel-time reductions that result in a "space-time contraction" shown in Figure 10. The speed of the advanced train links illustrated in Figure 10 are assumed to be about 300 km per hour. This may be considered as modest compared to the proposed maglev designs for the next millenium capable of speeds up to 1,000 km per hour. The figure illustrates that the most modest high speed rail networks proposed to date would reduce the effective frictional distance between European cities, but would not collapse into an agglomeration traversable by commuting (i.e., less than one hour time distance). Nevertheless the proposed infrastructure can achieve a higher degree of integration by reducing travel time to a few hours and thereby increasing the travel flux and interchange characteristic for an "ecumenopolis". It does not allow, however, the emergence of a single functional European metropolis.

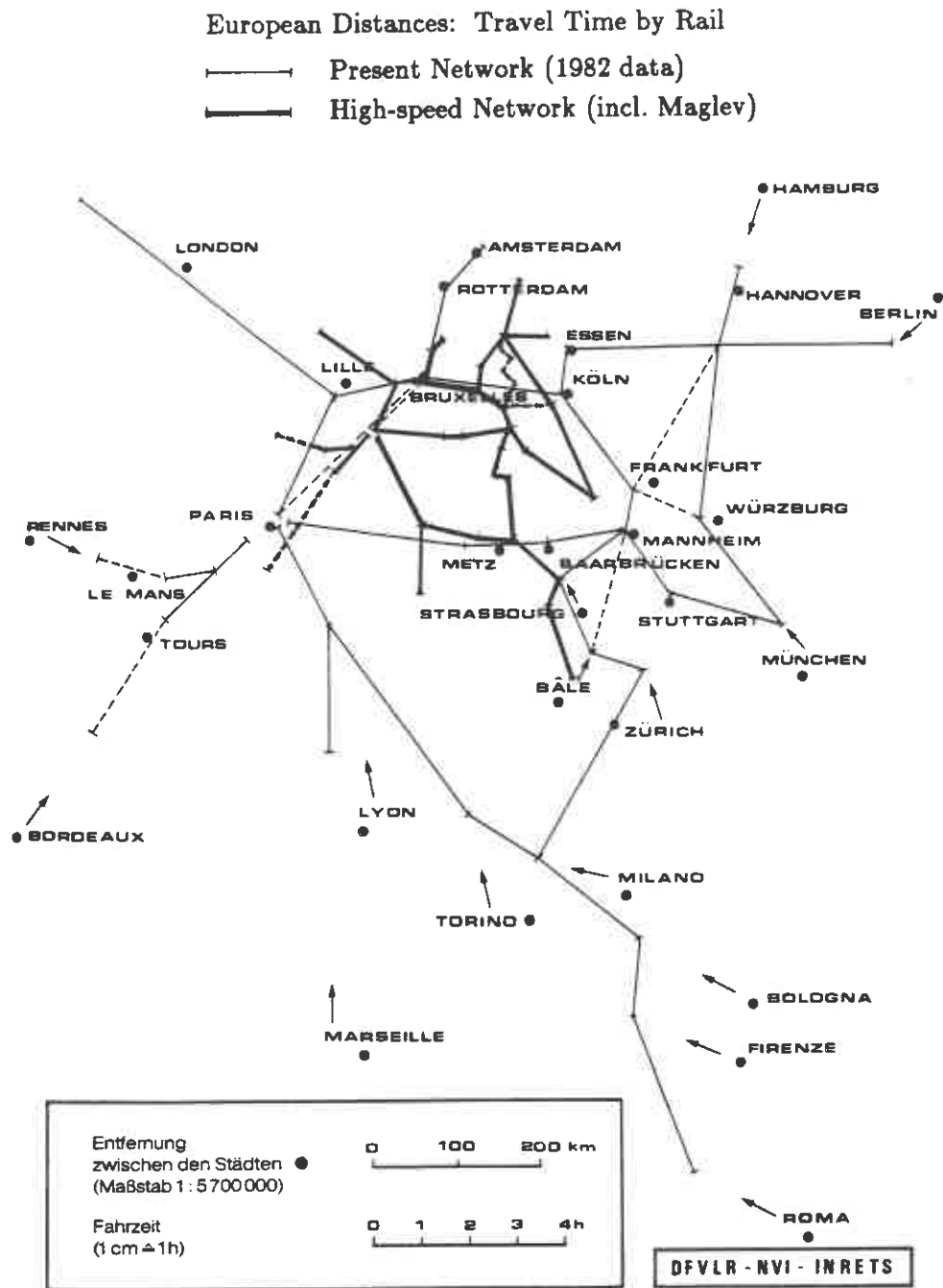
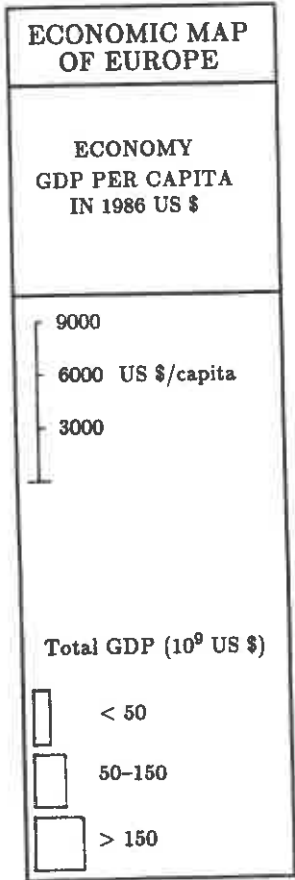
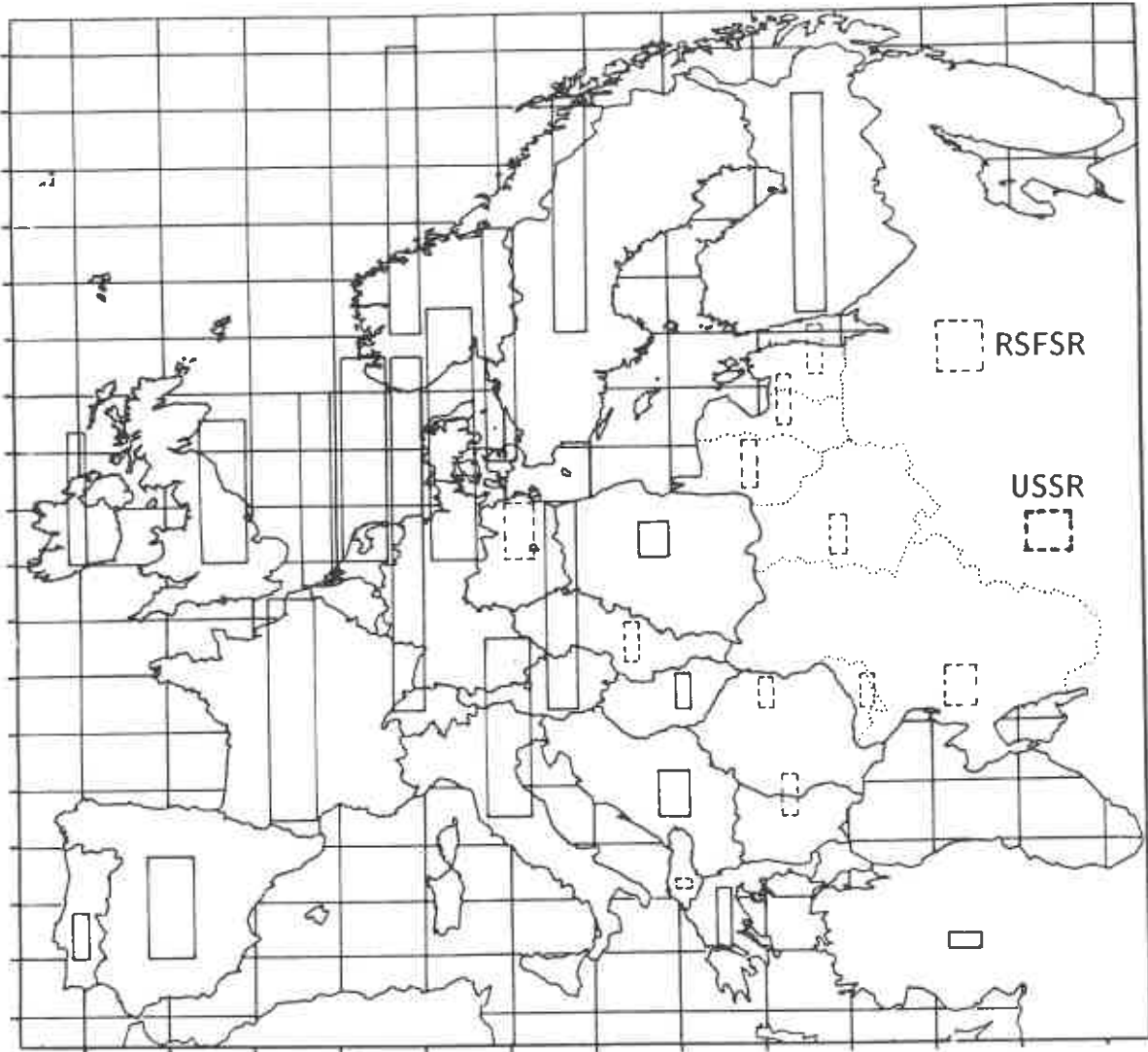
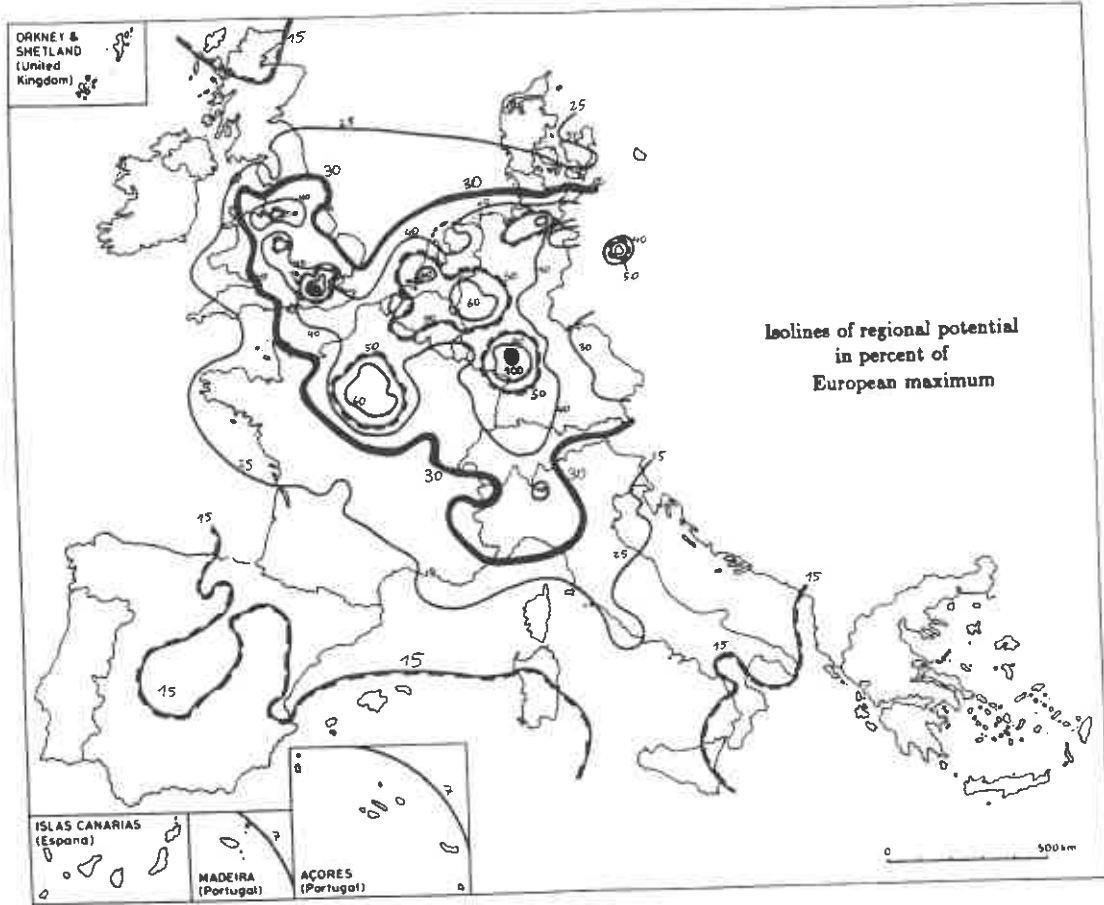

Figure 10. Space-Time Geography of Europe in Kilometers and Travel-Time by Conventional and High-Speed Train. Distances Between Cities are Given in Kilometers, While the Two Networks are Given in Terms of Travel-Time Between the Cities.



Gross Domestic Product (GDP) assesses the value of all goods and services produced. As such it is an indicator of the level of economic development despite a number of serious deficiencies intrinsic in the measure. The height of the bars indicates the per capita GDP while the width gives three categories of absolute levels. In terms of GDP per capita, the level of economic development portrays substantial variations across Europe. It is in excess of US \$ 20,000 per capita in Switzerland and less than one thousand in Albania and Turkey. These are the extremes, but the regional disparity is large. Most affluent area includes France, FRG, Italy, Austria, Benelux and the Scandinavian countries with GDP per capita of more than US \$ 10,000, while Portugal, Yugoslavia, Hungary and Poland are below US \$ 3,000 per capita. Thus, the latter group portrays per capita GDP levels of about one-fourth of the most affluent countries. There are serious obstacles to determining a comparative, aggregate measure of economic activities in the Eastern European countries. They report net material product, which excludes most services and depreciation. Furthermore, the monetary units are given in non-convertible currencies. Our estimates (dashed lines), compounded by a high degree of uncertainty, indicate levels of development characteristic of Southern Europe (less than three thousand US Dollars per capita). This, however, does not allow for a direct comparison of the East and South European economies due to the fundamentally different structure of ownership and income distribution, and the nature of economic activities in general.



ECONOMIC MAP OF EUROPE
ECONOMIC POTENTIALS
EUR 12 in 1983
KEEBLE ET AL., 1988

The concept of a regional economic potential is analogous to that of an electrical potential in physics. It measures the accessibility to economic activity of any particular region. Accessibility to economic activity is a measure for job or business opportunities as well as an indicator for the degree of economic integration to economic gravity centres.

$$P_i = \sum_{j=1}^n \frac{M_j}{D_{ij}}$$

Thus, the economic potential in region *i* is the sum of all of the volumes of economic activities in its surrounding regions *M_j* (measured by GDP) weighted by the intervening distance *D_{ij}* (measured by travel time). The regionalized economic potential are then renormalized with the highest potential being 100 percent. In present day Europe the regions with the highest accessibility to economic activity are Greater-London and is Rheinessen-Pfalz (Frankfurt). Large urban centres have typically around 50 to 60 percent of this accessibility potential, and a value of 30 percent has been adopted to mark the economic potential characteristic for the inner core of Europe. What is particularly striking is the steep gradient in the economic potential between the inner core and the delimitator for the European core area (30 percent of maximum economic potential). In addition, the high gradient between the inner core and the periphery is particularly striking. Spain, Portugal, Southern Italy or Greece have an accessibility to economic activities of generally only 10 to 15 percent of the maximum European potential prevailing in London or Frankfurt.

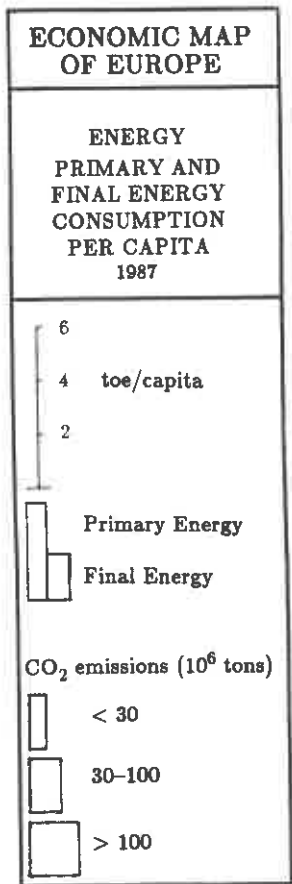
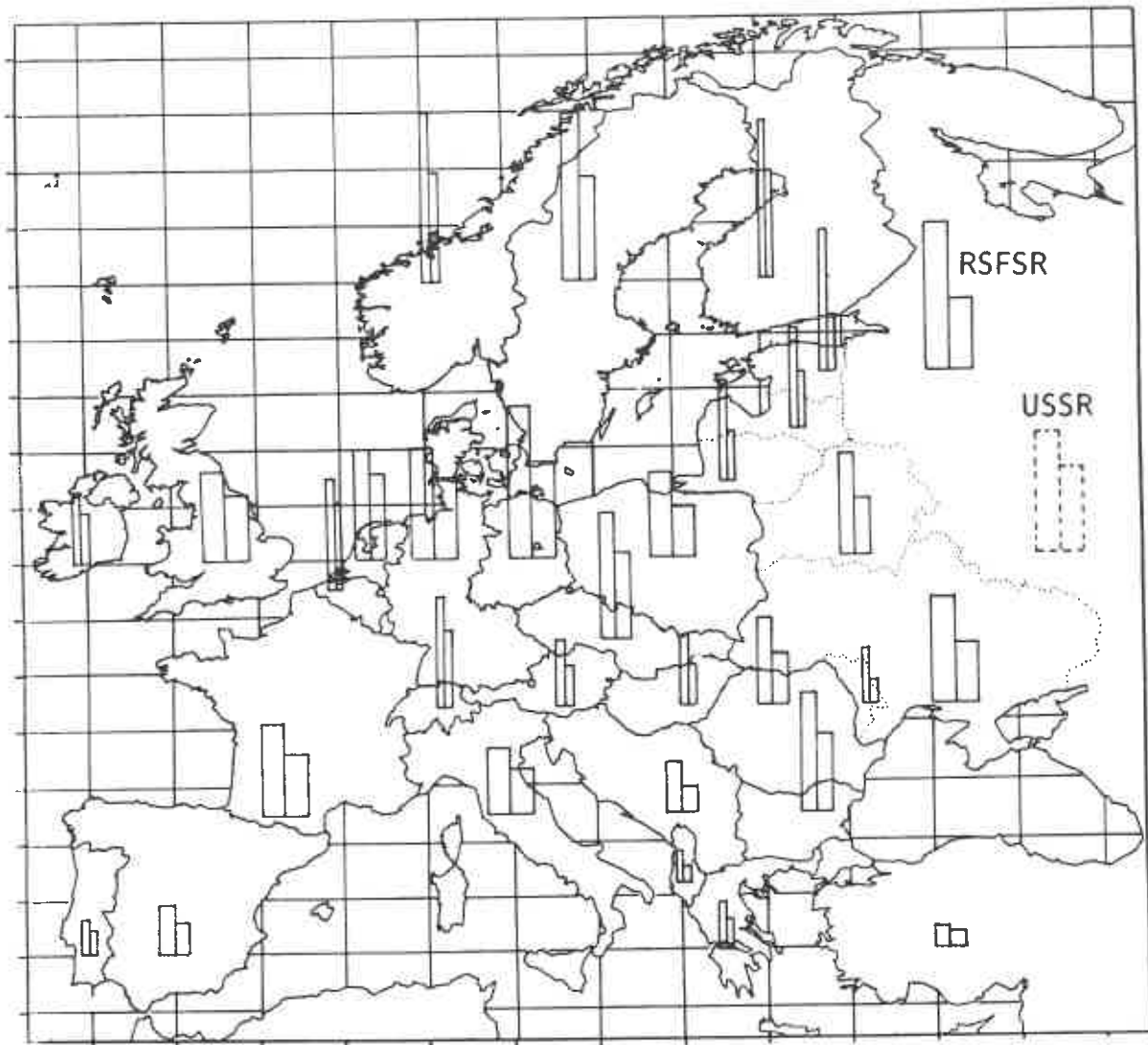

Variations in the levels of total primary energy consumption are not very large between the Eastern European and most affluent countries of Western Europe and Scandinavia. The critical difference is that energy is utilized more efficiently in the Western economies. The efficiency of primary to final energy conversion is low in the East, where about half of primary energy is used in the conversion process compared to about a third in the West. This explains the very high level of primary energy consumption in the Baltic republics. However, final energy consumption is also relatively high in the Eastern countries when compared to those Southern countries with a similar economic development level, such as Yugoslavia, Portugal and Greece, which consume about a third of final energy per capita compared to the Eastern countries. In other words, the value added achieved per unit of final energy consumed is dismally low in the East European countries. Western European countries can produce close to US \$ 5,000 of value added (1986 Dollars) per toe final energy, while in Eastern Europe levels are typically about five times lower. On the extreme ends are Switzerland (with US \$ 7,000 per toe final) and Romania (with US \$ 700 per toe final). Thus, energy intensity in the economies of the East is very high by Western standards, and the efficiency of their energy systems in converting primary energy to fuels and electricity is very low. The height of the bar shows per capita primary energy consumption on the left and final energy consumption on the right. The width of the two bars give three categories of absolute levels of energy consumption in terms of the resulting carbon dioxide emissions.

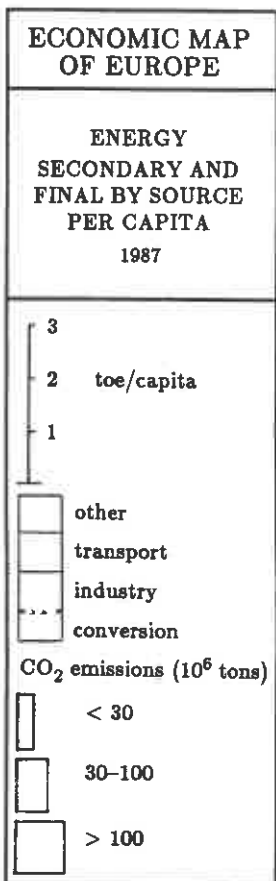
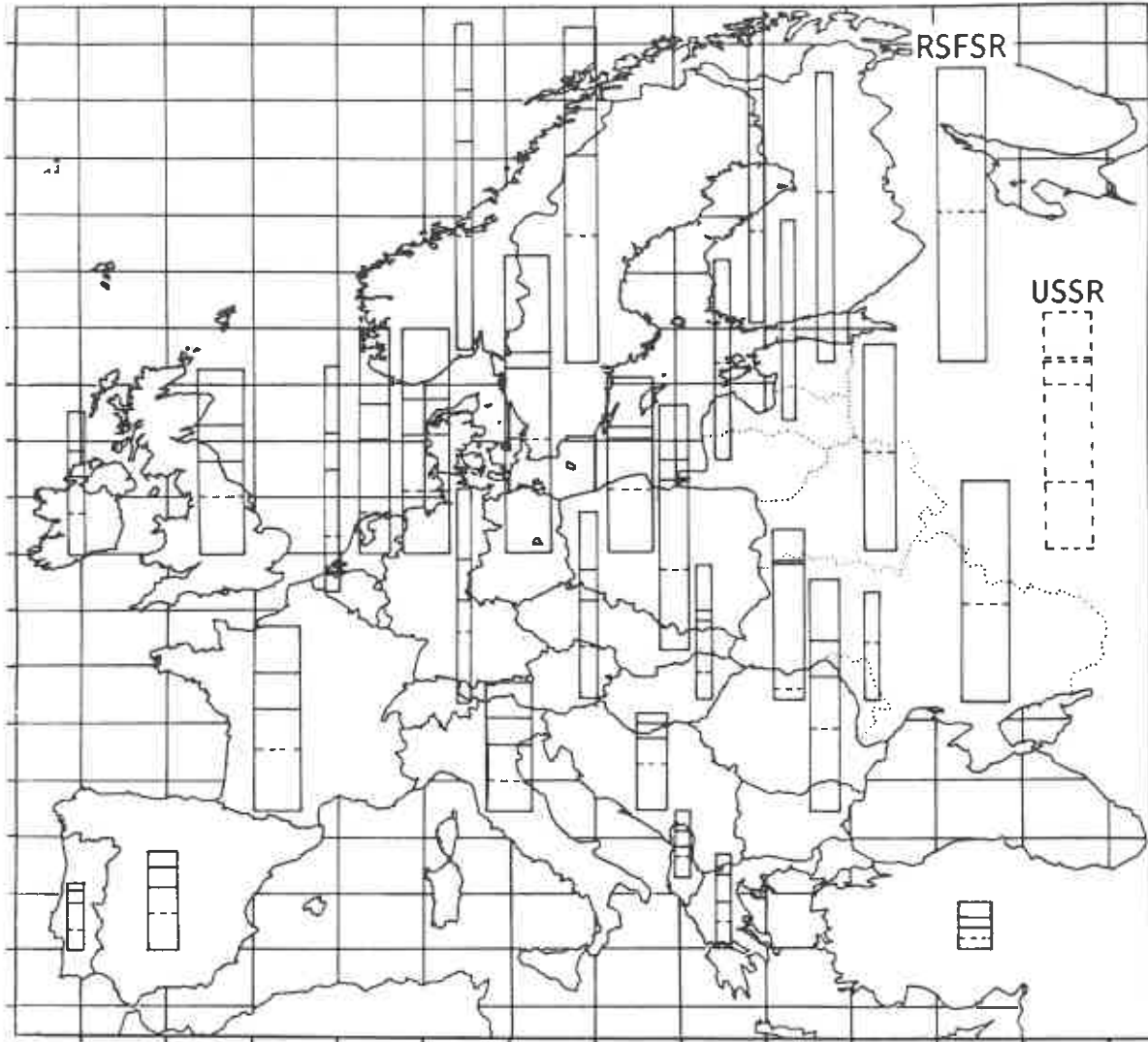

Each individual bar indicates secondary energy delivery including all fossil fuels, electricity and some district heat. After various transformation (conversion) steps, secondary energy carriers are delivered to the consumer as final energy. Conversion steps include storage, transport and distribution. Losses and own consumption of the energy sector are also included under this category (conversion). Their share in the secondary energy is indicated by the dashed line. The rest constitutes delivered final fuels, electricity and heat. Subdivisions of each bar indicate the consumption of delivered final energy in different sectors of the economy: in industry, transport and other sectors (i.e., agriculture, households and commercial). The height of the bars indicates the per capita consumption and the width gives three categories of absolute level of energy consumption in terms of resulting carbon dioxide emissions. The transformation of secondary to final energy is clearly very inefficient in Eastern Europe. Relatively large quantities of secondary energy are required in the transformation process so that comparatively small shares are delivered as final fuels and electricity to the consumer. Southern Europe consumes the least amount of secondary and final energy per capita so that the resulting absolute consumption and the related carbon dioxide emissions are rather low compared with the levels prevailing in other parts of Europe. While in general energy consumption is a good proxy for the level of economic development, as indicated by the difference in energy consumption between North, Central and South Europe, the relatively high levels of energy consumption in the Eastern countries do not correlate with this trend due to very low utilization efficiencies.

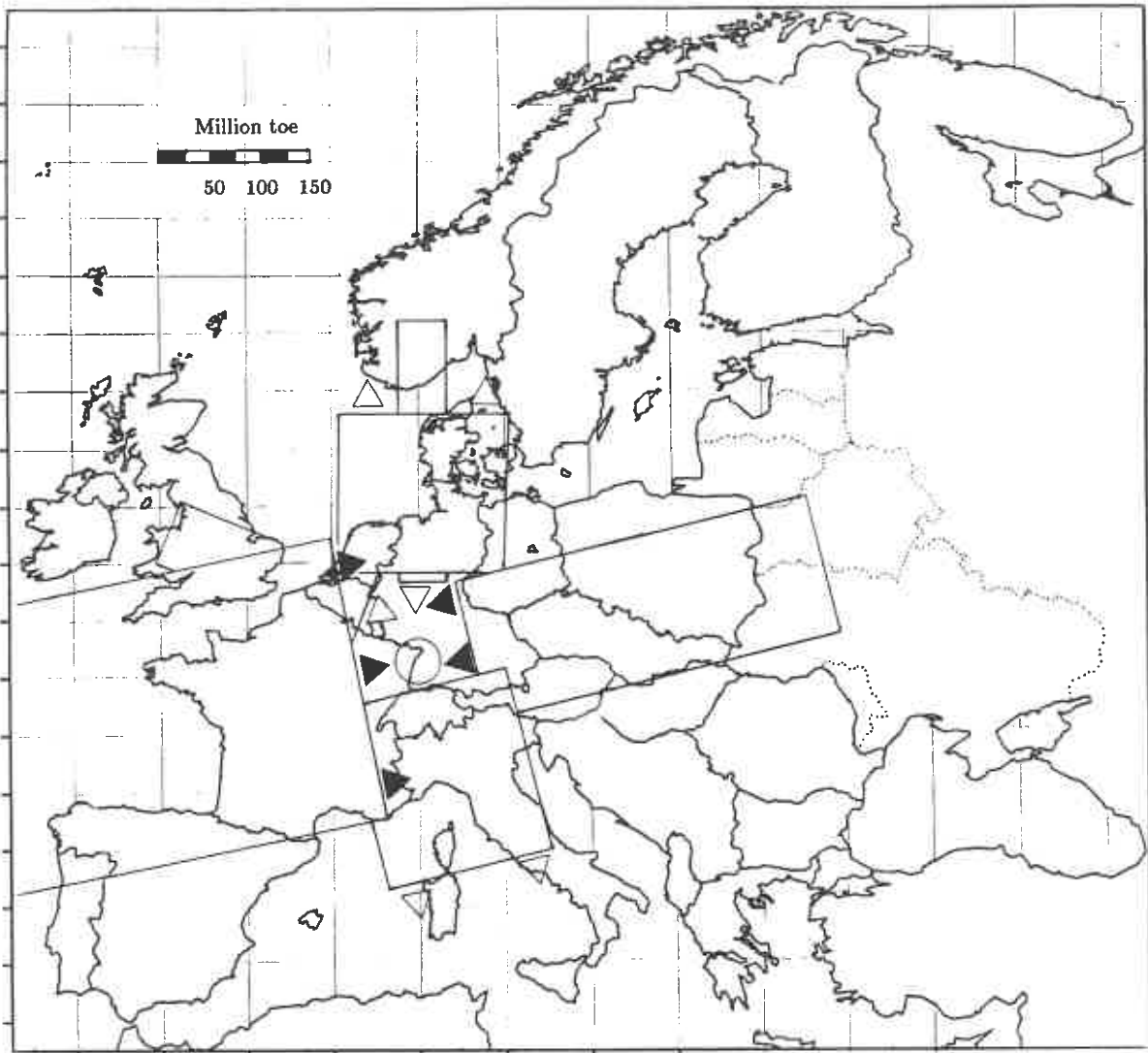

ECONOMIC MAP OF EUROPE

ENERGY FLOWS IN EUROPE:
OIL, GAS & COAL
IN 1986

Crude Oil & Products

Imports 

Intra-European 

Energy flows in Europe are shown for Community countries in terms of the width of the oriented bars. The width of the bars gives the relative magnitude of energy imports and trade. The direction of flow is indicated by the triangles (arrow of flow). Shaded triangles represent imports into Community countries while white triangles denote intra-European energy flows. West European energy net import dependency exceeded 40 percent of total primary energy consumption in 1986. The map shows crude oil and oil product imports and trade, indicating that the largest imports are from outside Europe (mainly the Gulf region). Half of that amount originates from Soviet Union (about 140 million boe). In comparison, the intra-European flows are of almost equal magnitude to imports. This means that European interaction in the oil trade is as strong as the oil import dependency. The first overlay gives only crude oil trade and imports, and illustrates how large the crude imports from the OPEC countries are in comparison to North Sea and Soviet supplies. Thus, most of the intra-European interaction constitutes trade that originates from a few relatively large refineries. The second overlay gives natural gas trade and imports, showing again that "domestic" production from the North Sea is almost as large as the imports from the Soviet Union. The third overlay gives coal imports and, in comparison, shows relatively small intra-European flows and imports from Poland and Eastern Europe.

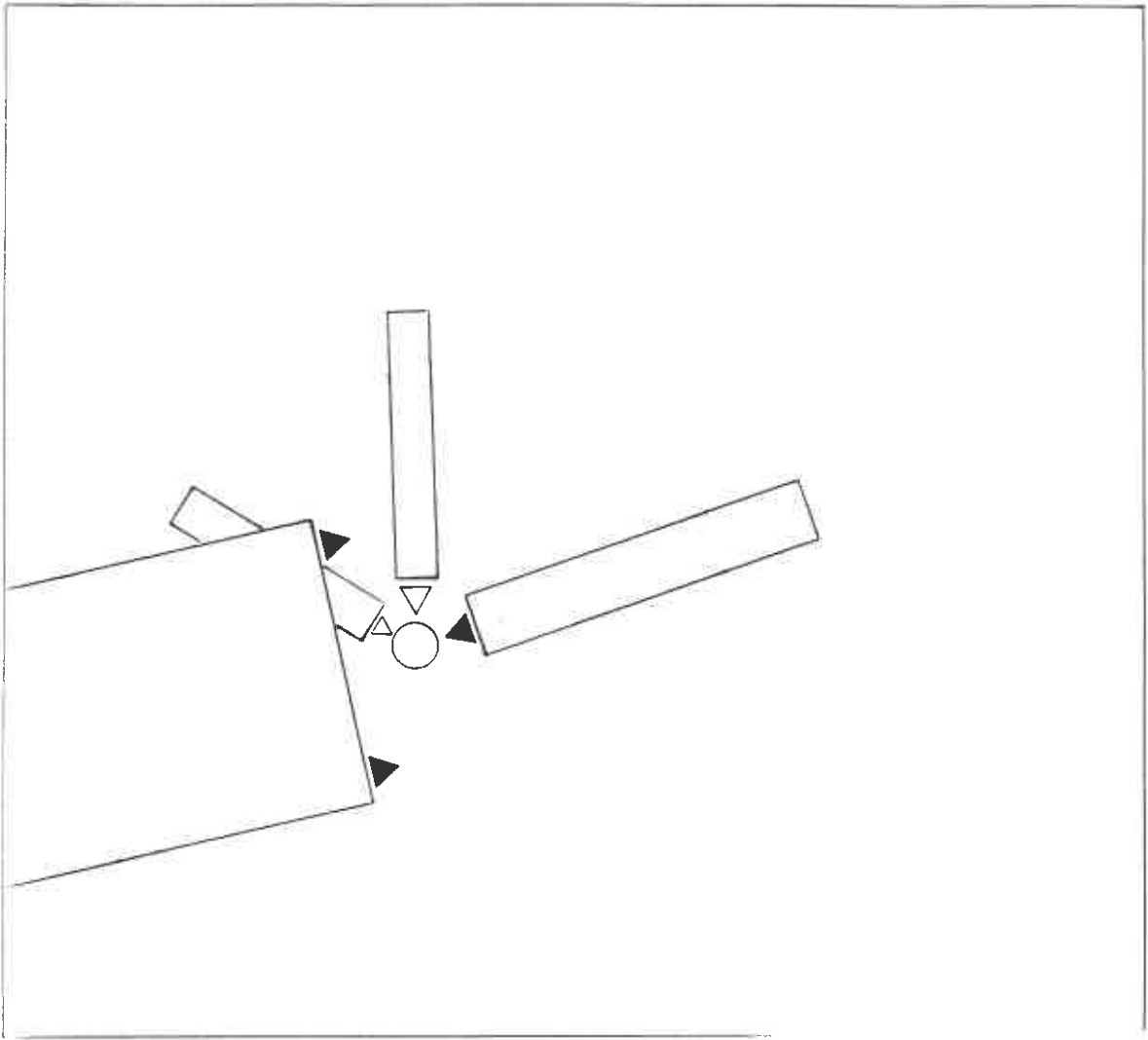

Crude Oil

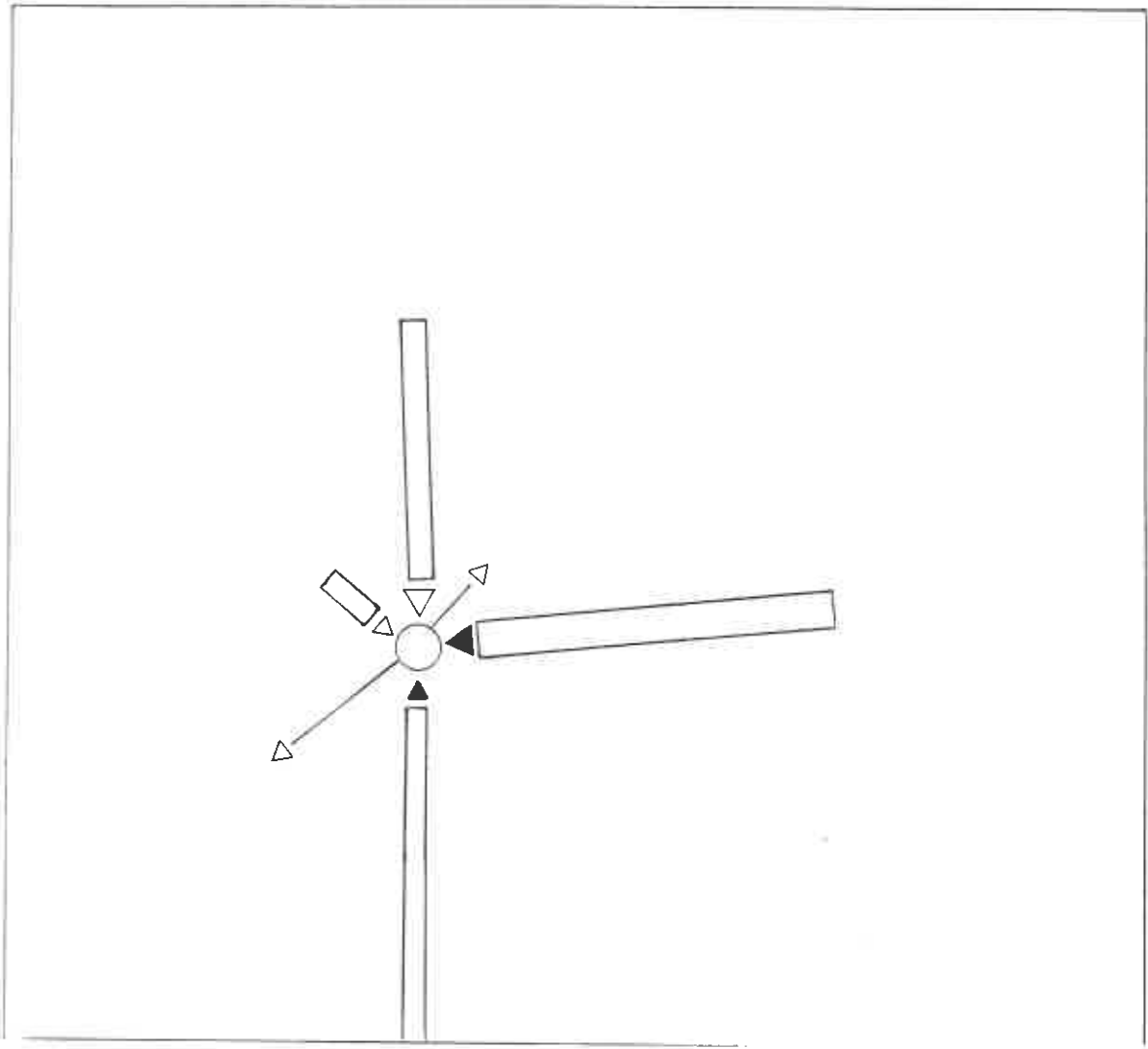

Natural Gas

44

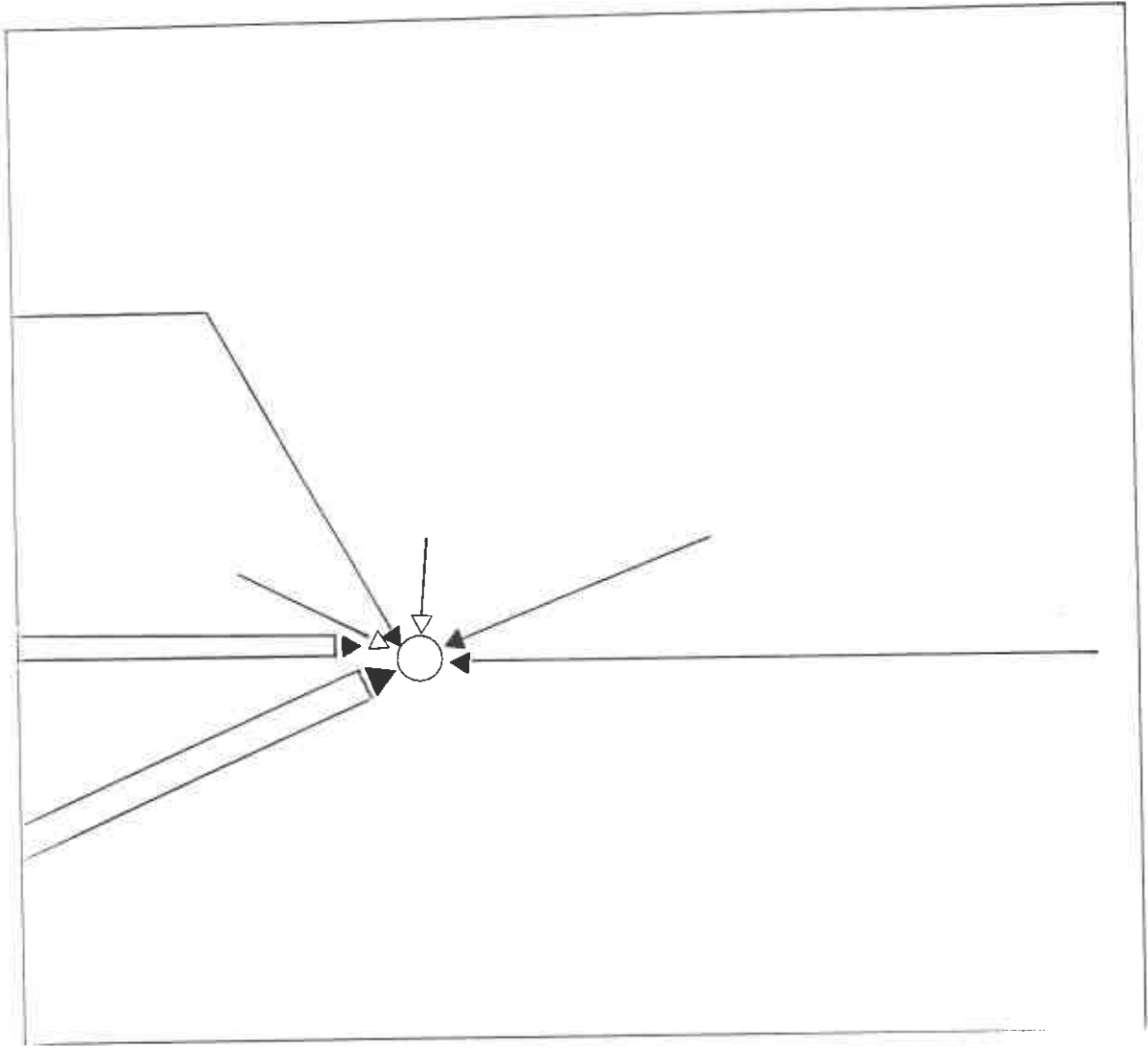

Coal

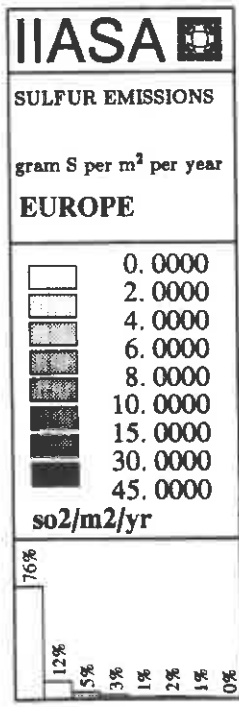
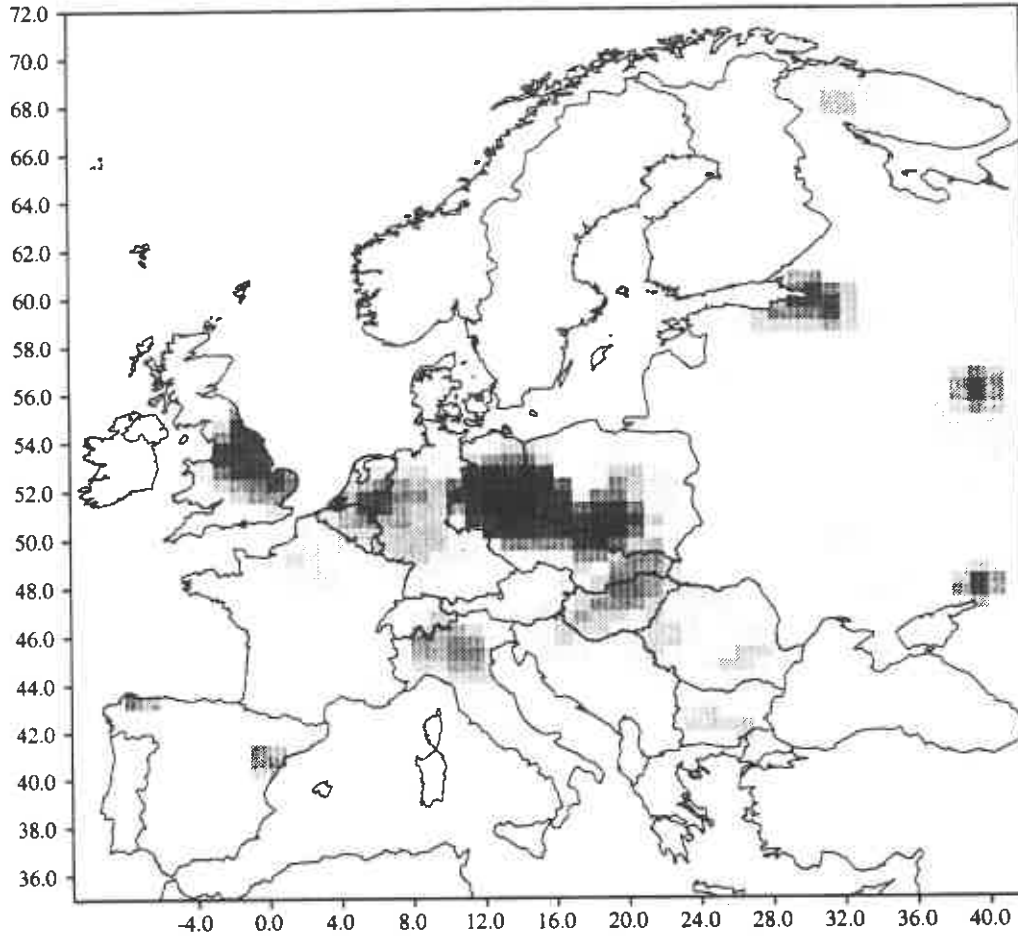

European sulfur dioxide emissions are given in grams SO₂ per square meter per year as of 1985. Low efficiency of energy utilization and the coal intensive energy supply mix in the East European countries results in extreme environmental burdens. This is clearly illustrated by the heavily shaded region between the German Democratic Republic, Czechoslovakia and Poland. It denotes sulphur dioxide emissions in excess of 15 grams per square meter per year, resulting in catastrophic environmental degradation and acid rain. In some bordering regions of the Federal Republic of Germany, the resulting transborder pollution is so high as to exceed all local sources added together. Other areas with high emission levels are the Soviet Union, England, the Benelux countries, the Federal Republic of Germany, North Italy and Spain. Thus, the emission of air pollutants in Europe is a heavy burden both to the local environment in the emitting country and to other countries. This is unfortunately one of the few areas in which Europe is fully integrated. Pollution flows do not respect national and political boundaries. It is also one of the areas in which cooperation and coordinated action can benefit all. For example, sulphur abatement measures in Scandinavia and the Federal Republic of Germany are fairly advanced so that further reductions would require enormous investments. If those investments were made in the countries causing much of the cross border pollution instead, it would not only substantially reduce pollution within those countries, but would have a much larger effect in Scandinavia and the Federal Republic of Germany.

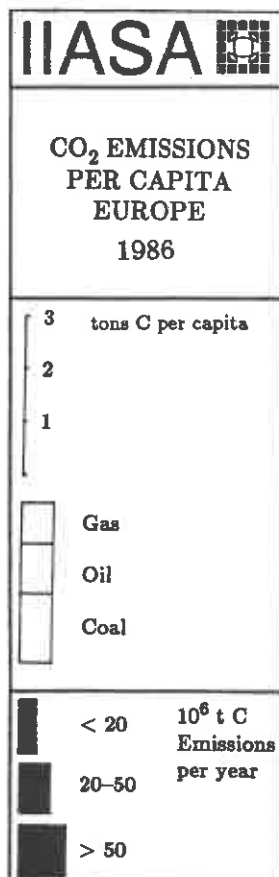
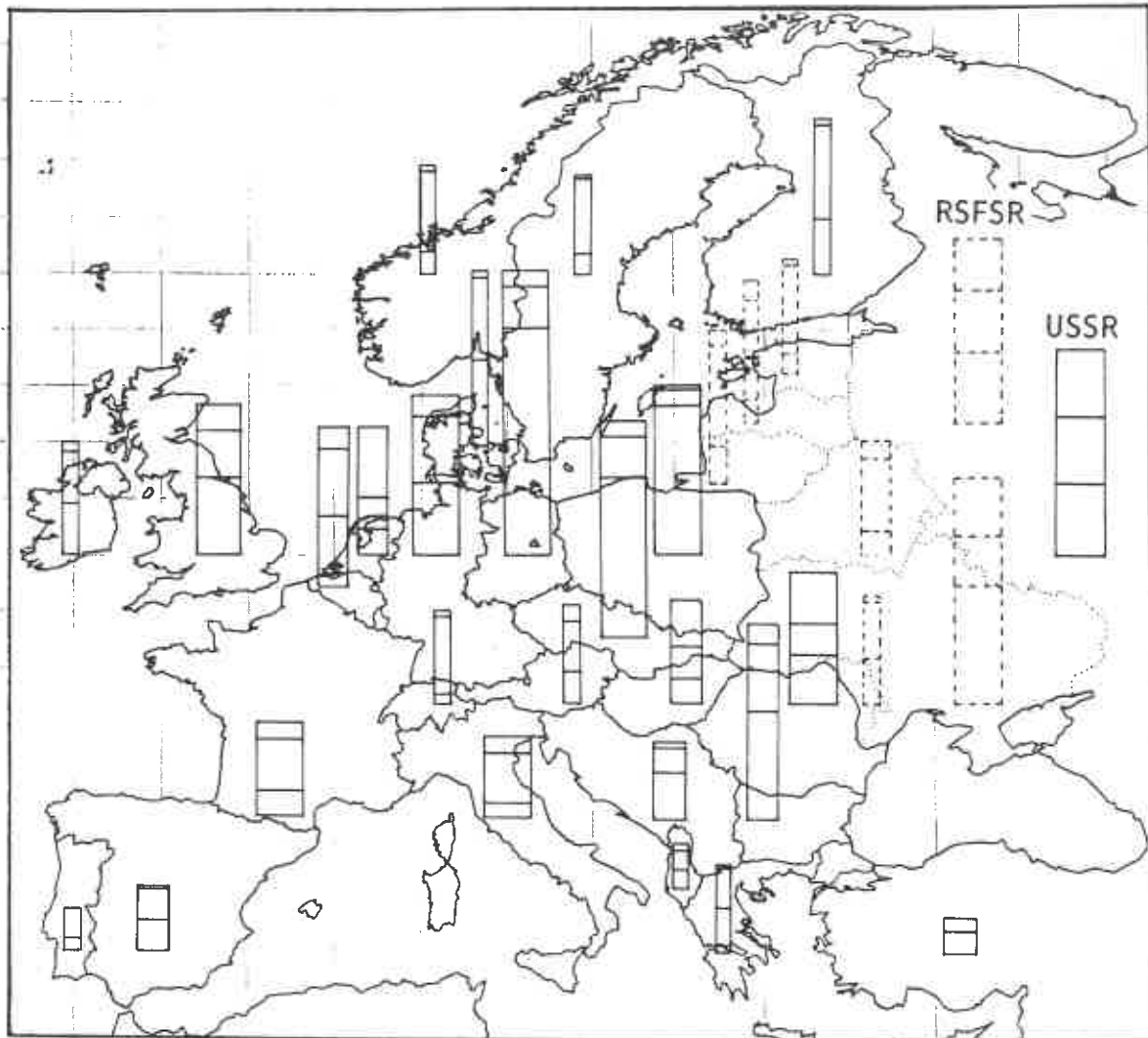

Carbon dioxide emissions are given in terms of tons of carbon emitted into atmosphere per capita per year. The height of the emission bars gives the per capita and the width three categories of absolute levels of carbon emissions. As in the case of sulfur dioxide, the low efficiency of energy utilization and the coal intensive energy supply mix in the East European countries generate very high levels of carbon dioxide emissions. The highest carbon dioxide emissions in excess of 5.6 tons carbon per capita are emitted in the German Democratic Republic. Czechoslovakia and the Ukraine also emit in excess of 4 tons of carbon per capita. These are also the European countries with the highest share of coal in primary energy consumption. In terms of carbon dioxide emissions per unit of GDP generated, the difference between Eastern and other European countries is even larger. Two extremes, with a difference of a factor of 25, are Switzerland with 80 kilograms of carbon per US \$ 1,000 value added and the Ukrainian SSR with almost 2 tons carbon per same value of goods and services produced. This vividly illustrates that environmental impact is not just a function of the economic and social activity levels but also depends on the energy system structure and the efficiency of energy utilization. For example, emission levels are two or three times higher in Eastern Europe than in those Southern European countries that have about the same level of economic development. Thus, carbon dioxide emissions provide a sharp distinction between the relatively efficient and service-oriented economies of the core, and the energy intensive industrial structure of the Eastern countries which resembles the industrialization path that was predominant in Western Europe some 50 years ago.

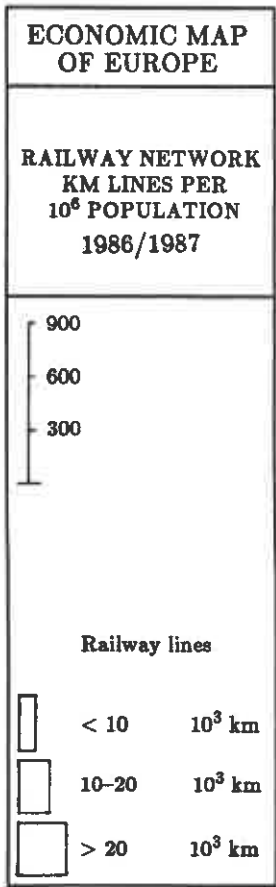
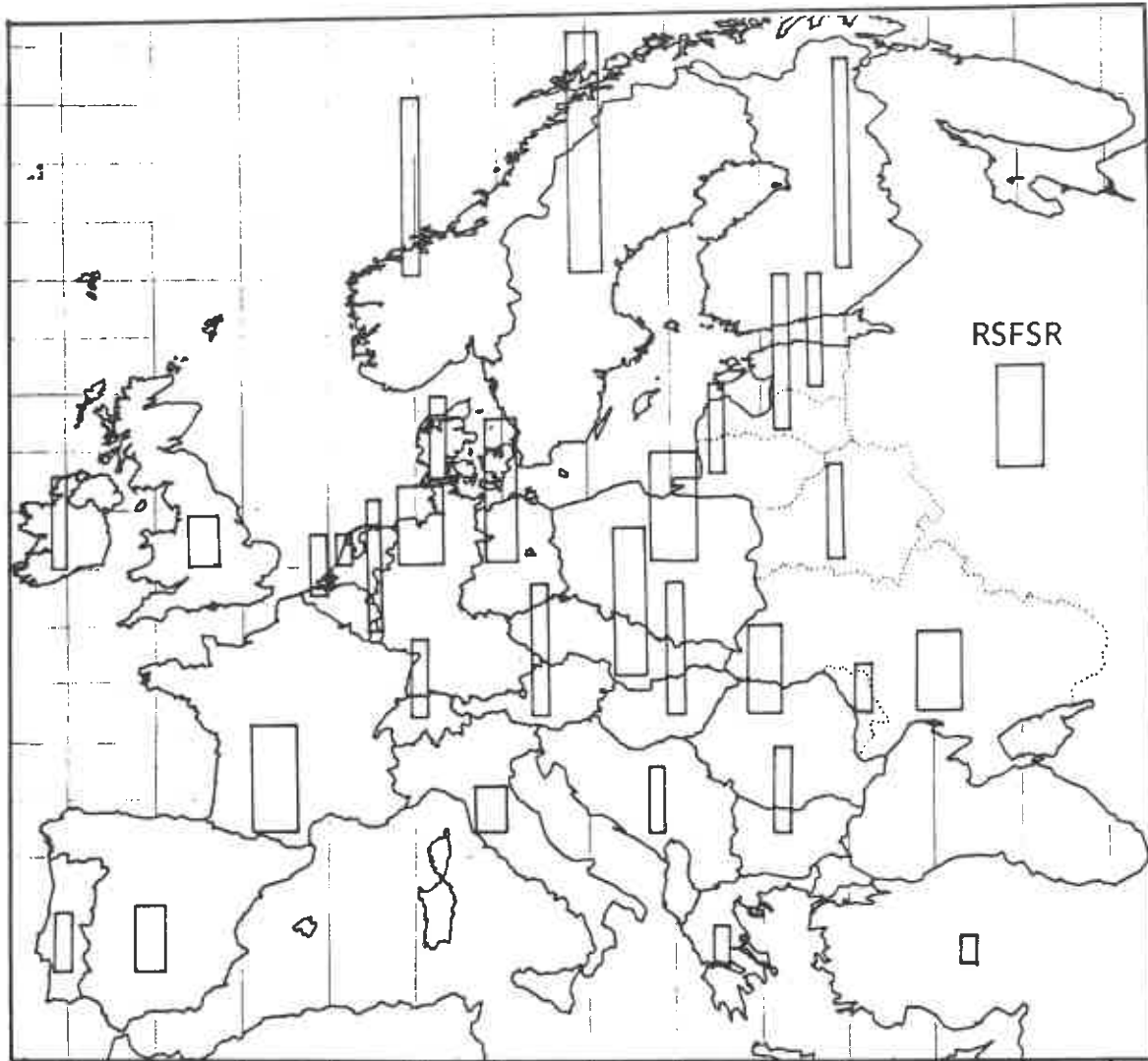

The height of the bars indicates the relative per capita size of railway networks in kilometers line length per million inhabitants. The width gives the absolute network size of each country subdivided into three categories. This is one of the rare comparative indicators for which European countries display a rather limited variation. In fact, Scandinavian countries, who have the longest networks with more than one meter railway line per inhabitant (but with low population and railway network density), are closely followed by the East European countries, the Soviet Union and Austria with between a half and one meter per inhabitant. The lowest per capita railway networks are in Southern Europe and the Community countries, all with less than half a meter railway line per capita (the exception being France with slightly more). The absolute lowest per capita railway density is in the Netherlands, followed by Turkey and then Greece. Great Britain also has a rather low per capita network size. In most of the Community countries this is due to the erosion of the infrastructure; for example, in Great Britain, and Denmark half of the maximum network size achieved during the 1930s has been dismantled. Considering the population growth since then, the actual per capita network size by 1930 was higher in these countries than in the Scandinavian countries and Eastern Europe today.

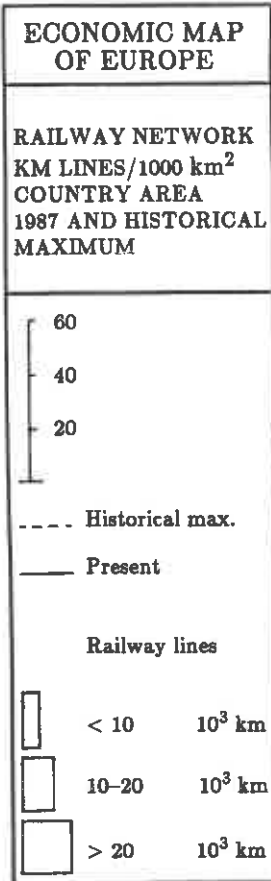
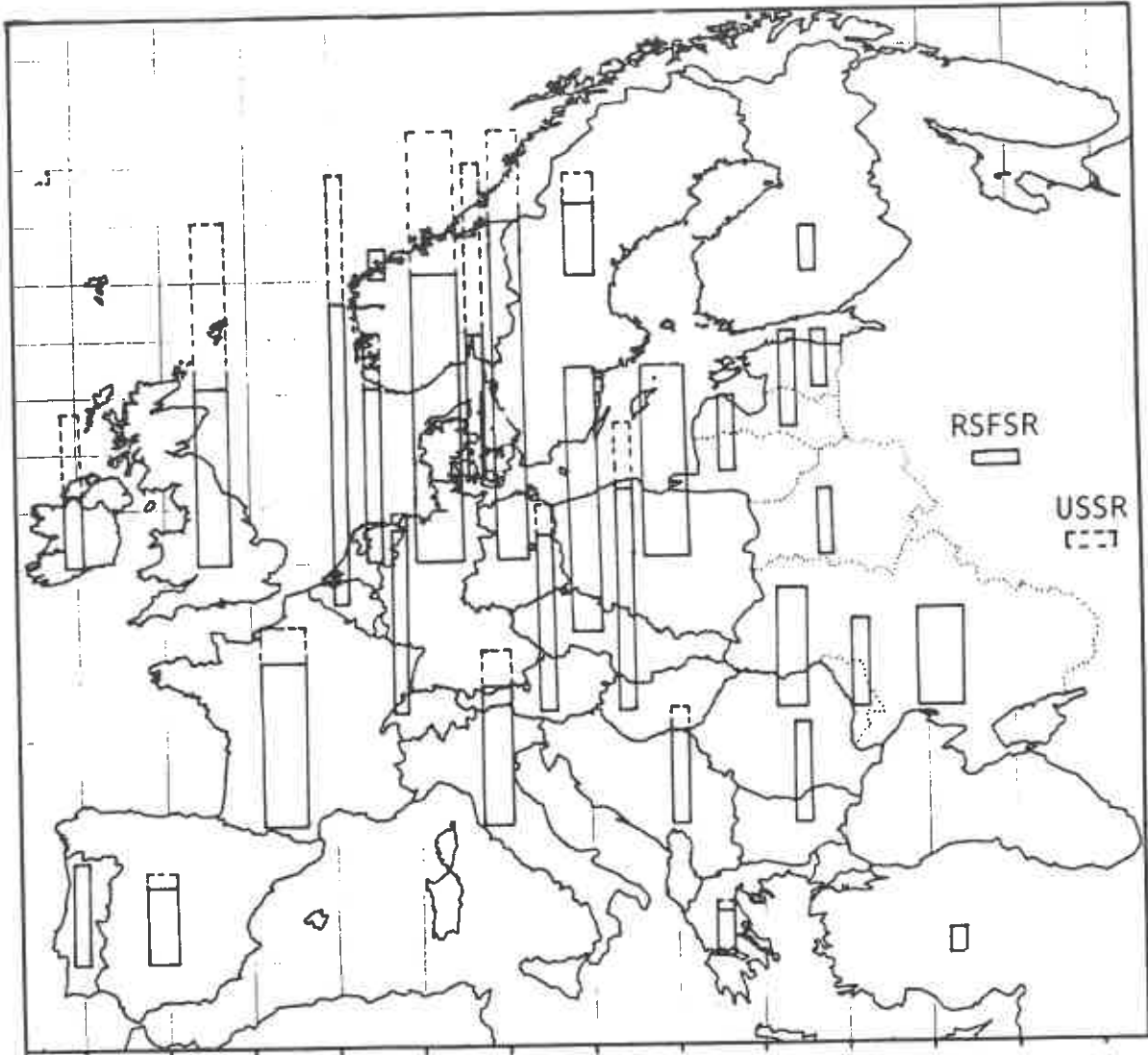

Density of railway lines per unit area of the country varies substantially among European countries. The height of the bars indicates the length of the whole railway network in kilometers per thousand square kilometers country area. The dashed portion of the bars gives the length of decommissioned lines, so that the sum of the two heights indicates the historical maximum network length. The width gives the total length of railway lines subdivided into three categories. In a number of Western countries about half of the historical maximum network achieved during the 1930's has been already decommissioned. With the exception of Hungary, there has only been a relatively small net decrease in the network size of most of the East European countries. However, much of the decrease in Hungary is due to territorial changes. The current network length per capita in most Eastern European countries is quite extensive; notable exceptions are the Soviet Union (including most of its Republics), Romania and Bulgaria. Southern Europe also has a relatively small network length compared to the rest of Europe. Thus, railway development is one of the few areas where Eastern Europe does not lag behind the West. However, decommissioning of obsolete lines, which occurred decades ago in the Western countries, is very likely during the next decades as the East European countries shift some of their passenger and goods transport to roads.

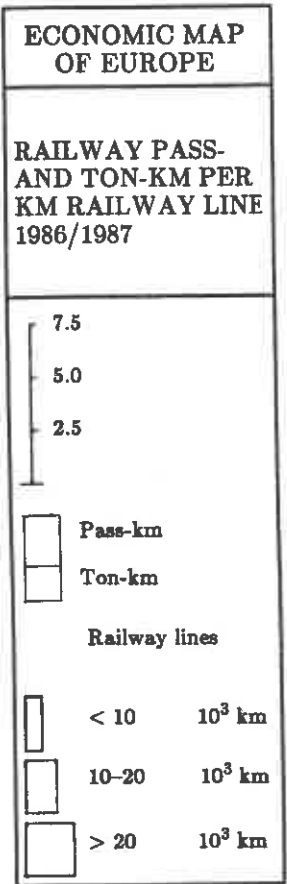
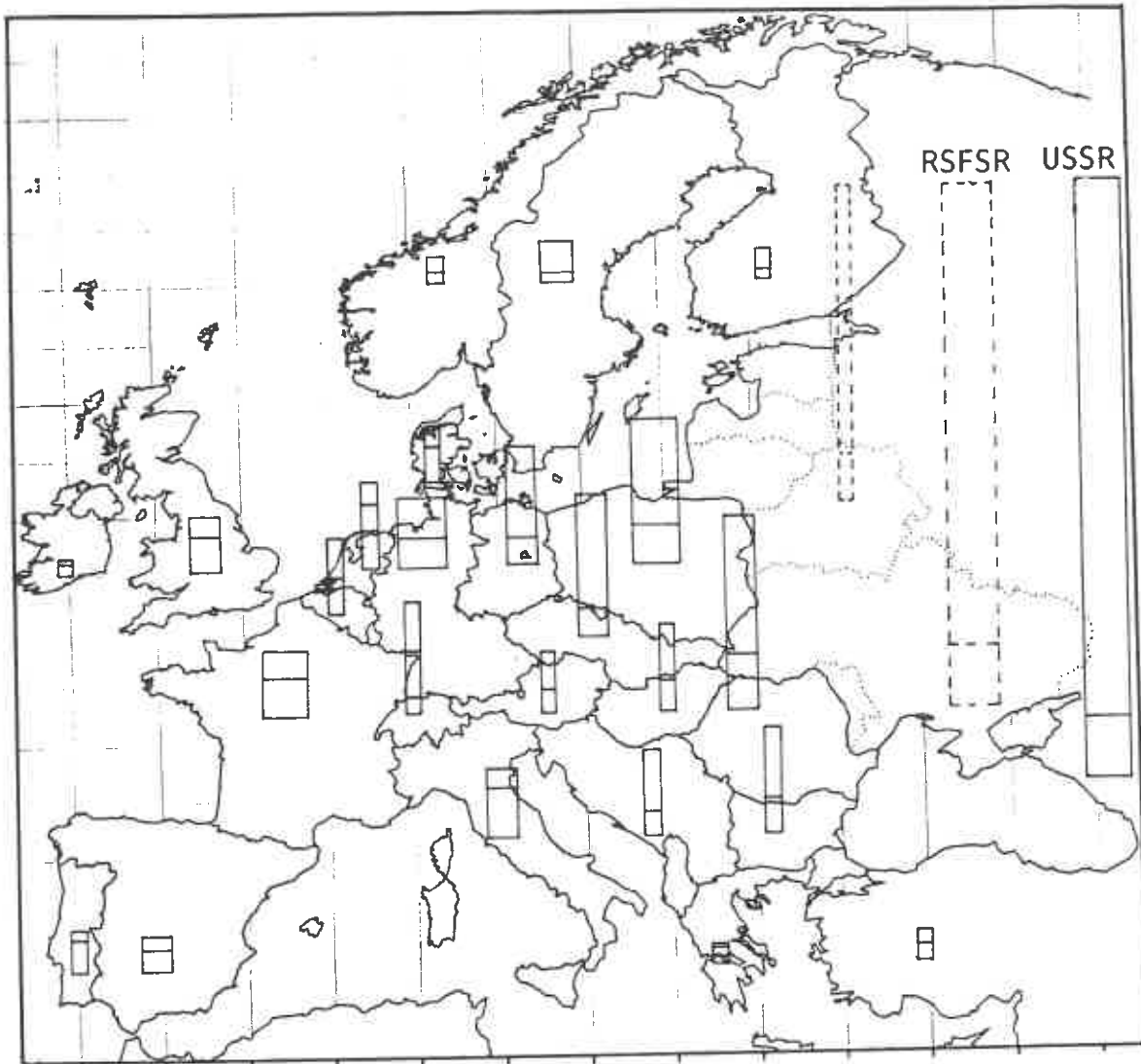

The height of the bars gives the sum of passenger-kilometers and ton-kilometers transported per kilometer of railway network in place. The individual shares of passenger and goods transport are also indicated. The width gives the size of the railway network subdivided into three categories. The most apparent feature is the high level of railroad utilization (per kilometer of network): it is ten times larger in the USSR than in the European Community countries. Also noteworthy is the large difference in railway network utilization within the USSR. In 1978, for instance, 178 billion ton-kilometers were transported by the busiest 1,250 kilometers. This is more than the tonnage carried by the combined networks of Austria, France, the Federal Republic of Germany and Switzerland. Another important difference is the relative share of passenger and goods transport. Passenger transport constitutes the major portion of Eastern European operations, but is the smallest part of overall operations in the other countries. In fact, the utilization of railway networks for goods transport is about the same in most European countries, but in the East railways carry many times more passenger-kilometers per kilometer railway lines. To an extent this is a manifestation of the relatively low level of individual transport systems and the small railway network size compared with the volume of operations. The goods transport utilization in Western countries has been maintained at internationally representative levels because the major market segment consists of low value and bulky goods.

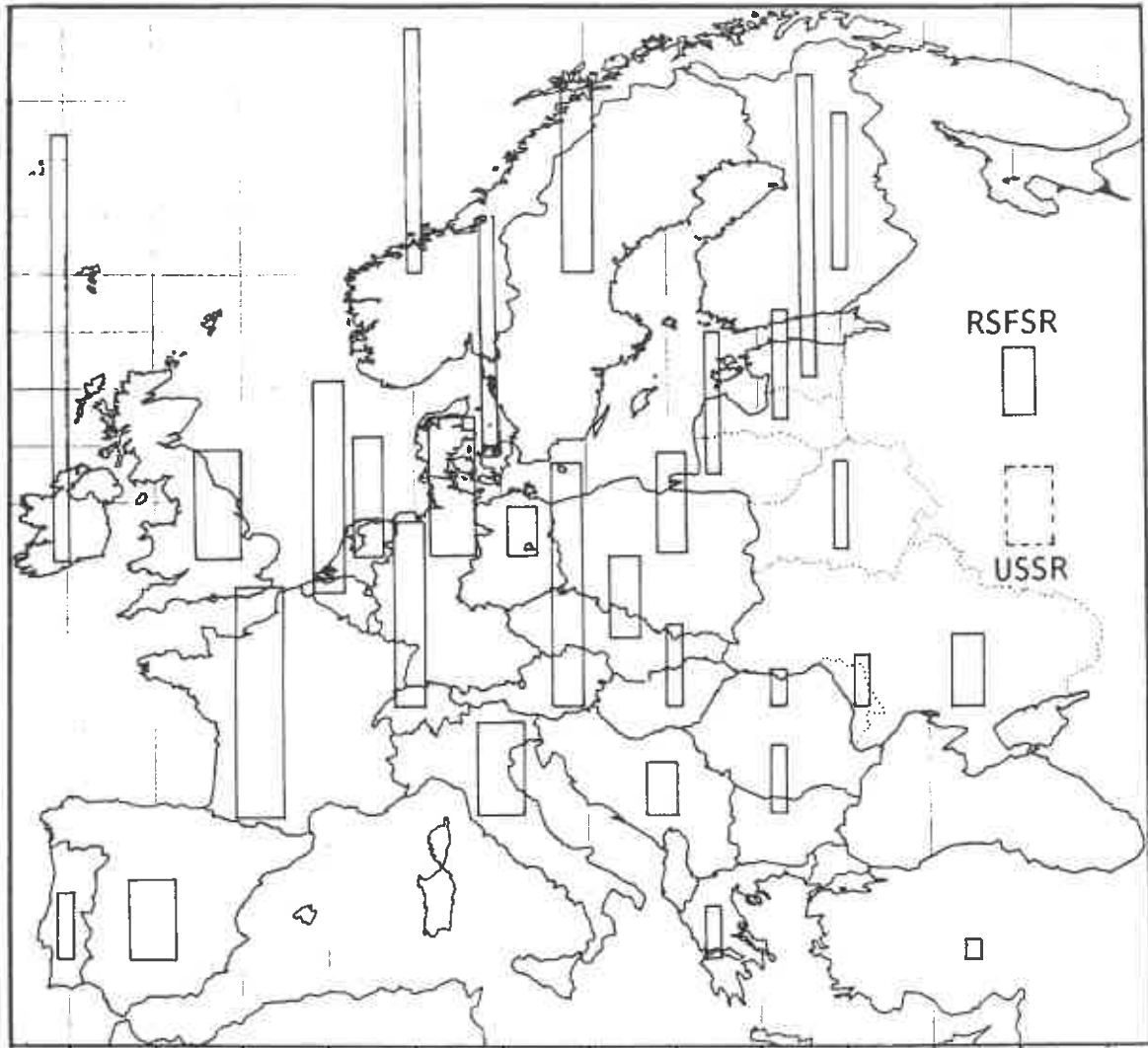

ECONOMIC MAP OF EUROPE

SURFACED ROADS (all roads) METERS/CAPITA EUROPE 1987

10
5

Road network

	< 50	10 ³ km
	50-200	10 ³ km
	> 200	10 ³ km

The size of national road networks is given in meters of all surfaced (paved) roads per capita. The height of the bars gives the meters of surfaced (paved) roads per capita, while the width indicates the size of the road networks subdivided into three categories. European Community countries and Scandinavia have large road systems of about 10 meters per person or more, while the Eastern countries have about half that length. This underestimates the relative difference between the East and West in terms of the importance of road transport and the associated infrastructures. The quality of roads is much higher in the Western countries and the share of motorways, highways and Autobahnen is much higher than in the East European countries. Furthermore, the infrastructural support of the road network is much better starting with fuel and service stations, bridges, tunnels and going all the way to the maintenance of roads themselves.

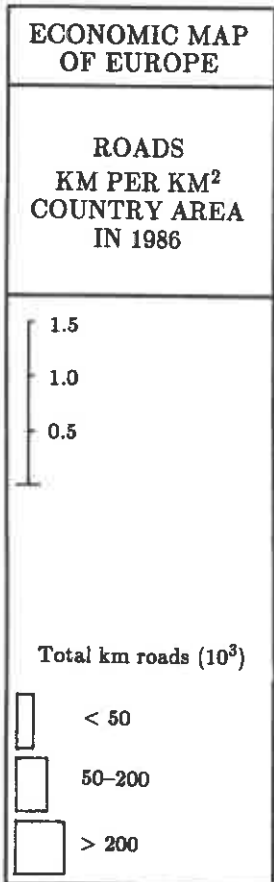
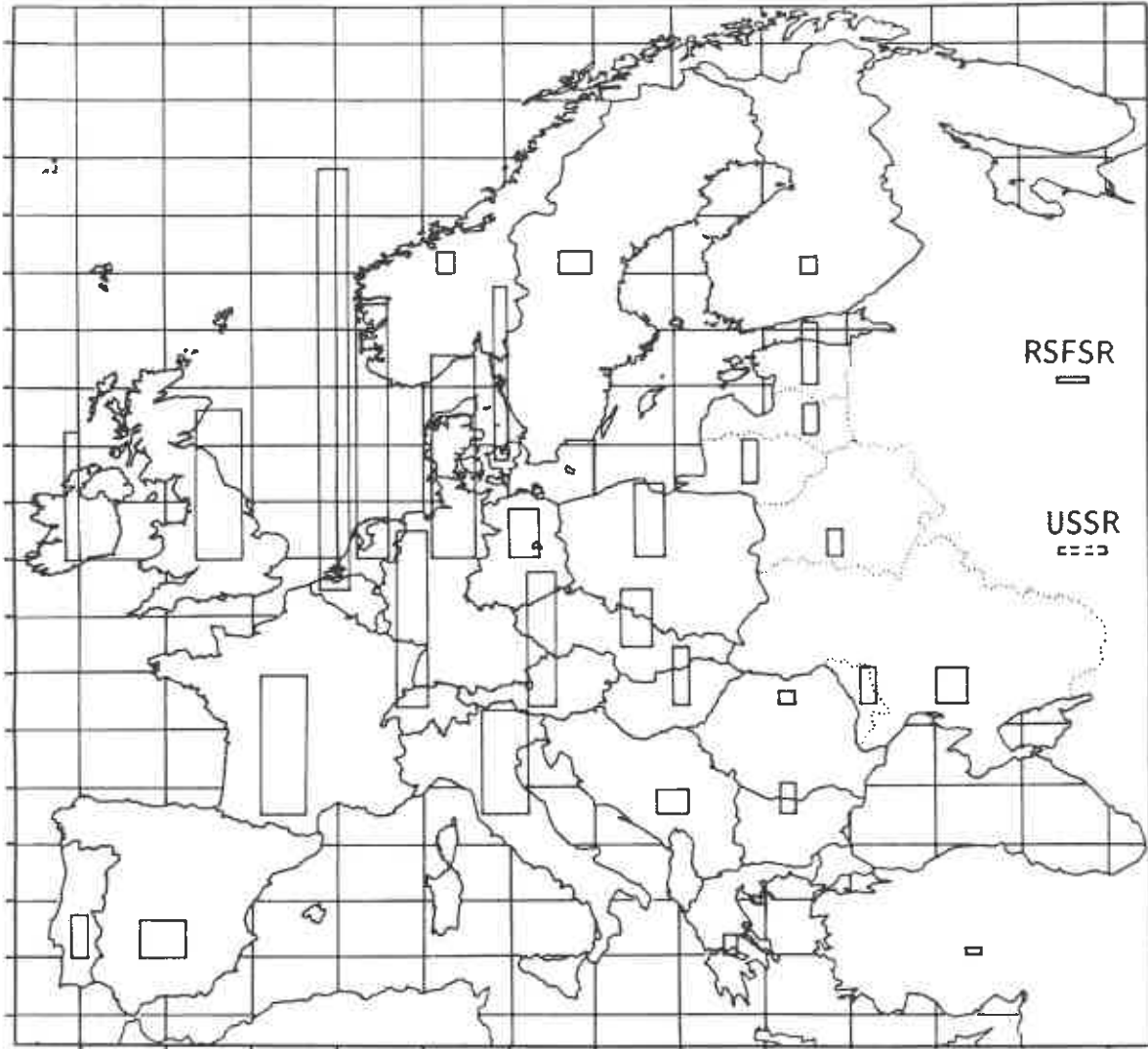

The height of the bars is proportional to the density of the road network in total length kilometers per square kilometer country area, while the width of the bars indicates the absolute network length and is subdivided into three categories. Road infrastructure endowments are unequal. They are lowest in Eastern Europe (and Turkey), and highest in the Community countries, falling off towards both the North and South. The relatively high population densities of the Community countries is part of the reason for the relatively dense road system, but these averages mask the important difference in the quality of the networks. The countries with the highest infrastructure density also have the highest automobile and commercial vehicle ownership rates, greatest road infrastructure utilization, and the best quality roads consisting of very productive priority networks. Autobahnen, highways and motorways can carry much more traffic than average roads, and at much higher speeds. This explains some of the advantages of a modern road transport system over railways: higher speed, flexibility and quality. Infrastructure density is the highest in the Benelux countries. In particular, Belgium not only has the largest network of roads per unit land area, but also one of the densest and illuminated motorway systems making road transport even more efficient. In contrast, infrastructure quality in the East is rather poor: average speeds are very low, as is individual automobile ownership. The whole system therefore is not much more attractive than railways. Overall road system density gives a good indication of the relative mobility of European countries, and their structure and economic system with respect to the value and quality of products transported.

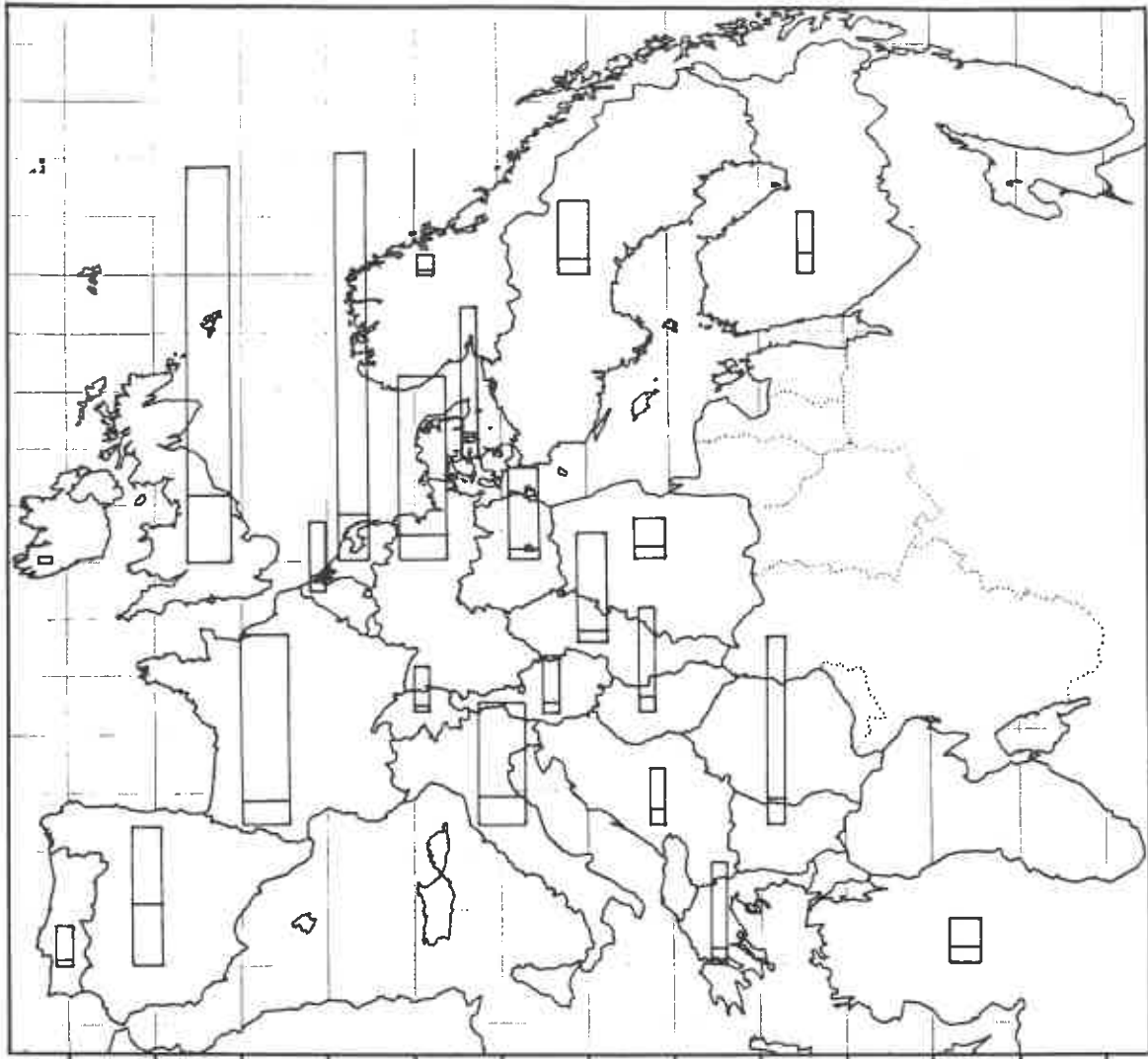

ECONOMIC MAP OF EUROPE

ROADS
TON- AND PASS-KM
PER KM HIGHWAY &
NATIONAL ROAD
IN 1986

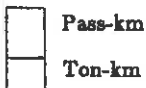
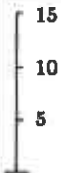

Road transport volume

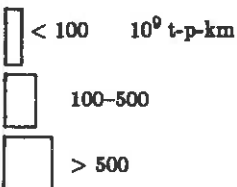

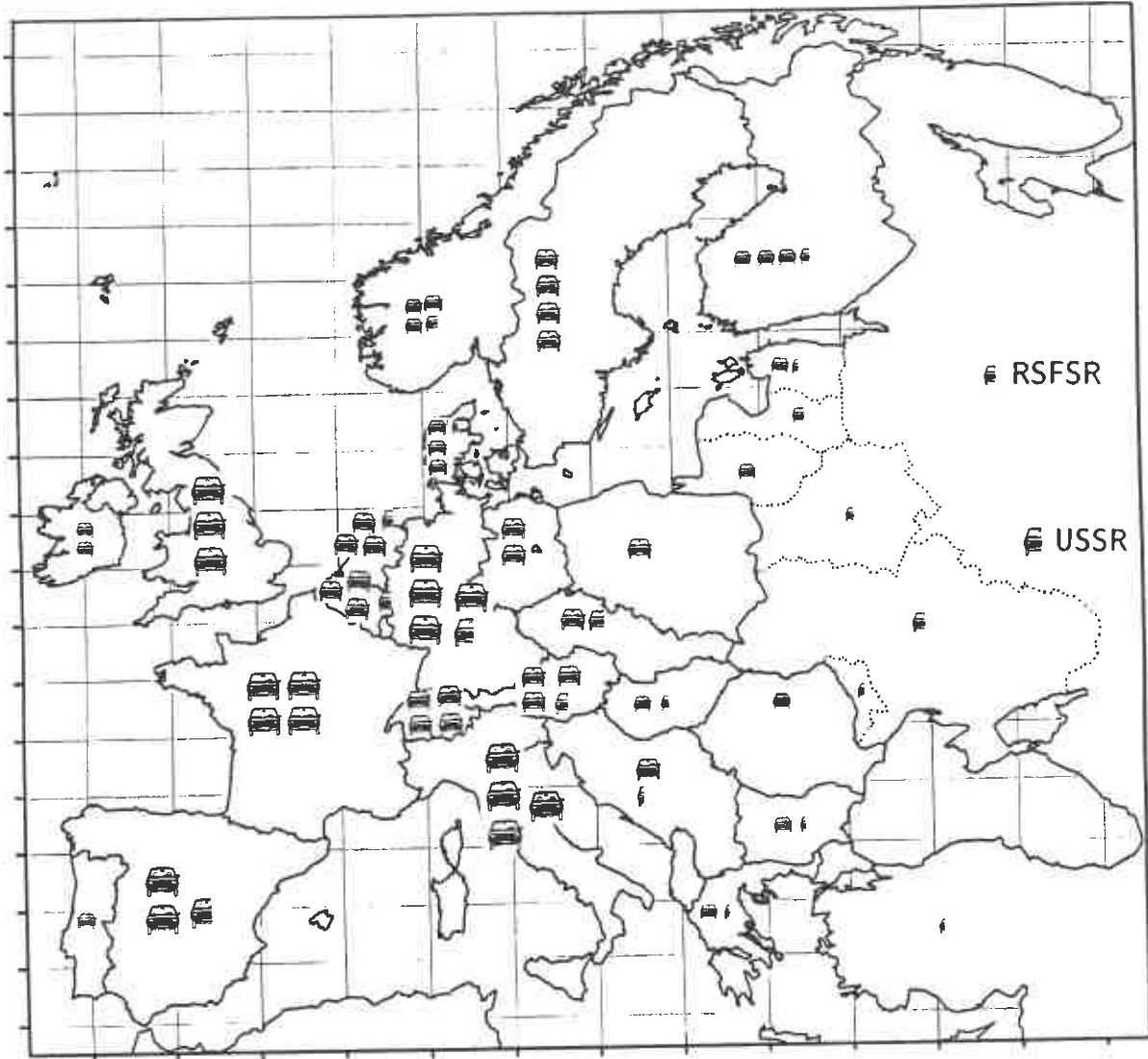

The height of the bars gives the total ton and passenger kilometers per kilometer length of road network. The width gives the total passenger and goods transport volumes subdivided into three categories. There appears to be a West-East gradient in the road transport intensity. In Eastern Europe the utilization intensity is low, and the size of the road network small, while most of the Community countries have a large, good quality road network, and therefore high infrastructure utilization. Switzerland, Austria and the Netherlands are interesting special cases: they all have relatively large road system networks compared with the land area, but utilization is quite low. In Eastern Europe the major exception is Bulgaria with a rather intense utilization of road infrastructure, but a low density and quality of roads; perhaps a function of the orientation towards truck transport with one of the largest transport companies in the world. Data for Soviet Union are unfortunately not available, but it is very likely that the utilization intensity is about the same as in the Eastern European countries, or perhaps even lower due to the relatively poor quality of roads.



ECONOMIC MAP OF EUROPE

PASSENGER CARS PER 1000 POPULATION EUROPE 1986

10⁶ cars registered in country

-  < 2
-  2-8
-  > 8

The number of passenger cars registered in each country is symbolically illustrated with each car symbol denoting 100 cars per 1,000 inhabitants. Smaller car symbols denote that the total number of car registrations is below two million, the intermediate size between two and eight million, and the large size more than eight million. The Federal Republic of Germany and Luxembourg have the highest automobile ownership with about 450 vehicles per 1,000 inhabitants. Most of the other countries in Western Europe have on average between 300 and 400 cars per 1,000 inhabitants. In comparison, the average ownership rate in Eastern Europe is about 150 vehicles per 1,000 inhabitants, and in the Soviet Union only about 50 per 1,000 inhabitants; almost ten times lower than in the Community countries. Even if car ownership in the East were doubled it would still fall far below the current Western European standard. Ownership forecasts based on road network utilization and automobile diffusion rates lead to estimates no higher than a doubling during the next decades. All this implies that the Eastern countries would continue to rely on mass transport systems, such as the bus and railroad, for further increases in mobility. In the Soviet Union, even a tripling of the current fleet of passenger cars would only bring the ownership rate up to the current average in the rest of Eastern Europe. Only Turkey has a lower car ownership rate (than the USSR) with about 25 vehicles per 1,000 inhabitants.

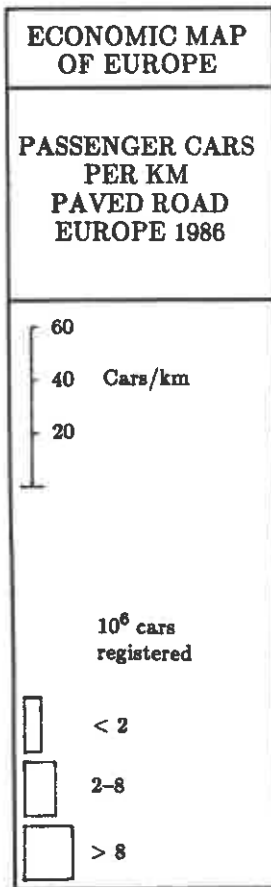
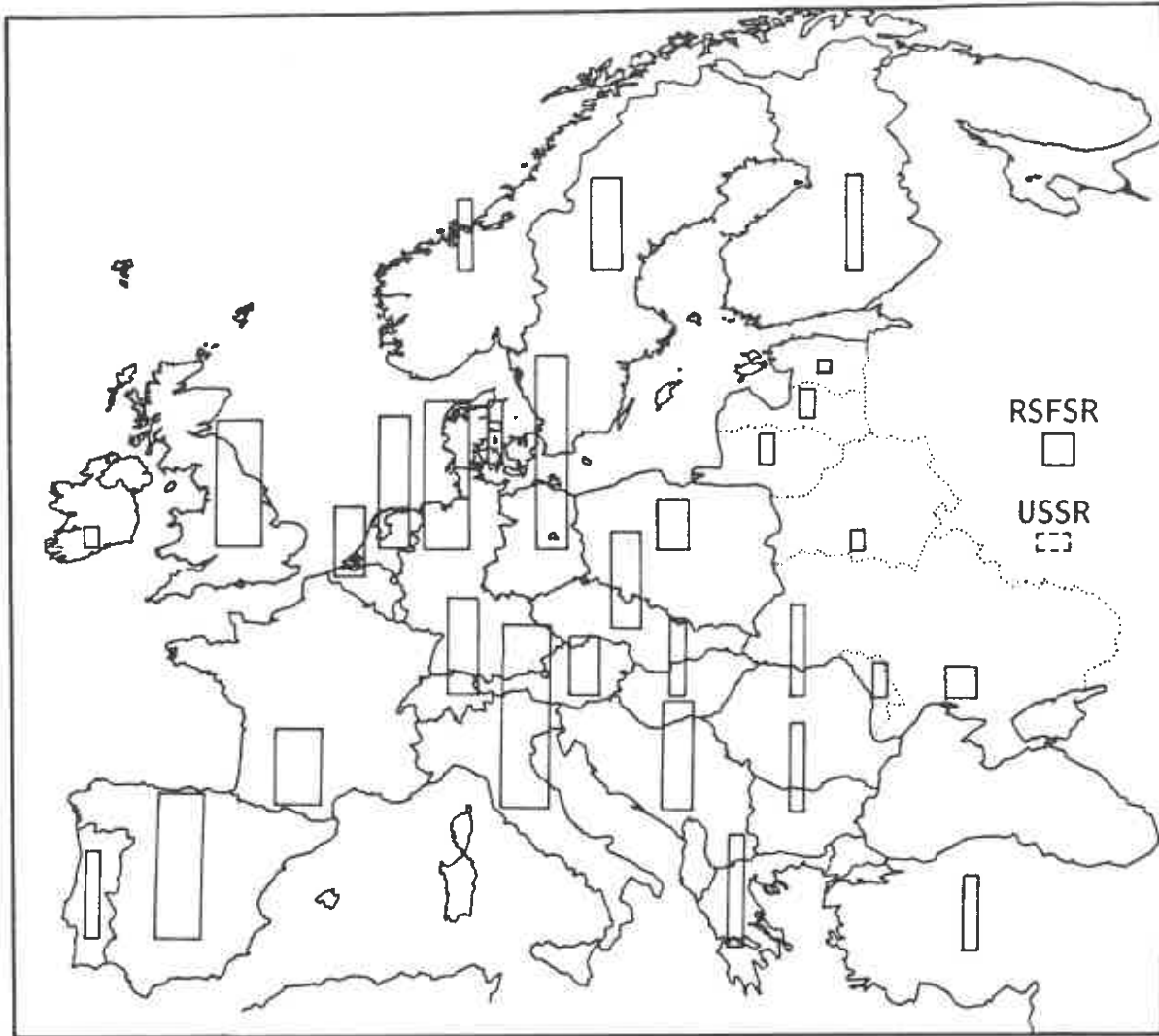

The height of the bars gives the number of passenger cars per kilometer of paved (surfaced) road, and the width the total number of registered cars subdivided into three categories. Despite the large differences in the size of the road system and levels of car ownership, the number of passenger cars per kilometer of roads is surprisingly invariant within the whole of Western Europe, with levels of about 30 to 60 cars per kilometer of paved (surfaced) road. This portrays a significant disparity when compared with Eastern Europe where both car ownership and number of vehicles per kilometer are very low, indicating the underdevelopment of individual transport. A substantial share of road passenger transport is by public bus. Ignoring the fact that the average quality of roads is not as good as in the West, there is enough room for further diffusion of automobile ownership in the East. Thus, the number of automobiles could double or even triple to reach Western densities. Any further increase would exceed the number of vehicles per kilometer infrastructure observed to be within the relatively narrow bounds for most of the Western countries. This estimate is consistent with the diffusion process of automobiles in these countries which indicates about a doubling in the level of automobile ownership during the next decades.

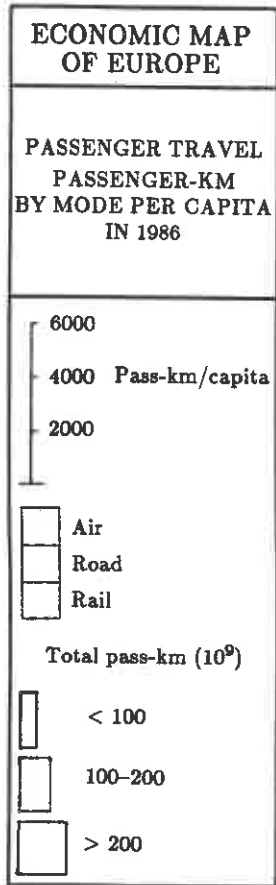
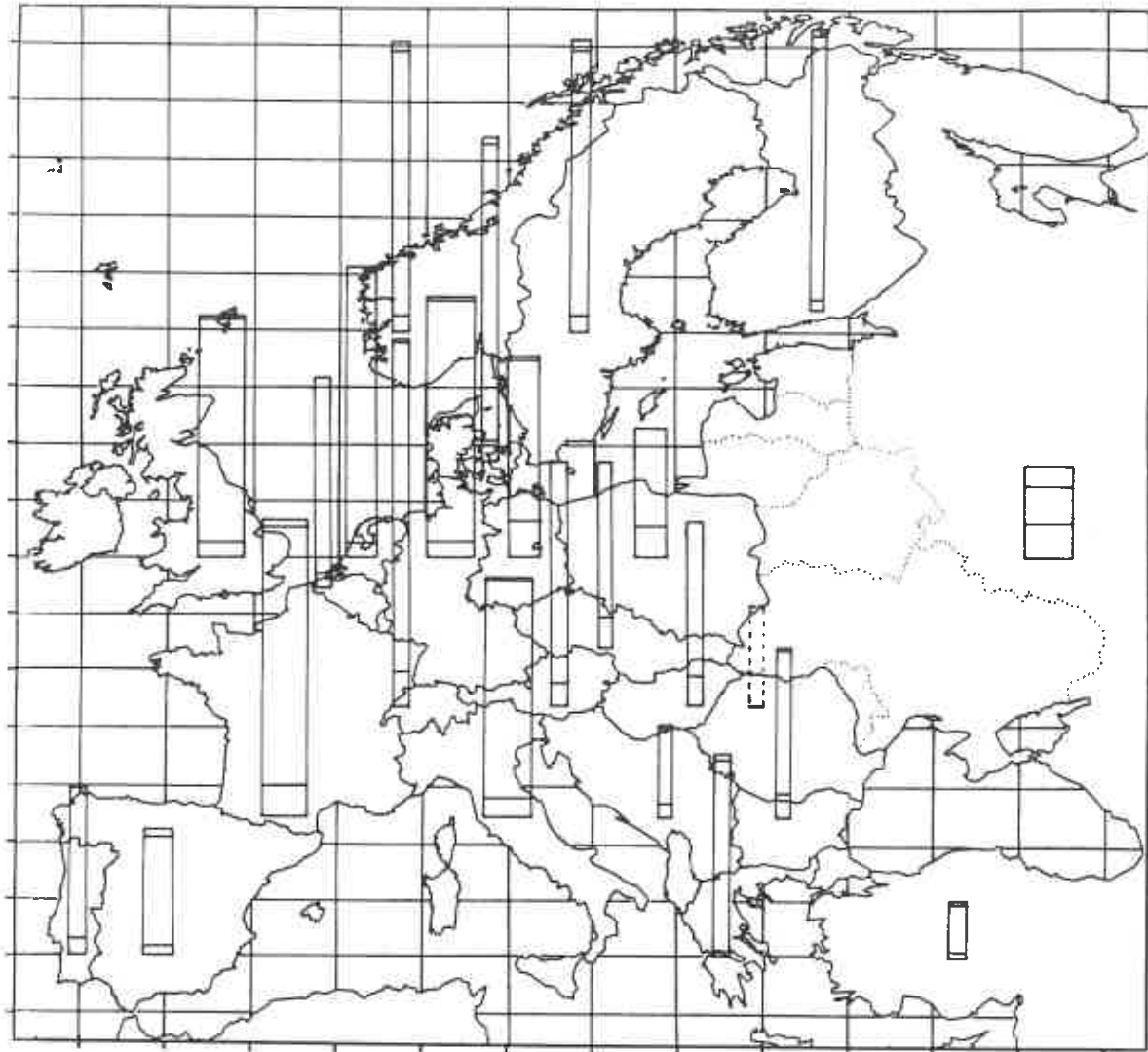

The height of the bars gives the per capita levels of passenger travel, with the subdivisions indicating the relative shares of different transport modes: air, road and rail. The width of the bars gives the absolute levels of passenger-kilometers traveled nationally, subdivided into three categories. One general feature of passenger transport in Europe is the dominance of roads with a market share of almost 90 percent in many countries. The Soviet Union portrays the most "balanced" passenger transport system with large shares of air and rail transport. Scandinavian countries, Spain and France also have relatively high shares of air and rail transport, but in contrast to the Soviet Union, roads clearly dominate. Greece is another interesting case with a relatively high share of air travel including domestic routes. There is, however, a structural difference hidden behind the dominance of road passenger travel in most countries (except the Soviet Union). While virtually all long-distance passengers travel by automobile in the Western countries, a substantial amount of passenger travel in the Eastern countries is by bus. Another difference is, of course, the level of per capita travel that portrays large variations between different countries. Mobility is very large in the Community countries and Scandinavia. With the exception of Spain and Portugal, it is higher than 6,000 passenger-kilometers per capita. This represents very high levels of mobility and is also reflected in high automobile ownership densities in these countries. Mobility is the lowest in Turkey with about 2,000 passenger-kilometers per capita and highest in Switzerland with more than 14,000 passenger-kilometers per capita.

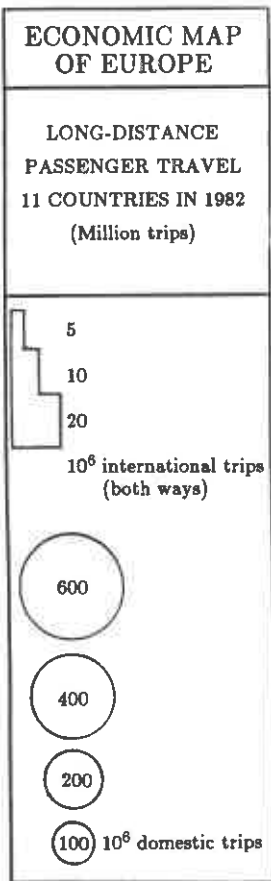
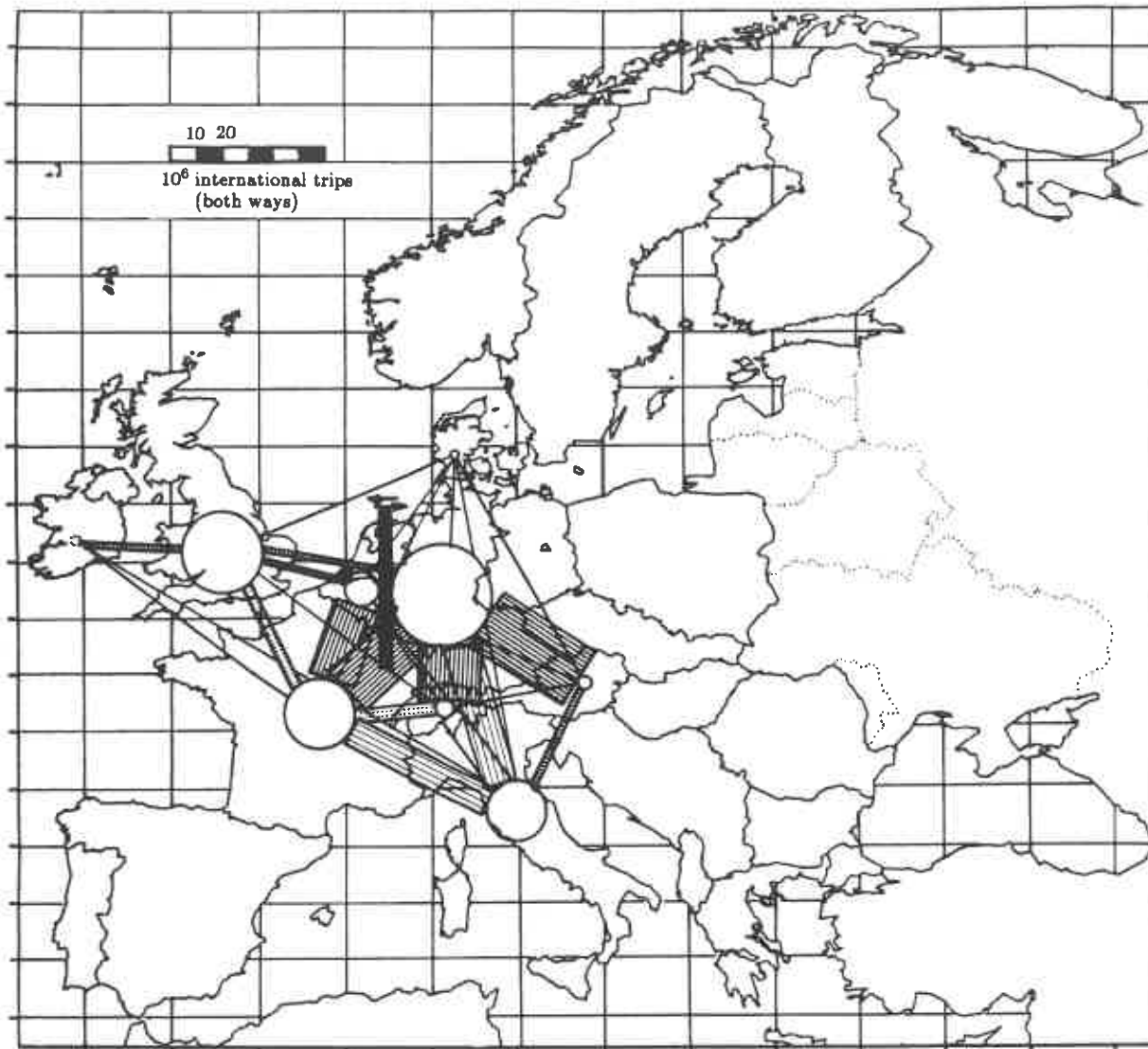

Passenger traffic within Europe is an important indicator of mobility and interaction between cities and metropolitan centres. In absence of regular statistics, country to country or city to city passenger travel data have to be estimated based on detailed spatial interaction (gravity) models, which are calibrated on basis of the most important regional source-destination flows. Such detailed models were developed within the EEC COST 33 model for base year 1982. The spatial interaction models indicate that a much larger volume of interregional traffic is associated with domestic than with international traffic. The circles symbolically represent intra-zonal traffic within a country, and the bars the interaction intensity for exchange in both directions. The diameters of the circles are proportional to the volume of domestic intra-zonal passenger traffic, and the width of the bars is proportional to the international intra-zonal passenger flows (both ways). The largest volume of intra-zonal passenger traffic forms a quadrangle around the FRG, Great Britain, France and Italy, with most of the international passenger travel between these centres. Thus, interaction is proportional to national activity levels. Major exceptions are the connections between Germany and the Benelux countries, and between Germany, Austria and Switzerland. These smaller countries are to some extent "pulled" by the gravity forces of larger countries and show also high interaction levels due to intensive economic interchanges and reduced barrier effects due to many socio-cultural similarities. High domestic mobility appears therefore to be associated with most of the international travel within Europe.

AVERAGE PASSENGER JOURNEYS PER DAY IN LONG DISTANCE TRAFFIC IN AUSTRIA (13),
(INLAND AND FOREIGN TRAFFIC (14)) ON SELECTED CROSS-SECTIONS, IN THE YEAR 1985

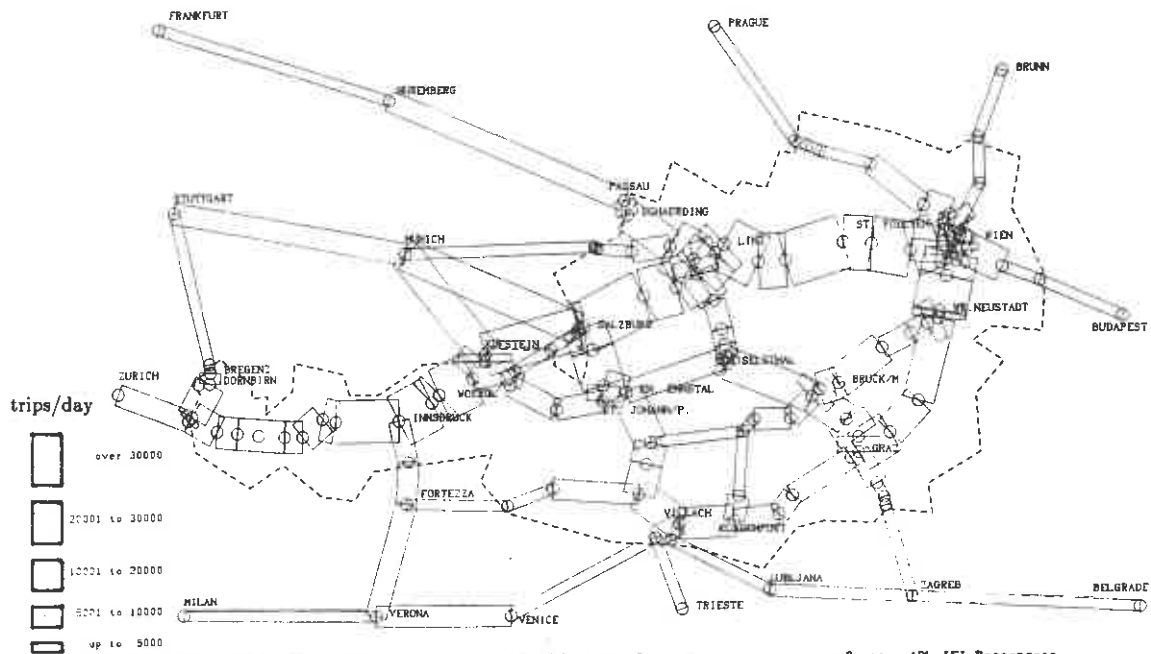

13. Distance travelled over 50 kms, without traffic to, from, and between 18 remote political constituencies of a total of 95 constituencies.
14. Traffic between Austria and Munich, Nuremberg, Stuttgart, Frankfurt, Prague, Brunn, Budapest, Zagreb, Belgrade, Trieste, Venice, Milan, Zurich, Lubiana, Verona, Forthosa, Passau including in each case the environs.

Source: ADL-IFI-Passengers
Transport Model, 1986.

ECONOMIC MAP OF EUROPE
PASSENGER TRIPS AUSTRIA IN 1985
IFIP, 1990

A detailed spatial interaction model showing the long-distance passenger trips within Austria and to/from international destinations illustrates the importance of domestic travel compared to international trips, even in case of a small country like Austria. Also visible is the strong orientation of international passenger flows with the FRG, illustrating the reduced barrier effects between two countries with intensive economic exchanges and speaking the same language. In comparison to this passenger travel to/from neighbouring Eastern European countries was relatively modest in 1985.

Passenger travel from Hungary and Czechoslovakia to Austria has increased significantly since 1985 (nearly by a factor of 8). An open question remains whether this is a local phenomenon for Austria only, as a result of the proximity of the main population centres of Budapest, Prague and Vienna and the many common cultural and historical roots between these three countries. In view of the much larger distances and also the higher barrier effects due to language differences we anticipate that similar dramatic developments as in Austria will occur only at local levels, e.g. between the GDR and the FRG (even more so if trips should become domestic travel) and between regions in geographical proximity to each other (e.g. Prague-Southern Germany). Longer distance international travel between Eastern Europe and the European core on the other hand should not increase to higher levels of interaction than prevailing presently between the Southern European Periphery (Portugal, Spain, Greece) and the core countries.

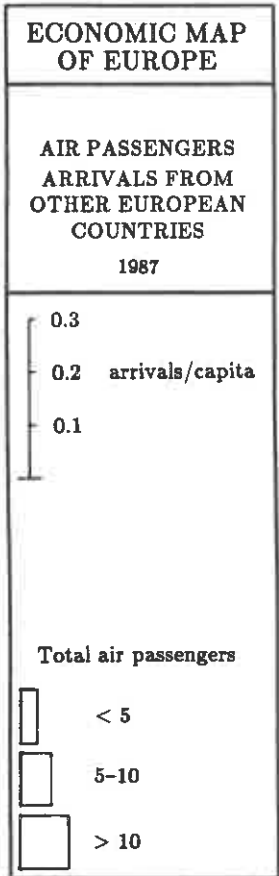
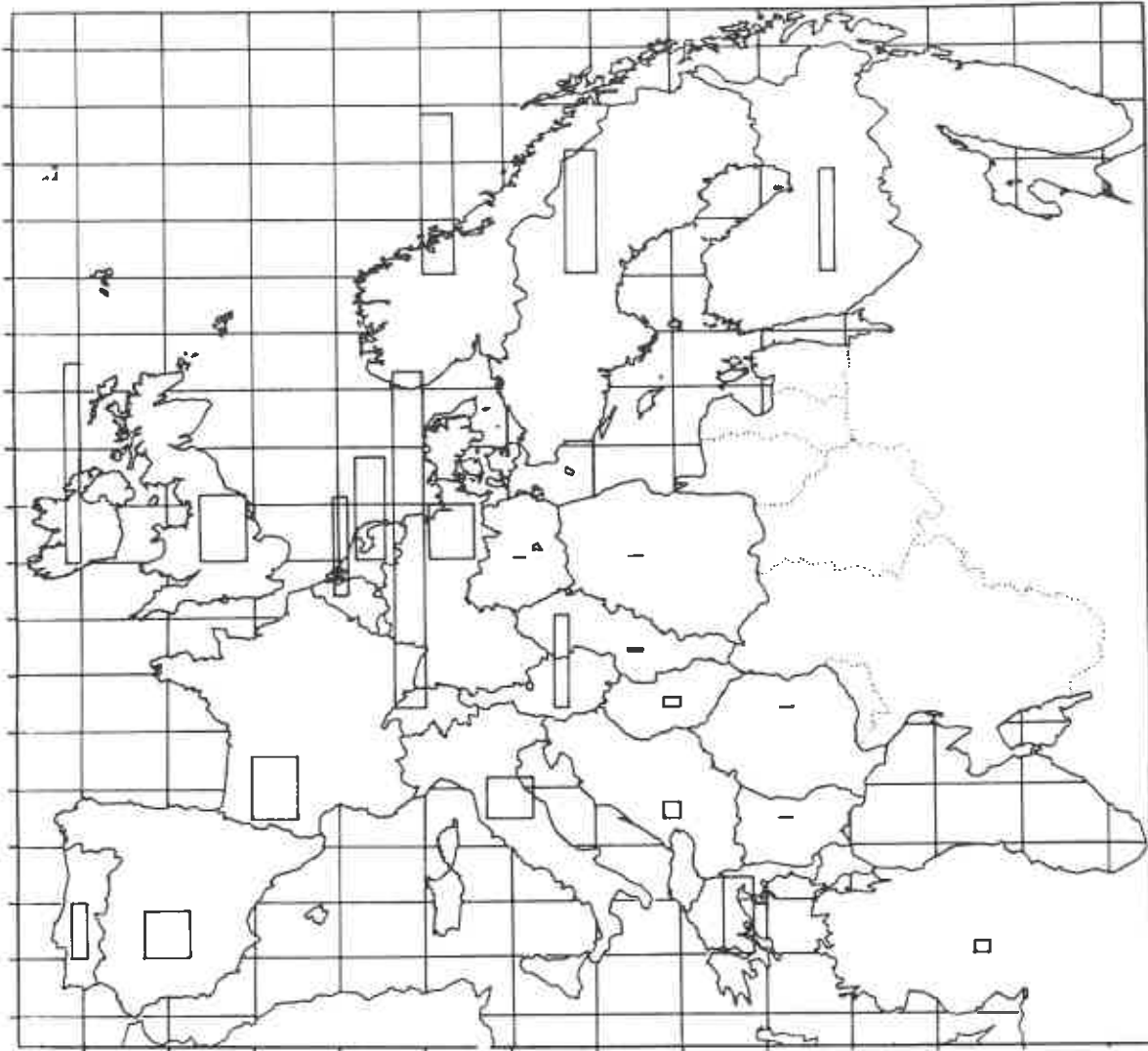

The height of the bars indicates the number of air passengers arriving in a particular country from all other European countries in per capita terms (of country of destination), and the width gives the absolute number of arrivals subdivided into three categories. This indicates the interaction between European countries in terms of the highest quality form of travel. Most business and professional interaction is conducted by air travel, and tourism and leisure travel by air within Europe is also increasing. In this respect there is a particularly strong dichotomy between East and West. Very few passengers arrive by air in Eastern countries while, for example, in Switzerland almost one passenger per inhabitant per year arrives from other European destinations by air. This indicates a very high level of air travel interaction with the rest of Europe. To an extent this is due to the hub function of Switzerland, but also indicates its central location in the middle of Europe. The relatively high level of arrivals in Scandinavian countries also indicates that they are indeed integrated with the rest of Europe. Greece also portrays a high level of arrivals from the rest of Europe, one of the few indicators that clearly shows a similar activity level as in the other Community countries. Hungary shows the highest level of interaction among the East European countries, a bit lower than that of Yugoslavia and Turkey who are the lowest in Western Europe.

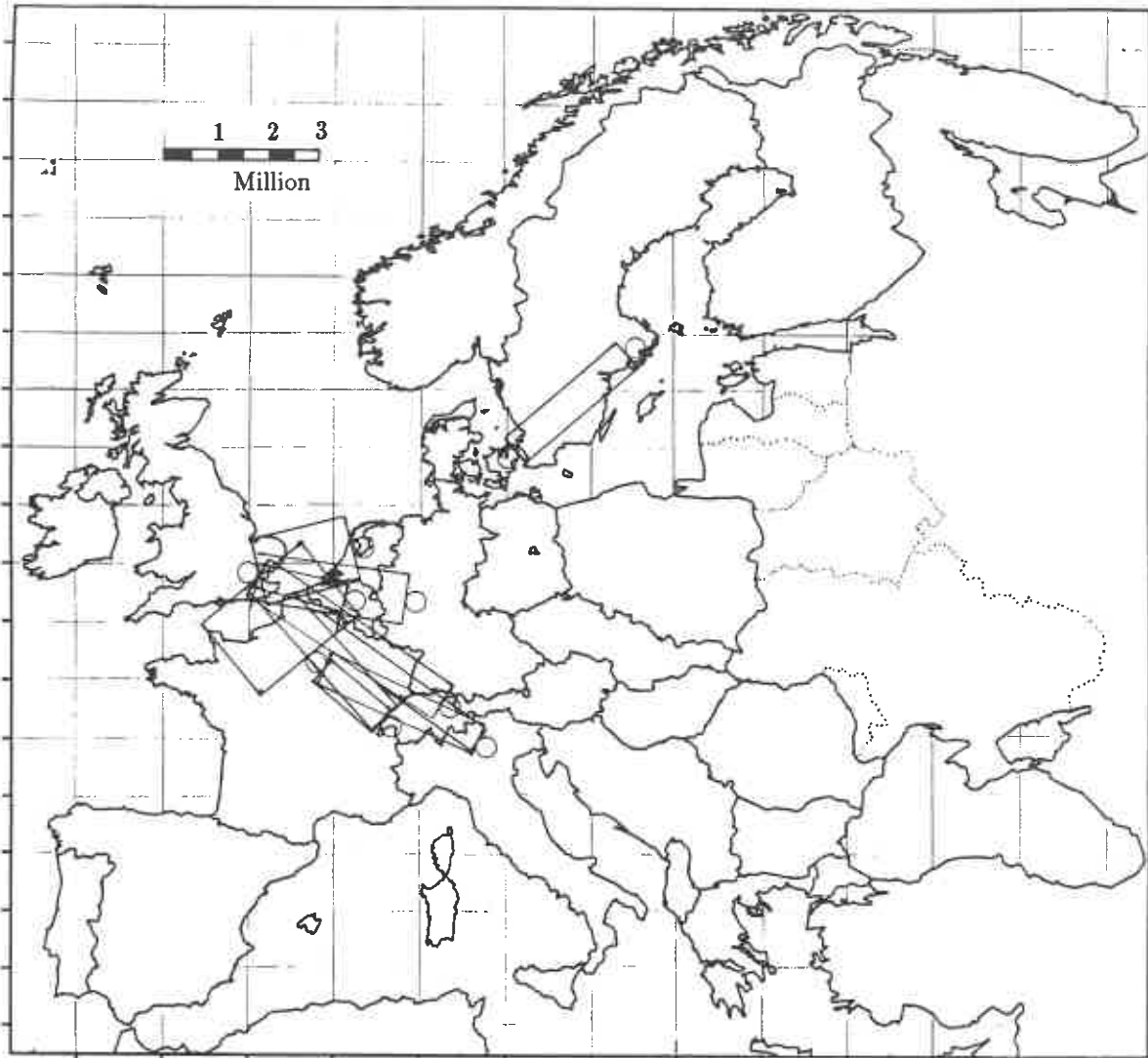

ECONOMIC MAP OF EUROPE
PASSENGERS BETWEEN AIRPORTS IN 1987
AIR PASSENGERS > 0.5 Million

In terms of intra-European scheduled air travel the largest four airports are London, Paris, Frankfurt and Amsterdam. The circles symbolically represent individual airports, and the width of the bars the interaction intensity for exchange in both directions. The absolute largest flow of passengers is between London and Paris, followed by the London and Amsterdam link. Most of the traffic is between the narrow corridor of air-space between England, the Benelux countries, Germany, Switzerland, Italy and France. Another important connection is between Copenhagen and Stockholm. This cluster of intense traffic links within central Europe represents passenger flows in excess of half a million per connection. The first overlay illustrates the second hierarchy of interaction between European airports with passenger flows larger than quarter of a million but smaller than half a million. It shows the strong interaction between the European community countries and Scandinavia, Switzerland and Austria. This clearly illustrates the apparent dichotomy in intra-European passenger travel. There is not a single East European city at the second hierarchical level. The second overlay gives the traffic flows to and from East European airports: all connections have less than 100,000 passengers (mostly to London and Frankfurt). Considering the fact that most of the scheduled air traffic in Europe is business travel (mostly node-to-node one-day trips), this structure also illustrates that commercial interactions between the Community countries are at least an order of magnitude larger than the interactions with the Eastern countries.

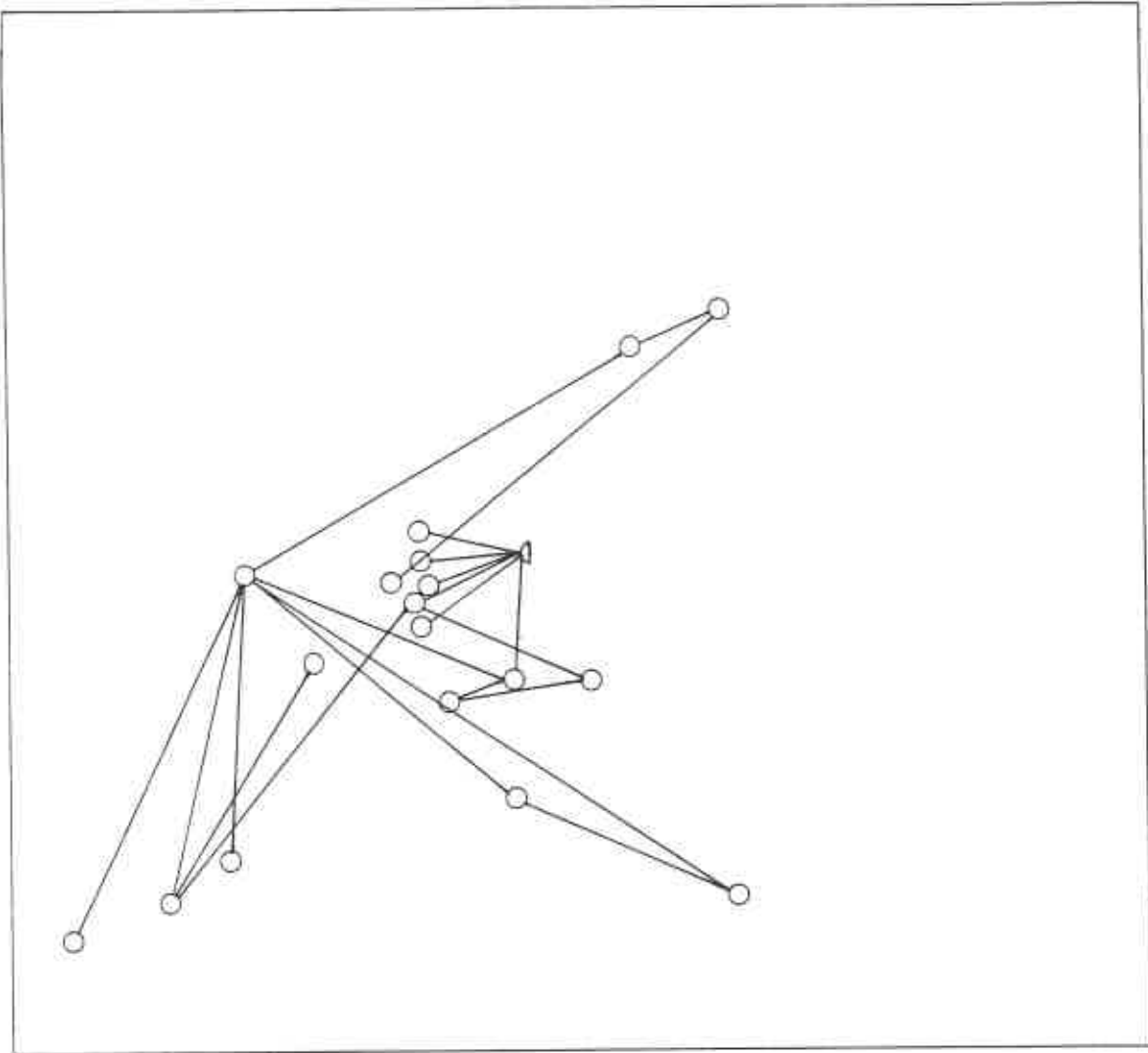

AIR PASSENGERS
OTHER WEST
< 0.50 Million
> 0.25 Million

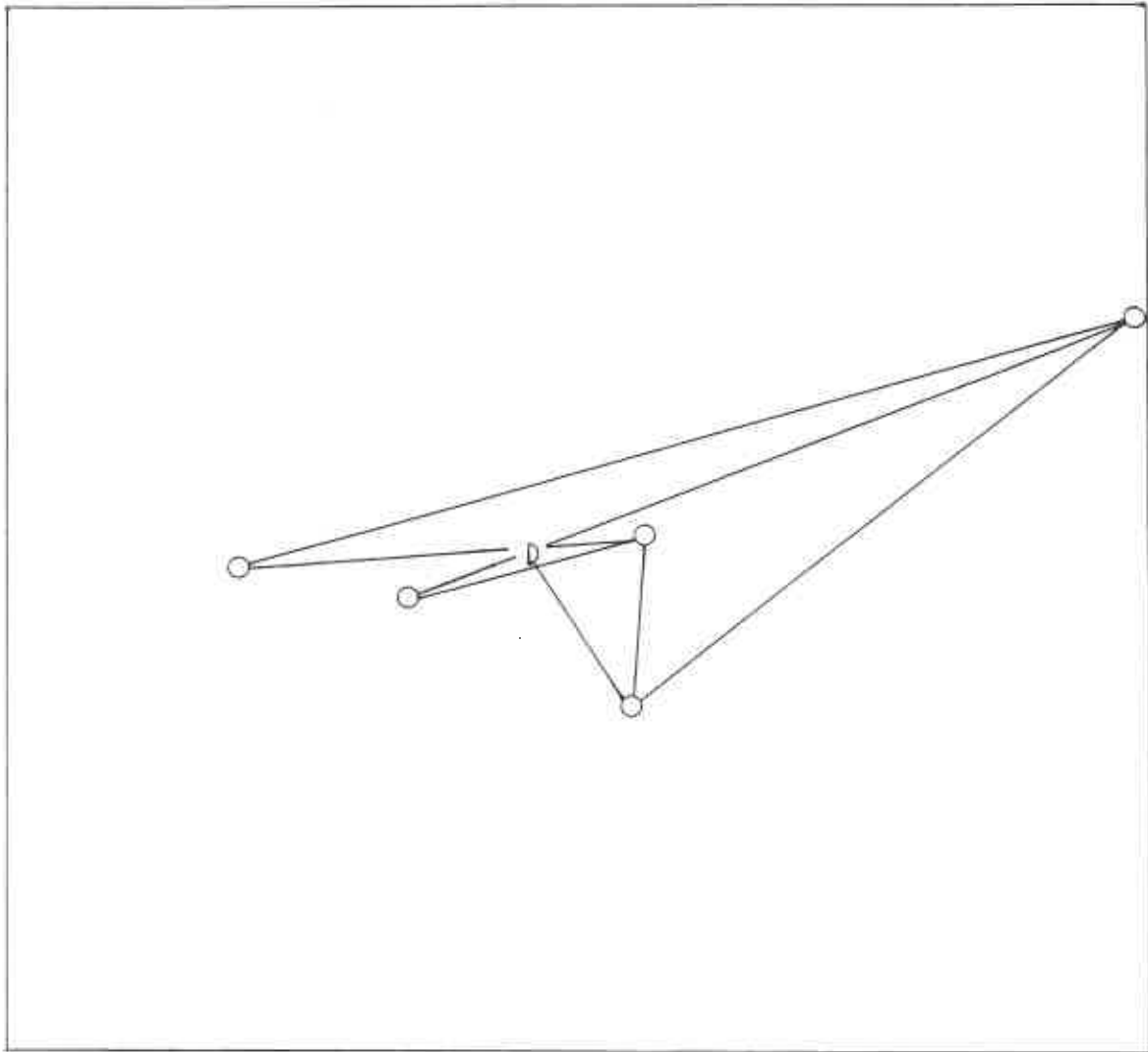

AIR PASSENGERS
EAST
>0.10 Million

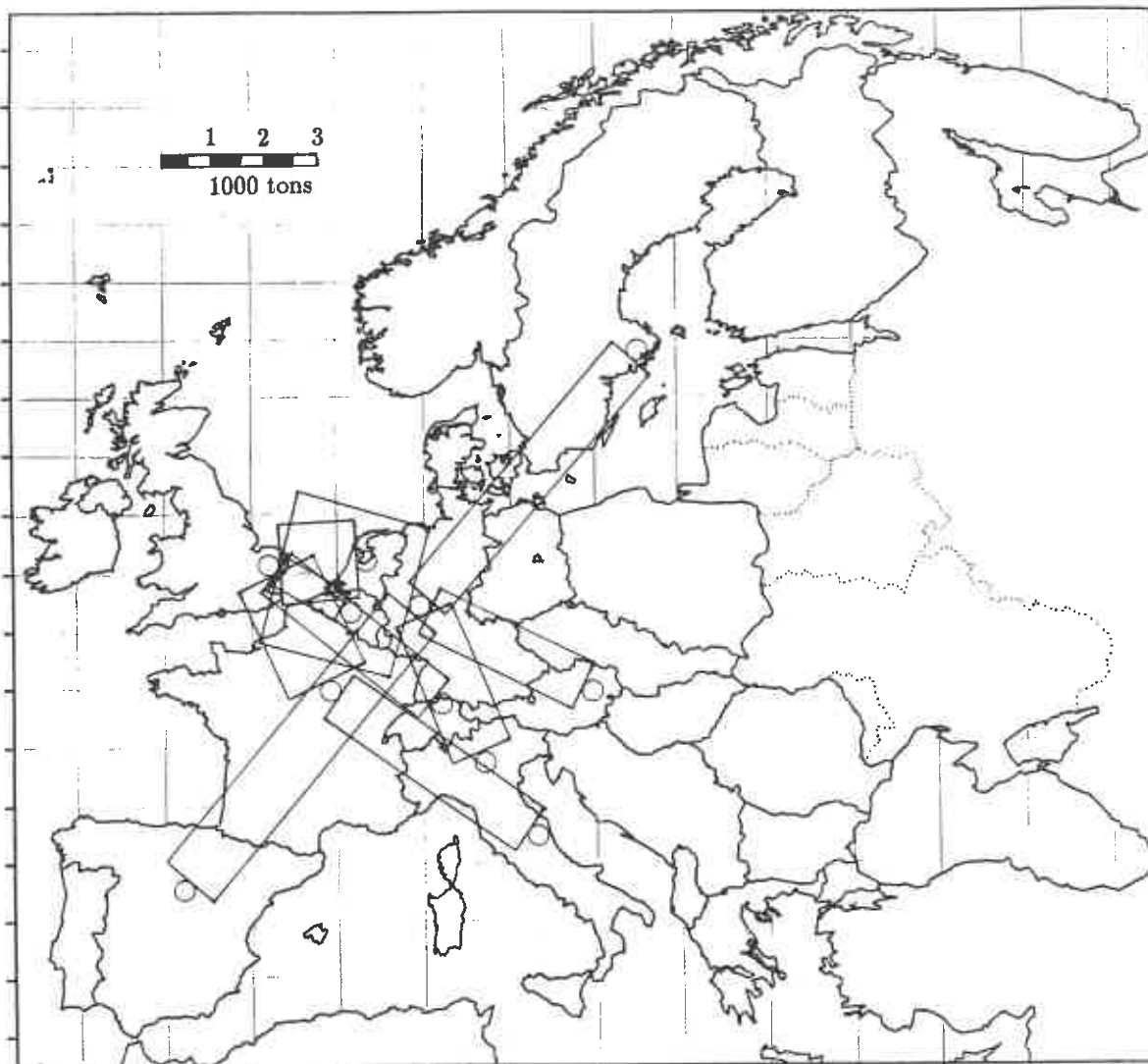

**ECONOMIC MAP
OF EUROPE**

**FREIGHT
BETWEEN AIRPORTS
IN 1987**

Interaction between European countries, in terms of goods transport by airways, is illustrated for only the most intensive flows. The circles symbolically represent individual airports, and the width of the bars the interaction intensity for exchange in both directions. Air freight is by about a factor thousand lower than the equivalent exchange of goods by other transport modes, representing no more than a few tenths of a percent of all goods flows between countries within Europe. Such a measure however underestimates the importance of air freight for the most valuable goods. There is a certain congruence between the patterns of intra-European air freight densities and those of truck transport (and goods transport in general). The most intense exchange is between London and Frankfurt, followed by the London and Paris link. London and Frankfurt are no doubt the strongest two nodes in Europe. Most of the exchange is between the Community countries with three intense links to Sweden, Switzerland and Austria. In comparison, the interaction with Eastern Europe is very small, indicating a weak exchange of high value-density goods.

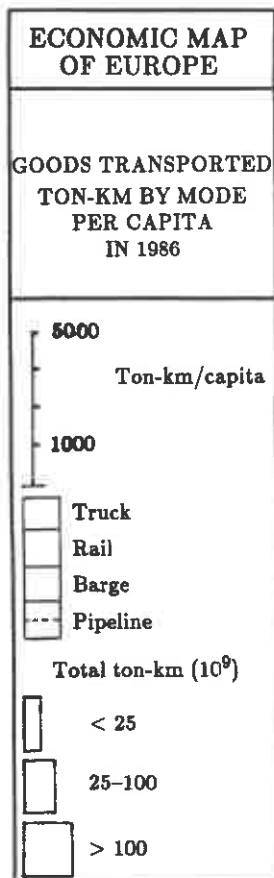
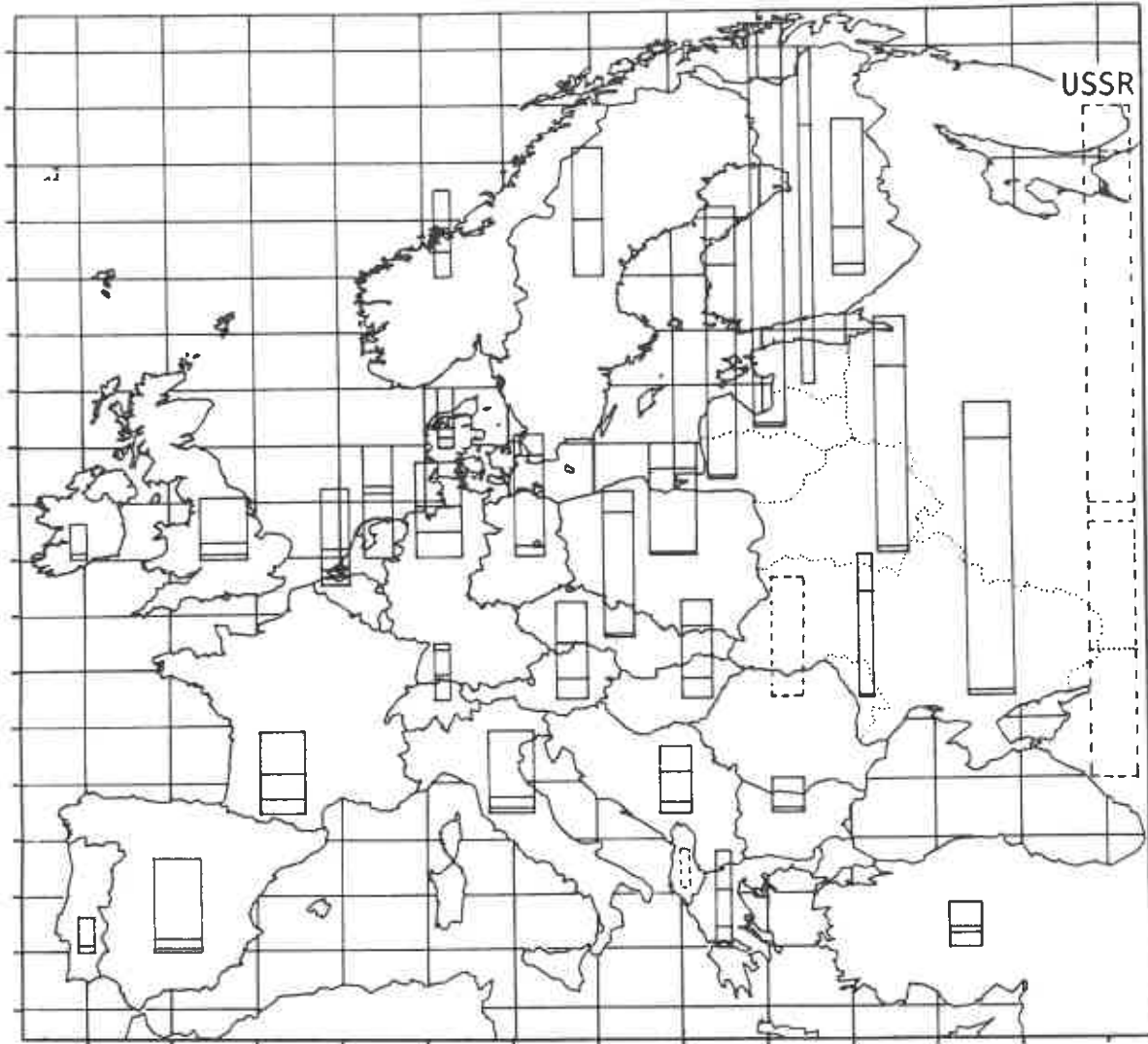

The height of the bars gives the per capita level of goods transport with the subdivisions indicating the relative shares of different transport modes: truck, rail, barge and pipeline. The width of the bars gives the absolute levels of goods transport operations subdivided into three categories. The absolute and per capita level of ton-km transported in Eastern Europe is substantially higher than in the rest of Europe. The highest levels can be observed in the USSR and are at least in part due to the vastness of the country. Transport densities are higher in the East European countries with high population densities such as the German Democratic Republic, Czechoslovakia and Hungary. The difference in per capita goods tonnage transported is less pronounced, but Eastern Europe and the USSR still show generally higher intensities than the rest of Europe. The volume of goods transport in Eastern countries is particularly large in relation to the value added, illustrating their material intensiveness. The high transport level of bulk, low value goods and commodities, such as primary materials and intermediate products, is reflected in the high share of railways in the goods transport system structure. This is in perfect symmetry to the large share of coal in the primary energy balance of these countries. In fact, most of the railway operations are dedicated to coal transport. Modern, service-oriented economies with the high-value goods and just-in-time deliveries associated with material disintensification, portray a much higher share of road transport. In general, countries with vast land areas require larger transport services. For example, energy is now the most important commodity carried in the Soviet Union accounting for about 35 percent of all ton-kilometers.

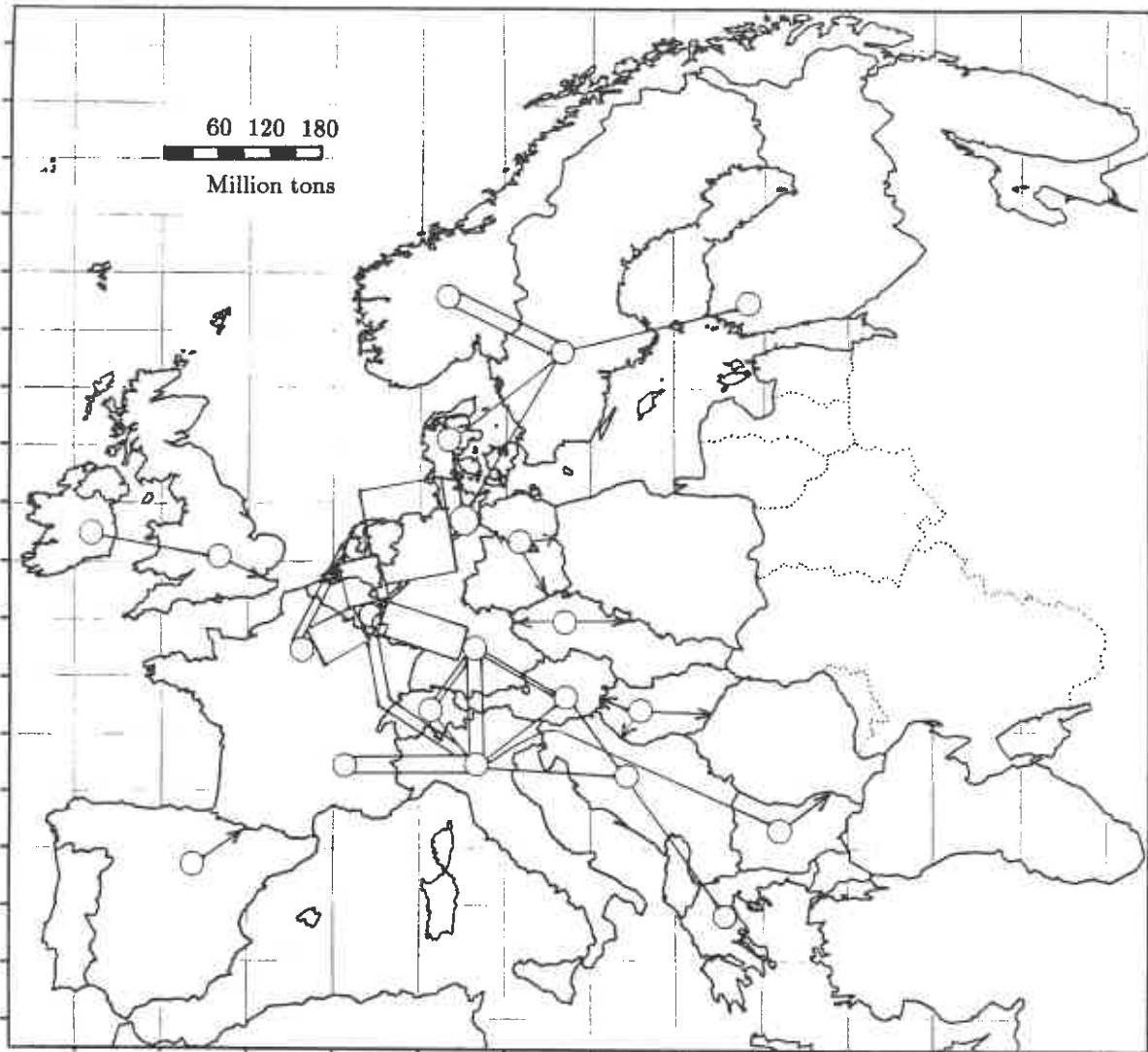

ECONOMIC MAP OF EUROPE

TOTAL GOODS
TRANSPORTED
BETWEEN
COUNTRIES
1986

European interaction in terms of total goods transported between countries is illustrated only for the most intensive flows. The circles symbolically represent individual countries, and the width of the bars the interaction intensity for exchange in both directions. By far the strongest intensity of international goods transport is between the Federal Republic of Germany and the Benelux countries. Further intensive routes are along the triangle that includes North Italy and France. There is also an isolated intense exchange between Sweden and Norway, mostly by rail. All of the other intense international goods flows are by truck. There is a relatively intense goods exchange between France and surrounding countries, but most of it is due to the large volumes of road transport along the same links. The international goods transport to and from East European countries is small in comparison to the interaction between the Community of six (EUR 6). The Iberian peninsula, along with other Southern countries, is also decoupled from the major flows. It is interesting to note that the most intense international interchange of goods is not correlated with the intensity of per capita goods transport in the individual countries. If anything, countries with relatively high levels of per capita goods do not participate very actively in international exchange, but apparently transport a lot of bulky and low value-density goods within the country borders.

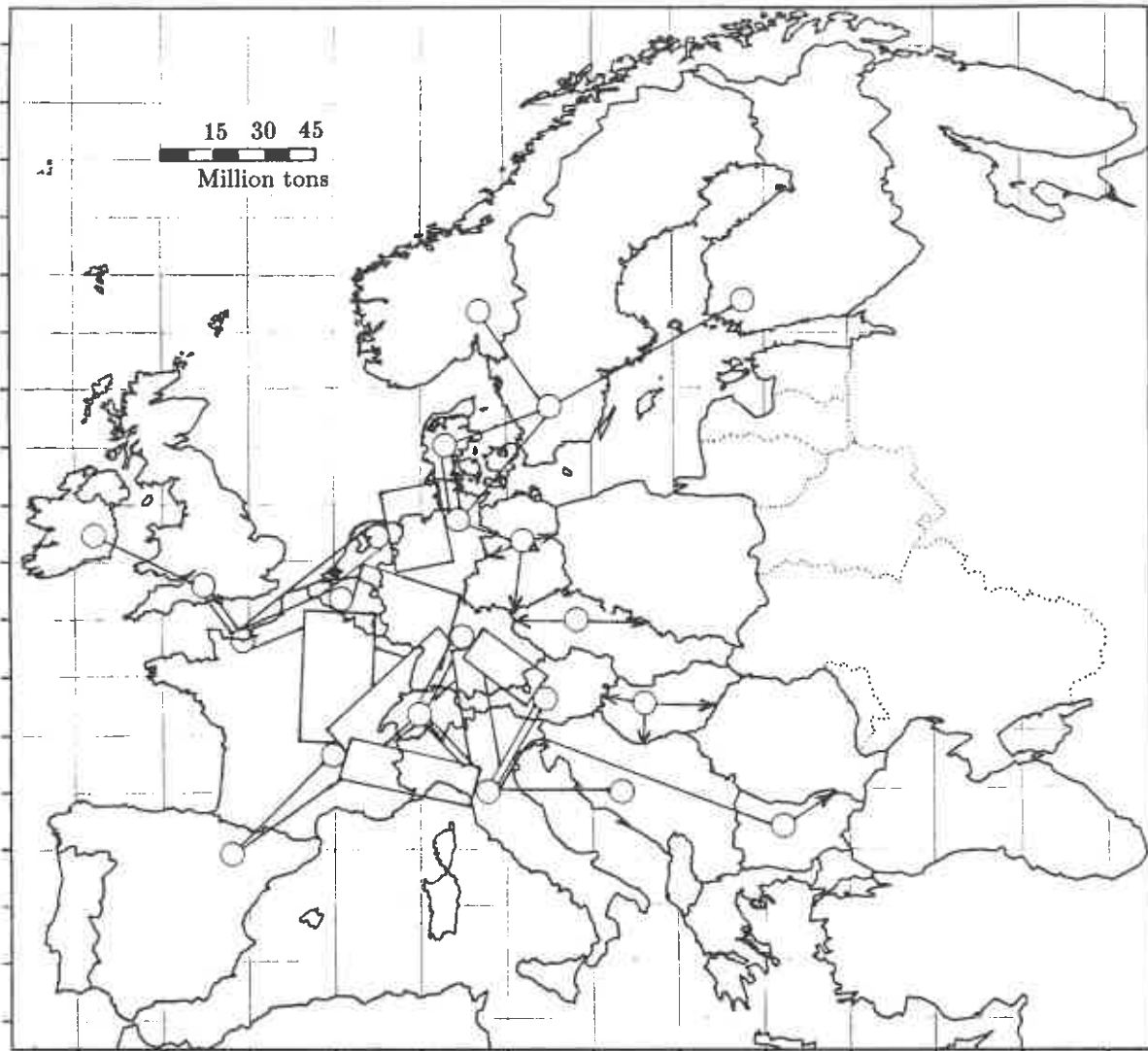

**ECONOMIC MAP
OF EUROPE**

**GOODS
BY ROAD
BETWEEN
COUNTRIES**

1986

European interaction between countries, in terms of goods transport by road, is illustrated for only the most intensive flows. The circles symbolically represent individual countries, and the width of the bars the interaction intensity for exchange in both directions. By far the strongest intensity of international road transport is between France, the Benelux countries, Germany, Italy, Austria and Switzerland. There are also strong links from this network to Great Britain and Denmark. In general, the international goods exchange by truck is even more polycentric in Europe than by railways. In addition to the intense interaction with the rest of Scandinavia and the Iberian peninsula, there is also a direct interaction with most of the East European countries. Thus, while most of the goods travel by rail within the Eastern countries, it is quite apparent that most of their trade with the Western countries is by road. Thus, it can be expected that further intensification in East-West trade would also use the truck as the preferred transport mode. The poor quality of East European roads is apparently lesser of an obstacle than the service offered by railroads.

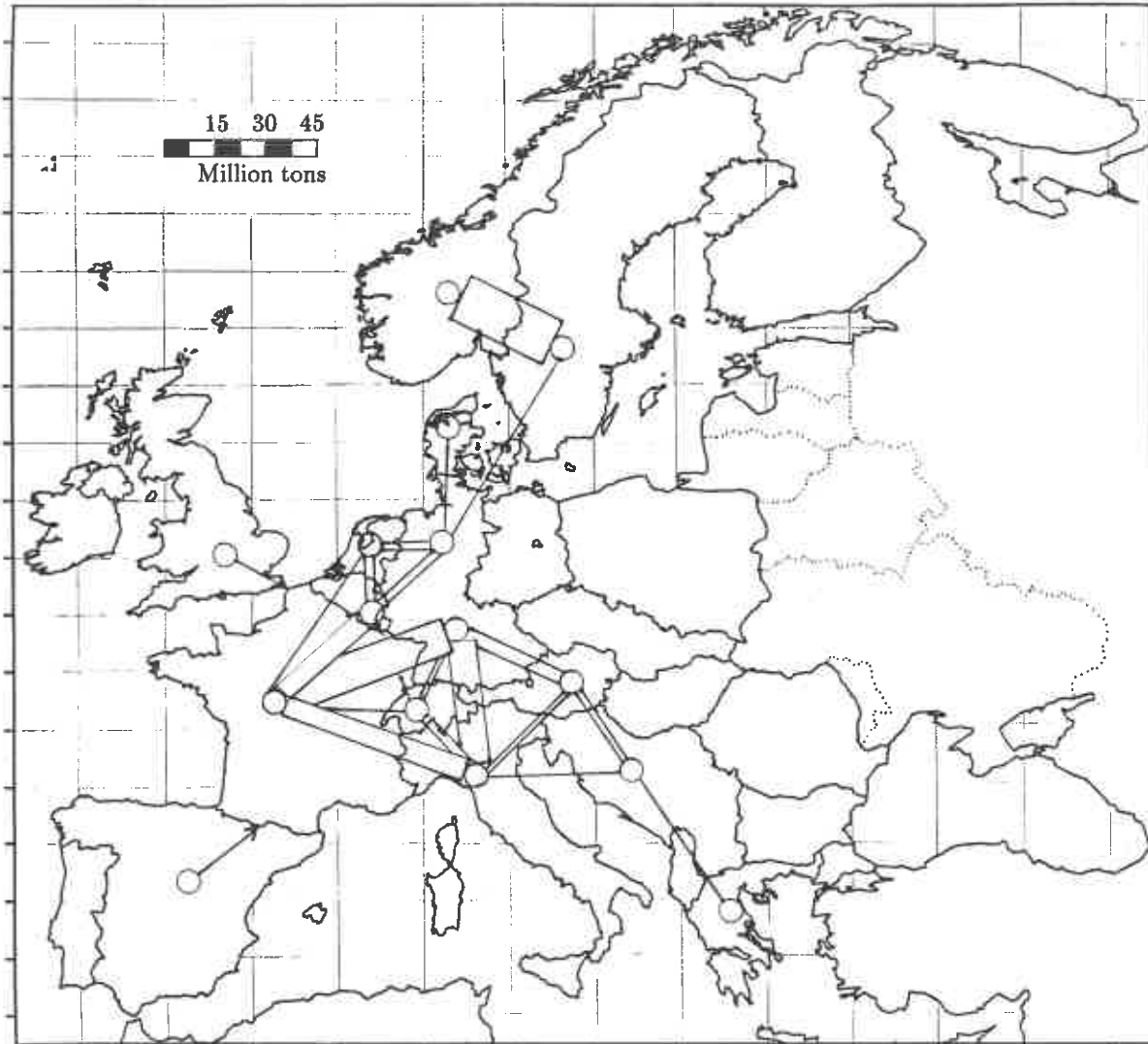

**ECONOMIC MAP
OF EUROPE**

**GOODS
BY RAIL
BETWEEN
COUNTRIES**

1986

European interaction between countries, in terms of goods transport by railways, is illustrated for only the most intensive flows. The circles symbolically represent individual countries and the width of the bars the interaction intensity of exchange in both directions. By far the strongest international rail transport intensity is between France and its neighbouring countries to the East. The most intense single exchange is, however, between Sweden and Norway. In general, the international goods exchange by railways is quite polycentric in Europe. Most of the interaction is centred around France, the Benelux countries, Germany, Italy, Austria and Switzerland, with extended "channels" toward Scandinavia in the North and to Greece in the South. In comparison, Great Britain and the Iberian peninsula constitute weaker links. Despite a relatively high intensity of railway goods transport in the Soviet Union and Eastern Europe, it is apparent that their international trade is very small by Western standards. Although the trade statistics by transport mode are very sparse for East European countries, in comparison to the Western trade volumes, the exchange is quite small. Consequently, they are still decoupled even in terms of the low value-density and bulky goods that by-and-large travel by trains.

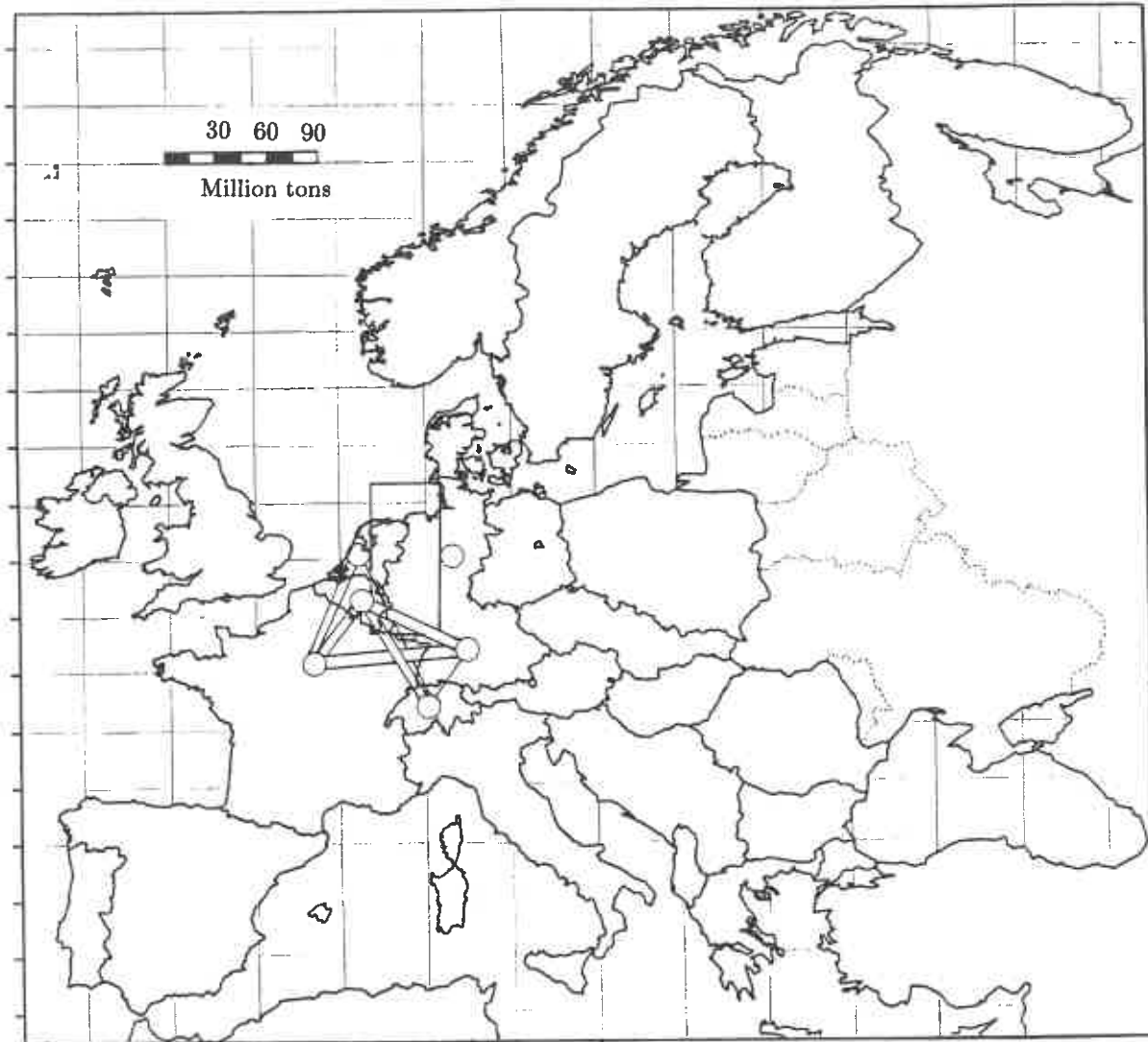

**ECONOMIC MAP
OF EUROPE**

**GOODS
BY RIVER
AND CANALS
BETWEEN
COUNTRIES
1986**

European interaction between countries, in terms of goods transport by rivers and canals, is illustrated for only the most intensive flows. The circles symbolically represent individual countries, and the width of the bars the interaction intensity for exchange in both directions. By far the strongest intensity of international river and canal transport is between the Federal Republic of Germany and the Netherlands. In fact, this very large volume of goods exchange by rivers and canals is a dominant share in the total flux of goods and commodities between the two countries. Further intensive routes are along the triangle that also includes Belgium, in addition to the Federal Republic of Germany and the Netherlands. The exchange of goods by waterway is very large in terms of tonnage transported, but represents only a small fraction of the total value of international goods exchange. It is interesting to note that the intense international goods transport by waterways follows the same routes as the other intensely utilized modes. Both rail and road goods transport is very intensive among the same set of countries.

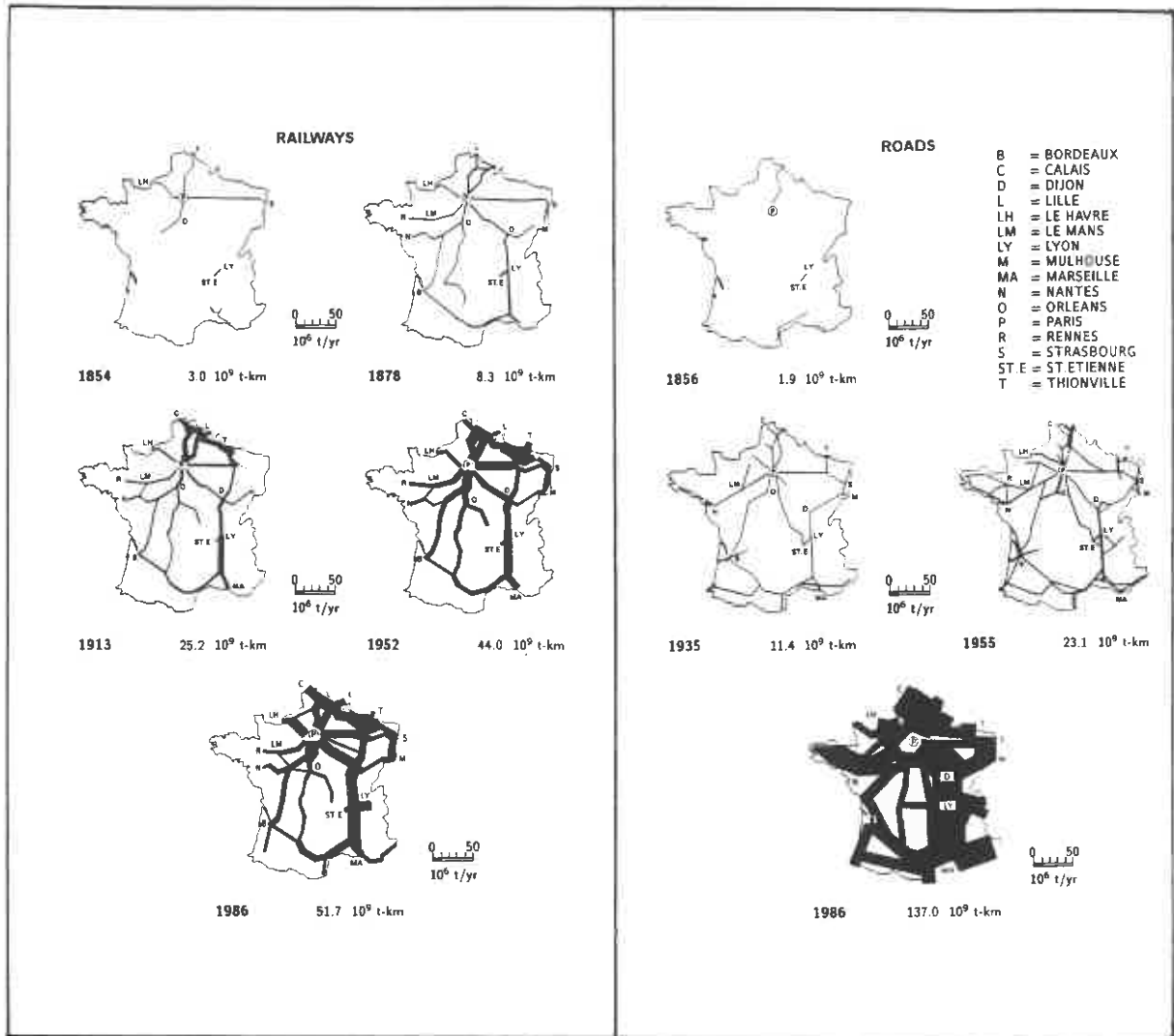

ECONOMIC MAP OF EUROPE

INFRASTRUCTURE USE (RAILWAYS AND ROADS)
FRANCE 1856-1986
(Million tons/year)

The figure shows the *intensification* in the usage of different transport infrastructures, railways and roads, based on the annual tonnage throughput at various segments of the infrastructure network. The data have been replotted on a common scale, i.e., the thickness of the lines is proportional to the tonnage transported. Also shown is the total national goods traffic flux in 10⁹ ton-km for the railway and road network for the given base years.

There are two phases of railway growth. The first one being characterized primarily by an extension of the network (between 1854 and 1878) connecting the main gravity centres of the country, whereas the second phase is characterized by an increasing intensification of the use of the existing railway network. The dominance of railways in the goods transport sector from the 1850s to the 1950s becomes particularly visible in the comparison to the throughput (tonnage transported) on roads. Since 1950 however, the throughput at various segments of the road infrastructure has increased dramatically: on average by a factor of 6 (in terms of ton-km) illustrating the shift in the preferred mode of goods transport from railways to roads.

The intensification of infrastructure use along various corridors implies that by and large infrastructures have emerged where an interaction potential existed. Economic growth goes along with increasing interchanges between "gravity centres" with a corresponding intensification of traffic flows in between.

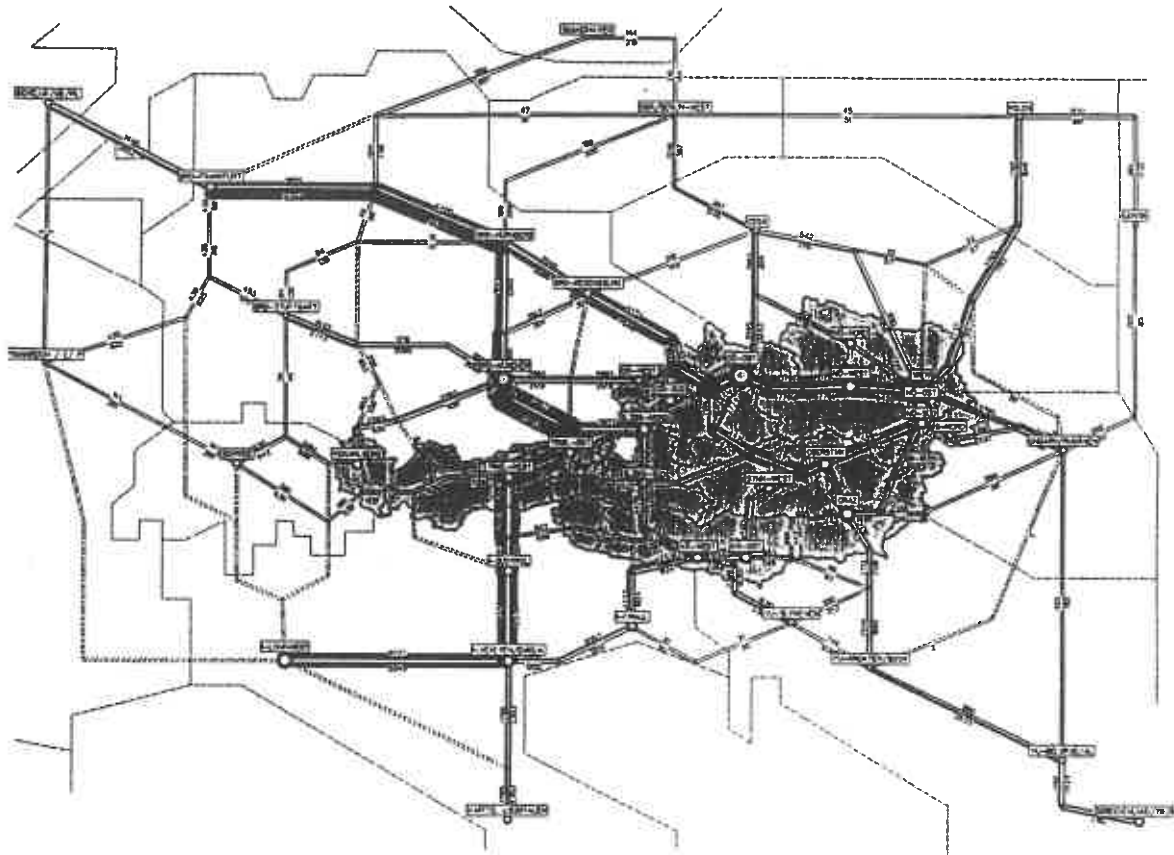

ECONOMIC MAP OF EUROPE

GOODS TRANSPORT IN & FROM/TO AUSTRIA INCLUDING TRANSIT IN 1984 AND 2000
(Million tons)

GUETER-VERKEHRS-STROEME

OESTERREICH :
Quell-,Ziel-,U.
Transitverkehr

GESAMT-
VERKEHR
1984
(i.1000 to)

Streckenbelastung
3000 Fahrten = 1 mm



Fahrten in die Verkehrszone
300 Fahrten = 1 mm²



The graphic shows the source, destination and transit flows of goods within Austria as well as between Austria and Europe, including transit flows via Austria. Thickness of flows is proportional to tonnage transported over various segments of the transport infrastructure network. Note that both road and rail traffic (but not inland waterway traffic) is plotted in the graphic.

Considering the importance of Austria as a transit country for traffic flows between the European Core and Southern and Eastern Europe it is noteworthy to realize the low density of goods exchanged between the Southern and Eastern periphery and the core. Compared to domestic traffic flows, e.g. from Vienna to Linz and especially the density of trans-Alpine goods traffic, the flows from Eastern European countries are modest. The densest goods traffic from Eastern Europe to Austria is from Poland, consisting mostly of coal, imported by railway for electricity generation plants built under the wake of the "oil crisis". Also noticeable is the dominance of goods flows between Austria and Germany (recall here that about 40 percent of all imports/exports of Austria are with the FRG) and the high transit traffic between the FRG and Italy.

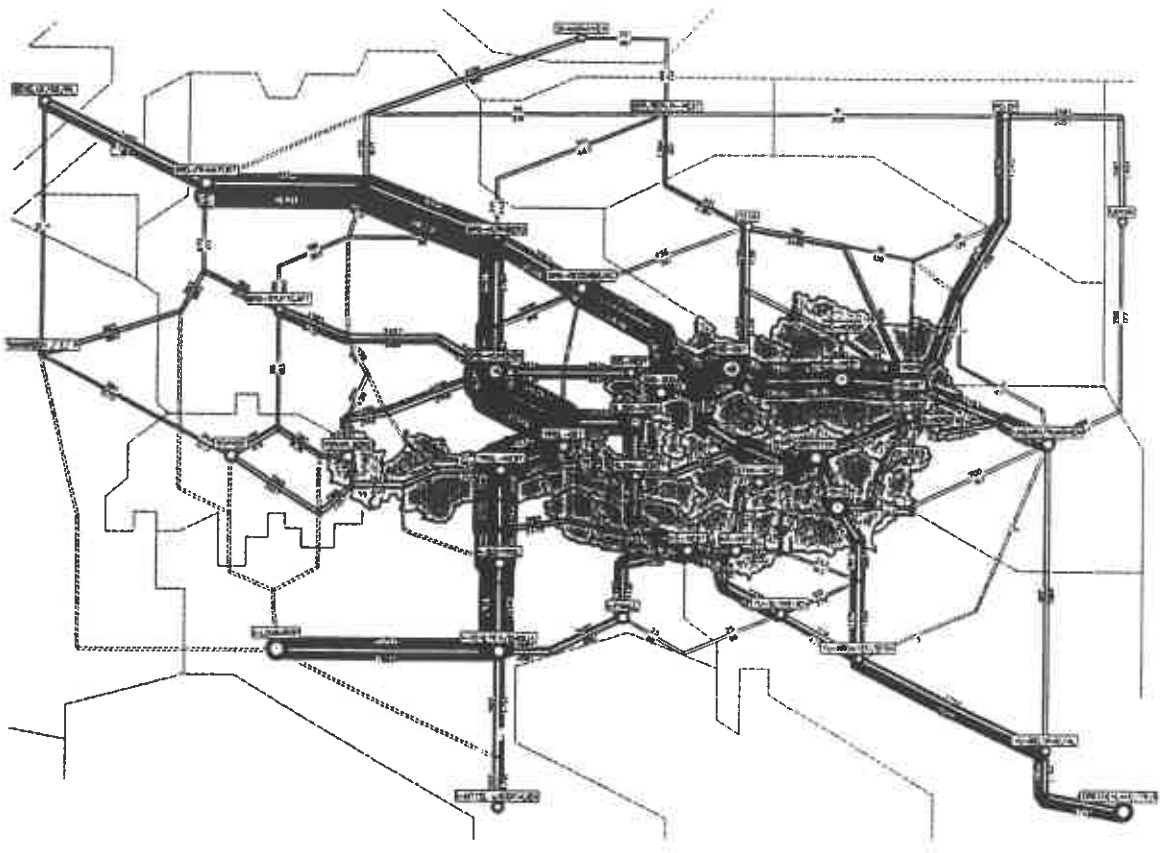

ECONOMIC MAP OF EUROPE

GOODS TRANSPORT IN & FROM/TO AUSTRIA INCLUDING TRANSIT IN 1984 AND 2000
(Million tons)

QUETER-VERKEHRS-STRÖME

ÖSTERREICH :
Quell-,Ziel- u.
Transitverkehr

GESAMT-
VERKEHR
2000
(t.1000 to)

Streckenbelastung
3000 Fahrten = 1 mm

Fahrten in der Verkehrszone
300 Fahrten = 1 mm

A forecast of goods traffic flows for the year 2000 assuming a progressive opening of the economies of Eastern Europe and a resulting significant increase in their traffic flows to and from the European core shows the intensification in the use of transport corridors. What is perhaps surprising is that the simulation model underlying the forecast for the year 2000 perpetuates the present disparities in the goods traffic with and within the European core and the comparatively low density of economic integration and resulting goods traffic of Eastern Europe. This illustrates that even in optimistic scenarios of the opening of Eastern European economies the growth rates in their degree of economic interaction are not larger than the growth rates anticipated within Western Europe proper, especially after 1992. Thus, whilst significant growth of goods traffic from/to Eastern Europe in relative (percentage) terms is to be expected, the growth in absolute amounts will remain modest compared to the increase in traffic volumes under a deepening of the economic integration of the European core.

7A

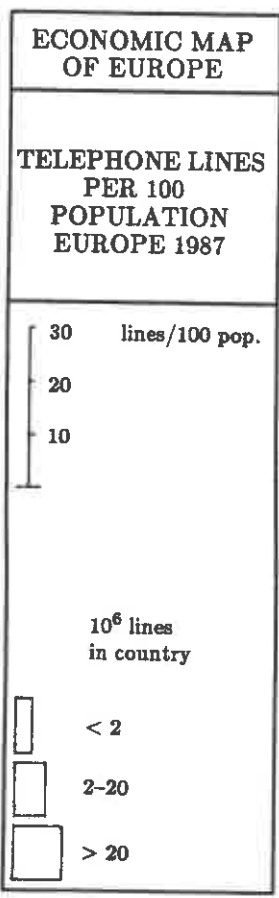
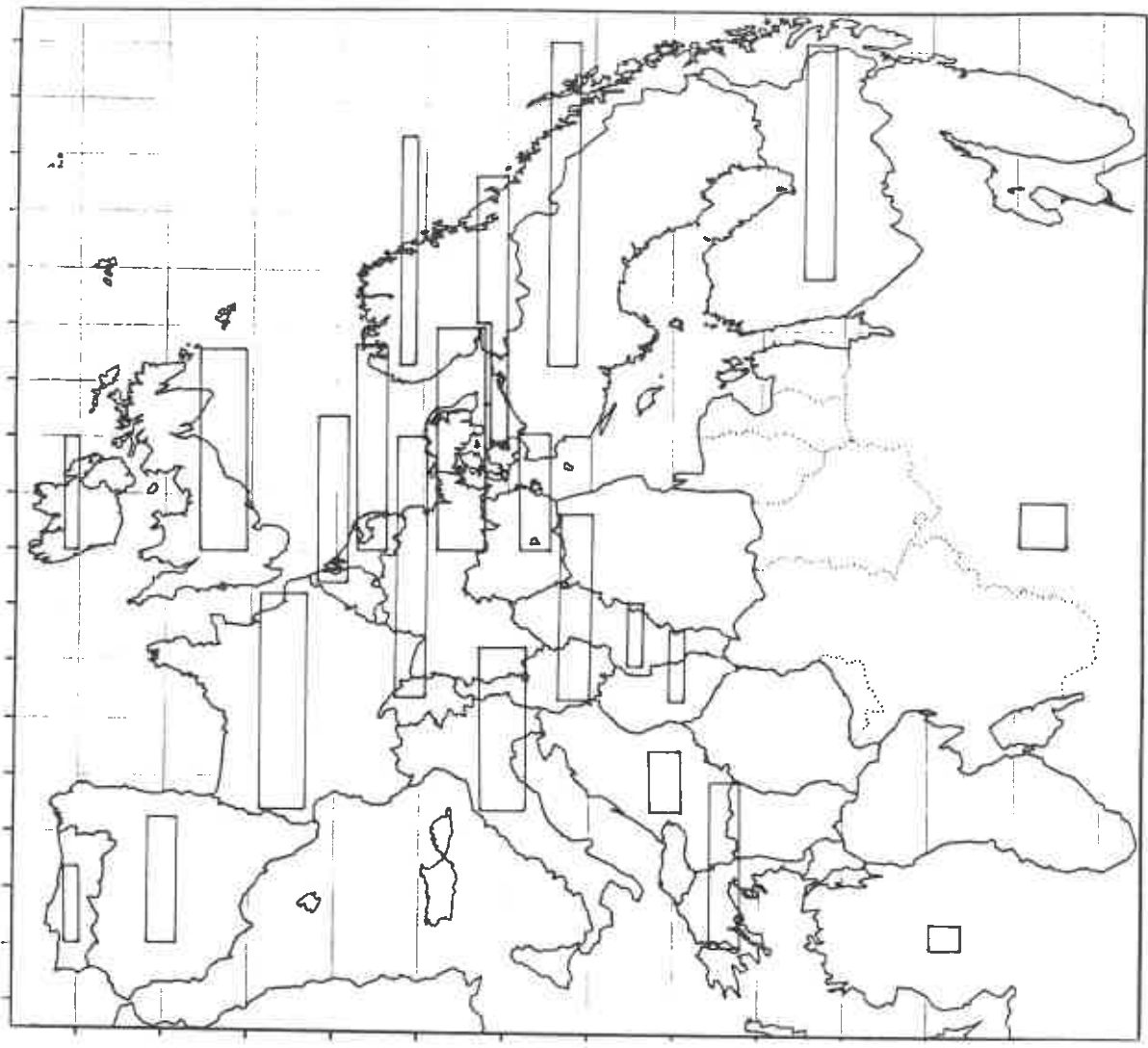

The height of the bars indicates the number of telephone lines per 100 inhabitants, and the width the absolute number of lines subdivided into three categories. In most Western countries the number of lines is not much smaller than the number of telephones. There are more telephones because many companies and businesses have stand-alone internal telephone switchboards. In a number of countries with deficient infrastructure, there is also a limited degree of "line-sharing". The number of telephones and lines is a good indicator for communication in general, for interaction within a country, and in particular internationally. Eastern Europe portrays a strong interaction deficit with much lower telephone ownership and even lower number of lines available. The German Democratic Republic is an especially extreme case where lines are reserved during the day for official use and after work are switched centrally to private phones. Arrangements have been made to upgrade telephone systems in the German Democratic Republic, the Soviet Union and other East European countries. As a strategy for increasing communication and interaction, building a new telephone system with a whole new infrastructure may not be feasible for most of the East European countries. The number of telephones could probably be increased with more ease than establishing a whole new infrastructure. Mobile phones could provide an efficient alternative for a substantial increase in the number of telephones and virtual lines provided that the capital investment is not prohibitive.

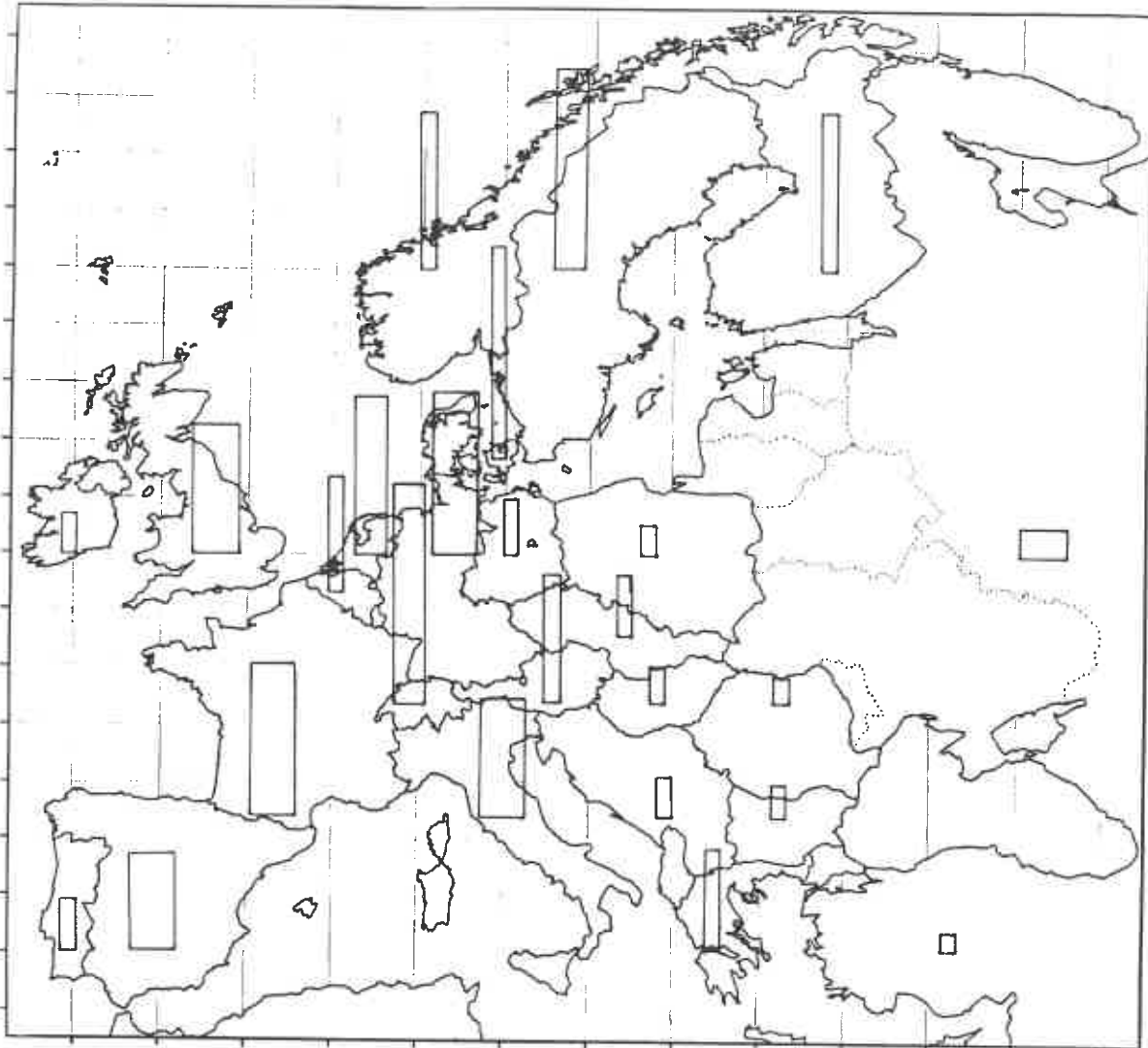

**ECONOMIC MAP
OF EUROPE**

**TELEPHONES
PER 100
POPULATION
EUROPE 1987**

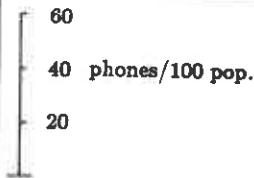

10⁶ telephone
lines in country

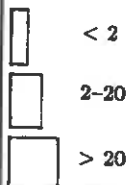

The height of the bars gives the number of telephones per 100 inhabitants, and the width the absolute number of telephone lines in a country subdivided into three categories. Telephone ownership is a good indicator for communication in general, for interaction within a country and in particular internationally. Eastern Europe portrays a strong interaction deficit. On average, Western Europe has about one telephone per two inhabitants, compared to about five times less in the East (about one telephone per ten inhabitants). Considering the poor quality of the telephone system in the East and its low network availability, the communication deficit is, in practice, probably even higher. For example, there are very few international lines and direct-dialling is often not possible. In the Soviet Union, many international calls have to be ordered at least one day ahead and domestic telephone books are unavailable. Thus, the communication lag of the Eastern countries appears to be much bigger than the transportation lag. Automobile ownership is higher in relative terms than telephone ownership. In some sense, the renewal of the communication system may indeed be the highest priority for the Eastern countries; and this may also be one of the few areas where a "catch-up" is feasible.

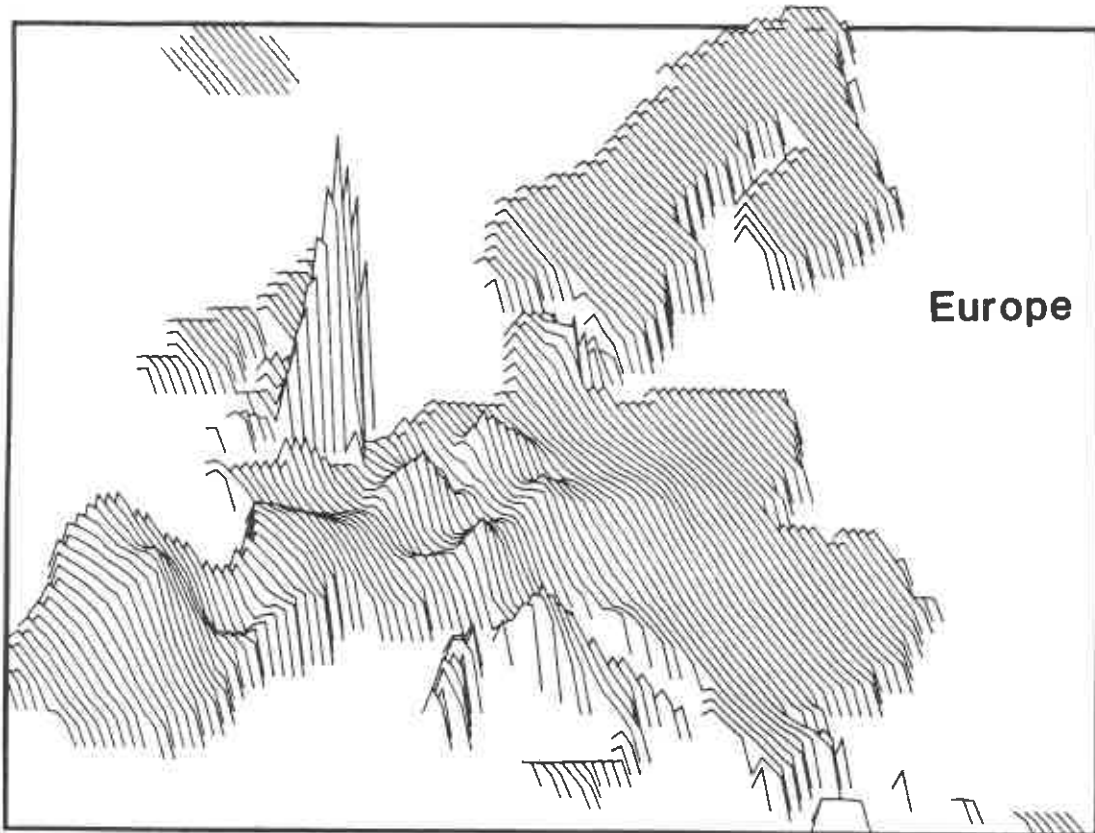

Urban telephone surface map of Europe (estimates of AT&T for 1982).

Density of urban telephones is shown per unit area. This density distribution is based only on cities with over 400,000 reported telephones. This means that all smaller communities and rural areas are excluded. Therefore, the map indicates both the settlement patterns and, accordingly, the spatial density of urban telephones. Peaks of high rates of telephone ownership occur for large cities and metropolitan areas. The most pronounced peaks are over London and Madrid. It is interesting to note that the Scandinavian countries and Switzerland do not appear to have a pronounced spatial concentration of urban telephones, although they have among the highest telephone ownership rates and line availability in Europe. This is clearly due to their relatively small cities and the low population density in general for the whole of Scandinavia. The urban telephone surface map shows that most of the interaction takes place within the Community countries where the highest telephone densities are observed.

74

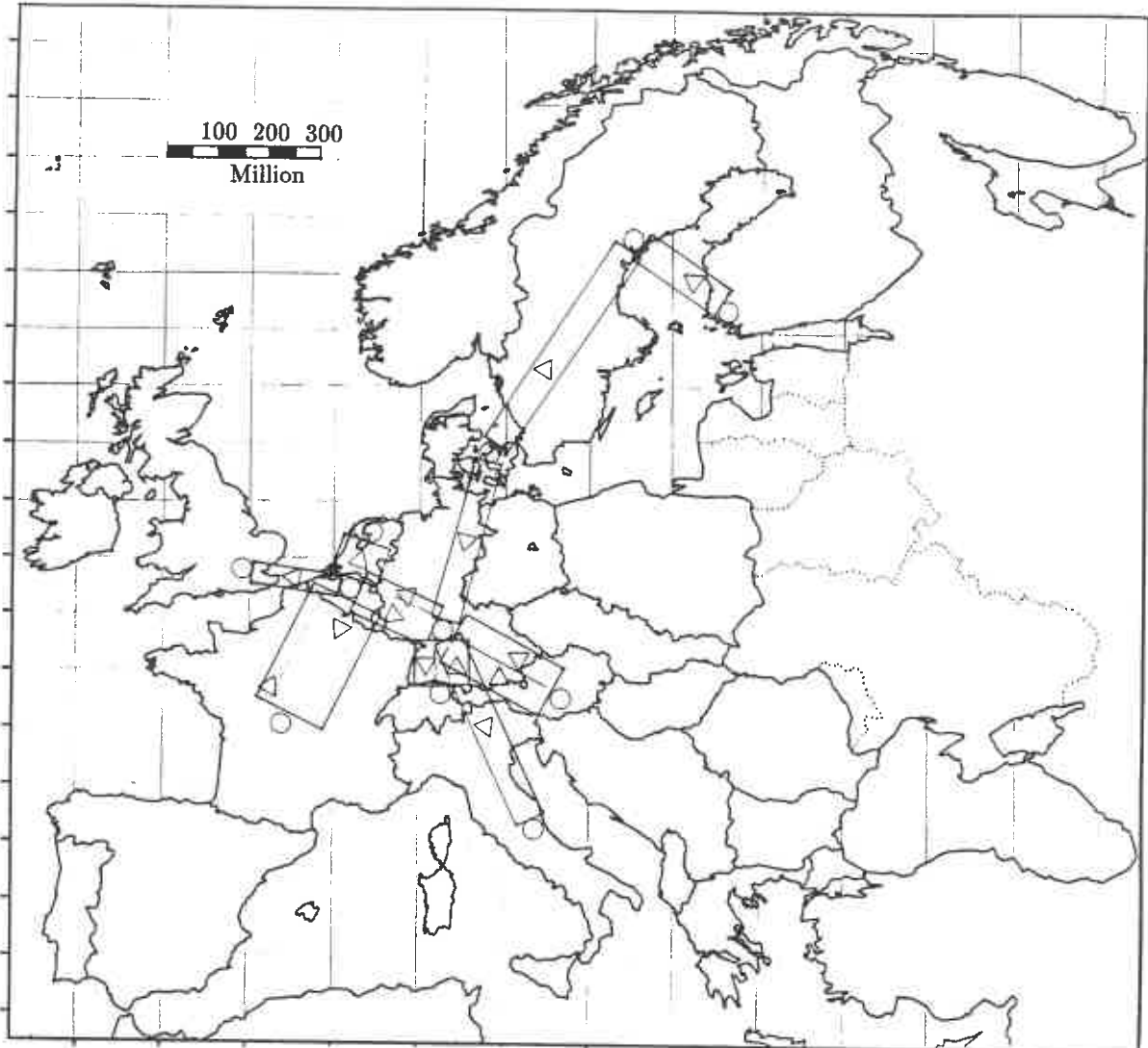

ECONOMIC MAP OF EUROPE

TELEPHONE CALLS FROM COUNTRY TO COUNTRY

1987

European interaction and communication intensity is illustrated on the basis of telephone calls to a given country by country of origin. Only the largest "channels" are shown. The circles symbolically represent individual countries and the width of the bars is proportional to the interaction intensity (i.e., number of telephone calls). The direction of communication is shown by a triangle (arrow). By far the strongest intensity of telephone calls is from Belgium to France; in the opposite direction the intensity is much lower. Other important links are the Federal Republic of Germany to and from Austria and Switzerland (similar intensities both ways), Great Britain to the Continent, Denmark to Sweden and on to Finland, and Germany to Italy. It is not a coincidence that these links are between those countries with the highest telephone ownership and number of lines per capita. This illustrates that the interaction intensity is indeed a function of the potential. Furthermore, these countries not only have among the highest rates of telephone ownership and line availability, but also the largest absolute number of telephones and network size (simply because France, Great Britain, Federal Republic of Germany and Italy have about the same population). According to the gravity theory of spatial interaction, these large countries would tend to attract large interaction flows. These could be assumed to be the highest where interaction friction is the lowest, i.e. where fewer obstacles exist. In fact this is the case - the largest interaction occurs where the language barrier is the smallest: Belgium and France on the one hand, and Germany, Austria and Switzerland on the other.