

IIASA PROCEEDINGS SERIES

# Modeling of Large-Scale Energy Systems

Proceedings of the IIASA/IFAC Symposium on  
Modeling of Large-Scale Energy Systems

February 25–29, 1980

W. Häfele, Editor, and L.K. Kirchmayer, Associate Editor

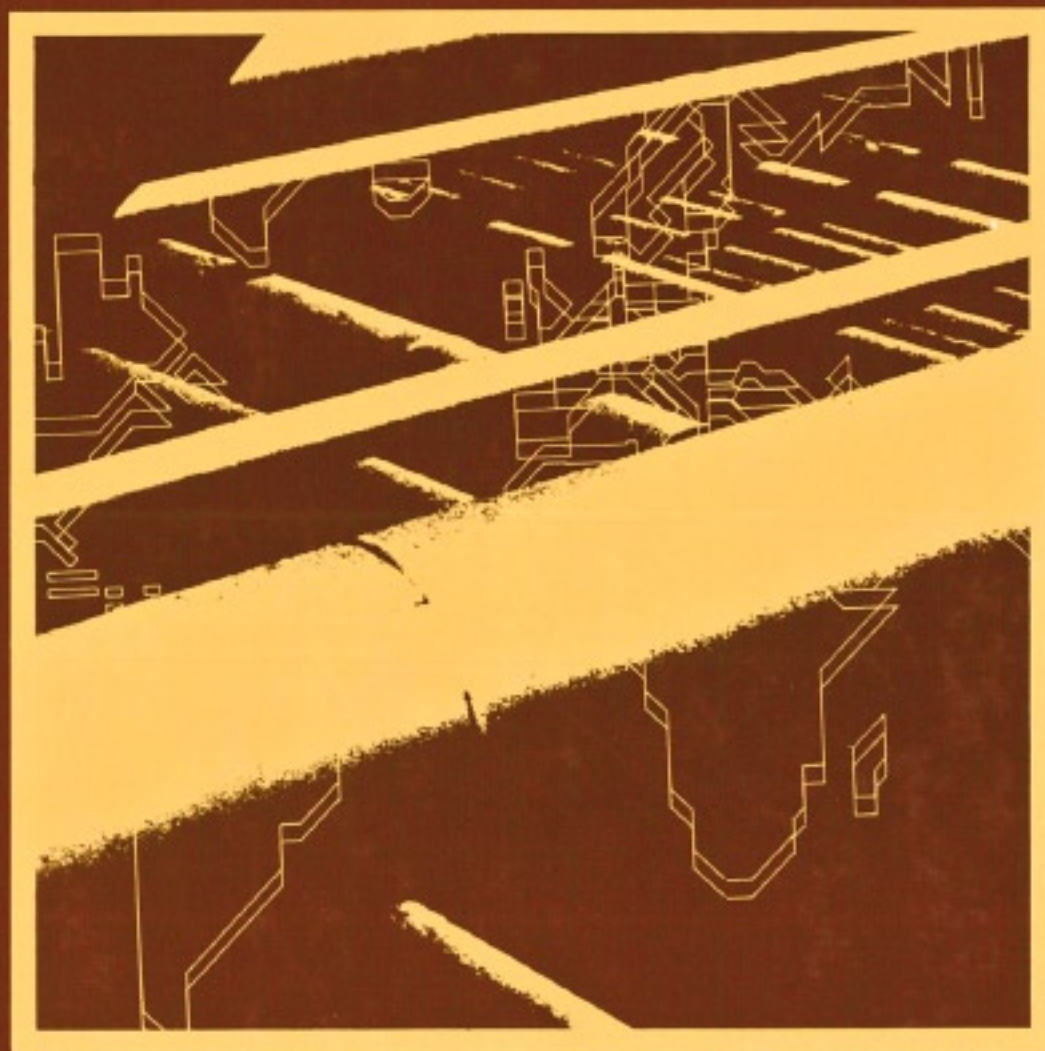

## IIASA PROCEEDINGS SERIES

---

- VOLUME 1      CARBON DIOXIDE, CLIMATE AND SOCIETY  
Proceedings of an IIASA Workshop Cosponsored by WMO, UNEP, and SCOPE,  
February 21–24, 1978  
*Jill Williams, Editor*
- VOLUME 2      SARUM AND MRI: DESCRIPTION AND COMPARISON OF A WORLD  
MODEL AND A NATIONAL MODEL  
Proceedings of the Fourth IIASA Symposium on Global Modeling,  
September 20–23, 1976  
*Gerhart Bruckmann, Editor*
- VOLUME 3      NONSMOOTH OPTIMIZATION  
Proceedings of an IIASA Workshop,  
March 28–April 8, 1977  
*Claude Lemarechal and Robert Mifflin, Editors*
- VOLUME 4      PEST MANAGEMENT  
Proceedings of an International Conference,  
October 25–29, 1976  
*G.A. Norton and C.S. Holling, Editors*
- VOLUME 5      METHODS AND MODELS FOR ASSESSING ENERGY RESOURCES  
First IIASA Conference on Energy Resources,  
May 20–21, 1975  
*Michel Grenon, Editor*
- VOLUME 6      FUTURE COAL SUPPLY FOR THE WORLD ENERGY BALANCE  
Third IIASA Conference on Energy Resources,  
November 28–December 2, 1977  
*Michel Grenon, Editor*
- VOLUME 7      THE SHINKANSEN HIGH-SPEED RAIL NETWORK OF JAPAN  
Proceedings of an IIASA Conference,  
June 27–30, 1977  
*A. Straszak and R. Tuch, Editors*
- VOLUME 8      REAL-TIME FORECASTING/CONTROL OF WATER RESOURCE SYSTEMS  
Selected Papers from an IIASA Workshop,  
October 18–20, 1976  
*Eric F. Wood, Editor, with the Assistance of András Szöllösi-Nagy*
- VOLUME 9      INPUT–OUTPUT APPROACHES IN GLOBAL MODELING  
Proceedings of the Fifth IIASA Symposium on Global Modeling,  
September 26–29, 1977  
*Gerhart Bruckmann, Editor*
- VOLUME 10     CLIMATIC CONSTRAINTS AND HUMAN ACTIVITIES  
Selected Papers from an IIASA Task Force Meeting,  
February 4–6, 1980  
*Jesse Ausubel and Asit K. Biswas, Editors*
- VOLUME 11     DECISION SUPPORT SYSTEMS: ISSUES AND CHALLENGES  
Proceedings of an International Task Force Meeting  
June 23–25, 1980  
*Göran Fick and Ralph H. Sprague, Jr., Editors*
- VOLUME 12     MODELING OF LARGE-SCALE ENERGY SYSTEMS  
Proceedings of the IIASA/IFAC Symposium on Modeling  
of Large-Scale Energy Systems  
February 25–29, 1980  
*W. Häfele, Editor, and L.K. Kirchmayer, Associate Editor*

IIASA PROCEEDINGS SERIES

---

Volume 12

Modeling of Large-Scale  
Energy Systems



# MODELING OF LARGE-SCALE ENERGY SYSTEMS

---

Proceedings of the IIASA/IFAC Symposium on Modeling of Large-Scale  
Energy Systems, February 25–29, 1980

W. HÄFELE  
*Editor*

L. K. KIRCHMAYER  
*Associate Editor*



PERGAMON PRESS

OXFORD · NEW YORK · TORONTO · SYDNEY · PARIS · FRANKFURT

U.K.	Pergamon Press Ltd., Headington Hill Hall, Oxford OX3 0BW, England
U.S.A.	Pergamon Press Inc., Maxwell House, Fairview Park, Elmsford, New York 10523, U.S.A.
CANADA	Pergamon of Canada, Suite 104, 150 Consumers Road, Willowdale, Ontario M2J 1P9, Canada
AUSTRALIA	Pergamon Press (Aust.) Pty. Ltd., P.O. Box 544, Potts Point, N.S.W. 2011, Australia
FRANCE	Pergamon Press SARL, 24 rue des Ecoles, 75240 Paris, Cedex 05, France
FEDERAL REPUBLIC OF GERMANY	Pergamon Press GmbH, 6242 Kronberg-Taunus, Hammerweg 6, Federal Republic of Germany

---

Copyright © 1981 International Institute for Applied  
Systems Analysis except the paper by  
Danskin which is Crown copyright.

*All Rights Reserved. No part of this publication may be reproduced, stored in a retrieval system or transmitted in any form or by any means: electronic, electrostatic, magnetic tape, mechanical, photocopying, recording or otherwise, without permission in writing from the copyright holders.*

First edition 1981

**British Library Cataloguing in Publication Data**

Modeling of large-scale energy systems. -  
(International Institute for Applied Systems  
Analysis. IIASA proceedings series; vol. 12).  
I. Power resources - Mathematical models -  
Congresses  
I. Hafele, W. II. Kirchmayer, L K  
III. Series  
333.7 HD9540.1 80-41554  
ISBN 0 08 025696 1

*In order to make this volume available as economically and as rapidly as possible the authors' typescripts have been reproduced in their original forms. This method unfortunately has its typographical limitations but it is hoped that they in no way distract the reader.*

*Printed and bound in Great Britain by  
William Clowes (Beccles) Limited, Beccles and London*

## PREFACE

The purpose of this symposium on Modeling of Large-Scale Energy Systems was to review the scope, limitations, and current applications of state-of-the-art energy models. Significant progress was reported on the work in many countries of the world in the utilization of models to affect tactical, strategic, and policy decisions. Insights into future research needs were also presented.

This symposium was organized by the International Institute for Applied Systems Analysis (IIASA) with cosponsorship by the International Federation of Automatic Control (IFAC) through the IFAC Systems Engineering Committee. IFAC is a federation of 40 national member organizations representing the technical societies related to automatic control in the respective member countries. The IFAC Systems Engineering Committee (SECOM) is broadly concerned with the theory and application of systems engineering and focuses upon energy problems through the SECOM Working Group on Large-Scale Energy Systems Analysis.

The Symposium Proceedings are presented according to the session organization:

### Opening Session

Session I – Problems in Exploring Energy Demand and Conservation

Session II – Integrated Sets of Models and Their Policy Applications

Session III – Problems of Technology Assessment, Energy Supply, and Use

Session IV – Questions of Distribution and Allocation of Resources

Session V – Issues of Decision Making Under Uncertainty

These papers represent the contributions of participants from 17 countries.

As a general observation, impressive accomplishments have been achieved in the past several years in bringing models to a useful state of development. Many different aspects of modeling are treated in the papers. The models include physical models; time series models of economic representations; scenario writing in which models containing technical, economic, environmental, and social factors were all considered; as well as simulation representations covering decision making. The experience reported indicates that more and more governmental and corporate executives are looking to economic and energy models as guides to improved

technology assessment and policies.

A number of significant challenges remain in the development of large-scale energy system models. Areas for future work include modeling of:

1. International energy markets
2. Less-developed countries
3. World oil policy
4. Global transportation of fuels
5. Energy and security
6. Energy–GDP–inflation relationship
7. Productivity–energy price relationship
8. Discontinuous improvements

Also additional efforts toward data collection and model validation as well as the treatment of uncertainty are warranted. The integration of economic, environmental, and energy models is a subject of increasing importance.

We wish to acknowledge the key contributions of K. Hoffman, Co-chairman of the Program Committee, as well as H. Porias and A. McDonald who served as Secretary and Acting Secretary of the Program Committee. Also to be noted are the major contributions of the members of the Program Committee: I.H. Abdel-Rahman, Institute of National Planning, Egypt; L. Bauer, Technical University of Vienna, Austria; H. Chestnut, General Electric Company, USA; R.J. Deam, Queen Mary College, London, UK; A.A. Makarov, Siberian Power Institute, USSR Academy of Sciences; K. Oshima, University of Tokyo, Japan; E. O'Shima, Tokyo Institute of Technology, Japan; H. Seidl, Wirtschaftsforschungsinstitut, Austria; H. Stimmer, Technical University of Vienna, Austria.

L.K. Kirchmayer  
*SECOM Working Group on Large-Scale  
 Energy Systems Analysis, IFAC*

Wolf Häfele  
*Program Committee Chairman,  
 IIASA*



# CONTENTS

## OPENING SESSION

Introductory Speech <i>W. Frank</i>	3
Introductory Speech <i>M. Styrikovich</i>	13
Energy Models and Policy Problems <i>W.W. Hogan</i>	17

## SESSION I: PROBLEMS IN EXPLORING ENERGY DEMAND AND CONSERVATION

Problems in Exploring Energy Demand and Conservation <i>W. Häfele</i>	29
Estimation and Projection of Energy Demand in Developing Countries: Current State and Major Issues <i>B.J. Choe</i>	
Behavioural Constraints on the Implementation of Conservation Measures in the UK, Using the SARU EDP Model <i>H. Danskin</i>	53
Demand for Energy in Manufacturing: Applications of Dynamic Models of Factor Demand to U.S. and Canadian Disaggregated Data <i>M. Denny, M. Fuss, and L. Waverman</i>	61
Sectoral Energy Demand for the Belgian Economy: The Case of the Iron and Steel Industry <i>F. Bossier, D. Duwein, N. Gouzée, and D. Rigaux</i>	69
Technology Assessment: Two Energy Examples <i>A.R. Demirdache and R.H. Clayton</i>	79

SESSION II: INTEGRATED SETS OF MODELS AND THEIR  
POLICY APPLICATIONS

Progress and Problems of a Systems Approach to Long-Range Energy Development <i>A.A. Makarov and A.A. Papin</i>	93
Integrated Modeling for Analysis of Energy Policy Decisions <i>E.G. Cazalet</i>	109
Linking Large-Scale Models and Energy–Environmental Case <i>P.W. House</i>	125
Formulation of Long-Range Power-Engineering Development Concept <i>V.I. Danilov-Danilyan and A.A. Ryykin</i>	139
Assessment of Scientific and Technological Progress in Energy Development Forecasting <i>V.N. Burkov, V.A. Irikov and A.S. Makarova</i>	149
An Overview of Macroeconomic Effects of Accelerated Implementation of Renewable Energy Technologies in the U.S. <i>W. Marcuse and P.J. Groncki</i>	161
Integrated Set of Models of the Electric Power System Development – Structure and Application <i>I. Lencz</i>	171
Energy Modelling: The Economist’s Approach <i>G.J. Kouris</i>	179
Policy Applications of the EC Modeling Programme <i>E. Fontela and R. Rubin</i>	187
System of Models for Assessment of Long-Term Development of the Energy Complex in Bulgaria <i>P. Tsvetanov</i>	195
A L.P. Model of the Dutch Energy Sector <i>F. van Oostvoorn, P.G.M. Boonekamp and N.J. Koenders</i>	207
Energy Model for Japan in A.D. 2025 <i>F. Mori, S. Wakamatsu, T. Maeda and S. Yasui</i>	215

Energy System Management by Computer Aided Analysis and Synthesis <i>K. Schmitz and H.P. Schwefel</i>	223
Energy Models in Mexico <i>E. Barriga and G. Bazán</i>	231
Issues in Modelling Aspects of the Greek Energy Problem <i>J.-E. Samouilidis</i>	239
SESSION III: PROBLEMS OF TECHNOLOGY ASSESSMENT, ENERGY SUPPLY, AND USE	
Planning and Analysis of Energy Research and Development Programs <i>K.C. Hoffman</i>	251
Technology Assessment in Energy Supply–Demand Model <i>Z. Falecki and J. Ordega</i>	265
Energy Systems and Energy Dependence: A Comparative Study in Technology Assessment for Various IEA Countries <i>G. Egberts, K. Leimkühler, and St. Rath-Nagel</i>	279
Decision Analysis in the Energy Sector: Nuclear Choices for Turkey <i>I. Kavrakoğlu</i>	289
Alternative Energy Futures – A Case Study for Austria <i>W.K. Foell and J. Richter</i>	299
A Stochastic Model for Electricity Generation <i>F. Louveaux and Y. Smeers</i>	313
Energy Modeling and Aggregation of Refining <i>D. Babusiaux and M. Valais</i>	321
A Mathematical Programming Model for Assessing Advanced Oil Technologies <i>A. Suzuki</i>	329
AL-EDIS: An Energy Information System for Developing Countries <i>V. Mubayi, R. Chatterjee, and T. D’Errico</i>	339

SESSION IV: QUESTIONS OF DISTRIBUTION AND  
ALLOCATION OF RESOURCES

Energy Price: Pervasive Carrier of Information <i>A.F. Beijdorff and J.H. Lukas</i>	353
World Fossil Resources: Availability and Constraints <i>M. Grenon</i>	373
Divergencies of Market and Optimum Prices for Energy Resources <i>H. Uzawa</i>	379
Long-Range Pricing of Crude Oil <i>R.J. Deam</i>	387
Application of Generalized Trans-shipment and Integer Programming Algorithms in Regional Energy Planning Models <i>J. Debanné</i>	401

SESSION V: ISSUES OF DECISION MAKING UNDER  
UNCERTAINTY

Risk Studies for Nuclear Power Plants – Merits and Limitations <i>A. Birkhofer</i>	413
Some Principal Aspects of Forecasting and Decision-Making and the Issues of Decision-Making Under Uncertainty in the Austrian Electricity Supply System <i>F. Pober</i>	425
Decisions Under Fuzzy State Distribution with an Application to the Health Risks of Nuclear Power <i>E. Kofler and P. Zweifel</i>	437
The Effect of Uncertainties on Estimates of the Economic Benefit of Introducing Alternative Reactor Types into an Electricity Generation System <i>C. Scrogg</i>	445
Discussion and Decision in the Case of Power Plant <i>Oberjägerweg</i> in West Berlin. Models, Experience, Conclusions 1976–1978 <i>H. Maier</i>	453

# OPENING SESSION



# INTRODUCTORY SPEECH

**W. Frank**

*Department of Energy, Raw Materials and Supreme Mining Authority,  
Federal Ministry of Trade, Commerce and Industry, Vienna, Austria*

## ABSTRACT

After dealing with the question of determining the complexity of a model, the Austrian experiences with the development and application of models for different purposes within the energy economy are described. Finally the importance of nonlinear models for the realistic representation especially of political influences on the energy supply situation is underlined.

## KEYWORDS

Complexity of Models; Analytical and Numerical Approach; Austrian Experiences with Models in Energy Economy; Necessity of Nonlinear Models.

## INTRODUCTION

Doubtless the greatest real system which we may consider is that of the Universe. It is worth to remember that, more than a century ago, it was already possible to make a distinct statement about the fate of this system. As a consequence of the just precisely formulated second law of thermodynamics one was able to assert that its ultimate destiny will be its heat death. The possibility of this statement is based on the following three assumptions:

- the Universe is considered as a closed system;
- there exists the entropy as a state function of this system;
- only the peculiarity of this state function has to be regarded.

This example clearly illustrates the fact that any well posed model of a system is determined by the questions which should be answered by its aid and furthermore, that the complexity of a model is not determined by the physical extension of the real system which it

should represent but by the number of parameters which are necessary to describe its behaviour adequately with respect to the problems of which the solution should be found with its support.

The term number of parameters needs some explanation. Here too I'll try to give the explanation by means of an illustrative example. A problem, familiar to mechanical engineers engaged in the design of combustion engines, is the evaluation of the resonance frequencies of the torsional vibrations of the crankshaft of those engines. The execution of the evaluation is done by a simplified model of the vibrating system. According to the rules of mechanical equivalence, any piece of the crankshaft belonging to one piston can be reduced to a piece of a rigid straight shaft. Each of these pieces is connected with its neighbour by elastic forces. In the same way the forces acting on each piston as well as the inertia forces of the moving piston and the connecting rod can be reduced to a periodically varying force and a periodically varying momentum acting on each piece. The model which we have constructed by this means consists therefore of  $n$  elastically coupled pieces of rigid shafts, if  $n$  is the number of pistons, subject to the action of periodically outer forces and momenta. So we have come to a system of  $n$  elastically coupled masses - the masses of the rigid pieces. Its behaviour is described by a system of  $n$  ordinary differential equations of the second order of  $n$  time dependent variables which represent the relative angle position of the different pieces. The resonance frequencies of this model correspond to those experimentally observed in the real system within a range of less than 2 %. But a further reduction of the number of variables - or parameters - is possible. Though the differential equations of the system are of the same kind one can consider instead of  $n$  discrete pieces of rigid elastically coupled shafts on which  $n$  periodically forces and momenta are acting pointwise, a throughout elastic shaft on which the mass and elastic forces as well as the acting forces and momenta are continuously distributed. The behaviour of this system is described by one single partial differential equation for the only variable of this system, which is the relative angle position of the cross section of the shaft, now depending on the time and the place of the cross section along the axis of the shaft. The approximation of this simplified model to the original one is fast improving with the increase of  $n$ . The fact that the solution of this partial differential equation is a standard result of classical analysis allows an immediate estimation of the resonance frequencies. This example does not show only that a drastic reduction of the original number of parameters - in the case if they describe states of the same kind - can be reached but it demonstrates also that in our times, where we dispose over such powerful tools for the performance of complicated numerical calculations like electronic computers, we should not neglect the other powerful tool which mankind has developed to master complicated situations, namely the analytic approach. In order to crack a nut we need a pair of tongs. The same is true for the solution of the problems which we are dealing with in our symposium. Both Computers and Analysis are essential.



AUSTRIAN EXPERIENCES WITH MODELS IN ENERGY ECONOMY

From what I have said one might have got the impression - though already great physical systems could be described with respect to a particular behaviour with only few variables - that the description of physically smaller systems create less problems than the description of larger ones. But I shall demonstrate that this conclusion is generally not true. In Austria, like in many other countries, so far, we have had a rather tight correlation between the Gross National Product on the one side and the overall use of energy or, in particular, the use of electric energy on the other side. But this statistical fact does not explain the interplay of the different economic factors like labour, capital and energy in the creation of the Gross National Product. In some of the great countries it was possible to develop - based on the available statistical data - a simple model for the medium term planning of the energy economy namely a production function for the Gross National Product. This production function contains the variables capital expenditure for gross investments, labour forces and energy input - in aggregated totals or distinguishing between different kinds of energy. But for Austria the same endeavour failed completely [1] for the national economy as a whole as well as for some important sectors. This was not due to the fact that the periods during which the economic evolution could be considered as relatively stable are not very long and therefore the result of smoothing of the statistical data of relatively small number of years is valid only within a rather broad range. The main reason for the mentioned disappointing result is the fact, that the law of the great number does not work within a small system. There the decisions of just one enterprise - or at least of a small number of economic entities - are often showing significant effects on the behaviour of the whole economic system. Therefore it is not possible to hide those entities behind a statistical aggregate ideally consisting of many such entities but one must take them explicitly into account i.e. one has to present them individually, which means that one needs an adequate number of variables for the description of the behaviour of the system. Furthermore, external influences in general do affect smaller economic systems more than larger ones. In particular, in smaller systems the significance of the foreign trade compared to that of the home market is in general more important than in larger ones. Also international political disturbances exert usually greater effects in smaller countries on the results of their economies than in larger ones. In the case of Austria this explains the situation of having only relatively short periods for which, under this aspect, statistically homogeneous data are available. Only beginning with 1955, the year of the state treaty, we can speak of a relatively long stable period.

The fact that a small country like Austria has to use complex models for the description of its energy economy justifies that I speak today to you, at the side of eminent experts such as Academician Styrikovich and Prof. Hogan, who are both at the same time exponents of the greatest countries of our world.

In Austria we have since about ten years an overall system of energy statistics published yearly by the Austrian Central Statistical Office [2] which corresponds to the Input-Output Matrix of the National Economy. The idea to establish such a system of national

energy statistics was developed by S. Sagoroff, K. Schagginger, K. Turetschek and myself in a study concerning the relations which exist between the national economy as a whole and its energy supply [3]. These energy statistics show the input and output of 25 different energy carriers to 43 economic sectors into which the whole national economy is divided. These statistics serve as data base for two important models.

The first one is a model for the simulation of the management of the energy supply in cases of emergency. If such a situation occurs an emergency council - set up by law [4] - has to advise the government the appropriate measures to be taken. The model is intended to facilitate the work of this council and is designed as a computer supported decision program. The procedure is as follows. By means of the data of the recent economic development the data of the last available yearly energy statistics are adapted to those which may represent the present situation. With the aid of a set of index numbers on which an agreement among experts has been reached, one passes over from the yearly energy balance adapted to picture the present situation to monthly ones. Based on these data one is able to compare the unrestricted needs of the forthcoming months with the amount of the different energy carriers which are expected to be then available for supply. A first decision must now be taken concerning the quotas of the different kinds of energy carriers assigned to each sector of the economy in order to arrive at a new equilibrium between the sum of imports and indigenous production of energy on the one side and the deliveries of energy on the other side. This first decision has of course to be checked with respect to its intrinsic consistency. That means that the activities of the particular sectors of the economy, their production and consumption of goods and services, which are possible with respect to the granted quotas of supply with the different energy carriers, are compatible, i.e. that the industry for the production of building material should not come into a position to produce more goods than the building industry is able to use and so on. This necessary check is done by a transition from the energy balance to the monetary input-output balance of the whole economy which represents the activities of the particular sectors of the economy by the monetary value of these activities with the aid of functions which are representing these activities in dependence on the respective consumption of energy. These functions are postulated on the base of the experiences gained already in the particular sectors on the relations existing between the levels of economic activities and the levels of energy consumption as well as on the special technological conditions of these relations. Details about this whole procedure were published recently by M. Oettl and W. Teufelsbauer [5]. I may only mention here that this method doesn't allow only to identify the discrepancies caused by the primary supply decision but does also allow to correct this decision and to gain at last an equilibrium between the activities of the particular sectors of the economy on the reduced level of overall energy supply. The computer allows to find this solution rather fast and it will be now up to members of the emergency council or at least to the responsible politicians to decide whether this solution is acceptable from their point of view or should be replaced by another one which is better suited for a compromise. In the latter case, the whole procedure has to be repeated with a new set of initial values for the quotas and will be continued

since at least an optimal political solution has been reached. The first tests with this model are now under way and we hope that we will be able to demonstrate that this model works well in the early summer of this year.

The question rises of course if it would be advisable instead of working with such a simulation model with a model, which delivers directly a solution for the quotas with respect to the best fulfillment of a special socio-economic criteria. Examples for such criteria are for instance a maximum of employment or a maximum of national income. It may perhaps interest you that we indeed did occupy ourselves with such optimal models ; this occupation was historically previous to that with the simulation one. Prof. Tintner published already in 1975 an excellent paper [6] in which he displayed in detail the structure of such optimal models for the management of an energy emergency. Yet the disadvantage of these optimal models lie in the fact that the necessary data for these models are not available. The Austrian Central Statistical Office has officially declared that it will last more than five years to produce these data and that then these data will refer to a situation at least seven years ago. Therefore on account of this lack of data we had to pass over from these perfect optimal models to the less perfect simulation one for which the data are more or less immediately on hand and which will allow us, as we hope, to reach at least a politically acceptable solution in any case of a possible energy supply emergency.

The second application of the yearly energy balance consists in the use as initial data base for the evolution equations for the forecast model of the Austrian energy economy. Charged by the Austrian Federal Ministry of Trade, Commerce and Industry, the Austrian Institute for Economic Research has developed a model for medium term forecast - i.e. for a period of 10 to 15 years - of the development of the Austrian energy economy. Every year a new forecast is published by the Institute [7] taking into account the discrepancies between the former forecasts and reality in order to improve the statements on the base of the experiences so gained. The detailed structure of this model is published in the annexes to the "Plan of the Austrian Energy Economy" in 1975 and also in 1976, both edited by the Federal Ministry mentioned above [8]. This model is founded on the assumption of a more or less undisturbed international political and economic evolution and on a set of explicit assumptions about the further development of particular economic sectors with rather high energy intensity on the one hand as well as on the Gross National Product on the other hand. The relations between the quantities, which are characteristic for the economic activities of the relevant sectors of the economy and their energy inputs as well as the relations between the Gross National Product and the energy consumption of the whole economy, are deduced from the experience of the past. For the future the trends, resulting from the historical statistical data are modified - if necessary - in accordance to available information about possible changes in the technology, the behaviour of the population and so on. Up to now these modifications were dealt with great caution. Especially the possibilities of conservation of energy were only marginally taken into consideration, due to the lack of administrative measures and financial promotions for this purposes. Though the situation has altered now in this

respect, the future forecasts will take into account explicitly the measures for energy conservation. Two extreme cases will be demonstrated respectively: The expected development without the influence of any of those measures and the development under the simultaneous influence of all those measures which may be realistically considered as feasible.

The experiences gained up to now with these forecasts are showing that the estimation of needs in 1985 and 1990 were always too high and had to be revised downwards. But this was mainly due to the unstable general economic development, especially to the recession in the years 1975 and 1976. During the periods, wherein the assumption of the growth rate of the Gross National Product was fulfilled the trend of the development of the actual energy consumption has shown good accordance with that of the forecast.

For the Federal Ministry of Trade, Commerce and Industry the forecast model serves as a standard of comparison in order to examine if the plans made up within the different branches of the energy economy by the respective companies are sufficient to meet the expected future needs which are to be expected without taking into account unawares, or if shortages are to be feared because of the insufficient arrangements by the companies, so that the administration should influence them to correct their initial plans.

The forecast model has been submitted at several times to critical reviews of a great number of experts on economic forecasts. Many proposals for improvements and refinements of the model have been made at these occasions. Yet the implementation of nearly all of these proposals proved to be impossible due to the lack of the availability of the necessary statistical data.

Especially from the methodological point of view the deterministic feature of the present forecast model is very unsatisfactory. E.g., in order to estimate the uncertainties in the result of the forecast caused by the ranges for the constants of the model it would be very desirable to work with a stochastic model for the forecast. However, at present there does not exist any base for an assessment of the ranges of these constants and therefore the transition from the deterministic to a stochastic model is impracticable.

Two conclusions may be drawn from these experiences:

1. By the existing statistical data base one is forced for practical purposes to work only with those models for which the base is adequate.
2. That one cannot dispense with the development of advanced models though at present they are not applicable in practice. Because only with the knowledge of the kind of data which is needed to make them operable one will be able to make the necessary provisions for the improvement of the statistics and to overcome their present lacks. Therefore advanced models are essential for any progress in modelling though being unapplicable at present.

For individual branches of the energy economy, as well as for the domain of great companies, a number of mathematical decision models, partially rather sophisticated ones, have been developed also in Austria. The reason for mentioning these models in the context of this conference is that they often show the same complexity as those for the whole energy supply system. A sample of such models, chosen by a committee of which I had the honour to act as chairman, has been published within a series of publications of the Federal Ministry of Trade, Commerce and Industry devoted to problems of Energy Policy [9]. In general the possibility to work with such models within the scope of a company is much easier than within the frame of the whole socio-economic context because of the following reasons:

- a) it is simpler to define the goal of a company than the goal of the socio-economic development. In most cases the goal of a company is to achieve a maximum of profit and therefore the simple question is put which strategy has to be pursued to reach this aim.
- b) The necessary data for models on the level of companies are available much easier and with a higher degree of reliability than for models on the socio-economic level. This is due to the fact that at least a part of this data is of a technical nature, that means that they are derivable either from the technical disposition of the plants or from rather well known factors of costs, and that the range of the other part of the data can be appraised rather fairly in general.

In Austria like in most other countries the use of models of large energy systems has started by dealing with the problems of the operation of the grid. 33 years ago the transmission capacity of the then existing grid under different load situations was systematically determined for the first time. This work was done with the aid of simple mechanical computers only and lasted some months. The results served as the base for the development of the grid. Three years later a low voltage electric model of the grid - in our modern terms an analogue computer - with a fidelity of at least 3 % became a decisive aid for the off line control and for the further planning of the extension of the grid. Today this analogue computers are already replaced by digital ones, which do serve for the planning of the grid as well as for the on line control of its operation. The new concept for the automatic load distribution for the Austrian grid, which will be fully completed in summer this year, is lead by the idea of a hierarchically organised system of local and regional computers and at last a central unit by which on line

- a) the control of the reliability
- b) the instantaneous optimal load distribution

can be performed. Off line, by the central unit alone, the long term optimisation of the future operation of the different plants will constantly be prepared and adapted to the changing situations. This

is very important for a country like Austria, whose electric supply still is predominantly dependent on the production of its hydraulic power plants.

As an example of the application of a model for the best combined energy supply with electric power, natural gas and heat from the district heating system in Austria I may mention the model which is actually developed by the Salzburger Stadtwerke AG [10]. A mixed-integer program will be used for the planning of the further extension of the combined supply system as well as for its actual performance with different primary energy carriers: coal, natural gas, fuel oil, hydro power and the buyance in addition of electric energy.

These examples may be sufficient to show that Austria takes an active role in the development and in the application of models of large-scale energy systems. Therefore it is also particularly interested in the results of the present IIASA Symposium.

#### NECESSITY OF NONLINEAR MODELS

Finally I want to come back to the question of socio-economic energy models. According to the Law on the Promotion of Energy Supply which has passed the parliament in December last year [11] the Austrian government will have to present from now on to the parliament a comprehensive report on the situation of the energy supply and its further prospects every year. Without making use of a formalized model for the whole economy it will therefore be necessary to apply a model which gives an account of the impacts of measures taken or omitted in the field of energy on other parts of the economy. This model extends therefore in many respects the forecast model which has been mentioned previously, especially because it should also allow for the impact of political decisions. We in Austria have gained the practical experience that for the adequate representation of such relations linear models are not suited. The decision against the use of nuclear energy from fission for the supply of electricity has been taken by a majority of only 50,4 % in the referendum. The converse result would have allowed to take the already finished nuclear power plant of Zwentendorf into operation at least in principal. This example shows that one has to consider the discontinuous effects of political decisions in an appropriate model. The theory of catastrophes, developed in the last decade by R. Thom, Zemann and others and, in an extended version, the theory of resilience to which special attention is given within the IIASA may help us to develop such realistic models. In finishing my exposition I would like to express my hope that this symposium will particularly stress the importance of these realistic non-linear models and that it will contribute to the development of those models which can be used with advantage by the men of practice in energy politics.

REFERENCES

- [1] Tintner G. and others: Produktionsfunktionen für Österreich unter Berücksichtigung der Energie. Published in: Großtechnische Energienutzung und menschlicher Lebensraum. TU Wien and IIASA (1977) page 75 - 90
- [2] Statistische Nachrichten 26. bis 33. Jahrgang 1971 bis 1976 (Neue Folge) Yearly publication: "Energieausstoß und -einsatz der österreichischen Volkswirtschaft (im Jahre 1969 bis 1977)"
- [3] Frank W., Sagoroff S., Schagginger K. and Turetschek K.: "Die energetische Struktur der österreichischen Volkswirtschaft im Jahr 1964". Schriftenreihe des Institutes für Statistik der Universität Wien, Neue Folge Nr. 5, Physica Verlag Wien - Würzburg (1970)
- [4] Austrian Bundesgesetzblatt Nr. 319/1976
- [5] Oettl M., Teufelsbauer W.: An Integrated Quantity Value Energy Input-Output Model for Planning Purposes. Paper presented to the Seventh International Conference on Input-Output Techniques, Session 6. Innsbruck, Austria 9. - 13. April 1979.
- [6] Tintner G. and others: Ein Energiekrisenmodell. Zeitschrift Empirica (2/1975)
- [7] E.g.: Monatshefte des österreichischen Institutes für Wirtschaftsforschung (April 1978)
- [8] Energieplan 1975, Bundesministerium für Handel, Gewerbe und Industrie Wien (1975)  
Energieplan 1976, Bundesministerium für Handel, Gewerbe und Industrie Wien (1976)
- [9] Planungsmethodik in der Energiewirtschaft. Band II der energiepolitischen Schriftenreihe des Bundesministeriums für Handel, Gewerbe und Industrie, Springer Verlag Wien (1976)
- [10] Schmidt H.: Das Konzept der Energieversorgung der Stadt Salzburg in der Zukunft. Lecture held at September 9th, 1977. Arbeitsgemeinschaft der Österreichischen Gemeinwirtschaft, Landesgruppe Salzburg. Hektogramm
- [11] Austrian Bundesgesetzblatt Nr. 567/1979





# INTRODUCTORY SPEECH

**M. Styrikovich**

*USSR Academy of Sciences, Moscow, USSR*

I am very grateful for the honor to present an introductory speech at such a highly representative forum of very competent specialists as gathered at this symposium.

The very fact that IFAC--a most prominent federation of scientists specialized in the area of automatic control--and IIASA--well-known to the world from its work, in particular on global forecasting--have united their efforts on modeling of large-scale energy systems, is very significant.

Any approach to modeling needs a profound knowledge, both in theory and technique of systems analysis, and in objects to which these analyses are applied. I myself am much more a specialist in general problems of energy than in methodology of modeling, and because of this I consider it reasonable to concentrate in this introductory speech on some complicated problems connected with prognoses of the world's as well as of regional energy development.

The complexity in this field is great because today all of the world's energy systems are at a turning point from a rather simple situation at which growing energy demand was ensured mainly through the extension of the production of oil and gas which are suitable for virtually any consumer. At the same time, installations for energy conversion were not too capital-intensive and the largest part of transformed energy prices, mainly electricity, was connected with the payment for primary energy resources. Moreover, such prices were more or less stable with a given possibility to create an economic prognosis of good probability.

Today, after an initial shock and some time of uncertainty, in which many individual options were considered as a probability, it is more or less clear--at least to the majority of specialists in the energy field--that several decades will be the transition period in which energy supply will be based on a mixed blend of various primary energy sources with a gradual switch from oil as a major source to nuclear and coal.

It is also clear with rather high probability that in the field of demand the near future will be marked by a rather large effort to lower the demand for primary energy sources by more or less strong economy measures. But in spite of such measures energy demand will grow considerably, and the so-called soft energy path is quite unrealistic. This was proven by IIASA's additional scenario for 16 Terawatt energy consumption in year 2030. In my opinion this scenario demonstrates the improbability of such low demand at least from two points of view. First, energy consumption for Regions I and III--which include most developed free market regions--will be, in 2030, almost the same as today. Because it is quite impossible to stop energy demand growth in the next one to two decades, this means that in the first decades of the next century there will be a decrease of energy demand, which is a forecast with very low probability.

Second, for less developed regions this scenario proposed very low energy consumption per capita even in the year 2030 which reflects the impossibility for such a region which represents the majority of the world population, to meet even the most essential needs for a proper level of living conditions.

It is necessary to take into account also that the largest part of the measures for economy of primary energy sources needs additional capital investment which also includes additional amounts of energy, and this initial energy consumption will be compensated by the energy economy only within a rather long period of time.

For this reason we must go to choose, as the only reasonable perspective, the so-called hard energy path, based in the next few decades on gradual substitution of oil and natural gas by nuclear and coal. Of course, such a way of action must be combined with all reasonable measures for preventing wasteful energy consumption, safety, and prevention of large ecological side effects.

It is worthwhile to mention that being at a turning point not only in the field of energy but practically in all fields of material culture implies the necessity to switch from traditional uses as general criteria level of life to a more broad quality of life. We have to re-evaluate almost all traditionally accepted points of view on optimal ways to solving many individual problems connected with energy in general.

First, it is necessary to take into account that in a transition period the energy supply shall be based on a mixed blend of several types of energy resources, very different in their usability for various consumers and mainly very capital-intensive. Today it is clear that even at the present price for oil, base load production of electricity on a large scale in every part of the world shall be much cheaper in large nuclear electrical stations than in existing heavy oil fired stations. But nuclear stations--even today's thermal neutron stations--are very capital-intensive and expenses connected with fuel consumption comprise only 20-30% of total electricity prices. That means that the price will change very significantly with the load factor. In future, with an increasing share of nuclear energy in total electricity production and especially with the introduction of fast breeder reactors, the difference between the prices for electricity consumed in intermediate load, base load, and off-peak

load, shall be very large. The same will take place for coal-fired electrical stations which will be more capital-intensive because of more stringent environmental restrictions. But very probably for coal stations the share of fuel expenses in electricity prices will remain larger than for nuclear, and consequently coal-fueled stations will be in many areas convenient also for intermediate load.

Of course, such a situation will call for the introduction of various measures for energy storage and artificial methods to smooth the load curve. Because natural conditions for such measures are in some areas much more favorable than in others, it means that the difference in price of electricity connected with the weekly load curve will be in some areas significantly larger than in others.

Very big changes will occur in the near future also in the area of heat consumption. In past times, the price for clean fuels--oil products and gas--which are acceptable for heat supply especially for small scattered consumers, was almost the same as the price for fuel for large electrical stations. But today the price of a unit of heat produced in a large nuclear or coal-fired electrical station is much lower than the price for oil products or natural gas, and in future the gap will most probably grow even further.

At such conditions, the effectiveness to use large electrical stations as a source for covering heat demand in place of using local installations for direct fuel combustion, will increase considerably. Of course, in countries (for example the Soviet Union) in which district heating systems based on co-generation of electricity and heat is commonly used, the problem can be solved in a simpler way. But also at such a condition we need a new approach because using nuclear energy means a very long and large pipeline for overheated water, or to use low pressure reactors for heat supply only. In the latter case it will be possible for such specially safe reactors near big cities.

Of course, using nuclear energy for district heating has some obstacle connected with the change of heat load around the year. In this case, the problem can be solved by using natural gas for heating (if we have, like the Soviet Union, large reserves thereof), or by using coal for winter load (in which case the installation will be equipped with additional systems for exhaust gas cleaning).

Because all these solutions have some obstacle, a zone of economical use of electricity for low temperature heat supply shall be broad in future, in form of cumulative of peak heating or use of heat pumps. Because natural (climatic, geographical, etc.) conditions of each specific area are different, it is necessary to provide a special submodel to investigate optimal solutions for several typical combinations of events and large systems for choosing an optimal blend for each large region.

In any case, seasonal changes of heat consumption is a very big problem because storage of heat for a season is much more expensive than for a day or a week. Today, only two methods of such storages exist--stockpiling of coal, or underground gas storage. In the case of cogeneration it is possible in some areas to use water storage of big hydrostations in combination with nuclear cogenerating plants; the latter, having a reactor of fixed thermal capacity, will work

at greater heat output, but lower electricity production in winter, while hydro-stations use accumulated water to increase output of electrical energy in winter.

Especially complicated is the problem of replacing oil and natural gas from producing high temperature heat for industry (metallurgy, chemical industry, etc.). Several years ago it was almost common opinion that such a problem could be solved via HTGR. But in the last years, studies on the problem give some indication that such a combination will be rather expensive because of difficulties to develop not only HTGR itself, but mainly high-pressure-helium high heat exchanger. Besides, in many cases electrical heating has some technological preference which might compensate a loss connected with producing electrical energy from high temperature heat. Especially promising in this field are several processes based on using plasmotrons in which practically the temperature level is unlimited. It is obvious that in many cases the replacement of direct combustion of oil and gas with nuclear energy through electricity may be preferable. It means that in future the already existing tendency of increasing the share of electrical energy in overall energy balance in the near future will be accelerated. A very special case is a problem to replace oil products in the field of transportation. Of course, in railways and pipeline transportation replacement of oil products or gas for electricity must be accelerated, and this can be done very easily.

But for autonomous transportation the problem is very difficult. Today it is almost clear that using hydrogen for cars, lorries and buses will be economical as a small addition to liquid fuel only (mainly for decreasing air pollution). Some perspectives have electrical accumulators of new types, especially for intercity vehicles. But for universal cars a switch from natural to synthetic liquid fuel is most promising (for the near future mainly produced from cheap coal).

Of course, all the examples mentioned above do not comprise a full list of new problems connected with the big change in all patterns of energy even for the near future. And, of course, a big part of these remains to be solved and will require an extensive exchange of opinions such as I hope shall take place during this symposium. Many more problems shall arise if we go to long-term prognosis. But it is necessary to think about a *very* long term of energy because all energy systems are very inertial in producing, as well as in consuming parts. And future energy systems are growing more and more rigid, because of increasing capital investment requirements and consequently longer lead times, and long economically reasonable working lifetimes. Also we must take into account that the penetration time of any new technology is very long. For example, if we want to have synthetic fuel as a significant part of the liquid fuel world market in the second decade of the next century, we must have several commercial factories already working in the first decade of the 21st century. This means that several demonstration plants which could provide the basis for a proper selection from among several already proposed processes for coal liquefaction must be in operation in the 90's, and consequently scientific work and experimental installations must be well established in the 80's. It means that we must work today very hard on future energy problems if we do not want to face very serious crises in future.

# ENERGY MODELS AND POLICY PROBLEMS

**W. W. Hogan**

*Energy and Environmental Policy Center, Kennedy School of Government,  
Harvard University, 79 Boylston St., Cambridge, Massachusetts 02138, USA*

Abstract. Energy models sprouted everywhere during the rush to analyze the problem of the seventies. A review of the major policy issues provides a setting for assessing the success of the modelers and for pointing to the problems to be faced in the next decade.

Keywords. Energy models; energy policy; model assessment; energy modeling forum.

## INTRODUCTION

My charge in these opening remarks was to overview energy modeling, covering the state of the art, the use of energy models, and the problems that occupy center stage in energy policy making. This is a broad mandate, more than I could hope to cover in the time available. Fortunately, this conference will provide a rich sample of the range of existing energy models. And for those interested in a more comprehensive summary of energy models, we are indebted to my colleagues, Alan Manne, Richard Richels, and John Weyant, for their excellent survey article in a recent issue of Operations Research.<sup>1</sup>

Faced with the competition, the best use of my time at the start of this conference is to examine the applications of energy models. Speaking from the perspective of my experience in the United States, I would like to step back from the discussion of technical

modeling problems, with the focus on the models, to describe where energy policy models, particularly large-scale models, are used, how a modeler perceives the policy problems that confront energy decision makers, and how the models have adapted over time, with varying degrees of success, to meet these problems. These introductory remarks on the uses of energy models may help motivate and set in context our many sessions over the coming days.

This is a propitious time for examining energy policy and energy models. Spurred by events familiar to us all, we have seen over the last several years, a great deal of work in energy modeling and its applications to energy policy problems. Following the disruption of the world oil market in 1973, there was an explosion of analyses, including the development and use of many energy models, focused on helping decision-makers deal with energy policy problems. The results of that burst of activity were summarized

recently in a remarkable sequence of more or less independent studies of energy policy and energy problems: Energy Future, by Stobaugh and Yergin<sup>2</sup>; Energy in America's Future, by Schurr et al.<sup>3</sup>; Energy: The Next Twenty Years, by Landsberg et al.<sup>4</sup>; Energy in Transition, by Brooks et al.<sup>5</sup>.

You may be familiar with a few of these volumes. The first, Energy Future, a national bestseller in the United States, was edited by two colleagues from Harvard University, Robert Stobaugh and Daniel Yergin. The second, Energy in America's Future, was written by a team led by Sam Schurr at Resources for the Future in Washington, D.C. The third, Energy: The Next Twenty Years, was prepared by a Ford Foundation sponsored study group of which I was one of twenty members. And the fourth, Energy in Transition, which preceded the other three in execution if not publication, is the product of the Committee on Nuclear and Alternative Energy Systems, chaired by Harvey Brooks and Edward Ginston, of the United States National Academy of Sciences.

These four volumes are remarkable because of consensus in their findings about the state of energy policy making and policy problems in the United States. This consensus provides a starting point for addressing the state-of-the-art of energy models indirectly by surveying the state-of-the-question in energy policy analysis. We can begin by summarizing the conventional wisdom, as I see it, held in common in the four studies which are representative of the mainstream of recent analysis in the United States.

For convenience in summarizing this conventional wisdom on energy policy, I will borrow seven statements from Energy: The Next Twenty Years, the seven key realities of the energy situation. These seven realities of the energy situation must be recognized and their challenges met if we are to move forward in the United States and in our relationships with the rest of the world.

The world is not running out of energy.

Every responsible analysis recognizes the abundant sources of energy available to the United States and the world. But for many years the available supplies of energy will be increasingly expensive to obtain and difficult to use. The problems are not in absolute scarcity but rather in how to make energy available economically.

Middle Eastern oil holds great risks but is so valuable that the world will remain dependent on it for a long time to come. A group at an international institute such as IIASA, concerned with the international dimensions of energy problems, may find nothing remarkable in this observation, which is so obvious as to be a commonplace. But this long-term dependence on Middle Eastern oil is still not accepted by many policy makers in the United States. Our most prominent official policy theme has been energy independence. Still daily we hear discussions of how to free ourselves from Middle Eastern oil. The prevalent view of the analysts, that this independence is an illusion, is only slowly seeping into the mainstream of energy policy making.

Higher energy costs cannot be avoided but can be contained by letting prices rise to reflect them. As you know, the United States has been unwilling to recognize and confront the consumer with the increased costs of energy that resulted from the turmoil in the world oil market. Our national policy has been directed at keeping domestic prices below world prices. The new conventional wisdom calls for facing the adjustments that are inevitable by removing the domestic barriers that may cost us more in the long run.

Environmental effects of energy use are serious and hard to manage. Until recently, environmental impacts were thought to be controlling, that they would dictate the character of U.S. energy supply development, primarily by exclusion. But every careful analysis of the problems denies this view. We find that for most environmental problems, at least those critical over the next two decades, the difficulty is absorbing the costs of controlling

environmental effects. These costs will be high, and it will be important to mitigate damage to the environment, but the costs need not be so high as to preclude the development of indigenous energy supplies.

Conservation is an essential source of energy in large quantities. This is the main theme of Energy Future, by Stobaugh and Yergin. The United States came to the conservation heresy rather slowly, starting with the doctrine of the absolute need for a growing level of energy usage. However, many analyses and the evidence of a few years have created the new orthodoxy of energy conservation. Energy saving now has a central place in U.S. energy policy.

Serious setbacks and surprises are certain to occur. One of the most impressive common elements of these four studies is the optimism over the long-run, defined as the turn-of-the-century and beyond, when many choices could be available to us, compared to the striking pessimism about what can be done in the short-run. We are now in a very precarious position, particularly because of the vulnerability of our oil supply. It is almost certain that this problem will get worse before it gets better.

Sound R&D Policy is essential but there is no simple, technical fix. Again, it may seem surprising at IIASA to see much of U.S. energy policy debate in the past centered on the merits of alternative proposals for the quick fix. By now, most analysts agree that the development of many new energy technologies will be necessary but not sufficient for solving our energy problems.

#### ENERGY POLICY AND POLICY MODELS

This is the core of the conventional wisdom in the United States, at the end of the seventies, after the intense amount of effort that went into both energy policy analysis and large-scale modeling for energy policy analysis. What can we say about how modeling affected the formation of

these opinions or provided the logical support for the policy conclusions. I will treat these questions by summarizing the seventies and anticipating the eighties through a series of more detailed issues. This is a selective chronology of the use and development of large-scale energy policy models in the United States and, in part, an indictment of the failure of those efforts as we look to the problems before us.

#### Allocation and Shortages

The first analytical and policy response to the dramatic disruption of oil markets, in 1973 and 1974, was to commission a large-scale, intensive, and accelerated effort to develop the capability for central management of the U.S. energy system. The charge was for the central government to allocate supplies and manage the effects of oil shortages. That effort was a dramatic failure. I suggest that we should not be surprised at this failure. Central management of the U.S. energy system is impossible during periods of emergency. Certainly large-scale modeling efforts have been of no help.

The data requirements are prohibitive. Data are not available at the level of detail required for either the analysis or the execution of management control. Most likely, the effect of the emergency is to change the system so much--e.g., change driving and vacation plans--that we cannot identify the data needed. Even if the data were available in principle, they would never be available in time to make decisions.

It is remarkable how much effort has been spent on developing large models that purport to be able to manage an emergency in the U.S. oil economy, usually by controlling refineries through the distribution of oil and the regulation of refinery yields. The idea has a surface appeal, particularly to a modeler. Unfortunately, true optimization and detached central management of the U.S. oil system is beyond the state-of-the-art. I attribute the repeated attempts to construct such models to the short tenure of the unfortunate government officials responsible for allocation programs during emergencies. Since

the job is impossible, model or no, turnover is rapid and we lose the experience and knowledge that a large-scale modeling system won't help. During the tranquility between the chaos of emergencies, the real life data problems seem tractable and hope springs eternal. Few of us have a history of first trying to develop such models; then, counseling against them; and, finally, tiring of the discussion. With each succeeding emergency, however, our ranks grow.

#### Price Controls

The second major focus of U.S. energy policy centered on dealing with higher prices and the effects of the price controls imposed by the U.S. Congress. Modelers generally find price controls a great inconvenience. We have a good theory of the operation of unfettered competitive markets, without price controls, and poorer theories about how the system functions in the presence of price controls.

The administrative control of prices is a divisive issue. There is no political consensus about the continuation of price controls or the associated transfer of income. The modelers have been helpful, however, in showing how controls affect the predictions of their models. Controls depress domestic supply and expand demand. Unlike the case in the analysis of allocations and shortages, models have played a role in describing for policymakers the implications of removing price controls. It is our misfortune that the improved understanding that flowed from the analysis did not lead to a policy consensus. The models showed that the certain costs of decontrol come early, and the uncertain benefits come much later. The models helped to clarify the gains of the winners and the sacrifices of the losers, but the models have not helped resolve the conflict in values.<sup>6</sup>

#### Import Reduction

Almost simultaneously with the consideration of the effects of high prices, the United States turned its attention to the challenge of oil import reduction. Project Independence and the

analysis of means for reducing oil imports dominated policy analysis. In retrospect, this was a great mistake in formulating the question and, therefore, in formulating the policy models.

Having seen our economy disrupted because of the turmoil in the world oil market, we assumed that we would avoid future problems if we could only reduce the level of imports. A great deal of modeling coin was spent on this problem. The Project Independence Evaluation System (PIES) model (the name itself identifying its objective) and its many descendants operated by the Department of Energy, for instance, were essentially large accounting systems for tracing out the import effects of almost any energy policy.

The models showed early that achieving complete autarky would be difficult at best. And our political process has certainly shown that independence won't come soon; energy independence for the United States would be so costly that we are not likely to achieve it.

Unfortunately, the pursuit of this mistaken objective consumed seven years of analytical effort, seven years of our political energy, and the process is still not complete. Most analysts now see energy independence as unattainable. More important, most analysts recognize the reality of energy interdependence. No one country, particularly the United States, can absent itself from the problems energy scarcity creates. It was a mistake to assume that import reduction was in any meaningful way a solution to our energy problems. Modelers were central in identifying that the goal could not be achieved. But modelers contributed little to seeing the goal as an illusion.

#### Environmental Costs

Models are playing an important role in the conduct of environmental cost-benefit analyses in the United States. Coal In Transition, for example, was a major study of the Energy Modeling Forum which compared a dozen different models developed for analyzing coal development in the United States. These models emphasize the environmental trade-offs



involved in large-scale coal use. One of these models, developed by ICF Inc., was used by the Federal Regulatory Analysis Review Group, the Federal Office of Management and Budget, and the Environmental Protection Agency to analyze the regulations for new source performance standards in the United States. It is now quite ordinary to use large-scale models to examine the costs of restrictions on emissions. For the most part, these modeling efforts tend to demonstrate that environmental problems have reasonable solutions, to show that environmental effects are costs to be accommodated, not constraints which restrict development.

#### Investment Capacity and Employment Effects

In 1974, there was a widespread belief in the United States that over the then coming decade employment constraints or investment capacity limits would prohibit the transition to a much greater reliance on domestic energy supplies. Although this specter of bottlenecks and scarce investment reappears from time to time, early modeling efforts (e.g., in PIES) quickly disposed of this issue. Using no more than detailed accounting, which is a strength of large-scale models, we calculated the investment and employment demands of an aggressive domestic energy expansion. By comparing such energy forecasts with the predictions of macro-economic models of the full economy, it was easy to show the growth in the energy sector, although expensive and significant, would not be so dramatic as to substantially dominate the growth of the economy. In relative terms, the future requirement would not be much greater than those of the past.

This was an important result at the time; it is an example of one frequent contribution of modeling: to quickly isolate non-problems. Investment capacity and employment bottlenecks quickly became non-problems in policy-making discussions; and, in my judgment, correctly so.

#### Energy and the Economy

After we considered the problems of

the very short run--import reduction, shortages, price control, environmental constraints, the demand for investment--our analyses turned to longer-run questions such as economic growth. At the start of the decade, all but a few specialists assumed that there was an iron link between energy and economic growth. But by the end of the seventies, heresy had moved to become conventional wisdom: economic growth can be achieved even in a world of scarce energy resources.

Energy modelers deserve much of the credit for this dramatic and important change in policy thinking. Hudson and Jorgenson, Manne, Nordhaus, Koopmans, and many others, with much of the work begun as part of the energy project here at IIASA, were at the core of the analysis and the debate that changed our view of the role of energy in the economy.<sup>8</sup>

The modelers articulated the question better than anyone else, and they produced the critical analyses which demonstrated that we could have economic growth even if we did have expensive energy. The key facts, as we know, were the small value share of energy expenditures in an equilibrium economy, and the high potential for substituting other factors of production for the newly scarce energy inputs. Almost all energy models and energy analyses now recognize and incorporate this energy-economy flexibility.

#### Conservation

Looking in more detail into the flexibility of energy use, we see the great potential for energy conservation. The improvement in energy efficiency is now at the core of energy policy-making. This trend has been carefully, heavily, and extensively supported by analyses with energy demand models. I, for example, have had the good fortune to chair a study group involving sixteen different energy modelers and comparing their energy demand models to isolate the long-run substitution or conservation potential. The effort has yielded an impressive data base providing powerful aggregate evidence in support of the sometimes more anecdotal analyses of energy conservation enthusiasts. The models confirmed, as early as 1974, what

we all now believe: there is a tremendous potential for improving energy efficiency in the United States.

#### Depletion of Supply

So far in this summary the modelers and models have fared well. Only in the analysis of allocation and shortages was there a complete flop. The failure in studying import reductions stemmed more from the formulation of the question than from the answers that we found with the models. But now the story turns for the worse.

A central problem for all energy policy makers is to prepare for the eventual exhaustion of conventional supplies. At one extreme, in the view represented by the Club of Rome analyses, the world runs out of resources, completely and soon. Few still hold to this cataclysmic view. Within the time frame of concern, exhaustion is not the problem; rather, we face the gradual depletion of low-cost sources of energy. As I stated before, the world is not running out of energy. But we are finding it harder and harder to come up with cheap energy supplies. How much will we find? And what will it cost?

Modelers have been a very active group participating in this discussion. Models such as the SRI-Gulf model, of which you will hear more this week from Ed Cazalet, explicitly characterize the process of depletion. Such models have been useful in describing the interactions between different sources of energy supply to meet long-run energy demand. As costs rise, more and more expensive sources enter the market, with the dynamics following the theories of Hotelling. These models are good at using information about the gradual depletion of conventional supply.

Unfortunately, formal modeling has contributed very little to producing the needed information on exactly how much potential supply we have, or what the costs will be. Energy supply modeling is in a primitive state. The best theoretical models require data which no one hopes to acquire within the next decade. As a result, the models which can be and are used by everyone, including me, are based on a flimsy theory and a heavy dose of geological judgment.<sup>9</sup>

#### Income Distribution

The single greatest obstacle to forming a consensus on an energy policy for the United States has been the problem of income distribution. Because of our large level of domestic energy production, compared to our level of total energy consumption, any increase in the price of imported oil which prompts an increase in the price of related energy products produces a dramatic shift of income, not only from the United States to the foreign suppliers of oil but also from energy consumers within the United States to energy producers within the United States. The control of this transfer must be part of any national policy, and this makes energy a divisive issue.

Many energy modelers have tried to confront this problem. To date, however, I have seen nothing that amounts to a persuasive model of what happens to different consumers and producers in the face of dramatic changes in the level and mix of energy prices. The equitable balancing of income distribution effects is a central problem for US policy. Some day modelers may have something of value to contribute to the debate, but so far we have contributed precious little.

#### International Interdependence

One of the most embarrassing encumbrances for a U S participant in an international energy seminar is the legacy of failure in the United States in coming to grips with the international dimensions of energy problems. This is not to say that we have a shortage of rhetoric, that we have not built international energy models, or that we have not recognized the complaints of our allies over our large demand for imported oil. It is to say that U.S. policy-makers tend to think of the problem as one of dependence, i.e., the effect of the world oil market on the United States. The interdependence, the reverse effects of our actions, and the inability of any one country to isolate itself from the world's energy problems, have only lately come to the forefront of concern. The characterization and analysis of the many connections in the world energy markets remain as important challenges for energy modelers.

One significant underattended issue is the treatment of LDC's. I particularly look forward to the final version of the IIASA energy study because it is the first where the analysts define the "world" as the world, not the world less some region which was too troublesome to analyze. Too often this deletion includes the LDC's. We find, of course, that over the long-run, all areas of the world will have a significant impact on the balance of the world through energy supply and demand. The largest growth region is likely to be the LDC's.

Our analysis of world oil policy was in disarray again at the end of the seventies. Modelers in the United States addressed this problem intensely after the first oil emergency. We were shocked; we didn't understand what was happening, we had to explain what OPEC, a homogeneous OPEC, was doing to us. These early models usually started with something like an assumption that OPEC was a newly-formed monopoly exercising its market power to manipulate prices and production.

Several different analyses of world oil markets were produced in 1974 and 1975. These models have not, however, been analyzed to see how well they predicted the evolution of the market after 1975. The models differ significantly in their structure and predictions, so they can't all be right. And even for the one or two that I know tend to predict well, we can attribute their good performance to quirks in the models rather than to any fundamental understanding of the structure of the world oil market. This first round of analysis has been extensively surveyed.<sup>11</sup> Although they may be unsatisfactory in themselves, the early efforts spawned a second round of intense study of world oil markets.

A new working group has been formed in the United States, under the auspices of the Energy Modeling Forum, focused precisely on the evaluation of world oil market models.<sup>12</sup> This study is important for several reasons. World oil policy is a very challenging

subject for modelers to confront, dealing with an imperfect, non-competitive market. Our theories are much weaker here than for competitive markets. It's a great opportunity for methodological work. In addition, a little insight could have a tremendous impact on policy decisions throughout the world. For example, in the United States, there is no end to the justification of new energy programs on the basis of how they might affect the world oil price. The supporting arguments are based on implicit models of the world oil system, implicit models built on implicit assumptions that cry out for challenge from the explicit analyses that energy modelers could provide.

#### Energy and Security

Intimately related to the economics of world oil pricing are the political and defense problems of energy and security. The events of 1979 reinforced our awareness of the dangerous state of the world oil supply system. The central problem of oil imports is the problem of security; the vulnerability to supply interruptions is a great threat to our economic and political security. We now recognize that import reductions will not be sufficient to remove this threat. The potential for oil emergencies will be with us for the indefinite future. It is critical that we develop new characterizations of the oil market, with new policies for the United States and other countries to prepare to meet supply interruptions.

What are the costs of measure supply interruptions? How do these costs differ for different oil importing countries? What policies might mitigate the size or impact of supply interruptions? What international cooperative measures could be adopted and enforced to meet the challenges of energy vulnerability? The oil importing countries must develop answers to these questions. And modelers must urgently provide the tools needed to help produce and explain the answers.

#### ENERGY MODEL COMPARISON

During this evolution of energy policy

models and policy studies, there has been a parallel development of institutions and techniques for model verification, validation, and ventilation. Verification is the demonstration that a model works as intended, that coding and data errors have been eliminated. Validation is the demonstration that a model reflects the essence of the system modeled, that the model predicts well. Ventilation is the explanation of how a model works, the exposure of critical assumptions and structure sufficient to make the model transparent to the scrutiny of the user.

Model developers and model users have been working on the ventilation phase to make large-scale energy models more accessible to policy-makers, and, in the process, to improve the quality of the models. These efforts at ventilation, at building bridges between the model developers and users, have been most visible in the work of the Energy Modeling Forum, the newly formed Utility Modeling Forum, and the MIT Model Assessment Laboratory. In their own ways, these groups analyze the content of models and how the models might be used to improve policy making. A clear lesson of these studies is the importance of focusing on the policy decisions, the policy questions to be addressed with the model. No model can deal with all questions about any system; few questions would not yield a little to some modeling. And some problems can be dealt with only through models.

As an example of an extreme case where models will be indispensable, but beyond the reach of validation, consider the decision we now face regarding the disposal of waste from nuclear power plants. It is clear that this decision is going to be based on a model of how the depository will operate over thousands of years. No one is going to conduct an experiment of this process; more likely, lawyers in a courtroom will decide whether or not some particular technical model of the process is superior to another. Those lawyers are going to have to understand some of the technical details; they will also have to

understand how the model fits into people's perceptions of the problem; and they will have to explain their judgment to many people who know and care little about the details of large-scale modeling. Much of the work now under way to develop our ability to ventilate models will help in this and more prosaic applications of energy models. One of the success stories of energy modeling is this gradual improvement in our ability to make energy models accessible and useful.

#### CONCLUSION

Energy is pervasive in our economies. It affects all that we do. From the perspective of the economic and political policy-makers, we have seen over the last seven years energy emerge from the attention of a few specialists to attention at the center of public and private decisions. Everyone now feels obliged to be knowledgeable about energy policy and energy analysis and, indirectly, energy modeling. From the perspective of the energy analyst, the changes of the last several years have moved energy problems to the core of the most difficult analytical issues confronting society. In large measure, energy policy analyses merge with the study of inflation, macro-economic management, income distribution, and the balance of trade. With the possibility of continued disruptions of oil markets, we find energy modelers wrestling with the problems of defense and foreign policy. While there will always be some special features, energy policy modeling will be more and more just policy modeling; the new challenges are far greater than the old.

We have a new perception of the critical issues as we anticipate the eighties. We will see energy policy analysts addressing less stable, less long-term, more dramatic issues dealing with energy and security, market manipulations, and international interdependence. Energy models have helped us organize our understanding of the many choices we have over the long run. Modelers must now turn their attention to describing the dangers and opportunities that are here today.

I am sure that this conference will be part of this new focus. Thank you.

NOTES

1. Manne, A. S., R. G. Richels, and J. P. Weyant, "Energy Policy Modeling: A Survey," Operations Research, Volume 27, Number 1, January 1979.
2. Stobaugh, R. and D. Yergin, Energy Future, Random House, New York, 1979.
3. Schurr, S. H., et al., Energy in America's Future, Johns Hopkins University Press, Baltimore, 1979.
4. Landsberg, H. H., et al., Energy: The Next Twenty Years, Ballinger, Cambridge, 1979.
5. Brooks, H., et al., Energy in Transition: 1985-2010, Committee on Nuclear and Alternative Energy Systems, National Academy of Sciences, Washington, D.C., 1979.
6. The Energy Information Administration operates several models which include descriptions of energy price controls; see Models of the Energy Information Administration, Department of Energy, Washington, D.C., May, 1978.
7. The Energy Modeling Forum (EMF), located at Stanford University, coordinates a series of working groups conducting comparative studies of the uses of energy models. The report on coal models, Coal in Transition, September, 1978, is available from the EMF headquarters.
8. The EMF conducted a comparative study of models of energy and the economy in Energy and the Economy, September, 1977. The same basic analysis also played a prominent role in the supporting work for Energy in Transition, above.
9. See W. W. Hogan (ed.), Energy Information: Description, Diagnosis, and Design, Institute for Energy Studies, Stanford University, 1978, for a discussion of the data and modeling problems in describing energy supply.
10. An interesting description of the incidence of benefits and costs from oil price control is found in Arrow, K. J., and J. Kalt, "Regulating Energy Prices: The Case of Oil," Kennedy School of Government, Discussion Paper Series, June 1979.
11. See Fischer, D., D. Gutely, and J. F. Kyle, "The Prospects for OPEC: A Critical Survey of Models of the World Oil Market," Journal of Development Economics, Volume 2, Number 4, 1975.
12. The EMF working group on international oil markets began work in 1980 under the chairmanship of Eric Zausner.

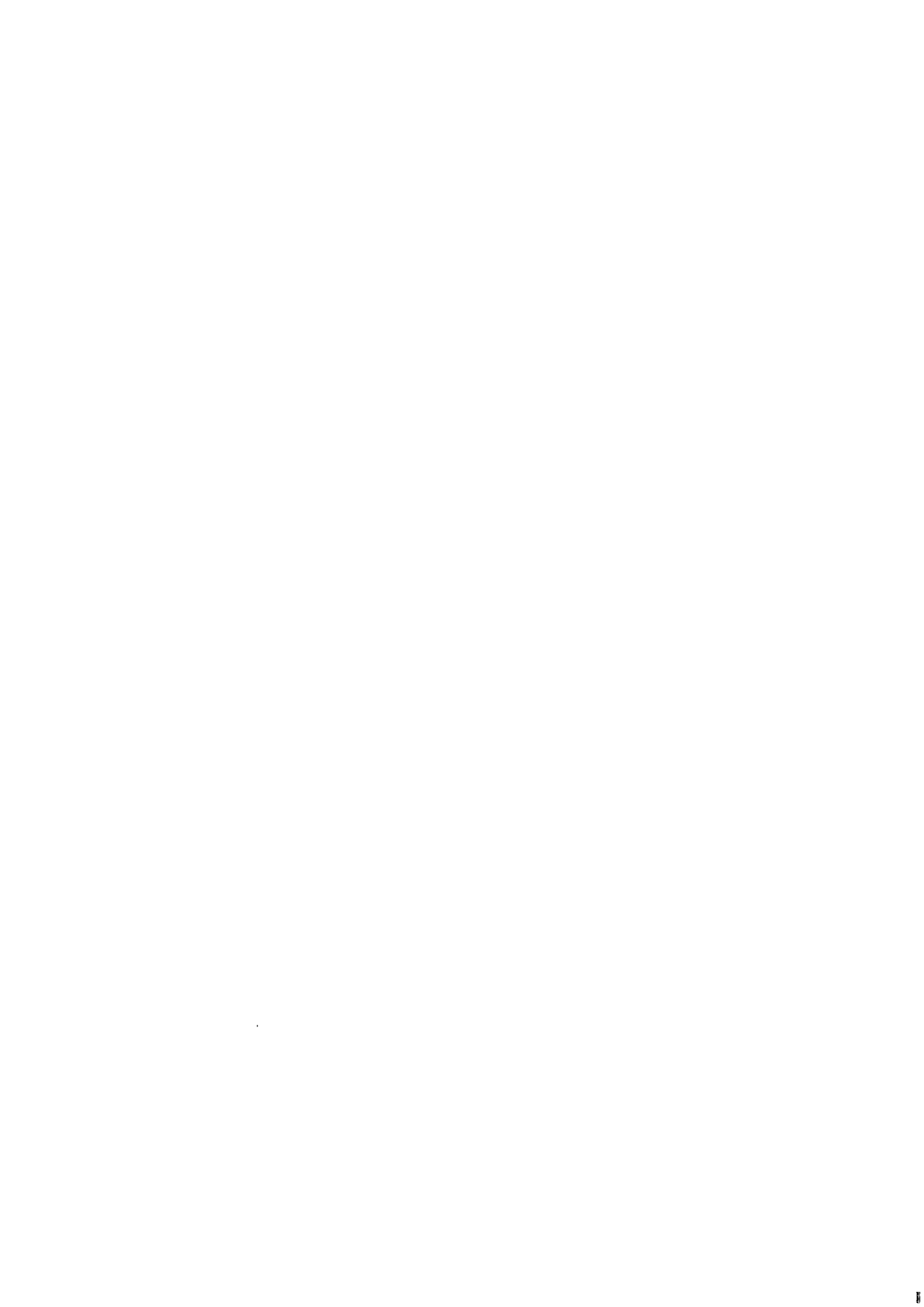

## *Session 1*

# **PROBLEMS IN EXPLORING ENERGY DEMAND AND CONSERVATION**





# PROBLEMS IN EXPLORING ENERGY DEMAND AND CONSERVATION

**W. Häfele**

*International Institute for Applied Systems Analysis, A-2361 Laxenburg, Austria*

## ABSTRACT

Different levels of energy demand are described, and the notion of negentropy is introduced to clarify the distinction between the thermodynamic *conservation* of energy and the *consumption* of highly-ordered (high quality) forms of energy. The substitutability of energy, labor, capital, and know-how in producing services is discussed. The actual mix that we use depends more on our culture and its evolution than on physics. Three different approaches to assessing energy demand are described, the econometric approach, the scenario approach, and an approach based on projected settlement patterns and associated energy consumption densities. Finally, some of the more salient insights gained from IIASA's set of global energy models are presented. Of particular interest are the economic implications of an extreme energy conservation strategy where primary energy requirements reach only 16 TWyr/yr in 2030.

## KEYWORDS

Developed regions; developing regions; energy conservation; global energy demand; long-range energy demand; negentropy.

## THE NATURE OF ENERGY DEMAND

Energy demand is a hotly-debated subject these days. When exploring related problems, it is most important to first clarify terms.

One must distinguish between primary, secondary, final and useful energy, as is illustrated by Fig. 1. Primary energy, for example, is crude oil or coal. In order to obtain a readily usable form of secondary energy, a conversion process is needed, such as takes place in refineries or in electrical power stations. Gasoline at the mouth of a pipeline or electricity at the bus bar of a grid are such secondary energy forms. At the place of consumption, that is, after this energy has been transported to the user, it becomes final energy. Gasoline at the filling station or electricity at the plug are examples. Part of that final energy is converted into useful energy in end use facilities, such as a car or a washing machine. This is the mechanical energy in the car or the heat acting on the laundry in the washing machine.

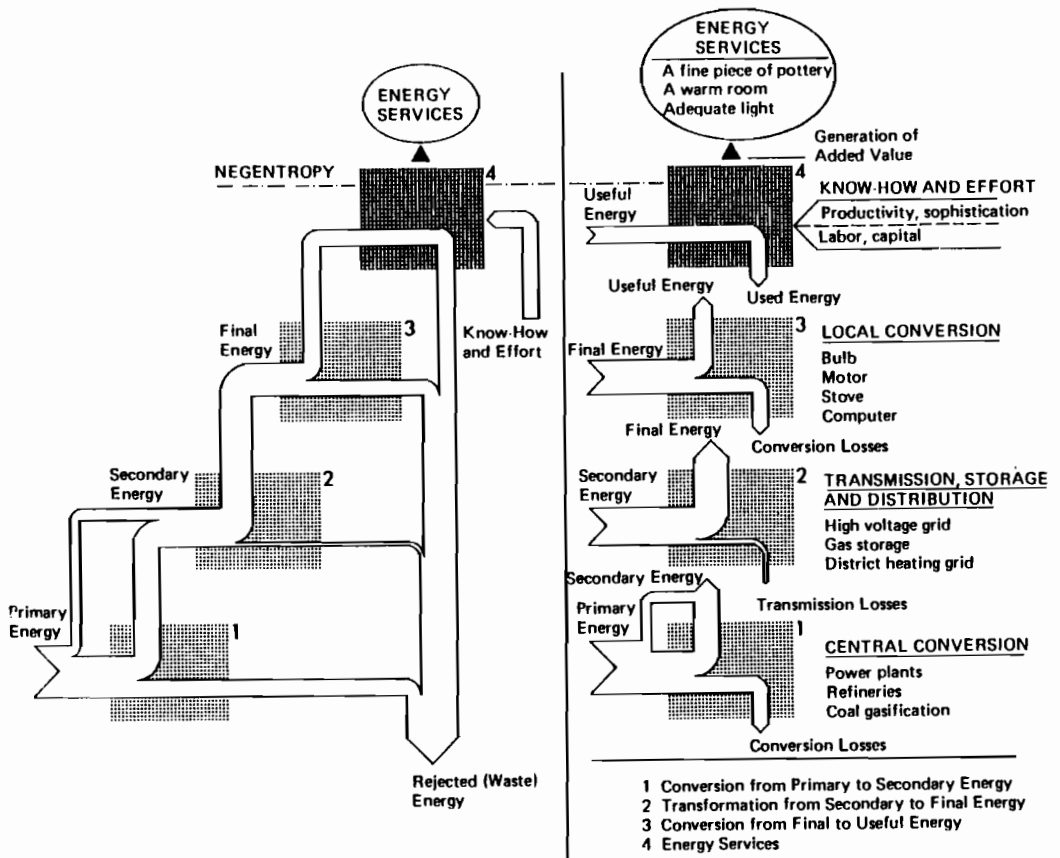

Fig. 1. Energy conversion and use.

It is well known that energy cannot be consumed. Indeed, as indicated in Fig. 1, all conversion losses and waste heat add up; and the total rejected energy exactly equals the primary energy input to the process. What is then consumed is the quality that goes along with energy, i.e., its negative entropy increments, for which no law of conservation holds. We call this negentropy. Engaging energy services by availing oneself of a warm room or a readable book means to consume negentropy.

It is useful to reflect on the fact that services created by the use of energy are balanced by services that are derived from the use of capital, labor, and know-how. It is know-how that is required, for example, when switching from a steam locomotive to a Diesel engine, by which some 80% of the energy requirement of the steam engine can be saved. The mutual substitutability of services is a notable general phenomenon. The notion of services, as it is addressed here, is a very abstract and immaterial quantity. One may relate these services to a generalized form of information, referring to them possibly as order states (Energy Systems Program Group of IIASA, 1980a).

The way in which the services derived from energy, capital, labor and know-how are actually divided among themselves is a matter of contingency. That is to say, the partitioning is not the outcome of a physical process, but reflects a certain state

in the intellectual, cultural and societal evolution. It is for this reason that, in the final analysis, energy demand and consumption are *political* issues, in the most profound and best sense of the word.

Evolution takes time. Yes, energy conservation is possible; it is not an invention of our time but is observed to have occurred also in earlier centuries, and at a stunning regularity. This is exemplified by Fig. 2, which gives the second law efficiency for three specific conversion processes in a logarithmic scale. Note that the time scale extends from 1700 to 2000 and beyond.

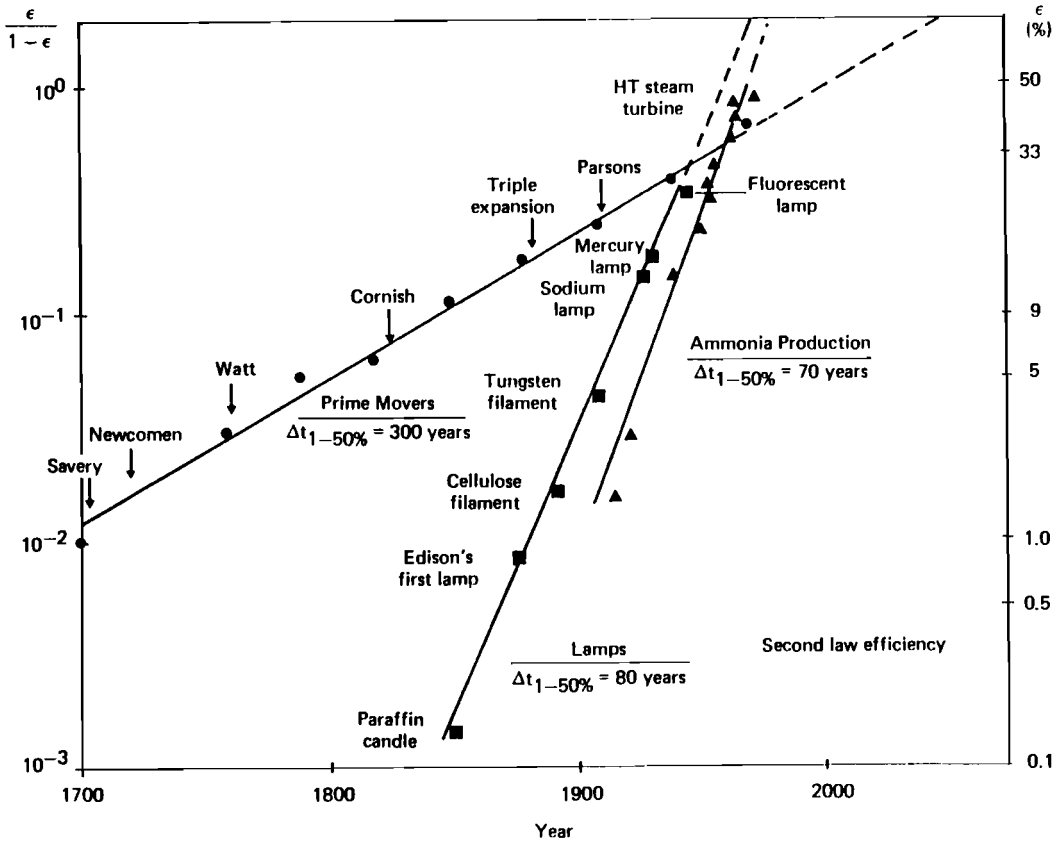

Fig. 2. Historical trends in efficiencies.

### THREE APPROACHES TO ASSESSING ENERGY DEMAND

If we assume that the services derived from energy, capital, labor and know-how are mutually substitutable we expect that a common denominator between these services exists. But there is no strictly thermodynamic nor a more general physical conception of such a denominator, and so money has taken on this role. This works in the case of a perfect equilibrium between supply and demand, where the mere fact that such an equilibrium exists serves as a translator. There, the many informational dimensions of a real-world market situation in a given society, characterized by a certain culture and technology, are translated into a one-dimensional scalar, i.e., the relative price.

Figure 3 tries to capture the idea for noneconomists. B is a production function; K stands for capital, L stands for labor, and P for price;  $\lambda$  is the well-known Lagrangian multiplier. Starting out from these determinants, a vast and prominent field of econometric evaluation of energy demand appears to have developed. There is the notion of elasticities,  $\epsilon$ , for example, formulated as ratios of changes in percent of determinants. For instance, the change in the level of demand for energy y as a function of x is defined as  $dy/y/dx/x$ . The basic idea is that such quantities can be extracted from time series, using a variety of sophisticated methods.

$$B = B(K,L) \rightarrow \text{MAX.}$$

$$dB = \left( \frac{\partial B}{\partial K} dK + \frac{\partial B}{\partial L} dL \right) - \lambda \left( p_K dk + p_L dL \right) = 0$$

$$P_K = \frac{1}{\lambda} \frac{\partial B}{\partial K} \qquad P_L = \frac{1}{\lambda} \frac{\partial B}{\partial L}$$

$$\frac{P_K}{P_L} = \frac{\frac{\partial B}{\partial K}}{\frac{\partial B}{\partial L}}$$

Fig. 3. Prices in equilibrium.

The shape of the demand function described in Fig. 4 is that used by W. Nordhaus(1976) while he was at IIASA. The elasticities  $\beta$  and  $\gamma$  are supposed to be known; P is the price, Q is the demand, and Y the per capita income. The demand function considered is a lagged one. The given demand is determined by the prices of the preceding five years and the per capita income of the previous two years. Success of such econometric models largely depends on the quality of the data base of the time series, so that demand and supply do balance and are in no way artificially constrained by regulations.

$$Q \sim P^\beta \cdot Y^\gamma$$

$$Q_{t,i} = e^{a_i} \cdot \prod_{\theta=0}^4 P_{t-\theta,i}^{0.2\beta} \cdot \prod_{\theta=0}^1 Y_{t-\theta,i}^{0.5\gamma}$$

i: e.g. VARIOUS  
REGIONS

Q = DEMAND  
P = PRICE  
Y = INCOME PER CAPITA  
 $\beta, \gamma$  = ELASTICITIES

Fig. 4. Demand functions.

Inherent to this approach is the regression to elasticities, the idea that elasticities change more slowly than the actual variables of the demand function. In most cases, this assumption is fair for a limited time period. For longer time horizons, say five years or beyond, it is not appropriate to assume a relative constancy of elasticities, especially if the infrastructure underlying the balance of demand and supply is changing or is about to be changed. In this case, one has to go back to accounting of energy end uses by simulation, in order to obtain the information otherwise available from elasticities and prices. This is done by accounting of energy end uses in physical and engineering terms.

The procedure works for the scenario writing approach, a way of simulating future economic conditions and lifestyles as they are conceived. The total demand for energy resulting from the scenarios can be accounted for in this fashion. It is generally felt that such an approach permits one to cover wider time horizons, of perhaps as many as 50 years. Here the constraining problem is internal consistency. It is possible to force consistency in by way of an input-output procedure, but this presupposes knowledge of how the input-output coefficients evolve over time and how to make them consistent.

At IIASA we have followed such an approach (Lapillonne, 1978) to a great extent, as is illustrated by Fig. 5. Our initial assumptions involve economic growth rates, economic structures and lifestyles. Another set of assumptions relates to technical factors, on the basis of which various end uses in the private, commercial and industrial sectors can be identified in detail, e.g., the heating requirements of a dwelling, the number of persons per car, person-kilometers, kilowatt-hours required per dollar of value added in various industrial sectors, etc. The connection between energy end uses and final energy is made via technological efficiencies, which then close the link to the various kinds of primary energy.

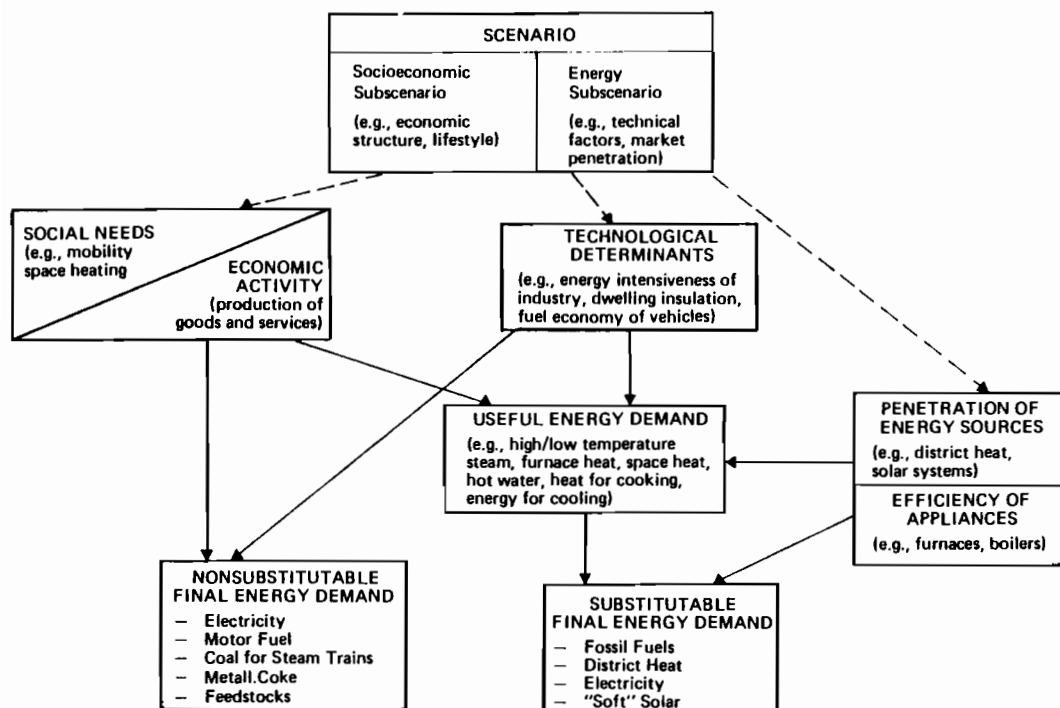

Fig. 5. The MEDEE approach.

A case in point is low temperature uses of solar power. For bigger energy systems, and not just for certain single cases, it is largely the rate of introduction of such a new technology that matters. This is often referred to as a question of market penetration rates (Marchetti and Nakicenovic, 1979). The analysis leads to a menu of final energy demands, some of which appear mutually substitutable while others are not easily replaced.

Only a few words need to be said about a possible third approach that might be taken to assess energy demand. It is radically different from the first two since it considers evaluations in space and not in time; it centers around the observation that the energy consumption density in urban areas is fairly constant. Compare Table 1 (Energy Systems Program Group of IIASA, 1980b), which shows that the population densities in different places in the world vary widely--that of New York is half that of London--but the energy consumption densities are almost the same. Even for cities in India, with a population density ten times higher than that in New York, the energy density differs only by a factor of two from the U.S. city. It seems to be the use of more urban space per person that leads to a higher per capita energy consumption. The idea is, then, to consider present or future settlement patterns in order to judge the related energy demand. At IIASA, we have pursued this approach only in one respect (Häfele, 1979), also because, obviously, more basic research is needed to make this method operational and successful. But we think it relevant as a third approach.

TABLE 1 Population and Energy Consumption Densities, 1975

Urban Area	Inhabitants (10 <sup>6</sup> )	Area (10 <sup>3</sup> km <sup>2</sup> )	Population Density (cap/km <sup>2</sup> )	Energy Consumption (kW/cap)	Energy Density (W/m <sup>2</sup> )
Tokyo-Yokohama	33	34	980	3.9	3.8
New York	19.7	35	560	11.4	6.4
London	12.7	11.4	1,100	5.2	5.7
Rhine-Ruhr	10.9	8.5	1,280	5.0	6.4
Moscow	10.6	14	750	5.4	4.1
Paris	9.8	12	820	4.3	3.5
Urban India	107.0	17.8	6,000	2.0	12.0

#### PRESENT AND FUTURE PATTERNS OF ENERGY DEMAND

At IIASA, we have found it convenient to consider seven aggregated world regions. They are explained in Fig. 6, and also used for the remaining charts.

Table 2 presents a globally-aggregated view of the use of commercial energy across various sectors. The result is 5.742 TWyr/yr of final energy. The household/service sector holds a share of 26%, the industry sector 45%, transportation 23%, and feedstocks a share of 5% of the final energy demand total. The primary energy requirement, complemented by transportation and conversion losses, totals 8.208 TWyr/yr as of 1975.

To get the full picture, however, one must take a special look at developing regions. Here, Regions IV (Latin America) and V (Africa and South East Asia) in Table 3 yield interesting information. In Region IV as much as 35%, and in Region V even 61% are based on noncommercial energy sources, such as wood and agricultural wastes. While this distribution is obviously a salient point for the supply side, it is equally significant for the end use technologies selected, since the efficiency from



-  Region I (NA) North America
-  Region II (SU/EE) Soviet Union and Eastern Europe
-  Region III (WE/JANZ) Western Europe, Japan, Australia, New Zealand, S. Africa, and Israel
-  Region IV (LA) Latin America
-  Region V (Af/SEA) Africa (except Northern Africa and S. Africa), South and Southeast Asia
-  Region VI (ME/NAf) Middle East and Northern Africa
-  Region VII (C/CPA) China and Centrally Planned Asian Economies

Fig. 6. The seven IIASA world regions.

noncommercial sources is usually very low, often much less than 5%. Therefore, a complete and new branch of potential future energy demand is expected to evolve somewhat independently of the lines governing the demand in developed countries.

At IIASA, we have taken great pains to build two scenarios for all the seven world regions, over the period 1975-2030. The two scenarios, called Low and High, are not meant to be extremes in either direction, but are assumed to cover a middle ground. They take into consideration not only energy demand but also, with particular emphasis, energy supply, world oil trade, energy investments and macroeconomic monitoring; this means that a full set of models had to be built and operated (Basile, 1980). For energy demand calculations, the second among the three approaches described is applied here, by way of a model called MEDEE-2. The results for per capita final (commercial) energy use are given in Table 4.

In Regions I and III, corresponding to the OECD countries, we have an almost zero growth of the per capita demand for final energy in the Low scenario. In the High

TABLE 2 Global Commercial Energy Use in 1975 (GWyr/yr)

	Coal	Oil	Gas	Elec.	Distr. Heat	Hydro <sup>a</sup>	Nuclear <sup>a</sup>	Total
Transportation	45	1,272	0	16	0	0	0	1,333
Industry <sup>b</sup>	729	722	620	359	170	0	0	2,600
Household/Service	285	547	382	249	48	0	0	1,511
Feedstocks <sup>c</sup>	0	298	0	0	0	0	0	298
Final energy	1,059	2,839	1,002	624	218	0	0	5,742
Transportation and distribution losses	38	0	97	91	10	0	0	236
Secondary energy	1,097	2,839	1,099	715	228	0	0	5,978
Inputs to elec. <sup>d</sup> and distr. heat	1,069	534	359	[-734]	[-277]	497	119	1,567
Other losses <sup>e</sup>	91	455	49	19	49	0	0	663
Primary energy	2,257	3,828	1,507	0	0	497	119	8,208

<sup>a</sup> Hydro and nuclear generated electricity are given in terms of fossil primary energy input equivalent.

<sup>b</sup> Industry includes agriculture, construction, mining, and manufacturing.

<sup>c</sup> Feedstocks include nonenergy uses of fuels. (Natural gas used to make fertilizers is included in "industry".)

<sup>d</sup> The inputs to electricity generation are primary equivalents of the sources; these figures include primary sources used in cogeneration facilities. (The -734 figure under "elec." represents the secondary (busbar) electricity generated from the several primary sources.)

<sup>e</sup> "Other losses" include all primary to secondary losses, e.g., primary transport, oil refining; they also include bunkers (210 GW of oil in 1975)--energy used in international shipments of fuel.

SOURCE: Energy Systems Program Group of IIASA (1980c).

scenario, North America has the highest energy consumption, but even there the per capita requirement rises by less than 50% in the next 50 years! Region II, covering the Soviet Union and Eastern Europe, is the second largest consumer. The developing world appears in sharp contrast to the so-called North of the globe; they show higher growth rates, but even after 50 years, significantly lower per capita consumption values.

For reason of completeness, the world's demand for primary energy in the two scenarios should be mentioned: it totals 36 TWyr/yr in the High scenario and 22 TWyr/yr in the Low scenario.

We have found it useful to evaluate these scenarios by several indicators. So, we analyzed what the assumed evolutions in the balance of energy demand and supply--which had been obtained by projections of energy end use in physical terms--could ultimately mean with a view to elasticities. We reversed the order, having elasticities serve as output rather than as input, and thus as indicators. Table 5 gives the related results. It is interesting to realize how the developed regions might afford a low elasticity, while the elasticity of the developing regions may be



TABLE 3 Energy in Two Developing Regions, 1965 and 1975

	1975	
	Total	Rural Fraction
Population (10 <sup>6</sup> )		
Region IV (LA)	319	0.40
Region V (Af/SEA)	1,422	0.78
	<u>Total</u>	<u>Share of Agric.</u>
GDP (10 <sup>9</sup> \$)		
Region IV (LA)	340	0.12
Region V (Af/SEA)	340	0.36
	<u>1965</u>	<u>1975</u>
Total primary energy (incl. noncommercial) (TWyr/yr)		
Region IV (LA)	0.278	0.447
Region V (Af/SEA)	0.442	0.672
Share of oil		
Region IV (LA)	0.46	0.51
Region V (Af/SEA)	0.15	0.24
Share of noncommercial energy <sup>a</sup>		
Region IV (LA), of which	0.35	0.24
Wood	0.28	0.18
Agricultural wastes	0.07	0.06
Region V (Af/SEA), of which	0.61	0.51
Wood	0.41	0.34
Agricultural Wastes	0.20	0.17

<sup>a</sup>Noncommercial energy is expressed here in terms of its calorific heat content and not as a replacement-equivalent of fossil fuels. The efficiencies of use of noncommercial and commercial fuels are quite different (see text). SOURCE: Energy Systems Program Group of IIASA (1980c).

TABLE 4 Per Capita Final (Commercial) Energy Consumption, Two Scenarios, 1975 to 2030 (kWyr/yr,cap)

Region	Base	High Scenario		Low Scenario	
	Year	2000	2030	2000	2030
I (NA)	7.89	9.25	11.63	7.95	8.37
II (SU/EE)	3.52	5.47	8.57	4.98	6.15
III (WE/JANZ)	2.84	4.46	5.70	3.52	3.90
IV (LA)	0.80	1.75	3.31	1.28	2.08
V (Af/SEA)	0.18	0.42	0.89	0.32	0.53
VI (ME/NAF)	0.80	2.34	4.64	1.76	2.46
VII (C/CPA)	0.43	0.93	1.87	0.64	0.93
World	1.46	1.96	2.86	1.58	1.83

NOTE: The figures are average rates of final energy use, averaged over the population and the year. The figures for Regions I through VII result from the many assumptions and calculations for each of the scenarios, using the MEDEE-2 model; the figures for Region VII are based on SIMCRED model runs.

TABLE 5 Final Energy-GDP Elasticities,  $\epsilon_f$ , 1950-2030

A. High Scenario

Region	<u>Historical</u>				
	1950- 1975	1975- 1985	1985- 2000	2000- 2015	2015- 2030
I (NA)	0.84	0.31	0.43	0.53	0.48
II (SU/EE)	0.68	0.59	0.58	0.52	0.53
III (WE/JANZ)	0.84	0.77	0.65	0.58	0.51
IV (LA)	1.21	1.07	1.01	0.97	0.90
V (Af/SEA)	1.42	1.20	1.08	1.05	1.01
VI (ME/NAf)	1.17	1.12	1.07	0.95	0.81
VII (C/CPA)	1.53	1.10	1.02	1.02	0.96
World	0.87	0.69	0.73	0.78	0.77

B. Low Scenario

Region	<u>Historical</u>				
	1950- 1975	1975- 1985	1985- 2000	2000- 2015	2015- 2030
I (NA)	0.84	0.24	0.38	0.53	0.46
II (SU/EE)	0.68	0.54	0.57	0.50	0.41
III (WE/JANZ)	0.84	0.67	0.64	0.60	0.49
IV (LA)	1.21	1.10	1.03	0.95	0.88
V (Af/SEA)	1.42	1.19	1.12	1.14	1.06
VI (ME/NAf)	1.17	1.21	1.11	1.01	0.93
VII (C/CPA)	1.53	1.02	0.98	0.99	0.90
World	0.87	0.64	0.73	0.79	0.74

consistently higher. The results reflect that it takes more energy per dollar value added to build an economic infrastructure than to operate and improve it.

It then makes sense to examine directly the ratio of final energy to gross domestic product (as is illustrated in Fig. 7). Such a representation should reflect a certain internal consistency and steadiness of the underlying assumptions, and help us judge the nature of the energy demand projected in the regions.

The figure depicts the High scenario results. The plot for the Low scenario is essentially the same, except that there the curves do not reach the highest values on the abscissa. The point of this graphic is obviously a maximum of energy-GDP ratios that is reached for incomes in the order of \$2,000 per capita (all in 1975 \$). Note also the partial symmetry of the curves. For investigations of the more distant future, it may be instructive to reflect on such integral features which characterize the two scenarios.

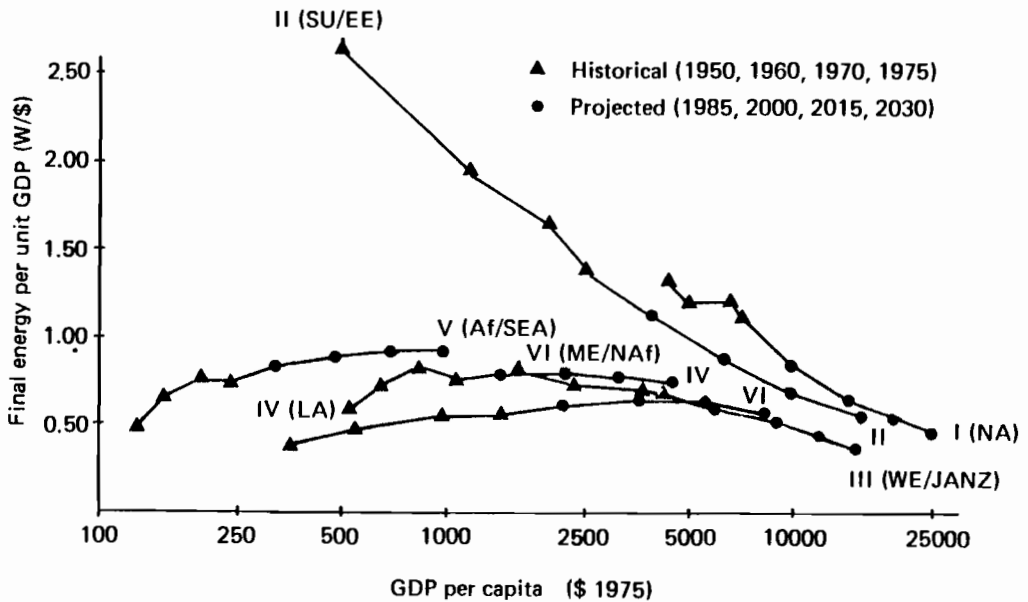

Fig. 7. Energy intensiveness in different world regions (High scenario).

#### EXTREME ENERGY CONSERVATION

We observed earlier that the actual partitioning of services derived from energy, capital, labor and know-how is of a contingent nature and not an outcome of a physical process. Therefore, it is possible in principle to conceive scenarios of extreme energy conservation. Balancing supply and demand can be achieved also in rather extreme ways, either by going extremely to the supply end, which means facing all the troubles of enhanced supply, or by going extremely to the demand end, which means facing all the troubles of enhanced conservation. The question is, then, what is extreme?

In our IIASA studies, we therefore conceived a so-called 16 TW scenario, based on a proposal by Colombo and Bernardini (1979). 16 terawatts by the year 2030 means that the 8 billion people then assumed to live would have 2 kWyr/yr per person, the same global per capita average as today. Any increase in the per capita energy demand in developing countries would therefore require decreases in the demand in developed countries. It is along such lines that, for the year 2030, target values of primary energy of 8 kWyr/yr,cap in Region I and 3.2 kWyr/yr,cap in Region III were obtained. The corresponding 1975 values are 11.2 kWyr/yr,cap in Region I, and 4.0 kWyr/yr,cap in Region III.

It is crucial that such decreases be made consistent with the assumed positive GDP growth of 2%/year. To that end, a number of assumptions had to be made, each of which is somewhat arbitrary, to ensure that the overall brackets of decrease in energy demand and of increase in GDP are met. Such assumptions relate to the structure of an economy, as well as to the lifestyle.

For the Low scenario, only a slight adjustment to the assumed GDP growth rate of 2%/year was necessary. The situation is entirely different for the 16 TW scenario. In Table 6 such major assumptions are compared with those of the Low case. It

TABLE 6 Major Assumptions for the 16 TW Case, Compared to the Low Scenario

	Region I (NA)			Region III (WE/JANZ)		
	Base	Low	16 TW	Base	Low	16 TW
	Year	Scenario	Case	Year	Scenario	Case
	1975	2030		1975	2030	
<b>Macroeconomics, Lifestyle</b>						
Manufacturing (% of GDP)	24.5	23.8	20.0	33.6	29.7	20.0
Services (% of GDP)	64.8	65.8	69.6	48.5	55.0	64.7
Basic materials (% of manufacturing-VA)	24.8	23.2	20.0	33.0	29.4	20.0
Machinery and equipment (% of manufacturing-VA)	43.2	47.0	50.2	42.0	47.1	55.0
<b>Intercity Passenger Transportation</b>						
Distance travelled per person per year (1,000 km)	10	15	10	7.5	10	7.5
Persons per car	2.0	1.9	2.0	5.21	3.20	4.0
Distance driven per car per year, intercity (1,000 km)	7.0	7.8	5.0	5.0	5.6	5.0
Bus (% of public transp.)	15	12	30	35	29	35
Train (% of public transp.)	5	5	20	50	56	60
Plane (% of public transp.)	80	83	50	5	15	5
<b>Dwellings</b>						
Electrical use for appliances (1,000 kWh/dwelling)	3.85	6.25	3.85	1.95	4.50	2.20
Useful energy for air conditioning per dwelling (1,000 kcal)	4,472	5,800	4,472		3,000	
Dwelling with air conditioning (%)	39	50	20	0	20	0

NOTE: These assumptions are selected from an array of changes. They represent both the largest changes and have the most energy-reducing impact. In some instances (e.g., automobile efficiency or home insulation) the assumptions for the Low scenario were regarded as sufficiently rigorous so that only rather minor further improvements could be introduced into the 16 TW case.

appears that the targets of the 16 TW scenario can only be met by changes in economic conditions and lifestyle, in addition to technological improvement: There, the manufacturing and basic materials sectors go down, while the services sector and the share of machinery and equipment within the manufacturing industry go up. Intercity transportation must remain at 1975 levels, despite the assumed 2%/year GDP growth. For Region I, bus services must double and train services quadruple whereas air traffic services are reduced. The energy needed for appliances in people's homes essentially remains at the present level, but air conditioning must be cut down significantly (in Region I), or continues not to be used (in Region III).

After additional assumptions have been made, which are not shown in the table, one can proceed to envisage further improvements on the technology side. The final energy demand that then results is explained in Table 7. For both Regions I and III, the reductions in energy use are given in percent of the Low scenario requirements, which, as one should note, already incorporate significant shares of energy conservation. Over and above these, the reductions range from 8% (Region I) to 56% (Region III), resulting in 32% and 45% decreases in the total final energy demand.

TABLE 7 Final Energy Results, 16 TW Case and Low Scenario  
(Absolute Figures in GWyr/yr)

	Region I (NA)				Region III (WE/JANZ)			
	Low				Low			
	Base Year 1975	Sce- nario 2030	16 TW Case	% Re- duc- tion <sup>a</sup>	Base Year 1975	Sce- nario 2030	16 TW Case	% Re- duc- tion <sup>a</sup>
Total Final Energy	1,871	2,656	1,819	-32	1,589	3,143	1,723	-45
By Sector								
Transportation	541	688	410	-40	313	716	394	-45
Industry	757	1,327	818	-38	805	1,588	725	-54
Household/service	573	641	591	-8	417	839	604	-28
By Fuel Type								
Substitutable fossil fuels <sup>b</sup>	921	964	789	-18	801	1,012	607	-40
Centrally supplied heat <sup>c</sup>	0	0	0	n.a.	0	103	68	-34
Soft solar	0	74	61	-18	0	71	46	-35
Electricity	228	547	265	-52	201	640	285	-55
Motor fuel	597	804	510	-37	381	864	518	-40
Coke and feed- stocks	125	267	194	-27	206	453	199	-56

<sup>a</sup>Percent reduction is the reduction from the Low scenario to the 16 TW case, as a percentage of the Low scenario.

<sup>b</sup>Substitutable fossil fuels are substitutable (mostly heat) uses of oil, gas, and coal.

<sup>c</sup>Centrally supplied heat is heat produced by district heat and cogeneration facilities.

The discrepancy between the 16 TW case and the Low scenario can further be illustrated by comparing the respective primary energy-to-GDP ratios. In the 16 TW case, shown in Fig. 8, the ratios are sharply rising and falling, while in the Low scenario the development of the curves is much smoother. Again it seems that such overall patterns may provide insight into the mechanisms underlying the scenarios, and can be considered as indicators. The implications of the steeply rising and falling curves are clearly different from those of the more sluggish--and more plausible--development in the Low scenario.

Overall, we found the 16 TW case a tough one, and our position is that the scenario does not possess much credibility. After all, for such a case of extreme energy conservation to materialize, a very large number of actual energy end uses must be adjusted and other significant changes in the economic structure must occur. In the final analysis, this issue is an economic, social, and political one, and is then beyond the domain of energy.

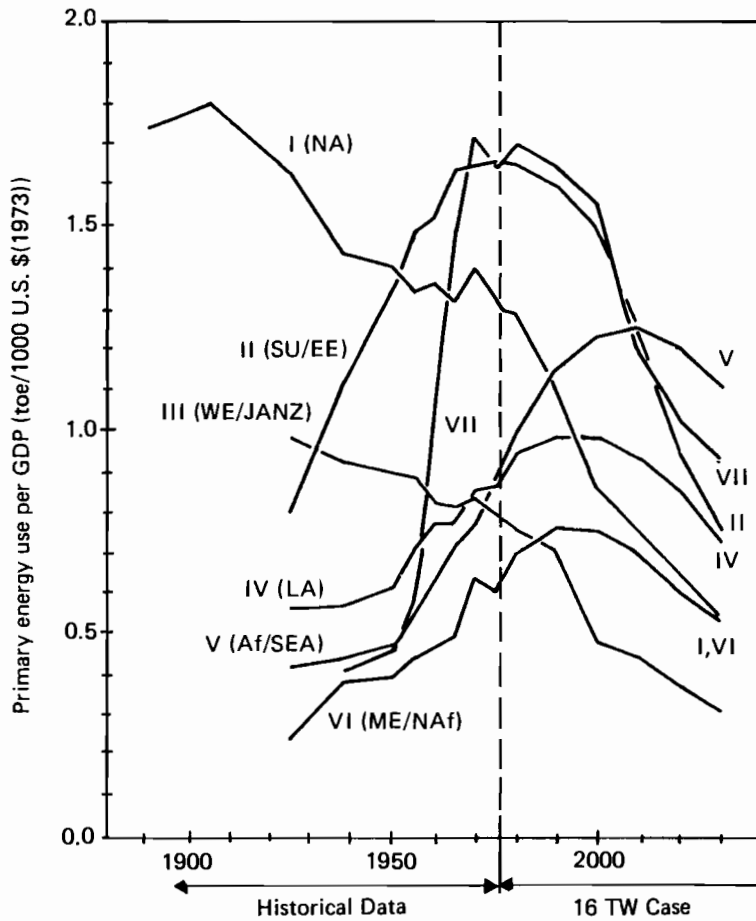

Fig. 8. Energy-to-GDP ratios in the 16 TW case for the IIASA world regions.

REFERENCES

Basile, P. (1980). *The IIASA Set of Energy Models: Its Design and Application*. RR-80- . Laxenburg, Austria: International Institute for Applied Systems Analysis (forthcoming).

Colombo, U., and O. Bernardini (1979). *A Low Energy Growth 2030 Scenario and a Perspective for Western Europe*. Report to the Commission of the European Community's Panel on Low Energy Growth, Brussels, July 1979.

Energy Systems Program Group of IIASA (1980a). *Energy in a Finite World, a Global Energy Systems Analysis*. Chap. 21: Energy, Negentropy, and Endowments. Laxenburg, Austria: International Institute for Applied Systems Analysis (forthcoming).

Energy Systems Program Group of IIASA (1980b). *Energy in a Finite World, a Global Energy Systems Analysis*. Chap. 23: Energy Densities, Land Use, and Settlement Patterns. Laxenburg, Austria: International Institute for Applied Systems Analysis (forthcoming).

- Energy Systems Program Group of IIASA (1980c). *Energy in a Finite World, a Global Energy Systems Analysis*. Laxenburg, Austria: International Institute for Applied Systems Analysis (forthcoming).
- Häfele, W. (1979). *Medium- and Long-Term Perspectives of Energy Strategies in a Finite World*. Paper presented at the IGSRP Congress, Strasbourg, France, August 29-31, 1979.
- Lapillonne, B. (1978). *MEDEE 2: A Model for Long-Term Energy Demand Evaluation*. RR-78-17. Laxenburg, Austria: International Institute for Applied Systems Analysis.
- Marchetti, C., and N. Nakicenovic (1979). *The Dynamics of Energy Systems and the Logistic Substitution Model*. RR-79-13. Laxenburg, Austria: International Institute for Applied Systems Analysis.
- Nordhaus, W.D. (1976). *Proceedings of the Workshop on Energy Demand*. CP-76-1. Laxenburg, Austria: International Institute for Applied Systems Analysis.





# ESTIMATION AND PROJECTION OF ENERGY DEMAND IN DEVELOPING COUNTRIES: CURRENT STATE AND MAJOR ISSUES

**B. J. Choe\***

*Economist, The World Bank*

## ABSTRACT

Estimation and projection of developing countries' energy demand must cope with the problems of inadequate data and rapid changes in the underlying economic structure. Existing studies showed that income elasticity of total energy demand in developing countries is substantially greater than unity, and price elasticity is somewhat smaller than those obtained for industrialized countries. The studies also found that the manufacturing and transportation sectors require more rapid increases in energy consumption for a percentage increase in value-added than other sectors. As additional data become available, the important linkage between energy and economic development as well as structural changes should be investigated on a sounder basis than hitherto possible.

## KEYWORDS

Energy demand; developing countries; econometric estimation; income and price elasticities.

## INTRODUCTION

The purpose of this paper is to review the current state of estimating and projecting the demand for energy in developing countries, and also to discuss the important related issues. Although a stock-taking may be premature at this stage, it may nevertheless put the studies of developing countries' energy demand in a proper perspective in relation to the progress made in this area for industrialized countries.

---

\* The views and interpretations in this paper are those of the author and should not be attributed to the World Bank or its affiliated organizations.

The issues important for developing countries need to be thought through, so that the approaches taken so far can be evaluated in the context of developing countries.

Unavailability or low quality of energy data are the major drawback in estimation and projection of developing countries' energy demand. The data problems are particularly severe in the important areas like non-commercial energy, energy efficiency, sectoral demand and interfuel substitution. Significant efforts are being made to expand and improve the data base at the international and national levels.

Within the scope of the available data, several studies have attempted to estimate the demand elasticities. Choe (1978 and 1979) estimated total commercial energy demand equations, alternatively assuming geometric and polynomial lags. Pindyck (1979) estimated geometric lag fuel demand equations for a limited number of developing countries. Parikh (1978) estimated total energy demand equations (commercial plus non-commercial) with cross-section data, but left out the price variable. Hoffmann's (1979) on-going study attempts to separate out the impact of structural changes on energy demand.

In the following sections, we critically review these studies, beginning with the studies of non-commercial energy. It is followed by the aggregate econometric studies of commercial energy demand. The fourth section deals with structural changes and sectoral demands for energy. The last section is devoted to conclusions and areas for future research.

#### NON-COMMERCIAL ENERGY <sup>1</sup>

The fact that non-commercial energy still accounts for a large share of total primary energy consumption in many developing countries has prompted a number of studies in this area. A recent study by Hughart (1979) provides a useful summary of the state of this subject.

Available data on non-commercial energy are limited, sketchy and often unreliable. The presently available data consist of the FAO data on firewood and charcoal, survey data of rural areas in several countries, and those indirectly constructed on the basis of crop production, forestry area and the number of animals. A significant part of the FAO data are also indirect estimates. These data are mostly cross sectional; time-series data, even if available, are usually not long enough for meaningful time-series analyses.

The studies of non-commercial energy are largely aimed at identifying the nature and extent of non-commercial energy usage in developing countries. Despite the deficiencies of the data, the studies clearly indicate that non-commercial energy accounts for 20% to 90% of all primary energy consumption depending on the countries, mostly for household energy needs in the traditional rural areas. In the traditional setting, non-commercial energy is obtained and consumed as a part of delicate agrarian ecosystems. Examples abound that these systems are under severe strains in many parts of the developing world as rural energy needs begin to exceed the natural regeneration capacity of these systems. Efficiency characteristics of

---

<sup>1</sup> The term "non-commercial" is used here to represent such traditional sources as firewood, agricultural residues and animal power and dung, irrespective of whether they are commercially traded or not.

non-commercial energy usage are not well known. Generally, the traditional combustion and utilization facilities are rudimentary, which normally result in substantial heat losses. Modes of utilization and associated efficiencies, however, should vary widely across countries and localities.

The dynamic aspect of non-commercial energy consumption, despite its obvious importance, has not received much attention in the literature. Available intertemporal data (e.g., for India and Brazil) show dramatic declines in the share of non-commercial energy in total primary energy consumption. Rapid growth of the modern sector vis-a-vis stagnation of the traditional sector could account for the most of these changes, rather than penetration of commercial energy into rural areas to replace non-commercial energy. Transition from non-commercial to commercial energy should be understood as a part of the entire socio-economic transformation process of a traditional society.

One can conceive of the demand for primary energy in a poor rural area as being determined primarily by the number of population; energy satisfies one of the basic human needs. Initially, practically all these needs would be met by non-commercial energy. Increases in rural population, however, would put pressure on the rural ecosystems and make it increasingly difficult to gather non-commercial energy. As rural incomes increase beyond the subsistence level, energy needs will increase and so will the opportunity cost of labor for collection of non-commercial energy. These developments have typically required a gradual transition from non-commercial to commercial energy. At the basic needs level, most rural population cannot afford commercial energy; when commercial energy is introduced as a matter of government policy, heavy subsidies are often required.

In the absence of meaningful time-series data on rural energy consumption, the dynamics can be gleaned from cross-country analyses of rural energy consumption, rural income and prices of commercial energy. The role of rural income as an explanatory variable of rural energy consumption is two-fold: it can be a proxy for the opportunity cost of labor needed to obtain non-commercial energy, in addition to being the usual income variable in any demand functions. In areas where rural income increases fast and consumption of non-commercial energy is close to the limits of natural regeneration, the true (social) cost of non-commercial energy may be high and increasing very rapidly. Normally, this process led to penetration of commercial energy into the rural areas. It is a matter of great uncertainty how this process will develop in the future when the costs of commercial energy are already high and will increase further. One direction which could be pursued is to improve the efficiency of non-commercial energy usage and to harness the locally available non-conventional energy sources (wind, solar, small hydro), all at some costs. This course is likely to take a long time and much depends on the location-specific circumstances.

#### AGGREGATE ECONOMETRIC STUDIES AND ELASTICITIES

Although the available data on commercial energy are in a much better shape than those of non-commercial energy, quantitative analyses of developing countries' commercial energy consumption suffer from the lack of adequate data on several key variables. These are data on sectoral consumption, prices to the final users of various forms of energy and efficiency characteristics of energy-using capital stock in developing countries. Studies of developing countries' commercial energy consumption, so far, have been concerned with: (a) estimation of total commercial energy demand as a function of gross domestic product (GDP) and energy prices; (b) estimation of individual fuel demand equations; (c) attempts to estimate the effect of

structural changes on energy demand; (d) use of input-output tables to determine sectoral output and energy demand. In this section we look at the first two classes of studies.

The common approach of the aggregative studies is to relate total energy consumption with GDP, energy prices and population, using time-series and/or cross-section data of these variables. When time series data are involved, the demand function is usually expressed in a dynamic form. Choe (1978 and 1979) estimated the following two dynamic forms on pooled time-series of cross-sections data of 40 developing countries for the 1960-75 period:

$$(A) \quad E_{it} = \alpha + \beta \cdot Y_{it} + \gamma \cdot P_{it} + \delta \cdot E_{it-1} + \varepsilon_{it},$$

$$(B) \quad E_{it} = \alpha + \beta \cdot Y_{it} + \sum_{k=0}^{t-1} \omega_k P_{it-k} + \varepsilon_{it},$$

where  $i$  and  $t$  are country and year subscripts respectively,  $E$  represents per capita energy consumption,  $Y$  is per capita GDP and  $P$  is energy price index, all expressed in natural logarithms.

The two specifications above differ in the way demand adjusts over time to higher prices. The geometric lag specification (equation A) posits a dynamic adjustment process in which the impact on demand of a price increase declines geometrically as time goes on. The fact that energy is consumed through utilization of capital equipments suggests that higher energy prices will initially affect the capacity utilization rate and subsequently induce modification and replacement of capital stock, which normally takes a long time. The geometric lag distribution puts an implausible prior restriction on the relative magnitude of these adjustments. The geometric lag specification also assumes a symmetric time path of adjustments to income and price changes. The nature of adjustments to income could be entirely different from that to prices. The polynomial distributed lag model (equation B), on the other hand, assumes instantaneous adjustments to income changes and can accommodate any time path of adjustments to price changes. One problem, however, is that the time path of adjustments can hardly be elicited from short time-series observations usually available for developing countries.

The models A and B above produced about the same estimate of the income elasticity; the long-run income elasticities estimated from model A average to about 1.3, which is practically the same as the estimate of the instantaneous income elasticity of model B. Model A, however, produced an average estimate of the long-run price elasticity of about -0.3, whereas model B results indicate a somewhat higher long-run price elasticity, in the neighborhood of -0.4 to -0.5. Model B results also indicate a time path of adjustments to prices which resembles a second degree polynomial; demand adjustments to price changes are small in the years immediately following the price change, gradually reaches a peak in 3 to 5 years and then tapers off after that.

A number of problems, however, are embedded in such estimates, and those problems become acute when the estimates are used for projection purposes. Perhaps the most important is to understand the nature of the substantially higher-than-unitary estimate of income elasticity. It implies that developing countries have been shifting towards more energy-intensive economic activities and/or that technological changes have been energy-using. Since we have the energy price variable in the equations, these changes, to the extent reflected in the estimated income elasticity, must in principle have been occurring autonomously, that is, without being induced by energy

price changes. In practice, however, the weaknesses of the data, particularly the energy price data, and other statistical problems could produce a less-than-satisfactory separation of income and price effects. The question is to what extent it is in the nature of development process that economic structure shift toward more energy-intensive sectors.

Projecting developing countries' energy demand on the basis of historical elasticities as estimated by the equations assumes in broad terms a continuation of the past trends in structural and technological changes. This is a sweeping assumption which may well turn out to be unwarranted. A way of approaching to this problem is to associate the nature and speed of structural changes to the stages of economic development. Income elasticities could be estimated separately for subgroups of developing countries, classified according to certain criteria. Stratification by per capita income, geographic regions, speed of industrial growth, etc., however, often do not produce the desired results. This may be taken as an indication that multiple criteria are required to adequately explain the differences in income elasticity.

Estimates of price elasticities for industrialized countries showed a wide range of values and sometimes conflicting results. A priori reasoning does not tell whether the price elasticity of developing countries should be greater or smaller than that of industrialized countries. In household consumption of energy, the scope for "doing without" would be much less in developing countries than in developed countries. However, the fact that developing countries have relatively small energy consuming capital stock would make it easier to adjust the total capital stock composition to changes in relative factor prices.

Another important area of concern is the extent of energy conservation, price-induced or otherwise, which may be expected in developing countries. Efficiency characteristics and conservation potentials in these countries are not clear at this stage. Energy conservation has not yet received much emphasis in these countries, perhaps because of the fact that the level of energy consumption is low enough not to arouse concern in many countries. More fundamentally, the usually high cost of capital in developing countries could make conservation investments less economic than otherwise, and materials used in conservation investments (e.g., insulation materials) are often not available domestically. Research and development of new conservation technologies largely are beyond the capabilities of most developing countries. Developing countries' conservation policies relied primarily on domestic pricing measures. Mandatory energy conservation in the industrial and transportation sectors faces the problems of capital and technology mentioned above. Household energy consumption in the traditional and urban areas may be amenable to improvements in efficiency, by changing the modes of cooking and heating without requiring much investments, but the traditional way of life may be challenged in the process.

Pindyck (1979) provides examples of estimating the demand for petroleum products in selected industrializing developing countries. Demand for a petroleum product is specified as a function of its own price, GDP, and the lagged demand variable. His estimates, although limited in coverage, show some interesting features. Generally, he finds that the residential and transportation demands for petroleum products are highly income elastic but price inelastic, compared with similar estimates for industrialized countries. On the other hand, the demand for heavy fuel oil, presumably the industrial sector, shows relatively low income elasticity but high price elasticity. Kerosene is found to be an inferior good (negative income elasticity) and price inelastic. The high price elasticity of the demand for heavy fuel oil is attributed to the availability of low-cost labor as a substitute for heavy fuel oil in the industrial sector of developing countries.

Pindyck's estimates can hardly be taken as representative of developing countries, since only five "advanced" developing countries are used in the estimates. In those five countries, kerosene may well have become an inferior source of household energy. However, in most of the remaining developing countries, kerosene still is preferred to non-commercial energy. It is also unconvincing that low-cost labor is a substitute for heavy fuel oil, but not for gasoline and light fuel oil. As a whole, it appears that more work needs to be done in this area, expanding the coverage and focusing on key petroleum products like gasoline, for which required data are more readily available and the associated substitution problems are less demanding.

#### STRUCTURAL CHANGES AND SECTORAL DEMAND

As noted in the preceding section, rapid changes in the underlying economic structure of developing countries are recognized as an important determinant of energy demand. In fact, the share of industrial output in GDP increased from 29% in 1960 to 35% in 1975 in developing countries as a whole. A significant part of the high estimated income elasticity may be accounted for by the increasing share of industrial output and accompanying urbanization. Although the proper way of quantifying the effects of industrialization on energy demand would be to estimate the sectoral demand equations, formidable data problems have thus far prevented this direct approach. A compromise approach is being attempted by Hoffmann (1978). Another conventional approach is the usual input-output method. This section deals with these two approaches.

Hoffmann attempts to estimate the effects of structural changes on energy demand, without relying on sectoral energy consumption data. It is done by specifying the demand for total commercial energy as a function of GDP, energy prices and the percentage shares in GDP of the major energy consuming sectors. Hoffmann uses four sectoral share variables: agriculture, mining and construction, manufacturing and electricity, and transport. The energy consumption and GDP variables are sometimes expressed in the per capita term.

A fundamental assumption in Hoffmann's approach is that sectoral energy demand equations can be aggregated to a total energy demand equation, which resembles the form estimated by him. When sectoral energy demand equations are assumed to be linear functions of sectoral GDP and energy prices, it can be shown that total energy demand can be expressed as a linear function of sectoral GDP and energy prices. The identity that total GDP equals the sum of sectoral GDP can be used to replace one sectoral GDP variable by total GDP. The coefficient of the total GDP variable is then interpreted as representing the sector left out in the total demand equation. Aggregation of sectoral demand equations is not feasible when the demand equations are assumed to be non-linear. Hoffmann uses the log-linear form. The interpretations above in the linear case, therefore, would not apply to Hoffmann's log-linear form. However, we may at least presume that the log-linear model would have a reasonably close interpretation to that of the linear model.

Preliminary results obtained by Hoffmann suggest that sectoral shifts have been an important determinant of total energy demand in developing countries. He finds that the GDP share of agriculture almost invariably has a negative relationship with total energy consumption, whereas the opposite is the case for the GDP shares of manufacturing/electricity and transportation. The estimates for the GDP share of mining and construction are mixed, that is, sometimes positive and sometimes negative. Of interest are the surprisingly large positive coefficients for transportation, compared with those for manufacturing and electricity. The total GDP coefficients vary widely between the groups of developing countries, probably because of its interpretation as the coefficient of the left-out sector rather than GDP itself.

It apparently is not an easy task to elicit the implications of sectoral shifts without going directly into estimating sectoral demands. Apart from the aggregation problem mentioned above, there is the statistical problem of multicollinearity between the sectoral share variables, particularly between the manufacturing and transportation shares. It is also likely to be the case that the peculiar characteristics of energy consumption in different sectors call for different specification of the demand equation for each sector. One advantage of the input-output methodology is that it works in terms of greater sectoral details than the econometric approach. The input-output approach, however, also suffers from a serious problem: developing countries undergo rapid structural changes and also must adjust to higher energy prices. The input-output coefficients should be modified accordingly. To do this, the input-output coefficients can be related to relative prices. The relationships must come from econometric evidence. Another method of coping with this problem is to allow for a multitude of activities (input-output vectors) for each product or service, and let the model choose the optimal set of vectors. In either case, data problems effectively limit their applicability to only a few developing countries for the near future.

### CONCLUSIONS

The task of estimating and projecting energy demand in developing countries faces the twin problems of coping with rapid structural changes and limited data availability. Existing studies are in fact largely a reflection of the data constraints. The studies conducted so far have indicated the broad range of aggregate income and price elasticities of energy demand, the effects of structural shifts on energy consumption and the demand elasticities for some of the individual fuels.

Progress is being made to widen the energy data base of developing countries. The International Energy Agency (1978) has compiled the sectoral consumption data for 16 developing countries, and the UN is also working on this area. The sectoral consumption data, combined with appropriate sectoral energy price data, will open up an important new area for research. The issues of structural changes and interfuel substitution can be addressed more meaningfully at the sectoral level.

Price elasticities and energy conservation are the subjects which demand innovative approaches as well as more data. The low level of capital stock accumulation in developing countries makes it important to look at the conservation issue as a part of future investment policies. In this connection, the vintage capital approach would be more relevant to developing countries than to industrialized countries.

Within the existing data, further analysis of cross-country differences in energy consumption seems desirable. Cross-country comparisons could focus on specific energy consuming sectors such as iron and steel, gasoline consumption for transportation and residential consumption of electricity. Additional data on non-commercial energy are likely to be hard to obtain. Sample surveys, however, can often provide an adequate basis for planning. Cross-country analysis of non-commercial energy with the existing data, despite all the deficiencies, could produce interesting insights into the relationship between rural energy demand, rural income and commercial energy prices.

REFERENCE

- Berndt, E.R. and Wood, D.O. (June 1979) "Engineering and Econometric Interpretations of Energy-Capital Complementarity," Amer. Econ. Rev.
- Choe, B.J. (1978) "Energy Demand Prospects in Non-OPEC Developing Countries," in Workshops on Energy Supply and Demand, International Energy Agency, Paris.
- Choe, B.J. (June 1979) "Energy Demand in Developing Countries," a paper prepared for the IAEE Conference on International Energy Issues, Washington, D.C. Mimeographed.
- Griffin, James (1979) Energy Conservation in the OECD: 1980 to 2000, Ballinger Publishing Company, Cambridge, Mass.
- Hoffmann, Lutz (December 1978) "Energy Demand in Developing Countries: Approaches to Estimation and Projection," in Workshop on Energy Data of Developing Countries, Volume 1, International Energy Agency, Paris.
- Hughart, David (August 1979) Prospects for Traditional and Non-Conventional Energy Sources in Developing Countries, World Bank Staff Working Paper No. 350.
- International Energy Agency (December 1978) Workshop on Energy Data of Developing Countries, Volume 2, Paris.
- Parikh, J.K. (1978) Energy and Development, Report PUN 43 to the World Bank.
- Pindyck, R. S. (1979) The Structure of World Energy Demand, MIT Press, Cambridge, Mass.



# BEHAVIOURAL CONSTRAINTS ON THE IMPLEMENTATION OF CONSERVATION MEASURES IN THE UK, USING THE SARU EDP MODEL

**H. Danskin\***

*Systems Analysis Research Unit, Departments of the Environment and Transport,  
2 Marsham Street, London SW1P 3EB, UK*

## ABSTRACT

The EDP model is an input-output one, driven by final demand for 24 different commodities including 4 fuels, and contains mechanisms to deal with fuel mix changes, technical progress in the use of energy and price-induced capital energy substitution, together with special demand sub-models of household heat consumption and car use and purchase. This paper describes in some detail the domestic heating sub-model and the constraints affecting the purchase of domestic conservation measures. As an illustrative example, a comparison is made between two projection runs, identical except that all 4 fuel prices are constant in the control run, and double linearly over the projection period in the second run. The aim of the experiment is not only to consider the total effect on domestic heat consumption but also to analyse the net savings into the contributions from reduced levels of comfort and increased use of conservation measures, and to examine their relative shares over time.

## KEYWORDS

Energy demand model; domestic conservation; behavioural constraints; contributory factors to net savings.

## INTRODUCTION

Part of the philosophy behind the EDP model is to investigate how people actually do respond to conservation signals such as fuel price increases and subsidies on the costs of conservation measures, to build a model of this behaviour and then to check how variations in particular signals affect the total demand for primary energy. Data for the UK over the period 1958-1977 were analysed to determine parameter values, so the model may be described as a "behaviour as usual" one in that people's response in the future to eg fuel price increases is assumed to be the same as that in the past; however, larger increases will produce larger effects in general so the epithet "business as usual" does not apply, except for one scenario.

---

\* The views expressed in this paper are those of the author and do not necessarily coincide with those of the Departments of Environment and Transport.

Another complicating feature of the real world is the number of interconnections which can produce various secondary and "knock-on" effects, and occasionally lead to counter-intuitive results. An important example is the set of constraints arising from the fact that at any time, consumers' disposable income is both fixed and disposed. Accordingly, increased fuel prices not only produce a reduction in fuel consumed directly but also cause expenditure on other goods and services to drop, leading ultimately to lower industrial demand for energy as well.

#### GENERAL MODEL STRUCTURE

In order to maintain proper accounting procedures, the model is constructed around a 24-sector input-output table; this is used directly in the calculation of prices, and, via its Leontief inverse, in the calculation of gross output from the set of final demands. The block diagram in Fig. 1 shows the main mechanisms of the model and how they are linked together.

For each of the 24 industrial sectors there is a model of technical change, both autonomous and price induced; the former is driven endogenously by an experience factor, represented by the cumulative production of the sector in question. Each sector also has a market share model for the 4 fuels (solid, liquid, gas and electricity) driven by their prices and the cumulative production term again.

In the domestic fuel mix model, cumulative production is replaced by (disposable) income per household. Technical improvement in domestic heating appliances is treated exogenously while capital energy substitution involving each of the conservation measures is triggered by the cost effective criteria being satisfied in each case, with the rate of uptake dependent upon income per capita, payback period and initial cost of the capital. Household demand for most of the 24 commodities (including the 4 fuels) is dealt with by a set of income and price elasticities with special sub models for domestic energy consumption (excluding appliance electricity) and for purchases and use of private cars. In these sub models, the effects of possible demand saturation are considered.

A simple price model makes allowance for changes in labour productivity in each of the non-fuel sectors while the effects of one price upon another are mediated by the input output table. The whole model is demand driven with the main exogenous variables being GDP, fuel prices (both wholesale and retail), purchase-type taxes, population, number of households, trade and the ratio of primary to secondary production of each fuel.

Details of each of these mechanisms are given by Danskin (1979) and a comprehensive description of the model and its background may be found in SARU (1980).

In the remainder of this paper, the domestic heating model is explained in detail; then follows a description of a simple experiment to demonstrate how various factors contribute to the net reduction in demand for domestic heating when fuel prices are increased.

#### DOMESTIC HEATING MODEL

The model deals with the consumption of all domestic energy apart from appliance electricity and this is dominated by the requirements for space heating and to a lesser extent, at least at present, water heating. Because of the reasonably homogeneous nature of the energy use involved, the model is based on useful energy, ie the energy actually available to the consumer when appliance efficiencies have been taken into account. Over the past twenty years or so in the UK, the level of delivered energy to the domestic sector has remained remarkably constant; however,

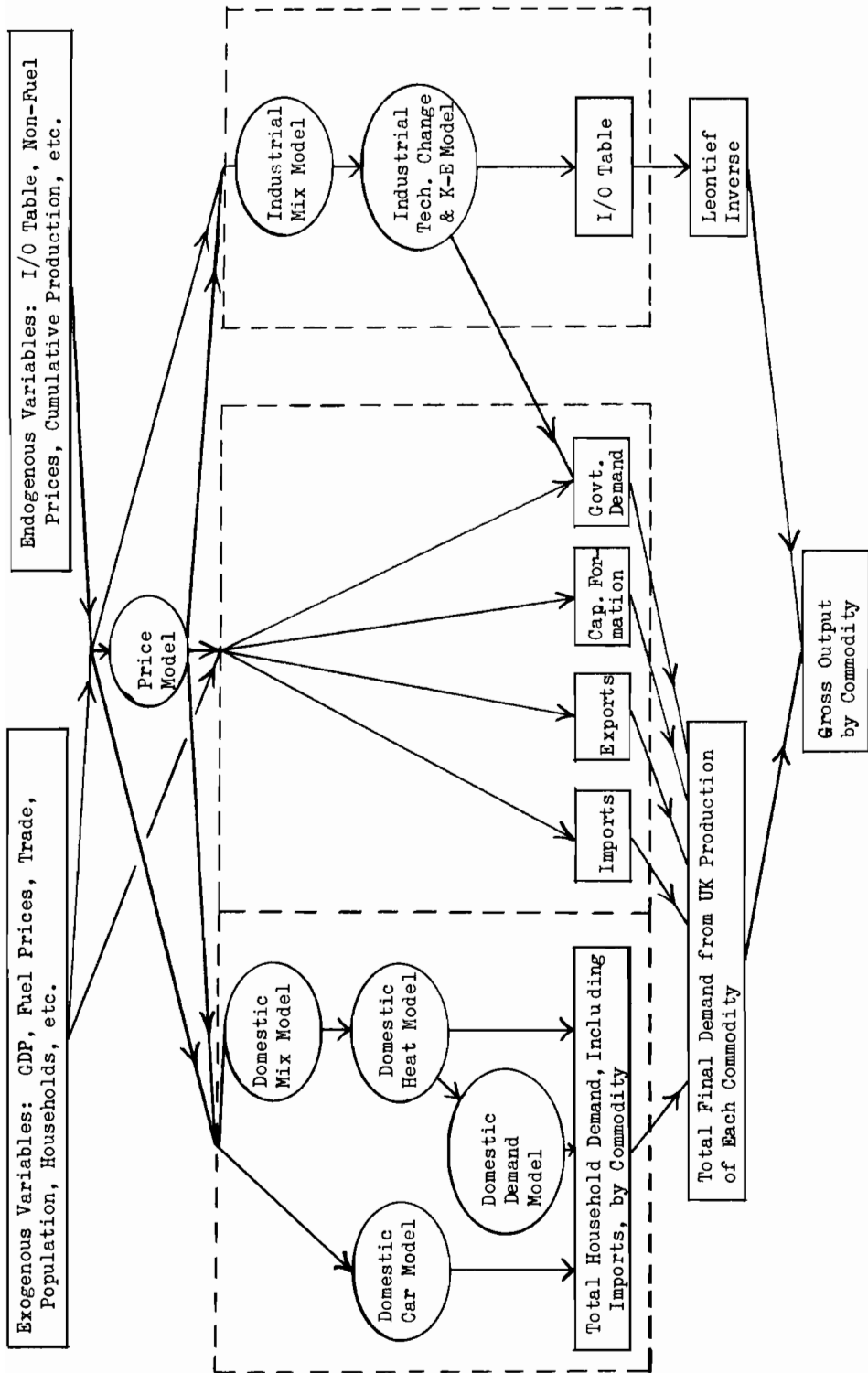

Fig. 1. General structure of model.

the useful energy has been rising steadily, mainly as a result of the switch away from inefficient open coal fires to more efficient oil, gas and electricity heaters and also to modern solid fuel stoves. This changeover is considered in the Domestic Fuel Mix model, but since changing market shares are not relevant for the experiment to be described later no further details will be given here, but can be found in SARU (1980).

In fact, the useful heat per household (UHH) has also been climbing and the modelling of this change is the basis of this section. The factors which influence UHH include household income, the average energy price for the particular fuel mix involved, the effect of any conservation measures installed or renewable energy sources being tapped (eg via solar panels), the contribution of incidental heat sources, intermittency of occupation, etc. etc. In outline, the UHH for a basic uninsulated house is given as a function of income and energy price, then adjusted for possible saturation effects as UHH approaches an upper limit; the rate of installation of each of the (six) conservation measures is calculated from the initial cost, the expected payback period and household income, and the corresponding UHH reduction factor determined; next, this factor is modified to take into account the propensity to take some of the potential energy savings as increased comfort, the size of this effect depending on the average whole house temperature relative to some maximum value. Finally, the modified reduction factor is used to find the actual UHH for a standard house insulated to current levels.

In more detail, consider first the conservation measures, each of which has a basic cost which could be altered exogenously to test the effect of direct price subsidies. There is also a retail price index corresponding to the sector in which the measure is produced, eg insulation from the construction materials sector. If the payback period for a particular measure, P, does not exceed a critical value, it is used in conjunction with the initial cost, c (equal to the basic cost  $\times$  appropriate retail price index) and household income I to determine the time constant T controlling the rate of installation of that measure. The relation is

$$T = T_0 + a P^x I^y c^z \quad (1)$$

where  $T_0$  is the minimum time constant for all measures (2 years) and a, x, y and z are parameters deduced from studies of actual take-up times (BRE, 1975; Cornish, 1976). Otherwise too large a value of P causes T to be set at a very high (constant) value so that the take-up of these measures is negligible. The number of households installing a given measure is related to the total 'eligible' population via exponential smoothing with the time constant T; for example, many old houses have solid walls so the eligible population for cavity insulation is rather smaller than the total number of households.

The above mentioned studies produced sets of time constants separately for tank lagging, loft insulation and cavity fill, broken down both by tenure type and social-economic class. A summary of the results is given in Table 1. The variation across tenure types and social classes is largely as expected, but what is somewhat surprising is the size of the time constants, eg 21 years for owner occupiers to install loft insulation with a payback period of only 3 years.

Each of the measures installed is assumed to reduce the useful heat requirement of the 'standard' house which we are considering by a constant fraction  $R_m$  and the national effect is proportional to the fraction of all households which have installed the measure. The basic reduction factor,  $f_0$ , is thus

$$f_0 = 1 - \sum_{m} (N_m / N_H) R_m \quad (2)$$

where  $N_H$  is the national total of all households,  $N_m$  is the number with the  $m^{\text{th}}$  measure already installed, and the sum is over all measures.

However, recent studies by Cornish (1976) have shown that installed measures have been used only in part to save energy, with the remaining potential savings being 'sacrificed' in order to increase the level of comfort, as measured by the average whole-house temperature,  $\theta$ . This temperature is calculated using the standard degree day equation (IHVE, 1970),

$$\theta = b + c (E.w)/(\bar{U}.i) \quad (3)$$

where  $b$  and  $c$  are the usual degree day constants,  $E$  is the useful heat per household,  $w$  the water heating factor (which allows for fortuitous gains to the space heating from hot water),  $i$  the intermittency factor, and  $\bar{U}$  is the weighted average whole-house conductance. This last factor depends in turn on the measures installed, viz

$$\bar{U} = U_0 - \sum_m (N_m/N_H) \Delta U_m \quad (4)$$

where  $U_0$  is the conductance of the 'standard' house with no conservation measures, and  $\Delta U_m$  is the reduction in conductance for the  $m^{\text{th}}$  measure.

The 'comfort function',  $c(\theta)$ , is designed to increase monotonically with  $\theta$ , from zero at 'low' values of  $\theta$  (eg those obtaining for 1950s levels of UHH) up to unity as  $\theta$  approaches some maximum value, currently taken to be 20°C.

TABLE 1 Time Constants for Domestic Insulation: Jan 1974-Dec 1976

	Acquisition of tank lagging	Acquisition of loft insulation <sup>1</sup>	'Topping-up' loft insulation <sup>2</sup>	Cavity fill <sup>3</sup>
All	5.1	30.4	32.6	79.0
<u>Social class</u>				
AB	2.5	8.4	28.7	37.2
C1	3.7	12.3	36.6	39.1
C2	5.2	31.4	31.4	81.3
DE	7.4	70.3	44.5	330.1
<u>Tenure<sup>4</sup></u>				
Owner occupied	5.2		21.0	39.6
Local authority	5.2		40.9	125.2
Private rented	7.6		70.7	75.1
Cost	£5	£40	£20	£125
Payback period (yrs)	0.2	3.0	7.5	5.0

<sup>1</sup> Assumed to be first time acquisitions of 75mm insulation.

<sup>2</sup> Assumed to be from 40mm to 75mm insulation; this is included separately from initial acquisitions of 75mm insulation since it is cheaper than the latter, but less profitable, thus giving more data points for analysis.

<sup>3</sup> Estimates drawn from very small samples.

<sup>4</sup> Data for 2 years only.

Source: Domestic Insulation Survey; Home Audit Division. Audits of Great Britain Ltd. London 1977.

The basic reduction factor is thus adjusted by  $c(\theta)$  to give  $f$ , the actual factor used to modify the basic value of UHH:

$$f = 1 - c(\theta) \sum_m (N_m/N_H) R_m \quad (5)$$

Finally, the UHH for a 'standard' uninsulated house, BUHH, is calculated as a function of household income and energy price, using constant elasticities. At this stage, there is an option to make allowance for possible saturation effects, corresponding to some prescribed maximum whole-house temperature, or to allow BUHH to rise with income. The option is chosen at the start of the simulation run, the model calculates the appropriate value of BUHH then adjusts it by the conservation factor  $f$  (Eq. 5) to give UHH. Given the results of the domestic mix model, and the conversion efficiencies for domestic fuels, the demand for each of the fuels can be found along with the total expenditure on fuels and conservation measures.

#### ILLUSTRATIVE EXPERIMENT

The purpose of this experiment is to demonstrate some of the ways in which the model allows one to analyse the net result of some policy decision into the separate contributions of the various factors involved, and to check whether or not these contributions alter over time, i.e. whether some of the factors may be more important in the short term, and others in the longer term. The experiment consists of comparing the value of UHH from two projection runs of the model in which all of the exogenous variables - except for all the fuel prices - have exactly the same time profile in each, the difference between the two being that each fuel price is constant in the control run and doubles linearly over the period of the projection in the test run.

The three factors contributing to the final level of UHH in a particular scenario are (1) the basic level of comfort desired, represented for a standard, uninsulated house by BUHH, (2) the basic reduction factor  $f_0$  (Eq. 2) which corresponds to the fractional savings expected from the installation of the various conservation measures and (3) a modifying factor  $S = f/\bar{f}_0$  (Eq. 5) which allows some of the conservation savings to be sacrificed for increased comfort. Thus, we can express UHH in the form

$$UHH = BUHH \times f_0 \times S \quad (6)$$

In order to calculate the contributions to the difference  $\Delta UHH$  between the two runs in such a way as to give results which are independent of the order in which they are calculated,  $\Delta UHH$  is given as the sum of three terms of the form  $\Delta S \times BUHH \times \frac{f_0}{\bar{f}_0}$ , where  $\Delta S$  is the difference between the two values of  $S$  for any given time, and  $BUHH$  and  $\bar{f}_0$  are the corresponding average values, over the two runs, of the other variables. The results are given in Table 2 where the absolute values have all been multiplied by the total number of households so as to give national figures for useful heat rather than household ones.

TABLE 2 Contributions to Total UK Net Savings of Useful Heat

Year	Reduced Comfort		Increased Conservation		Sacrificed Savings		Total Savings	
	PJ	Share	PJ	Share	PJ	Share	PJ	Share
1980	16.2	107%	0.2	1%	- 1.3	- 9%	16.1	100%
1990	57.3	83%	23.3	34%	-11.5	-17%	69.1	100%
2000	80.3	65%	66.2	54%	-23.6	-19%	122.8	100%

These results illustrate some of the effects which the model is designed to reveal. First of all, it appears that the extra sacrificing of some of the energy savings arising from the use of increased conservation measures is not trivial, but amounts to nearly 20% of the potential total savings for the latter part of the projection period, or around 35PJ of primary energy in the year 2000. The other side of the coin, of course, is that the level of comfort in homes is correspondingly higher than would have been estimated without this effect, a useful point to remember when considering the possible depressing effects on the standard of living arising from fuel price increases.

The large change over time in the relative contribution of conservation measures to net savings highlights the problem of the long time constants involved in the domestic sector; however, because of the cumulative effect of conservation measures which allow comfort levels to be maintained with a lower energy input, conservation is important as a longer term investment. On the other hand, although reductions in desired comfort levels produce immediate energy savings, the reverse situation occurs just as fast; furthermore, as incomes rise, these depressed comfort levels will rise again with the net result that this particular factor merely delays the arrival of higher levels of energy demand.

These results are specific not only to the comparison between doubling fuel prices and holding them constant but also to the basic scenario on which the experiment was carried out. For example, with much higher rates of growth of GDP, it might be expected that the share of savings from reduced comfort would be dominant for rather longer than in this case, although runs would have to be performed to check this. From a policy point of view, it might be useful to repeat this experiment on the same basic scenario but with the fuel price increases varying over some range in order to discover whether a threshold effect could exist whereby fuel price growth rates below a certain level produced negligible net savings over the period under consideration; alternatively, for very rapid growth of fuel prices, the secondary effects of the sacrificed savings could perhaps effectively cancel most of the original savings.

Other policy issues on the domestic front which the model could illustrate include the effects of subsidising conservation measures, the effects of producing the rise in fuel prices by means of a retail tax rather than by depletion in the energy sector, the different consequences for household expenditure and, ultimately, for national primary energy demand, of achieving the same household temperature profile against time by different means, e.g. different combinations of fuel taxes and conservation subsidies etc. In each case, there are further repercussions for national primary energy demand because consumer expenditure on other goods and services is altered; in addition, if there is an increase in the industrial price of fuels, the relative prices of other items change since the costs of energy intensive goods, e.g. chemicals, will rise faster than the average (although capital-energy substitution will reduce all energy intensities). As a result, the final demand for each commodity is altered, the gross output is different and the industrial demand for energy also changes. However, the strict accounting procedures enforced by the use of the input-output table allow the model to keep track of all these adjustments. Thus, the model is a convenient tool for carrying out "what-if" type experiments, the very kind which policy makers require.

#### REFERENCES

- BRE (1975). Energy Conservation: A Study of Energy Consumption in Buildings and Possible Means of Saving Energy in Housing. Department of the Environment, Building Research Establishment, Watford.
- Cornish, J. P. (1976). The Effect of Thermal Insulation on Energy Consumption in Houses. In R. G. Courtney (Ed.), Energy Conservation in the Built Environment.

- The Construction Press, Lancaster. pp. 458-466.
- Danskin, H. (1979). The SARU Energy Demand Projections Model. Futures, 11, pp.491-509
- IHVE (1970). In P. L. Martin (Ed.), IHVE Guide, Book B. The Institution of Heating and Ventilating Engineers, London. pp.B18.9-B18.14.
- SARU (1980). UK Energy Demand Projections. HMSO, London. To be published.

#### ACKNOWLEDGEMENT

This paper is reproduced by permission of the Controller of HMSO.



# DEMAND FOR ENERGY IN MANUFACTURING: APPLICATIONS OF DYNAMIC MODELS OF FACTOR DEMAND TO U.S. AND CANADIAN DISAGGREGATED DATA

M. Denny, M. Fuss and L. Waverman

*Institute for Policy Analysis, University of Toronto, Toronto, Canada*

## ABSTRACT

In this paper we utilize recent advances in the specification of dynamic models of the demand for energy to compare short run and long run responses in Canadian and U.S. manufacturing industries to energy prices shocks. We present short run and long run own and cross-price elasticities of demand for energy, labour, materials and capital for 18 2-digit Canadian and American manufacturing industries. Also contained in the empirical results are the speeds of adjustment between steady state equilibria. On average, it is estimated that about one-third of the ultimate adjustment occurs during the first year after the shock. In addition, we explore the nature of energy/capital and energy/labour complementarity or substitutability. Disaggregation by 2-digit industrial classification reveals considerable variation in the relevant production characteristics, so that no overall summary conclusions can be obtained. Complicating this situation is the fact that for a number of industries, switching occurs in the complementarity/substitutability relationship as firms adjust from the short run to a new long run steady state equilibrium.

## KEYWORDS

Energy demand; dynamic model; price elasticities; disaggregated data; energy/capital complementarity.

## INTRODUCTION

Many researchers have examined the nature of the demand for energy in the manufacturing sector. Knowledge of the characteristics of this demand for energy is important for many public policy decisions. For example, are energy and capital complements in production, so that energy conservation policies based on higher energy prices will lead to lower rates of capital accumulation? Most U.S. and Canadian studies of total manufacturing have indicated just such a complementarity relationship between energy and capital.<sup>1</sup> On the other hand, some international cross-section studies have indicated that there is a substitutability relationship between capital and

---

<sup>1</sup> For example, see Hudson and Jorgenson (1974), Berndt and Wood (1975) and Fuss (1977).

energy in producing manufactured products<sup>2</sup> - that higher energy prices induce a substitution of capital for energy generating greater investment and thus accelerating economic growth. Another important relationship is the cross-price elasticity between labour demand and energy prices. If energy and labour are substitutes as most studies have shown then higher energy prices will lead directly to an increase in employment. There are indirect effects to consider as well. Higher energy prices, if reflected in higher product prices reduce demand for the more energy intensive products thus affecting aggregate employment and investment.

Most of the evidence to this point in time on the characteristics of the demand for energy in the manufacturing sector has emanated from research utilizing aggregate national manufacturing data estimated with static models of input demand. In this paper, we report the empirical results of two extensions to existing modeling of energy demand in the manufacturing sector - the use of disaggregated data by 2-digit industrial classification and the use of dynamic adjustment rather than static equilibrium models of factor demand. We show that these extensions add important information of the type required for the crucial policy decisions made necessary by the post 1973 changes in energy prices. We concentrate entirely on the production relationships between energy and other inputs.

#### THE MODEL

The model used has been extensively described elsewhere, here we simply describe its main features.<sup>3</sup> Explicit economic maximization principles are used in constructing a model of a firm's choice of input use. The parameters of this theoretical model are then estimated with past observations using econometric techniques. The dynamic model utilizes optimal control theory with a capital stock as the state variable and energy, labour, non-energy materials and investment as control variables. Utilizing an internal cost of adjustment model of capital accumulation, it is hypothesized that the objective of the firm is to minimize the present discounted costs of producing a flow of output. Included in production costs are the increasing marginal costs of adjusting the capital stock along a path between two steady state equilibria.<sup>4</sup> The logic to the internal adjustment model is that as the firm attempts to grow more quickly, inputs must be increasingly devoted to investment activities instead of output production. This dynamic model contains a number of advances in modeling input demand: disequilibria in input markets is explicitly recognized, as spillovers between input demands are incorporated (i.e., if the firm is not employing the desired capital stock because of adjustment problems, this disequilibrium in the capital market has important implications for the other input markets); the model involves a general equilibrium analysis of all factor demands simultaneously; the relationships between inputs can vary from the short to the long runs, i.e., inputs can be substitutes in the short run and complements in the long run or vice versa.

---

<sup>2</sup> Examples include Griffin and Gregory (1976) and Pindyck (1979).

<sup>3</sup> The model was originally proposed by Fuss (1976) and has been used by Berndt, Fuss and Waverman (1977, 1980), and Denny, Fuss and Waverman (1979). This present paper reports the basic empirical findings of the latter two reports. The theoretical model developments have appeared as Berndt, Fuss and Waverman (1979), and Denny, Fuss and Waverman (1980).

<sup>4</sup> This conceptual model is based on the research of Treadway (1974).

## ESTIMATION AND RESULTS

The dynamic model was estimated for 19 2-digit SIC manufacturing industries in Canada with data for the 1962-75 period and for 18 2-digit SIC manufacturing industries in the U.S. with data over the 1948-71 period. The Canadian data include regional as well as intertemporal observations, while the American data base consists of a time series of national aggregates.

### Dynamic Model Estimation with the U.S. Data

In Table 1 we present a number of price elasticities of demand for 18 2-digit manufacturing industries in the U.S.. The estimated cost function for each of these industries exhibit the correct curvature properties for cost minimization. In all of the 18 industries, the own-price elasticities of demand are negative as implied by economic theory (columns 2 to 6, the percentage change in quantity used of input  $x$  with respect to a 1% change in the price of  $x$ ). The important elements for public policy are first, the magnitude of the long run price elasticities of demand; second, the differences between short and long run price elasticities of demand; and third, the cross-price elasticities of demand between labour and energy and capital and energy. Of the 72 long run own-price elasticities of demand, only nine are greater than unity indicating that input demand is inelastic in the long run. Long run energy own-price elasticities vary somewhat; in 11 of the 18 industries, this elasticity is less than  $-.5$ . Labour and capital own-price elasticities of demand appear to be slightly more elastic than those of energy, while the materials' response appears to be the least elastic.

In all but one case there is very little difference between short run (one year) and long run energy own-price elasticities. This result is somewhat surprising for it implies that the firms are able to quickly adjust their energy demand to the level required. In the model, differences between long and short run own-price elasticities of demand for any variable input depend upon the absolute value of the elasticity of substitution between that input and capital. When energy and capital are neither highly substitutable nor highly complementary, the gradual adjustment of capital to its new equilibrium value has relatively little effect on the time path of energy demand. From column 7, we can see that the cross-price elasticities of demand between capital and energy are indeed small (the percentage change in demand for capital with respect to a 1% change in the price of energy). There are much greater differences between short and long run own-price elasticities of demand for both labour and materials; which implies that the labour/capital and materials/capital elasticities of substitution are of more significance.

In 14 of the 18 industries, the capital/energy cross-price elasticity is negative indicating that an increase in the price of energy leads to a reduction in the amount of capital used, i.e., capital and energy are complements in production. The weight of this evidence then is that higher energy prices tend to reduce investment in the manufacturing sector and the rate of growth of capital accumulation.

The estimates also indicate (column 6) that in 12 industries, labour and energy are long run substitutes and that in 6, labour and energy are long run complements. Therefore, any summary statement of the degree of complementarity or substitutability between energy and labour in aggregate manufacturing rests on substantial differences in responses among specific industries. In the short run, only 8 industries exhibit complementarity between energy and labour. Moreover, in two industries energy and labour switch from being short run substitutes to being long run complements while 2 industries show short run complementarity but long run substitutability between energy and labour.

An important parameter of the dynamic model is  $\beta^*$ , the variable representing the degree to which the gap between the desired capital stock and the actual stock is closed within one year. A  $\beta^*$  close to zero indicates a very slow response to exogenous shocks, while a  $\beta^*$  close to unity denotes very quick adjustment. The average adjustment coefficient for all 18 industries is .3, indicating that in the first year following an exogenous shock, 30% of the difference between the capital stock actually held by the firm and the desired stock of capital is closed. After five years, 81% of the change to the desired level of the capital stock has been accomplished.

#### Dynamic Model Estimated with Canadian Data

The elasticities of demand estimated from Canadian data for the 1962-75 period are given in Table 2. Turning first to the last column, the average  $\beta^*$  (estimate of the adjustment parameter) is .38, a value very close to that (.30) estimated for the U.S. in a different time period. The long run energy own-price elasticities estimated with the Canadian data appear in most cases to be somewhat higher than those estimated for the U.S.. In most of the Canadian industries, there is very little divergence between short run and long run energy own-price elasticities. As we indicated earlier, this result is a signal that in the long run, energy and capital are neither strong complements nor strong substitutes; a result entirely consistent with our findings for the U.S.. 11 of the 18 industries show capital/energy substitutability; only 3 of these cross-price elasticities, however, are significantly above zero. The 7 industries which exhibit some capital/energy complementarity again have capital energy cross-price elasticities close to zero. In the U.S., we found that capital energy complementarity predominated. For Canada, however, it is impossible to summarize aggregate manufacturing as showing, in aggregate, either capital energy substitutability or capital energy complementarity. The labour energy cross-price elasticities also vary in sign across Canadian industries. These divergencies are similar to U.S. evidence. The dynamic model allows for short run energy/labour relationships to differ from and slowly adjust to some long run equilibrium value. Estimates with the Canadian data, indicate that in the short run only 4 industries exhibit labour/energy complementarity while in the long run 9 industries exhibit such behaviour. These observations indicate that in the short run, as energy prices increase, firms tend to substitute labour for energy. In the long run however, the impact of higher energy prices is to reduce employment.

Canadian industries exhibit twice as many shifts in energy/labour relationships between the short and long runs (6; 5 industries changing from short run substitutability to long run complementarity) as compared to the U.S. experience. In addition, in 5 Canadian industries (as compared to 3 U.S. industries), 'overshooting' is found, i.e. a greater energy/labour substitutability is found in the short run as compared to the long run.

It is our feeling that the evidence utilizing the Canadian data is more powerful than the evidence from the U.S. data for a variety of reasons. First, the Canadian data include both cross-sectional and time series observations. The additional cross-sectional evidence provides much valuable information. Secondly, the Canadian data have less flaws than the U.S. data.

#### SUMMARY

The evidence indicates that it is important to disaggregate aggregate manufacturing into its various industry components. Factor demand models, including energy demand models, estimated with aggregate data may be misleading for policy purposes since aggregating industries with very different production characteristics may result in

erroneous conclusions as to the nature and characteristics of important relationships among inputs. One of our major conclusions is that it is difficult to summarize 'manufacturing' as conclusively showing energy/labour or energy/capital complementarity or substitutability. The complementarity or substitutability between these inputs varies according to the production structure of the specific industry. Our second major conclusion is that utilizing dynamic models is important for public policy decisions. The results indicated that, in fact, adjustment to exogenous shocks is fairly slow. Results for both the U.S. and Canada indicate that, on average, in the first year after an exogenous change, only 30%-40% of the change to the new desired production techniques has been accomplished. Of course this speed of adjustment varies widely across specific industries. Utilizing the dynamic model also indicates that 'overshooting' can occur, and that complementarity or substitutability relationships change over time. The constraint of having fixed assets and a given technology may force firms in a short run to react to higher energy prices by employing more labour to produce a given level of output. However in the long run, when the firm is able to change its technology by using a new and different capital stock, it may use less labour than it did in the short run. Hence, evidence of employment gains in a specific industry shortly after large energy price increases should not be taken as necessarily representing the ultimate equilibrium response of firms in that industry. Our results indicate that the ultimate long run response of firms to the higher energy prices may well be to lower employment below the immediate short run response, perhaps even to a level less than that which existed in the previous steady state equilibrium. Finally, the evidence for the U.S. indicates that complementary relationships prevail for energy and capital. For Canada, energy/capital relationships are almost equally divided between substitutability and complementarity.

#### REFERENCES

- Berndt, E., M. Fuss and L. Waverman (1977). Dynamic Models of the Industrial Demand for Energy, Research Report EA-590 Electric Power Research Institute, Palo Alto, Ca., U.S.A.
- Berndt, E., M. Fuss and L. Waverman (1979). "A Dynamic Model of Costs of Adjustment and Interrelated Factor Demands, with an Empirical Application to Energy Demand in U.S. Manufacturing", paper presented at the 1979 European Meeting of the Econometric Society, Athens, Greece, September 3-6.
- Berndt, E., M. Fuss and L. Waverman (1980). Empirical Analysis of Dynamic Adjustment Models of the Demand for Energy in U.S. Manufacturing Industries 1947-74, Research Report, Electric Power Research Institute, Palo Alto, Ca., U.S.A.
- Berndt, E., and D.O. Wood (1975). "Technology, Prices and the Derived Demand for Energy", Rev. Econ. & Stat., 57, No. 3, 259-268.
- Denny, M., M. Fuss and L. Waverman (1979). Energy and the Cost Structure of Canadian Manufacturing Industries, Technical Report No. 12, Institute for Policy Analysis, University of Toronto, Toronto, Canada.
- Denny, M., M. Fuss and L. Waverman (1980). "An Application of Optimal Control Theory to the Estimation of the Demand for Energy in Canadian Manufacturing Industries", Proceedings of the Ninth IFIP Conference on Optimization Techniques, Springer-Verlag, Berlin.
- Fuss, M. (1976). "Dynamic Factor Demand Systems with Explicit Costs of Adjustment", mimeograph, Stanford University, August.
- Fuss, M. (1977). "The Demand for Energy in Canadian Manufacturing: An Example of the Estimation of Production Structures with Many Inputs", J. Econometrics, 5, No. 1, 89-116.
- Griffin, J., and P. Gregory (1976). "An Intercountry Translog Model of Energy Substitution Responses", Am. Econ. Rev., 66, No. 5, 845-857.
- Hudson, E. and D. Jorgenson (1974). "U.S. Energy Policy and Economic Growth, 1975-2000", Bell J. Econ., 5, No. 2, 461-514.

- Pindyck, R. (1979). "Interfuel Substitution and the Industrial Demand for Energy: An International Comparison", Rev. Econ. & Stat., LXI, No. 2, 169-179.
- Treadway, A.B. (1974). "The Globally Optimal Flexible Accelerator", J. Econ. Theory, 7, 17-39.

TABLE 1 Price Elasticities of Demand, U.S. Industry Data, 1948-71, Dynamic Model

SIC (1)	Energy (2)		Capital (3)		Labour (4)		Materials (5)		Labour/Energy (6)		Capital/ Energy (7)		$\beta^*$ (8)
	SR	LR	LR	LR	SR	LR	SR	LR	SR	LR	SR	LR	
20 Food	-0.57	-0.57	-0.21	-0.16	-0.13	-0.03	-0.13	-0.13	0.01	0.01	0.03	0.03	.44
21 Tobacco	0	-0.01	-0.58	-0.39	-0.44	-0.07	-0.14	-0.14	-0.02	-0.02	-0.01	-0.01	.30
22 Textiles	-0.18	-0.19	-1.10	-0.22	-0.47	-0.11	-0.33	-0.33	-0.01	0.02	-0.01	-0.01	.21
23 Apparel	-0.01	-0.36	-0.84	-0.22	-0.22	-0.12	-0.23	-0.23	-0.01	-0.01	-0.13	-0.13	.20
24 Wood	-1.09	-1.10	-2.18	-0.53	-1.41	-0.34	-0.85	-0.85	-0.01	0.02	-0.03	-0.03	.12
25 Furniture	-0.08	-0.16	-1.27	-0.35	-0.57	-0.27	-0.35	-0.35	-0.01	0.01	-0.07	-0.07	.21
26 Paper	-0.61	-0.73	-0.50	-0.02	-0.69	-0.02	-0.07	-0.07	0.02	0.12	-0.06	-0.06	.49
27 Printing	-0.48	-0.69	-0.42	-0.38	-0.40	-0.46	-0.65	-0.65	-0.03	-0.02	-0.04	-0.04	.36
28 Chemicals	-0.15	-0.15	-0.48	-0.12	-0.21	-0.04	-0.35	-0.35	0.03	0.03	0	0	.51
30 Rubber	-0.50	-0.51	-0.29	-0.11	-0.17	-0.04	-0.14	-0.14	0.04	0.04	-0.01	-0.01	.61
32 Stone, Clay & Glass	0	-0.38	-0.60	-0.33	-1.80	-0.51	-0.52	-0.52	-0.15	-0.05	-0.04	-0.04	.19
33 Primary Metals	-0.55	-0.65	-0.52	-0.61	-1.06	-0.30	-0.32	-0.32	0.04	-0.04	0.06	0.06	.40
34 Metal Fabricating	-0	-0.25	-1.00	-0	-1.18	-0	-0	-0	0	0.10	-0.09	-0.09	.11
35 Machinery Electrical	-0	-0.01	-2.15	-0	-2.56	-0	-0	-0	0	0.03	-0.02	-0.02	.13
36 Machinery	-0.11	-0.16	-2.25	-0.08	-0.30	-0.06	-0.99	-0.99	0.01	0.02	-0.05	-0.05	.06
371 Motor Vehicles	-0.13	-0.13	-0.55	-0.54	-0.97	-0.17	-0.19	-0.19	-0.03	-0.03	0	0	.63
372 Other Trans. Equip.	-0.30	-0.35	-1.64	-0.01	-0.75	-0	-0.01	-0.01	0.01	0.03	-0.05	-0.05	.09
38 Instruments	-0.5	-0.59	-0.45	-0.51	-0.55	-0.57	-0.82	-0.82	0	0	-0.01	-0.01	.31

SR Short run - one year

LR Long run - time to steady state, dependent on  $\beta^*$  in each industry

$\beta^*$  The % of the gap between the desired capital stock and the actual capital stock closed within one year

TABLE 2 Price Elasticities of Demand, Canadian Industry Data, 1962-1975, Dynamic Model

SIC (1)	Energy (2)		Capital (3)		Labour (4)		Materials (5)		Labour/Energy (6)		Capital/ Energy (7)		$\beta^*$ (8)
	SR	LR	LR	LR	SR	LR	SR	LR	SR	LR	SR	LR	
01 Food	-.44	-.51	-.86	-.07	-.25	-.07	-.29	-.07	.008	-.02	.08	.08	.21
2 Tobacco	-.49	-.49	-.54	-.29	-.46	-.03	-.12	-.03	.01	.02	-.004	-.004	.14
3 Rubber	-.72	-.73	-.80	-.21	-.27	-.10	-.36	-.10	.01	.007	.03	.03	.83
4 Leather	-.46	-.46	-.49	-.20	-.41	-.10	-.12	-.10	.01	.004	.02	.02	.67
5 Textiles	-.07	-.07	-.68	-.41	-.77	-.16	-.49	-.16	.009	-.03	.009	.009	.47
6 Knitting Mills	-.07	-.77	-.92	-.13	-.89	-.08	-.108	-.08	.003	-.04	.19	.19	.08
8 Wood	-.41	-.43	-.37	-.09	-.59	-.08	-.49	-.08	-.02	-.007	.07	.07	.38
9 Furniture	-.67	-.67	-.85	-.08	-.37	-.05	-.11	-.05	.007	.008	-.003	-.003	.32
10 Paper	-.45	-.51	-.81	-.26	-.70	-.14	-.18	-.14	.017	-.11	.08	.08	.33
11 Printing	-.57	-.57	-.15	-.11	-.26	-.14	-.14	-.14	-.005	-.004	-.001	-.001	.19
12 Primary Metals	-1.04	-1.96	-1.59	-.11	-.36	-.04	-1.62	-.04	.09	-.10	.36	.36	.28
13 Metal Fabricating	-.09	-.09	-.27	0	-.47	0	0	0	.030	.033	.003	.003	.38
14 Machinery	-1.46	-1.47	-.62	-.03	-.06	-.02	-.25	-.02	.015	.018	-.02	-.02	.33
15 Trans. Equip.	-.69	-.69	-1.66	-.10	-.94	-.03	-.03	-.03	-.011	-.024	-.05	-.05	.19
16 Electrical	-.52	-.52	-.42	-.10	-.20	-.04	-.09	-.04	.009	.008	.002	.002	.75
17 Non-Metallic Minerals	0	0	-.86	-.27	-1.00	-.19	-.43	-.19	-.03	.06	-.07	-.07	.45
19 Chemicals	-1.01	-2.83	-1.11	-.19	-.27	0	-.60	0	.19	.03	.46	.46	.50
20 Miscellaneous	-.87	-.87	-.33	-.04	0.17	0	-.06	0	.03	.03	-.002	-.002	.43

SR Short run - one year

LR Long run - time to steady state, dependent on  $\beta^*$  in each industry

$\beta^*$  The % of the gap between the desired capital stock and the actual capital stock closed within one year



# SECTORAL ENERGY DEMAND FOR THE BELGIAN ECONOMY: THE CASE OF THE IRON AND STEEL INDUSTRY

**F. Bossier, D. Duwein, N. Gouzée and D. Rigauz**

*Bureau du Plan-Planbureau, Brussels, Belgium*

## ABSTRACT

In this paper, an econometric model for the analysis of energy consumption in the Belgian iron and steel industry is presented. The model is used to simulate the energy needs of the iron and steel industry for the year 1990.

## KEYWORDS

Energy consumption ; stages of production ; price sensitiveness ; substitution between energies ; forecastings.

## INTRODUCTION

The purpose of this paper is to propose a model for the analysis of the energy consumption in the Belgian iron and steel industry. The econometric model distinguishes the main stages of production of the sector and studies, for each of these stages, the evolution of the specific energy consumption of each product. The first part of the paper is devoted to a presentation of the Belgian iron and steel industry situation. This preliminary description shows the interest for a *by stage of production* approach. The second part of the paper is a short description of the model selected for the analysis of the sector. The first simulation results for the year 1990 are also introduced and briefly commented.

## THE BELGIAN IRON AND STEEL INDUSTRY AND ITS ENERGY CONSUMPTION

The production of iron and steel is the most significant user of industrial energy in Belgium, with a share of 38,3 % in the total industrial consumption for 1977. At a global level, the energy used by the iron and steel industry represents more than 15 % of the national energy consumption.

It is therefore justified to bring a special attention to the energy consumption process of this sector, given the increasing need for energy conservation. The iron and steel sector considered here includes the production of pig iron in the blast furnaces, the production of raw steel in the steel furnaces and the steel finishing process in the rolling mills. The production of coke in the coke ovens is treated in another study.

TABLE 1 Trends In the Belgian Iron and Steel Industry

	1966	1970	1974	1976
Pig iron production, 10 <sup>6</sup> tons	8.4	10.8	13.0	9.9
Energy supplied, 10 <sup>6</sup> GJ	202.5	255.1	304.1	226.8
Specific energy for pig iron GJ/ton	24.7	23.6	23.4	22.9
Finished steel production, 10 <sup>6</sup> tons	10.5	12.3	16.0	12.0
Energy supplied, 10 <sup>6</sup> GJ	52.9	66.3	75.5	63.9
Specific energy for finished steel GJ/ton	5.2	5.4	4.7	5.4

As shown in table 1, in the past few years, the efficiency of energy use has slightly increased for the production of pig iron and has fluctuated around a constant level for the production of finished steel.

These results show the interest of a study of the energy consumption which could, at least, distinguish the main stages of production <sup>1</sup>.

#### Technology of Steel Production in Belgium

The production process starts with the preparation of the charge of the blast furnace. The ore is grinded, agglomerated and further treated according to the type of ore. In the last years, the iron content of the ore has constantly risen and the preparation of the charge has gradually become an important stage of the production process.

After preparation the charge is loaded with a sufficient amount of coke, some scrap and some additives into the top of the blast furnace. The coke is used for the reduction of the ore ; thus, this type of energy is also a raw material for the pig iron production.

---

<sup>1</sup> The same kind of approach can be found in other studies. See Reay (1977).

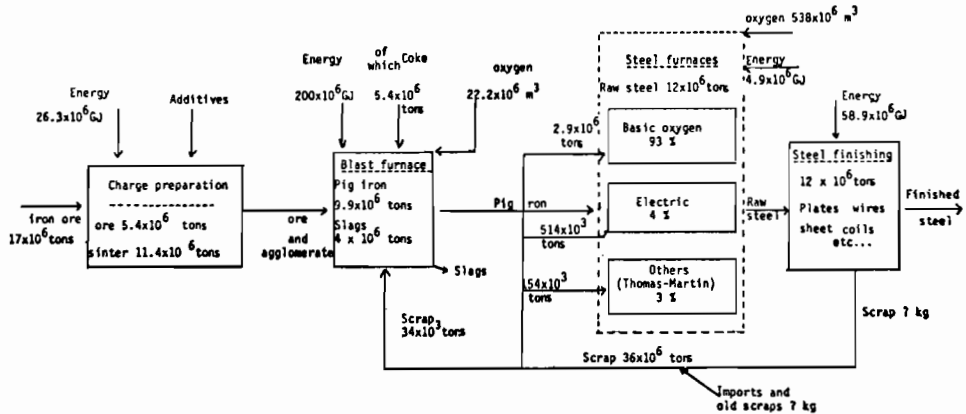

Fig. 1 : The main stages of production in the iron and steel industry (1976)

The Belgian blast furnaces are in general relatively old and not equipped with modern instrumentation and automatization. Yet, modernization efforts are being made. Most of the blast furnaces have been transformed to make possible gas or fuel injections. This tendency to substitute gas and fuel partly to coke has been a result of a constant decrease of the relative prices of gas and fuel before 1974. Studies on that subject [Groupement (1977) ; Szekely (1975)] show that a continuous decrease in the *mise au mille* of coke has been brought by both improvements in blast furnace working and substitution of gas and fuel to coke. In the case of Belgium, however, the value of 1976 is still high, though it dropped between 1965 and 1976 from 650 kg to 540 kg coke per ton of steel produced.

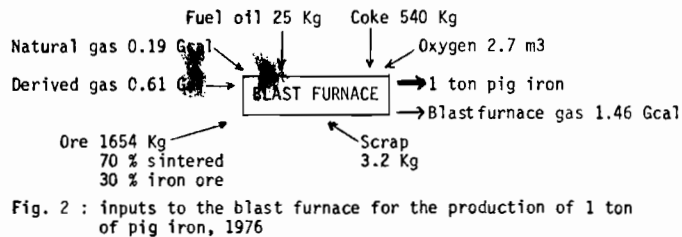

Fig. 2 : inputs to the blast furnace for the production of 1 ton of pig iron, 1976

The pig iron goes from the blast furnace to the steelmaking. In 1976, the oxygen processes (LD + LDAC and OBM) were the most important with a part of more than 95 % of the steelmaking. Electrical steelmaking had a nearly constant part of 4 % and did not penetrate further because of the high cost of electricity and the unstable market of scrap ; it is principally devoted to the production of special steels. Belgian steelmaking is thus very advanced and low energy consuming, so that there is nearly no way in this field to improve energy efficiency.

Finally in the steel finishing stage, continuous casting penetrates slowly. Only a few factories are already working with continuous casting. Most of the installations are still high energy consuming because of repeated cooling and heating operations. Thus, in this stage of production, the amount of energy saving which can be realized is important.

### The Consumption of Energy by Stage of Production

The consumption of energy of the iron and steel sector can be described following the stages of production presented above. The allocation of energy consumption between the four main stages of production is displayed in table 2.

TABLE 2 Allocation of the energy consumption between the four main stages of production (in %)

Production stage	1965	1970	1975	1976
Preparation	5.9	6.7	8.6	9.0
Blast furnace	73.4	72.8	68.2	69.0
Steelmaking	2.4	1.2	1.7	1.7
Steelfinishing	19.2	19.3	21.4	20.3
Total	100	100	100	100

This table shows that the production of pig iron in the blast furnace is the most important energy consuming stage, though its part decreased from 73 % in 1966 to 69 % in 1976. On the contrary, the stage of preparation has been using an increasing part of the energy consumed by the sector (from 6 to 9 %). Afterwards, the steel finishing stage has a relative stable part, fluctuating between 19 and 21 %. Finally, the steelmaking only uses about 2 % of the total energy consumption.

The next table shows the way in which the allocation between the fuels used has changed in the last twelve years. The decrease of the relative part of coal and coke is accompanied by a large increase of the requirement for natural gas, while the fuel-oil keeps its share unchanged. Natural gas is also partly substituted to the other forms of gases.

TABLE 3 Fuel substitution in the iron and steel industry

	% of total energy used by the industry			
	1965	1970	1974	1976
Coke and coal	57.2	51.7	51.3	51.1
Fuel-oil	8.3	9.7	8.1	8.4
Natural gas	-	4.8	12.9	13.3
Other gases	29.2	28.0	20.7	20.2
Electricity	5.3	5.7	7.0	7.0
Total	100	100	100	100

Coke is only used in the stages of preparation and blast furnace. For these stages, coke represents the predominant kind of energy product, with a constant relative part of about 67 %. Electricity is especially used for the steelmaking while natural gas is used in all stages.

The allocation of energy between the different fuels in the future will depend on the relative prices of energies, but also on the technological possibilities to realize these substitutions. A forecasting of the energetical allocation of the iron and steel industry is proposed in the next section.

## THE MODELIZATION OF THE IRON AND STEEL INDUSTRY ENERGY CONSUMPTION

Energy consumption of the iron and steel industry is modeled in order :

- to summarize the main energetical characteristics of the sector by the use of a limited number of relations ; these relations should emphasize the most important factors for the explanation of the energetical behaviour (the prices of energies and of the other factors for instance). They also should include a complete analysis of the possible relations existing between the aggregate factors of production (capital, labour, energy and other inputs). Finally, the model should permit to describe the potential limitations to the substitution between the energy products, by taking into account the origin (energy produced - by-product - or bought by the sector) and use of each form of energy ;
- to simulate, on a ten year basis (1980-1990), the possible evolution of the steel industry energy mix. The study of different scenarios should be based on various price hypothesis. The influence of some technical choices should also be considered (development of continuous casting technique, further development of electric arc units...).

The energetical model developed for the Belgian steel sector is presented shortly below. This model tries to incorporate the kind of information requested to clarify the energetical options of the sector. The main technical relations are briefly described in the first point. The second point is relative to the main results of the model simulation on the period 1978-1990.

### The Iron and Steel Industry Model

The model developed for the analysis of energy consumption is made up of the following relations :

- price relations aimed at analyzing the substitution possibilities between the energies and the aggregate factors ;
- technical relations introducing limitations to the substitution between energies and explaining the origin and development of by-products (blast furnace and coke oven gases).

The model distinguishes the main stages of production of the sector from one another. The price and technical relations are estimated for each of the stages considered (blast furnace and steel making-steel finishing).

The price relations. The price relations are developed on a two-level way. The first level allocates the total sectorial cost between the four main factors of production (capital, labour, energy and other non energetical inputs), each factor demand being a function of all factor prices. The second level shares out the energy expenditure between the main energy products, each energy demand<sup>2</sup> being a function of all energies prices. All demand functions are derived from the minimization of translog cost functions at the two levels of the study<sup>3</sup>.

---

<sup>2</sup> with the exception of by-product gases.

<sup>3</sup> See Berndt-Wood (1975), Fuss (1977).

The kind of price relations considered enables to study the sensibility of factors to price variations. In particular, the relations existing between factors can be specified from the cross-price elasticities estimates.

The technical relations. Beside the set of price relations estimated for each stage of production, technical relations are developed which bring two kinds of informations :

- first, technical relations permit to evaluate the quantities of by-product gases which could be produced by coke ovens and blast furnaces ;
- another set of relations is aimed at controlling the evolution of the specific energetical consumptions (coke ratio, fuel oil and natural gas injections). The energy needed for the ore preparation is also calculated from this set of relations.

Accordingly, the technical relations may improve the information furnished by the price relations. They also complete the information requested for the evaluation of the total energy needs.

The complete model is reproduced in figure 3. It shows how the different levels of modelization are imbricated in each other. Total energy demand (with the exception of by-products) is first calculated at the first level (KLEM level) of the price model. The total resulting energy demand is then allocated between the main forms of energies by the second level of the price model (energy sub-model). The technical relations are used to improve the results coming out of the price models. They also calculate the demand for by-product gases and the energetical need of ore preparation. As a result, the total energy demand can be computed and the total ratio energy/ton of steel can be analyzed.

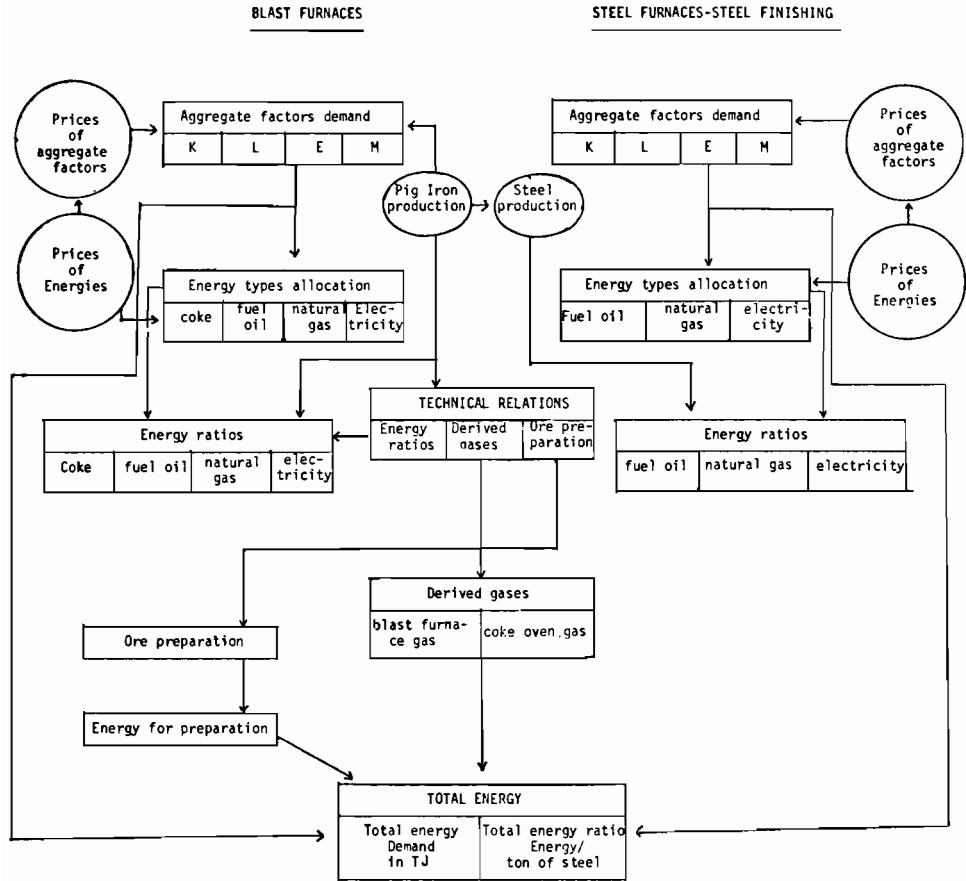

Fig. 3 : The iron and steel industry model  
- Energy consumption by stage of production -

An Application of the Iron and Steel Industry Model : Energy Consumption  
Projection for the Year 1990

A good example of the use of the energy model presented above is the simulation of the energy needs of the sector for some future year. This kind of exercise requires the choice of exogeneous hypothesis regarding the energy and other factors prices and also the level of production expected for the various stages of the iron and steel industry. The simulation has been made for the year 1990 and for three energy price scenarios : a low scenario which is a constant energy prices hypothesis (in real terms), a middle scenario which selects a real energy price inflation of one to two percent and a high price scenario which selects a three to four percent real energy price inflation. As to the capacity of production for the year 1990, it is expected not to exceed its level of 1974. Accordingly, the production of finished steel is fixed to about 16 millions of tons in 1990 (against 12 millions of tons in 1976). The main simulation results are summarized in table 4.

TABLE 4 Simulation results - year 1990

Energy consumed	1976 (observed)	1990 (simulated)		
		low scenario	middle scenario	high scenario
Specific energy for pig iron,GJ/ton	22.90	23.5	22.0	21.1
of which				
- coke used in the blast furnace, kg/ton	5.40	5.46	5.07	4.84
- fuel injections,GJ/ton	1.85	1.62	1.47	1.34
Specific net energy for finished steel,GJ/ton	5.38	5.40	5.14	4.69
of which				
- natural gas, GJ/ton	2.64	2.97	2.68	2.39
- fuel oil, GJ/ton	0.43	0.38	0.21	0.21
Production of by-product gas,GJ/ton of pig iron	6.13	6.23	5.63	5.29

The results displayed in table 4 show how the demand for each type of energy can be influenced by the energy price variations. Thus the past tendency to a decrease of the specific energy consumed per ton of product seems to be reinforced by the new price environment. The results also show in what extent the energy mix can change with price movements. The new energy mix also takes into account the technical choices which have to be done by the industry during the years 1980-1990, to guarantee a gain in energy efficiency, i.e. the choice of more efficient blast furnaces, a more systematic recourse to the continuous casting technique for the steel finishing, the modernization of all other installations...

The consequences of these technical measures are reflected back by the reallocation process which occurs at the level of aggregate factors of production ; increase of the capital and other non energetical inputs share at the detriment of labour and energy.



## CONCLUSIONS

In this short presentation, we have tried to show how the consumption of energy in the iron and steel industry can be explained by a model combining price relationships and technical information. The first results indicate a sensitiveness of the energetical consumption of the sector to the variation of the energy prices.

High energy prices will lead to a decrease in total energy consumption and to a substitution of energy by other aggregate factors. The composition of the energy mix is also influenced by changing energy prices and substitutions between energies, even if limited, will occur.

Yet, the model has still to be completed. First, a more complete approach should include the study of coke ovens, which can be considered as practically integrated in the iron and steel sector. Further, the production of electricity by the sector should be taken into account, given the important possibilities of self-production which exist already of which could be developed in the future. Finally, other technical relations could be included to improve the results obtained with our first exercise.

## ACKNOWLEDGEMENT

The authors would like to thank the *Services de Programmation de la Politique Scientifique - Diensten voor het Wetenschapsbeleid* for having permitted to present the paper.

## REFERENCES

- Berndt, E.R., and Wood, D.O. (1975). Review of Economics and Statistics, 107, 259-268.
- Fuss, M.A. (1977). Journal of Econometrics, 5, 89-116.
- Groupement des Hauts Fourneaux et des Aciéries Belges (1977). Rapport annuel.
- Reay, D.A. (1977). Industrial Energy Conservation, Pergamon Press (Oxford).
- Szekely, J. (1975, Ed.). The steel industry and the energy crisis. New York.



# TECHNOLOGY ASSESSMENT: TWO ENERGY EXAMPLES

**A. R. Demirdache and R. H. Clayton**

*Ministry of State for Science and Technology, Federal Government of Canada,  
Ottawa K1A 1A1, Canada*

## ABSTRACT

One of the major tasks of technology assessment in Canada is to analyze and compare long-term energy options - nuclear fission, nuclear fusion, geothermal, tidal and solar - and to study the related transition from the present fossil fuel economy to a future non-fossil fuel economy. The purpose of this paper is to assess two energy options, nuclear and conservation, within the framework of technology assessment. This paper does not attempt to review the enormous current literature on the subject of energy, but rather to relate the energy question to the technology assessment process.

Using the scenario approach, technology assessment is applied to two alternative energy options in detail. The critical supply and demand assumptions are highlighted and the policy implications suggested. Above all, the sheer difficulty of ensuring adequate energy balances is emphasized.

## KEYWORDS

Technology assessment; entropy; energy reference system; scenarios; nuclear controversy; consumer society.

## INTRODUCTION

One of the major tasks of technology assessment in Canada is to analyze and compare long-term energy options - nuclear fission, nuclear fusion, geothermal, tidal and solar - and to study the related transition from the present fossil fuel economy to a future non-fossil fuel economy. Two points among others can be raised:

- i) The transition period is marked by great uncertainties arising from the trend in consumption, the trend of investment in the energy field, the state of resources and the world political equilibrium. Because of the system's slow-changing nature, if adequate strategies are not adopted, regardless of whether they may seem pointless in the short-term, various types of crises with serious consequences may emerge in the next twenty-five years.
- ii) During the transition which could take from some decades to possibly a couple of centuries, what can be the role of nuclear energy and conservation?

The purpose of this paper is to outline some conditions likely to decide the latter question.

It is clear that the energy problem is partly economic, partly technical and partly social. The conventional distinction between economics, engineering, geology and even biology gradually disappears. Many factors will affect the energy future. (1)\* These include the following:

i) The increasing role of information and knowledge

The future patterns of energy growth will depend more on the exploitation of "information as a resource" and will be less dependent on ownership of traditional factors of production such as land, physical capital, resources and mineral inputs. Knowledge may even become the most valuable property in society. (2)

The service-information economy will result in "restructuring the society" because it will bring profound changes to work and the home. The two places where people spend most of their lives may be profoundly altered. The working environment has already been changed for many people with the rise of white-collar work, but it is likely to change much more in the future. The intrusion of energy technologies, mainly in the utility area, into the home is proceeding, although less rapidly than many technologists had expected.

ii) Increasing social and technical complexity

An important feature of the modern Canadian energy system is the sheer complexity of the institutions and technological structures. The increasing importance of knowledge has resulted in greater specialization, which has increased efficiency at the cost of increased interdependence among organizations, production processes and distribution networks. Modern energy industries have also tended toward extremely large scale, which achieve relative output economies but may lead to rigidity and unresponsiveness to further change. The technical complexity of the energy system has increased the cost of management and coordination. The energy industry now operates under numerous new constraints aimed at environmental protection, worker safety and sales practices.

iii) Increasing rigidity of interest group demands

The increase in the number and power of special interest groups is a main cause of declining growth in the nuclear industry. These organizations include labour unions, professional associations, farmers' organizations, trade associations and other lobbying groups. These groups often have an incentive to block or delay nominations as well as to keep new entrants out of their industry or occupation. Members of a common-interest organization often can gain substantially from a policy that reduces the output of the society as a whole, because they can get most or all of the gains of the policy and bear little or none of the costs.

iv) Entropy as the ultimate limits to energy growth

In the face of this conflict between a complex and rather rigid energy system on the one hand, and social change on the other, the Law of Entropy now also may have to be taken seriously. The Law of Entropy states that the earth's energy and matter are being converted constantly from usable to unusable forms by combustion, wear and tear and rendering to waste. Just as heat always passes from the warmer to the cooler medium and never the reverse, the process of entropy cannot be reversed.

This entropic process occurs at a gradual pace in nature but it is greatly accelerated by man in his quest for even more production technologies and higher levels of consumption. Since the amount of matter/energy from which all useful materials must be derived is limited, the speed by which this endowment is used up will determine how long energy growth and, ultimately, life itself, can be sustained on earth. Georgescu-Roegen(3) insists that living generations have a moral obligation to limit and indeed reduce population and entropy as to "minimize the regrets" of some future generation that must cope with a difficult and possibly violent adjustment, as the requirement of our materials-intensive and polluting society outstrips the remaining resources of the planet.

\*See list of references at the end of the paper.

#### THE TECHNOLOGY ASSESSMENT PROCESS

The easiest way to analyze energy policy is backward through hindsight. Unfortunately, one has to live it forward. Technology assessment is directed towards helping adequate policy development in prospect. It isn't easy. For example, many technology assessment studies have tried to deal with the future by extrapolating forward recent or existing past trends. *"Many forecasts assume that the future is in some ways discernable from purely numerical evidence in the recorded past. Since forecasting has shifted from the prophet and seer to the statistician, the visionary element has been downplayed and the numerical element has received nearly exclusive emphasis."*<sup>(3)</sup> The scenario approach, as will be applied in this paper, tries to blend the visionary and the numerical in a fruitful way.

Technology assessment processes normally consider energy resources and energy demands. While the near-term future could be unsatisfactory in many instances - notably owing to shortages of liquid hydrocarbons - a number of options will lead to satisfactory solutions in the long-run. These options and their systems implications must be identified. Interest then focuses on the transitions from today's condition to one option or a combination of options for the long-term future. However, such transitions have certain constraints which determine strategies for managing such transitions. Capital costs and risk have emerged as major constraints in the consideration of energy systems.

Two schools of thought on general energy strategy have evolved. One school, represented by Amory Lovins<sup>(4)</sup>, favours a "soft technology path". This includes using direct solar energy, wind and biomass conversion; and careful resource conservation. The other, represented by the nuclear establishment, favours a "hard technology path", i.e., technological possibility to produce ample energy for our future while avoiding the use of non-renewable natural resource feedstocks as well as avoiding environmental problems.

If one compares the assessment processes, as they have been applied to date in energy systems, different recommendations are observable regarding desirable future energy technologies. But even greater contrasts exist in the analysis that different groups use to support their recommendations for "hard" or "soft" energy paths.

All methods of evaluation which compare favourable and unfavourable impacts of energy systems rest ultimately on how the assessments are made. Thus, they depend, at their foundation, on the type of data used and on the initial, and differing, premises. Very roughly, analysts fall into one of two groups with respect to their philosophy of assessment. The philosophy of the first group springs from the economic planning theory and views assessment as inference from market data. The second, which includes sociologists and systems analysts, views assessment as inference from the direct replies to an interviewer's questions.

All models provide a breakdown of demand by economic sector and a disaggregation of supply by fuel type. Most often, nuclear electricity is not differentiated from other forms of generation and price elasticity of demand cannot be specified by fuel type. An example of a detailed demand breakdown for Canada is given in the "Reference Energy System for Canada" presented in Figure 1. This description of the Canadian energy system provides a complete physical representation of the technologies, energy flows and conversion processes from extraction of primary energy resources through refining, transportation and storage of energy. In the reference system, energy supplies such as nuclear fuels, fossil fuels and hydropower are allocated to energy demands defined on a functional basis, such as space heating, transportation, etc.

A satisfactory framework for the assessment of the full range of alternative energy policies requires an approach that encompasses both the economic techniques and

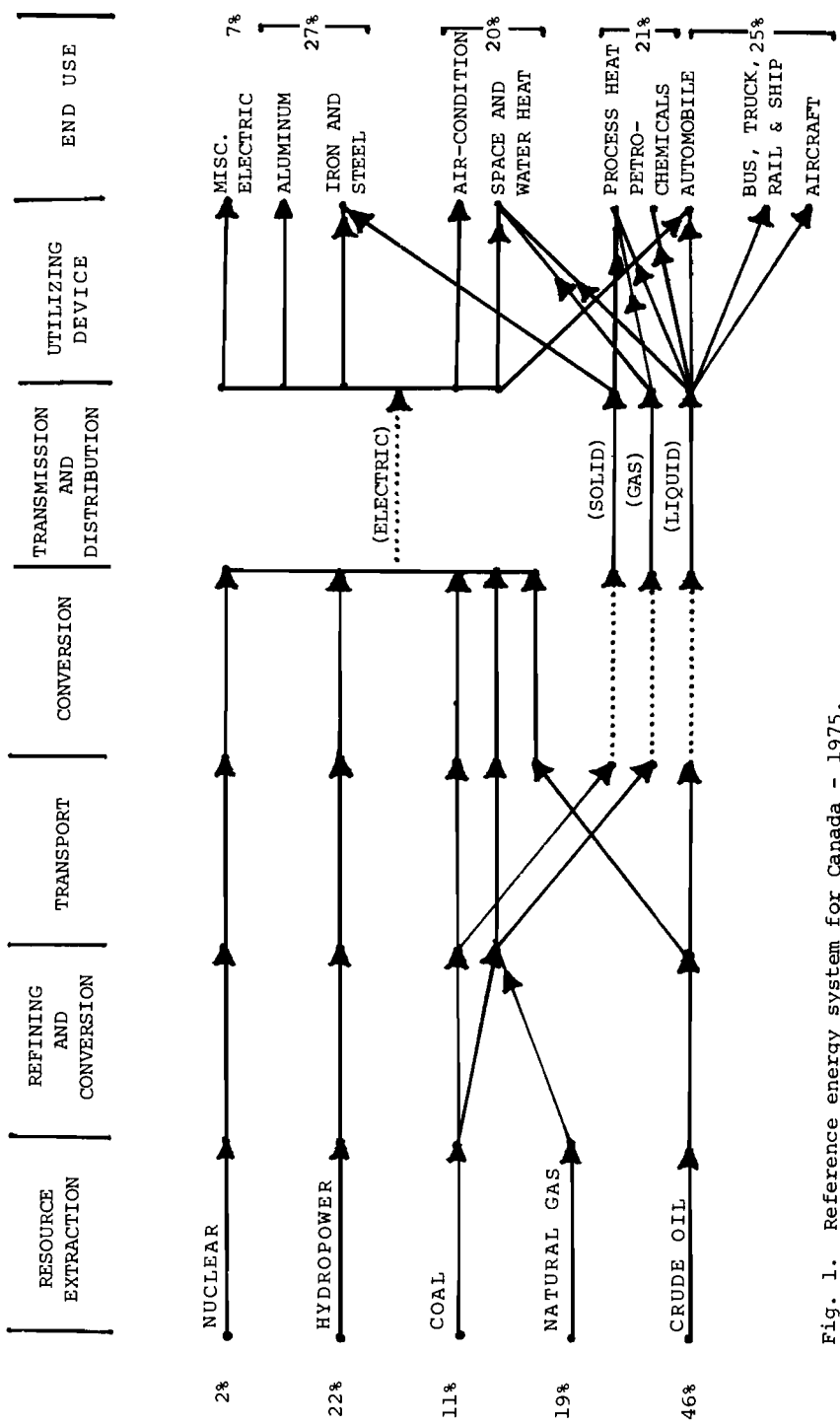

Fig. 1. Reference energy system for Canada - 1975.

systems analysis. This is generally not done because analysts approach problems with a preselected methodology, carrying with it a philosophy of assessment. Recently, however, Kenneth C. Hoffman of the Brookhaven Laboratory and Dale W. Jorgenson of Harvard University<sup>(5)</sup>, have developed a model which combines econometric and systems analysis techniques. The econometric model reflects economic impacts at the aggregate level that result from changes in energy policy. The systems analysis model determines the optimal use of resources for a given energy policy and a given economic environment.

Technology assessment recognizes that an attempt must be made to imagine the different futures that could result from the behaviour of the actors involved within the limits of the systems through which they act. It attempts, therefore, to distinguish trends whose dynamics are almost invariant from those which can be affected by decisions of the actors concerned and by insignificant events. One of the main outcomes of this type of analysis has been the construction of global or partial scenarios worked out at different levels. These scenarios offer pictures of the future and certain time horizons, describe the paths that lead there, and illustrate the consequences of that possible situation or condition. Therefore, interest lies in the light they throw on the possible policies of certain actors, particularly governments.

Scenarios are not forecasts, so much as attempts to cast light on possible or plausible futures. However, some of their characteristics which stand up comparatively well in relation to the assumptions may naturally appear as forecasts. In addition, the various combinations of assumptions are not equally plausible.

The two scenarios outlined in Parts 4 and 5 represent two of the productive avenues to pursue vigorously and simultaneously in Canada, while preparing for the emergence of new energy forms which may become available in the longer term. These scenarios are limiting cases. Their analysis becomes the basis for deriving the broad strategic thrusts of an energy policy. One is a "hard" energy path - an accelerated electricity scenario. The other is "soft" - a Conserver Society scenario.

#### TECHNOLOGY ASSESSMENT AND THE NUCLEAR CONTROVERSY

The use of nuclear technology has become very controversial in recent years. The growth of public opposition which has followed the expansion of nuclear power programs has surprised electric utilities and governments. Public opposition has become a major consideration, perhaps a permanent constraint in the formulation of national policies. In Canada, a coalition of nuclear opponents (Canadian Coalition for Nuclear Responsibility) has emerged as a chief spokesman, and with a number of articulate scientists as technical advisors. This coalition sees in nuclear power installations the potential for catastrophic accidents, sabotage at nuclear plants, and for diversion of nuclear materials into the manufacture of terrorist weapons.

On the other side, AECL (Atomic Energy of Canada Limited), AECB (Atomic Energy Control Board), the utilities and many independent scientists put forward the position that nuclear energy is relatively safe and that its potential for disaster can be contained with current technology. There is a strong case to be made for nuclear-generated electricity as an element in the national energy base. The Federal Government has recognized the contribution that nuclear technology can make to the nation's well-being. *"It would be unconscionable under any circumstances to deny to the developing countries the most modern of technologies as assistance in their quest for higher living standards. But in a world increasingly concerned about depleting reserves of fossil fuels, about food shortages and about the need to reduce illness, it would be irresponsible as well to withhold the advantages of the nuclear age -- of power reactors, agricultural isotopes and cobalt beam therapy units."* (Speech of the then-Prime Minister to the Annual Meeting of the Canadian Nuclear Association, Ottawa, June 17, 1975.)

If the current opposition to nuclear power merely follows the pattern of environmental concern which swept a number of industrialized countries a few years ago, and assuming no fatal accidents actually occur, one might expect it to die away in similar fashion as planning and regulatory procedures are tightened, as public attention is captured by new concerns and as people become accustomed to living with nuclear power stations. But, if the root cause lies in public fears about the peculiar dangers of radioactivity and an association in the public mind between civil nuclear power and the terrors of nuclear weapons, public opposition may intensify and increasingly curb the growth of nuclear power.

Scientists and engineers play a dominant role in this controversy. The debate would long have died if it were not kept alive by a continuing intellectual input of scientifically-derived arguments. The scientists themselves engage in what could be called a purely scientific controversy, i.e., a debate which follows well institutionalized rules.<sup>(6)</sup>

The areas of confusion and uncertainty are the following:<sup>(6)</sup> (a) A prolonged debate on safety assumptions - radiation levels, probabilities of accidents, the safety of emergency cooling systems, toxicity of plutonium, waste disposal and storage of nuclear material (including theft and sabotage prevention). (b) Economic assumptions, notably calculations of the economic rentability of construction and operation of nuclear power plants. (c) Licensing procedures and legislative regulatory standards, particularly for adequate public participation in a field in which decision-making and planning processes require considerable technical and scientific expertise. Adequate forms of public participation have yet to be developed.

The Canadian Nuclear Association recently surveyed the attitudes of Canadians towards the use of nuclear power in producing electricity. The main findings can be summarized as:<sup>(6)</sup> (a) *Levels of public knowledge concerning the use of nuclear power to produce electricity are very low;* (b) *Twenty-one percent of the informed groups are opposed and 68% are in favour of the use of nuclear power for generating electricity in Canada;* (c) *The public rated scientists as the most reliable source of information, then "Television News" programs followed by AECB and the Federal Minister EMR;\* the least reliable sources of information were viewed as the local MPP;\*\*newspaper reports and electric utilities;* (d) *Above all, if a nuclear power plant was planned in a local area, Canadians felt that technological experts, the Provincial Government, and the public at large should be the main participants in the siting decisions.*

#### ACCELERATED ELECTRICAL SCENARIO

This scenario assumes that the use of energy will continue to grow much as it has in the past. (See TABLE 1) On balance, it assumes that the nation would not deliberately impose any policies that might affect ingrained habits of energy use, but rather would make a strong effort to develop supplies at a rapid pace to match rising demand.

This energy future is possible with domestic resources alone through the year 2000. It would require very aggressive development of all possible supplies -- oil and gas onshore, coal, tar sands and nuclear power. If it proved feasible to increase oil imports on a large scale, then the pressure on domestic resources would relax somewhat. Undeniably, the political, economic and environmental problems of getting that much energy out of the earth would be formidable.

This scenario requires the maximum use of all sources to generate electrical power and maximum reliance on electricity for end uses that seem practicable. The key assumptions are summarized as follows:

\* Energy, Mines and Resources

\*\* Member of the Provincial Parliament



TABLE 1 Primary Energy Use for the Accelerated Electrical Scenario - Canada -

	1975		2000		2025	
	Q	%	Q	%	Q	%
Primary Energy Required (Quads - 10 <sup>15</sup> BTUs)	8					
OIL (1000 barrels/day)	3.68	46	1800	29	2250	20
NATURAL GAS (also SNG & imported LNG)	1.52	19	1500 bcf/y	18	3000 bcf/y	16
ELECTRICITY (1) (GWe installed capacity)			60		170	
Hydro	1.76	22	37	22	70	19
Nuclear (5)	.16	2	3	14	55	19
Coal - Thermal (3)	.88	11	20	12	45	16
Nuclear Power Plants (2)			1.5		30	
RENEWABLES (1000 b/d oil equivalent)	-	-	-	5	250	10
THERMAL ELECTRIC COAL (millions of tons/year) (4)			28		60	
	8.0	100	16.0	100	20.0	100

(1) No allowance is made for reserve generating capacity; an allowance of 20% should be added as minimum required installed capacity.

(2) A nuclear plant here has a capacity of 3.2 GWe.

(3) Coal in 1975 includes some oil and natural gas used for electricity generation. That is essentially eliminated by 2000.

(4) 1 tar sands plant (100,000 b/d 10 million tons of coal).

(5) 1975 78,000 boe/d

2000 1.1 x 10<sup>6</sup>

2025 2.1 x 10<sup>6</sup>

\* cumulative brrls 60 billion

\*\* cumulative brrls 240 Tcf

# cumulative 3 billion tons

### Supply Assumptions

- Electric power is intensively generated by hydropower, coal and nuclear power;
- New technology energy sources are introduced as available to generate electricity: solar electric (photovoltaics), wind and tidal; and,
- A minimal contribution is assumed from waste materials.

### Demand Assumptions

- Improved electric conversion efficiencies are introduced;
- Widespread use of electric autos begins; and,
- Technologies to improve efficiency of electricity transmission and distribution are implemented.

### Policy Implications

This scenario corresponds to a forecast in which oil is not available in the future to meet the same energy share as at present and electricity has moved in to meet supply requirements. However, there are long-term problems of electricity: a certain inability to substitute directly for liquid fuels in transportation, buildings and industrial plants. Technological developments in end use devices and changes in infrastructure are required. An important issue is the question of how rapidly electrification of land transportation could be achieved. Electricity does have the advantage of being clean at point of use and has versatility in the resources for its generation. It is as convenient as a wall plug or switch and virtually instantaneous in action. From an energy point of view, an "electrical society" would be a convenient, pleasant society. Electricity already has become associated with much that people regard as the better life.<sup>(7)</sup>

No doubt the difficulties and disadvantages of electricity are likely to increase as substantial growth takes place in its use. However, they are likely to be outweighed by the necessity of using more and more electricity. At least the problems associated with electricity are better known than those associated with new sources of energy supply such as frontier oil and gas, in situ oil sands production, and the new renewables such as solar, biomass or wind. Moreover, the problems to be overcome for an expanded electrical option are likely to be small compared with an over-reliance on world resources, such as oil, LNG and coal.

Long-term future electrical costs might well increase much less rapidly than oil and natural gas, firstly because fuel costs for electricity are a smaller percentage of total costs, and secondly, because three basic resources for electrical generation (coal, water power and uranium) can establish costs and prices independently of oil and natural gas.<sup>(7)</sup>

However, the capital cost component of electricity is severe. One set of projections for electricity, taking into account possible declines in "capacity factor" - percentage of time generating plant is used - showed electricity taking 78% of total energy capital in the year 2000, but providing only 24% of total secondary energy. There is every reason for reducing electricity capital. One way to do this is by eliminating non-essential electricity and by load management. Hybrid heating systems, in which electric space-heating is supplemented by an alternative system, may be a solution.

In the "hybrid" system<sup>(8)</sup>, electricity would provide half the annual heat (or a different fraction if desired) during "off-peak" times and oil or gas the other half. For half the heat, the heating load factor would be 80% and the overall electric generating plant capacity factor could be as high as 75%. Thus,

electricity for heating would be produced at less than the power system's current average cost. The two heating sources could easily be controlled by two thermostats, one for the electric heater and one for the oil or gas furnace. The furnace thermostat would be set a few degrees below the heater thermostat. In this way, the heater would always have priority and the furnace would only come on when needed, that is in colder weather.

This system has an important additional advantage. If widely used, the electric capacity dedicated to it could serve as a reserve which could be withdrawn by the power company on short notice by remote control. The auxiliary heat source would then take over and supply all heat till the heating capacity is released by the power company. There would thus be no need for any idle ready reserve (at present 10%) as kept by power companies to meet partial power failure or unexpected peak demand.

With the "hybrid" system, nuclear electricity would become the cheapest form of power available to business and consumers, at least up to the limit of the "hybrid" system. The extra energy to give electric space heat within the system can be provided at essentially the marginal cost of fueling a nuclear reactor. So the nuclear controversy is not merely an academic discussion over the cost/benefit of different forms of electricity generation - it is an issue affecting how cheaply (perhaps even if at all) Canadians will keep their homes warm.

#### CONSERVER SOCIETY SCENARIO

The "Conserver Society" is a relatively new term but not all the ideas contained in the expression are novel. Phrases like "live within your means" and concepts such as "stewardship" take on a new importance in a Conserver Society.

#### Definition

*"The Conserver Society is one which: promotes economy of design in all systems, i.e., 'doing more with less'; favours reuse or recycling and, wherever possible, reduction at source of materials used; questions the stimulation of excessive per-capita demand for consumer goods by modern marketing techniques; and, recognizes that a diversity of solutions in many systems such as energy and transportation, might in effect increase their overall economy, stability and capacity to respond to changing circumstances."*(9)

#### Background studies

One useful study on the "Selective Conserver Society" was done by GAMMA. GAMMA, an interdisciplinary group composed of professors from the universities of Montreal and McGill, was founded in 1974 to conduct futures research. They investigated a "conserving society" and worked out some of the policy options and their implications to achieve it. The GAMMA study was divided into two phases. The first phase resulted in the publication (in July 1975) of a think-piece which outlined the theoretical basis for the task. In the fall of 1976, the second phase was published in a four-volume report<sup>(10)</sup> which developed five scenarios of the future around the theme conservation/non-conservation. For example, the CS<sup>1</sup> scenario is one of rational conserving society which could be expressed as "doing more with less". The CS<sup>2</sup> scenario depicts a stable state with the theme "doing the same with less". The CS<sup>3</sup> scenario is the most radical of the three conserver societies and assumes a fundamental value change. It would imply an absolute reduction in scale. Its theme is "doing less with less". The Ministry of State for Science and Technology also conducted five seminars held across Canada, on "The Conserver Society: The Technological Challenge". Recently the Department of Energy, Mines and Resources published a study on Energy Conservation in Canada (EP 77-7). This report describes

realistically attainable savings by 2000 for conservation measures which are believed to be technically feasible, economically justified and considered socially acceptable, in the major end-use sectors - buildings, transportation and industry.

#### Policy implications

Planners increasingly concentrate on the scientific and technological implications of the growing need to more carefully conserve natural resources. Yet, it is clear that a trend towards conservation will have wide-ranging social effects. Nevertheless, emphasis to-date is on technological development and it is assumed implicitly that social adjustments will be made in the normal way. There are three policy implications stemming from the Conserver Society. The first concerns the conservation of resources. Much attention is already paid to energy conservation. However, less emphasis is being given to the conservation of materials. The dimensions of the economic threat due to materials scarcities are not well known. There is even less substitutability between different materials than there is between alternate energy sources. A shortage of a specific material - for example any of the ancient non-ferrous metals like lead, tin, zinc, copper, etc., which have risen in real price over the last few years without attracting commensurate increases in production - might cripple one industry yet leave another relatively untouched. Interestingly, if one assumed that conservation is necessary and imminent, and that a whole new line of "conserver" technologies and products will have to be invented, then it follows that whoever breaks the market first could stand to do a booming business. Nations which are slow to develop conserver technologies will more likely than not have to import them. In some cases such as solar energy technologies, the importation of solar panels from the U.S. may result in Canada's using devices which are not ideally suited to our solar regime. In such an event, Canada would lose in two ways: through a decrease in domestic industry and through the use of sub-optimal technology. The recent U.S. announcement of its intention to develop more fully the conserver option makes more urgent the need to consider the industrial implications in Canada of a Conserver Society. Finally, it is desirable, technically feasible and economical to reduce the rate of primary energy growth in the years ahead, at least to the levels of a long-term average of about 2% annually, as set forth in the EMR Study No. 11, or even less. Such a conservation-oriented energy policy provides benefits in every major area of concern -- avoiding shortages, protecting the environment, avoiding problems with other nations and keeping real social costs as low as possible. In discussing the possibility of reduced energy demand, it is sometimes assumed that low growth and conservation might together form a single low demand future. In fact, there are good reasons for believing that these two conditions would, to some extent, conflict with one another. The reason is simple: conservation requires capital financing for new equipment and low economic growth lacks the money to pay for it. The converse is that, to some extent, economic growth and conservation are complementary. Growth allows economies to replace old plants and old machines faster with newer, more efficient designs, a key requirement of conservation. There is no kidding ourselves - to one degree or another - economic growth must be paid for in energy. With no new energy sources of supply, an economic growth rate of (say) 2.0% may well be about the maximum available and this may actually work against optimum conservation. There might come the day when governments have to sacrifice growth - and jobs - to save energy.

#### CONCLUSION

In Canada, as of the end of 1977, 4000 MW of nuclear power was already installed and operating and another 15,000 MW was under construction. Indeed, during 1977 the installed nuclear capacity in the province of Ontario accounted for 27% of total electrical energy generated even on the basis of a comparatively low (70%) capacity factor. Furthermore, based on Ontario Hydro's latest system expansion program, about 80% of the province's electricity would be supplied by nuclear power stations by the

end of the century. The major concerns of critics of nuclear power relate to the health, environmental, safety, economic and political aspects of nuclear power rather than the scientific and technological. To many, nuclear power represents the embodiment of "hard" as contrasted with "soft" technology, the increasing centralization of electric power, and concomitantly, the increasing centralization and dehumanization of society as well as threats to the biosphere. To the proponents, nuclear power is essentially an everlasting source of clean energy that will become increasingly important as oil stocks rapidly dwindle towards the end of the century. They view it as a technology necessary for our social and economic well-being. Virtually all participants in the nuclear debate, however, have agreed with the conclusion of the World Council of Churches Study Group that "Pandora's Box cannot be closed. We cannot live as though nuclear power had not been discovered".

The situation of the world economy will be precarious until the proportion of oil in the world supply of energy (and particularly the proportion of present OPEC oil) has been substantially reduced. Energy conservation, nuclear power development and use of coal - which is cheap and available - are the three avenues to pursue vigorously and simultaneously, while preparing for the emergence of new energy forms which may become available in the longer term, like solar energy, and without losing sight of safety and ecological considerations. In the energy field, each country should intensify its own national efforts. In other words, the energy scenarios are not alternates but rather must be conjoined. What is the rate of "energy growth in Canada"? How is this growth to be financed? How are the end-uses to be distributed? The main issue common to these questions is the balance between the present and the future. "How much does the present generation have to forego (in consumption) to ensure a higher rate of capital stock for future generations? As Robert M. Solow<sup>(12)</sup> has remarked: "We have actually done quite well at the hands of our ancestors. Given how poor they were and how rich we are, they might properly have saved less and consumed more."

A recent report by Professor Wassily Leontief of Harvard University, "The Future of the World Economy"<sup>(13)</sup> makes clear the enormous scale of social and technological effort required to sustain global growth for another 25 years. The study was conducted under the auspices of the United Nations and was primarily funded by the Government of the Netherlands.

The Leontief Study has demonstrated that, on balance and with some exceptions, the arguments are heavily against deliberate policies to halt or slow down the basic long-term technological trend, even if it could be done with safety. Indeed, one would prefer to accelerate some aspects of this trend, while being prudent and generally watchful in order to prevent or reduce the impact of the baneful possibilities. However, it is unlikely that growth can continue uncontrolled for more than another quarter century at the maximum. Thereafter, there will come a period marked by rapidly mounting needs for monitoring, restraining, and even reducing the economic process. Whether a more highly controlled, more commonly organized state to replace the society we now know will be better or worse than present-day society, few can yet answer.

*". . . The first step is to measure whatever can be easily measured. This is okay as far as it goes. The second step is to disregard that which cannot be measured or give it an arbitrary quantitative value. This is artificial and misleading. The third step is to presume that which cannot be measured easily is not really very important. This is blindness. The fourth step is to say what cannot be measured really does not exist. This is suicide."*

Quoted in Hayes, 1974<sup>(1)</sup>

REFERENCES

1. Hayes, D. (1974). *Energy Forecasting*, background paper for the Committee on Mineral Resources and the Environment, National Academy of Science.
2. Heilbroner, R.L. (1974). *An Inquiry into the Human Prospect*, W.W. Norton & Company, Inc., New York.
3. Daly, H. (1973). *Towards a Steady-State Economy*, W. Freeman, San Francisco.
4. Lovins, A.B. (1977). *Soft Energy Paths*, Friends of the Earth, Cambridge, Massachusetts.
5. Hoffman, K.C., D.W. Jorgenson (1977). Economic and Technological Models for Evaluation of Energy Policy, *The Bell Journal of Economics*.
6. Greer-Wootten, B., L. Mitson (1976). *Nuclear Power and the Canadian Public*, Institute for Behavioural Research, York University, Toronto.
7. Gander, J.E., F.W. Belair (1979). *Energy Futures for Canadians*, Energy, Mines and Resources Canada.
8. Clayton, R. (1979). *Canadian Energy: The Next 20 Years and Beyond*, Institute for Research on Public Policy, Montreal, Canada.
9. Science Council of Canada. (1977). *Canada as a Conserver Society: Resource Uncertainties and the Need for New Technologies*, Report No. 27.
10. GAMMA. (1976). *The Selective Conserver Society*, Universite de Montreal/McGill University.
11. Department of Energy, Mines and Resources. (1977). *Energy Conservation in Canada: Programs and Perspectives*, Report EP 77-7.
12. Solow, R.M. (1974). The Economics of Resources or the Resources of Economics, *American Economic Review*, 64, pp. 1-14.
13. United Nations. (1976). *The Future of the World Economy*, Report prepared by a research team lead by W. Leontief.

*Session II*

**INTEGRATED SETS OF MODELS  
AND THEIR POLICY  
APPLICATIONS**





# PROGRESS AND PROBLEMS OF A SYSTEMS APPROACH TO LONG-RANGE ENERGY DEVELOPMENT

**A. A. Makarov\* and A. A. Papin\*\***

*\*Siberian Power Institute of the USSR Academy of Sciences, Irkutsk, USSR*

*\*\*International Institute for Applied Systems Analysis, Laxenburg, Austria*

## ABSTRACT

In the paper an attempt is made, first, to assess both the potential and limits of systems analysis as applied to long-range energy development, and, second, to evaluate past experience in the field, in light of such an assessment. Particular attention is devoted to: the premises underlying the systems approach; its means for reducing uncertainties about the future; temporal limits to its applicability; the state of the art in energy modeling (a principle tool of the systems approach); and possibilities for the further development of energy modeling. The paper also focuses briefly on features of the systems approach that are particularly applicable to energy development under conditions of planned economies.

## KEYWORDS

Systems analysis; energy development; long term; premises and means; temporal limits; energy modeling; energy-economy interconnections; energy supply system; resources; R & D strategies; planned economy.

## PREMISES AND MEANS OF THE SYSTEMS APPROACH TO ENERGY

Systems approach has already been widely acknowledged as the principle methodological basis for studying possible patterns of social and economic development, in particular, energy development. It plays a particularly great role in the so-called 'normative' forecasting aiming not only at plotting possible scenarios of future development but also choosing a preferable one between them with regard to some criteria. However, in spite of the appreciation of the philosophy of systems approach, its initial premises and the resulting requirements to methods, as well as the temporal limits of its applicability have not been defined properly yet. Below an attempt is made to feel this gap.

### Outline of the Traditional Approach

The principle theses underlying most of the energy studies carried out until recently assumed:

- the existence of objective regularities in the development of the phenomena under consideration;
- the possibility of quantifying those regularities or, at least, of finding out quantitative measures for their visible images;
- the validity of the past regularities or their quantitative images in the future.

These theses can be observed most clearly in the simplest case--when a forecast offers an extrapolation of the past trends which are found out by means of analyzing statistical data about the phenomenon forecasted.

The first thesis from those said above seems to be correct--energy as one of the most essential components of the productive forces is developing according to objective laws inherent in them. However, the contents of those laws, and, all the more, their quantitative characteristics, are hardly explorable, and their visible quantitative images are far too multiple and heterogeneous to make the second thesis valid. Finally, the third thesis can be accepted only for making short-range forecasts, and is evidently inadequate for long-term assessment of energy development.

#### Premises of the Systems Approach

Systems analysis is based on premises different from those applied in the traditional approach. Certainly, it rests on past experience and employs a comprehensive analysis of trends of the past development just as the traditional approach does. However, in this case external and internal relationships of the system (especially productional ones) which are observed more easily and therefore are more open for studying, become the principle subject of analysis. Exposure of those relationships and quantitative estimation of their parameters gives the ground to project development of the system.

Thus the systems approach assumes:

1. Possibility of exploring external and internal relationships of the systems studied.
2. Visibility of those relationships and their parameters.
3. Possibility of quantitative estimation of prospective values of the technological parameters characterizing the relationships of interest.

The premises named above express the necessary and, it is believed, sufficient conditions for building a model (formal or partly mental) for the system studied that serves currently as the principle tool of systems analysis. But they do not imply satisfying the extremely important--and frequently forgotten--condition of the adequacy of a model and the modeled system that provides right use of models. As no formal methods of model verification exist yet, modeling continues to be a kind of art accessible for prominent experts in systems analysis, namely those who are capable of selecting the essential relationships of the system from their innumerable number, and of finding the means to check whether the choice was right. One should not underestimate the role of that factor in systems approach to forecasting as well as the resulting 'humanization' or 'subjectivization' of conclusions. It would be incorrect to suppose that systems analysis allows to remove professional limits to the extent that an energy forecast can be worked out, say, by a mathematician or an economist with the same success as by an energy expert.

Taking into account the above reservation one can consider the first premise of the systems approach to energy forecasting as a sufficiently feasible one. The second requirement that implies making models visible and matching modern computers is also usually met by reasonable aggregation of the system's relationships. The major difficulties of systems analysis of energy development are connected with satisfying the third premise demanding for proper informational provisions.

The different kinds of technological parameters which make overwhelming share of input data necessary for systems forecasting of energy might be subdivided into the following three groups with regard to difficulties of their evaluation:

- Parameters of existing or similar new energy technologies, evaluation of which does not offer any principle difficulties.
- Parameters of new energy technologies or of existing ones applied under essentially new conditions (like oil production from deep offshore). The values of such parameters are estimated on the basis of technological, geological, and other projections fulfilled by specialists in connected areas with knowledge of the structure of new technologies and analogs for their main components. Thus, this part of the work on energy forecasting also cannot be made without wide participation of energy experts--not system analysts but technologists.
- Aggregated parameters characterizing complex connections of energy with other sectors of the economy, above all, connections on energy demand. The all-penetrating character of energy makes those connections so fractional and numerous that their detailed modeling is hardly possible and, what is more, harmful because in most cases it could break the consistency of the level of detail throughout the model. Therefore for purposes of long-range forecasting both straight and back energy-economy connections should be modeled in an aggregated way. But this, in turn, demands a determination of future values of a great number of aggregated indices of economic development the technological basis of which is substantially unrecognizable. So far only one way exists of evaluation of such economic indices namely the way of extrapolation of their past trends for the future, that is of making use of traditional (not systems) methods of energy forecasting.

So, the paradox of systems approach to energy forecasting lies in the fact that at some phase of its implementation the necessity has appeared to use extrapolation methods together with their controversial premises. In other words straightforward application of systems analysis to development of real systems is impossible as in that case one would have to study the whole set of interfaces inherent in the economic and social environments. On the other hand the necessity to distinguish the scope of the system studied, demands inevitably outside forecasting of its broken external connections involving extrapolation methods. This paradox seems to discredit the systems approach as one just adding its own hard-met conditions to ones of the traditional approach.

In fact, however, that is not the case if systems analysis is used intelligently. On the one hand, the deeper the modeling of external connections of the system expands outside it the less the errors of exogenous parameters definition affects the results of forecasting. For example, the results of projecting of the productional structure of energy supply systems show much less accuracy if demand for energy, and capital and material resources available for energy development, are given exogenously than in the case when a combination of energy and economic intersector models is applied with exogenous setting the normatives of input-output matrices. In other words, the farther we move the line of exogenously given parameters from projected ones (that is the fuller the systems approach is realized) the less the possible errors in definition of exogenous parameters and, hence, shortcomings of the traditional methods, influence the results.

On the other hand, the errors of forecasting become smaller if a given number of exogenous parameters is greater because the impact of each of them to final results become weaker. Obviously, the latter is valid only if exogenous parameters are mutually independent and show about equal impacts to results. Coming back to the example given above it means that forecasting of the productional structure of the ESS on the basis of exogenously given demand for energy is dangerous as the parameters of energy demand are highly dependent on each other and, getting together, influence the results on ESS development to a very high extent (almost definitely).

As a result, all the shortcomings of traditional ways of energy demand projecting will be inherent in the systems approach to ESS development. On the contrary, joining of an energy model and an intersector model of the economy replace exogenous energy demand assessment (and exogenous assessment of values of economic resources directed to the energy development) by projection of a great number of mostly independent coefficients of input-output matrices of about equal potential impacts to results. Even substantial errors in definition of future values of those coefficients lead to comparatively small total impact to results thanks to the effect of their mutual compensation. For example, if economic and energy development is described by linear models which is currently the case, then the errors in outputs appear to be a few times less than the errors in inputs (this is valid for models of dimension up to 1000 equations if above named conditions are satisfied)--see Table 1 (Makarov and Melentyev, 1973).

TABLE 1 Comparison of Errors in Definition of Inputs and Outputs of LP-Models

No. of Model	Dimension (Equation x Variables)	Relative Error of (%)	
		Inputs	Outputs
1	380 x 900	± 10-15	± 5-6
2	700 x 1400	± 10	± 4
3	440 x 1000	± 10-15	± 5-6
4	125 x 500	± 10-15	± 7
5	350 x 900	± 20-25	± 4

Thus a skillfully made approximation of external connections of the system considered added with straightforward modeling of major ones let minimize--but not remove--the limitations of the traditional methods of forecasting and take the advantages of systems approach. But it should be stressed once again that the high professionalism of forecast-makers who combine general and specific knowledge of the system with mathematical background and sufficient understanding of higher and adjacent systems is an indispensable condition for success.

Means for Reducing Uncertainties in the Systems Approach to Energy

In comparing the systems approach with traditional methods of energy forecasting it is necessary to show by what means the former is capable to provide more room to lower uncertainties of the future. In our opinion this is achieved by two principle means:

*First, by modeling productional connections of the system, which due to high stability over time predetermine patterns of short-to-medium-term energy development (for up to 10 years) and reduce manyfold the number of long-term energy strategies to be analyzed, retaining only technologically feasible ones. The technological links of the system are especially important in this regard as they change only with the introduction of principally new energy technologies. As the large-scale employment of such technologies takes usually about 30 to 40 years then at least for that period of time knowledge available and, hence, feasibility of modeling of technological connections in energy give a firm foundation to foresee the future.*

The problem of territorial connections especially those characterizing the allocation of new fuel bases is more complicated. While geological data available for coal basins are, as a rule, sufficiently reliable for modeling of their long-range

development, the characteristics of new oil and natural gas deposits are not. However, one should take into consideration firstly, more than 10-year lag between the time of discovery of a new oil or gas deposit and the phase of its large-scale development, and secondly, the fact that territorial (transport) connections in this case (especially in the case of oil) are much less important for adequate modeling than technological ones. Thus productional relationships in energy may be foreseen and modeled more or less reasonably for around 30 years ahead (depending on the level of the exploration density of a territory and the prevailing kinds of energy resources).

But knowledge of the composition of productional interfaces of the system studied and an estimation of their parameters obtained with more or less reliability do not guarantee a trustworthy forecast of development of the system. In fact, a description of cause-effect relationships of energy development in a model allows just to outline an extended over time cone-shaped range of feasible energy strategies. As a rule the dimension of that range is so large that it does not give much rapid information about the future. To decrease the level of uncertainties in this case *the second mean of systems analysis is applicable, namely, the intentional selection of preferable or desirable strategies from the number of feasible ones.*

The introduction of an objective function in a model is a great methodological step forward making forecast normative and purposeful. While taken for granted by systems analysts, the significance of this tool has often not been realized by forecast makers. Its meaning is that the subjects of forecasting come to include not only technological structure of the society but also its future aims that is its social order. In fact when for the purposes of global forecasting world energy development is optimized with regard to a single objective function (for instance, in a global LP model) complete world unity is assumed. Such an assumption would substantially affect the results of forecasting. For instance, runs of the gaming model for the world oil market have shown that the level of future oil price is 1.5 times higher in realistic situation of contradictions between oil producers and consumers than in a hypothetical case of full unity among oil producers and consumers (Makarov, 1976). Then, if a model for national economic development operates with a single objective function it means in any way that the assumption of centralized planning is introduced, affecting to a large extent the results. At last, optimization of the energy development of a country with market economy with regard to a single objective function is also an essential idealization--usually not estimated by its consequences--because accounting for competition between energy firms would likely lead to a different picture of energy development. It is curious that studies of some gaming models (Makarov, 1976) have shown that the situation of competition between a small number of large firms offers greater changes in energy development when compared with the situation of market equilibria while the situation of a great number of small competitors show almost the same results as those under condition of market equilibria.

From what was said above it follows that the reduction of uncertainties of the future by the introduction of objective functions into models for energy development is a very informative and binding act determining to a great extent the results of normative forecasting. Making use of this means of systems approach without comprehensive analysis of its adequacy to real conditions of economic and social development would lead to serious methodological error.

#### Temporal Limits of Applicability of the Systems Approach to Energy

In closing the discussion about the methodological foundations of systems approach to long-term assessment of energy development, it seems necessary to evaluate its general consistency with the problems to be solved. Let us try to do so in proceeding from the pragmatic goals of long-range energy forecasting.

In our opinion those goals can be outlined as follows (Makarov, 1977):

1. Assessment of preferable long-term energy R & D strategies with corresponding distribution of capital and material resources among R & D programs.
2. Finding out the necessity and timing of development of fuel production in bound areas with elaboration of measures for making proper technological and macro-structural provisions.
3. Assessment of expedient levels of energy conservation in the long-term future with recommendations on proper and timely changes in patterns of technological, economic, and, perhaps, social development.

What is the final time horizon that should be analyzed in order to reach the above goals? Are the methods of systems analysis capable of providing sufficiently trustworthy estimations of energy development throughout that horizon? Let us try to answer these questions.

In finding out the preferable energy R & D strategies, forecasts of the energy development are necessary to estimate possible timing, scales, and impacts of deployment of different technological innovations. Following Burkov, Irikov, and Makarova (1980), let us mark out three 'strata' of innovations being developed at any point of time: ones under industrial testing; designed ones; and ones under demonstration on physical feasibility. According to trends in timing of development of R & D programs over the last few decades, studying the first 'stratum' would require information about development of energy systems for 10 years ahead, the second 'stratum' for 15 to 20 years, and the third one for 30 to 40 years ahead. It follows from the earlier sections of this paper that studies of the first two 'strata' of innovations may be provided with necessary system's data. As far as the third 'stratum' is concerned it appears under conditions of uncertainty--it is the shortage of data about costs and efficiencies of technologies being in initial stages of their development that imposes the temporal constraints on the modeling of technological interfaces in energy. Thus systems analysis can help only to find out the demand for principally new technologies over the next 30 to 40 years and to estimate the utmost levels of their parameters at which they still can prove commercial feasibility. But it cannot help to make a reasonable selection among the new technologies or even to range them in the order of priority (although there are no formal limits in doing so). Fortunately usually the share of such principally new technologies in total R & D spendings makes less than 10%. Therefore, taken as a whole the problem of concentrating of economic resources on the most promisable R & D programs may be solved by the methods of systems analysis (Burkov, Irikov, and Makarova, 1980).

The matter of the second pragmatic goal--preparation for production of fuel from bound areas--stands a bit worse. The necessity of making such decisions when looking at past experience, must be determined up to 20 years in advance. Usually, this perspective is supplied rather sufficiently with technological data, and that allows to find out the very fact of necessity to come to bound areas. But for fuel resources with costly exploration (that is for oil and natural gas) the allocation and possible scales of fuel production in nonexplored bound areas stay out of correct modeling, and, so, out of quantification. It means that in this case it is impossible to substantiate the timing of preparatory measures, especially, the measures on regional macro-development. Resources of high level of exploration--coal and nuclear energy--play the role of marginal sources of energy and, because of that, estimations of their future development are affected by all possible errors in estimation of energy demand and development of other energy resources. Therefore making use of the methods of systems analysis one can succeed in estimating the allocation and establishing the priorities in development of new bases of coal and nuclear fuels production. But getting a trustworthy estimation of required scales of their development seems to be unrealistic, because of low reliability of existing geological estimations of hydrocarbons.

Thus, in regard to development of fuel production in bound areas systems analysis can give reasonable data about:

- necessity and timing of development of bound areas that allows to judge about requirements in new exploratory and productional equipment.
- sequence of priorities in development of new large fuel bases (for oil and gas such data is usually very rough) that gives a basis to start (or be prepared to) projecting activities on some of those bases.

The rest of necessary preparatory measures including ones for development of macro-structure in bound areas, cannot be grounded on results of forecasting and, therefore, is to be taken while watching the actual process of energy development.

Finally, systems approach offers a basis for analyzing only principle components of energy conservation policies in a rather aggregated way. For instance it can help in examining the necessity of essential shifts in technological structure of energy consumption (like the shift from light motor fuel to diesel fuel and, later, to electricity in transportation sector). It should be noted here that the level of reliability of such estimations is believed to be about the same as of those connected with any other principle technological innovations in energy. Further, the systems approach can provide an estimation (in order of magnitude) of necessary shifts in the intersectoral structure of the economy, as well as in the patterns of final consumption of GNP. But at the same time an estimation of a whole mass of possible concrete changes in the economy and their potential contributions in energy savings does not seem possible by means of energy forecasting.

So, comparing the requirements to informativity of long-term energy forecasts with feasibilities of systems approach one has to recognize that currently it cannot be considered as a methodology fully adequate to the goals of long-term energy assessment. And though systems analysis is considerably more appropriate for purposes of energy forecasting than traditional methods, improving of its feasibilities is an important scientific problem. In connection with this it is worthwhile to analyze the concrete tool of systems approach to energy--mathematical models--in order to outline major possible directions of its further development.

#### LONG-TERM ENERGY MODELING: TODAY'S STATE AND FURTHER PROSPECTS

At present there are some versions of the hierarchical set of mathematical models developed to assess long-range energy development at national/regional level<sup>1</sup> (see, for example, Behling, Cherniavsky, and Hoffman (1977); Connolly, Dantzig, and Parikh (1977); Häfele, and Basile (1978); Makarov (1976); Manne (1977); Schöler (1979)). Their analysis shows a clear tendency of unification of the structure of the model's families, that is, of gradual adoption by more and more researchers of nearly the same composition of the models, however, with substantial differences in their contents. In our view that reflects the natural process of making a tool of research consistent with problems to be solved. The typical set of models is characterized below with more emphasis on its comparatively new elements.

#### State of the Art in Long-Term Energy Modeling

Not immediately, but quickly enough energy forecasters came to the conclusion of the impossibility of getting trustworthy estimates on energy development without at least aggregated *estimation of development of the economy as a whole* (Figure 1).

---

<sup>1</sup>We do not touch on the problems of global energy modeling here.

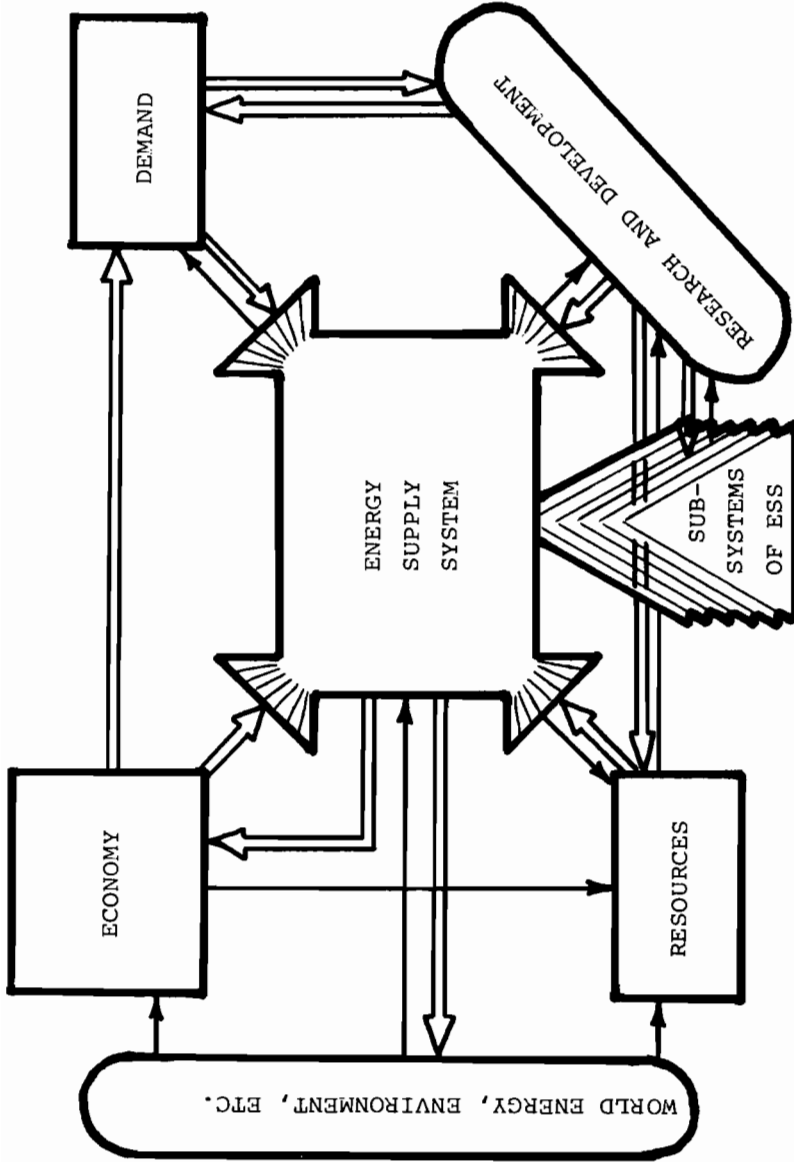

Fig.1 A systems approach to the assessment of long-range energy development



Though very aggregated but direct modeling of the system of higher level of hierarchy (for the energy it is the economy) is an indispensable condition for systems analysis. Note, that the overwhelming majority of energy forecasts developed by traditional methods so far assumed exogenously given few hypotheses of economic development. At the beginning of the implementation of systems approach to energy attempts were made to do the same. But it became clear very soon that by doing so, accounting was missing for very important correlations between level of energy demand and amount of economic resources available for energy development. Besides, the possibility was missing for analysis of energy-economy feedbacks, that is, for quantifying the impacts of energy development to economic growth. The latter is extremely important on present and future stages of energy development because of the observed and anticipated sharp growth of its requirements to the economy. Neglecting potential impacts of any of the two-side energy-economy relationships to results would make major goals of energy assessment unachievable.

*Projections of demand for energy is an integral part of long-term energy assessment.* The question is not whether such projections are necessary but which section along the chain of energy conversions can give most reliable estimates. Until recently almost all energy projections assumed energy demand given in terms of so-called secondary energy--electricity, heat, and directly used liquid, gaseous and solid fuels. Thereby the substitutability between different kinds of secondary energy that determine productional structure of energy in dependence on relative costs of secondary energy production, was left out of the analysis. Methodologically fulfilling long-term projections of energy demand in terms of useful energy (by energy consuming processes) seems, therefore, to be more correct.

*Estimation of energy resources availability* is another traditional component of energy forecasting. A comparatively new element of this part of energy studies is the presentation of resources as functions of production costs and prices. That is what allowed to formulate the problem of optimization of productional structure of energy. In a broader sense energy resources projections must include separate cost estimates on resources exploration (especially for oil and natural gas) with finding out the geological features of deposits, and on fuel production with evaluation of optimized development of large fuel bases over time. The latter is closely connected with the optimization of the productional structure of energy.

A very important component of long-term energy studies is *the assessment of R & D strategies*. The necessity of such assessment is beyond doubt, but usually it is done by means of exogenous assumptions about the composition of new technologies to be considered, their build-up rates, and cost parameters, whereas systems approach requires straight analyzing of impacts of patterns of energy development to directions and rates of scientific and technological progress in energy. Studying and modeling of these impacts is still a problem to be solved.

Finally, *assessment of dynamics of productional structure of energy* (or, in other words, assessment of proportions of ESS development over time) is made on the basis of modeling mainly its technological interfaces while territorial connections are often neglected. For most countries and compact regions (like Western Europe) such an approach may be accepted but for countries like the USA or USSR, or for big regions like North America, characterized by great distances and high variety of geographical conditions, modeling of territorial connections seems quite necessary. At the same time accounting for *environmental constraints* as well as *conditions and limits of imports or exports of energy* and some other factors is required.

So, in our opinion, further efforts on improving the composition of the models should go in the following main directions:

- direct modeling of economic development with accounting for straight and back energy-economy relationships which determine parameters of energy demand and impacts of energy development to economic growth;
- modeling of geological and economic aspects of long-term energy resources development (first of all, development of oil and natural gas resources);
- studying and modeling the R & D strategies in dependence on patterns of energy development.

It would also be valuable to make an effort for further improvements of energy demand models in the direction of more adequate description of markets for different kinds of energy in the main consuming sectors, as well as of energy supply models for direct introduction of major territorial relations, and economic and environmental constraints.

Below the possible approaches are considered to the realization of the above listed directions of improving the system of models for long-term energy assessment.

#### Modeling of Energy-Economy Interactions

By now there are two different approaches to economic modeling for purposes of energy forecasting. The first one prevails at energy studies under conditions of market economy. It was applied, for instance, in studies by Behling, Dullieu, and Hudson (1976); Manne (1977), and has been developed at IIASA (Häfele, and Basile, 1978). This approach in general case makes use of three kinds of models, namely: a macroeconomic model describing the potential GNP growth as a function of capital and labor resources, labor productivity, and some other macroeconomic indices; intersectoral input-output models yielding balanced states of the economy in different points of the future and thereby providing inputs to energy demand calculations; and energy-oriented input-output model for assessment of impacts of different energy strategies to economic development.

This approach should be appraised as methodologically correct for studying the economic development under strong monopolization of the markets. Its consistency with such a situation is explained by the fact that all three models lack objective functions, in other words, are not optimizing. Probably such an approach is more adequate to conditions of market economy than any other one assuming an exogenously given criteria of economic growth (like maximization of GNP or final consumption), as the latter would be equivalent to hypothesis of transition to planned way of running the economy.

However, the lack of optimization models, as was said, makes the quality of energy projections worse. In fact, an econometric macro-model for economic growth that serves as a central element of the above approach, is a classical example of traditional methods of forecasting with their premises impracticable in long term. But this model is one that provides energy demand calculations with key parameters of economic growth and, thereby, predetermines the results on energy demand and affects to a large extent the results on energy supply. Therefore, the final results of forecasting appear to be in strong dependence on the a priori knowledge of character and parameters of the functions underlying the macro-model.

Equally, the approach considered does not provide an analysis of the correlation between the future levels of energy consumption and the sum of economic resources that may be directed to energy development (the latter is important for countries where energy is substantially state-owned), because none of the models used introduces investments by sectors of economy. Finally, the impacts of energy development to the economy are evaluated in a rather aggregated way--by total capital investments required not over the whole set of sectoral necessary outputs--due to the same disadvantages of macro-economic model.

Thus, this approach to modeling of energy-economy interconnection does not realize all possibilities of systems analysis. That is explained not by the shortcomings of the systems analysis, but by objective difficulties of long-term forecasting under conditions of market economy.

In planned economy an optimized dynamic intersector model is used for projecting economic growth. There are two existing modifications of such a model. The first one is an LP model (Zimin, 1980) and the second one represents a set of input-output submodels coordinated by special iterative procedure which simulates major stages of the economic analysis (Gershenson, 1977). While not giving the features of those modifications it should be however noted that both of them describe in some detail the technological interfaces in the economy and maximize public consumption (with qualitative improvements of its structure) under some constraints, in particular, one on available labor force.

The implementation of optimizing economic models is also connected with certain difficulties. These difficulties result from the necessity to forecast the evolution of around two thousand coefficients of input-output matrices (in the models for market economy their number reaches 1,000). As it was said above, currently such forecasts can be done only on the basis of extrapolation. The reliability of such forecasts for planned economy might be a bit higher because the basis for extrapolation is composed not only of past meanings of the coefficient but also of their planned values for 10 to 15 years ahead. For instance, in the USSR in order to estimate values of input-output coefficients for long-term perspective, the historical data from 1968, as well as the results of planning calculations for the period up to 1990, are used. On the basis of such 22-year statistics which, moreover, reflects partly changing conditions for energy development, one can set to forecasting the coefficients for another 20 to 25 years that is up to 2010-2015. It is also important that most of the extrapolated parameters are independent of each other, and impacts of each of them to rates and proportions of economic development are small; these facts allow to count on mutual compensation of errors in accordance with the Law of large numbers.

Having an optimization model for the economy developed an iterative procedure of intercoordinated assessment of long-term development of energy and the economy may be organized in such a way that economic projections would give: inputs to energy demand calculations; dynamics of prices for economic resources demanded by the energy supply system development; and values of major kinds of economic resources allotted to energy development over time. On the other hand, assessment of long-term energy supply strategies would provide data for correction of the input-output coefficients for energy-correlated economic sectors.

Certainly, the above named advantages of optimized models for the economy do not guarantee reliable results of energy forecasting by themselves, nevertheless they make forecasts more grounded--within the limits of our today's knowledge.

#### Energy Resources Modeling

Generally speaking, in order to estimate values and costs of any kind of energy resources available in a given region, three different processes have to be modeled: geological processes resulting in availability of potential resources; resources exploration providing additions to proven reserves; and fuel extraction that provokes a necessity of accomplishing combined geological and techno-economic assessment.

Modeling of those processes is at present in progress and assumes two essentially different approaches. The first one rests on the method of analogies that is, it

searches for resemblance of the characteristics of a given geological region to those of better explored regions, and thus estimating availability of potential energy resources in that region, and the levels of exploration and development costs. The data obtained compose a basis for the following, more formal, optimization of paths of resources development (as it is done at IIASA<sup>2</sup>). It is clear, that, as far as mental modeling exceeds formal one in this case, the confidence in such estimations is fully dependent on the proficiency of analysts.

Second approach implies direct modeling of geological situation in the region, followed by formalized estimation of levels and costs of fuel production (Golovin, Kitaygorodsky, and Fainshtein, 1979). The relationships and the statements of the geological model introduce some a priori geological hypotheses and the numerical meanings of its parameters are simulated by the Monte Carlo method on the basis of available exploration statistics for the region.

Estimates of potential fuel resources available in the region, as well as the total number of perspective geological structures underlying those estimates, represent major inputs to the model. Note, that those estimates may be specified while simulating the process of exploration in the model. Model runs give probabilistic estimates of additions to fuel reserves (by groups of deposit of the same size and deepness) versus exploration costs--see Figure 2.

These estimates go as inputs to the linear-programing model which optimizes exploration activities and fuel production level over time, as well as defines dynamics of marginal production costs. Other inputs to the model include, in particular, depletion rates of reserves by groups of deposits, demand for fuel produced in this region versus price, and, if necessary, total investments available for resources exploration and development. Obviously, two latter groups of inputs can be obtained only from assessment of ESS development strategies that necessitate rather tight linkage between energy resources models and a model for ESS development.

#### An Approach to Energy R & D Modeling

Scientific and technological progress is one of the most important factors affecting long-term energy development. In energy studies conducted so far R & D strategies are assumed as a rule, developing independently on general energy development. In fact, the course of scientific and technological progress is essentially determined by demand of ESS for technological innovations. At the same time, it submits to its own logic that gives a principle ground for direct modeling of R & D strategies. The question is to describe the kind of interfaces in research and development of new technologies like influence of successful development of one technology to development of others if they have common physical or technological components. Exploring and modeling of such interfaces would allow us to find out internally consistent R & D strategies and give a coordinated estimation of expenditures following their realization.

Figure 3 gives a schematical representation of the system of models for R & D forecasting that has been developed on this ground in the USSR (Burkov, Irikov, and Makarova, 1980). In this system the energy supply model serves for estimating of rational scales of future deployment of technological innovations and their impacts on ESS strategies. Two other groups of models are intended to estimate expected techno-economic characteristics of new technologies through assessment of possible alternatives for technological innovations with taking account of limited capital

---

<sup>2</sup>Unfortunately, no published data are available.

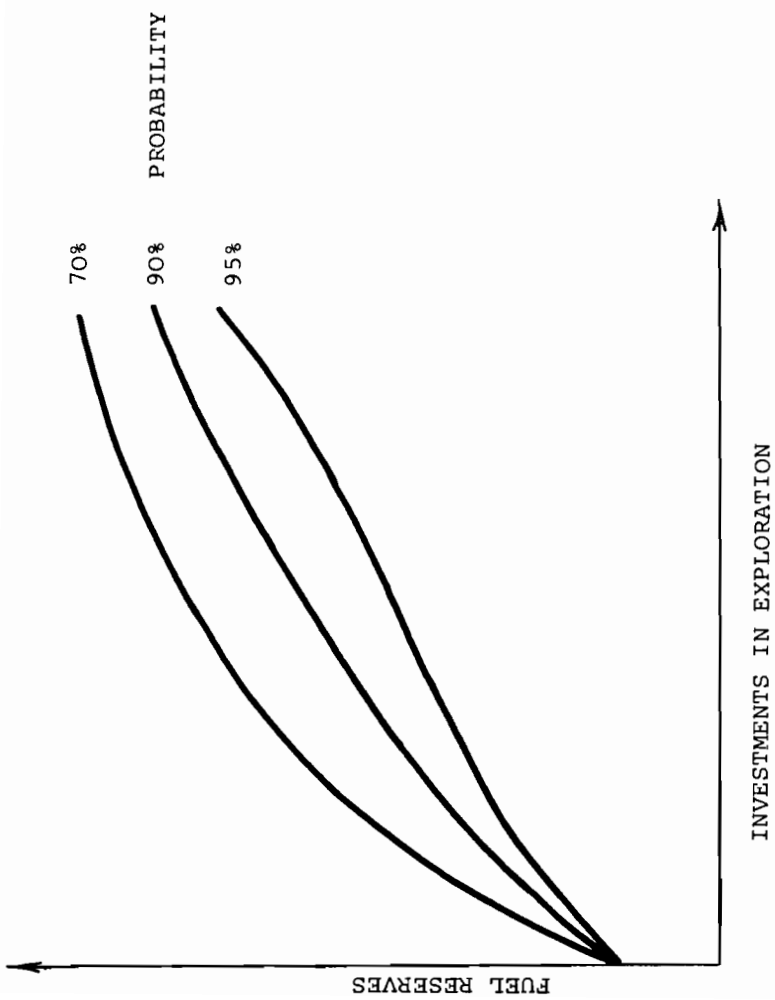

Fig.2 Probable estimates of fuel reserves versus exploration investment

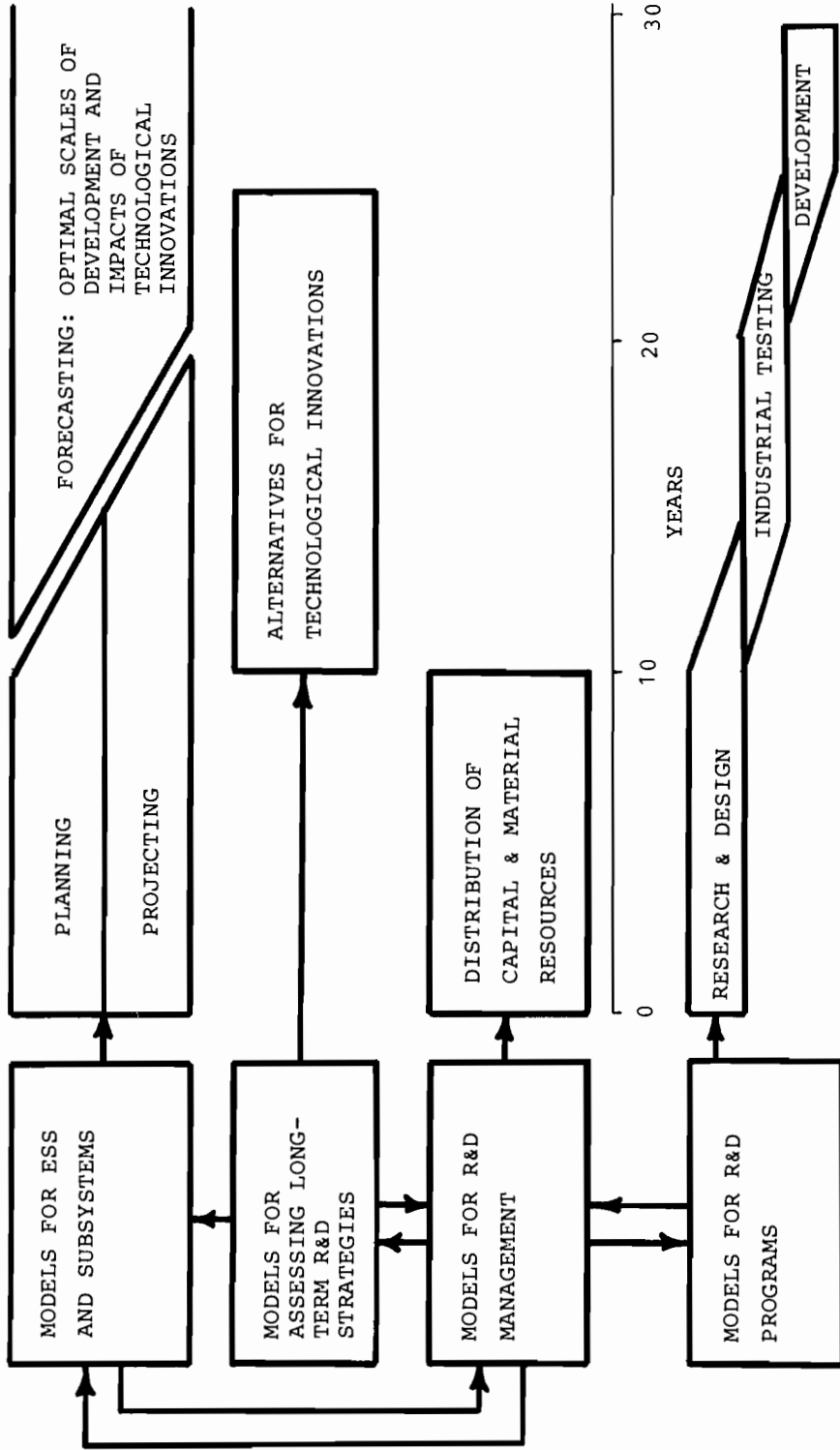

Fig. 3 An approach to energy research and development modeling

and material resources available for Research and Development. Apparently these models should be linked with the models for particular R & D programs.

Energy Research and Development modeling is quite a new business, entailing great difficulties, and international scientific cooperation in this sphere could be extremely helpful.

In conclusion, we would like to express optimism in respect to systems analysis of energy--the fact that methods and models have been developed do not fully meet the requirements of long-term energy assessment yet, will surely serve as a good incentive for further methodological efforts.

#### REFERENCES

- Behling, D.J., R. Dullieu, and E. Hudson (1976). *The Relationship of Energy Growth to Economic Growth Under Alternative Energy Policies*. BNL-50500, Brookhaven National Laboratory, Upton, N.Y.
- Behling, D.J., E.A. Cherniavsky, and D.C. Hoffman (1977). *Overview of Technological-Economic Models for Energy Policy Analysis*. BNL-2273, Brookhaven National Laboratory, Upton, N.Y.
- Burkov, V.N., V.A. Irikov, and A.S. Makarova (1980). Assessment of Scientific and Technological Progress in the Approach to Energy Development Forecasting. Proceedings of IIASA/IFAC Symposium on Modeling of Large-Scale Energy Systems, Laxenburg, Austria.
- Connolly, T.J., G.B. Dantzig, and S.C. Parikh (1977). *The Stanford PILOT Energy/Economic Model*. Technical Report SOL77-19, Stanford University, Stanford.
- Golovin, A.P., V.Ya. Kitaygorodsky, I.Ya. Fainshtein (1979). Models for Energy Resources Forecasting and Optimization. *Economics & Mathematical Methods*, 5.
- Häfele, W., and P. Basile (1978). Modeling of Long-Range Energy Strategies With a Global Perspective. Proceedings of the Eighth IFORS International Conference on Operational Research, Toronto.
- Makarov, A.A., and L.A. Melentyev (1973). *Methods of Energy Study and Optimization*. Nauka, Novosibirsk.
- Makarov, A.A. (1976). In A.A. Makarov (ed.). *Problems of Energy Forecasting*. SPI, Irkutsk.
- Makarov, A.A. (1977). In Yu. Kononov (ed.). *Methods of Systems Analysis for Long-Term Energy Development*. CP-77-2, International Institute for Applied Systems Analysis, Laxenburg, Austria.
- Manne, A.S. (1977). ETA-MACRO: A Model of Energy-Economy Interactions. In C.J. Hitch (ed.). *Modeling Energy-Economy Interactions: Five Approaches*. Resources for the Future, Washington, D.C.
- Schöler, U. (1979). Dynamic Simulation: An Approach to Energy Planning. In A. Strul (ed.). *Energy Models for the European Community*. IPC Science and Technology Press Ltd.
- Gershenson, M.A. (1977). Intersector Models for Long-Term Energy Forecasting. In Yu. Kononov (ed.). *Methods of Systems Analysis for Long-Term Energy Development*. CP-77-2, International Institute for Applied Systems Analysis, Laxenburg, Austria.
- Zimin, I., and A. Propoi (1980). *Dynamic Linear Programming Models of Energy, Resources, and Economy - Developing Systems*. Accepted for publication at the International Institute for Applied Systems Analysis, Laxenburg, Austria.





# INTEGRATED MODELING FOR ANALYSIS OF ENERGY POLICY DECISIONS

**Dr. Edward G. Cazalet**

*Decision Focus Incorporated, 1801 Page Mill Road, Palo Alto,  
California 94304, USA*

## ABSTRACT

Two sets of integrated energy models and their applications are described. The first set of integrated models is designed to address the need for additional electric power capacity in the face of uncertain future demand growth. Models of electric power operation, finance, and consumer preferences are integrated with methods for representing demand uncertainty. Using a common computer software package, integrated planning models have been constructed for dozens of U.S. electric utilities, and the results have been employed in several regulatory proceedings.

The second set of integrated models is designed to address medium- and long-range energy-economic policy and energy technology research and development issues. Models of all energy industries and processes and the rest of the economy are integrated to provide projections of energy supply and demand, capacity additions, financial flows, and economic impacts. Several modeling groups in the U.S. Department of Energy and its National Laboratories, industry-sponsored research institutions, and electric power companies presently use a common software system for constructing large-scale integrated models for their specific needs.

The basic approaches of both sets of integrated models are presented, discussed, and summarized. References to detailed documentation of the models and methodologies are included.

## KEYWORDS

Energy policy decisions; integrated energy models; economic models; power system planning; decision analysis; energy supply.

## INTRODUCTION

Analysis of energy policy problems requires modeling of complex economic markets, technological change, resource depletion, energy-economy interactions, environmental impacts, and uncertainty. Integrated models that combine all of these relevant aspects of an energy decision problem are very helpful in focusing information gathering and debate on the sensitive issues. This paper describes two sets of integrated models for energy decision making. The two sets of integrated models are quite different in terms of scope and detail and therefore illustrate how integrated models can be tailored to the problem.

The first set of models is used extensively for electric power system planning, while the second set is used extensively for broad national and regional energy planning. The computer modeling systems used to construct each set of models are also different. Both computer modeling systems and the initial models were constructed by the author and his colleagues at Decision Focus Incorporated under contract to various organizations.

## INTEGRATED ELECTRIC POWER CAPACITY PLANNING

This first modeling system integrates simplified versions of accepted electric power utility models and methods of assessing electric demand uncertainty and consumer preferences (Cazalet, Clark, and Keelin, 1978; Clark and others, 1979).<sup>1</sup> The methodology emphasizes decisions concerning the alternative levels of electric system capacity additions required to meet uncertain future electric demand. Detail in the model relevant to other decisions on such projects as electric power pricing and load management is included only where it is relevant to the determination of least-cost levels of capacity addition.

The primary output of the methodology is the characteristic over/under capacity curve shown in Figure 1. The vertical axis of this curve is total consumer cost, which includes all costs of providing electricity to present and future electricity consumers, including environmental, electric service outage, and monetary costs. The horizontal axis of this figure is planning reserve margin, the percentage increment on expected peak demand in a future year used to determine planned total capacity in that future year.

Figure 1 shows how total costs to consumers are affected by the level of planning reserve margin. As the planning reserve margin increases, outage cost can diminish rapidly because system reliability improves. Variable costs (mostly fuel costs) may decline as a result of increased flexibility to operate low variable-cost units. Fixed costs increase with increased planning reserve margin, since a larger investment in new

---

<sup>1</sup>This capacity planning methodology was developed under a contract with the Electric Power Research Institute, Palo Alto, California.

plants is required. Environmental costs may increase, decrease, or show little change, depending on the environmental impact of new capacity installed relative to the environmental impact of the existing system.

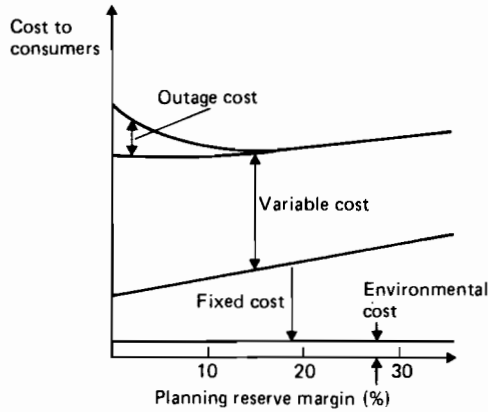
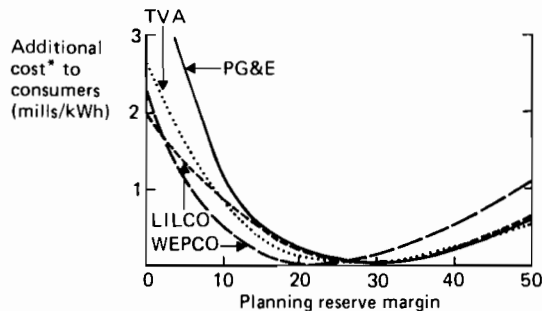

FIGURE 1 Cost to consumer as a function of planning reserve margin.

Figure 2 shows the over/under cost curves for four U.S. electric utilities normalized so that the vertical scale represents additional cost to consumers for planning reserve margins that differ from the least-cost planning reserve margin. The curves show that planning reserve margins in the range of ten to forty percent tend to minimize total costs to consumers. The curves also show that total consumer costs are relatively constant. Also, both high and low reserve margins are more costly to consumers, but very low planning reserve margins are more costly than very high ones. These results show that no amount of analysis and regulatory procedure can determine precisely the best planning reserve margin within the wide least-cost range, but it is nevertheless crucial to avoid planning reserve margins that are too low.



\*Expected cost levelized in 1978 dollars

FIGURE 2 Base case results for four utilities.

Modeling Demand Uncertainty

Perhaps the most important aspect of this integrated approach to capacity planning is the representation of demand uncertainty. In this methodology, demand in each future year is represented as a range of possible values, each with an associated probability. This range of uncertainty tends to become broader as the forecast lead time lengthens because of the unknown effects of the changing technical, political, and social conditions on the demand for electric power. Conversely, the range of uncertainty for a particular year tends to shift and narrow as the technical, political, and social conditions that will determine demand in that year become known.

One of the several useful ways to represent uncertainty in electric demand growth is with a probability tree of annual demand outcomes as shown in Figure 3. Extended and branched throughout the planning period, it characterizes a range of future electric demands.

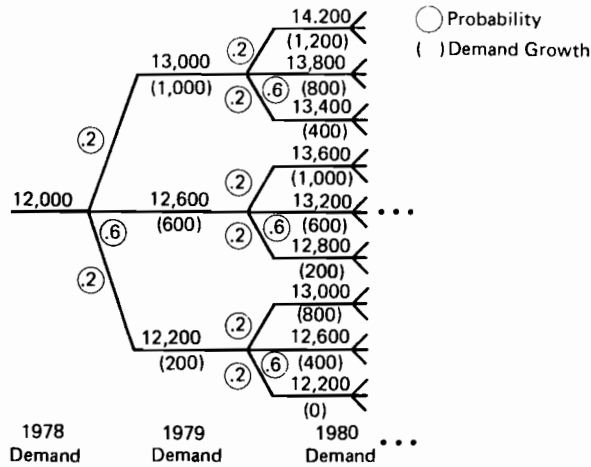

FIGURE 3 Probability tree representation of conditional uncertain demand.

Probabilities are circled. The demand outcome is shown on each branch. The changes in demand from the previous year are shown in parentheses. Note that the probability tree clarifies how the 1980 expected demand (the middle branch at each fork) depends on the 1979 demand outcome.

The probabilities are assigned to various levels of demand using available and well-tested procedures (Tversky and Kahneman, 1974; Spetzler and Stael von Holstein, 1975). Within a structured interview technique, motivational and cognitive influences on the probabilities assigned by a given expert are identified and often reduced.

Integrated Structure of the Over/Under Models

The methods for representing demand uncertainty are brought together in an integrated planning model with models of capacity expansion, the electric system, and consumer preferences. The structure of the resulting model is summarized in the logic flow diagram shown in Figure 4. This diagram is organized in three main parts: information (what we know), alternatives (what we can do), and preferences (what we want). Each of the small boxes in the figure refers to an important component model, a decision variable, data sets, or the model results.

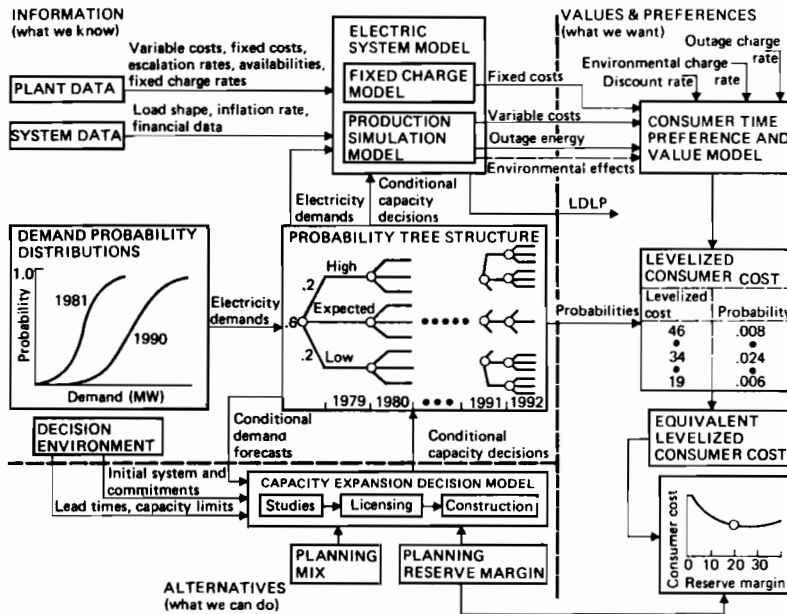

FIGURE 4 Integrated structure of the capacity planning model.

At the left of the figure, the main inputs to the model are displayed. They consist of plant data, such as costs of new plants; system data, such as load duration curves; demand uncertainty in the form of probability distributions; and a description of the decision environment in terms of initial conditions of the system, planning lead times, and limits on the physical availability of new capacity such as those imposed by the available hydroelectric sites.

At the bottom of the figure are the two key decision variables of the study: the planning reserve margin and the planning mix. These two variables feed into the capacity expansion decision model that determines the actual commitments of new units to various stages of licensing and construction. The planning reserve margin is the primary focus of the models; planning mix is considered to the extent that it affects planning reserve margin.

In the center of the figure is the probability tree described earlier. This probability tree is determined by the two continuous probability distributions provided as inputs on the left. These two distributions provide short- and longer-term measures of demand uncertainty. The model user specifies how many stages and branches per stage will be used in constructing the demand probability tree. Some approximation techniques are used to reduce the size of the probability tree.

An input to the capacity expansion decision model at the base of the figure is the conditional demand forecast at each time point on each path in the probability tree. The conditional capacity expansion decisions are recomputed at each time point on each path in the probability tree. This gives us the inputs to the electric system model along each path in the tree.

The electric system model is composed of the fixed charge (financial) model and production simulation model. The production simulation model is a probabilistic simulation of system operation with the capacity of each unit treated as uncertain. The outputs of the electric system model are the fixed and variable monetary costs of service, the outage (unserved) energy, and the environmental effects as measured by the energy production by each type of plant. These outputs of the electric system model are computed for every time point on every path through the probability tree.

The representation of values and preferences is shown at the right of the figure. First the consumer preference model reduces the various consumer outcomes for a single path through the tree to a single number—the equivalent levelized consumer cost. The value assignments required to perform this calculation are the consumer discount rate, environmental charge rates, and outage charge rates. These value assignments are usually determined on the basis of studies of consumer behavior and expressed preferences. As with all model inputs, the effect on the least-cost decisions of changes in value assignments is determined through sensitivity analysis.

Next, the consumer risk preference model computes the certain equivalent levelized cost. The calculation weights the equivalent levelized cost along a path through the probability tree by the probability of that path. The certain equivalent levelized cost is the constant annual known payment that has the same perceived cost to the consumer as the uncertain streams of costs computed by the model along each path in the probability tree.

This certain equivalent levelized cost is calculated for a range of planning reserve margins. By varying the planning reserve margin over the range, we can trace out the characteristic U-shaped over/under curve shown in Figure 1. As we have described, this single curve summarizes a large amount of economic and technical information including many value judgments and a representation of demand uncertainty.

## Application of Over/Under Models

First used in late 1978, over/under capacity planning models have been constructed for dozens of utility and regional electric service areas. Over eighty copies of the computer software have been acquired by U.S. electric utilities and regulatory bodies. Over/under models have played important roles in several regulatory hearings (Cazalet and Keelin, 1978).

More importantly, however, the over/under methodology is facilitating a trend in power system planning away from heavy reliance on single number econometric demand forecasts and arbitrary loss-of-load probability reliability criteria. The trend is towards evaluating generation capacity additions, conservation programs, system reliability, and environmental impacts on a comparable basis. Integrated modeling is the only effective way to analyze the trade-offs and uncertainties required for current power system planning.

The extensive use of over/under capacity planning models has required development of extensive user documentation (Clark and others, 1979). Many user workshops have been held to introduce new users to the methodology and computer software.

## INTEGRATED ENERGY MARKET MODELING

This second modeling system integrates models of energy supply, conversion, transportation, and end use with models of the rest of the economy (Cazalet and others, 1979, Clark, Keelin, Shur and Warthman). The modeling system is used to construct comprehensive medium- and long-range models of international, national, and regional energy markets. The outputs of these models are price and quantity projections used as inputs to analyses of specific energy policy decisions or as background projections used to gain insight into energy problems.

Typical outputs of these models are price or quantity projections for energy products as shown in Figure 5. However, the specific projections are of much less interest than the sensitivity analysis results that show, for example, how future U.S. oil imports vary under different assumptions as in Figure 6.

## Network Representation

This approach to integration of models of specific industries, technologies, and markets is illustrated by the series of network diagrams shown in Figure 7 through Figure 10. The network diagrams shown here are for one version of the DFI Energy-Economy Demonstration Model; other models constructed using this system differ primarily in terms of the level of detail in regional and sector specifications.

In this model, emphasis is placed on U.S. energy sectors and their linkages to other U.S. economic sectors and foreign

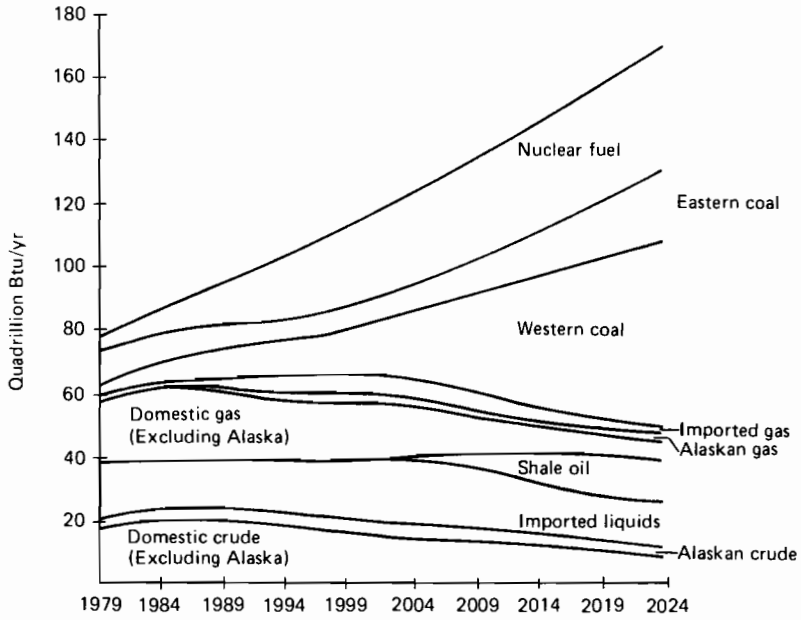

FIGURE 5 DFI model reference case quantities.

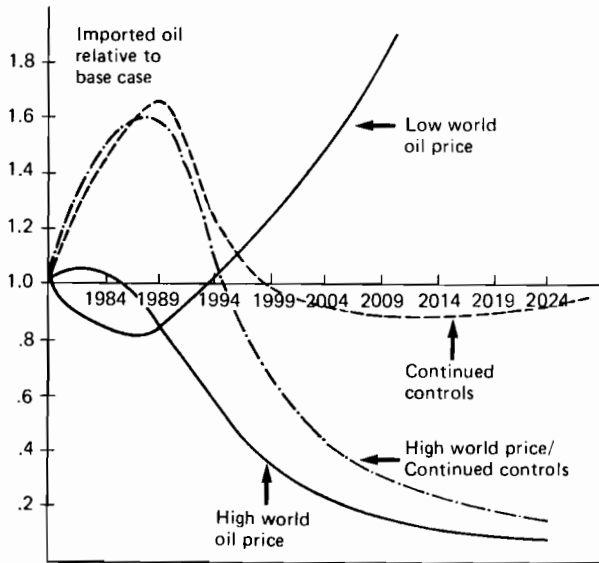

FIGURE 6 U.S. imports sensitivity cases.



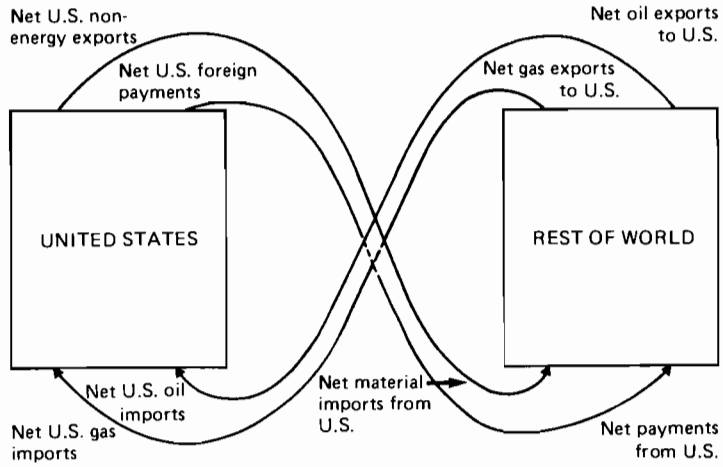

FIGURE 7 DFI model global region network.

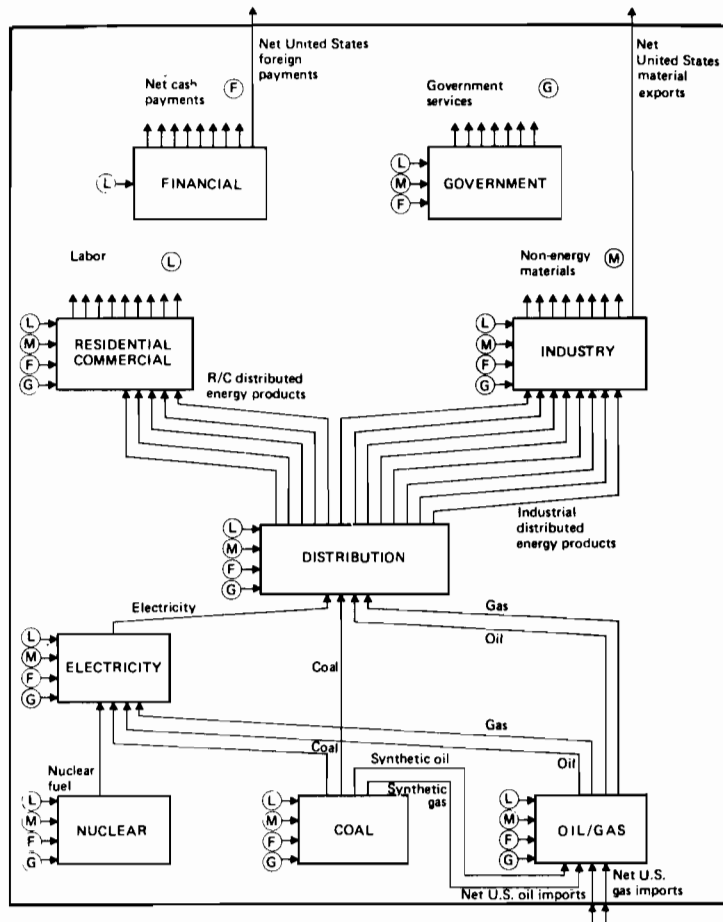

FIGURE 8 DFI model United States sectorial network.

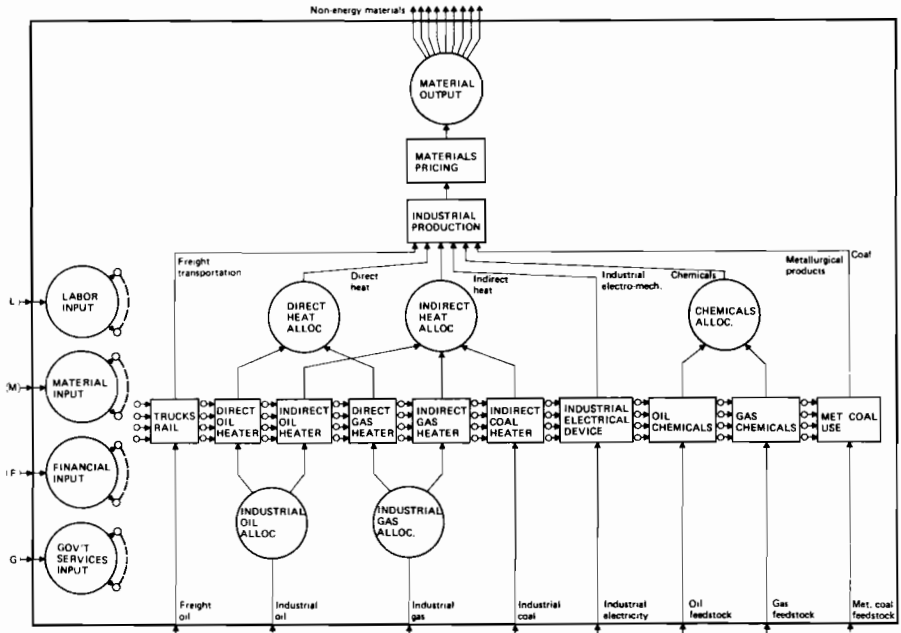

FIGURE 9 DFI model industrial sector network.

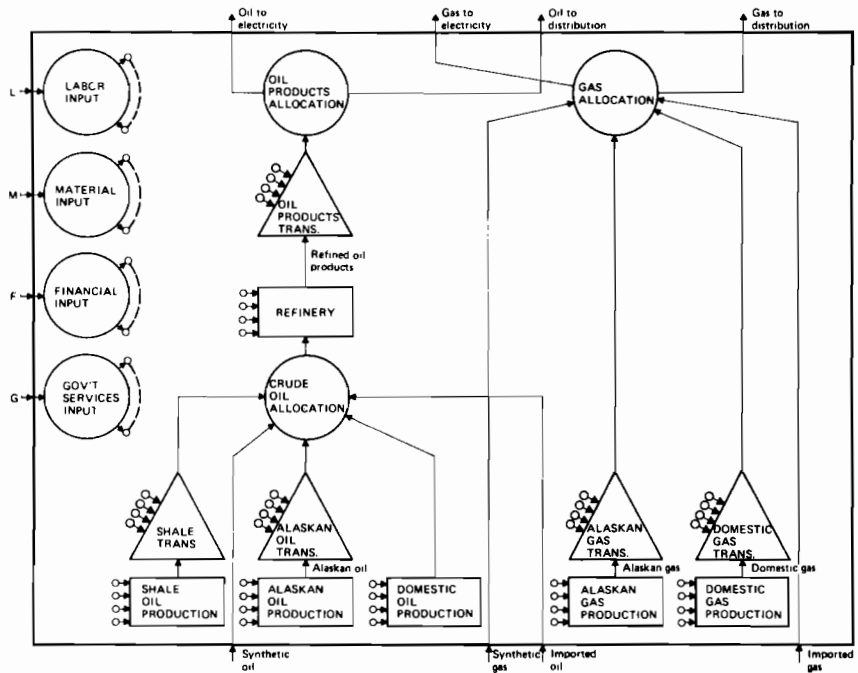

FIGURE 10 DFI model oil/gas sector network.

energy supplies. The structure of this model can be summarized as follows:

- The world is divided into two global regions, the United States and the Rest of the World (Figure 7).
- The Rest of the World is represented by a highly aggregated model representing the relationship among U.S. oil and gas imports, material exports, and net U.S. payments.
- The United States is represented by a network of sector models emphasizing oil, gas, coal, nuclear, and electric production sectors; energy distribution; and the residential, commercial, financial, and government sectors (Figure 8).
- Each sector in the U.S. network is represented by either a network of activity models or a single activity model describing basic economic activities and commodity flows in a sector (typical sector networks are illustrated in Figure 9 and Figure 10).

The general conventions used in drawing network diagrams and implementing them in a computer program are that physical commodities flow in the direction of the arrows on each link and cash payments flow in the direction opposite that of the commodity flow. For example, in Figure 7 the net payments for oil imports by the United States are represented implicitly as a flow in the direction opposite that of the net flow of oil. Similarly, the flow of payments to the United States for (nonenergy) material exports is opposite that of the net flow of materials. These two financial flows may not balance; thus giving rise to a third flow, net financial payments by the United States.

Figure 8 shows the energy-economy linkages characterized in terms of links for labor, nonenergy materials, net financial payments, and government services. These linkages are not fully drawn in the figure but are indicated by the symbols L, M, F, and G. Government services are characterized in this model as a way of characterizing taxes as financial flows in payment for government services.

#### Process Models

The process models linked together by the system need satisfy the network conventions only as to definition of the price and quantity flows on the linkages and certain other conventions related to the solution algorithm. In practice, however, a set of generic process models is used. The generic process models represent generic resource extraction industries, conversion technologies such as electric power and synthetic fuels technologies, transportation of energy products, and end-use conversion technologies. These models are made specific by providing data or process parameters, such as capital costs, thermal efficiency, and construction lead time.

Generic process models have been developed at various levels of detail; the modeler selects the level of detail appropriate to his problem. All of the process models establish economic relationships between prices and quantities of outputs and inputs over time. Within a process model, con-

struction of capital facilities is distinguished from the operation of those facilities. In addition, the changes in the design of facilities over time and with respect to prices are modeled. Thus each vintage of plant can be distinguished, and explicit technical models of production are utilized. The financial structure of the firm is also characterized in a generalized equilibrium model. Behavioral rules for investment, operating, and pricing decisions are usually based on profit-maximization (but need not be) and are endogenously determined at all levels.

In modeling nonrenewable resource processes, economic rents (Hotelling rents) associated with exhaustible resources such as oil and gas are calculated on the basis of producer and consumer expectations of future prices.

Markets are characterized as perfect, imperfect, or regulated using available generic process logic. Competitive and centrally planned markets can be represented. Unlike linear programming models, the share of the market demand allocated to various supply sources can be characterized as smooth functions of the relative prices of each source, thus avoiding the bang-bang behavior of linear programming allocations.

#### Methodology

The methodology used to construct these models has been called generalized equilibrium modeling even though market disequilibrium is often represented in the models (Cazalet, 1977; Cazalet, 1979). Mathematically, a generalized equilibrium model is a large system of simultaneous nonlinear equations or relations and unknowns. The basic approach used is similar to the Gauss Seidel successive approximations method normally used for the solution of linear systems of equations (Synfuels Interagency Task Forces, 1975). In this method, an initial guess at the solution is made, and successive improvements in the solution are made until each equation in the model is satisfied. Convergence of the procedure is greatly enhanced by solving the relations and variables in the order that most rapidly reduces the errors in satisfying each relation. The procedures have been effectively employed in dozens of generalized equilibrium models often with 100,000 or more fully simultaneous nonlinear equations.

#### Applications of Generalized Equilibrium Energy Models

The major models and studies carried out using generalized equilibrium modeling systems are listed in Table 1. In some cases, the models are used to directly assist in public policy decision making, such as in 1975 when a generalized equilibrium model was used to analyze U.S. synthetic fuels strategy (Synfuels Interagency Task Force, 1975). The analysis ultimately influenced Presidential and Congressional decisions. In other cases, the models are used by such organizations as the U.S. Department of Energy and its National Laboratories, the Tennessee Valley Authority, and the Electric Power Research

Institute for energy policy and R&D planning and analysis. Generalized equilibrium modeling studies have been published in Cazalet and others (1976), Stanford Research Institute (1977), National Academy of Sciences (1978), Sussman and others (1976), Henry and others (1979), Sussman and Rousseau (1978), and Balson and Barrager (forthcoming).

TABLE 1 GEMS Models and Systems.

YEAR	MODEL	ORGANIZATIONS
1973-74	SRI-Gulf Synfuels	SRI, Gulf Oil
1975	Western Energy Resources	CEQ, NSF, ERDA,
	President's Synthetic Fuels Study	FEA, SRI
1976-77	EPRI Supply Program	EPRI, SRI
	CONAES	SRI, DFI
	MOPPS Study	ERDA, DFI
	LLL R&D Study	LLL, SRI
1975	Gulf-SRI Model	Gulf Oil
	FORUM—Coal in Transition	Gulf Oil
1976	SRI-World Energy Model	SRI Multiclient
1976	Lawrence Livermore Economic	
	Equilibrium Modeling System	LLL, SRI
1977	DFI Energy-Economy Modeling System	DFI, DOE
1977	DFI Demonstration Energy-Economy Model	DFI
1978	DOE Long-Range Model	DOE, DFI
1978	EPRI Integrated Forecasting	DFI, EPRI
1978	DFI Generalized Equilibrium Modeling	
	System	DFI
1978	TVA Regional Energy	DFI, TVA
1979	EPRI Technical Assessment	DFI, EPRI
1979	EPRI Synfuels	DFI, EPRI,
		Harvard,
		Stanford
1979	DFI National Energy FORUM Oil & Gas	DFI
1979	Chase Manhattan Bank	Chase, DFI
1979	Pennsylvania Power & Light	PPL, DFI
1979	Gas Research Institute	DFI, GRI

Software for generalized equilibrium modeling is now available on a commercial basis. Using this software, several modeling groups in the United States are now actually using and constructing their own tailored energy models. The models in use and presently under construction range from large multi-region models to relatively small models of specific sectors. The conventions established by the modeling software permit modeling groups to effectively exchange energy model computer codes and data. To facilitate these exchanges and promote model development, an active user's group has been formed.

#### SUMMARY OF THE INTEGRATED APPROACH

The essence of integration is to tailor the models to the analysis of specific decision problems or a class of related decision problems. All variables and relationships that influence the evaluation decisions should be explicitly

represented in an integrated model; detail that does not influence the evaluation of decisions should be eliminated from the integrated model.

An integrated approach should explicitly represent uncertainty using sensitivity and probabilistic analysis. A modular approach is necessary when precoded submodels are assembled or activated to rapidly create new models. Otherwise the cost of tailoring a model to a decision problem can be excessive. Methodologies, as well as models, must be integrated. Most modeling methodologies can be viewed ultimately in terms of systems of equations. When these equations have special structure (linearity, diagonal dependency), special techniques can be used. However, an integrated model should begin with the formulation of the problem (specification of the equations). Techniques for solving the equations should take advantage of model structure and not impose a structure on the model.

#### REFERENCES

- Balson, W.E., and S.M. Barrager (forthcoming). Integrated Forecasting Model. RP1108. Decision Focus Incorporated for the Electric Power Research Institute, Palo Alto, California.
- Cazalet, E.G. (1979). A Progress Report on the Development of Generalized Equilibrium Modeling. Prepared for NATO Advanced Research Institute. Brookhaven National Laboratory.
- Cazalet, E.G. (1977). Generalized Equilibrium Modeling: The Methodology of the SRI-Gulf Energy Model. Decision Focus Incorporated for the Federal Energy Administration, Palo Alto, California.
- Cazalet, E.G., and others (1979). The DFI Equilibrium Modeling System. Decision Focus Incorporated, Palo Alto, California.
- Cazalet, E.G., and others (1976). A Western Regional Energy Development Study: Volume I: Economics; Volume II: SRI Model Data Base. Stanford Research Institute, for the Council on Environmental Quality, Menlo Park, California.
- Cazalet, E.G., C.E. Clark, Jr., and T.W. Keelin (1978). Costs and Benefits of Over/Under Capacity in Electric Power System Planning. Decision Focus Incorporated for the Electric Power Research Institute, Palo Alto, California.
- Cazalet, E.G., and T.W. Keelin (1978). Cost and Benefits of Over/Under Capacity in the Northern States Power Company Service Area. Decision Focus Incorporated for the Northern States Power Company, Palo Alto, California.
- Clark, C.E., Jr., and others (1979). Modelers Guide to Building Energy-Economy Models Using the Generalized

Equilibrium Modeling System (GEMS) and the Model Data Management System (MDMS). Decision Focus Incorporated, Palo Alto, California.

- Clark, C.E., T.W. Keelin, R.D. Shur, and F. Warthman (1979). Users Guide to the Over/Under Capacity Planning Model. Prepared by Decision Focus Incorporated and Forrest Warthman & Associates for the Electric Power Research Institute, Palo Alto, California. EPRI EA-1117.
- Henry, J.P., Jr., and others (1979). "World energy: A manageable dilemma." Harvard Business Review.
- National Academy of Sciences (1978). Energy Modeling for an Uncertain Future. Report to Modeling Resource Group Synthesis Panel of the Committee on Nuclear and Alternative Energy Systems, National Research Council, Washington, D.C.
- Spetzler, C.A., and C.A.S. Stael von Holstein (1975). "Probability encoding in decision analysis." Management Science, 22, no. 3.
- Stanford Research Institute (1977). Fuel and Energy Price Forecasts, Volumes I and II. Report prepared for the Electric Power Research Institute, Palo Alto, California.
- Sussman, S., and others (1976). A Study of the Importance of Energy RD&D for the United States. Report UCRL-52140. Lawrence Livermore Laboratory, Livermore, California.
- Sussman, S.S., and W.F. Rousseau (1978). A New Language for Economic General Equilibrium Models Report UCRL-52507. Lawrence Livermore Laboratory, Livermore, California.
- Synfuels Interagency Task Force (1975). Recommendations for a Synthetic Fuels Commercialization Program. U.S. Government Printing Office, Washington, D.C.
- Tversky, A., and D. Kahneman (1974). "Judgment under uncertainty: Heuristics and biases." Science, 185, 1124-1131.

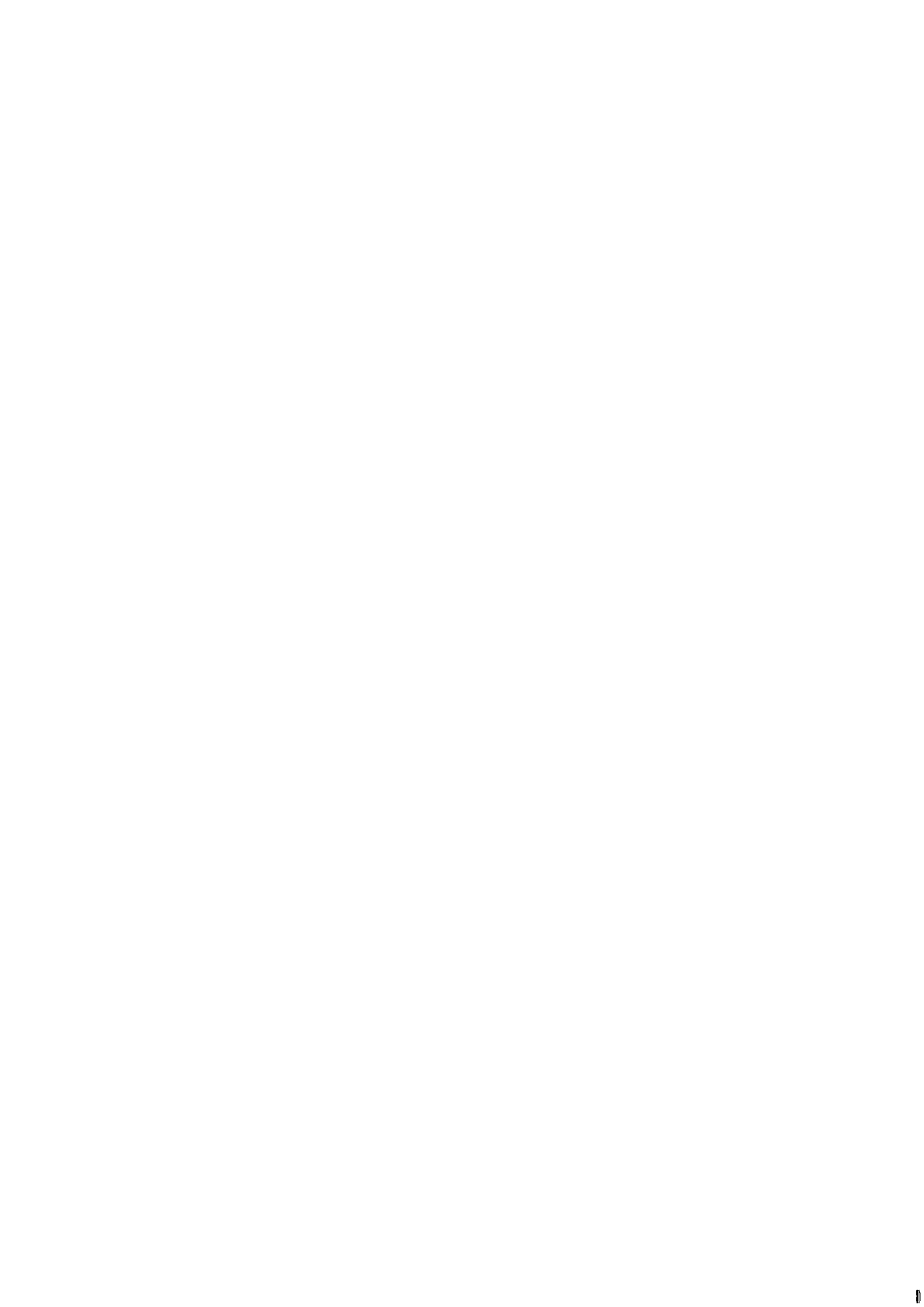



# LINKING LARGE-SCALE MODELS AND ENERGY-ENVIRONMENTAL CASE

**P. W. House**

*Director, Office of Technology Impacts, Office of the Assistant Secretary for Environment, U.S. Department of Energy, Washington, D.C., USA*

## ABSTRACT

This paper is a discussion of the linking of the two major assessment models used by the Department of Energy (DOE): The Project Independence Evaluation System (PIES)--recently renamed the Midrange Energy Forecasting System (MEFS)--and the Strategic Environmental Assessment System (SEAS). PIES is used to project energy and economic forecasts. SEAS then uses these forecasts to predict environmental impacts over the same time period. These linkages are made at the national and regional levels.

## KEYWORDS

Project Independence Evaluation System (PIES); Strategic Environmental Assessment System (SEAS); Department of Energy (DOE); Regional.

## INTRODUCTION

### Environmental Impacts of Energy Policy

Ever since Habitat in Vancouver, B.C., in the Seventies, environmental issues have been formally recognized as transnational or global. The concerns in the environmental area include those where the international implications are obvious such as acid rain, CO<sub>2</sub>, and the pollution of rivers that flow across national boundaries. Of less obvious significance are cases where differential pollution control laws encourage the relocation of "dirty" industries to countries who will accept the pollution. Or, a world-wide concern for the preservation of site of particular national beauty or species of wildlife that is threatened by extinction.

Recently, still another issue has come upon the scene which also has significant international ramifications: energy. Because there is clearly a limited supply of energy sources (particularly oil) and because these supplies are not evenly distributed across the earth but are controlled by individual sovereign states who are generally free to dispose of them as they see fit. The politics which have transpired between the nations that have energy and those that do not has been front page news around the world for years now.

Finally, the interplay between the strategies of environmental and energy policies has been of varying intensity, ranging from high interest in specific issues at specific locales to more generalized concern at the global level.

This paper will be about the efforts made at the U.S. Department of Energy to address the environmental impacts of energy policies. More particularly, the regional implications for the environment. The models discussed which have been used to perform the regional environmental impacts are the Mid-Range Energy Forecasting System (formerly known as PIES) and the Strategic Environmental Assessment System (SEAS). Both models are of the "top-down" variety.

Top-down analysis suggests methodologies which attempt to get a global perspective of the relationship of the variable in question and other variables which might impact it or that it impacts. Normally, the analyses produced are relatively holistic in nature and attempt to investigate strategic questions of national policy. Data is collected at a relatively coarse grain (State or Federal region as opposed to city block, for example) and relationships between the variables given certain actions are represented by average coefficients of groups of people, processes, or actions rather than specific activities. Such models are used both for research and analysis purposes to test the first order consequences of various strategy alternatives and to look for unanticipated effects of various courses of action.

Before going on to discuss these models in detail, I would like to degress and talk to some points concerning global issues and models in general. The various conferences held at IIASA and elsewhere around the world ( in addition to numerous articles and books on the subject) attest to the belief that it would be useful to add the analytic power of models to the investigation of global issues. Unfortunately, several factors have continually surfaced which have frustrated the attempt to really use the potential power of these analytic techniques. One, for example, is the lack of consistently, high quality data bases throughout all nations. In some countries, data is just not available or, if available, of questionable validity. Another is that the relationships between the economics of the various nations are so poorly understood that the specification of them in a model is impossible--or only possible at so high a level of aggregation that the results are of questionable value. Finally, it is clear that there is no real client for the results of global models. The lack of such clientele means that both the specification and the use of the results is left to chance and the builder of the model.

Obviously, I am not going to be able to do much with this collection of problems in any definitive fashion. However, the use of a national-to-regional linkage of model results has some analogy to global-national models. The problems of linking models and data bases were addressed as these models were put together and the experience gained can be used by those interested in global issues in thinking through their issues.

Let us now turn to a description of the model systems (PIES and SEAS) and to their regional components.

Project Independence Evaluation System (PIES) Model\*

Description: General

By way of background, Project Independence was the generic title used to describe activities organized by the Federal Energy Administration (FEA) (and later the Department of Energy (DOE)) in the continuing development and implementation of a national energy policy for the United States. The PIES system generates planning estimates of possible energy system variables, taking into consideration the effect of relative prices, the potential for fuel substitution, and the technological constraints inhibiting increased energy supplies.

Among the several objectives considered by the PIES model in analyzing alternative strategies are:

1. Price sensitivity -- the impact of relative prices.
2. Fuel competition -- the substitution of one energy source for another.
3. Technology -- the variation of the production and conversion technologies within the energy system.
4. Resource limitations -- the physical capacities and other resource limitations.
5. Externalities -- the by-products or side-effects of energy production and consumption.
6. Economic impact -- the interaction with the total energy production and consumption.
7. Regional variations -- the uneven geographic distribution of energy production and consumption.
8. Dynamics -- the lead times, capacity in previous periods, and other time-dependent conditions.
9. Modularity -- the possibility of expansion of major components of the energy system or the introduction of new components.
10. Judgment -- the capability of incorporating information and making approximations and estimates.

Thus, the energy system is depicted as a kind of network wherein production, processing, conversion, distribution, transportation and consumption activities take place. The prices and capacities for these activities are presented so as to be consistent with the dual objectives of preserving price sensitivity and recognition of potential constraints on the system. This framework is structured by separating the supply and demand sectors.

Details of the National-Level PIES System

The supply system which produces, processes, and converts activities becomes nodes within an energy network. These nodes are then connected with links which depict the transportation and distribution system.

Potential energy production system activities are described by a set of supply curves, identifying prices to be paid and nonenergy resources to be consumed at each possible level of operation.

---

\*Peter W. House, and John McLeod, Large Scale Models for Policy Evaluations, New York: John Wiley and Sons, 1977.

Important physical or technological limitations affecting the production of energy are described within the transportation and distribution network. The refining and conversion sectors are included as the intermediate nodes of the network, each with a description of its capacities and conversion technologies. The refining and conversion activities are joined with the demand or consumption sectors through an additional set of transportation and distribution links. These links are subject to capacity restrictions which can be modified if sufficient key resources are available (when compared with alternative uses in the production or distribution of energy). The supply curves, conversion technologies, transportation possibilities, costs and resource requirements are produced by supply submodels of the evaluation system and linked within this framework.

The estimates of the demand for energy are produced by a demand model. The demand for energy products takes place in different geographical regions and varies with energy prices. The choice of the activities to be described as demand is somewhat arbitrary, but can be thought of as the final demands for energy. Fuel substitution is simulated by the demand model through the empirical development of the relationships between demands and relative prices.

Given the prices, resource requirements, and capacity constraints, an integration model is utilized to construct a feasible set of energy flows that satisfies the final demands for energy. The energy supply activities and the demand prices are adjusted during this market simulation to obtain a balanced solution which is in equilibrium. This equilibrium balance is a point where no consuming sector would be willing to pay more for an additional unit of any energy product and no supplier would provide an additional unit of any energy product for less than the prevailing market prices.

For an arbitrary selection of prices and demands, the least cost balancing solution may not be an equilibrium solution: there is no means of guaranteeing that an arbitrary price for estimating product demand will be equal to the prices at which the product is supplied. However, the necessary adjustments in the prices are identified and these adjustments are repeated until the equilibrium solution is obtained.

The supply demand and equilibrium balancing components describing the energy system are combined with models of the economy, assessments of nonenergy resource availability, and report writers that evaluate energy solutions in terms of the environmental, economic, or resource impacts. Econometric, simulation, accounting, and optimization models are included in this system, each exploiting special capabilities for the relevant components of the problem. The model of macroeconomic activity is the well-known system developed by Data Resources, Inc.,\* and is one of the several major econometric models of the United States economy.

The resource constraint elements consist of a large data base which records the coefficients of demand for nonenergy resources for the alternative energy activities included in the system. These coefficients are employed to construct constraints for the equilibrium solution of capacities are known or to prepare ex-ante summaries for off-line evaluation of potential bottlenecks. The supply model component consists of a variety of procedures used to construct stepwise approximations to the energy supply curves. These range from nonautomated engineering analysis in the case of coal to the complex software of the National Petroleum Council for the estimation of the supply of oil and gas.

The demand model is a behavioral econometric model. The demand for energy is not represented in terms of its final use as energy but as the demand for the variety of energy products in the using sectors. The structure of demand and substitution is

\* Data Resources, Inc., The Data Resources Quarterly Model, Econometric Forecasting System. Equation Specifications, varied dates.

postulated in terms of relative prices and the parameters of these relationships are estimated using econometric techniques. The resulting system consists of over 800 behavioral relationships governing the demand for energy in 40 product and sectoral combinations.

The demand, supply, and resource assessments models are combined through the series of programs, constituting the integrating model. A partial equilibrium is obtained by balancing prices and quantities for all energy products. Through this model, the quantity flows and prices of the equilibrium energy sector solution provide the input to a series of evaluation or report writing programs that relate the solution to particular problems under consideration. These reports, over 20 in total, range from an executive summary of the energy balance to detailed classification and compilation of associated environmental residuals, water requirements, or implied non-energy resource usage for those inputs which have not been considered directly in the energy system network.

#### The Strategic Environmental Assessment System (SEAS) Model

Description: General

SEAS has been described\* as "a system of special-purpose models linked to a macro-econometric model and an interindustry input-output of the United States economy." Economic forecasts to estimate pollutant levels and associated abatement costs, such as pollution abatement benefits, energy demands, solid waste generation and associated recycling, land use requirements, mineral use and virgin stock status, processed ore inventories, transportation demand, and relative commodity price changes, are used by other models in this system. At present, this model is used to build on economic and energy policies and forecasts made primarily by government agencies in order to predict pollution loadings, costs of cleanup and associated direct and indirect economic impacts which are likely to flow from these policies and forecasts.

In the Department of Energy, SEAS has a very particular use. In DOE's Office of Environment, SEAS is used to predict the environmental impacts of energy policies and scenarios produced by other parts of the Agency. To accomplish this, it is necessary for the analysts to map the energy and economic forecasts onto the SEAS system of models and to then use the system to calculate the environmental residuals and impacts from these forecasts.

The model, as presently used: forecasts up to a 25-year period; produces forecasts at national and regional levels; provides for regional variation of industrial pollutants; allows for variation in assumptions regarding pollution control regulations; has a detailed breakdown of economy for environmental analyses; emphasizes pollution from energy industry in conjunction with major polluting nonenergy industries; permits users to trace effects throughout the system; has a very rich data base containing a comprehensive set of environmental, energy, and economics variables and parameters; and finally, allows for extensive user options, particularly in output report selections.

SEAS is designed to operate as a set of integrated submodules which can be run either alone or as a part of the overall system. These submodels can be divided into four general areas: energy, economics, regional disaggregation, and environment. Within each of these major categories, there is a further breakdown. The economics section has four models: energy investment, interindustry input/output, sector disaggregation and pollution abatement costs. Energy consists of three submodels: electric utilities, industrial combustion and an energy supply network simulator. Regional disaggregation is carried out using a single subsection, and the environmental portion uses four models: transportation, residual generator, land use, solid waste, and environmental quality indicators.

\* Peter W. House, Trading Off Environment, Economics, and Energy, Lexington Books, Lexington, Massachusetts, 1979.

## Details of the Component Submodels

### The Economic Models

The SEAS economic forecasts are developed at several levels of detail. The first, the macroeconomic forecast, provides the general parameter projection on an annual basis through 1985. These general values include employment, general production sector output volumes, personal consumption, disposable income, capital investment, etc., and allow projections of the general subaccounts of the GNP. Basic structural relationships between these economic variables are developed from Bureau of Labor Statistics and the Commerce Department models and data bases. The macroeconomic model used in SEAS was developed and is maintained by Chase Econometric Associates (CEA).

The second level of forecast is the calculation of interactions among industries in order to meet the levels of output in the demand forecast of the macro model. This economic input/output model provides the yearly economic projections for 185 sectors of the economy, and statistics for each sector such as employment, output sold for final demand, total output, durable goods and construction expenditures, export, imports and inventories. The model, called INFORUM, is a rigorous input-output system that provides great detail and balanced accounting of sectors and to the final consumers. The INFORUM model is maintained by a staff at the University of Maryland and linked to the macroeconomic model by CEA.

The third level of forecast detail of economic activity is produced by the SEAS design and system teams and deals with procedures that break the specific (185) industry forecasts into richer information (where required) for specific analysis questions, using official estimates from the Departments of Commerce, Agriculture and the Interior for more detailed economic activity levels. This last level of detail in SEAS is readily expanded and now represents three times the detail available from the original INFORUM sectors.

A fourth level is found in the abate cost model, ABATE. ABATE estimates the investment, operating, and maintenance costs associated with abating the emissions of air and water pollutants by each economic sector. It also feeds back to INFORUM the increased monetary and goods demands placed by pollution control investment and operating purchases on the industrial sectors which supply construction materials and labor, abatement equipment, chemicals for abatement, energy sources, and operating manpower requirements. INFORUM uses this information to rebalance its forecasts of sector economic activity. Nonindustrial consumption and disposal processes, such as utilities, sewage treatment plants, and commercial and residential space-heating consumption, are handled by INFORUM, RESGEN, and ABATE in concert, in the same manner as the industrial sectors.

The fifth and final level of detail is in the areas of energy investment. The energy supply demand, the unit capital costs, the forecasted construction period, and the materials requirements are loaded into the model as inputs. These are then fed into an energy investment model which calculates the impact on the composition of GNP, output of selected sectors, the indirect energy use for capital resources, and the sectoral employment. These calculations are then fed back into INFORUM, used to update the economic forecasts.

### The Energy Models

There are three energy models in SEAS: electric utilities, industrial combustion, and an energy supply network simulator (ESNS). Each is considered briefly in turn.

The electric utilities model forecasts the air emissions and fuel consumption levels for electric utilities operating before 1976, provide state-level location of electric utilities operating after 1976 by fuel type, and regionalize state electric utility fuel mixes to the county level. It considers various fuel types and takes as inputs items such as total demand for electric power, fuel mix, capacity factors and retirement factors, and environmental considerations.

The industrial combustion model has as its purpose the regionalization of industrial fuel combustion and the calculation of regional air pollution emissions. It takes as inputs future coal distribution, boiler size, various assumptions as to the state of coal technology and relevant environmental factors. The forecasts are made at the county level and normally aggregated to a higher level, such as Air Quality Control Region (AQCR).

Finally, the energy system network simulator (ESNS) is designed to determine the environmental/economic consequences of a specific energy policy the candidate energy policy is translating into changes in both the demand and energy and adjustments in various stages of the fuel cycle. It is divided into sections containing energy demands, intermediate activities and energy supply sectors. The network detail is determined by environmental issues, investment implications, and the calibration requirements fostered by mapping it onto other models (i.e., PIES). The changes forecast by this model lead to adjustments in other models in SEAS; for example, in the energy activities both nationally and regionally, economic forecasts and pollution forecasts.

#### The Environmental Models

There are five environmental modules in SEAS: transportation, residuals generation (RESCGEN), land use, solid waste, and environmental quality indicators. The transportation module forecasts the demand for automobiles, buses, trucks, railroads, and airplanes in terms of miles traveled for both passenger and freight transportation purposes, using the Department of Transportation forecasted total of miles traveled. It estimates the annual volume of controlled emissions produced by mobile sources. It has the ability to vary emission standards by model year, average age of the auto fleet, model splits for SMSA, occupancy ratios, and the MPG of various model years. It can also take into consideration the transportation control plans of regions.

The residuals module estimates annual emissions of air and water pollutants and of solid wastes for the most significant polluting industries. It estimates first the potential environmental emissions before abatement, and then the emissions actually reaching the environment; the latter depends on the degree of pollution abatement in each sector and its subprocesses. The released emissions include not only the untreated primary pollutants, but also the significant secondary pollutants produced by the pollution treatment processes themselves (e.g., sludges).

The Solid Waste-Recycling Module estimates the amounts of solid wastes from non-industrial sources, the expected method of disposal, and the costs associated with each method. For incineration and open-burning disposal methods, it also estimates the annual levels of air pollution emissions. Recycling levels are applied to the product classes which comprise significant elements of the solid waste stream to calculate total amounts of materials available for recycling and the levels actually recycled.

The Land Use Module estimates amounts of land used in broad categories as a function of forecasts of economic activity. It also calculates nonpoint sources of water pollution. For nonpoint rural pollution sources, such as agriculture, construction, forestry, mining and drilling, it calculates soil loss, sedimentation,

and pesticides/fertilizer loading. For urban runoff as well as naturally occurring pollution sources, it forecasts levels of air, water, and solid waste pollution emissions.

The final module, environmental quality indicators, is designed to translate air emissions and water effluents into indicators of environmental quality to allow regional and temporal comparisons of air and water pollutant levels. For air pollution, for example, the indicators used are concentration ranges and ratios, emissions per square mile, emissions per cubic metre of ventilated flow, and population at risk for both TSP and SOx.

#### The Regional Disaggregation Model

In order to enrich the forecast of economic and environmental impacts, this model provides a forecast of distributions of industry outputs and the associated environmental emissions to a number of geographical subdivisions. The subdivisions include states, SMSA (Standard Metropolitan Statistical Areas), river basins, air quality control areas and "basic economic areas." The OBERS projections developed by the Departments of Commerce and Agriculture are employed in this model.

The analyses performed outside the computer system are most important and are made up of two elements: (1) the analysis used to develop the experimental design of alternate scenarios to modify the specific input data for each scenario, and (2) the analysis of the computer outputs to show impacts of scenario changes, and, hence, insight into probable effects of specific national policies and regulations, including public and institutional reactions.

The purpose of the regionalization model is to allocate the present and future industrial, commercial, and consumer activity to lower levels of aggregation. The model has four separate regionalization modules: (1) a permanent share file based on OBERS\* projections; (2) an ability to manually override these coefficients; (3) a dynamic forecasting capability; and (4) special regionalization programs for utilities, boilers, and coal mining.

The model has several special features which make it unique as a regionalization system. It reflects changing pollution control technologies or standards over time. It also incorporates changing process technologies within sectors over time. In addition to allowing for differences in pollution per unit of output for the same sectors in different regional locations, it allows user override of all the above. Finally, it automatically identifies secondary residuals produced by the treatment of process streams.

#### Using a Top-Down Approach to Energy and Environmental Policy

Having described SEAS and PIES\*\* and alluded to the fact that such systems could be and have been used to forecast regional impacts of energy policy and environmental impacts, it remains for us to demonstrate how these are done. We shall provide examples from the National Energy Plan required of the Department of Energy every two years. In general, the energy and economic forecasts used are accepted as given and are used to calibrate the economic and energy forecasting portions of the SEAS model. Once the SEAS submodels are constrained so that the forecasts they produce

\* OBERS is a forecast of county-level employment and economic activity issued jointly by the Departments of Agriculture and Commerce.

\*\* A new collection of energy forecasting models has been assembled under the heading of the Mid-Term Energy Forecasting System. Its major submodels are the Mid-Term Energy Market Model, the Mid-Term Oil and Gas Supply Model, the Regional Energy Demand Forecasting Model, the National Coal Model and the Refinery and Petrochemical Modeling System.



ape those of the "official" DOE forecasts of energy and economic futures, the model is then used to predict the environmental impact of these futures.

The National Energy Plan -- National Perspective

The Second National Energy Plan (NEP-II) presented a set of actions designed to both reduce demand for energy in the United States through conservation and to increase domestic energy production, thereby reducing American dependence on foreign oil supplies. The Second National Energy Plan was designed to change the mix of fuels used in the United States over the next twenty years or so. The following table presents the projected mix of energy sources in 2000 under two sets of assumptions concerning world-wide energy supply/demand relationships and a likely range of prices of imported oil. Domestic production of energy is projected to increase from 60 quads in 1975 to about 97 quads under the low oil price scenario, an increase of about 60 percent. Domestic production would increase to 113 quads under the high oil price scenario, or about 90 percent of the 1975 production level.

	<u>Energy Supply by Source (Quads)*</u>		
	<u>1975 World Oil Price (\$11.60/bbl)</u>	<u>2000 Low World Oil Price (\$21.00/bbl)**</u>	<u>2000 High World Oil Price (\$38.00/bbl)**</u>
<u>Domestic</u>			
Coal	14.9	35.4	43.9
Synthetics***	( 0 )	( 2.3)	( 5.6)
Oil	17.7	19.0	23.4
Conventional***	(17.7)	(17.2)	(20.8)
Shale***	( 0 )	( 1.8)	( 2.6)
Gas	<u>22.2</u>	<u>18.1</u>	<u>18.6</u>
Total Fossil	54.9	72.5	85.9
Nuclear	1.8	14.9	16.5
Hydro, Solar and Geothermal	<u>3.1</u>	<u>9.8</u>	<u>10.1</u>
Total Domestic	59.7	97.2	112.5
<u>Imported</u>			
Crude Oil	8.7	20.8	5.4
Refined Oil Products	3.8	7.7	2.3
Natural Gas	0.7	0.8	0.1
LNG	<u>&lt;0.1</u>	<u>0.8</u>	<u>1.6</u>
Total Imported	13.2	30.1	9.4
Coal Exported	<u>-1.8</u>	<u>-2.4</u>	<u>-2.4</u>
GRAND TOTAL	71.1	124.9	119.5

\* One quad equals one quadrillion Btus.

\*\* 1979 dollars.

\*\*\* Not included in total.

Note: These values differ slightly from those in the Plan due to rounding and slight changes made in the final version of the Plan. These differences do not change the overall finding of this report.

The largest domestic supply increases are expected in coal and nuclear energy. The production from coal would more than double under the low price scenario and almost triple under the high price scenario. Nuclear energy was expected to increase by a factor of roughly eight to nine times by the year 2000.

Under the low price scenario, energy imports would nearly triple from 1975 to 2000. At higher oil prices, however, imports would actually decline by about 30 percent. Total U.S. demands for energy in 2000 are projected to be about five percent lower under the high oil price scenario than under the low price scenario.

Given the energy future projected, the environmental analysis could proceed as in the earlier case having first received estimates of the economic and regional impacts of the Plan. These latter estimates were not a part of the published results. Following are some selected summary environmental impacts that were published given the above forecasts.

#### Air Emission Trends.

Air pollutants are released from a variety of processes. Of interest to the Department of Energy are those emitted by the combustion of fossil fuels by electric utilities and industrial boilers and the operation of motor vehicles. Because of improved controls and stricter emission standards, emission levels for three of these criteria air pollutants--hydrocarbons, carbon monoxide, and particulates--are generally projected to remain at the 1975 levels or to decrease between 1975 and 2000 under both scenarios. Sulfur oxide levels in 2000 are anticipated to remain at the 1975 level under the low world oil price scenario and decrease slightly under high world oil prices. Nitrogen oxide emissions are expected to increase by a third in both the low and high price cases over the twenty-five year period examined due to increased fuel burning.

Each pollutant and each region were subjected to more detailed analyses. Rather than try and summarize them all further and instead of attempting to either reproduce or paraphrase the results here, we have chosen to give a capsulized discussion of air emissions of TSP--total suspended particulates.

Projections of particulate emissions at the Federal Region Level show a fairly substantial decrease between 1975 and 2000 in the Mid-Atlantic, Southeast, and Great Lakes Regions, where emissions were highest in 1975. This decline is due to the forecasts compliance of existing energy facilities and industrial sources with SIP emission standards. Decreases are also seen in the New York-New Jersey and Central regions for similar reasons. The regions that exhibit increases in TSP emissions by 2000 were those with fairly low emissions in 1975. In general, reductions in TSP are projected to occur in highly industrialized regions that had fairly substantial emission levels in 1975 as a consequence of the use of better emission controls, whereas increases were seen in regions with fairly low 1975 TSP levels as a consequence of increased industrial activity or coal use.

The regional trends indicate that air quality improvement may occur in areas, such as the Great Lakes Region, which are highly industrialized and, as of 1975, emitted large quantities of TSP. The projected increases do not appear alarming at the Federal Region level, but may present localized problems within some regions.

Similar assessments were carried out by pollutant for air, water, solid waste, and nuclear emission streams. With this as an example, let us just briefly summarize some of the other environmental impacts found by the analyses.

#### Water Consumption Trends.

Water consumption by the Nation's energy industry is expected to increase almost four-fold between 1975 and 2000. This increase would be caused primarily by growth in steam electric generation by coal and nuclear fuels facilities and by more stringent water pollution control regulations, which encourage the use of cooling towers which consume larger quantities of water than current once-through cooling practices.

#### Water Pollution Trends.

National efforts to improve water quality during the last decade are beginning to show general success. Energy use would be responsible for the major share of point-source releases of total dissolved solids, sulfates, and other pollutants. Releases from coal mining and processing operations and electric utilities would be the main source of total dissolved solids and are projected to contribute about three-fourths of the national sulfate effluents by 2000.

Energy industries would be responsible for a minor share of the other water pollutants analyzed (biochemical oxygen demand, total suspended solids, nutrients, and chlorides). Total suspended solids from energy sources are projected to decrease slightly over the projection period while nutrients and biochemical oxygen demand from energy sources are projected to remain at their 1975 levels.

#### Solid Waste Trends.

Solid wastes, currently produced at a level of 487 million tons per year, include industrial solid wastes and sludges, municipal refuse, and municipal wastewater treatment sludges. Noncombustible solids remaining after conversion of solid fuels, and sludges, from pollution control devices and from wastewater treatment currently represent about 17 percent of all solid wastes. That portion resulting from fuel use is expected to almost triple during this time as a result of electric utility and industrial use of coal. For example, sludges from flue gas desulfurization systems show a dramatic growth due to the projected impact of revised regulations for new plants. Another area of projected solid waste of interest to the Department of Energy is oil shale retorting. This emerging fuel source is expected to result in from 372 to 537 million tons of noncombustible wastes annually by 2000 for the low and high world prices, respectively.

#### Regional Trends.

The discussion of environmental trends presented above has emphasized expected changes at the national level. Regional variations will occur that depend on local energy supply and demand patterns. Figure 1 is a map summarizing the major regional environmental trends anticipated under both world oil prices cases.

#### Lessons Learned

In one sense, this paper demonstrates that it is technically possible to link the very large policy model, PIES, used to help make national energy policy, with SEAS, the also large environmental model, in such a fashion that impact assessments are possible. Further, to the extent that regional forecasts of national policy have meaning when done from the top down, it is equally technically possible to do regional environmental impact analyses at the same level of detail as the energy analysis is done. Although these findings are of some comfort to those who would have empirical analyses as a major input into national energy/environmental policy, it should be noted that even this significant step was not done without cost, nor is the process complete. Let us look to a couple of the more obvious technical difficulties yet to be addressed adequately.

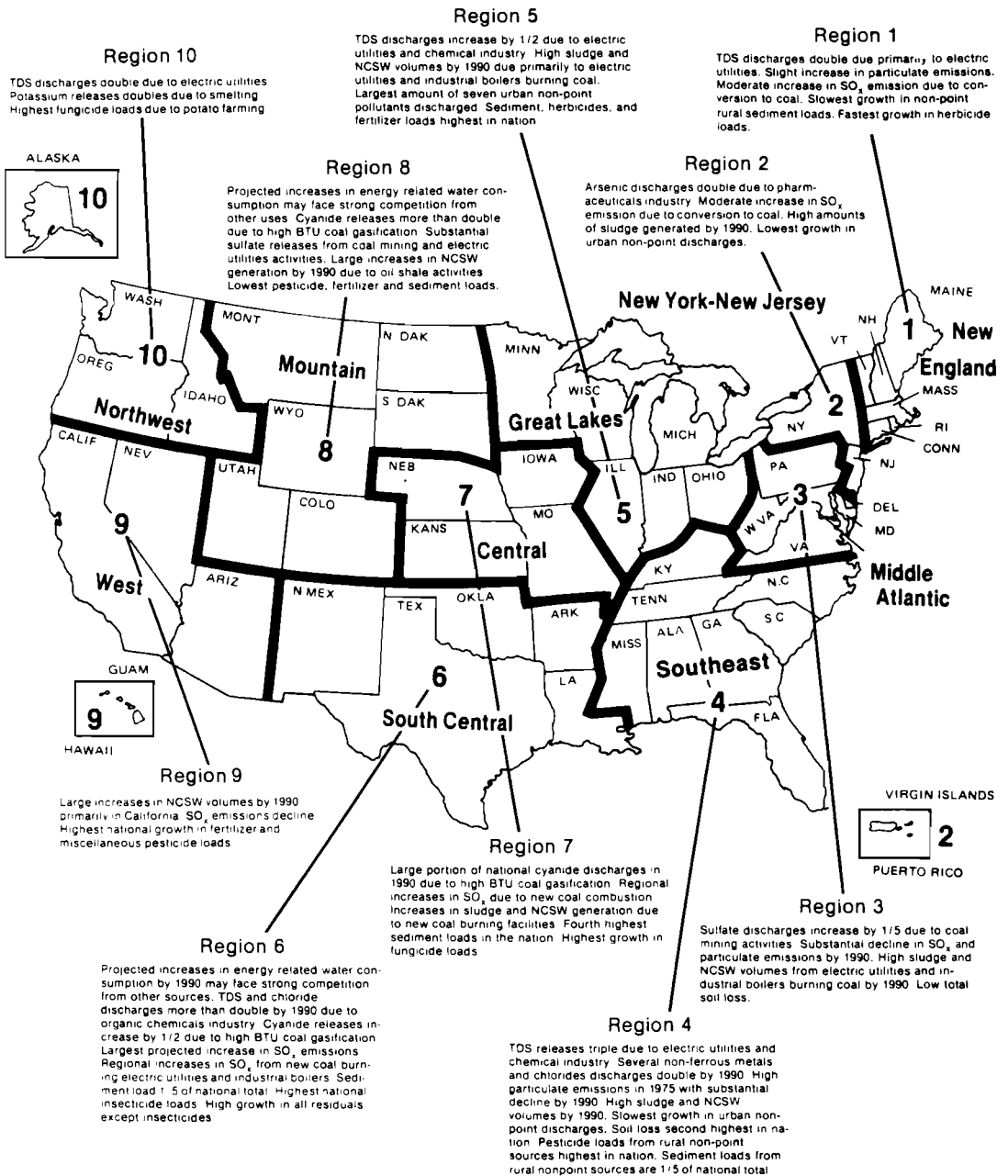

Fig. 1. Major Regional Trends Associated With Energy Development

One class of problems yet to be adequately resolved is those associated with the building of any model: the calibration of the data used in the model. It is well known that if the assumptions used in the model data are not consistent and if the data is not calibrated to a single norm, then the resulting output is so much garbage. This requirement for consistency is made more difficult when, in addition to the data calibration requirement, there is a need to assure that the assumptions made in the models to be linked are consistent also. The larger the models being linked (larger in the sense of numbers of substantive forecasting unique variables), the more difficult this requirement is to meet.

With two models the size of PIES and SEAS, this goal is far from being realized. The econometric models used to generate the national growth, for example, are different and even though the SEAS model does not actively use its economic forecasting capability, the mapping of the PIES forecast onto it is made more difficult because of the difference in the subroutines themselves. For example, SEAS uses INFORUM which is basically an I/O model with about 190 sectors. These sectors are further disaggregated with several hundred subsectors. The PIES model uses DRI's Macro-Economic Model which is built on a very different logic structure from the I/O approach. Consequently, the mapping techniques chosen require that the GNP final demand components provide the bridge between PIES and SEAS models in the economic areas. The most obvious loss this engenders is in the area feedbacks into the system. One specific case is that PIES does not explicitly account for the expenditure of pollution control on interindustry decisions including energy costs and investments. Although this is only about 2% of the total GNP, it is a significant percent of specific industrial sector expenditures. The electric utility sector, for example, is important to both energy and environmental policy makers, spending about 10-15% of its annual expenditures on such items. However, the linkage between PIES and SEAS is much more straightforward when national and Federal region levels of energy demand and supply are used to drive SEAS.

In another area, the regional forecasts are subject to criticism. In the beginning of this paper, I discussed top-down vs. bottom-up forecasting. Proponents of the latter school hold that no macro-modeling technique can possibly accurately reflect the richness and uniqueness of individual regions of our Nation. The methods used in the PIES and SEAS models are based on logic structures which generally assume partitioning of data according to historical patterns. A few of the more analytically sophisticated subroutines may go so far as to adjust these regional shares according to some preordained decision rules. There is some truth to allegations that such rules cannot possibly represent reality and suffer most as one becomes more regionally-specific or moves further ahead in time.

At DOE, we have recognized this deficiency but have not been able to solve it in a strictly empirical fashion. Although space does not permit complete exposition of the technique, I can capsule it as a non-computer interface.

Specifically, the state-level forecasts of both the energy supply and demand and the resulting environmental impacts are sent to six research centers located across the country who, using a mix of models, interviews, and other analyses, add local perspectives, institutions, and laws to the model forecasts. In some cases, then, feedback causes a change in the models themselves; in most it merely enriches the analysis of the data.

It is doubtful whether any forecasting or impact system can ever be designed or perfected to cover all the difficulties discovered. On the other hand, the steps taken to link these two very large systems are significant indeed and the recognition that problems exist and solutions are sought is equally encouraging. There is still a long way to go. These experiences, however, are of enormous benefit for those in the global policy or modeling communities as the technical questions addressed are normally transferable (albeit often only in a conceptual sense) to the similar difficulties with creating analytical tools to deal with global issues.



# FORMULATION OF LONG-RANGE POWER-ENGINEERING DEVELOPMENT CONCEPT

**V. I. Danilov-Danilyan and A. A. Ryvkin**

*Institute for Systems Study of the USSR Academy of Sciences, USSR*

## INTRODUCTION

The attempts to peer into a distant future and, as far as possible, influence its structure are already becoming more and more serious and persistent. The fact that the long-range forecasts are developed at present not by futurologists alone but by experts well-known for their significant contribution to natural, economic and social sciences, illustrates the urgency of the long-range development problems facing mankind. It is no accident that energy and power resources are in the focus of attention and have turned out to be the area of the most intensive research involving sophisticated techniques and methods of modeling and systems analysis.

Today as never before it becomes abundantly clear that the future of mankind, realization of its ancient aspirations to progress and justice are closely linked with penetration into the secrets of a huge laboratory--nature, with the introduction of material resources, developed and being developed in this laboratory, in social and economic turnover. Accordingly, the energy transformed from its natural state to a force controlled by man assumes a special role, becomes one of the decisive component of his might and to a great measure determines the reproduction capacities of the entire human civilization.

The current acute energy problems have arisen due to a shift from a long and seemingly the only possible period of "energy collection", wherein man made a merit of "unsealing" the natural energy endowment and intensive drawing of deposits that have been accumulating for thousands of years, to a new era of mass production and rational exploitation of natural energy sources. This transition has just begun; it is by no means definite as the natural "depots" are far from exhausted and much that is stored there is just starting to attract our attention. But from social and economic points of view, however, one is safe in saying that the transition process has gained momentum and is in full swing as the distant future state of world power engineering is determined by today's ideas and developments carried out on their basis. And these ideas call for an ever-increasing introduction into the economic circulation of "inexhaustible", i.e., sufficiently large energy sources.

We observe that the very consumerism with regard to nature is more and more rejected by progressive mankind, though it is still strong in economic and social structures tracing its origin to the past. However, the influence of these structures on the current decision making, including the decisions relating to distant future, is very strong. They influence also those serious and undoubtedly unbiased research projects

that underlie the long-range strategic decisions in the area of power engineering. In this paper we shall discuss a number of generally accepted conceptual hypotheses which are behind numerous research projects of both power engineering and of a more general nature, hypotheses which, routine though they are, do not seem indisputable at all. We shall touch upon only those assumptions, however, that essentially affect the selection of development strategies and whose rejection may question many a conclusion on alternative ways of overcoming natural difficulties of the interim period.

#### CONCEPTUAL HYPOTHESES BEHIND THE PRESENT NOTIONS

a) Commenting on the reasons for the world energy crises that burst out in the early 70s, the majority of experts place the emphasis on the fact that the era of cheap energy, that led to wasteful energy consumption, has gone. The sources of cheap energy are limited, and the exploitation of new deposits and application of new types of energy imply greater expenses. Such an approach to describing reality is quite customary for economists. Most of them have developed their theories on the basis of the hypothesis of the *limited nature of resources suitable for economic exploitation and of primary utilization of the best factors of production available*. Formally this hypothesis is realized in economic models in different ways, in particular, by choosing the production functions, linking the output and resources, so that the first partial derivatives with respect to each of the resources are positive and the second partial derivatives, negative. Thus, the use of such production functions means that, first, the set of considered economic factors is strictly fixed. Second, the very factors are internally homogeneous, and their values form a linear space wherein the production function is specified. Third, the use of such functions for long-range forecasting presupposes additional hypotheses both on commensurability of factors and output at considerably separated time intervals and on the nature of changes of the factor space or the very functional dependence over time. The production functions theory, developed in econometrics, employs approaches based on the notions of the so-called technology space where the technological advance is interpreted as the change in the function parameters over time. In any case, in the existing mathematical models of economic growth technological progress is interpreted either as an explicit function or as an implicit dependence on the structural parameters of the model, which is a function of time too. Be that as it is, this implies relationships affecting the rate of output, though the influence may be indirect (e.g., through the dynamics of a real and registered departure of factors, etc.).

b) The ideas concerning ways of solving energy and more general problems of world development are based mostly on the hypothesis of *reproducibility of advanced countries' technologies in developing countries*. Accordingly, a conclusion is made that the developing countries should mostly adopt and utilize the scientific and technological achievements offered by the advanced countries. The logic of this approach leads to an assertion that the industrially developed countries have to extend their technologies, including the energy ones, to backward countries while the latter, through economic relations established with the former, must not only compensate the rendered assistance with supplies of natural resources but also assist further technological progress in the developed world. As a result, the assistance in technologies and equipment rendered by the consumers of natural resources is proclaimed to be a decisive source of industrial growth in the third world countries for the whole period of their adaptation to the established forms of international division of labor. According to the proponents of this concept of scientific and technological progress the countries most rich in natural resources will henceforth specialize in their extraction while the consumers will continue specializing in development of new technologies.



c) In the condition where the reserves of the most effective energy resource--oil--are near to exhaustion, the entire world should exercise a gradual transition to new energy sources consuming the remaining reserves of cheap energy just for maintaining the economic activity during the interim period. This thesis is partially derived from the two preceding ones and is supported by the arguments on the growing interdependence of all the partners in the world economy, which is becoming ever more unified.

d) The established trends in the dynamics of world market prices are quite natural and reflect the objective socio-economic laws. In other words, at the time of cheap energy one could observe a justified tendency towards a relative reduction of raw material prices while the new stage, involving the more expensive energy, must bring about a reverse trend to higher natural resource prices.

e) The current world price structure is in principle (i.e., with regard to the continuing trends) acceptable for comparing the costs and effects of extensive future introductions of various new technologies, and the economic effect calculated on the basis of these prices may be used for comparing the long-range decision alternatives.

f) The traditional economic measures like the Gross National Product, Gross Domestic Product, National Income and so on are reliable guidelines for measuring the real long-run dynamics of national economies of countries and regions. The economy featuring higher rates of macro indicators growth catches up with the economy developing at a slower rate.

g) The comparison of economic evaluations (criteria) may be used for operational purposes too, i.e., as sufficient conditions for making actual economic decisions at the macro level.

#### ANALYSIS OF TRADITIONAL HYPOTHESES AND ALTERNATIVE ASSUMPTIONS

Almost all of the hypotheses mentioned above are perceived by the majority of forecasters as laws of socio-economic development reflecting not only the generally accepted point of view but the essence of the actual development processes. But are these assertions truly indisputable, is the line of development that is the logical consequence of these assumptions as straightforward as is implied?

a) The assumption concerning the limited volume of resources suitable for economic application and the primary utilization of the best factors of production, essentially limits the area of possible development options.

First, this fixes the structure of the considered technological factors. The introduction into the analysis of quite new resources, in particular of new energy sources, is possible only through an application of respective changes to the old structure. In other words, alteration of the object when its development in certain directions has slowed down while the new dimensions, non-essential for the former structure, tend to grow, is either not taken into account at all or (at best) is accounted for as applied to the space specified by the structure that existed at the time of forecast development. Within the framework of long-range and super-long-range analysis this hypothesis may exert a strong distorting influence.

Second, the dynamic models based on such hypothesis, even if the dimensions of the considered space are set a priori, are capable of reflecting just "trifle" changes interpreting the general development trajectory as an integral curve which appeared as a result of stagewise current decisions. Hence, long-range (structural) laws are identified with the sequential realization of short-term interactions similarly to the solution of differential equations.

Third, our notions of economic systems are based to a measurable degree on the postulate of the existence of not only fixed finite space, within which the object develops, but of the presence in this space of a normal coordinate system. It is worth pointing out that this normalization exists objectively independently of the state of the considered system. Unfortunately, this postulate is applicable only to a short-range analysis as the system of cost economic measures depends essentially on the reproduction structure of economy, i.e., not only on the effort expended by each of the independent elements of the system but on *how* these elements are isolated from each other, and *how* they interact in production, exchange, and reproduction.

b) The hypothesis of the global reproducibility of technologies, prevalent in the advanced capitalist countries, closes up with the assumption of the only way of technological advance in our civilization, of independence of technical change from the existing reproduction structure of world economy. To prove the flimsiness of such hypotheses, suffice it to analyse the situation that would have formed in the world should the developed capitalist countries be completely cut off from raw materials in other parts of the globe. What are the major structural changes that would have followed the deep crisis? Probably, many a directions viewed at present as technological progress would have been abandoned as wasteful and inefficient. But why are they not considered as such today?

In order to fully comprehend the problem we may analyze the possible consequences of yet another assumption. Let us assume that it became possible to instantaneously disseminate the most advanced technologies, possessed for example by the US, and set up enterprises equipped with respective machinery and staffed with highly-skilled personnel all over the world. Would the gap between industrialized and developing countries be bridged in this case? No, there is no solution to this problem by this route. The problem is not confined to the fact that some countries have already passed certain stages in their development while others have still to make it. The most sophisticated technologies reproduced across the world will remain idle as the type of technical advance we observe has taken place in specific socio-economic environments.

Numerous achievements of technical thought in the US were realized owing exclusively to specific features of the reproduction structure of the world economy. This structure happened to be stratified and its lower layers, connected with extraction of natural resources, shift at an ever-increasing rate to the developing countries while the upper ones involving development of technologies and manufacture of equipment turn to the most advanced countries. The laws of the "free trade" world are such that they dictate the selection of the only long-range development strategy based on the concept of comparative costs. Following this strategy implies that each region must strive to specialization in the field where its efficiency will be the highest, i.e., the developing countries should henceforth concentrate on turning out raw materials and semi-products and the advanced ones, on the development of technologies and manufacture of equipment. With surprising unanimity this point of view is shared by the majority of authors of well known global projects. M. Mesarovic and E. Pestel give it the form of "humanism" when speaking of organic growth. G. Kahn upholds it from the positions of a blunt reactionary pointing out that though the US does allocate a third of world resources in its interests, it is only fair as the destiny of civilization is determined by those who are capable of ensuring the technological change and, consequently, it is only to the benefit of mankind if the poor and unskilled do dirty and unpleasant work for them. Now we are interested, however, not in the social aspects of such a long-range development strategy but in the feasibility of other strategies that do not lead to stratification of the reproduction structure of the world economy but provide conditions for the comprehensive development of each participant of international division of labor and integrated employment of his natural and other

economic resources. The strategies oriented at internal evaluation of developing countries and the establishment of an economic reproduction structure adequate to this problem, will result in a different type of world technological progress. In such conditions the technical advance in the most developed capitalist countries will no longer rest upon a huge resource base. Incentives will appear for an accelerated transition to technologies penetrating into new, deeper and wider spheres of nature.

The assistance from the industrialized world to the developing countries must not at all aim at reproduction on the part of the latter of simplified or, as referred to at present, adaptive technologies. The assistance will really enhance the development only if the developing regions are assisted in setting up their own reproduction structure and, in this case, if they find ways of satisfying their basic requirements with internally reproducible technologies.

c) It is difficult to oppose the thesis of the necessity for a gradual transition to new energy sources as it becomes clear that the traditional sources can no longer meet our requirements. Today, however, the world does not yet face the shortage of oil. It is available and will surely last for some 20 to 30 years of intensive exploitation. That is why the problem of gradual transition to new sources must be approached simultaneously with the questions of how best to dispose of the available reserves and whether the entire world will undergo this transition at one time. At present the advanced capitalist states pursue a policy aimed at immediate consumption of the best reserves available in the world, as this is allegedly the optimal strategy for the globe as a whole. Indeed, such a strategy would have been really optimal if the world economy were first, a unified nonconflicting whole and second, consisted of homogeneous regions. As none of the conditions are met in reality the proclamation of such a strategy equals the slogan: let us first eat yours together and then each will eat his own. The arguments that in exchange for their resources the developing countries receive technologies (as a rule intended for extractive industries or primary processing of raw materials) and other modern commodities (mostly for current consumption) do not change the essence of the matter.

New ways of energy generation will inevitably be discovered. But irrespective of the combination of specific technologies that would be applied, the general law inherent in the progress in the man-nature relationship will remain intact. According to this law the transition to the next technological level involves generally a sharp rise in capital investments and creation of much more powerful artificial systems supporting the man-nature interaction. The effect of the system introduction measured in terms of increased output must, with their wide-spread application, surpass the system size growth. Only in this case may one speak of progress. Thus, at the initial stages of new technology introduction the capital intensiveness of produce will grow (if it may be reliably measured) and then as technology becomes commonly applied, it will go down. No doubt that out of the multitude of proposed alternatives mankind will choose only those that, first, require feasible systems consistent with the given level of development and, second, offer lower capital-intensiveness of the generated energy compared to its current level.

At the same time it may be near to impossible for the developing countries to construct energy transfer systems which require sizable initial investments. Hence, it is these countries rather than the advanced capitalist regions that need the remaining reserves of traditional energy sources at the initial stages of development. Accordingly, the gradual transition to new energy sources may be exercised only with due account of the mentioned need of developing countries. They will be unable to meet this demand within the present structure of world economic relations as the few countries possessing huge oil reserves realize their exports in

the world market dominated by the stronger consumers. Hence, the developing countries have only one way out, i.e., establish large economically integrated regions and frame reproduction economic structures there adequate to the goals of development.

d,e) Recently economists have extensively discussed the long-run dynamics of raw material and finished product prices. Some presume that in conditions of inflation the relative raw material prices tend to go down as the finished product prices, primarily machinery, grow at a faster rate. Others, following the official price indices, assert that the dynamics of raw material prices and those of finished product prices are approximately equal and, moreover, the raw material prices rise even at a faster rate.

In our opinion the comparison of price indices for different aggregate products under the conditions of the stratified reproduction structure of the world economy, given its extreme heterogeneity and high trade barriers, can hardly clarify the nature of exchange between regions with different levels of development.

The mechanism of price formation for new equipment in the advanced capitalist countries is such that the price is set on the basis of the cost of the additional living labor replaced by this equipment, on the basis of the effect gained through its utilization (replacement of existing technologies) and with due account to costs incurred in its manufacture. The contribution of each of the mentioned factors may be different depending on specific market conditions. The present patent system enables the manufacturers to set the price on the basis of replacement and accordingly gain a sizable inventor's profit. Further on, as production expands, the price would not actually increase which, given the general inflationary background, would seem as its reduction while the mass of profits will grow on as the price considerably exceeds the level of costs. What is more, the frequent artificial innovations practiced in the majority of industrialized capitalist states (linked with the introduction of some additional quality or the simple addition of a new part to the product) and frequent revisions of the base for calculating the price indices indicate that the dynamics of indices cannot cover the considerable share of quite inflationary price growth.

The developing countries are in a quite different position. They have either no alternatives at all to the purchases of equipment (when they start or run national production) or, at best, solve this problem by comparing the costs involved in the manufacture of machinery on their own. In any case the arguments in favor of purchasing the equipment usually dominate. Irrespective of the equipment price its cost would be included in the cost of products manufactured using it, etc. Should it be used for resource output, then the raw material cost will again be taken into account in setting the price of new equipment and so on. However, the raw material producer and its consumer, i.e., equipment manufacturer (or any other modern product) are in different conditions. The cost structure of the former is open for study while that of the latter is a commercial secret. That is why the comparison of actual efforts of partners (be it possible in principle) is quite impossible in reality. It is clear though that the decisive word in the inflationary race rests with the second partner as it is he who is less controlled. But when the second overstates his effort at a faster rate, we may but spot it when reviewing the dynamics of price indices. Moreover, as the equipment cost is a component of raw material price, while the equipment itself is rated as a new product, these indices may even show a faster rise in raw material prices.

We have undertaken such a detailed excursus into the economic problem in order to illustrate the precarious basis the generally accepted point of view rests on today. According to this point of view the lower quality of resources implies higher costs of output. They do increase only if there is no progress in technologies. Should

progress be available the rising costs are quite nominal and reflect a certain policy of those who develop technologies and manufacture equipment. As for the comparative dynamics of official price indices, these do not provide a solid basis for either sound conclusion or rapid forecasts as they overstate the efforts of the economy specializing in resource extraction and understate as regards the economy producing new technologies, equipment, and other new commodities.

The fact that even with these distortions we observed rather lengthy periods during which resource prices, including energy, grew much more slowly than the general rate of inflation, while the trend in their falling behind the general price rise is observed continuously, is a serious argument pointing to the existing gap in the dynamics of actual evaluation of efforts of developing and advanced capitalist countries directed at turning out final products. Where the gap in dynamics leads is easily seen from the example of a simple model simulating the interrelationships of the economy of a certain country with the world market. Further on we shall identify the notion of *price* not with the movement of price indices but with an actual evaluation of each of the trade partners.

Let a product put out in a certain country be equal to  $Y$  and the product the country disposes of after foreign trade operations equals  $X$ . Both values are measured in fixed prices. The export quota of this country is a fixed share of  $Y$ , or  $aY$ , and the world prices of its exports rise at an average rate  $p$  compared to prices of imports. Then the physical volume of the product the country disposes of after foreign trade exchange will be:  $X_t = Y_t + Im_t - Ex_t = Y_t(1 + ae^{pt} - a)$ , provided the currency surplus is used for import.

Let us calculate the growth rate of  $X$  and designate the growth rates of  $X$  and  $Y$  as  $x$  and  $y$  respectively. Then

$$x = \frac{\dot{X}_t}{X_t} = y + \frac{ape^{pt}}{1+ae^{pt}-a} .$$

For  $p > 0$  with  $t \rightarrow \infty$  in the limit we have:  $x = y + p$ , i.e., as a result of a prolonged action of the mentioned trend in the foreign trade prices, the country which is in a better position will annually gain from the outside a certain additional growth rate approaching  $p$ .

True, the country with  $p < 0$  will insignificantly reduce its rates as a result of exchange. At a starting point the deduction from its growth rate will equal  $ap$ , and then it will decrease and tend to zero.

Let us examine the interaction between the two economies under these conditions. Let index I correspond to the economy in more favorable conditions. It is easy to see that with  $y_1 + p < y_2$  the marginal growth rate for the first economy will be  $x_1 = y_1 + p$  and for the second one,  $y_2$ . If we take into account that the first economy is advanced and the second one developing, then the gap between them will close at a rate approaching  $y_2 - y_1 - p$ .

When  $y_1 + p = y_2$ , then irrespective of the higher internal rate the developing economy will not catch up with its more powerful partner.

If, finally,  $y_1 + p > y_2$ , then we encounter the situation where the less developed partner in the exchange will be unable to satisfy the continuously growing "appetite"

of the partner in its product. For a while it may reach the balance by increasing its export quota. As such a process does not ensure a durable balance the situation will inevitably reach a crisis point: the developed economy will face shortages in the product supplied by its developing partner.<sup>1</sup> If the developing economy specializes primarily in labor-intensive production then the system will witness an imbalance of the raw materials crisis type. An attempt will be undertaken to raise the price of raw materials that will encounter tough resistance from the developed partner which will boost prices of its exports, primarily of equipment, food and speciality goods as all of them have their own, to a certain degree, definite consumer.

Such a price war would not bring complete victory to the developed economy, i.e., maintain the old exchange terms with the unchanged structure of the world economy. Should the advanced economy not be inclined to close the gap in price growth rates from  $p$  to  $y_2 - y_1$  then it will have to find some new strategy for foreign economic relations aimed at a lower  $y_2$ . One of the options of this strategy is the transfer to the developing countries of a group of industries providing the next level of product processing that follows the one attained by the developing economy. This will not affect the dynamics of prices on the transferred industry's products as the price of labor power in the developing economy is not only lower but rises at a slower rate.

One may see from these models, given the natural hypotheses relative to scientific and technological progress, that a long-run orientation of each country towards the predominant application of the most beneficial (from the point of view of international exchange effect) technologies leads to a rapid stratification of the reproduction structure of the world economy, i.e., some economies start specializing in producing resources and semi-products, others in manufacturing mass products, a third group in producing equipment and a fourth in developing technologies. And the prices of the respective products, supporting the long-run system equilibrium, assume different dynamics as the competitive price in the world market forms under the influence of internal evaluations of a product, and the latter substantially depend on the reproduction structure of the economy. The more difficult it is to reproduce a certain necessary product, the more advantageous it looks for the economy to import it, but the longer the economy renounces the domestic manufacture of this product, the more it falls behind with respect to technology, and it is much more difficult to start the necessary production in the future. The mentioned contradiction may be solved only with a long-range development strategy oriented not at comparative costs but at the creation of a reproduction structure of the economy which is adequate for the goals of comprehensive development.

Thus, the model arguments show how the different long-run dynamics of world prices (more accurately, of domestic effort evaluations) of exports of advanced capitalist countries and developing regions lead to a situation where the former import foreign growth rates and in exchange export inflation.

f,g) What has been said above testifies to the fact that such economic indicators as GNP, GDP, and the like are quite unacceptable for operational purposes. In particular, the struggle of developing countries for higher growth rates in these indicators with continuing adherence to the comparative cost strategy will not bridge the gap between the advanced and developing regions. In fact, as it follows

---

<sup>1</sup>We may note here that the developing economy permanently faces shortages in products supplied by advanced economies. This, however, results mostly in its internal crisis phenomena such as shortages in technologies and respective equipment adequate to its needs, shortages in commodities to meet consumer demand and so on. This, however, does not necessarily exert a decisive influence on foreign trade relations.

from the above model the economy growing at a higher rate may but catch up with the slower growing economy.

Let us pay attention to yet another specific feature of aggregate cost indicators which makes it undesirable to use them in the analysis of long-run laws. The dynamics of these indicators substantially depends on the internal structure of an economy, its share in the international division of labor, and its position in the structure of world economic relations. Hence, a particular domestic effort even one particular economy may be viewed differently when included in different foreign relation systems. We get yet another proof that there is no system of economic measures independent of an object as well as of its environment (in case the object is open). If a short- or medium-term analysis may neglect to an extent such dependence then it is quite inadmissible to abstract from it in a long-range approach. At the same time an attempt to study and account for this dependence in quantitative terms will hardly result in more sound decisions than those attained through a phased implementation of short-term decisions. The long-term interrelationships should not be approached with the same requirements as set by theory when describing conjuncture behavior of economic systems. The long-range analysis does not require extremely accurate predictions as the current costs a society bears in the name of rather distant goals are on the one hand, not so great as to press for immediate abandonment of alternative options and on the other, are so important in terms of future structures that a certain variation in research and development, providing for quick manoeuvre, is necessary. At the same time the acceptable variation is not at all unlimited, it is to be confined to the framework of a certain general strategy of long-range development formulated, as was already mentioned, in accordance with the focal goals of a system.





# ASSESSMENT OF SCIENTIFIC AND TECHNOLOGICAL PROGRESS IN ENERGY DEVELOPMENT FORECASTING

**V. N. Burkov\*, V. A. Irikov\*\* and A. S. Makarova\*\*\***

*\*Institute for Control Sciences of the USSR Academy of Sciences, Moscow, USSR*

*\*\*High Temperature Institute of the USSR Academy of Sciences, Moscow, USSR*

*\*\*\*Central Economic and Mathematical Institute of the USSR Academy of Sciences, Moscow, USSR*

## ABSTRACT

The approach to evaluating the long-range energy development, which has been worked out in the USSR, stipulates the application of a set of mathematical models. Recent efforts provided inclusion to that set of some new elements designed for the assessment of scientific and technological progress on the energy sector, namely: models for the assessment of parameters of an alternative to a new energy technology; models for choosing between alternatives to a new technology; an aggregate model for the assessment of Research and Development strategies. The paper describes the approach to the build-up and structure of these models. Besides, the problems of interfacing of new models within the whole set of energy models are discussed.

## KEYWORDS

Scientific and technological progress; R+D program; R+D strategy; R+D planning and forecasting; new energy technology; life-time; research; design, testing; commercialization; R+D modeling; model interactions.

## INTRODUCTION

The growth of demand for technological advancement over the coming transitional period of the energy systems development, as well as the anticipated growth of capital and material intensiveness of energy, are expected to reinforce the interdependence between patterns of energy supply systems development and energy R+D activities. Such an observation was made in particular in recent papers by Häfele and others (1975), Kononov (1977), Makarov and Melentyev (1973), and Melentyev (1979).

Undoubtedly this requires a more comprehensive assessment of energy R+D strategies in the process of energy planning and forecasting, which would provide consistency of R+D strategies with the general energy systems development, and vice versa. In this paper we describe a possible approach to planning and forecasting in the sphere of scientific and technological activities on the energy sector which would meet such a requirement. The approach implies wide modeling of the systems under consideration.

In the first section of the paper the place of R+D activities in the whole process of energy development is determined, and their principle characteristics are given. Also, a classification of tasks of R+D planning and forecasting is proposed, stressing the connections of these tasks to those related to projecting future energy development.

The next section reviews the scope and functions of the models we propose for use in energy R+D assessment. A special set of models is to be used for completing each R+D planning/forecasting task. The composition of the models and their interactions, as well as their connections and feedbacks with other models for energy development are described.

The final section of the paper shows the place and role of the proposed models in the assessment efforts of long-term R+D strategies.

#### PROBLEMS OF R+D PLANNING AND FORECASTING

In a somewhat conventional way an R+D strategy may be determined as an overlapping set of concrete R+D programs developing over time, each of which is described by a set of indices characterizing its results and the process of fulfillment. Here, an R+D program means a large project resulting in the creation of a new complex energy technology (like the MHD-plant) but not of a particular equipment (like a turbine or generator).

The results of an R+D program are described by the following two groups of output indices:

- techno-economic parameters of a new technology (e.g., energy efficiencies, specific capital investments);
- scales of deployment of a new technology measured in rates of its installed capacities over time.

The process of fulfilling an R+D program may be described in terms of projects, tasks, and problems to be completed and solved, and of the necessary resources. For our purposes let us consider this process as a sequence of different stages of life-time of a new energy technology from its conception to the end of operation, namely: fundamental and applied research; projecting and designing; experimental and industrial testing; and commercialization (large-scale production of equipment for the new technology, construction and operation of new facilities).

Let us agree that the stages of the life-time of a new technology from research to reaching the projected levels of its output characteristics were regarded as a part of the R+D activities, and that the stages from development of the leading commercial sample to the start of operation of a given technology were regarded as part of the industrial activities. In this case the major target of R+D planning and forecasting is an identification of a preferable R+D strategy, including time-schedules of different R+D activities (composition of R+D programs to be fulfilled throughout a given time horizon, their timing, and the distribution of the limited economic resources among them) and their expected results (levels of output characteristics and scales of deployment of new technologies).

Keeping in mind the approach to the R+D programs described above, the process of energy development can be considered as a continuous flow of life-cycles of different technologies. The heterogeneity of this flow makes the whole problem of energy planning and forecasting significantly more complex, and necessitates its decomposition into a set of comparatively homogenous interconnected tasks. Let us take the USSR scheme for planning and forecasting as a basis for such a decomposition.

It is obvious that the necessity of fulfilling any R+D program should be based on the needs of the energy supply system (ESS) development. Let us therefore subdivide the R+D programs into four classes with regard to the degree of their completion and the time period expected to lead to the beginning of a large-scale deployment of the resulting energy technologies. Such a classification with indications of associated uncertainties of input data is given in Table 1.

TABLE 1 A Classification of R+D Programs With Regard to the Degree of Completion

Classes of R+D Programs	Status of a New Technology Development	Time Leading to Industrialization	Associated Uncertainties of Input Data
1. Industrial testing	Pilot industrial sample has been built and is being tested	4 to 6 years	1. Timing of industrialization (depending on resources available)
2. Experimental testing	Experimental industrial sample has been built and is being tested	up to 9-11 years	1. and 2. Scales of deployment 3. Meaning of input characteristics within a given design
3. Design	Applied research has been basically completed and designing phase has started	up to 20 years	1., 2., and 3., and 4. Alternatives for design 5. Alternatives for manufacturing processes
4. Research	Applied research has been started on the basis of completed fundamental research	more than 20 years	1., 2., 3., 4., and 5., and 6. Scientific and technological alternatives for a new technology 7. Alternatives for organization of research

The figures of Table 2 indicate which classes of R+D programs should be subject to assessment at different stages of planning and forecasting in both the ESS development and energy R+D activities. Analyses of the time required to fulfill large energy R+D programs show, e.g., that in the next 5 years only the large-scale development of existing technologies (class 0) is possible; in the period from 5 to 10 years ahead the commercial deployment of technologies of class 1 could be expected; etc.

Now let us elaborate on the tasks of R+D planning and forecasting for the above classes of R+D programs.

For technologies of class 1, which are now subject to industrial testing and will be commercialized within the next 4 to 6 years, the major problems are connected with the organization of their industrial deployment. As these problems are solved almost completely at the medium-term planning stage of ESS development, there are no choices left in the sphere of R+D planning. Thus, the main tasks to be completed while making the medium-term planning projections for class 1 of R+D programs are: construction of pilot series of industrial samples of new technologies and reaching the projected values of their output characteristics; distribution of responsibilities among building and, partially, projecting firms; mastering serial production of equipment and distribution of resources in related industrial sectors.

TABLE 2 Correlation of R+D Program Classes to Different Stages of Energy Planning and Forecasting

Stages Systems	Planning		Forecasting		
	Medium-term 5 years	Long-term 10 years	Medium-term 20 years	Long-term 30 years	Super-long-term 40-50 years
Energy supply system	0	0 1	0 1 2	0 1 2 3	0 1 2 3 4
R+D activities	1 2 3 4	2 3 4	3 4	4	4

Technologies of class 2 are expected to be commercialized within some 9 to 11 years; they should therefore be assessed by their impacts to the ESS development within the framework of the medium-term forecasting of energy production in order to provide for proper and timely preparatory measures in related industrial sectors. In this connection the most important tasks to be undertaken at the long-term R+D planning stage include: making an ultimate choice between the alternatives for each new technology design and construction, as well as for the values of its output characteristics; elaboration of technological tools, terms, and scales of manufacturing of the necessary equipment; distribution of responsibilities among experimental industries and, partially, projecting firms; estimation of necessary scales and terms of capital construction and reconstruction in related industrial sectors, and distribution of capital investments and building capacities among them.

For technologies of class 3, which are shifting from research and development to industrialization within some 20 years and are thus covered by long-term forecasting of ESS development, the problems to be solved consist in the choice of the preferable alternatives for R+D programs on the basis of a wide sensitivity analysis. Consequently, the following tasks should be considered the major ones in medium-term R+D forecasting: narrowing down the range of studied alternatives for a new technology (to 2-3 alternatives); specifying the ranges of possible values of the output characteristics and the schedules of the work; identification of the key problems which require enforced efforts (e.g., development of new materials and manufacturing technologies); estimation of the scales of commercialization of new technologies with complex accounting for the demands of ESS development and constraints from machinery and other related sectors; substantiation of the distribution of projecting and, partially, research capacities among R+D programs for the first 5 years; forecasting of the patterns of development of energy related industrial sectors; forming the R+D programs in those industrial sectors supporting the energy sector, including distribution of research and projecting capacities among them. The completion of these tasks results in the formation of the long-term energy R+D strategies.

The technologies of class 4 are expected to reach the stage of industrial development in more than 20 years from now (that is beyond 2000). Here, the major point is to explore and specify possible ways of utilization of new scientific conceptions in the field of energy. Accordingly, the tasks to be completed at the stages of long- and super-long-term R+D forecasting include: analysis of possible directions of research for the creation of new energy technologies on the basis of

different combinations of physical, chemical, and other effects; evaluation of the utmost levels of output characteristics of such technologies; assessment of their competitiveness with other classes of energy technologies; identification of the fundamental key problems. However, it should be noted here that, because of large uncertainties in the data used for super-long-range energy projections, a quantification of the interaction between the research and production spheres of energy development is extremely complicated. Therefore the results of such projections may serve only as some informal zero-order basis for making decisions.

When looking at the above sets of R+D planning/forecasting tasks from the viewpoint of choosing between strategic directions of the scientific and technological progress, it becomes apparent that the tasks connected with class 3 of energy technologies and long-term forecasting of the ESS development (see darker boxes in Table 2) and, to some extent, those connected with class 3 of energy technologies and medium-term forecasting of the ESS development are of primary significance. So, in the following we will center our attention on those tasks, while considering a set of models for R+D assessment.

#### A SYSTEM OF MODELS: DESIGN AND STRUCTURE

A systems approach to energy (see, in particular, W. Häfele and others (1975), Kononov (1977), Marakov and Melentyev (1973), Melentyev (1979)) and to planning of R+D activities (developed, e.g., by Irikov, Shabunin and Sheverov (1975), Komkov (1978), Martino (1977), Pospelov and Irikov (1976), Yanch (1979)) is available to solve methodological problems connected with the assessment of energy R+D strategies. The approach which has been developed in the USSR on this basis stipulates the modeling of the main internal and external connections in the energy field. However, the models are regarded as an auxiliary tool which arranges and amplifies the creativity of the specialists.

Let us first outline briefly the system of models used for long-term energy assessment (see Figure 1). The core of the system is the dynamic model for the ESS development (M-4 in Fig. 1) which describes major internal (technological, territorial and other) energy links. Its chief objective is the estimation of impacts of new technologies to the total ESS development and an analysis of the effects of the limited extent of high-grade fuel resources.

A long-term dynamic inter-sectoral model (M-1) is intended to: assess the impacts of energy on the economy; ensure consistency within the various energy development strategies; provide a basis for energy demand calculations.

An energy demand model (M-2) is used to calculate the substitutable and non-substitutable shares of future energy consumption, taking energy-economy inter-relations into consideration.

The M-3 model determines the resources and reserves of high-grade fuels (oil and gas), as well as the future levels of their production in consistency with growing production costs.

The start-up dates and techno-economic output characteristics of new technologies are determined in a set of models for R+D activities.

The necessity of an integration of science and industry as well as of forecasting and planning calls for the development of a normative approach to R+D forecasting (Martino, 1977; Yanch, 1979), combined with a goal-oriented approach to R+D planning (Pospelov and Irikov, 1976) for the purpose of energy development. In this approach R+D activities are regarded as a partially controllable system whose

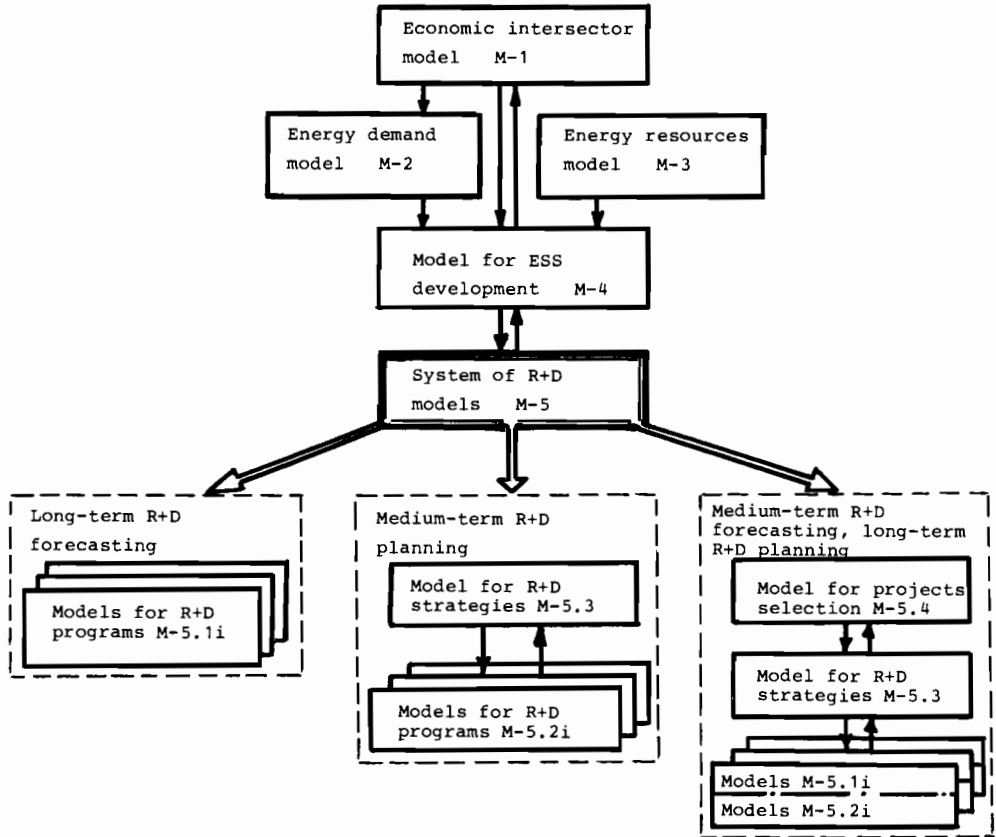

Fig. 1. A schematic representation of the models for R+D planning and forecasting, and their linkage.

chief objective is the elimination of bottlenecks arising in energy production. This requires recognition and simulation of both, internal links in R+D activities which integrate R+D programs into a unified system and provide possibilities of management, and external links, primarily on the energy production sector.

Until recently energy modeling tended to neglect these requirements. A typical approach was that estimates of output characteristics were made for each new technology; then an energy supply model was investigated to yield an approximate estimate of the scale of commercialization of new technologies. The adequacy of such an approach is questionable because of the underlying assumptions that R+D programs are independent, that the economic resources for the programs are unlimited, and that the R+D activities are independent of the general energy development.

There are the following factors (links) combining separate R+D programs into a system:

1. Links through common resources for all R+D programs. The resources necessary for completing all potentially feasible and useful projects are several times larger than those available. Deficiency of resources significantly affects the list of projects under way and their time-schedules.

2. Links through common elements of different technologies. Such elements make R+D programs mutually useful in terms of cost and time reductions, a growing probability of success and improved values of some output characteristics (especially specific costs) of new technologies due to unification, standardization, and facilitation of serial production.

3. Links through the final objective which may either lead to a competition of technologies (if they perform similar functions) or to their mutual benefit by elimination of individual disadvantages (e.g., a combination of nuclear power plants and hydrogen production plants).

The existence of controlled factors which determine the course of scientific and technological progress is useful for organizing an iterative procedure of interaction of R+D models and the model for ESS development, in such a way that the system of R+D models provides the ESS model with data on the potential technological advancement (a list of feasible technologies and their characteristics), while the data on the demand of the energy sector for new technologies are provided by the energy supply model for the R+D models (with due regard to the internal and external connections of the ESS).

Let us first outline the possible structure of R+D models and their functions, and then take a more thorough look at the system of these models (see Figure 1).

Model M-5.1i recognizes the physical and technological links among the subsystems (elements) of technology "i". Its major functions are: (1) estimation of the values of the basic characteristics for a given design; (2) search for a design which offers a better set of values of output characteristics.

At the initial stages of fulfilling an R+D program, the models based on morphological methods of analysis can serve as M-5.1i models (Yanch, 1979), while at the final stages the models optimizing the technological parameters (such as the one described by Levental and Popyrin, 1972) may be used.

Model M-5.2i, describing the development process of technology "i", considers the internal technological and organizational links in performing its activities. Its functions are: (1) to provide an optimistic estimate of the time of completion of the i-th program and a pessimistic estimate of its resources requirements; (2) to establish the resources-to-time dependences; (3) to schedule the activities in the development of the i-th technology.

Model M-5.3 for R+D strategies considers the above mentioned links between R+D programs to be implemented while neglecting the alternatives to an R+D program. Its objectives are: (1) specifying time and cost estimates with regard to the links between R+D programs; (2) allocation of resources among R+D programs and estimation of their start-up and completion dates.

Model M-5.4 for R+D programs considers the links between new energy technologies and their development options. Its chief function is to narrow down the number of alternatives to an R+D program, taking mutual utility of R+D programs and the limited resource situation into consideration.

For a detailed description of the M-5.2i, M-5.3, and M-5.4 models, their underlying algorithms, and their results, see Irikov, 1977; Irikov and Larin, 1978; Irikov, Shabunin, and Sheverov, 1975; Komkov, 1978; Pospelov and Irikov, 1976. Here we will briefly consider only some modifications of these models.

As we know, experts are recruited for estimating the levels of the characteristics of new technologies. Since the experts represent, however, different organizations,

and their estimates reflect the interests of these organizations, their expertise becomes subjective. This may offer an additional source of uncertainty in the input data for the models and it is thus interesting to develop special procedures providing more trustworthy outputs of active expertise. Such a problem is studied in the theory of active systems (Burkov, 1977). Here we will only treat one rather simple example of the ways of solving this problem.

If we assume that the M-3 model solves the problem of allocation of "N" different economic resources among "n" R+D programs, each of which is fulfilled by an independent organization and is completed during time  $T_i$ ,

$$T_i = \frac{W_i}{U_i},$$

where  $W_i$  stands for volume of work to be done on each program "i", and  $U_i$  denotes the available resources. Each organization is assumed to be capable of an accurate estimation of the  $W_i$  values whereas the central (planning or forecasting) management knows only the interval  $(\underline{W}_i, \bar{W}_i)$  of the possible values of  $W_i$ . The forecast estimate  $S_i$  of the value  $W_i$  is reported by each organization to the central management which allocates the available resources consistently with the  $S_i$  estimates, e.g., with regard to minimizing the time for all programs. The optimum solution  $U_i^*$  of this problem is known to have the form  $U_i^* = N \cdot S_i / \sum_{i=1}^n S_i$  and is significantly dependent on the values of the reported estimates  $S_i$ .

Using the tools of game theory, it can be shown (see Burkov, 1977) that associating organization stimulation with the quantities  $\phi_i \approx U_i^* (T_i^{(1)2} + \sum_{i=1}^n S_i / N)$  can assure credibility of the reported estimates, or the values  $S_i \approx W_i$ . If representatives of organizations do not trust the estimate  $S_i \approx W_i$  to be optimal, then a business game can be played in the course of which the players are persuaded that it pays to report credible estimates. Note that this modification of the M-5.3 model, which incorporates stimulation of data credibility, does not require an overview of all the reported estimates and the actual amount performed; and this is important because of the long leading times in the field of energy. It should be said that such examples show principle possibilities of solving the problem considered, however the approach still requires essential improvements in order to prove its adequacy.

If the criterion of achieving the objective cannot be set as a scalar function in the M-5.3 and M-5.4 models, the approach given below is helpful in projecting selection of and resource allocation to R+D programs. The constraints and links of the models are all retained. To replace the goal function, a number of meaningful assumptions are made on the properties of the decisions and procedures within a set of decision rules, which can be corrected in the course of a dialogue and result in the choice of the most preferable decision. For the discrete problem of project selection the tools of a set theory and the Boolean choice functions (Irikov, 1977; Pospelov and Irikov, 1970) are used. For the continuous problem of resource allocation, the simpler and more effective algorithms of the gradient for multi-criterial choice (Irikov and Larin, 1978) lead to iterative dialogue procedures which converge into the most preferable decision in five through seven iterations.



Now let us consider the systems of models intended to assist in completing the R+D planning and forecasting tasks, which were pointed out in the previous section (Figure 1).

In medium-term R+D forecasting all the models mentioned are used. The M-5.1i and M-5.2i models are used to produce alternative projects for each i-th technology and estimate their output characteristics. The M-5.4 model selects and transmits to the energy supply model technological data with regard to the mutual utility of technology alternatives and the limited resource situation. The energy supply model is used for further selection of alternatives to technologies, taking the connections of the ESS into consideration, as well as for specification of the requirements for the output characteristics of the new technologies. The M-5.3 model specifies the schedules of completion of the selected projects in view of the constraints on available resources.

In long-term R+D planning the same set of models is used but the resources are measured more thoroughly, and an ultimate selection of alternatives to each technology is made. Note that the M-5.3 model is also used for scheduling the respective activities.

Now, in medium-term R+D planning the ultimate choice between the alternatives has already been made and only the "resources-versus-time" task has to be undertaken; the application of the M-5.4 model, or of the M-5.1i models is no longer necessary. So, in this case only part of the models is used, as shown in Figure 1.

When solving the problems of long-term R+D forecasting (and those of super-long-term forecasting) an analysis of resources and organizational links in R+D activities does not seem necessary; estimation and approximate selection of alternatives may be made on the basis of the energy supply model runs. This leads to the implementation of only a simplified version of the M-5.1 models for the estimation of the utmost values (ranges) of output characteristics, informally accounting for mutual utility of projects with common elements.

#### APPLICATION OF THE SYSTEM OF MODELS

Let us consider briefly the possible implications of R+D models in the long-term R+D assessment. The place of the models and their informational links may be seen by passing through the major stages of the informal procedure for forming the R+D strategies.

1. Analysis of "bottlenecks" in energy development including those of the long term (the M-1, M-2, M-3, and M-4 models are used).
2. Formation of the list of potential technological innovations as possible tools of filling anticipated gaps in energy development. Estimation of output characteristics and completion dates of R+D programs (simplified versions of the M-5.1i and M-5.2i models).
3. First-order estimation of scales and dates of commercialization of new technologies (interlinking of the M-4 model with the M-5 subsystem of R+D models to be used).
4. Detailed specification of foreseeable alternatives to R+D programs. Specification of the structure of the system and mutual utility of the programs (detailed versions of the M-5.4 and M-5.2 models and the M-4 model).
5. Analysis of possibilities in related industries (first of all in machinery). Updating cost estimates, taking account of the unification of equipment and the

needs of the industries in capital formation and technological advancement (associated sectoral models).

6. Updating the scales and anticipated dates of commercialization of new technologies after allocation of the limited resources (interaction of detailed versions of the M-4 and M-5 models).

7. Composition and approval of R+D strategy and development of five-year- and long-term R+D plans (detailed versions of the M-5.3 and M-5.2 models).

The procedure is iterative. For coordination of the inputs and outputs of R+D models and the energy supply model a converging algorithm is available, which relies on a sensitivity analysis of the M-4 model. At each iteration a solution of the energy supply model results in finding the gradient of its objective function in the field of input characteristics, whose components are used as coefficients in the objective function of the model for selection of R+D alternatives. The solution of the latter model is put back into the energy supply model in an updated form, and a converging procedure is run.

#### CONCLUSIONS

This approach to the assessment of scientific and technological progress contributes to achieving the main objective of forecasting, i.e., to a reduction of uncertainty of possible outcomes by a more realistic incorporation of the following groups of factors: links which define R+D activities as a system; critical links with the sphere of energy production; and the possibility of stimulating the credibility of expert information through the use of models for active systems.

#### REFERENCES

- Burkov, V.N. (1977). Foundations of Mathematical Theory of Active Systems. Nauka, Moscow.
- Häfele, W., and A.A. Manne (1974). Strategies for a Transition from Fossil to Nuclear Fuels. RR-74-7, International Institute for Applied Systems Analysis, Laxenburg, Austria.
- Häfele, W. and others (1976). Second Status Report of the IIASA Project on Energy Systems. RR-76-1, International Institute for Applied Systems Analysis, Laxenburg, Austria.
- Irikov, V.A. (1977). Some Problems of Development of Man-Machine Procedures for the Creation of Plans of R+D. Proceedings of the 2nd International Conference "Management of Rand Dand Education", Wroclaw.
- Irikov, V.A., and V.Y. Larin (1978). Dialogue Procedures for solving Choice Problems in Hierarchical Systems. Proceedings of the Symposium "Hierarchy in Large Energy Systems", Siberian Power Institute of the USSR Academy of Sciences, Irkutsk.
- Irikov, V.A., M.I. Shabunin, and V.G. Sheverov (1975). Coordination of the Models for R+D Planning and Management. In, Mathematical Methods of Analysis, Assessment and Planning of Scientific and Technological Progress. Central Economic and Mathematical Institute of the USSR Academy of Sciences, Moscow.
- Komkov, N.I. (1978). Models for Research and Development Management. Nauka, Moscow.
- Kononov, Yu., editor (1977). Methods of Systems Analysis for Long-Term Energy Development. CP-77-2, International Institute for Applied Systems Analysis, Laxenburg, Austria.
- Levental, G.B., and Popyrin, editors (1972). Methods of Mathematical Modeling and Optimization of Thermal Power Units. Nauka, Moscow.

- Makarov, A.A., and L.A. Melentyev (1973). Methods of Energy Study and Optimization. Nauka, Moscow.
- Martino, J. (1977). Technological Forecasting. Progress, Moscow.
- Melentyev, L.A., editor (1977). Methodical Provisions for Optimization Calculations in Energy Under Uncertainties in Input Data. The USSR Academy of Sciences, Siberian Power Institute of the USSR Academy of Sciences, Moscow-Irkutsk.
- Melentyev, L.A., (1979). Systems Study in Energy. Nauka, Moscow.
- Pospelov, G.S., and V.A. Irikov (1976). Program Planning and Management. Sovetskoe Radio, Moscow.
- Yanch, E. (1979). Forecasting of Scientific and Technological Progress. Progress, Moscow.



# AN OVERVIEW OF MACROECONOMIC EFFECTS OF ACCELERATED IMPLEMENTATION OF RENEWABLE ENERGY TECHNOLOGIES IN THE U.S.\*

**W. Marcuse and P. J. Groncki**

*Department of Energy and Environment, Economic Analysis Division, Brookhaven  
National Laboratory, Upton, New York 11973, USA*

## ABSTRACT

The original formulation of the Brookhaven energy system models was directed toward technology assessment for new and competing energy technologies. The Hudson-Jorgenson econometric model was originally formulated to identify the economic impacts of energy futures where energy use projections departed markedly from historical trends. The two models were married so that the feedback effects of energy and nonenergy demand levels and nonenergy prices generated by the economic model could be reflected in the technology and fuel-mix-selection solutions of the energy model. In turn, the engineering-based energy costs, energy prices, and capital requirements for energy systems characterized in the energy model are used to override the econometric estimates based on historical data in the economic model. Recently, the coupled models have been used to address questions concerning the macroeconomic impacts of accelerating the implementation of renewable energy technologies in the United States. Of particular interest were the scenarios where 1) renewables were included which cost more than conventional alternatives now and in the future, and 2) some renewables that are initially more costly are characterized by a learning curve so that in time their costs come to equal conventional alternatives. A further analysis was done for the first case (renewables always more expensive) under conditions where 1) the incremental costs were paid by the government through deficit financing, and 2) the incremental costs were paid by consumers. This paper will present the formulation of the analysis using the combined energy system - economic model and the results of the study.

## KEYWORDS

Technology assessment; renewable energy; energy-economy interactions; models; hierarchical system.

---

\*This is an abridged version of a paper by Marcuse and Groncki, 1979.

## INTRODUCTION

This paper presents the results of a study of energy/economy interactions, which were generated by the concurrent solution of three complex models. The study is discussed in the context of the limitations and constraints imposed on the analysis by the decision-making environment. Thus, the operational process of defining and clarifying the needs of decision makers is explicitly presented. Descriptions of the analytical models, the nature and current status of the linkages between the models, and plans for future development are documented elsewhere (Groncki and Marcuse, 1979). The underlying approach is that of a hierarchical, decomposed structure with the outputs of one model fed as inputs to the others. The methodologies for the interfaces have evolved over time and the transformations have become routine. The analyst still oversees the interfaces to be sure that the models behave reasonably during the solution routine and to reduce the risk of surprise outcomes.

Most systems analysis reports are on work performed at universities or research centers and are complete in the sense that all possible pathways and outcomes are examined and discussed. In contrast, much work performed directly for decision makers and that enters into the decision process is not reported at all. When it is documented, it is often presented as completely finished even though much of the polishing and detailed analysis was done after the fact. This paper presents a policy analysis that was performed under conditions that are, unfortunately, all too typical. Not all of the analytical questions raised during the study were completely addressed; the "optimal" formulation of the problem was discarded in favor of a "timely" one; and several shortcuts were employed to provide the decision maker with access to the best available information when he needed it, instead of fully refined information when it was no longer useful. This paper presents an unembellished account of a study that was executed under severe constraints.

The study was commissioned by Bert Mason and Greg Ferris of the Solar Energy Research Institute (SERI) and in response to a request from Bennett Miller, Director, Solar and Geothermal Energy Programs, U.S. Department of Energy (DOE). Mason played a seminal role in translating the concerns of Miller into the formulation of the analysis. The technological data were provided by Ferris. The study was executed by a team consisting of Richard J. Goettle IV, Paul J. Groncki, and Joan Lukachinski of Brookhaven National Laboratory; and Edward A. Hudson and David C. O'Conner of Dale W. Jorgenson Associates. The analysis was prepared for Bennett Miller to be used in testimony before the United States Congress in support of his program. The original presentation to the sponsor was in the form of an oral report accompanied by briefing charts. The only documentation to date has been an unpublished research memorandum.

## BACKGROUND

### Departmental Policy Review

In the fall and winter of 1978, the United States Department of Energy (DOE) launched a comprehensive departmental policy review (DPR) of solar energy options. The DPR recommended a solar energy "maximum practical" implementation by the year 2000, with solar energy sources providing about 21.5 quadrillion Btu (quads) of primary energy (fossil fuel equivalents). The DPR base case (which assumes no special solar initiatives above those already legislated plus the effect of higher energy prices) projects a solar sector supplying 14.7 quads of primary energy in 2000. In February 1979, the Office of the Assistant Secretary for Energy Technology in DOE asked SERI to assess the employment implications of

the DPR scenarios. It is widely believed that solar and conservation alternatives to fossil fuels are job creating, and thus, the possible effects of energy policies on employment are of primary concern to Congressional staffs. As discussed below, this question was reformulated.

#### Methodology

The methodology, developed to analyze the effect of alternative energy policies and technologies on the U.S. energy and economic systems, involves the integration of three different models (Groncki and Marcuse, 1979). A macroeconomic growth and interindustry model (econometric in nature) is used to estimate the aggregate energy/economy interactions and the long-run path of the economy (Jorgenson and Hudson, 1974). A linear programming process model is used to estimate the least cost method of meeting specified energy service demands and captures the substitution possibilities within the energy system (Kydes and Rabinowitz, 1979). A disaggregate input-output model is used to assess the impacts of the aggregate energy/economy interactions on detailed industrial sectors (Tessmer et al., 1975; Fraser, 1978).

#### Formulation of the Issue

The original request was to examine the employment-generating effects of the DPR "maximum practical" solar implementation. The DPR scenario depicts the penetration of solar technologies over the next twenty-five years so that the impact on the labor force occurs gradually during that period. Since the forces affecting the economy-wide demand and supply of labor far exceed the impact of a gradual substitution of solar for conventional energy technologies, it is obvious that the direct and indirect impacts of the DPR scenario might be to change the occupational structure, the skill mix, and, to a small degree, the productivity of the labor force. The level of employment will be a function of the supply and demand for labor and a market-clearing wage rate. This does not mean that substantial unemployment may not exist at any given moment during the period caused by either a non-market clearing wage rate that is slow to respond to the excess supply or a pool of functional unemployables (structurally unemployed). Government policies designed to offset these types of unemployment must meet three tests: the expenditure stream must be timed such that it has a large and quick impact, the occupational mix of those to be employed should conform to the mix of currently unemployed and the policy alternative must prove preferable to other short-run employment generating programs. Since the DPR initiatives do not meet all three conditions, the question of their aggregate, economy-wide employment effects is not relevant.

Although the solar alternatives may generate an increase in demand for certain types of labor, the supply of this labor can only come from the labor pool available for all economic activity. Since a general equilibrium model incorporates labor supply as well as demand, wage rates will adjust to clear the market. Hence, no excess labor is available and the additional demand must be met by diverting labor from other activities, and thus changing the mix of occupational skills. Of course, if the DPR technologies increase labor productivity, wages will rise and additional labor will be forthcoming. If productivity is decreased, the reverse will happen. Only if long-run equilibrium is achieved with a chronic excess supply of labor will labor-absorbing technologies increase employment. However, under these circumstances policy makers could turn to any other labor-intensive activity to absorb the excess labor. Excess labor supply may also result from structural unemployment, but there is little reason to

believe that solar technologies will eliminate this pool more effectively than other measures aimed directly at the structural problem.

The sponsors were alerted to the fact that it is not meaningful to seek solutions to short-run problems through long-run policies nor to analyze short-run responses with long-run policy models. The sponsor accepted the suggestion that two important labor-related issues should be considered: (1) the changes that are likely to occur in the sectoral and occupational structures of employment resulting from the DPR scenario; (2) the change in labor productivity and consequently in real wages associated with the enhanced solar scenario.

#### CASE SPECIFICATION

The solar penetrations for the base case and the DPR "maximum practical" cases were given. The life-cycle costs for solar technologies, supplied by SERI, were higher than the lifecycle costs of conventional technologies, even with rising fuel prices. It was assumed that the introduction of the higher cost solar technologies would be encouraged by a government subsidy or that consumers might voluntarily decide to pay the higher costs. On the basis of these assumptions, two cases were analyzed: "subsidy" and "user pays." A third scenario was chosen which is characterized by decreasing costs of solar technologies to levels making them competitive with conventional technologies. This analysis case is labeled "competitive."

#### ECONOMIC IMPACTS

Table 1 presents the values for GNP and its components for the base case and for the three DPR "maximum practical" cases. It is clear that if the cost of solar technology does not exceed that of conventional energy sources, economic activity is not affected. On the other hand if solar energy is more expensive, future economic output and the rate of growth of the economy are reduced. Although this reduction seems small, the cumulative effect of even a small annual percentage change can become quite large over a period of decades.

##### Competitive Case

The competitive case shows no change from the base case in GNP or its components. This is expected if the resource costs of the competitive case are no greater than those in the base case. The calculated values, carried out to more than three significant figures, show a slight decline in GNP, almost all of it in consumption. This is consistent with the necessity to free up more output in the early years for capital which characterizes the case with more solar penetration. Thus the time phasing of capital expenditures in the base case compared to the competitive case leads to more investment for the competitive solar options in the first few decades and greater consumption later.

##### Subsidy Case

Both the absolute level of GNP and growth rate are lower in the subsidy case than in the base case because the solar technologies are less efficient per dollar cost in providing energy than the lower cost conventional alternatives. The required labor and capital inputs per unit of energy output are increased and this reduction in productivity is reflected throughout the economy in the form of lower wages, decreased returns to capital, and a fall in output. In the



TABLE 1 GNP and Economic Growth: Year 2000  
(1972 Billion)

	Base Case	Competitive Case	Subsidy Case	User Pays Case
Gross national product	2700*	2700*	2650	2630
Consumption	1740*	1740*	1700	1680
Investment	390*	390*	380*	380*
Government	570	570	570	570
Net Exports	**	**	**	**
Average annual growth of GNP 1977-2000(%)	3.11	3.11	3.04	2.99

\*The solution values of these quantities differed in the detailed computer output for quantities of less than ten billion dollars if not rounded.

\*\*Less than five billion dollars.

Source: Model runs.

Totals may not add because of rounding.

subsidy case, the consumers are reimbursed for their additional energy costs and use this income for nonenergy products. This results in checking some of the GNP decline and in generating some additional energy demands to produce the additional nonenergy products.

#### User Pays Case

Like the subsidy case, both GNP and its growth rate decrease relative to the base case, because there is no income supplement to offset the higher energy costs, the absolute level and the growth rate of GNP are smaller than in the subsidy case. Most of the decrease occurs in consumption since the additional expenditures for energy must come largely from consumer expenditures.

#### PRIMARY ENERGY CONSUMPTION

Although the economic impact of the high cost solar technology scenarios is small (but significant), the impact on energy consumption is much more striking. Table 2 shows a considerable drop in primary energy use for all three "maximum practical" penetration cases. The differences in energy use among the three cases reflect the differences in economic activity. The solar penetration levels and the electric generation by oil, gas, and nuclear are fixed. Domestic production of oil and gas are upper bounded. This leads to the increased solar implementation of the "maximum practical" case displacing some combination of imports and coal. The pattern of displacement differs between the competitive case and the two noncompetitive cases. In the competitive case the level of economic activity is unchanged from the base case. The solar contribution largely displaces electricity which is largely produced from coal. Thus the competitive solar case shows little decrease in oil imports but a substantial decrease in coal requirements. For the subsidy and user pays cases, the displacement of conventional sources by higher cost solar results in a decrease in the rate of growth and absolute level of GNP. The level of real wages is lower and the derived demand for fuel to provide the lower level of energy services is reduced. This effect, unlike that of the solar substitution in the competitive case, generates a substantial decrease in imported oil requirements. As in the competitive case, there is a marked decrease in coal consumption as conventional electricity is displaced by the solar alternatives.

TABLE 2 Primary Energy Consumption: Year 2000  
(Quadrillion Btu)

	Base Case	Competitive Case	Subsidy Case	User Pays Case
Domestic oil	19.4	19.4	19.4	19.4
Imported oil	16.9	15.8	12.0	10.0
Domestic gas	16.5	16.5	16.5	16.5
Imported gas	0.0	0.0	0.3	0.3
Biomass	0.4	0.8	0.8	0.8
Coal	25.5	14.1	16.7	16.0
Solid waste	0.3	0.9	0.9	0.8
Wood	2.5	2.9	2.9	2.9
Nuclear	24.3	24.3	24.3	24.3
Other nonfossil electric	8.5	11.2	11.2	11.2
Nonfossil direct	3.0	5.8	5.8	5.8
Total primary energy	117.3	111.7	110.8	108.0
Energy-GNP ratio (10 <sup>3</sup> Btu/1972\$)	43.5	41.5	41.8	41.2
Imports share of total primary energy (%)	14.4	14.2	11.1	9.5

Source: Model runs.  
Totals may not add due to rounding.

The energy GNP ratio is often used to describe energy efficiency. All three "maximum practical" cases show marked improvement in this measure, partially due to the displacement of electricity by solar since the conversion losses associated with conventional electricity generation are greater than those of the solar replacements, and also to factor substitution away from higher priced energy in the subsidy and user pays cases. The small differences between these cases are probably not significant.

#### EMPLOYMENT AND PRODUCTIVITY

##### Aggregate Employment Effects

Employment levels are virtually unchanged between scenarios. The lower real wage rates associated with the higher cost scenarios result in a decrease in the available labor at the equilibrium wage rate.\* As shown in Table 3, the indicated decrease in the number of jobs is very small and occurs in response to the lower labor productivity under the long-run assumption that the labor market is cleared.

##### Productivity Effects

The chief mechanism affecting model outcomes is the endogenous capture of factor substitutions in response to relative factor prices. The values of the coefficients for the year 2000 are shown in Table 3. Perhaps the most significant

\* This results from the supply curve for labor incorporated in the DJA model. If the long-run supply curve was backward bending, available labor might increase with lower real wages.

TABLE 3 Employment and Productivity: Year 2000

	Base Case	Competitive Case	Subsidy Case	User Pays Case
Employment (millions)	122.5	122.5	122.3	121.8
Unemployment rate (%)	4.8	4.8	4.8	4.8
Gross labor productivity (Real GNP/employment) $\$10^3/\text{MY}$	22.0	22.0	21.7	21.6
Year 2000 input-output coefficient for:				
Capital	.1983	.1991	.2033	.2033
Labor	.1860	.1862	.1850	.1851
Energy	.0280	.0276	.0281	.0275
Materials	.5877	.5877	.5836	.5840

Source: Model runs.

change is the increase in the capital coefficient for the high cost solar cases. This more capital-intensive system generates a lower not a higher income because the energy capital requirements per unit of energy services are higher. Historically, capital has been directed toward developing substitutes for labor and increasing labor productivity. The model indicates that in an era characterized by increasing resource cost, capital investment may be directed more to increasing resource productivity and less to improving labor productivity. The input-output coefficients change markedly between 1985 and 2000. The base case capital coefficient increases by 13.3%; labor and energy coefficients decline by 12.4 and 13.9% respectively; the materials coefficient remains relatively constant showing a 1.3% increase. The difference in the temporal changes between scenarios is very small. It is clear that the model implies a much more capital-intensive economy with sharply decreased labor and energy requirements per unit of output for the year 2000.

#### Disaggregated Employment Effects

The BNL input-output/linear programming model contains 110 sectors. The labor coefficients for these sectors have been projected to the year 2000. The convergent energy/economy solution provides activity levels for each sector. The level of sectoral employment is estimated by the product of these activity levels and the projected labor coefficients. Sectoral occupational-mix coefficients are then applied to the employment projections for each sector, and the change in occupational mix is calculated. These coefficients, supplied by Lawrence Berkeley Laboratory, describe the 1972 occupational skill mix. When they are applied to the 2000 activity level the employment for each skill is generated. The employment mix is based on the working assumption that the skill mix in each sector will not change between 1972 and 2000. The change in skill mix over the whole economy is the result of the change in the structure of employment across industries and not of changes of skill mixes within industries. The results should be viewed with these caveats in mind. The employment response to the DPR cases for sixteen selected sectors is shown in Table 4. Employment changes in the energy sectors reflect the shift away from coal and oil showing substantial decreases in coal employment relative to the base case. Since the coal industry grows, even in the subsidy and user pays cases, there is a lower rate of growth in employment rather than a decline, and thus less economic dislocation than would result from absolute decreases in coal production. Substantial percentage increases in employment occur in the synthetic gas and combined-cycle electric sectors reflecting the large increases in output over very small bases. The employment gains in the hydroelectric sector result from

TABLE 4 Sectoral Employment Changes: Year 2000

Sector	Base Case Employment (1,000's)	Maximum Practical Cases, % Changes		
		Competitive	Subsidy	User Pays
<b>Energy</b>				
Coal	1370	- 25.7	- 18.0	- 19.1
Refined oil products	280	- 1.5	- 11.7	- 15.9
Methane (coal & biomass)	5	127.2	126.0	130.0
Combined cycle electric (coal and wood)	20	158.3	157.9	161.5
Hydroelectric	60	21.6	21.4	23.0
<b>Nonenergy-solar related</b>				
New construction-residential	1330	- 8.1	- 10.4	- 10.0
Main. & repair construction- residential	1090	11.6	12.0	11.7
Plastic & synthetic materials	300	22.1	20.4	19.7
Glass and glass products	190	49.5	48.2	48.5
Forestry and fishery products	110	16.6	10.6	6.2
<b>Nonenergy-conv. fuel related</b>				
New construction-non- residential	1950	- 19.9	- 21.9	- 21.6
Engines and turbines	200	- 8.7	- 10.0	- 10.6
New construction-public utility	100	- 6.9	- 7.3	- 6.7
<b>Nonenergy-energy related</b>				
Farm machinery	120	- 13.4	- 16.7	- 17.3
Wholesale and retail grade	26400	1.1	1.3	0.8
Office computing and acct. machine	390	- 10.7	- 12.7	- 13.1

Source: Model runs.

the penetration of low-head hydro which does not appear in the base case. The solar-related energy sectors show decreases in residential construction employment. The SERI data included much of the installation labor in the solar component sectors. The surprising decrease in labor requirements in residential new construction reflects this accounting convention. The increase in labor requirements in the maintenance and repair construction sector more than offsets the decline in residential construction. The plastics and synthetic materials, glass and glass products, and forestry and fisheries sectors all show substantial increases based on increased "maximum practical" scenario demands for plastics, glass, and wood.

The employment impact on nonenergy conventional fuel-related activities is quite large. The decrease in nonresidential construction results in part from the lower GNP growth rate and the associated decreased level of capital formation and in part from the decrease in new construction of facilities (e.g., refineries). The relative decline in employment in the public utility construction and the engines and turbines sectors derives from the decreased construction of electric generating stations. Export industries are affected by the decrease in exports resulting from the decreased need to earn foreign exchange to finance oil imports. The effect of reducing traditional U.S. capital goods exports is illustrated by the engine and turbine sector as well as the office, computing, and accounting machine sector. The farm machinery sector is affected not only by the fall in the need to export but indirectly by the decrease in agricultural exports. By and large, the capital goods sectors all show decreases in employment. The effect on the wholesale and retail trade sector is characteristic

of the service, communication, and transportation sectors. These all show small but positive increases. The introduction of the solar technologies directly reduces the output of the conventional energy sectors, particularly electricity, and indirectly reduces the output of the manufacturing sectors supporting them. Through the reduction in exports the input requirements of the export-producing manufacturing sectors are also reduced. The released resources are partly absorbed by the solar technology industries and the remainder by the service industry sectors.

This shift in economic activity toward the service industries explains the effect of the "maximum practical" cases on the occupational skill mix, as shown in Table 5. The net changes are very small and result in releasing unskilled, semiskilled, and skilled labor as well as foremen from the manufacturing sectors and in increasing professional, management, clerical, and sales employment in the service sectors. Table 6 reflects the same shifts with decreased employment in the energy, manufacturing, and construction industries arising from the shift away from manufacturing for export and the decrease in electric utility, refinery, and coal mining activities which affect construction as well as equipment. The released labor services are absorbed by the service, trade, finance, communication, transportation, and agriculture sectors. The solar data from SERI that allocated much of the solar construction to the solar supply sectors reinforces the construction employment loss due to the decrease in utility and manufacturing activity.

#### CONCLUSION

This paper discusses a study in the context of the real life constraints under which policy analysts operate. The results are significant in that they are counter to the conventional wisdom that solar technologies create employment and shift the occupational mix toward blue collar jobs. They also indicate that increased capital intensity in the future may not lead to increased labor productivity. The results imply that the differences in the time paths of capital expenditure between solar and conventional energy technologies, even if they are equal in cost, are an area for worthwhile research. The assumption used in this study was that life-cycle costs are equal. The case of equal capital costs has not yet been investigated.

These findings are unusual. They are heavily dependent on two characteristics of the modeling structure. First, the international trade balance mechanism assumes that exports fall in response to lower fuel imports and that these exports have the same sectoral composition in 2000 as in the recent past. Second, the econometric formulations reflect the increasing fraction of output arising from tertiary industries that has been true historically and assumes that this trend continues through 2000.

TABLE 5 Comparison of the Occupational Structure of  
Total Industrial Employment - Year 2000 Cases

Occupational Class	Base,%	Maximum Practical, %		
		Competitive	Subsidy	User Pays
Engineers & scientists	1.82	1.81	1.81	1.82
Other professionals	9.77	9.85	9.86	9.86
Management, clerical, sale	37.95	38.33	38.33	38.32
Foreman	1.88	1.85	1.85	1.85
Skilled labor	12.63	12.18	12.29	12.33
Semiskilled labor	28.95	28.94	28.94	28.91
Laborers	6.99	6.94	6.92	6.91
Totals	100.00	100.00	100.00	100.00

Source: Model runs.

TABLE 6 Comparison of the Industrial Structure of  
Total Industrial Employment - Year 2000 Cases

Industry	Base,%	Maximum Practical, %		
		Competitive	Subsidy	User pays
Energy	4.39	4.02	4.14	4.16
Agriculture	2.20	2.23	2.22	2.20
Nonfuel mining	0.35	0.37	0.36	0.36
Construction	7.10	6.60	6.60	6.66
Manufacturing	22.58	22.52	22.37	22.32
Transportation	2.28	2.32	2.30	2.29
Communications	1.08	1.09	1.09	1.09
Trade	25.74	26.10	26.11	26.12
Finance, insurance + real estate	6.49	6.71	6.71	6.71
Services	27.78	28.05	28.10	28.07
Total	100.00	100.00	100.00	100.00

Source: Model runs.

REFERENCES

- Fraser, J. T. (1978). Documentation of the Brookhaven Energy I/O and I-O BESOM Linkage. Brookhaven National Laboratory, Upton, New York. BNL 50856.
- Groncki, P. J. and W. Marcuse (1979). The Brookhaven Energy/Economy Modeling System and its Use in Conservation Policy Analysis. Brookhaven National Laboratory, Upton, New York. BNL 51056.
- Jorgenson, D. W. and E. A. Hudson (1974). U.S. energy policy and economic growth. Bell J. Econ. Manage. Sci., Vol. 5, No. 2, pp. 461-514.
- Kydes, A. S., and J. Rabinowitz (1979). The Time-stepped Energy System Optimization Model: (TESOM) Overview and Special Features. Brookhaven National Laboratory, Upton, New York. BNL 26456.
- Marcuse, W., and P. J. Groncki. (1979). Macroeconomic Effects of Accelerated Implementation of Renewable Energy Technologies in the U.S. Brookhaven National Laboratory, Upton, New York. BNL 51092.
- Tessmer, R. G., K. C. Hoffman, W. Marcuse, and D. J. Behling (1975). Coupled Energy System-Economic Models and Strategic Planning. Brookhaven National Laboratory, Upton, New York. BNL 20120.

# INTEGRATED SET OF MODELS OF THE ELECTRIC POWER SYSTEM DEVELOPMENT— STRUCTURE AND APPLICATION

**I. Lencz**

*Power Research Institute, Brno, Czechoslovakia*

## ABSTRACT

The study describes the internal structure of an integrated set of models oriented to the problems of the development of the electric power system and of the centralized heat supply systems. It also characterizes some procedures for investigation of the influence of the uncertainty of the prognostic information.

## KEY WORDS

Integrated set of models; data base; electric power system development; centralized heat supply systems; uncertainty of prognostic information.

## BASIC CONCEPTS

We have already dealt with the solution of an integrated set of models (further denoted "System") to be applied in the field of the electric power system (Lencz, 1974). In this study we describe a solution with a strikingly broader effect, which involves, together with the electric power systems, also systems for centralized heat supply and respects their relations to overall energy system and the system of the national economy. Water is also involved in these considerations in view of its significant functions, among others, as a source of primary energy, a means of energy accumulation and a cooling medium.

The System is provided with a data base, which includes selected information taken from the statistics of the national economy, of

the overall energy system and of the electric power system, as well as the so-called primary and secondary prognostic information generated by the components of the System. The system includes special mathematical tools for operating with time series and a set of mathematical models.

The System as a whole is a means of solving a single complex problem, i.e. the rational development of the electric power system and of centralized heat supply systems in relation to the development of the overall energy system and of the national economy. The components of the System may be used for solving numerous partial problems.

The construction of the data base of the System exploits the usual principles of a multi-level grouping of information on the following levels: information word, information record, information file, combined file. Information files and combined files are denoted by symbolic names and by names chosen by the user, under which the information is accessible both for models and for their users.

#### THE PROBLEM

In Czechoslovakia, as in many other countries, we aim at securing a reliable, high-quality and economically profitable supply to consumers of electricity and of low-potential supply heat. The economy of the solution is a very wide term involving the economy of development and operation, economic utilization of primary resources and satisfying the reasonable energy demands of the society.

A specific feature of the task consists in its unique time dimension, embracing tens of years and being complicated by the fact that, from certain points of view, the electric power systems should be modelled hour by hour in some sections of time.

The time dimension of the problem is defined by time sets TP and T, where TP defines the past and T the future of the represented complex. Both time sets are alternatively discretized with the step of 1 year, 1 week or 1 hour depending on the character of the part problem.

The past of the represented complex is described in the time set TP based on statistical data a narrower selection of which is presented in Table 1.



TABLE 1 Some Combined Files of the Statistical Section of the Data Base

Title of file	Symbolic name	Content
National economy	NOO	Time series describing the development of production activity of demographic and climatic factors
Overall energy system	POO	Time series describing the fuel supply, the consumption of heat, etc.
Electric power system	SOO	Development of the global and sectorial electricity consumption, power and generation balances, etc.

Prognoses of the Consumption of Electricity and Heat

The first and from a certain point of view the most difficult part of the problem under solution is the task of forecasting using the information from statistics NOO, POO, SOO defined in the time set TP - the future development of electricity and heat consumption including the respective load curves, i.e. of determining in the time set T, the corresponding elements of sets SOO, POO, and on the basis of the latter the sets ZOO and TOO (cf. Table 2).

For solving the related problem the System is equipped with special mathematical tools for regression and correlation analysis of time series, for investigating their trend, seasonal, cyclic, auto-correlational and random components and for alternative projections of individual processes. A survey of the utilized procedures and methods was described in (Lencz, 1977). The results of the forecast belongs to the basic files of the primary prognostic information.

Principles of Modelling the Power Plants

The global approach applied in relation to the national economy and to electricity and heat consumption is insufficient in the case of the generating basis of these subsystems. Their representation is based upon the description of existing and hypothetical power facilities regarded as elements of the power system.

The set of power plants E is described by the Cartesian product

of sets  $E_i$ , where  $E_i$  is the description of the  $i$ th power plant

$$E = \times E_i \quad (i = 1, 2, \dots, n)$$

Let us illustrate the approach by describing the fossil fuel power plants, which can be characterized on the level of separate generating blocks  $B_{i,j}$  with a common fuel store  $A_i$ , i.e. by means of the Cartesian product

$$E_i = \times B_{i,j} \times A_i \quad (j = 1, 2, \dots, m)$$

The alphabet of possible internal states of a block can be described using the Cartesian product

$$B_{i,j} = R_{i,j} \times BD_{i,j} \times C_{i,j} \times P_{i,j} \times Q_{i,j}$$

where the vector of bivalent variables  $R_{i,j}$  describes the state of the realization of the block, the set  $BD_{i,j}$  contains subsets of descriptive, electric, reliability, fuel consumption, economic and ecologic parameters. The vector of bivalent variables  $C_{i,j}$  characterizes the availability of the block, the set  $P_{i,j}$  includes possible loading values of it.

TABLE 2 Some Files of Primary Prognostic Information

Title of file	Symbolic name	Content
Power plants	EOO	Descriptive, electric, reliability, consumptional, economic and ecologic parameters of power facilities
Electric load curves	ZOO	Trend, seasonal and cyclic components of load curves
Thermal load curves	TOO	Components of load curves of the sectors of thermal consumption

Information obtaining the actual state of the parameters of the blocks (of the sets  $BD_{i,j}$ ) is stored in the information file Ell. Analogously the combined file EOO holds parameters of the whole group of power plants. The combined file EOO is also an essential part of primary prognostic information for starting a model solution.

The behaviour of individual generating blocks realized in the elec-

tric power system or in the systems of centralized heat supply is conditioned by continuous variations of the internal state (within the framework of sets  $C_{i,j}$ ,  $P_{i,j}$ ,  $Q_{i,j}$ ) due to

- faults influencing the system given by the set  $G_i$ ,
- commands to start or shut down the generating block given by the set  $S_i$ ,
- values of the demanded load given by the set  $P_i$ ,
- supplies of fuel into power plant  $F_i$ .

The set of input values affecting the power plant is characterized by the Cartesian product

$$X_i = P_i \times S_i \times G_i \times F_i$$

and the set of input functions is a subset of the Cartesian product defined in the time set  $T$

$$U_i \subset T \times X_i$$

These influences cause changes in the internal state and the output function of the block. The appropriate information is concentrated in the third section of the data base (see further).

#### MODELS

The set of models affiliated to the data base decomposes the development problem from the point of view of the modelled complex, further from the point of view of the phenomena under study and, last but not least, from the point of view of the chosen section of time. The set of models includes:

- a) a simulation model of the heating power plants for combined generation of electricity and heat, burning fossil as well as nuclear fuel. It determines, inter alia, the electric power outputs from these sources which are forced into the electric power system (secondary information sets  $V10 \times V20 \times V30$  - Table 3),
- b) procedure for synthesizing the dynamized variants of the development of power plants within the framework of the set  $XR_{i,j}$ . It determines the secondary file ROO based, inter alia, on reliability and system structure criteria,
- c) model of the calculation of electric power system reliability, including maintenance scheduling; the respective information becomes a content of file MOO,

- d) model of daily and annual operating régimes of power plants which, based on the information included, inter alia, in sets ROO, MOO, optimates unit commitment and the load dispatching and determines subsets of the Cartesian product  $TxP_{i,j}$ ,
- e) balance model of nodal balances of the transmission network,
- f) model of the operation and of the development of transmission net work,
- g) balance model of the economic evaluation of the development.

TABLE 3 Some Files of the Secondary Prognostic Information

Title of file	Symbolic name	Content
Electric power outputs of heating power plants	V10, V20, V30	Trend, seasonal and cyclic component of the electric power outputs of public and industrial heating power plants
Development programs of the generating capacities	ROO	Dates of the commissioning and putting out of service of power facilities
Schedules of maintenance	MOO	Schemes of the planned maintenance of power facilities

A special position within the set of models is occupied by a global linearized model of the electric power system as a whole, which serves to optimize the internal structure of the modelled system. It comprises the procedure for elaborating a matrix model from the data base and the procedure of linear programming for its optimization. It serves for global considerations, includes procedures for a profound aggregation of information and its results can serve for the procedure ad b).

In order to solve certain typical problems we have elaborated appropriate sequences for the application of different models. Their user chooses the information out of the data base according to the symbolic names of the sets and their code notation and chooses the procedure parameters. Having solved the part problem he can store the secondary prognostic information in the data base and choose a further procedure of the solution.

INVESTIGATION OF THE INFLUENCE OF UNCERTAINTY  
OF THE PROGNOSTIC INFORMATION

The prognostic information is loaded with a high degree of uncertainty which brings about technical and economic risks in the decision making. The described integrated set of models is, inter alia, an appropriate means of investigation of this influence. The respective procedure was characterized in the Appendix to the paper (Lencz, 1977).

For example, when prognosing the electricity consumption, there does not originate only one particular prognosis of the development assumption, but a wider zone of possible paths. Let us assume that - by means of an expert evaluation of this zone and excluding apparent unacceptable forecasts - we obtain the limiting cases and the mean value of prognoses represented by information files SOO-MIN, SOC-MEAN, SOO-MAX. By means of synthesizing the respective variants we determine the rational development schemes represented by files ROO-MIN, ROO-MEAN and ROO-MAX, which we consider to be the basis for possible decisions. The correlation between conditions and decisions is seen in Fig. 1.

The risk to the decision-making results from the fact that within the interval  $t$  the development conditions are not going to deve-

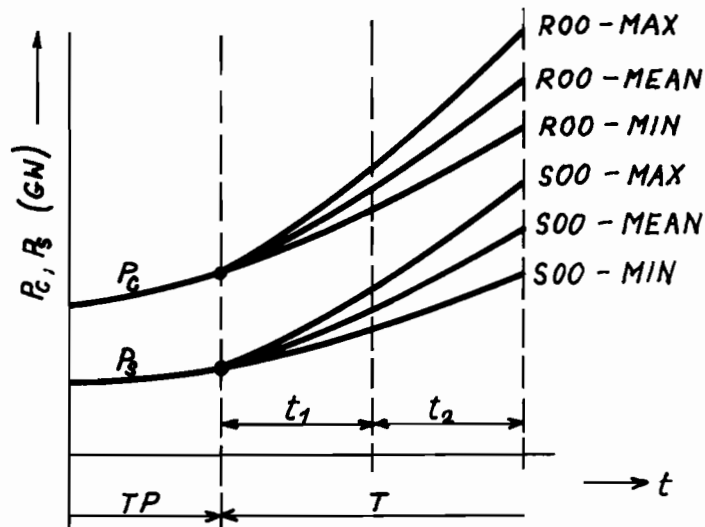

Fig. 1 Relation between installed capacity ( $P_C$ ) and load ( $P_S$ )

lop themselves in compliance with the accepted decision and further corrections of the development trajectory are possible only after a certain observation period  $t_1$  (3-4 years) has elapsed. The risk is greatest in the period  $t_2$  (3-4 years) when the effect of the decision manifests itself, and follows from the considerable time of preparation and realization of modern large power facilities.

The risk of decision-making is given, on the one hand, by the insufficient reliability of the electric power system and by the large amount of undelivered energy or by the cost of its elimination and, on the other hand, by a low utilization of capital investments. Let us mention that - even supposing relatively small differences in annual increments of the consumption between mean, maximum and minimum variants (+1, -0,5 %) - in the period of the future 5-8 years the risks are considerable and with an extreme discrepancy the system operation without additional corrections is practically impossible.

Another uncertain factor - the time taken to put large power facilities (e.g. nuclear power stations) on line may be studied analogously.

By means of the System or its models other uncertain factors can be and have been examined, as, e.g. the influence of the shape of the load curve, of the reliability of prospective nuclear plants, of economic parameters, etc. The majority of these factors have their specific effect, e.g., upon the choice of the internal structure of the system, upon the dimensioning of the power reserve, etc. The structure of the System enables one to choose for each specific case an adequate set of tools.

#### REFERENCES

- Lencz, I., (1974): New ways and new possibilities of modelling the electric power system development.  
Proc. of IIASA Working seminar, Laxenburg.
- Lencz, I., (1977): Prognoses of the consumption of energy: The Czechoslovakian experience.  
In W.Nordhaus (Ed.), International Studies of the Demand for Energy, North-Holland, Amsterdam.

# ENERGY MODELLING: THE ECONOMIST'S APPROACH

**G. J. Kouris**

*IEA-OECD, Paris*

## ABSTRACT

The analysis in this paper deals both with the theoretical and the empirical aspects of energy modelling. As the construction of an energy model is still in the making only a sample of empirical results is quoted.

## INTRODUCTION

As interest on energy matters mounts the development of models as well as the number of scientists which are diverted to the subject, increase exponentially. Energy modelling can be approached from either the supply side or the demand side. In retrospect it seems that the emphasis has tilted from supply to demand and hopefully somewhere in the middle now. No doubt the ultimate resolution lies in the point where the demand curve meets the supply curve. Still it is crucial to lay down our priorities right from the beginning. The supply of fuels is planned on the anticipation of likely demands and acts, in the short and medium term, as a constraint that activates price changes in order to clear market imbalances. In the longer term, unless the signals from the market are interpreted clearly overcapacity might be the result, which means that we have been wasting scarce resources. It follows then that the endeavour to balance desired supply and demand should start by an assessment of the likely demands for future fuel sources.

## ENERGY AND THE MACRO-ECONOMY

The traditional macro-economic analysis has become in the post-1973 era more and more energy conscious. The usual "macro-parts" of the real, monetary and labour markets must now be supplemented with a fourth one, the energy market. Energy and oil have by now gained a legitimate place in macro-economic planning and forecasting. Hence the view in this paper is that the energy market forms part of a general macro-economic equilibrium solution.

A typical macro model would yield estimates for GDP, aggregate consumption expenditure and industrial output. These three variables are the basic activity indicators that are needed to "drive" a three-sector energy market. Industrial output represents the income effect for energy consumed in industry, while aggregate consumption expenditure will likewise be the income effect for energy consumption in the domestic sector. In the transportation sector, since a portion of energy is used for residential usage and

the rest is used for commercial or industrial usages, a dual income effect is needed. Thus both the industrial output and consumers' expenditures could be used.

There is also an autonomous conservation element which stems from the progress in technology and has been re-enforced from the 1973-74 energy crisis. Autonomous conservation is directly linked to the performance of the economy, and should not grow smoothly overtime. Instead it should be a function of the economic cycle. Thus prolonged periods of stagnation would exert a negative pressure on the ability to save energy.

The area of interest to many economists nowadays is on the feedback effects from the energy market to the macro-economy. Even more crucial is the impact on economic activity of an increase in the price of oil. The initial effect of such an increase is felt in the economy directly from the price of oil to the level of domestic prices. There is a secondary effect, however, which stems from the fact that the rest of the fuel prices rise in "sympathy" to the initial rise in the price of oil. Since oil is the marginal fuel in the energy market it assumes a leading role in determining the prices of the rest of the fuels. Thus a given percentage increase in the price of oil has a present and lagged impact on energy prices that extends to a few years.

Another linkage between the energy market and the macro economy, which operates through the supply side of the system, is fuel availability. Any production function in the macro-model should allow for the by now all important factor, energy. Capital, labour and energy become the basic inputs in the production process that define the potential output of the economy. When the supply of energy and oil is limited or equivalently, if people anticipate that energy or oil is in limited supply, then the potential output of the economy is restricted. It is especially this last factor that would explain, at least in part, the sluggish economic growth in the OECD are in the period since 1974. The difference between potential and actual GDP, being a measure of the "overheating" of the economy should be included in the inflation equation.

An increase in the price of oil, however, at the Arabian Gulf is an increase for all rather than any one country in isolation. Thus, although there is recycling of money from the producers to the consumers of oil, world trade incurs a setback and export volumes of every single country decrease. In order to measure this international trade multiplier effect simulations with linked models of the major world economies are needed.

Another effect which is easy to describe but very difficult to quantify is the impact on investments of frustrated expectations which spring from turmoils in the oil market. Oil is probably the world's most important traded commodity; and as such it is bound to affect expectations of governments, firms and households alike. Since expectations are in turn important in planning investment expenditures and durable good purchases, their impact on investment activities could be quite significant. Measuring, however, expectations has always been a hurdle in econometric modelling.

The following flow chart describes how the various linkages between the energy market and the overall economy fit together.



Linkages Between the Macro-economy and the Energy Market

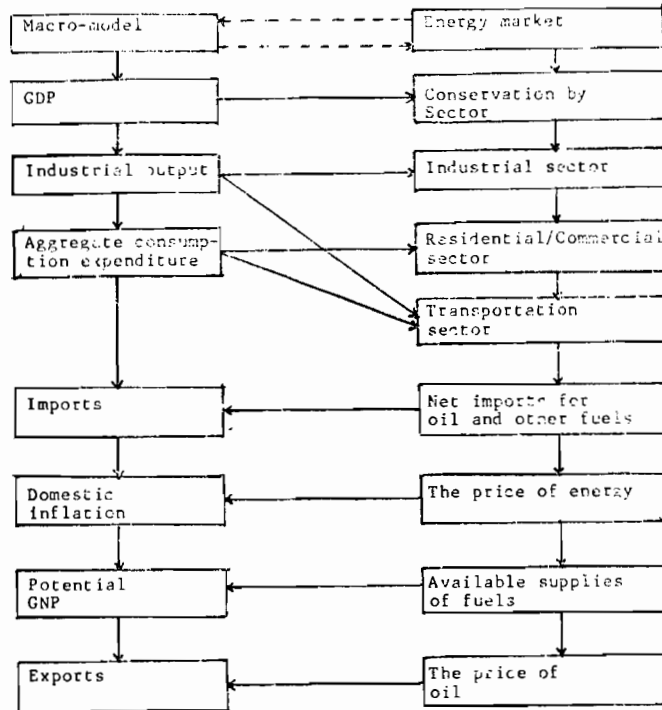

### THE BASIC RELATIONSHIPS IN THE ENERGY MARKET

The analysis of energy demand is more appropriately done at the final consumption level. Any attempt to forecast energy on a primary input basis disregards reality where ordinary decisions about how much energy to consume and which fuel type to use are based on final or end-use energy. In this context it is firstly important to identify the different types of behaviour that exist in the industrial, residential/commercial and transportation sectors. Once we have established the level of final energy consumption in these basic sectors it is not difficult to arrive at the primary energy level through a set of technological relationships.

The two main market forces influencing final energy demand are income and price changes, each one having a different time profile. Income is primarily a short run phenomenon while price is assumed to encompass both a short and a long term reaction. Energy demand, being essentially a derived demand, in the short term responds directly to an income variable. In the industrial sector, for example, although firms plan their production for the short and long run on expectations about future output levels, energy consumption (like other production inputs) will depend on the production level that will actually be demanded at each time period. In the short

term - when the technology and substitution between the factors of production remains constant - demand will vary with output levels and possibly efficiencies associated with the utilization rate of capacity. In the longer term, energy prices relative to prices of other factors of production will further influence industrial energy demand; this effect is assumed to be captured by the change in the "real" price of energy.

The reasoning is similar for the transportation and residential/commercial sectors of the economy. Since energy demand derives from the demand for services that the various durable goods yield, any level of consumption expenditure will be associated with a given rate of energy consumption. Here again there is a proportionality between the activity indicator, consumption expenditure, and energy consumption. Although the purchases of durable goods may depend on both present and expected incomes, the actual utilisation of such durable commodities - and hence energy consumption - will depend on consumer expenditure at each time period. Thus the income effect of energy demand on transportation and the residential/commercial sectors can be viewed again as a short term phenomenon.

Fuel price changes by producing short and long term reactions have implications on both energy consumption and interfuel substitution. When the price of energy increases, consumers will in the short term try to cut consumption but they will, in general, keep their existing capital equipment or durables stock. In the longer term, conservation can be achieved by switching to more efficient equipment, retrofitting houses, reorganising the production process, etc.

The long term response of energy consumption to price changes has a different time response in every sector. In industry long term conservation, which reflects the life of capital stock and the ability to invest in more efficient process, should be achieved a lot faster than in the household, where appliances once bought stay for years. In the transportation sector the existence of a long term reaction is not clear. A short term reaction of course does exist but motorists tend to go back to old habits quite soon.

In order to arrive from final energy demand to the primary energy level, an efficiency factor for the conventional thermal power stations should be assessed. The same factor, of course, would be used to measure output from nuclear and hydro stations into equivalent primary terms. Energy consumption by the energy sector together with losses are essentially determined by final energy requirements and the state of technology. Simple functional relationships between the total requirements of various fuels and the actual consumption of these fuels (or losses), in the energy sector, can be computed. The resulting technical coefficients can be variable over the forecast horizon depending on the likely movements of technological progress. This can be performed judgementsally. Refinery fuel consumption can likewise be made a function of total demand for oil products. As regards manufactured gas, an efficiency factor - like in power generation - can be assessed and used for conversion to primary input units.

Thus, from the final energy consumption stage, through some essentially technical adjustments for electricity generation, energy consumption by the energy sector, losses, refinery consumption and manufactured gas, primary energy consumption can be ascertained.

### THE BALANCE OF DEMAND AND SUPPLY

The balance between supply and demand for energy can be carried out both at the national and the world level. In the past years, however, the practice in most countries has been to increase indigenous energy sources to a certain level and then meet excess demand by importing the rest of the energy needs primarily in the form of oil. This means that the most crucial balance is at the world rather than at the country level. 1979 has indeed been a testimony of how fragile the world system is to shortfalls in oil supply anywhere in the globe.

Thus, within every country the balance of supply and demand for every fuel will be important in determining prices at the final market. At a second stage inter-regional trade in coal and natural gas should be considered, while the worldwide exportable oil supplies should be treated as the residual fuel that tops up world energy needs. This is not the same as assuming that the supply of oil is unlimited. The assumption instead is that the price of crude oil will rise enough to keep demand within the confines of desired production.

The following flow chart illustrates the various inter-relationships in the energy market.

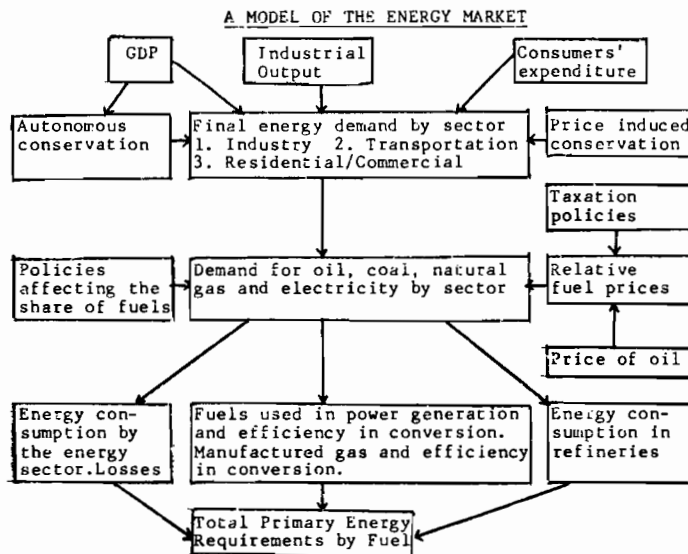

### SOME EMPIRICAL RESULTS

In the following chart an attempt is made to observe the effect of income and price changes on final energy consumption. The aggregate energy output ratio for seven major OECD countries has been computed from 1960 to 1978. By forming this ratio the assumption is, of course, that the income elasticity is unity which is somewhat restrictive. Nevertheless for visual purposes it is quite adequate because it can give us a fairly good idea of the reaction of energy consumption to income and price changes.

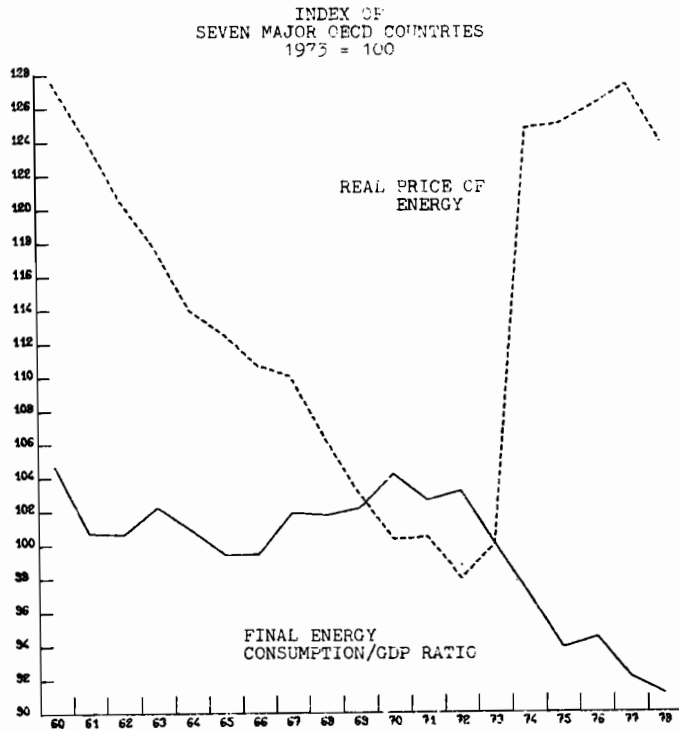

The energy price data consist of the weighted average of the energy component of the consumer price index and wholesale price index as well as the price of motor gasoline. Thus it represents the energy price level to final users. The two indices are negatively related especially in the period after 1965. This implies then that energy consumption does respond in the opposite direction to changes in fuel prices and a price elasticity must have been at work even before the energy crisis period.

INCOME AND PRICE ELASTICITIES

In line with our theoretical exposition on the income and price effect we have computed elasticities for a number of countries. The results concern final energy demand on GDP and energy prices.

For the seven major OECD countries the income elasticities and the short and long run price elasticities are as follows:

Estimation Period 1960-78  
Response of Final Energy Consumption to Income and Price

	Income Elasticity	S.R. Price Elasticity	L.R. Price Elasticity After 8 Years
U.S.	0.765	- 0.160	- 0.472
Japan	0.970	- 0.130	- 0.470
Germany	0.872	- 0.175	- 0.505
France	0.958	- 0.135	- 0.385
U.K.	0.425	- 0.180	- 0.250
Canada	0.957	- 0.145	- 0.405
Italy	1.055	- 0.110	- 0.342
TOTAL	0.831	- 0.155	- 0.445

Equation specification:

$$E_t = a + bY_t + c \sum_{i=0}^{\infty} \lambda^i P_{t-i} + u_t, \quad 0 < \lambda < 1$$

It must be emphasized that these elasticities have first been computed econometrically but subsequently have been modified according to judgment. Inter-country differences have been taken into consideration while the size of the elasticities has been constrained to values that yield a better fit for the post-energy crisis period.

As a test of the usefulness of these types of elasticities we have tried to compare actual consumption against predicted for the total seven OECD countries. Thus by inserting the actual income and price data(\*) we have predicted total final energy consumption (excluding non-energy uses of energy) for the period 1971 to 1978.

(\*) The actual equation used for predicting final energy demand for the aggregate of seven is :

$$E_t = 3.0035 + 0.8310 Y_t - 0.1550 P_t - 0.1031 P_{t-1} \\ - 0.0685 P_{t-2} - 0.0456 P_{t-3} - 0.0303 P_{t-4} \\ - 0.0202 P_{t-5} - 0.0134 P_{t-6} - 0.0089 P_{t-7}$$

All variables expressed in natural logarithms.

E = Total final consumption.

Y, P = GDP and the index of real energy price respectively.

Final Energy Consumption (in Mtoe) Aggregate Data for the Seven Major  
OECD Countries

	<u>Actual</u>	<u>Predicted</u>	<u>Error as % of Actual</u>
1971	2004.1	1990.5	- 0.7
1972	2127.8	2100.7	- 1.3
1973	2193.7	2210.7	1.0
1974	2127.0	2144.8	0.8
1975	2045.4	2086.4	2.0
1976	2170.7	2145.3	- 1.2
1977	2198.6	2187.2	- 0.5
1978	2261.0	2249.7	- 0.5

The good predictive ability of the equation suggests that market forces are quantifiable and as such they can be used for forecasting and energy policy making.

CONCLUDING REMARKS

The analysis so far was an effort to describe the specification of an energy model that simultaneously interacts with a macro-economic model. Or alternatively a macro-economic model that treats energy as one market within the rest of the markets in the economy. At the same time an effort was made to pinpoint the broad differences in behaviour among the energy sectors. Thus the aim has been to specify the boundaries where a modelling exercise can take place given the availability of data and the empirical evidence so far.

The strong tendency, or desire, to plan the demand and supply of energy, demonstrated by the interest shown by governments and other major economic organisations in intervening to control and contain market forces, necessitates the introduction of a number of exogenous elements in such a model. Autonomous conservation, government policies that induce fuel substitution, price controls, exogenous assumptions with regard to nuclear electricity, to name a few. However, the market mechanism should be allowed to play a significant role in a model because it is crucial to know the modification of these "planned" changes according to the direction of market forces. In this respect a simulation model, as the one here described, is particularly appropriate in testing the feasibility or consequences of such plans. The blend of the energy reality with the macro-economy is a modelling task of great importance and it merits more attention than what economists have devoted until now. The changes in the energy market - and the economy as a whole - that we have experienced since 1974, have revealed that mere extrapolation of past trends is an inadequate tool to capture the future or even plan the present. It is especially through the interplay of fuel prices that a model can capture the subtleties of the energy market. The various relationships in the model can be econometrically estimated wherever this is possible or meaningful. However, in many ways energy economics has undergone a qualitative change in recent years so that judgment is also essential to enhance the "realism" of any modelling exercise.

# POLICY APPLICATIONS OF THE EC MODELING PROGRAMME

**E. Fontela\* and R. Rubin\*\***

*\*Battelle Institute, Geneva, and University of Geneva, Switzerland*

*\*\*Expert, Commission of the European Countries, Brussels, Belgium*

## ABSTRACT

The EC energy modeling project includes several national and multinational models linked between themselves. They have econometrically estimated equations, input-output tables, simulation modules and a linear programming energy flow optimisation model. This system of models is built in a modular form and the users can easily work with each of its single components. Policy applications of the models are starting after a period of development and validation. The paper describes a set of possible partial or global applications of the models, at national or multinational levels.

## KEYWORDS

Energy; modeling; simulation; forecasting; policy; condensed forms.

## THE EC ENERGY MODELING PROGRAMME

The development of a comprehensive EC energy policy is still at a very early stage despite the fact that its usefulness has been often stressed in the recent years. Undoubtedly the development of such a policy encounters many obstacles and practical constraints. National characteristics of the energy systems of the EC countries dictate specific differences both in strategies and in policy decisions: these differences are particularly strong in the area of nuclear energy.

All member countries, however, feel the need for studies of the future in order to better assess the implications of alternative decisions; but there again methodological differences appear as the administrations of some countries favour normative approaches while others prefer exploratory approaches.

The Commission of the EC, conscious of these initial difficulties, started four years ago a relatively large programme of systems analysis applied to the energy sector, in the framework of the activities of the Research and Development Directorate.

Essentially the approach is modular, treating countries individually in order to progressively build a multinational system. It calls upon the modeling capabilities existing in the nine EC countries aiming at a harmonisation of modeling techniques in this area. The situation of this programme is described in a special issue of Energy Policy (Sept. 1979) to which most of the teams that are currently participating in the programme have contributed.

The set of models used includes:

- medium-term models (next ten years)
  - . macro-economic (EURECA)
  - . sectorial, input-output (EXPLOR)
  - . energy demand (EDM)
  - . flow optimisation (EFOM)
- long-term models (next thirty years)
  - . macro-economic (SLT)
  - . energy demand (EDM)
  - . flow optimisation (EFOM)

All these models have been developed and tested for each single EC country. At this national level they are all linked (the linkage between the medium-term models and the long-term models is made in the flow optimisation models that require specification of energy demands up to the year 2020).

As pointed out earlier, one of the objectives of this programme is to develop alternative multinational futures as opposed to the simple sum of national futures. The multinational approach has been chosen from the start at the macro-economic level; it is clear that the process of economic integration in the EC has been developing during the last two decades and that at present there is a considerable degree of interdependence that makes it imperative to treat explicitly in the model the inter-country economic relations. Thus EURECA is a multinational model with trade linkages and the longer term model national SLT models are driven by a supranational model SLT model with national disaggregation.

The complexity and high degree of uncertainty of multinational modeling at the sectorial and energy demand levels has led to a postponement to a later stage of the programme, of this type of linkages. The approach remains national but with due consideration in the trade vectors of possible future evolutions of the integration process, and adopting harmonious classifications allowing for intra-country comparisons.

Finally at the level of the energy flow optimisation it has been felt that, although the volume of intra-European energy trade is still relatively small it may well develop in the future as a result of European energy policies, and therefore together with the national EFOM models a multinational model has been developed (EFOM 12 C).

This later effort has had to face considerable difficulties as a result of the existence of substantial differences in data and statistical practices even in



relatively technical areas as those related to cost coefficients.

Although the process of validation of these models is not yet completed, by the end of 1979 all of them were technically operational and were ready for concrete applications. A small operational group in Brussels coordinates the national groups of implementers and performs multinational exercises: this group is working in relation with other EC Directorates (in particular the Directorates for Energy and for Economic Policy).

The national groups of implementers have strengthened their energy modeling capabilities during this programme and are working in close relation with the national agencies involved in energy policy making.

As a result of the work performed so far in this programme the energy modeling community has been consolidated in Europe and national studies are being increasingly made in a harmonised framework. This is perhaps an essential first step for further coordination of the energy policies of the European countries and for a future European energy policy.

#### CONSTRAINTS IN THE MODELING APPROACH

As already mentioned earlier, the EC system of energy models had to be modular in order to allow for both national and multinational applications.

It was also essential to build the system using the capabilities existing in Europe when the programme was started; this constraint implied that, at the national levels, the best modeling capabilities had to be identified and considerable effort had to be made in order to integrate them into a coherent framework. Rather than to start a new model system, the programme evolved towards the more complex and less rewarding process of linking existing models mainly through their exogenous variables.

In itself this process was enriching for all the teams as, since the beginning, it introduced as a major constraint for the model builders, a perfect transparency of their models: all teams of implementers had to be aware of both the possibilities and the limitations of each single model. Furthermore, from the software point of view, this initial methodological choice imposed a very high level of flexibility; each single model had to be treated in separate modules thus allowing later on for a possibility of using each model either separately or jointly (when calling upon the multiple linkage programmes).

The evident loss in mathematical elegance of the EC modeling system has therefore been overcompensated by the gains in transparency and flexibility, and last but not least, by the gain in time resulting of the acceleration of the implementation process.

#### THE EC ENERGY MODELING SYSTEM AND THE MODEL USER

Transparency of the models (of the structure of the relations, of the data used, of the values given to exogenous variables and parameters) and great flexibility are essential for the user. Besides these national assets of the modeling approaches adopted by the EC, a substantial effort is envisaged to improve the conversational

characteristics of the software and thus facilitate the technical relation between the user and the models.

The models included in the EC system are conceptually simple, but they call upon at least four types of modeling techniques: econometric, input-output linear programming and simulation. Many of the models are very large and disaggregated. It can hardly be said that the task of the user is easy; indeed those who fully grasp all the details of the structure are very few, even among the team of model builders. Thus the model user may be tempted to call upon the flexibility aspects of the system and to use only the part of it that he can easily understand; this is particularly the case for those familiar with linear programming methods or with input-output models. In doing so the user certainly will gain insight into his particular problem but he may lose other interesting aspects of it that could have been better illustrated by other parts of the system of models.

Conscious of this difficulty the EC team is planning to develop in the next stages of the programme "condensed forms" of the entire system. The condensed forms, or "models of the models", should in particular summarize the main reactions of the large model to changes in the world environment (e.g. changes in petroleum prices) or in specific national policies (e.g. nuclear investment programmes).

The development of condensed forms opens new areas of modeling of potential interest to the users such as optimal control, decentralised optimal control and gaming, a line of research which is also included in the second EC programme (1980-84).

#### THE EC ENERGY MODELING SYSTEM AND THE SOCIO-ECONOMIC ENVIRONMENT

The energy system cannot be treated in isolation and this is the reason that justified the inclusion in it of economic models (macro-economic and sectorial), both for the medium term and for the long term.

When using the models with the purpose of exploring the future, economic scenarios can be elaborated by giving specific values to the exogenous variables or to technical coefficients and parameters. For the medium term this procedure is considered to be valid owing to the inertia of the socio-economic structures. However, when looking into the longer term, major socio-economic changes may take place and a more careful and systematic analysis of the scenarios has to be made.

For the EC energy modeling system two procedures have been adopted for the long term: cross-impact analysis, as a way of computing probabilistic aggregated scenarios considering major future events and developments both in the EC and in the rest of the world and a hierarchic scenario technique with the demand model MEDEE. This latter technique forces the user to specify many detailed conditions of future situations, and thus allows for use of the models both in an exploratory and in a normative way (and in this way it answers one of the initial problems created by national differences in methodological approaches).

#### POLICY APPLICATIONS OF THE EC MODELING SYSTEM

With the characteristics described above, it is obvious that the EC modeling system is particularly useful for the simulation of both events and policy decisions and the assessment of their possible future impacts on a national and multinational level, in aggregate and sectorial terms.

During 1979 work has concentrated in the different countries on the drawing up of a central projection or reference scenario towards which all other simulations could be compared. Some first tests have been made of the impacts of events (mainly changes in petroleum prices) or policies (in GB, simulations have been made bringing the prices of gas and electricity to the same level with a thermal equivalent; in France, simulations have been made for energy saving measures). In each country the teams of implementers working together with national energy agencies are preparing new simulations of policies of potential interest for their countries in a common EC context and considering national constraints; these may include price controls, rationing, investment policies, subsidies of new energies among others are resulting in a constant energy demand forecast.

In so far as each of these teams is using a similar instrument, it will be possible from now on to compare country results and to develop a common European language.

For the central team, it will be possible to develop multinational solutions and to bring them into the discussions between national teams, thus contributing again to a clarification of policy issues.

The EC has recently stated some overall energy objectives like bringing the elasticity of energy consumption to the GDP to 0.7 in 1990 or making a converging movement of the relative prices of the different energy products (thermal equivalents). It is envisaged at present to evaluate with the multinational system the possible impacts of these evolutions.

Similarly, case studies are underway to assess the impacts of alternative investment policies including a sizable increase of energy investments.

In all these cases, many of the impacts are related to socio-economic magnitudes (GDP, inflation rate, employment, ...). It is quite obvious that, at the present stage of our knowledge of essential processes of substitution among production factors, many of these results should be treated with great care. The EC energy modeling system is, however, attempting to bring together the best knowledge available and is making the user conscious of its unavoidable limitations.

For the time being, and considering both the complexity of the system and the limitations of both the data and the model structure, the contact between the final user (the policy decision maker at the legislative or executive levels) and the model has to be filtered by the expert teams (at the EC and at the national levels). But it is essential that a communication is established between the final user and the expert team of the utmost transparency both at the level of the drawing up of hypothesis and of the interpretation of results. This transparency is the essential pre-condition if one wants to avoid the black-box characteristics of modeling that have limited its credibility, its development and its final usefulness.

Let us now examine the different possible uses of the EC energy models, uses for which the present stage of development of the programme is sufficient, provided extreme care is paid to the evaluation of future exogenous variables and parameters.

#### 1. Uses of Single Modules at National Level

As pointed out earlier the great flexibility of the EC system of models allows for specific applications using only parts of the system.

- The macro-economic models: the Eureka model includes a production function with capital, labour and energy. Thus this specific model can be used in each country in order to:
  - . assess the impact on economic growth of changes in energy prices and availability,
  - . study the possibilities of substitution between energy and labour at an aggregate level.

The international linkage existing for these macro-economic models facilitates the study of the international transmission of economic trends.

Eureka also identifies separately petroleum imports and it is therefore possible to compute growth consequences of constraints in petroleum imports.

- The input-output models: the input-output tables available in the EXPLOR model allow for an assessment of the structural implications for any single national economy of technological changes in production technologies induced by changes in the prices and availability of energy. As, for the moment, the input-output models are static, this type of simulations requires specific sectorial techno-economic studies analysing available production processes and their probable evolution. A project is underway to introduce dynamic behavioural functions into EXPLOR.

The methodology is also available to compute the structural effect of import or production constraints using, for instance, consumer expenditures maximisation as an objective function.

The input-output tables have been used in many countries already to compute the impact on prices of changes in the price of petroleum, considering both the direct and indirect effects; this computation is practically standardised. EXPLOR is, however, something more than a simple input-output model; it includes a number of other functions explaining both the formation of final demand and of factor costs and prices. Therefore it is possible to compute with EXPLOR the third order effect on prices of changes in petroleum prices when taking into consideration the relation existing in all countries between the cost of living indices and the wage rates. Studies conducted in this direction have clearly shown that the final impact of petroleum prices on national prices is much higher than the direct and indirect effects indicated and basically depends upon the strength of the unions when defending the purchasing power of the workers.

- The energy demand models: Both the EDM (medium term) and MEDEE (long term) can be used to analyse in depth the possibilities of substitution among energy products to meet demand requirements. For the medium term, the analysis is mainly done using the relative prices of the energy products and sectorial activity levels; for the long term, the analysis is made in terms of energy consumption processes at a very detailed techno-economic level. It is indeed felt that, in the long term, the range of possibilities of substitution is much wider and much less conditioned by past situations. The great flexibility of the MEDEE approach allows for simulations not only at the technical level but also at the social level.

It has often been said that the energy crisis cannot be solved in the long term without substantial socio-economic changes (implying new social structures corresponding to new value systems). The MEDEE models can be run with scenarios

portraying the essential characteristics of this new society (favouring, for instance, soft energy choices, non-polluting industries, decentralized industries...) and may suggest government policies oriented towards lower energy consumption standards.

- The linear programming models: Energy modeling efforts in most countries have for some years been concentrated in this area as a result of the previous application of linear programming in the optimisation of electrical networks. The general outcome of these models are optimal resource allocation under given constraints cost calculations and investment needs. It is therefore possible with EFOM to compute the implicit costs of environmental constraints or of import constraints.

These models include a detailed description of energy production processes and it is therefore possible to compute conditions for use of new technologies (e.g. solar) and to derive a policy of subsidies or of research and development expenditures.

## 2. Use of all the Modules together in a National Context

When using all the modules together it is possible to provide a more comprehensive answer to all the questions treated with each single module. One should, however, keep in mind the complexity of the system and it is necessary for the final user to specify a priori his areas of interest in order to extract from the information of a complete run only those aspects which are specifically related to them.

It is also possible, when using the entire system at national level, to run more complex scenarios including events (e.g. petroleum price changes, import constraints ...) and a policy mix (e.g. energy saving measures, rationing, subsidies to new technologies, public investment in petroleum substitution processes ...).

For reasons already pointed out, it is essential that this type of complex simulation be preceded by a thorough study of the system and that each result be explained with due reference to the structural relations of the models from which it is derived.

## 3. Use of all the Modules together in a Multinational Context

This is by far the most ambitious application of the EC systems of models that can be envisaged at present. It is, however, essential if the EC models are to be in the future of any use for the development of EC energy policies.

The problems to be dealt with are the same as those described for national applications. But furthermore it is possible in multinational applications to simulate the impacts of common policies (e.g. in energy saving or in the taxes and subsidies policies) or of a coordination of national policies (e.g. in the investment area leading to modifications of production specialisation in the different countries).

## FINAL REMARKS

The EC system of energy models has kept up to now the rest of the world as exogenous (with the single partial exception of the EURECA module). In principle

this situation could limit some of its possible applications in a very interdependent world. Collaboration with research groups in the United States and in international organisations has, however, been established since the beginning in order to overcome this potential limitation. It would practically be impossible to further develop the linkage process of the existing models in order to include explicitly other areas of the world. This is another reason for which the development of condensed forms of the existing system appears as an essential need of the Programme for the years to come.

# SYSTEM OF MODELS FOR ASSESSMENT OF LONG TERM DEVELOPMENT OF THE ENERGY COMPLEX IN BULGARIA

**P. Tsvetanov**

*Institute of Nuclear Research and Nuclear Energy, Bulgarian Academy of Sciences,  
Sofia, Bulgaria*

## ABSTRACT

The paper reflects some methodical concepts of the National program for systems assessment of the long-term development of the Energy complex in Bulgaria. It contains brief notes on the decomposition of the general task of the management of development into subtasks and describes the principles and state of the presently established system of models for assessing the long-term development.

## KEYWORDS

Theory of large energy systems; energy modeling.

## INTRODUCTION

The national energy systems (ES) belong to the category of the large artificial systems with a number of features: technological unity determining the presence of a National energy complex (NEC), hierarchy, complex character of links with nature and society, interconnection and interdependence with the regional and the world energy systems, inertial character of the structural changes and uncertainty of trajectories of development which make the task of development management complex and multidimensional. An important element of the systems approach to the solving of this task is its decomposition into sub-tasks. Figure 1 represents in a generalized manner such a decomposition of the task of modeling NEC development in Bulgaria according to hierarchy levels of ES and management stages. The energy systems in the country (general energy and the electric energy, coal, oil and gas systems covered by it) are interpreted as three-level ones (national and regional levels and level of energy plants) whose development is solved at two main stages: planning (short-term annual, medium-term - at five year periods and long-term - every 15 years) and long-term forecasting (15-40-50 years).

My paper reflects the state and principles of the system of models of the National program for long-term assessment of NEC development

in Bulgaria. The interest toward this stage of development covering future structural changes in energy increased considerably in recent years because of limited resources of high-grade organic fuels, energy prices growth, the trend toward capital-intensive technologies and ecological constraints of ES development which pose for solution concrete and urgent tasks with long-term consequences: selection of the most effective trends of scientific and technical progress, determination of the expediency to extract resources under extremal conditions, formation of an energy-oriented import-export policy, study of the consequences of energy development upon the country's economy including non-energy-intensive development.

	<i>Planning</i>		<i>Forecasting</i>
	<i>System of models for opt. of the 5-years development</i>	<i>System of models for opt. of the long-term planning</i>	<i>System of models for long-term forecasting</i>
<i>System of models for opt. of the general energy system (GES)</i>	<i>Models of the GES and BES-country Models of the GES and BES-regions</i>	<i>Models of the GES and BES-country Models of the GES and BES-regions</i>	<i>Model for forecasting of the GES and BES of the country</i>
<i>Models for opt of the branch energy systems (BES)</i>	<i>Models of the BES-country Models of the BES-regions</i>	<i>Models of the BES-country Models of the BES-regions</i>	<i>Model for technological progress of the BES-country</i>
<i>Models for opt of plants and equipment</i>	<i>Models for opt of separate plants</i>	<i>Models for opt. of standart and type equipment</i>	—

Fig. 1. Structure of the complex of models for optimizing energy development.

The national program for assessing the long-term development of NEC in Bulgaria is developing in close cooperation with IIASA and covers two scientific directions: methods and models for systems assessment and systems aspect of development of energy technologies. The first direction covers the application of systems analysis to assess the energy strategies and comprises two groups of tasks: general methodical problems (methodical and information problems of the links of long-term planning and forecasting, problems of linking the modeling of NEC to regional and world development etc) and a system of models for long-term forecasting - the subject of this paper.

#### SYSTEM OF MODELS

The set of models for long-term assessment of NEC development (Fig. 2) comprises 5 models reflecting various aspects of the energy problems and a stage of results and preparation of proposal.

#### Economic Model

The model is one of the key models of long-term forecasting. It aims at generating the basic indicators of the country's economic develop-



ment such as national income, production volume, investments and manpower according to sectors, necessary to determine energy demand and the development of the energy systems. It is also used to assess how the individual energy strategies affect the national income, the sectoral distribution of production and manpower and the composition of foreign trade activities according to products.

The building of such a model of the system of energy models in Bulgaria is presently at the stage of study including the macro-model developed in IIASA, the systems of models existing in Bulgaria and some other models developed in IIASA and other institutes.

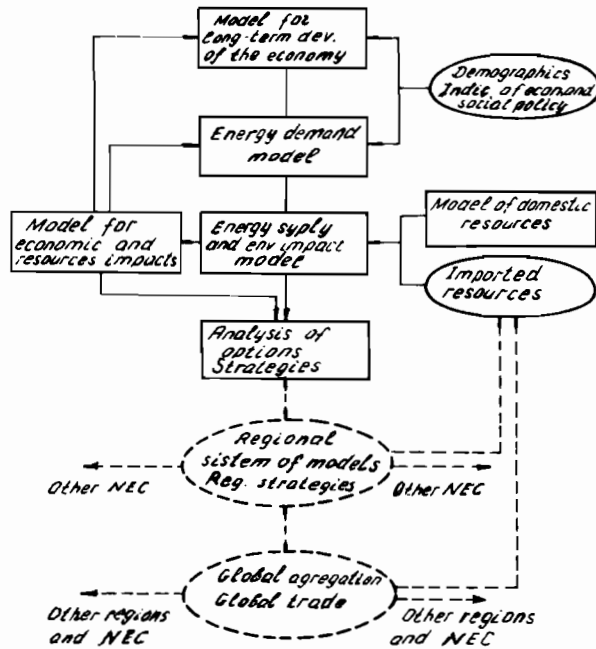

Fig. 2. General scheme of the system of models for assessment of NEC development in Bulgaria.

The macro-economic model of Norman-Rogner /1966/ used in the system of models of IIASA was a successful attempt to build a model which is sufficiently accurate to cover the basic investment peculiarities, leaving aside the maximum possible amount of details with a view of the long-term orientation of the model (1990-2030) and the information difficulties arising in connection with the world's regions. It was decided to build a single-sectoral structural model applying an approach based on production and consumer functions in aggregated form and including a certain number of important macro-economic factors such as for example aggregated factors of investments and consumption growth. This approach allows coincidence in macro-economic sense but gives limited possibilities for the output information needed for the model of energy demand and of ES development. The possibilities to assess the energy strategies by means of the model are also limited.

The now existing economic models in Bulgaria are mainly oriented toward medium-term and long-term planning. The most developed of them -

the IRIS system - is a system of equations of macro-economic relationships and its solving yields synthetic indicators of economy (economic growth) and production volumes, investments and manpower in a number of key sectors, including energy, which could be used as constraints of the development. However, the relationships in this system are not elements of an input-output model which hampers the closing of the energy-economy loop for an assessment of energy strategies from the viewpoint of national economy.

The studies of the improvement of the IRIS system are accompanied by a study of the models of SDS of IIASA MSG applied by L. Bergman /1978/ to energy in Sweden, the INFORUM model presently introduced in Bulgaria, and the SEI model developed by M.A. Gershenson /1977/ presented at this Symposium. The latter model is particularly attractive for the countries with centrally planned economy because of the dynamization of the coefficients of the economic inter-sector long-term model through a special adaptive model using information about the country's economic development in the last 15 years and the development in the next 15 years. (In accordance with the practice of management of development many economic institutions and governmental bodies in the planned economy countries have reliable data for this period).

#### Model of Energy Demand.

The model uses information from the economic model and information about demographic, social and technological development and policy, and assesses the components of energy demand in the country.

Modeling of energy demand occupies a prominent place in the studies of ES development. It is determined not only by the fact that the energy demand, reflecting the ties between society and energy, determines the necessary scale of its development. Modelling of energy demand and particularly so of long-term demand is extremely complicated from methodical point of view. IIASA studies in the period 1965-1966 including those of the author of the present paper, directed at the methodical clarification of the problem, can be divided into two categories: studies oriented at the better clarification of the mechanism and interties between energy demand and social and technological development (factor analysis, economic analysis, international comparisons etc) and studies of forecasting methods based on these ties. These studies give us ground to believe that an acceptable forecasting of energy demand can be done through a flexible, not fully formalized research procedure of a detailed scenario analysis of the economic, social and technological aspects of development. Such a procedure, initially developed at IEJE-Grenoble, France was subsequently adapted in IIASA in two versions: MUSE and MEDEE-2. The approach in these models and particularly so that of MEDEE-2 (Lapillone, 1978) is being used as the basis of the presently developed model of long-term demand in Bulgaria MEDEE-B. Its steps (Fig.3) are:

- Systems analysis of the social, economic and technological systems so as to identify the basic factors determining long-term evolution of energy demand. Unlike MEDEE-2 the model of Bulgaria at this stage covers also the studies using the country's economic model which are important for energy demand;
- Disaggregation of overall energy demand for various end-use categories;
- Organization of all determinants in a hierarchic structure from

macro into micro level, reflecting how the macro-determinants affect each end-use category:

- Construction of a simulation model by simplifying the system's structure and grouping the determinants into exogenous determinants and scenario elements.

Objectives of model. In designing MEDEE-B we have the following objectives in mind:

- Disaggregating the social, economic and technological systems we want to reflect directly the influence of the structural changes in these systems upon the long-term energy demand elements of saturation of social needs, policies (e.g. transportation and energy conservation policies), technologies (e.g. substitution of current processes with less energy-intensive ones), energy prices;
- To identify the potential market of each final energy form on the basis of detailed accounting of the energy demand by end-use categories in the modules of the simulation model;
- To use the model not only in the system of models for long-term forecasting of ES development but also as a reference for the medium-range policies of energy conservation now conducted in Bulgaria as one of the basic "strategies" of energy development.

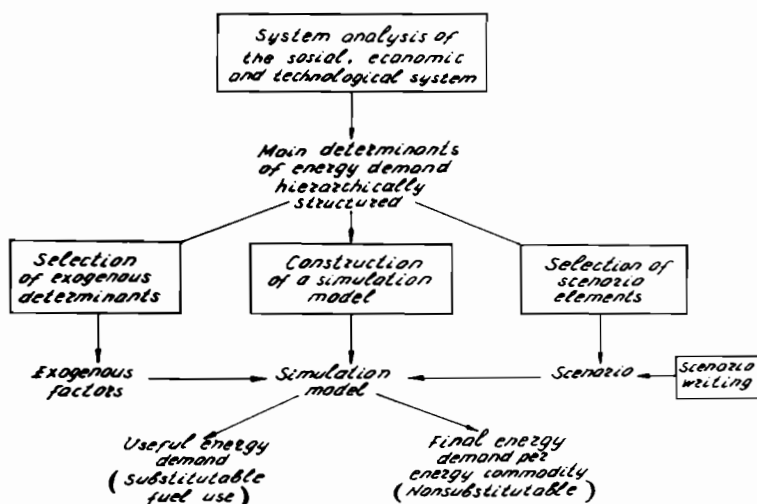

Fig. 3. Structure of model of energy demand MEDEE-B.

Description. The general structure of MEDEE-B is close to that of MEDEE-2. The distinctions connected with the presence of a balance long-term economic model in the system of models of Bulgaria are:

- In the input information - MEDEE-B is driven by socioeconomic information a considerable part of which originates from the economic model of the country's long-term development;
- In the structure of the model as a whole - Unlike MEDEE-2 the model MEDEE-B does not contain a macro-module. The functions of such a module are being performed by the country's economic model;
- The structure of the industrial module. In the case of MEDEE-B it is determined by the structure of the economic model with additional partial disaggregation in accordance with the country's organizational management so as to fulfil the medium-term policy of fuels and energy conservation mentioned previously.

The general procedure of studies in the simulation model of MEDEE-B is close to that of MEDEE-2. Energy demand in each of the modules of the simulation model (household/service, industrial and transportation) for each of the sectors is calculated as end-use demands of nonsubstitutable energy carriers (electricity, coke) and as useful energy of substitutable energy carriers (low-, medium- and high-temperature heat, stationary and non-stationary motive energy etc). The calculations are made for each sector according to sector's activities as measured through the voluminal cost production, or according to the physical volume of production and a coefficient of energy intensity reflecting energy demand in one unit of activity.

Model of Energy Supply.

The model compares the alternative technological systems of primary and secondary conversion, distribution and end-use in order to satisfy each component of the useful energy demand. It accounts also for the impact of the technological systems on environment and the impact of the constraints for environmental pollution on the perspective of development of technologies.

The model presently developed is of the MESSAGE type of IIASA (Agnew, Schrattenholzer, Voss, 1979). The scheme is shown in Fig. 4.

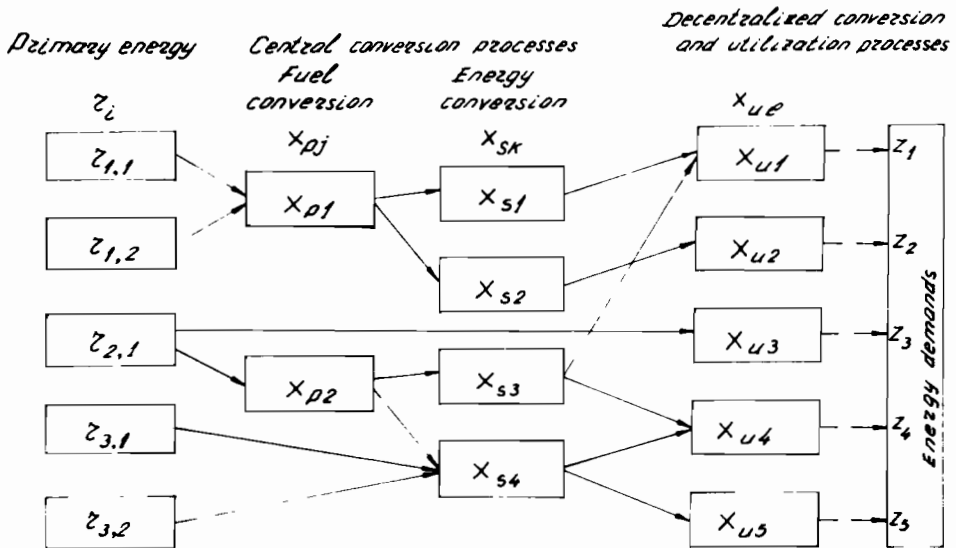

Fig. 4. General scheme of energy supply model.

Designations:

$x(t)$  is an  $\{n\}$  vector representing the level of production measured in output units of the energy supply technologies in the period  $t$  ;  
 $y(t)$  is an  $\{n\}$  vector representing the additional capacities  $N(t)$  created in the period  $t$  ;

$x(t)$  and  $y(t)$  can be partitioned in vectors to correspond to the central fuel and energy conversion and end-use processes, i.e.

$$x(t) = \{ x_p(t) : x_s(t) : x_u(t) \} .$$

the subvectors being of length  $n_p$  ,  $n_s$  and  $n_u$  respectively;

$r(t)$  is an  $\{m_r \times n_r\}$  vector of primary energy resources where  $m_r$  is

the number of different energy resources,  $n_r$  is the number of resource categories.  $r(t)$  can also be regarded as an  $\{m_r \times n_r\}$  matrix  $R(t)$ ;  $z(t)$  is an  $\{m_u\}$  vector of useful energy demands.

$m_r, m_p, m_s$  and  $m_u$  refer to the number of different energy forms: resources produced by the centralized conversions and the devices of end-use of energy.

The objective function of the model can be stated as the minimisation of primary fuel costs plus operating and maintenance costs discounted over time.

$$\sum_{t=1}^{n_t} \beta(t) [b'_r r(t) + c'_p x(t) + c'_s x_s(t) + c'_u x_u(t) + d'_p y_p(t) + d'_s y_s(t) + d'_u y_u(t)] \quad /1/$$

where  $\beta, c$  and  $d$  are unit cost vectors of primary energy sources, operating and maintenance and capital costs, respectively, and  $\beta(t)$  denotes the discount factor.

Balance equations energy supply - demand. The satisfaction of energy demand is realized by decentralized conversions and devices of end-use of energy which convert the end-energy (coal, liquid fuels, electric energy) into useful energy. On its side, end-energy is the product either of centralized conversions or of extracting of primary energy. Mathematically this can be formulated by the following matrix (vector) relationship.

$$\begin{array}{cccc|ccc} -V_{ru} & -V_{rs} & -V_{rp} & A_r & x_u & & 0 \\ -V_{pu} & -V_{ps} & A_p & & x_s & & 0 \\ -V_{su} & A_s & & & x_p & \geq & 0 \\ A_u & & & & r & & z \end{array} \quad /2/$$

Because the variables are measured in output units, the  $A$ -submatrices consist of ones and zeroes while the  $V$ -submatrices consist of conversion ratios (i.e. the reciprocals of the efficiencies) and zeroes (i.e.  $V_{rp}$  is an  $\{m_r \times m_p\}$  matrix giving the requirements for input of primary energy sources required for the fuel conversions processes in the production of one unit of the main output of the processes).

Availability of natural resources. The equations of the resources demand are of the following type:

$$\text{where: } \sigma_t \cdot \sum_{i=1}^{n_t} r_{ij}(t) \leq s_{ij}(n_t), \quad i \in m_r, \quad j \in n_r \quad /3/$$

$r_{ij}$  - annual demand of the internal primary energy resource  $i$  of the resource category  $j$ ;

$\sigma_t$  - length of period of time in years;

$s_{ij}(n_t)$  - availability of internal energy resource  $i$  of the resource category  $j$ .

For each imported energy resource for each period of time is satisfied the condition

$$\sigma_t \cdot r_{ij}^k(t) \leq s_{ij}^k(t) \quad /4/$$

where:

$r_{ij}^k(t)$  - annual demand of imported energy resource  $i$  of the category  $j$  ;

$s_{ij}^k(t)$  - estimated availability of imported energy resource  $i$  of the category  $j$  .

Other constraints. The environmental constraints (factors related to the effect of the various energy technologies on environment), the auxiliary conversion technologies and the additional constraints (constraints of capacities, constraints of market penetration of new technologies) occupy an essential place in the model but for the sake of brevity they have not been formulated in this paper.

State and development of model. The model is developed in two stages. The first stage does not cover the sectors of end-use consumption and is used to study the dynamics of technological changes, the substitution of fuels, the study of the effect of gas cleaning, improving the existing technologies and price policy for energy conservation. The second stage covers also the sectors of end-use consumption and is used to determine the location of plants for energy conversion, utilization of waste heat, energy conservation through total improvement of conversions etc. Present activities cover specification of technologies included in the model, covering in particular developed nuclear and solar technologies, load characteristics of electricity consumption, district heating and environmental impact of energy conversions.

#### Economic IMPACT Model

The model is used to evaluate the direct and indirect investments and operating costs of the energy strategies and their requirements for the development of the related branches and for limited natural resources (water, energy, land, materials and manpower). It is based on the dynamic multisector model constructed at the Siberian Power Institute and developed further at IIASA (Kononov, Por, 1978). The use of the model in the energy field in Bulgaria and in some other small countries with open economy is linked with some peculiarities because of the breaking of a considerable part of the production relations because of the import of fuels, energy and equipment. The adapting and improvement of the model requires efforts in two directions: first - the breakings of the production relations should be accounted for properly, and secondly - the model must not turn into a model of constrained production relations but must retain, in particular in the field of investments, its character as a model for economic assessment of development strategies. The latter is of importance both with regard to preserving the significance of model for assessment of these strategies and to the closing of the loop energy - economic model of country's development.

We will discuss briefly some of the features of this approach with the different sets of equations of the model.

The first set of equations calculates the direct demand of materials and equipment by the related sectors for construction and operation in NEC:

$$y_e(t) = A_1 \bar{x}_e(t) + \sum_{\tau=t}^{t+\hat{\tau}} F_1^{(\tau-t)} \bar{N}_e(\tau) \quad /5/$$

where

$y_e(t)$  - vector of direct operational and investment requirements of NEC in products of related sectors at year  $t$  ;

$\bar{x}_e(t)$  - vector of annual energy production of NEC (production of the  $e$ -th resource or energy conversion or energy supply to the consumer at year  $t$  );

$\bar{N}_e(t)$  - vector of required additional capacity in NEC;

$A_1$  - contribution of non-energy sectors to operation and maintenance of energy production per unit of activity ;

$F_1^{(\tau-t)}$  - contribution of non-energy sectors for the building up of additional capacity to be put into operation in the year  $\tau$ . ( $t \leq \tau \leq t + \hat{\tau}$ )

$\hat{\tau}$  - lead time (construction lag).

In the spirit of the aforementioned this system of equations should solve two problems:

- Accounting for the broken links - the result of imports and equipment. This is realized through the respective preparation of information in the matrices  $A_1$  and  $F_1^{(\tau-t)}$ . The vectors  $\bar{x}_e(t)$  and  $\bar{N}_e(\tau)$  obtained by the model of energy supply are decomposed into sub-vectors of imports and internal production;

- Including in  $y_e(t)$  of the requirements toward the sectors related with the export of products to compensate the import of fuels and energy. This is done by including in the nomenclature of the related sectors of the sectors compensating the import of fuels and energy and through the appropriate selection of specifiers in  $A_1$  according to the relative role of these sectors for the compensation of this import.

The second system of equations, by using the balance method, describes the direct and indirect requirements for products and equipment of the related sectors, necessary for a given development of NEC:

$$x_1(t) = A_2 x_1(t) + A_3 x_2^{in}(t) + y_e(t) \quad /6/$$

where:

$A_2$  - matrix of input-output coefficients;

$A_3$  - matrix of materials and equipment requirements per unit of investment in non-energy sectors;

$x_1(t)$  - vector of output in non-energy sectors;

$x_2(t)$  - vector of direct capital investments.

We should decide how to exclude from  $x_1(t)$  the materials and equipment imported in the related sectors. Two approaches are possible:

1) By adding into the equation the term  $(-\bar{y}^{imp}(t))$  giving the import of these materials and equipment, and 2) By changing the consumption coefficients of a given imported product for production and construction needs of all other sectors (if there is a hypothesis what portion of the consumption of certain product will be covered by imports). The model IMPACT-B uses the first approach.

The calculation of the additional capacities in the related sectors including the sectors compensating imports in NEC, using  $x_1(t)$  poses no problems:

$$N_i^{(i)}(t) = \begin{cases} \min\{x_i^{(i)}(t+1) - x_i^{(i)}(\tau)\} & , \text{ if } x_i^{(i)}(t+1) - x_i^{(i)}(\tau) > 0 \\ 0 & , \text{ if } x_i^{(i)}(t+1) - x_i^{(i)}(\tau) \leq 0 \end{cases} \quad /7/$$

for each  $i \in \{1, 2, \dots, k\}$ .

The calculation of the direct and indirect capital investments in the model of IIASA is determined by the necessity to introduce capacities in NEC and the related sectors:

$$x_2(t) = x_2^d(t) + x_2^{in}(t) = \sum_{\tau=t}^{t+\hat{\tau}} F_2^{(\tau-t)} \bar{N}_e(\tau) + \sum_{\tau=t}^{t+\hat{\tau}} F_3^{(\tau-t)} N_i(\tau) \quad /8/$$

where

$F_2^{(\tau-t)}$  and  $F_3^{(\tau-t)}$  - specific capital investments in the year  $t$  for putting into operation the capacity in NEC and the non-energy (including those which compensate imports in NEC) sectors in the year  $\tau$ .

However, these expenditures are not full capital investments for the development of NEC. The latter cover, apart of the expenditures for fuels, energy and energy equipment imported in NEC, also materials and equipment imported in the different sectors for which reason the model IMPACT\_B covers also

$$x_{TOT}(t) = x_2(t) + \bar{x}_e^{imp}(t) \text{ and } \bar{y}^{imp}(t) \cdot C, \quad /9/$$

where

$\bar{x}_e^{imp}(t) \cdot C_e$  - expenses for the import of fuels and energy

$\bar{y}^{imp}(t) \cdot C$  - expenses for the import of materials and equipment in the different sectors.

Calculation of WELMM requirements for the development of NEC and the different sectors (including those which compensate imports in NEC) poses no problems:

$$x_3(t) = A_4 x_e(t) + A_5 x_1(t) + A_6 x^{in}(t) + \sum_{\tau=t}^{t+\hat{\tau}} F_4^{(\tau-t)} \bar{N}_e(\tau) \quad /10/$$

where:

$x_3(t)$  - WELMM expenses;

$A_4$  - direct operational WELMM coefficients;

$A_5$  - operational WELMM coefficients of non-energy sectors;

$A_6$  - construction WELMM coefficients of non-energy sectors;

$F_4^{(\tau-t)}$  - direct constructional WELMM coefficients.

IMPACT\_B is now at the stage of experimental calculations. Its linking to the economic model of the development of the country is done by a procedure developed jointly with the economic model.

### Analysis of Variants, Strategies.

The stage of analysis of variants uses the methods of making decisions under the conditions of uncertainty, the methods of factor analysis and planning of experiment and aims at preparing proposals on the basic trends of the long-term energy policy: basic trends of scientific and technical progress, basic programs of national importance including energy conservation, development of sectors connected with the development of NEC etc. The procedures of this analysis are not the subject of the present paper.



The contents of this paper reflects the beginning of the establishment of a system of models. Significant efforts are necessary for the full experimentation of the models with real data, their linking into a system, the investigation and formulation of the exogenous conditions and the overall procedures for the study and analysis of the results.

#### REFERENCES

- Agnew, M., L. Schratzenholzer, and A. Voss (1979). A Model for Energy Supply Systems Alternatives and Their General Environmental Impact, WP-796, IIASA, Laxenburg, Austria.
- Bergman, L. (1978). Energy Policy in a Small Open Economy: The Case of Sweden. RR-78-16, IIASA, Laxenburg, Austria.
- Gershenson, M. A. (1977). Intersector Models for Long-Term Energy Forecasting. In Y. D. Kononov (Ed.), Methods for Systems Analysis for Long-Term Energy Development, CP-77-2, IIASA, Laxenburg, Austria, pp 9-18.
- Lapillone, B. (1978). MEDEE-2: A Model for Long-Term Energy Demand Evaluation. RR-78-17, IIASA, Laxenburg, Austria.
- Norman, M., and H. H. Rogner (1977). Potential GNP Model for the U.S. IIASA, Laxenburg, Austria.
- Tsvetanov, P., and W. D. Nordhaus (1965). Problems of Energy Demand Analysis. In W. D. Nordhaus (ed.), Proceedings of the Workshop on Energy Demand. CP-76-1, IIASA, Laxenburg, Austria, pp 88-102.
- Tsvetanov, P. (1966). On the Approach to World Energy Modeling, WP-76-31, IIASA, Laxenburg, Austria.



# A L.P. MODEL OF THE DUTCH ENERGY SECTOR

**F. van Oostvoorn, P. G. M. Boonekamp and N. J. Koenders**

*Energy Study Centre, Netherlands Energy Research Foundation ECN,  
Petten, The Netherlands*

## ABSTRACT

The main objective of the model is to use it as a tool for long term energy planning and evaluation of energy policies. After discussing the main policy issues and characteristics of the Dutch energy system an attempt is made to clarify the choice of the adopted modelling technique. Although we stress the major advantages of the L.P. modelling approach we pay particular attention to the limitations of the adopted class of models. We indicate how to remove some limitations and thus enlarge the scope and credibility of the L.P. model of the Dutch energy sector, called SELPE. Furthermore the specification of SELPE will be discussed and an application is presented.

## KEYWORDS

Linear-programming; energy sector; objective functions; energy policy of the Netherlands; applications; network-model description.

## INTRODUCTION

A few years ago the national Energy Study Centre was established with the objective to perform system analysis studies in the energy field. The main part of the modelling activities is devoted to develop tools for energy planning and policy analysis for the government. In this paper we will concentrate our attention on a long term energy model of the Dutch energy sector. Before focusing on the choice of modelling technique we mention some special features of the Dutch energy economy and some important energy policy issues. Firstly an import feature is the openness of the Dutch national economy and energy system. This means a strong domestic dependence on world market developments and a high import vulnerability. Secondly the dependence on foreign energy resources will strongly increase in the future when domestic natural gas is depleted. Thirdly the cheap crude oil imports and the large natural gas deposits made the Dutch economy very energy intensive.

The major energy policy goals are:

- conservation of rapidly depleting natural gas resources,
- restricted use of nuclear energy,
- increasing imports of LNG and the reintroduction of coal as an important energy source,

· last but not least energy demand conservation.

It is clear that long term energy policy and planning is needed to tackle the problems that go along with the profound shifts that will take place in the near and the far future. Evidently an important policy maker and decision maker like the government needs a policy and planning tool to comprehend these transitions and to deal effectively with the problems involved.

#### WHY LINEAR PROGRAMMING FOR MODELLING THE NATIONAL ENERGY-SECTOR?

The fact that technological features dominate the energy sector suggests the use of a process analysis type of model. A L.P. network description of the many production functions composing the energy network model offers a number of advantages over the alternative approach of statistical production or supply functions and is therefore commonly used in energy sector modelling (see for instance models like BESOM, DESOM, Markal etc.).

In a joint-product-multiprocess sector like the energy sector, statistical estimation is difficult in view of the problems of simultaneous equations bias and multicollinearity. On the other hand the L.P. network description is easily adaptable to joint production and capital intensive processes. It offers easy incorporation of technological processes by using detailed engineering data.

The general structure of SELPE, an acronym for Static Linear Programming Energy-model, is like most of the L.P. models of the energy sector.

minimize  $cx$

subject to  $Ax \geq b$

and  $x \geq 0$

where  $\bar{c}$  is an  $1 \times n$  vector of costs associated with the various processing activities.  $x$  is an  $n \times 1$  vector of endogenous energy flows.  $A$  is an  $m \times n$  matrix of conversion, transportation, distribution and allocation coefficients.  $b$  is an  $m \times 1$  vector of exogenous energy demand.

The heart of the network model is the set of constraints describing the Dutch energy sector as close as possible for the period 1976-2000. In the network representation of the energy sector energy forms and fuels are represented by nodes. Processes, important ancillaries and by-products are represented by links. For the network description we did not use a single stage specification of energy supply till end-use like (Cherniavsky, 1974).

Instead we used a multi-stage specification of energy supply till end-use like (Finon, 1976). This last approach has the advantage of identifying separately each stage of the transformation process from primary energy till end-use. We used many different types of constraints and no strict network convention was adopted.

The SELPE model provides a complete physical representation of the Dutch energy sector for the period from 1976 till 2000.

Energy resources are: nuclear power, solar heat, wind power, imports of LNG, NG, coal, coke, crude oil and oil products and extraction of NG and small amounts of crude oil.

New technologies like coal gasification, fluidized bed combustion and combined heat-power production etc. are incorporated. Also centralized and decentralized electricity and heat production on a coal, oil, gas or nuclear base are included. We distinguish peak and base load electricity production and the capacity variables in the electricity sector are endogenous.

The definition of exogenous demand is partly in useful energy and partly in final energy demand. A fuel independent definition of the exogenous demand variables was not adopted, because of lack of data, linking problems with demand models and the weak applicability of the L.P. technique in this sector definition. To indicate the size of the model it contains about 220 endogenous variables, 60 processes and 50 other constraints.

#### LIMITATIONS OF THE L.P. DESCRIPTION AND WAYS TO REMOVE THEM

It is a well-known fact that the L.P. models are of an overtly normative nature. Thus the qualities in describing the actual behaviour of the energy sector in a realistic way can be rather poor.

Using a single objective function like minimization of cost in the model assumes perfect competition on all energy markets. However in the real world the physical energy-supply responses are not always functions of market prices only. Besides energy-prices other factors influence the energy supply and distribution. The capital intensive energy sector contains a lot of market imperfections and often its production functions are subjected to economies of scale. For that reason appropriate constraints were added to the SELPE-specification and partly removed these drawbacks. So probably the L.P. objective of cost minimization or maximization of economic efficiency is rather close in reflecting the decision making process in the energy sector.

The definition of cost in the optimization model raises problems too. Energy markets are characterized by price regulation and rate structure economics that weaken the general accepted relation between price and economic cost. For example many models use the concept of supply cost in their objective functions. Supply costs are more pertinent to supply decisions and (demand) prices are more pertinent to demand decisions. So for the computation of a market equilibrium with a static L.P. model we have to incorporate market prices to guide the decisions in the model. This price-cost distinction is overlooked in many large L.P. energy sector models. To improve the behavioral performance of SELPE we used the concept of market prices by incorporating taxes, regulation effects and rate differences in the specification of the objective function. For example public utility rate-making for electricity and natural gas are included for final demand categories. We think the network description can easily handle these cost-price distinctions

Another improvement in modelling the decision making process is attained by using other objective functions. The changing environment of the energy policy making and the existence of conflicting objectives linked to different decision makers or groups of decision makers is obvious. In other words energy policies and objectives cannot be placed in the context of cost minimization only.

We have to take into account other political dimensions such as uncertainty of crude oil imports or the availability of resources in the long run. Different pressure or interest groups, for example environmentalist and entrepreneurs, have conflicting objectives.

As a matter of fact we specified other objectives for SELPE too, viz.:

- minimization of oil imports,
- minimization of an environmental index,
- minimization of resource use,
- minimization of capital cost.

Clearly some of the above mentioned objectives are conflicting and this is reflected in the decision making process. A promising method developed to handle the conflicting decision making within an L.P. model is the so called multi-objective analysis (Zionts, 1979; Nijkamp, 1976). Probably there are two important benefits to the use of multiple criteria analysis. Firstly the model describes decision making of the real world more realistically. Secondly the decision maker, for example the government, can be forced to reveal his priorities in a more consistent way than is otherwise attainable.

The energy demand is treated as an exogenous variable rather than as a demand function. This concept of zero price elasticity of final demand works reasonably well during an era of no abrupt discontinuities in energy prices and demand is not seriously affected by prices. But nowadays and in the future price effects on energy demand will be important.

Besides the zero price elasticity causes a bias towards high technology and capital intensive energy systems and thus blurs a fair comparison between competing technologies.

There are several ways to remove the zero price elasticity of demand. Shadow prices of demand constraints can be compared with assumed market prices, complementary to the assumed exogenous final demand of energy till market equilibrium is attained. For this exercise price elasticities of demand are needed. Another approach is linking the sector model to an (interindustry) energy demand model.

The deterministic system description of the L.P. model overlooks the fact that the parameters or coefficients of the model contain statistical errors. The user must know how accurately the model represents the energy sector, because changes of the values of the parameters would change the calculated optimal values of decision variables and so influence the energy policy recommendations.

Main sources of errors are:

- specification errors,
- input data errors,
- parameter errors.

The coefficient of the constraints of SELPE are estimates for the optimization (planning) years 1980, 1985, 1990, 1995, 2000. These estimates are based on a combination of engineering and economic (statistical) data. The statistical data consists of annual data for the years: 1973, 1974, 1975, 1976, 1977.

Probably the most suitable way to deal with the statistical errors in the parameters of a large scale L.P. model is:

1. Use appropriate L.P. software (e.g. Apex III) and one gets information about the sensitivity of parameters, input variables etc.
2. Select the most sensitive parameters and input variables. Generally model solutions are most sensitive to variations in the values of the cost parameters.
3. Estimate the uncertainty of the selected parameters and input variables.

So for a specific year tolerance margins for each variable can be calculated. Thus point estimates of sensitive parameters and input variables are replaced by margin estimates and so the calculated optimal solutions are band-width values.

Furthermore for a proper assessment of the capability of SELPE to reflect the relations of a real world system we also validate our model. This is very important for giving reliable policy answers to the policy maker. We did validate SELPE only for a few historical years. These ex-post forecasts for 1976 and 1977 were very illuminating. In fact they led to some respecification of constraints of SELPE. We admit that proper validation would need a longer reference period, but validation of a rather big L.P. model needs a lot of time. Therefore in spite of the rather "good fit" of the calculated values of the endogenous variables to the actual values we feel that further study is needed in this direction.

#### AN APPLICATION

The model SELPE described previously will be illustrated by an empirical application. We will present some preliminary results of a larger analysis of a set of long term energy scenario's, of which more computation results are underway. Our first step was to establish a reference or base case scenario representing a projection of the developments in the Dutch energy sector till the year 2000. The period 1976-2000 was subdivided in intervals of 5 years.

So the planning years for optimization were 1980, 1985, 1990, 1995, 2000.

Input data representing the national economic framework for the reference scenario were projections of the Central Planning Bureau of the Netherlands.

The most important data were:

- an average growth of GNP of 3%,
- an average growth of domestic energy demand of 2.9%,
- an average growth of industrial energy demand of 4.4%,
- an average growth of residential energy demand of 1.3%.

The calculation of an optimal reference scenario for the period 1976-2000 for the Dutch energy sector showed some interesting results.

- a. In spite of a very moderate growth of energy demand the oil imports did increase sharply, see Fig. 1. The refinery capacity stayed at its 1976-level and in 1995 oil refineries will reach a 90% degree of capacity utilization which is now about 65%.

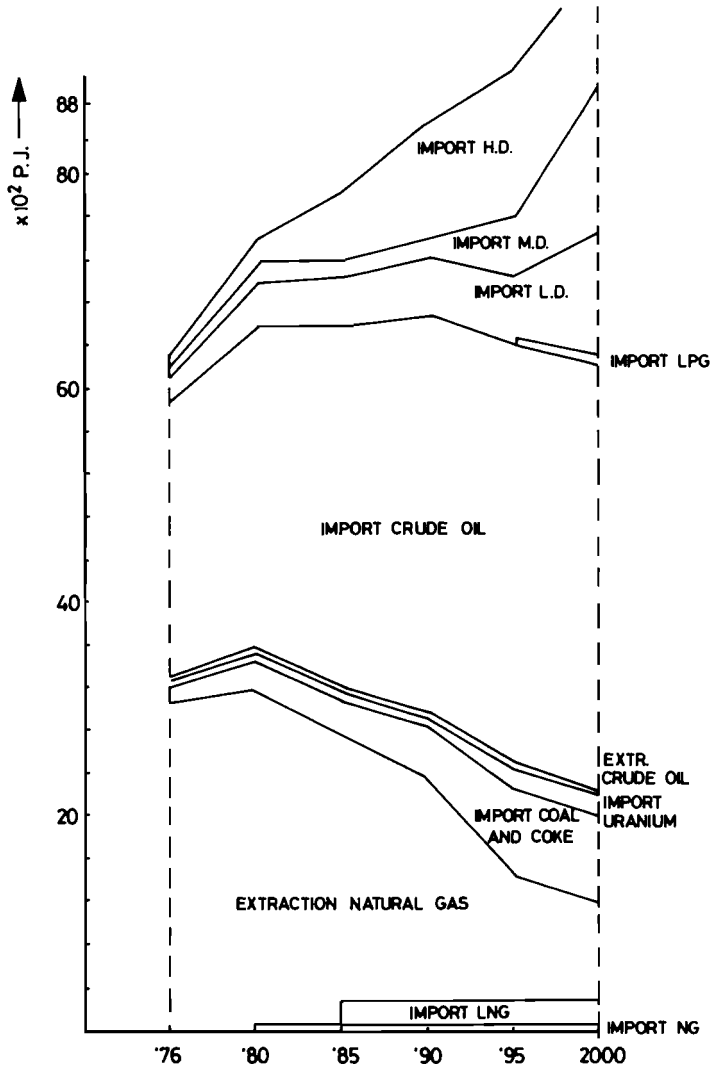

Fig. 1 Supply mix of primary energy

b. The policy of conserving domestic natural gas will change the fuel input mix of the electric utilities profoundly, see Fig. 2. In the first years the share of heavy distillates will increase but later on when coal fired electric power stations are on stream there will be a dramatic shift to coal inputs. Political obstacles will probably restrict the building of more than 3000 MW nuclear capacity of LWR's before the year 2000. The capacity utilization of public electric power stations, now about 60%, will increase up to 73% in 1990. But the penetration of new technologies like wind power, district heating and solar heating is very low mainly due to the assumptions of relatively conservative price increases for energy imports.

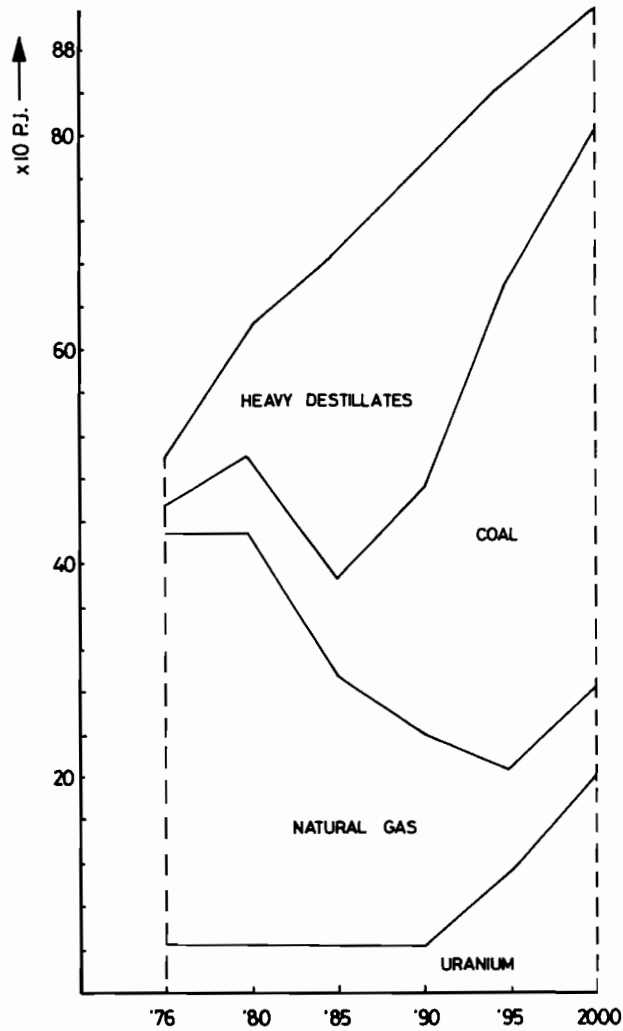

Fig. 2 Fuel input mix of electric utilities



In general, the results of the reference scenario seem fairly realistic and did increase the credibility of SELPE.

Further extension of modelling activities would be the use of multiple criteria decision making analysis and the use of an environmental sub-model containing emissions, environmental constraints and an environmental objective function.

However, we did not yet estimate price elasticities of demand or linked the supply model to a demand model. These time-consuming activities will start in the near future.

#### REFERENCES

- Cherniavsky, E.A. (1974). Brookhaven energy system optimization model. BNL 19569.
- Finon, D. (1976). Un modèle énergétique pour la France. CNRS, Paris.
- Nijkamp, P. and P. Rietveld (1976). Regional science and urban economics 6. North-Holland, Amsterdam, 253-274.
- Zionts, S. (1979). Methods for solving management problems involving multiple objectives, working paper no. 400, School of Management, State University of New York at Buffalo.



# ENERGY MODEL FOR JAPAN IN A.D. 2025

**Committee on Energy System Analysis, JITA\***  
**F. Mori\*\*, S. Wakamatsu\*\*\*, T. Maeda\*\*\*\* and S. Yasui\*\*\*\***

*\*Japan Industrial Technology Association, Tokyo, Japan*

*\*\*Mitsubishi Electric Corporation, Tokyo, Japan*

*\*\*\*Electrotechnical Laboratory, Japan*

*\*\*\*\*Tokyo Gas Co., Ltd., Tokyo, Japan*

## ABSTRACT

The objective of this simulation model of the energy system is intended to quantitatively support the formulation of development strategies for Japan's energy technology.

We shall discuss the characteristics of the energy system in Japan and outline three submodels - namely the supply, demand and energy flow models.

## KEYWORDS

Energy R&D strategy; world energy model, energy flow in Japan; quality of life; industrial structure; security of an energy system, roles of new technologies.

## PREFACE

The development of energy technologies not only takes time, but involves vast amounts of money and numerous trained personnel. Therefore, it is necessary to establish a strategy on energy development. Through the use of models we have attempted to clarify the importance of new energy technologies, in order to assess its impact on Japan's future supply and demand for energy. The model has incorporated 3 interesting features.

Energy data was collected and processed in such a way so that it conformed to the parameters of the model. However, not only forecasted, but historical data concerning the conversion, storage, transportation and distribution costs of energy, that takes place from the time of origination or acquisition until final consumption was difficult to obtain. We were successfully able to construct a data base.

It was also important to perceive changes in the needs of the people. Food, clothing, shelter, social life styles and industrial activities,

all affect the quality and quantity of energy required. The model takes into consideration these changes in consumption patterns.

Another aspect was determining the impact of the amount of money and resources spent in energy development. Self-supply and internal technological development of energies are deemed essential for national security. Thus, a method of evaluating energy security has been devised in connection not only with self-supply of energies, but also with imported energies, availability of energies from various energy producing countries and diversification of energy sources.

#### BRIEF DESCRIPTION OF JAPAN'S ENERGY SYSTEM AND THE ANALYTICAL MODEL

In reviewing the energy system of any country, it is important that the characteristics and peculiarities of the country be studied, so the model simulates a "real world" situation. The characteristics listed below are not only important as a starting point for the analysis, but identify the Japanese energy system. The model assumes that they will not undergo drastic changes in the future.

- (1) The level of domestic energy supplies and resources are limited. Therefore, Japan depends on imports for the majority of its energy needs.
- (2) Oil accounts for a large portion of total energy supplies.
- (3) Energy is consumed in large quantities in a concentrated area, where environmental regulations are very severe.
- (4) The use of energy by industry accounts for 60% of the total energy consumption, while the residential consumption is small.
- (5) Most of the energy-related plant and equipment are modern, due to many years of high economic growth and investment.
- (6) Electricity is available all over the country. However, only half of the nation's population consumes city gas, while the other half uses LPG.

The simulation model has the following major features.

- (1) The model has been designed to closely scrutinize energy imports, while rough estimates are given for domestic resources.
- (2) The demand for oil by industry was classified by end use in the industry's facilities.
- (3) In order to measure the effect on the environment, energy consumption has been categorized by both sulphur content and whether or not the facility was equipped with desulfurization or denitrating devices.
- (4) With respect to residential energy demand, kerosene and LPG consumption has been considered, in addition to electricity and city gas.

#### SCOPE OF STRATEGY REVIEW

The following studies were made using the analytical models.

- (1) External factors of the Japanese energy system were forecasted on the basis of multiple scenarios. (i.e. Energy prices, amount

- of energy supply available to Japan and energy demands.)
- (2) According to multiple criteria, the optional amount of energy for each demand sector and the optimum rates of operation of the facilities were determined in 5 year intervals.
  - (3) The effect of the technological development, such as improvement of the system's vulnerability, energy saving, reduction of energy costs, reduction of energy imports were discussed in the review of the outputs. Especially, analysis on end-use markets were emphasized where new energies are thought to be suitable.

#### OUTLINE OF THE MODEL

Structure of the model:

The model includes the following three submodels and a control model.

- (1) Supply model
- (2) Demand model
- (3) Energy flow model

Supply model:

The supply model may be regarded as the world's energy supply and demand balance model. It forecasts energy prices and amount of energy suppliable to Japan under the predicted economic and energy situation of the world. This model is called supply model, because its results are used as restrictions of primary energies for the energy flow model.

Basic assumptions are listed below.

- (1) The world is divided into 9 demand/supply regions.
- (2) Each region has its own standard economic growth rate which depends on energy prices and energy demand elasticity based on economic growth rates.
- (3) OPEC's oil prices are affected by the supply/demand gap of traded oil.
- (4) Demand in each region is divided into 4 categories, substitutable demand, non-competitive electricity, non-competitive oil and non-competitive coal.
- (5) The amount of substitute energy production depends on the market price mechanism.
- (6) The amount of each energy source used is determined by its substitutability function.

Fig. 1 shows the basic structure of the model.

Fig. 2 shows an example of a substitutability function which determines the amount of a substitute energy according to its relative price to oil.

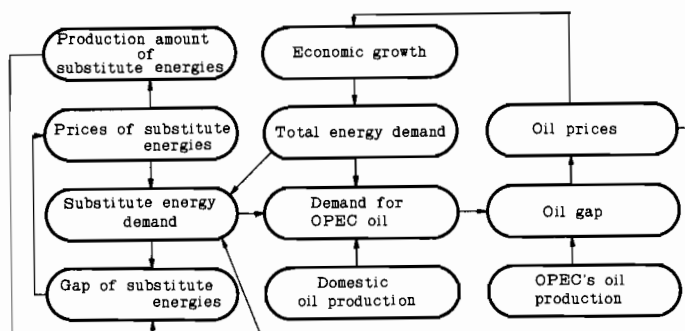

Fig.1 Basic Structure of Supply Model

Rate of substitution

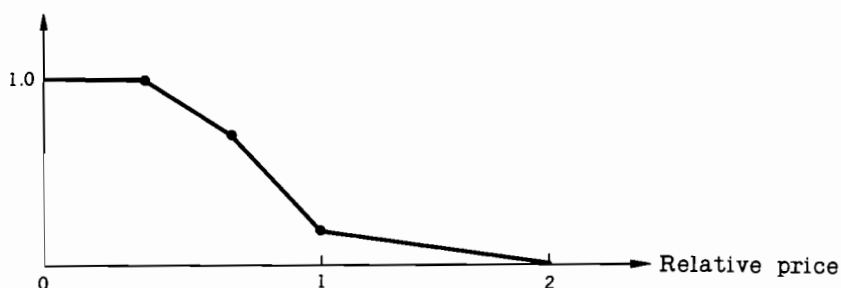

Fig. 2 Example of Substitutability Function

Demand model:

The demand model is intended to forecast the average quality of Japanese people's life (QOL), level of industrial activities and energy demand required to support the living standard and industrial production. QOL is expressed by a combination of 5 basic needs, namely foods, clothing, housing, general life and national needs. In the development of the forecasting procedures, each need was related to the population, income per capita, saturation factors and etc.

The energy demand in each end use market was estimated using the 5 basic needs. For industrial markets, the amount of end-use products and materials for industrial production required to meet the respective estimated needs were forecasted in due consideration of future industrial structure and target levels for imports and exports. The amount of energy required to produce these products and materials were estimated for each industry and facility. For transportation markets, demand by type of transportation was related to the amount of passenger vehicles and ton-kilometers of freight, which were functions of the basic needs. Residential energy demand was divided into 6 sectors, that is, space heating, cooling, water heating, cooking, motive power and lighting/electronics, which were related to the size of houses, the size of household, saturation of appliances and the basic needs.

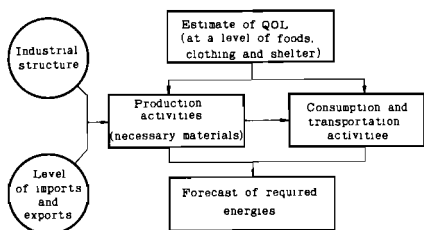

Fig. 3 Energy Demand Forecasting

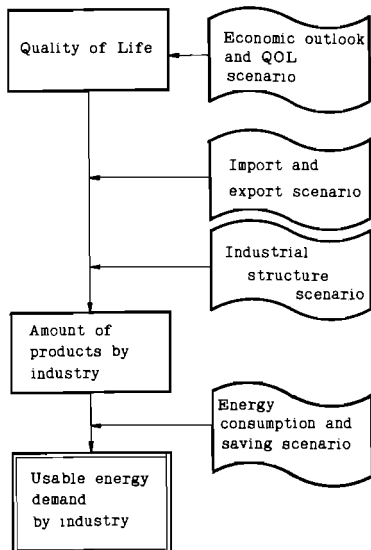

Fig. 4 Industrial and Commercial Demand Forecasting

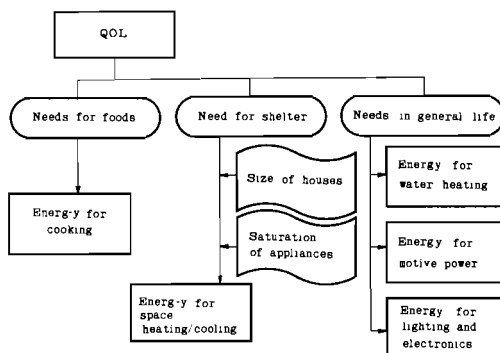

Fig. 5 Residential Energy Demand Forecasting

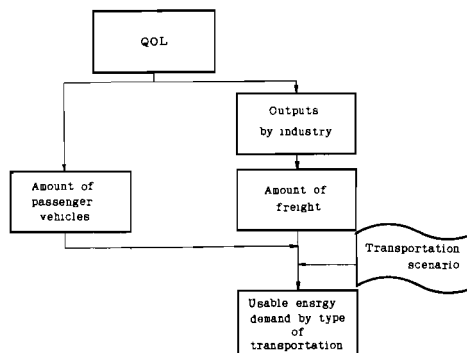

Fig. 6 Transportation Energy Demand Forecasting

Energy flow model:

The energy flow model was used for evaluating the effects of various policies. The output estimated the percentage contribution for each primary and secondary energy source and how technological development of energies would improve the future energy situation in Japan.

The model includes about 40 primary energies, over 60 secondary energies and more than 50 end use demands. These are connected by about 400 processes such as conversion facilities, transportation measures and end use appliances to form an energy flow.

The forecasted time period was from 1975 to 2025, though it is to be noted that the model itself can be applied for any given period. Optimization is carried out only for a single fiscal year at one time. However, in order to connect all the fiscal involved, the results obtained in any fiscal year were reflected to the constraints in the following year.

The major algorithm that determines the amount of energy supply required at each level of the energy flow is a linear programming technique. A maximum of 10 criteria can be used for the objective function. The significant ones were the following.

- (1) To maximize the total thermal efficiency in the whole system
- (2) To minimize the amount of energy imports
- (3) To minimize energy-related costs in the whole system
- (4) To minimize the total emission of air pollutants in the whole system
- (5) To minimize the vulnerability of a nation's energy structure

As for the last criteria the vulnerability is defined as a combination of a degree of reproduceability and regional divergence of resources.

Examples of Outputs

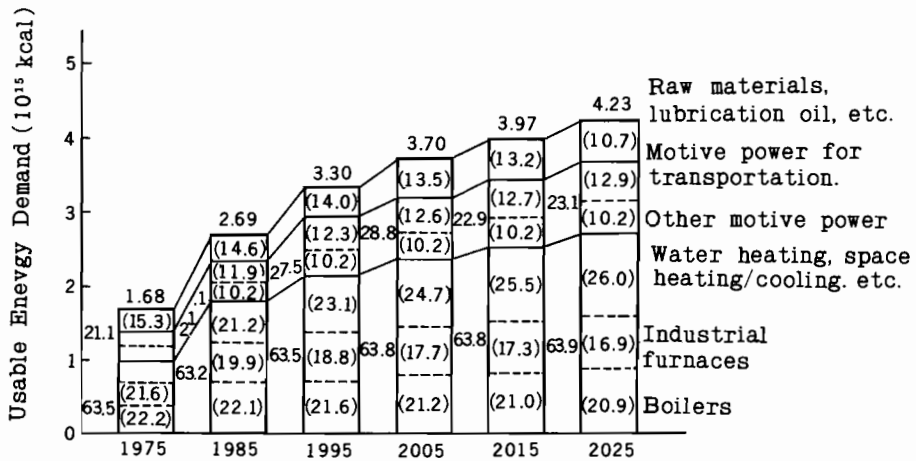

Fig.7 Demand Growth based on the usable energy (Low energy growth scenario)



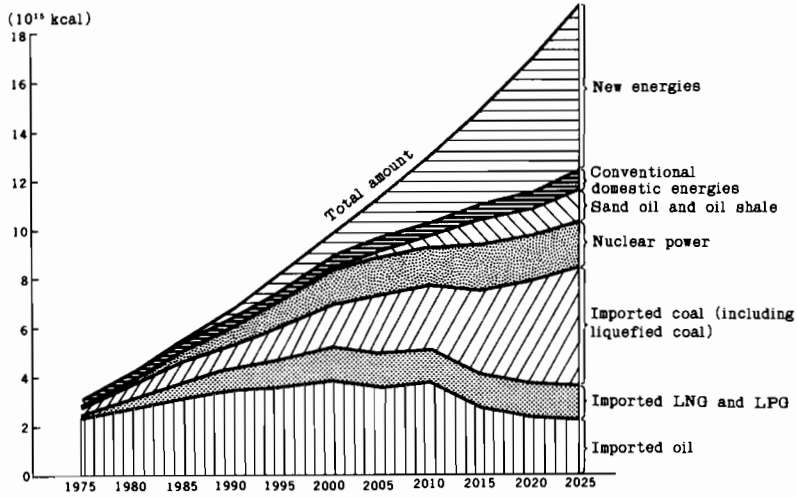

Fig.8 Primary Energy Supply Growth (based on physical input)

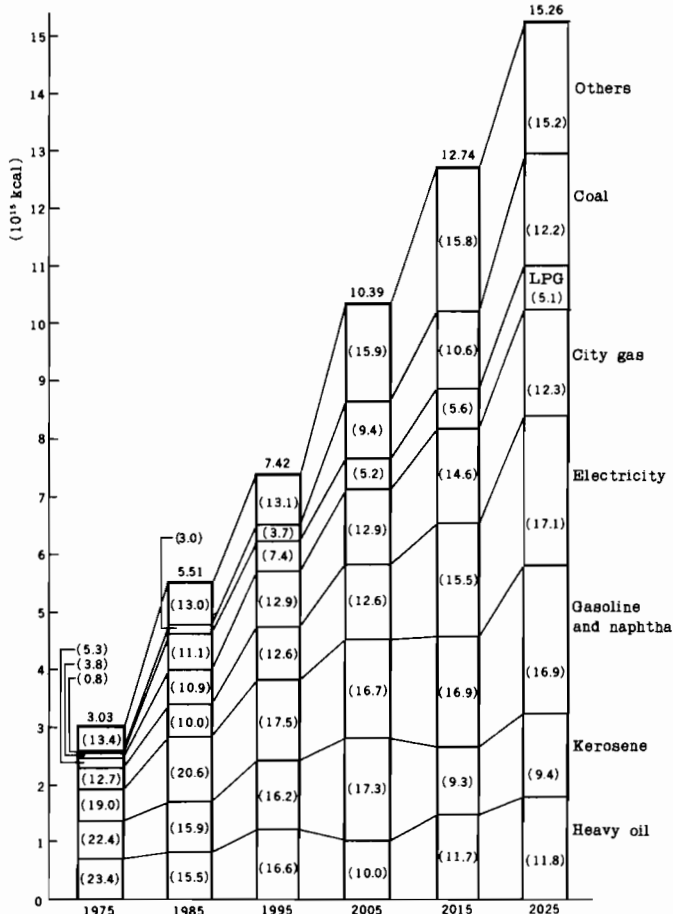

Fig.9 Energy Supply for End-use (Historical growth scenario)

## CONCLUSION

The models were originally developed in 1974. During the period of the past six years, data was updated repeatedly and the models were modified, and the results obtained were made public every year. They have been used to support a new governmental project of so called new energies. (i.e. Solar energy, oceanic energy, hydrogen, etc. excluding nuclear power.) Now the resources and techniques related to these new energies have been given more important roles than ever in the long term energy plan in Japan.

We believe the most distinguishing characteristic of this research lies in the data used. With respect to demand forecasting, data on residential use was based on a detailed analysis by type of use for period of more than ten years. We also investigated more than 500 processes to get information on characteristics of respective facilities. They involve average scale or capacity, efficiency, construction costs, time of construction, possibility of energy saving, coefficients of environmental pollutants, operating rates, sites, etc. In the case of the flow model, the volume of data used in a simulation exceeded 100,000.

Data is still being collected and various new scenarios are being tested. We expect to obtain more concrete analyses and useful suggestions for Japan's new energy policy in 1980.

# ENERGY SYSTEM MANAGEMENT BY COMPUTER AIDED ANALYSIS AND SYNTHESIS

**K. Schmitz and H. P. Schwefel**

*Kernforschungsanlage Jülich (KFA), Programmgruppe Systemforschung und  
Technologische Entwicklung (STE), Federal Republic of Germany*

## ABSTRACT

JES - The Jülich Energy Model System is presented. An important part of this system is LESS (Long Term Energy Simulation System), a dynamic energy simulation model. LESS and the supporting program packages IRECA (Interface for Regression and Correlation Analysis), DAIMOS (DATA Interface for Modular Simulation) and OASIS (Optimization And Simulation Integrated System) are described.

## KEYWORDS

Energy model, Simulation, Optimization, Systems analysis.

## INTRODUCTION

The present situation in the energy planning field is characterized by uncertainty, complexity, a large quantity of data which needs to be considered and the long-term nature. In many areas of politics and economics, precarious decisions have to be made when discussions and debates concerning the choice of future directions of the energy economy arise. One must recognise that the basic characteristics of energy planning mentioned above do make the formulation of adequate decision aids very difficult. There is therefore an increasing interest in the application of systems analysis in the energy field to overcome these difficulties. One aspect of systems analysis concentrates on the construction and development of computer-aided energy models and to date a large number of such models have been produced (Beaujean and Charpentier, 1978). It appears that systems analysis based investigations, particularly in the field of energy modelling, can yield improved approaches by virtue of their interdisciplinary nature which provides an integrated point of view for solving the energy planning problem.

## JES - THE JÜLICH ENERGY MODEL SYSTEM

At Jülich, STE has been engaged in developing energy models of the Federal Republic of Germany which can be regarded as tools for pursuing new ways in energy planning (Voss, 1977; Rath-Nagel, 1977; Schmitz and colleagues, 1977; Schöler and colleagues, 1978; Schmitz, 1979; Egberts, 1979).

Some of the principle claims in setting up these analyzing tools were:

- consistency and transparency  
which are necessary prerequisites for a rational discussion of various alternatives
- ease of handling and quickness  
to allow a more rapid decision making after the decision relevant data and parameters have changed
- a high degree of flexibility  
to be able to change the model structure, and to incorporate different methods from subroutine libraries which are available
- possibility of adjusting free parameters iteratively to meet given goals and constraints.

In Fig. 1 the Jülich Energy Model System with its different models and modules is represented schematically. These are

- a dynamic Linear Programming model (Egberts, 1979), a version of which is known as MARKAL and has been developed jointly at the Brookhaven National Laboratory (BNL) and the KFA. It optimizes the technology mix of the energy system, comprising all the important steps of production, conversion, transportation and distribution from primary to final or useful energy in various end use sectors,
- an economic impact model which will be based on the same ideas as the corresponding IIASA model (Kononov, 1976),
- microtechnological models of single technologies, e.g. solar and heat pump systems for space heating and warm water purposes, and finally
- a dynamic simulation model called LESS (Long Term Energy Simulation System) which will be described below.

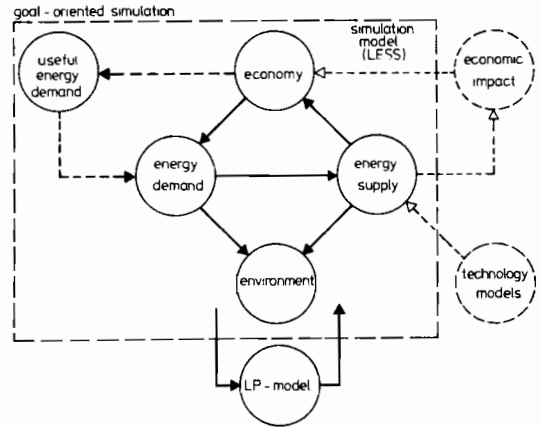

Fig. 1. Model Base of JES

#### LESS - LONG TERM ENERGY SIMULATION SYSTEM

Today LESS consists of four main modules for

- the macroeconomics,
- the final energy demand,
- the energy supply, and
- the environmental aspects.

Another module for the useful energy demand will be added in the near future. Now some aspects of useful energy are integrated within the final energy demand module.

The main goal in the development of LESS was the integrated mathematical formulation of the interdependencies between economic development, energy demand, energy supply and its economic impacts with the possibility of consistent and reproducible analyses.

The task of the macroeconomic module is to provide values for the economic growth

in the different areas of the economy, which are:

- the four defined industrial sectors (iron and steel production, chemical industry, stone, cement and clay industry, and other industries as a residual),
- the commercial sector, and
- the energy industry.

Furthermore for private households the disposable income as an economically determining factor for the energy demand is computed.

By means of these economic indicators within the energy demand module the final energy demand is calculated. This is done mainly by using regression and correlation techniques. As an output of these computations we obtain the final energy in the following sectors: the four industrial sectors mentioned, the transport sector with a subdivision into road, rail, water and air transport systems, the commercial branch, private households and the non-energetic consumption in the petrochemical industry. As a basis for these analyses, in some cases the useful energy demand is determined, e.g. space heating demand, goods or passenger transport volume, and iron and steel production in the steel industry. The energy demand module allows the simulation of energy saving by introducing energy saving measures, such as better insulation of buildings, and the implementation of decentralized technologies, for example, solar equipment and heat pump for warm water and space heating applications. Thus an assessment of decisions in this field can be simulated.

The energy supply module has the task of meeting the energy demand calculated by the energy demand module. It therefore accounts for the energy flows on the supply side, with its conversion capacities, transformation losses, imports, exports, stockpiling, indigenous mining, distribution losses etc. These are described by a set of simultaneous equations which are solved for every year. Within the energy supply module there is a power plant construction routine which computes the annual erection and decommissioning of the different types of electrical power plants required and the total installed capacity to meet the electricity demand for the calculated years. It is worth mentioning that the energy supply module allows for the simulation of different new energy supply technologies like coal gasification, coal liquefaction, hydrogen and methanol production etc.

The environmental module is an emission module which calculates the emissions of different types of pollutants due to energy consumption and energy conversion in the various sectors. Thus the emissions by sectors, by pollutants and the overall emissions can be derived.

#### OPERATION OF LESS (IRECA, DAIMOS, OASIS)

With the growing complexity of LESS and the enormous quantities of data to be handled, the software data management problems increased. To overcome these problems a special FORTRAN programmed package of tools has been developed to facilitate the construction testing and operation of LESS (Drepper and Hermes, 1979).

Figure 2 shows the data and software environment of LESS. These are

- the model base containing the above mentioned modules of LESS,
- the data base, and
- the software packages DAMOS, IRECA and OASIS.

Their application is not restricted to LESS and may be extended also to other large dynamic simulation systems (Drepper, Heckler and Schwefel, 1979).

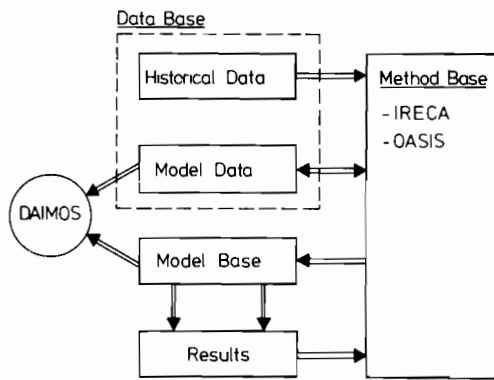

Fig. 2. LESS and its software and data environment

- IRECA is an interactive, dialogue-guided system for linear and nonlinear regression and correlation analysis for time series. It contains more than 50 different possibilities for the fitting of seven types of econometric models with one dependent variable and up to four parameters. An editing system and a processor for all binary arithmetic operations enable computer-independent handling of all input and output time series which need not be equidistant. An important feature within IRECA is the possibility of introducing assumptions in the estimations, i.e. assumptions about the values of coefficients within a hypothesis or assumptions which assign different weights to the input variable. In this way subjective assumptions of experts combined with the

objectivity of a mathematical estimation method allows a satisfactory description of a process.

- DAIMOS links several modules of LESS with each other and with their data base(s), thus allowing the formation and operation of the model exactly as required by the user for his specific purposes (Drepper, 1978). This system may be used for all those time-dependent simulation models which consist of linear and nonlinear sets of simultaneous equations as well as ordinary differential and integral equations. The time scheduling can be different for each module and the simultaneous equations can be scattered over all modules. The modular concept in modelling has, furthermore, the great advantage that each modeller can build and test his own module without being handicapped by changes in the programme caused by other users. The heart of DAIMOS is a preprocessor, which produces or modifies a so-called Global Variable Map (GVM) containing information about the type and the dimension of global variables. It corresponds with a blank common block generated by the preprocessor as well, thus assuring the interaction between the modules.

Figure 3 shows the preparation and execution steps for adding a new or altered module (MOD<sub>i</sub>) to the model system. The preprocessor corrects and extends the GVM and prepares the COMMON statements for the new module. After having compiled the source program, DAIMOS carries out the simulation taking care for the links between the modules, for the input of data from the data base as far as necessary, and for the time scheduling. The FORTRAN coded module itself contains the equations for one time step only. There are six sections to be distinguished by the modeller (see Fig. 4).

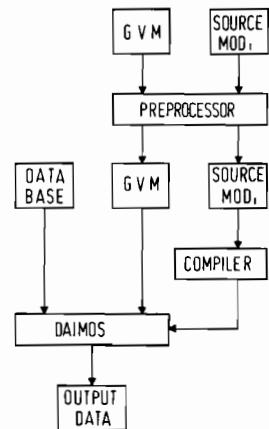

Fig. 3. DAIMOS and its preprocessor

Section 1 contains all kinds of initialization, section 6 all calculations to be done only once at the end of the simulation run. Sections 2 to 5 are evaluated at each time step, whereof Section 3 is the central part. It contains all those equations the parameters of which may be interchanged between the different modules and may be involved in sets

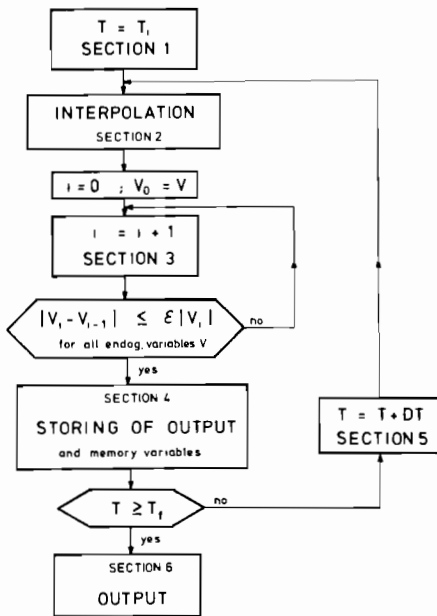

Fig. 4. The six sections of a module

of coupled equations. Here the sequence of statements need not be ordered because of the iterative procedure DAIMOS uses to solve the equations. Depending on the strength of the coupling, one of two methods which are at our disposal may be selected. In order to be able to reduce effort which is necessary for the iterations, the Sections 2 and 4 have been introduced. Here those items may be calculated which must be known before solving the equations and those items which make use of variables being involved in Section 3 respectively. The interpolation of exogenous input variables is done before entering Section 2 and the storing of output variables after Section 4. So Section 5 remains for integrations and differentiations which connect two consecutive time steps with one another. The output dialogue finally follows after Section 6. Here tabular and print plot output of selected time series may be done as well as a complete output of all endogenous variables in the same format as is used for items in the data base.

- OASIS contains all important derivative-free parameter optimization techniques as described and tested by Schwefel (1977) which can be superimposed on the DAIMOS guided simulation model (Heckler and Schwefel, 1978). No changes are necessary within the model itself. The variables to be changed are given to the optimization techniques by name and can even be individual items of time series. The same holds for the objective function and the constraints to be incorporated. The starting point given does not have to be feasible and during a search for a maximum or minimum the optimization method used can be changed interactively. There are two ways of combining a simulation model, e.g. LESS, with OASIS:

- Simulation within the optimization, which has already been achieved.
- Optimization within the simulation, a technique which will be available in the near future.

Normally the second way does not lead to an overall optimum, because optimization at certain time steps does not necessarily lead to a global optimum over the full time range. Therefore the first way will be preferred.

IRECA, DAIMOS and OASIS operate with identical input and output formats. Thus they form a coupled system working with the same data bases. The three interfaces are programmed in FORTRAN, so that LESS, or any other simulation model, has to be written in FORTRAN too. The advantage is an easy transportability from one computer to another and the possibility that a model builder may call on all available library subroutines and is therefore no longer restricted to special subsets of numerical algorithms.

## CONCLUSIONS

The above described techniques of simulation, optimization and analysis, are now based on the threefold system.

- IRECA : answering questions such as: "How are system variables interlinked with each other?"  
(systems analysis)
- LESS/DAIMOS : answering questions such as: "What will happen, if ....?"  
(systems simulation)
- LESS/OASIS : answering questions such as "By what action can a given goal be reached?"  
(systems synthesis)

The transition from a merely simulation oriented analysis to an optimization of simulation models can be seen as a step from systems analysis and systems simulation to systems synthesis. It is clear that this latter way of investigation needs an active participation of decision makers in the sense that goals must be formulated. The passive role characterized by looking at a system when asking "What happens, if ....?" is not longer sufficient and must be supplemented by the normative way. Both ways together allow answers to be given to a broad range of different questions concerning alternative energy strategies for the future with one single model.

Using the tools described above at their best, would be done by asking for those decisions which have to be taken now for certain, and those which could be delayed, in order to avoid unrepairable mistakes.

## REFERENCES

- Beaujean, J.M. and J.P. Charpentier (1978). A Review of Energy Models, No. 4, RR-78-12. International Institute for Applied Systems Analysis, Laxenburg, Austria.
- Drepper, F. (1978). A data-model interface for modular dynamic simulation. Proceedings of the Winter Simulation Conference, Miami Beach, Florida.
- Drepper, F., R. Heckler and H.P. Schwefel (1979). Ein integriertes System von Schätzverfahren, Simulations- und Optimierungstechniken zur rechnergestützten Langfristplanung. Jahrestagung der Gesellschaft für Informatik, Bonn, FRG.
- Drepper, F. and U. Hermes (1979). IRECA - Interface for Regression and Correlation Analysis, Benutzerhandbuch. Interner Bericht, Kernforschungsanlage Jülich, Jülich, FRG.
- Egberts, G. (1979). MARKAL, A Multiperiod Linear Optimization Model of the Energy Supply. To be published.
- Heckler, R. and H.P. Schwefel (1978). Superposing direct search methods for parameter optimization onto dynamic simulation models. Proceedings of the Winter Simulation Conference, Miami Beach, Florida.
- Kononov, Y. (1976). Modelling the Influence of Energy Development on Different Branches of the National Economy, RR-76-11. International Institute for Applied Systems Analysis, Laxenburg, Austria.
- Schöler, U. and colleagues (1978). A Dynamic Energy Model for the Countries of the European Communities. Commission of the European Communities, EUR 5953 EN, Brussels-Luxembourg.
- Rath-Nagel, St. (1977). Alternative Entwicklungsmöglichkeiten der Energiewirtschaft in der BRD, ISR 28. Birkhäuser Verlag, Basel, Boston und Stuttgart.
- Schmitz, K. and colleagues (1977). Die Entwicklungsmöglichkeiten der Energiewirtschaft in der Bundesrepublik Deutschland - Untersuchung mit Hilfe eines



- dynamischen Simulationsmodells, Jül-Spez-1. Kernforschungsanlage Jülich GmbH, Jülich, FRG.
- Schmitz, K. (1979). Langfristplanung in der Energiewirtschaft, ISR 65. Birkhaeuser Verlag, Basel, Boston und Stuttgart.
- Schwefel, H.P. (1977). Numerische Optimierung von Computer-Modellen mittels der Evolutionsstrategie, ISR 26. Birkhaeuser Verlag, Basel, Boston und Stuttgart.
- Voss, A. (1977). Ansätze zur Gesamtanalyse des Systems Mensch-Energie-Umwelt, ISR 30. Birkhaeuser Verlag, Basel, Boston und Stuttgart.



# ENERGY MODELS IN MEXICO

**E. Barriga and G. Bazán**

*Rio Rhin No. 22 - 3er. piso, México 5, D.F., Mexico*

## ABSTRACT

This work has a purpose to release every work about energy modeling that have been taking place in Mexico mentioning briefly what it consists on and the results. Finally it will discuss problems gained from having tried to implement this kind of systems.

## INTRODUCTION

The Mexican energy sector represents roughly 6% of the Gross Domestic Product and has been growing at a historical annual rate of 6.8%. Total energy demand for 1978 was  $713 \times 10^{12}$  Kcal and was distributed roughly in the following way: 26% industrial sector; 30% transportation sector; 8% residential and commercial sectors and 30% consumption by the energy sector itself, and the remaining to others such as agriculture, etc. Of this demand, 87% was supplied by oil and gas; 7.2% by hydroelectricity and geothermal\* and the remaining 5.07% by coal. These proportions have been almost constant during the last two decades, with a small increase in the participation of oil and gas due to the relative decrease in the participation of hydroelectricity.

In Mexico, nationalized enterprises are responsible of energy supply. While Petróleos Mexicanos provides hydrocarbons, and Comisión Federal de Electricidad electricity, both of them are coordinated and supervised by Secretaría de Patrimonio y Fomento Industrial. Mainly these enterprises have worked on developing models to the energy sector. The most important goal of this paper is to show all the efforts that have been done on this field, briefly describing the systems and works generated, particularly those general systems use to determine energy consumption in Mexico.

---

\* Considered at 3074 Kcal/KWH

### Development of the Energy Sector

Energy supply in Mexico is the responsibility of government owned enterprises. Under the present organization scheme of the public administration the responsibility to coordinate and supervise the energy supply is an important faculty of Secretaría de Patrimonio y Fomento Industrial.

The oil industry was nationalized in 1938 by integrating the foreign owned oil private enterprises into the recently created Petr6leos Mexicanos (Pemex), which became one of the largest oil industries in the world. Actually Pemex is the most important industry in the country, it is organized as an integrated industry, covering all the aspects from exploration to production, refining and distribution of products, including primary petrochemicals.

In 1978, Pemex processed 485.3 million barrels of crude, condensates and gas liquids and produced 2,561.4 million cubic feet of gas per day. Of its total production of crude and liquids, 365,000 barrels per day were for exportation.

Comisi6n Federal de Electricidad (CFE) is the single electric utility in the country. It was established in 1937 as a small utility to promote the electrification of those regions of the country that were not economically attractive for the private utilities. In the early 1960's the private utilities were purchased by the Government and integrated into CFE. In 1978, the total installed capacity was 13,992 MW out of which 5,225 MW came from hydroelectric plants. In that year some 8.6 million consumers were connected, being approximately 26,000 of the industrial category. Electricity generated in that year was 55 TWH.

The Comisi6n Nacional de Energfa At6mica was established in January 1979, in order to coordinate the two nuclear entities that were established at the same time: Uranio Mexicano (Uramex), responsible for exploration, mining and milling of uranium, and the Instituto Nacional de Investigaciones Nucleares (ININ) responsible for research and development work in the nuclear field, as well as for the promotion of the peaceful uses of atomic energy.

Mexico does not have an integrated coal industry. Actually coal is mined essentially by the steel industry which is both government and private owned through a concession system administered by Secretaria de Patrimonio y Fomento Industrial.

The Energy Commission was established in February 1973, as a mechanism to assist in the coordination of the energy sector. Its main objective is to analyze and propose long range energy policies on the basis of the knowledge available about primary resources within the overall economic framework defined by the government.

This Commission is also a forum to deal with matters common to Pemex, CFE, and the nuclear institutions.

With respect to the renewable energy systems, research and development is carried out essentially by academic institutions but operating without a coordinating group to these activities.

## BACKGROUND

The first serious efforts of modelling in Mexico were developed at the end of the 1960's with the support of the World Bank (previously there were not important works in this field). During that time and with Alan Manne's participation, the so-called INTERCON model was developed. This is a multi-region model using the integer programming technique in order to determine those investments to electricity. Also the "Modelo Energéticos" was developed analyzing the interdependence among three main sectors: oil, electricity and steel<sup>1/</sup>.

## MODELS PERFORM IN MEXICO

At first we will mention those studies in energy in a general way that have been carried out in Mexico, by briefly explaining their goals, description of the system, period, technique and the range or value obtained from demand studies (Table 1). It is important to mention that there is a great interest in Mexico on this field and because of that, several models are being developed not only in energy but also related to the national economy. From the latter, Secretaría de Hacienda y Crédito Público, Secretaría de Patrimonio y Fomento Industrial, Banco de México, Oficina de Asesores del Presidente and Pemex are working seriously.

### Oil Sector

The institutions that have performed modelling works on this sector are Petróleos Mexicanos, Secretaría de Patrimonio y Fomento Industrial and Instituto Mexicano del Petróleo.

We will briefly describe the modeling systems of Pemex because in the energy planning field this institution is considered to have the most important works. Pemex has developed three different systems such as INTERCON, Mod-Pemex and Plan Pemex.

INTERCON is a linking model designed to coordinate all planning aspects of CFE and Pemex, because both enterprises have been working in models separately. Actually CFE was planning its expansion based on current prices of industrial fuels (fuel oil and natural gas) without considering Pemex, the natural supplier of those fuels. In 1975 with this model, the transaction prices of both enterprises were the result of a simultaneous optimization.

With respect to "Plan Pemex", this model is a mathematical representation of production and distribution of hydrocarbons in Mexico being a system of 2500 equations and 4500 variables.

On the other hand, "Mod-Pemex" is a dynamic model designed to analyze those activities performed by the oil industry. It has a bounded horizon of planning and it represents Pemex's growth in the time, taking in consideration the geographical location. The basic objective of this model is to choose a plan for

---

<sup>1/</sup> "Multi-Level Planning Case Studies in Mexico", published by Louis M. Goreaux and Alan S. Manne, North-Holland/American Elsevier.

any future facility of the energy sector required to supply oil and petrochemical products. In order of accomplishing this objective, the current minimal value of the expenditure is estimated<sup>2/</sup>.

#### Electric Sector

On the electric sector it is important to mention that there is a great experience and CFE has been working many years on these systems. After Alan Manne's work, CFE and Electricité de France worked together to design models of integrated planning for power electric systems. The scheme of planning had the purpose of minimizing the expected investments and operational costs, actualized and subject to the usual technical and economic limitations of any important interconnected system with thermal and hydraulic losses<sup>3/</sup>. An important model designed by CFE is the so-called "MNI". This model determines long term policy development to generation equipment. This system minimizes current investments and the expected generation costs and faults, actualized to a given rate over several decades. Those projected prices of equipment and fuel are used as deterministic data. The dynamic and non-linear structure of the problem is described through an algorithm of the best estochastic non-linear control.

---

<sup>2/</sup> For more available information about these models of the oil sector see "Mod-Pemex" and "Plan Pemex", published by Unidad de Informática, Petróleos Mexicanos, January 1971.

<sup>3/</sup> Concerning a complete description of these systems see: "Método de Planeación Integrada para Sistemas Eléctricos de Potencia", published by Gerencia General de Planeación y Programa, Comisión Federal de Electricidad, México 1975.

TABLE 1 Demand Studies of Total Energy in Mexico Elaborated by National Institutions

Studies	Objective	Description of the System	Horizon	Technique	Value and range obtained from long term demand studies for the year 2000 (Kcal x 10 <sup>12</sup> )
Comisión de Energéticos WAES Study	Forecasting energy demand for the year 2000.	Elaboration of four scenarios, considering economic growth, energy prices, main substitution fuels, governmental attitude and population growth. For each sector the difference between fossil fuel consumption and electricity was considered.	1972-1985 1985-2000	Construction of scenarios for the year 1985 and the year 2000.	2 975 - 3 855
Comisión de Energéticos "Modelo Conjuntos"	Forecasting structure of energy demand.	An extrapolated model was used.	1975-2000	It is a dynamic exponential model with an adjust through minimal squares. The function is optimized through an iterative system.	3 500
Brookhaven National Laboratory	This model was constructed to evaluate different energy policies, besides the effects of	BESOM model cluster- ed those quantified qualities of the energy system, such as technical efficiency, emissions, costs,	1975-1985	This is a linear programming model based on RES system (Reference Energy System). This system concerns to the graph-	1 100 - 1 300 to year 1985.

Studies	Objective	Description of the System	Horizon	Technique	Value and range obtained from long term demand studies for the year 2000 (Kcal x 10 <sup>12</sup> )
	introducing new energy generation technologies of transformation technologies to these policies.	structure of electricity charges.		ical flow description and energy conversion that deals with those technologies of reference.	
Instituto Mexicano del Petróleo	To analyze and forecast energy demand in a sectorial way and by product.	An analysis of historical consumption at a sectorial level and by energy sources. It is also a correlation model about energy demand and an economic variable. For the forecast of energy demand it was related to several variables of economical activity, such as GDP.	1976-1995	Different ways (direct and indirect) were used to collect historical data. Hypothesis of economical growth were taken in forecasting.	2 193 for 1995; following its methodology for the year 2000 the value 3 075 is obtained.
Petróleos Mexicanos, Oficina de Coordinación y Estudios Técnicos	To forecast energy demand in the long term.	Medium-run forecastings of IMP model were used. Later, energy demand was correlated to GDP. This was developed for petroleum products. With respect	1974-2000	Regression and correlation analysis.	3 023 - 3 625



Studies	Objective	Description of the System	Horizon	Technique	Value and range obtained from long term demand studies for the year 2000 (Kcal x 10 <sup>12</sup> )
Centro de Investigación y Docencia Económicas	Forecasting energy demand with a continuous dynamic model in the sense that the variation of the main parameters were generated through the model structure itself.	to electricity, the data of CFE was used. This system is formed by 3 subsystems: economic, demand and units conversion.	1976-2000	- Correlation and regression - Systems analyses with scenarios - A simulation model	3 412
Comisión de Tarifas de Electricidad y Gas	Energy production forecasting for the year 1990.	Historical analysis of population and the relationship population-labor has changed, and its influence in energy demand. Therefore some goals of employment are established and with these goals an energy forecast could be done.	1976-1990	Normative and regression analysis.	1 280 for 1990; following this method this value reaches 3 500 in the year 2000.
Instituto de Investigaciones Eléctricas	To know the different participation of primary	Energy market behaviour and those trends of different energy	1976-2000	Single logistical model. It was originally developed to	3 300 - 3 400

Studies	Objective	Description of the System	Horizon	Technique	Value and range obtained from long term demand studies for the year 2000 (Kcal x 10 <sup>12</sup> )
cas - UAM (Ixtapalapa)	energy in supplying energy in the long-run.	products were analyzed.		describe technical substitution process.	
Subgrupo de Demanda, Grupo de Política Energética	Forecast energy demand for the year 1985.	Energy demand behaviour was related in function of the economic activity. It is assumed that economic growth is very related to energy demand, considering that endogenous, or explicative variables do not absorb instantaneous-ly the impact that among them the observed or induced changes by the explicative variables produced.	1977-1985	Model with gradual delays, also known as "Dynamic Model".	Those values obtained are for the year 1985. These are presented in a "spread" way depending on those assumptions related to GDP. With an 8.8% GDP rate growth, the value of demand was of 1 248; with 7.7%, demand reaches 1 160 and with 6.4% it reaches 1 042.

# ISSUES IN MODELLING ASPECTS OF THE GREEK ENERGY PROBLEM

**J.-E. Samouilidis**

*Chair for Industrial Management, National Technical University of Athens,  
28is Oktovriou 42, Athens, Greece*

## ABSTRACT

This paper highlights the main aspects of the Greek energy problem and reviews the current state of the research effort undertaken in order to model these aspects. An energy policy model is under development, which can be used to access the impact of energy policies on the economy, in a long term perspective. The model includes four submodels: an energy demand model; an energy-economy model; an energy system model; and an economic growth model. The paper presents the structure of the energy policy model and gives some details on the energy-economy and the energy system models.

## KEYWORDS

Energy modelling; energy-economy interaction; energy system model; linear programming; energy policy.

## INTRODUCTION

The Greek energy problem, though not basically different from that of many other countries, has its own peculiarities. These are mainly due to the development stage of the economy, which is somewhere between the post-industrial societies and the developing agricultural economies. The income elasticity of energy demand has been very high in the last twenty years, due to the rapid industrialisation process; and prospects are not optimistic, given that the industrial sector, and in particular the high-energy-intensity industries, are expected to be the leading growth sectors of the economy. On the other hand, increasing oil prices are exercising a heavy pressure on the already sensitive balance of payments, in an economy which is roughly 70% dependent on foreign sources of energy supply. Development of indigenous resources, like lignite oil and natural gas, though expected to relieve existing pressures, is tied to high capital expenditure, which is also required for industrial expansion.

A modelling effort, centered around the above aspects, has been undertaken at the Chair for Industrial Management of the National Technical University of Athens. The aim of the work, which is still ongoing, is to develop an *Energy Policy Model-GREPOM*, intended to give a better understanding of the interrelationship among the factors that are shaping the energy policy formulation.

This paper reports on the present stage of the work, giving an overview of the model structure and describing with some details two of the model components. The text of the paper is organized in seven sections. This introductory section is followed by a presentation of the main aspects of the Greek energy problem, and the structure of the energy policy model. In the following sections, the energy system model and the energy-economy models are summarized, and some results of the latter are commented. Concluding remarks close the paper.

#### ASPECTS OF THE GREEK ENERGY PROBLEM

The Greek economy has been a fast growing economy for the last twenty five years. The per capita gross national product has overtripled during that period and reached the level of 3500 \$, at current prices, in 1978, which corresponds to 50% of the average income per capita in the European Community. This development process was accompanied, as one could expect, by considerable structural changes in the economy, which were particularly reflected in two ratios: (1) the ratio of the product of the industrial sector to the GDP, which has gone up from 14 % (1958) to 22 % (1977); (2) the ratio of all energy intensive industries to the product of the industrial sector, which has also increased by 50 % in the last twenty years.

Despite the high degree of uncertainty which is characteristic of future growth, government plans indicate that the country's growth rate should, and could, be higher than the expected average in the European Community. It is forecasted, and also intended, that industry will be the leading growth sector, with particular emphasis given to some metal extracting and processing industries, which could thus contribute to a higher utilization rate of indigenous natural resources.

As a result of the above, it is more than obvious, that energy should be a factor of primary consideration in all economic development plans. It could be argued, that the role of energy in economic growth is more critical in the Greek economy, than is the case with the developed economies in which the composition of the GDP will remain either constant, or even change in favour of the service sector.

Following the trends which were observed in the GDP, energy demand in the Greek economy has been growing with high rates, in the last twenty five years. Average annual rates were in the range of 10-12 % before 1973 and decreased to 8-10 % thereafter. In 1978, energy consumption reached at 1.5 tons of oil equivalent per capita, which is still very low when compared to the corresponding figure in the U.S. or the E.C. Income elasticity of demand has remained in the past rather stable on a level which is characteristic of developing economies, ie 1.5-1.6.

Total expenditure for energy, which amounted to only 5 % of the GDP in 1965, reached 9 % in 1973 and overpassed the 10 % level in 1976. This overdoubling in the energy contribution to GDP is due both to an increase of the energy use per unit of product and to an increase of the energy prices. In relation to the total expenditure for energy, it must also be pointed out that 90 % of it represents foreignexchange payments. Thus expenditure for imported energy which was only 90 million US \$ in 1966, reached the level of 1.3 billion in 1978. This last figure corresponds to 20 % of the value of imported goods.

The share of the various carriers of primary energy has been gradually changing, in favour of indigenous natural resources. Today oil accounts for 70 %, coal --mainly lignite-- for 26 %, and hydroenergy for 4 % of total primary energy consumption. Significant changes, have taken place in the final energy side. Thus the share of electricity has increased from 27 % in 1965 to 35 % in 1978. At the same period the share of lignite in electricity generation has gone up from 44 % to 58 %. Natural gas is not used today in the Greek energy system.

Considerable changes have also occurred in the structure of energy demand. In 1978, the industry's share was roughly 45 %, transportation accounted for 24 %, the rest 33 % having been covered by domestic and miscellaneous users.

The country's main energy resources, under exploitation today, are lignite and hydroenergy. Known lignite reserves are estimated at 5.500 million tons of low calorific value fuel.

Hydroenergy potential is estimated at 20.000 GWh, out of which 19 % is now under utilization. There is no production of oil and gas, at present. Oil and associated gas reserves were discovered in Northern Greece. Oil and gas production, planned to begin in 2 years, will reach a peak, which is equivalent of 12 % of current demand for oil. Major exploration activities are underway in various parts of the country for hydrocarbons, uranium and geothermal energy. Indicative results seem promising.

Major structural decisions for the Greek energy system are today: (1) The introduction of natural gas; negotiations are on the way with the major gas suppliers. (2) The use of nuclear technology for electricity generation; it is expected that the first nuclear power station of 600-800 MW will be in operation at the end of the 1980's; two or three units of similar size will follow in the next decade. (3) The utilization of very poor lignite deposits to be burnt in thermal power stations.

#### THE ENERGY POLICY MODEL

The *Energy Policy Model*, actually a set of models, provides a tool for the analysis of energy policies, which can be used to assess the impact of these policies on the Greek economy, in a long term perspective. The model includes four (sub) models, each being in a different stage of development: an energy demand model, already operative; an energy-economy model, in the stage of result evaluation; an energy system model, in the final stage of formulation; and an economic growth model, in the stage of conception.

The model, which is shown in Fig. 1, presents some conceptual similarities with the set of energy models at the International Institute of Applied Systems Analysis, as described by Häfele and Basile (1978). Three growth parameters are in use at this stage: gross national product, the participation of industry in GNP, and the participation of energy intensive industry in the product of the industrial sector. The latter two, having proved to be decisive factors influencing energy demand, are in continuous change in the Greek economy, unlike the stability which they have shown in the post-industrial economies. These growth parameters are combined with the exogenous crude oil prices to generate scenarios, which drive an energy demand model.

The *Energy Demand Model* is based on a combined econometric and optimization approach, as described by Samoulidis and Pappas (1979). A set of classical econometric models is used to forecast energy demand for each one of the twenty sectors of the economy, based on historical data. These forecasts are fed into a goal programming model, which functions as an "information integrator". Besides the econometric models, the goal programming model retrieves also information from other sources such as: government reports on energy policy objectives; feasibility reports on new uses of energy; and the forecaster's judgemental analysis. All these pieces of information are integrated by the goal programming model, to provide a set of consistent energy demand forecasts.

1) These forecasts are, however, open loop forecasts in the sense that they are based on the assumption of zero energy-economy interaction. Thus they are revised to take into consideration the existing interaction between the economic and the energy systems. The revision is performed through a very simple *Energy-Economy Model*, based on a conceptual framework described by Sweeney (1978). This model is summarized in the following section.

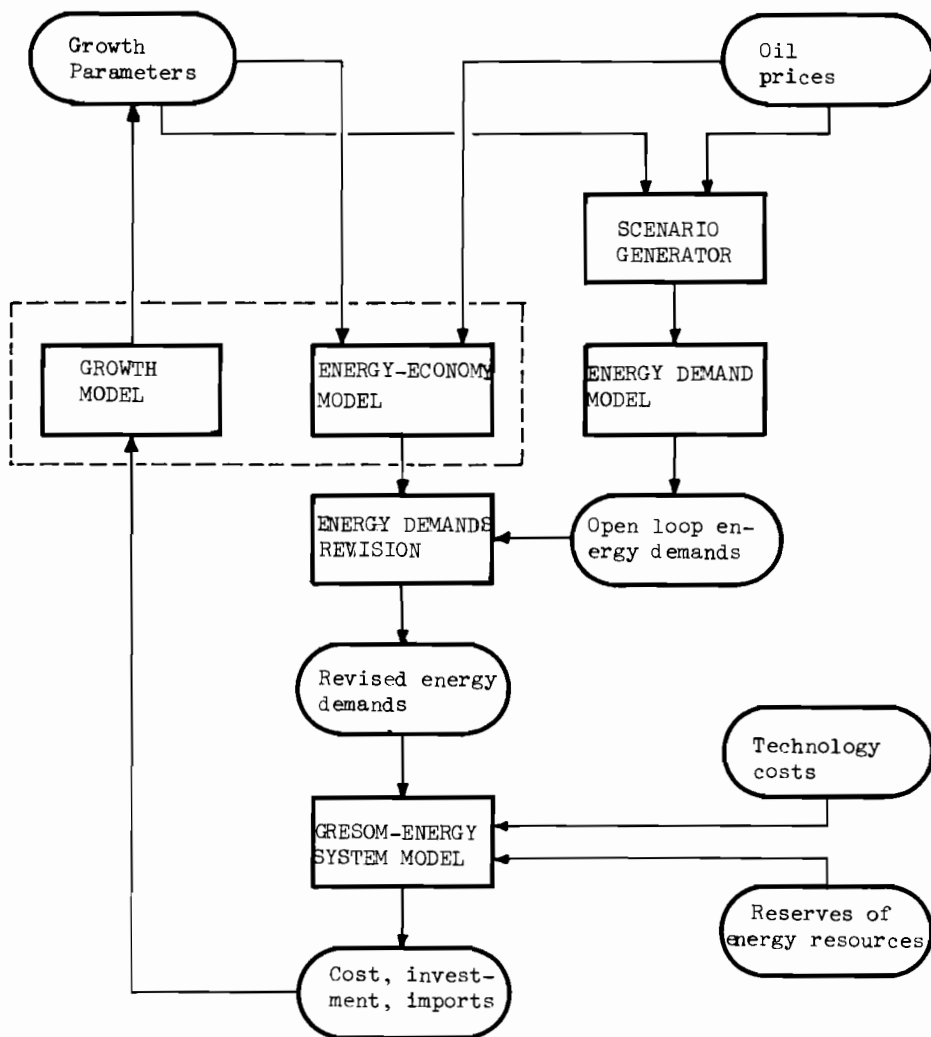

Fig. 1 The Structure of the Energy Policy Model

The revised energy demands are inputs to the *Greek Energy System Optimization Model - GRESOM*, a linear programming model, describing the structure and operation of the energy system. A brief presentation is given in one of the following paragraphs of this paper. The model determines, among others investment requirement, energy costs, energy imports for the optimal energy strategies. All these variables are used as inputs to a *Growth Model*, describing the economic growth process. This model is still in the early conception stage, so that very little can be said on it. The idea is to use a control theory approach and link this model to the energy-economy model.

#### THE ENERGY-ECONOMY SIMPLIFIED MODEL.

This is a very simple model along the lines developed by Sweeney at the Energy Modeling Forum of Stanford University (1978), as previously mentioned. The model, as used here, addresses itself to the impact that sudden changes in energy price will have on aggregate output, measured by the net national product.

The economy is viewed as consisting of three sectors: an energy importing sector, a domestic energy producing sector, and the rest of the economy. Such an economy uses as inputs: a quantity of capital services, a quantity of labour services, a quantity of imported energy, and a quantity of domestically produced energy. This economy can be represented by a set of equations including: an equation that defines net national product in terms of the quantities and prices of the basic inputs; equations that represent marginal conditions, describing a competitive economy in equilibrium, and stating that prices equal the corresponding marginal productivities.

Under a set of simplifying assumptions about a perfectly inelastic supply of capital and labour, and assuming that all energy is imported and that energy demand follows a constant elasticity function, the following two equations can be deduced:

$$(1) \quad \frac{dY}{dP} = -E$$

$$(2) \quad E = A Y^n P^{-\epsilon}$$

where

Y : net national product (NNP),  
P : price of energy,  
E : quantity of energy consumed,  
n : income elasticity of demand for energy,  
 $\epsilon$  : price elasticity of demand for energy,  
A : constant.

By solving differential equation (1) and using equation (2), we get expressions for NNP and energy containing the price of energy as the single independent variable:

$$(3) \quad Y = \left[ Y_0^{1-n} + \frac{A(1-n)}{1-\epsilon} (P_0^{1-\epsilon} - P^{1-\epsilon}) \right]^{1/1-n}$$

$$(4) \quad E = A \left[ Y_0^{1-n} + \frac{A(1-n)}{1-\epsilon} (P_0^{1-\epsilon} - P^{1-\epsilon}) \right]^{n/1-n} P^{-\epsilon}$$

where the subscript "o" denotes values of the variables in the year in question under a regime of stable energy prices; ie this subscript refers to the base case, according to the terminology used by Hogan and Manne (1977).

#### THE ENERGY SYSTEM MODEL

The energy system model, described in this section, follows the already established tradition of using linear programming to represent the energy system.

The planning horizon of the model covers a 35-year period starting in 1980 and ending in 2015. The planning horizon is divided into four periods 1980-85; 1985-90; 1990-2000; 2000-2015; thus giving the LP model a dynamic structure. We are primarily concerned with the system structure in the first three periods, the fourth period playing the role of a "buffer". The variables of the model are expressed in period averages of annual quantities.

There are two types of decision variables in the model. *The strategic or structural* variables represent new capacity or expansion of existing capacity in the energy system: eg electricity generating capacity, refinery capacity, gas pipeline capacity, or distribution network capacity. These variables are associated with investment costs. *The tactical or operational* variables represent how the capacity of the various installations is utilized; eg electrical energy produced, diesel oil produced, natural gas transported or distributed etc. These variables are associated with operation costs.

The model constraints are structured in five modules: the electricity module; the oil module; the coal module; the natural gas module; and the energy demand module.

The model considers three alternative objective functions, which can be either used one at a time in the simple LP versions of the model, or might be used simultaneously in a goal programming version.

One of the objective functions represents total cost extending over the planning horizon. Total cost for meeting the demand in energy is analysed in two components: investment cost, which is expressed as a linear function of the strategic variables of the model; operation cost, which is expressed as a linear function of the tactical variables of the model. All costs, incurring during the course of the planning horizon, are discounted to a present value. Residual values of equipment are also taken into consideration.

The two other objective functions to be also minimized express respectively: the quantity of primary energy consumed; the quantity of imported energy.

#### SOME RESULTS

This paragraph includes a sample of the results given by the energy-economy simplified model. Table 1 gives NNP and energy for various price increases, in the year 2000.

In the first column of Table 1, energy prices are presented as compared to prices of a reference year—which is 1970. In the second column, NNP in the year 2000 is compared to the NNP of the same year under a regime of stable prices; thus  $N_0$  is the base case net national product. Thus doubling of the energy prices would decrease the NNP by 10 %. In the third column, the "open loop energy" ( $E_A$ ) is compared to the base case energy  $E_0$ .  $E_A$  is the energy calculated by equation (2), in which NNP is assumed not affected by price changes; ie in  $E_A$  only price induced



energy reduction is considered. In the fourth column, the "closed loop energy" ( $E_c$ ) is compared to the base case energy. The closed loop energy is affected by changes in both the price of energy and the net national product.

TABLE 1      Impact of Energy Price Increases on  
Net National Product and Energy Demand - Year 2000.

$P/P_0$	$Y/Y_0$	$E_A/E_0$	$E_c/E_0$
1.00	1.00	1.00	1.00
1.50	0.94	0.82	0.74
2.00	0.89	0.71	0.59
3.00	0.82	0.58	0.43
4.00	0.76	0.50	0.33
5.00	0.72	0.45	0.27
6.00	0.68	0.41	0.23

All calculations are based on: income elasticity,  $n=1.5$ ;  
and price elasticity,  $\epsilon = -0.5$

Table 2 below reproduces results similar to Table 1, but for a given price increase and for various values of the price elasticity of demand.

TABLE 2      Impact of the Price Elasticity of Demand on  
Net National Product and Energy Demand - Year 2000.

$-\epsilon$	$Y/Y_0$	$E_A/E_0$	$E_c/E_0$
0.1	0.78	0.89	0.61
0.3	0.80	0.72	0.51
0.5	0.82	0.58	0.43
0.7	0.84	0.46	0.35

Calculations based on values of income elasticity,  $n=1.5$ ;  
energy price,  $P=3P_0$

As it could be expected higher price elasticities of demand produce greater energy reductions, but on the other hand tend to have a smaller impact on net national product. It is also shown that the percentage error one makes in energy demand estimation when ignoring the effect of the price induced changes of the NNP, becomes smaller with increasing price elasticity. Thus for  $\epsilon = -0.1$  the error is 41.2 %, and goes down to 30.1 % for  $\epsilon = -0.7$ .

Finally in Table 3, the impact of income elasticity of demand for energy on the above changes is indicated. It is shown that, the greater the income elasticity, the greater will be the impact of a given price increase on energy demand; but on the other hand the smaller will be the impact on net national product.

It can thus be concluded that, under the above mentioned assumptions, the impact of energy price increases on growth would tend to be slightly smaller in developing economies, than in industrialised economies.

TABLE 3 Impact of Income Elasticity of Demand on  
Net National Product and Energy Demand - Year 2000

P/P <sub>0</sub>	Income elasticity=1.0		Income elasticity=1.5	
	Y/Y <sub>0</sub>	E <sub>c</sub> /E <sub>0</sub>	Y/Y <sub>0</sub>	E <sub>c</sub> /E <sub>0</sub>
1.00	1.00	1.00	1.00	1.00
2.00	0.88	0.67	0.89	0.63
3.00	0.80	0.52	0.81	0.47
4.00	0.73	0.42	0.75	0.37
5.00	0.68	0.36	0.70	0.31
6.00	0.63	0.31	0.66	0.26

Calculations based on price elasticity of demand  $\epsilon = -0.4$

#### CONCLUDING REMARKS

This paper presented the present stage of the ongoing research work on energy modelling, at the Chair for Industrial Management of the National Technical University of Athens. The structure of an energy policy model was described, and some details of two of the component models were given.

Within the context of a simplified energy-economy model, an effort was made to analyse the impact of elasticities of demand, both price and income elasticities, on NNP and energy changes, caused by energy price increases. It has been confirmed that, higher price elasticities of demand produce greater energy reductions, for a given energy price increase; but on the other hand tend to have a smaller impact on the national product. Income elasticity of demand which is assumed equal to 1.0 for the industrialised economies, is higher for the developing economies, taking values as high as 1.6. It has been shown that for a given price increase, the greater the income elasticity, the greater will be the reduction of energy demand, but the smaller will be the reduction of the NNP. It should be noted, however, that NNP is not very sensitive to income elasticity changes, and relevant reductions tend to be very small. On the other hand energy seems to me more sensitive.

Given the complexity and the great uncertainty that are characteristic of the energy future, we are trying to keep our modelling effort modular and flexible as much as possible, so that quick answers are given to the ever arising questions. We also make an effort to develop models that are small and simple, capable of capturing the basic interrelationships between the main underlying factors. Not only because this is more appropriate for small countries, having at their disposal only limited modelling resources; but also because recent experience in advanced countries has indicated that small, well thought, models do not necessarily say less than big models (Energy Modeling Forum, 1977).

#### REFERENCES

- Energy Modeling Forum (1977). Energy and the Economy. EMF Report 1, Stanford University, Stanford, California.
- Häfele W., and P. Basile (1978). Modeling of long-range energy strategies with global perspective. In K.B. Haley (ed), OR'78. North Holland, Amsterdam.
- Hogan, W.W., and A.S. Manne (1977). Energy-Economy interactions: the fable of the elephant and the rabbit? In Energy and the Economy, EMF Report 1, Vol.2, Stanford University, Stanford California.

Samouilidis, J.E., and I.A. Pappas (1979). A goal programming approach to energy forecasting. Paper presented at EURO III, Amsterdam, April 1979.

Sweeney, J.L. (1978). Energy and economic growth: A conceptual framework. EMF, Occasional Paper 3.0., Stanford University, Stanford, California.



## *Session III*

### **PROBLEMS OF TECHNOLOGY ASSESSMENT, ENERGY SUPPLY AND USE**

•



# PLANNING AND ANALYSIS OF ENERGY RESEARCH AND DEVELOPMENT PROGRAMS

**K. C. Hoffman**

*MATHTECH, Inc., Princeton, New Jersey, USA*

## ABSTRACT

In response to higher prices and projected shortages of energy, particularly liquid fuels, many nations have launched large research and development programs. For maximum effectiveness, these programs must deal with new technologies for both the supply and utilization of energy--particularly liquid fuels--in a balanced way. While the outcome of research and development is, by definition, uncertain, it is necessary to plan national and international programs that are balanced and effective. The approaches to R&D planning and analysis vary according to the stage of a technology in the research development and commercialization cycle. This paper reviews analytical approaches to the planning and analysis of national and international energy research and development programs. Among the special topics discussed are the market-oriented, total energy system concept, the coupling of energy and economic models, and multi-objective analysis. The methods may also be employed by industrial groups involved in significant R&D investments and by government sponsors of energy R&D.

## KEYWORDS

Research and development; planning; assessment; modeling.

## INTRODUCTION

The management of an energy research, development, and demonstration program requires the explicit definition of a set of goals and objectives for technologies under development, and extremely close monitoring of progress in the R&D program towards meeting these goals and objectives. Strategic goals and objectives define the need for liquid fuels, electricity, and environmental controls consistent with a desired or projected pattern of economic development. Alternative supply and end-use technologies may be evaluated against these objectives by comparing their technical, economic, and environmental characteristics in terms of such parameters as efficiency of performance, reliability, maintainability, first cost and operating cost, and emissions to air and water. R&D priorities may be established by evaluating alternative systems in the context of projections of energy markets, as well as economic and environmental development. All of these factors, as well as the ultimate characteristics of the technology under development, are, of course, highly uncertain. These uncertainties and risks must be evaluated to the extent possible and factored into the R&D planning and analysis process.

The research, development, and demonstration cycle for a new technology includes the following steps:

1. Conceptual phase: definition of needs or requirements, or more likely, generation of new ideas or concepts;
2. Survey of applicable concepts;
3. Basic and applied research;
4. System development, demonstration, and commercialization.

It is important to note that following the initiation step, Step 1, which leads to the perception that a new technological concept can fulfill a need in the private or public sector, a selection process must occur, based on technical and/or economic factors. Up to the point of commercial or practical implementation, systems which are conceptually feasible may encounter technical, economic, or social barriers which either render them unacceptable for further development when considered alone, or when compared to alternatives which appear more viable as the R&D cycle proceeds.

In addition to the technical and economic analyses performed during the R&D cycle, energy technologies must be scrutinized within the overall energy system itself. This implies that a credible analysis must rely upon a basic reference (conventional) system to serve as a benchmark against which a new or advanced technology may be gauged in terms of technical, economic, and environmental attributes. Such comparisons can provide a required measure of consistency in terms of system costs, resource constraints, technology characteristics. A uniform set of assumptions regarding fuel prices, material costs, labor costs, and productivity, and inflation rates for the time frames of interest is necessary for such comparisons. These factors, which affect the economic viability of new technologies, may be taken as parameters permitting a series of sensitivity analyses to be performed regarding the assumptions used for R&D planning. All too often, new technologies are compared with other advanced concepts without ever addressing a comparison with conventional, well characterized, and perhaps superior alternatives. The following discussion deals with the topics to be addressed in R&D planning and analysis, criteria that may be applied in R&D assessments, and information needs for the management of R&D programs.

The questions to be addressed in R&D planning, and the analytical approaches to be used, vary considerably through the steps of the R&D cycle from the definition of requirements through research and development to commercialization.

#### CRITERIA FOR R&D ASSESSMENT

The criteria used to establish priorities among energy research and development options generally involve a complex mix of technical, economic, environmental, social, and institutional factors. The relative weights given to each of these factors are closely related to overall national objectives for security of resource supply, protection of the environment, and economic development. An energy R&D program must address these issues at the near, intermediate, and long term in a balanced way.

The technical options to be pursued in an R&D program are classified according to the time frame that they impact upon; and their contributions to the energy system over time may be analyzed. These options may also be classified according to their current stage of development, i.e., research, development, or demonstration. The criteria by which options are evaluated will vary according to this stage of development. The selection among promising options in the early development stage, where technical and economic characteristics are poorly defined, is quite different from that among candidates for large demonstration projects where a technological base has been established. The current stage of development of a given technology is closely correlated with the time frame in which it will impact, and thus, this



classification may be made with respect to either attribute.

The priorities established on the basis of these criteria are not necessarily related to the level at which a program is funded. There are several program elements that may show a very high priority rating but that simply do not require the same expenditure as a more complex technology having a much lower priority. The demonstration of a number of solar heating systems, for example, is much less costly than a single coal gasification plant. High priority options should be funded on the same basis to the extent permitted by budgetary constraints. When funding levels must be reduced below the level required to ensure successful development of all options, the lower priority options are either reduced to a minimum viable level, or dropped from the R&D plan entirely.

It is also misleading to determine priorities on the basis of energy provided (or saved) per dollar invested in R&D. The analysis must include cost savings attributable to implementation of the newly developed technology compared with the alternative technology that would have been used instead, as well as the cost of the R&D programs. For example, a technology requiring a larger R&D program may contribute fewer energy units, but at a significantly lower cost than the technology it replaces. Thus, this technology could have an advantage when all costs and savings were considered, but would look rather poor when compared on the quantity of energy delivered per dollar invested in R&D.

Conservation options must be considered in a similar fashion by accounting for energy saved, along with dollars invested in R&D and dollars invested in extra capital equipment associated with the conservation measure. Further, to estimate all of the benefits, any cost savings attributable to the effect of reallocating scarce resources released for other uses by the conservation technology should be accounted for.

Following is a summary of the criteria that apply among technical options at each of the stages of development. An overlaying set of criteria and evaluations apply to the assignment of priorities between the time frames; e.g., fusion compared with higher efficiency end-use devices. The problem of addressing the appropriate allocation of priorities between stages of development or time frames deals with the desire to resolve immediate problems as compared with the protection of future generations. There is no firm analytical basis for such comparisons and a research and development program must deal with these objectives in as balanced a way as possible.

#### Demonstration Projects to Impact in Near Term (to 1985)

The new technical options that will impact in the near term are those that are now in the advanced development and demonstration phase. The program objectives generally involve the demonstration of engineering and economic feasibility. Some of the projects in this category deal also with technologies that have been developed and are now being implemented, but with R&D problems that are constraining the rate of implementation of the technology. In this latter area, the R&D program should enhance the implementation of developed systems by removing barriers to public acceptance, providing the means of satisfying recent codes and standards, and providing an improved basis for the establishment of new codes and standards. Included in this area is research on reactor safety, environmental control technology, and biomedical effects of pollutants.

The technical and economic characteristics of near term technologies are generally well defined and are important criteria. The role of the technology in supporting current national objectives is of equal importance in this time frame. Clean energy systems, such as solar-storage combinations, must be developed and demonstrated despite the possibility of their having a higher current cost than conventional

options. Further, demonstration projects that are candidates for wider, near term implementation should be compatible with the existing energy infrastructure in order to make effective use of existing facilities.

In the evaluations performed on large projects approaching the latter stage of development, it is important to consider the economics of the system as well as the policy background. Such policies as peak load pricing of electricity, energy taxes, and subsidies have a strong influence on the market penetration of technologies. The influence of such policies on the economic competitiveness of new technologies must be understood. This understanding is necessary both from the viewpoint of judging the commercial viability of a system against known policies and from the viewpoint of estimating the policy actions necessary to bring a system into the market in order to exploit its potential environmental or fuel saving benefits. These considerations are especially pertinent to the solar options.

The availability of labor, materials, resources, and an industrial base to implement these technologies in the near term are very important. If these are projected to be available, then there almost certainly will be a sufficient base for the construction of demonstration facilities.

#### Development Projects to Impact in Intermediate Term (1985-2000)

Most technical options that will have an impact in the intermediate term are currently in the development phase. The technical and economic characteristics of these technologies are not well defined at their present state of development, hence they must offer some other potential advantages to be assigned a high priority. A R&D program must be designed to achieve the appropriate scientific and engineering basis for eventual demonstration and implementation, and to obtain an improved definition of the technical and economic characteristics of the technology. The objective of this work is primarily the demonstration of engineering feasibility.

The critical national objectives and attendant energy R&D objectives that will hold in this time frame are also less clear than in the near term. Uncertainties exist with regard to future trends of energy demands, the ultimate availability of domestic resources, and the need to address specific national needs. The R&D priorities have to be tested for sensitivity to these future developments. In view of the uncertainties that exist, the portion of the program directed at technologies in this category serves to increase the available options. This serves to remove the constraints that energy problems place on national economic and social objectives, and thereby broadens the feasible range of policy alternatives.

In this category, there is sufficient lead time to develop an appropriate manpower and industrial base for implementation, but the availability of R&D manpower at the present time may be limiting.

#### Research and Early Development, Impact in Long Term (2000 and Beyond)

Most basic research projects and some complex development programs fall into this category. The important criteria for basic research programs deal with the opportunities to add to basic knowledge and understanding of energy-related phenomena and the availability of researchers with sufficient background or experience to work effectively in the field. These may include people now in the field, or those that may transfer from other fields of research. This area of energy R&D must be supported to the extent with which funds can be effectively utilized and receives this priority because of its importance in providing the basis for future breakthroughs, and for technological supremacy of the nation. R&D also serves to generate options that will provide flexibility and protection against future risks or problems. In this regard, it is useful to consider potential risks or problems, such as a possi-

ble CO<sub>2</sub> catastrophe, that could dictate either a change in policy or the most aggressive pursuit of alternative technologies.

The complex development programs that may be implemented in this time frame must be judged against the promise that they hold as an abundant resource base, a clean form of energy, or any other special distinguishing characteristics. These criteria emphasize the requirement that long term programs must represent significantly different options from those in the near and intermediate term.

The uncertainties regarding energy requirements and availability and national needs, are much greater in this time frame than in earlier periods. Similarly, technical and economic characteristics are poorly defined. Programs in this category deal with proof of scientific feasibility. Formal analysis is not really relevant to the determination of priorities at this stage of research.

#### General Criteria for R&D Program Elements

Following, is a statement of general criteria applied to various program elements. Regardless of the time frame, *all development and demonstration projects* must consider these criteria:

- Environmental impacts of technology and related factors affecting public acceptability;
- Need for Federal support (related to work in the private sector);
- Probability of technological success;
- Cost of achieving R&D objective.

#### Near term demonstration projects must also evaluate:

- Projected level of implementation and contribution to energy requirements (special emphasis on substitution for, and conservation of, oil);
- Technical efficiency of process, including analysis of energy inputs to plant construction (net energy);
- Projected capital and operating cost of commercial size plant and economic benefits attributable to implementation;
- Compatibility with existing energy infrastructure;
- Adequacy of industrial base to support implementation and severity of any other barriers (legal-political);
- Adequacy of resource base to support the implementation (energy resources, water, other resources);
- Adequacy of manpower base to support the implementation (must communities be developed and people be relocated?);
- Adequacy of scientific and engineering base (is demonstration premature?).

#### General criteria that apply to intermediate term development programs are:

- Projected level of implementation and contribution to energy requirements (special emphasis on substitution for, and conservation of, oil);
- Availability of energy resources to support implementation and long term operation of commercial plants or devices based on this development program;

- Potential for broadening range of national policy options;
- Diversity that would be added to the energy system;
- Need for additional information on technical and economic characteristics;
- Availability of trained personnel to perform R&D.

Long term program elements (2000 and beyond) should assess:

- Potential for significant augmentation of energy resource base to substitute for scarce fuels;
- Potential to assist in end-use substitution of abundant resources for scarce fuels;
- Potential to reduce environmental damage, or to avoid such contingency problems as a CO<sub>2</sub> crisis;
- Potential to add to base of scientific knowledge;
- Opportunity cost of research (value of near and intermediate term programs that cannot be supported if this long term research is funded).

In the planning and management of energy research, development, and demonstration, analysis is performed at several levels for a variety of purposes. Strategic analysis is carried out at the higher management levels on a range of technological and policy strategies. While such analysis must capture the essential economic, technical, and environmental characteristics of alternative technologies, it generally does not involve a detailed process description of individual technologies (e.g., solar power tower) and their components. Such analysis at the strategic level usually deals with an array of technologies that are evaluated against broad national goals and objectives, and must treat the entire energy system embedded in the economy and ecosphere.

Analysis at the Program Level, however, must deal with the mechanical and process description of technologies and major components. It must be designed to feed appropriate information on the essential characteristics of the energy technology or system under development to the strategic analysis and, in turn, accept constraints on, and objectives for, the economic, technical, and environmental characteristics as determined by energy and economic or environmental policy. A good deal of energy process and technology modeling is in progress to address this need. Ideally, the results of this design process should be captured in the strategic level analysis. In the reverse direction, the strategy and policy goals must be reflected in the design of the specific technical process. The nuclear technology area is an example of one that has progressed to this point. Early systems analyses of alternative nuclear reactors and fuel cycles concentrated almost exclusively on minimum cost systems. Recently, the new strategic objectives of risk aversion and nonproliferation have been factored into the analyses, along with conventional economics.

#### ANALYTICAL METHODS

The large number of technical options that exist or are under development for the supply, conversion, and utilization of energy, as well as the complexity of the overall energy system, has led to the widespread use of analytical models and data bases for the assessment of energy technologies. A number of these analytical models are reviewed and summarized by Hoffman and Wood<sup>1</sup>

A more detailed review of the use of a selected set of analytical models in energy policy has been conducted by Weyant.<sup>2</sup> With respect to R&D assessment, Weyant's

review includes the Gulf-SRI Model developed by Cazalet<sup>3</sup> and its application to a synthetic fuels assessment, and the Brookhaven-Hudson-Jorgenson energy-economic modeling system that was utilized by the United States Energy Research and Development Administration in its formulation of national R&D plans. In the former case, the Gulf-SRI Model was used to address a specific decision problem, the level and mix of a synthetic fuel demonstration program. The Brookhaven-Hudson-Jorgenson modeling system was used in a different way, as a framework for the overall R&D plan to ensure that a sufficiently broad set of options was being pursued and to estimate national benefits of that plan. This latter R&D planning process made substantial use of the Reference Energy System as a framework for analysis encompassing the entire energy system.

#### The Total Energy System Perspective

The Reference Energy System (RES), Figure 1, is a network representation of the overall energy system encompassing all of the physical activities required in the supply and utilization of various forms of energy used to deliver energy services. Technologies are represented for all operations involving specific fuels, including their extraction, refinement, conversion, transport, distribution, and utilization. Each of these activities is represented by a link in the network for which efficiency, environmental impact, and the cost coefficients may be specified. The network is quantified for a given year with the level of energy demands, and the energy flows through the supply activities that are required to serve those demands. The total environmental effects, resource consumption, and costs for the energy system are tabulated for each planning year. It provides a compact information system that can be used directly, in a manual fashion or with computer assistance, for the evaluation of alternative policies and technologies. Projections of demands and flows represented in the Reference Energy System have been developed for future years using a variety of analytical techniques, ranging from a judgmental approach to rather sophisticated energy and economic models. The Reference Energy System is designed to permit the assessment of individual technologies, or a broad set of technologies and policies ranging across all supply and utilization options, with emphasis on the potential markets for the technologies.

A major feature of the RES is the treatment of end-use devices as a part of the energy system, and the correlation of energy demands in these devices with functional definitions of energy services. That is, demands are defined in terms of vehicle-miles traveled, households (of various types and in different climatic regions) to be heated, and tons of steel and aluminum to be produced, as examples. The levels of services, defined in a base year and projected to future years, thus serve as demand drivers for the energy system and are translated into energy units (Btus per year) needed to provide the required service levels. Market oriented energy services are generally estimated in relation to projections of population, economic activity, and income.

The high level of technical detail is necessary to permit the assessment of inter-fuel substitution strategies, analysis of conservation options, and analysis of the impacts of introduction of advanced technologies. Additionally, this comprehensive framework provides the ability to analyze both centralized and decentralized technologies, since the detail associated with energy transmission and distribution systems is also included. Thus, the RES framework permits the comparative assessment of:

- Single technologies, delineating the associated impact upon the cost of energy, environmental emissions, and the use of oil and other resources;
- Groups of technologies (a strategy), producing net impacts for the group;
- Policy options, including taxes, standards, incentives, etc.

FIGURE 1: REFERENCE ENERGY SYSTEM

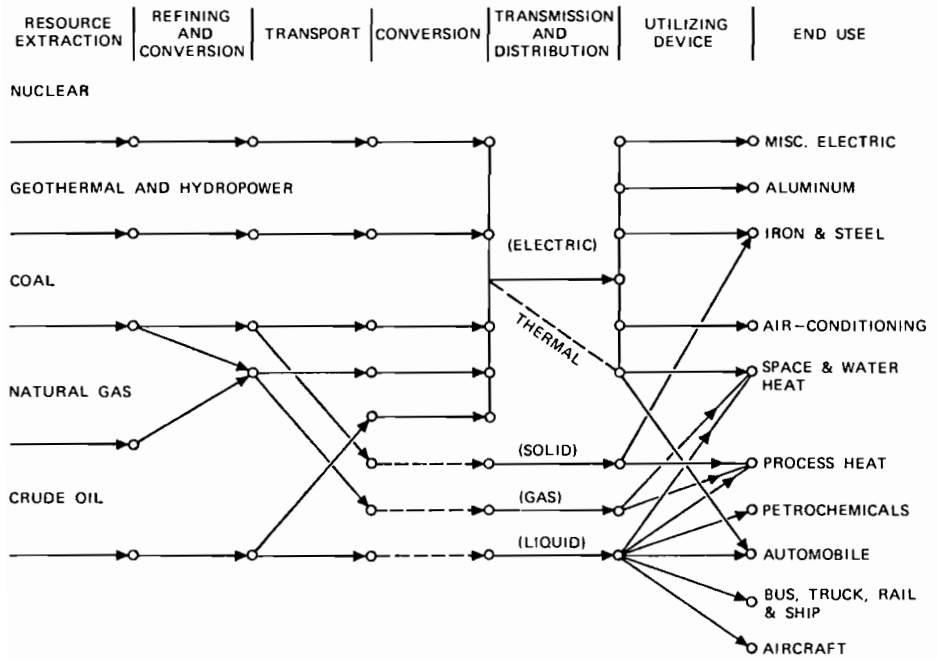

### Benefit-Cost Analysis

A series of benefit-cost analyses of individual R&D options were performed at Brookhaven National Laboratory using the Reference Energy System. Base case projections were developed for 1985 and 2000. Individual technologies were then inserted into the system, competing against other technologies for two sets of oil prices. The system benefit (if system cost decreased) or deficit was calculated. By interpolation, each intermediate-year benefit was calculated and annual benefits were discounted to obtain present value. Similarly, estimated R&D expenditures were also discounted. The results of the analysis are presented in Table 1, which are based on an oil price increasing to \$23/bbl in the year 2000 (\$'s refer to 1975 dollars).

### Modeling Approaches

A variety of energy models using different analytical approaches may be employed to analyze energy supply, demand, and the market potential for new technologies in the context of the total energy system. The major classes of analytical models that have been employed for energy R&D planning and technology assessment in the United States include:

#### Mathematical Programming:

ETA Macro (Stanford, Alan Manne)<sup>5</sup>  
Brookhaven Energy System Optimization Model and TESOM  
MARKAL-International Energy Agency<sup>6</sup>  
PILOT (Stanford)<sup>7</sup>

#### Dynamic Simulation:

Fossil 2 (Dartmouth, Roger Naill)<sup>8</sup>  
LEAP (Successor to Gulf-SRI and Decision Focus Models)<sup>9</sup>

The mathematical programming models use a process or activity analysis approach, where a wide variety of technologies are incorporated and appear in the solution in response to the optimization of a specific objective function. Some of the models listed include a linkage to a macroeconomic model.

The optimization routine in ETA-Macro deals with the supply technologies that deliver either electric or nonelectric energy. The demand for electricity and non-electric fuels are estimated in relation to Gross Domestic Product (GDP) by a set of econometric relationships. The Brookhaven Models, and MARKAL, include an activity description of end-use technologies which permit the assessment of specific R&D options in the end-use sectors in balance with supply technologies.

Linkages to the economy are included in the Brookhaven models through a coupling to the Hudson-Jorgenson econometric model of the economy which includes the variable coefficient interindustry matrix. The PILOT model incorporates a fixed coefficient input-output model with an econometric demand model for goods and services to couple the energy system to the overall economy. The analysis of energy options in the context of the overall economy is extremely important to determine the effects of alternative technical strategies on such economic variables as growth of GDP, employment, and structural inflation attributable to changes in the cost of energy.

A variety of objectives may be used in the mathematical programming models. For example, the Brookhaven model can accept the following objectives to be minimized:

- Capital cost;
- Total system cost;

Table 1: BENEFIT/COST RANKING, HIGH OIL PRICES  
(\$18.00/bbl. in 1985; \$23.00/bbl in 2000)

ERDA RD&D Program	Discounted Present Value of Benefits (millions of 1974 dollars)	Discounted Present Value of RD&D Costs (millions of 1974 dollars)	Benefit/ Cost Ratio
Heat Pump	5,800	7	830
Industrial End-Use Efficiency Improvement*	52,000	130	390
Residential & Commercial End-Use Efficiency Improvement*	84,000	270	310
Shale Oil - Surface & Underground	32,000	---	---
Shale Oil - in situ	31,000	130	245
Residential & Commercial Total Energy Systems	20,000	95	210
Improved Auto Propulsion	27,000	180	150
Enhanced Oil Recovery	27,000	360	74
Low Btu Coal Gas	15,000	230	67
Fluidized Bed Combustion	6,300	230	28
MHD Topping	7,200	330	22
Coal Liquefaction	12,000	590	21
Geothermal	5,500	310	18
Coal Combined Cycle**	3,000	---	---
Electrical Transmission & Distribution	1,700	190	9
Pipeline Coal Gas	1,500	220	7
Potassium Topping**	1,100	---	---
HTGR	220	640	0
Electric Storage	9	500	0
Wind Conversion	-20	180	0
Ocean Thermal Conversion	-130	400	0
Solar Electric from Thermal	-4,400	1,200	-4
Photovoltaic	-3,200	850	-4
Biomass	-5,200	640	-8
Battery Autos	-1,600	120	-14
Solar Heating & Cooling	-11,000	250	-43

\* Benefits appear to include efficiency improvements expected from industry as well as benefits expected from ERDA RD&D. Calculated Benefit/Cost Ratios should thus be viewed with caution. Also, additional end-use device cost to attain improved efficiency has not been included. It is apparent that higher end-use costs may be borne with still significant benefit/cost ratios.

\*\* RD&D cost estimates have not been provided by ERDA; so benefit/cost ratios have not been calculated. Ranking of these programs is based only on the magnitude of expected benefits.



- Imported fuels;
- Total thermal energy;
- Emissions to air and water (individually, or as a weighted combination).

A multi-objective study has been performed using MARKAL to map the energy supply and end-use technologies employed to satisfy each of the objectives of minimizing cost, oil imports, and environmental emissions. This approach is illustrated in Figure 2, which shows the feasible technology surface for various combinations of the three objectives. The explicit tradeoff between cumulative oil imports and cost, and the technologies appearing at specific points in the tradeoff curve, are shown in Figure 3.

The dynamic simulation models include process descriptions of energy supply options in a network format. The LEAP model also incorporates technical detail on end-use devices. A major feature of the dynamic simulation models is the ability to represent the dynamics of technological substitution and market changes.

#### Conservation Technology Assessment

The planning and analysis of a Federal research and development program on end-use technologies requires an information base at the individual process or technology level. Estimates must be made of the prospects for significant improvement in the efficiency of specific end-use devices, and of the likely pace of industrial research and development toward these objectives. The effects of a Federal program may then be estimated and the benefits compared with the R&D cost, similar to the methods used to evaluate alternative supply options. It should be noted that the conservation technologies rank rather high in the cost-benefit results illustrated in Table 1.

The problem of distinguishing between the role of improved technology and that of alternate policy options in achieving energy conservation arises quite frequently in energy R&D planning. It frequently is argued that certain policy options involving taxes, incentives, and/or standards can achieve specific goals without the development of new, more efficient technology, or can force new developments. The purpose of analysis here is to establish a conceptual framework for the assessment of both policy options and R&D to determine, in specific cases, whether they are indeed alternative options or actually are mutually supporting options. The actual situation will vary, depending on the specific energy-utilizing activity (residential space heat, auto transport, aluminum manufacture, etc.), and thus the methodology must be applied using information on specific utilizing devices (e.g., furnace) or systems (e.g., building including insulation, furnace, etc.)

#### CONCLUSIONS

The major planning and analysis requirement is the disciplined comparison of the many technical options for the supply, conversion, and utilization of energy. Decisions taken by private firms and/or government to accelerate the research and development pace on specific options requires a judgment of the market potential, or a determination that a particular technology supports an important national or regional objective. In the latter case, the decision is a political one, and once made, must be supported by regulatory and tax policies to ensure that the technology will be competitive in markets. Standards may also be employed to force a technological change into the marketplace. In either case, the technology assessment must be conducted in the context of the overall energy system. All of the infrastructure requirements to supply, deliver, and utilize energy from the new technology must be identified and analyzed, and the benefits and costs of the alternatives considered.

Figure 2: PARETO-OPTIMAL SURFACE FOR MULTI-OBJECTIVE TRADEOFF ANALYSIS

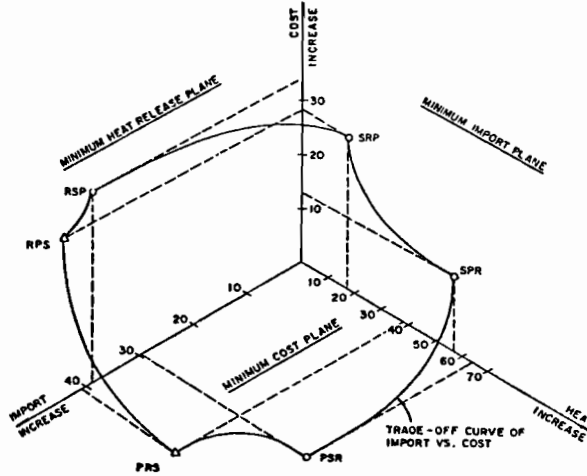
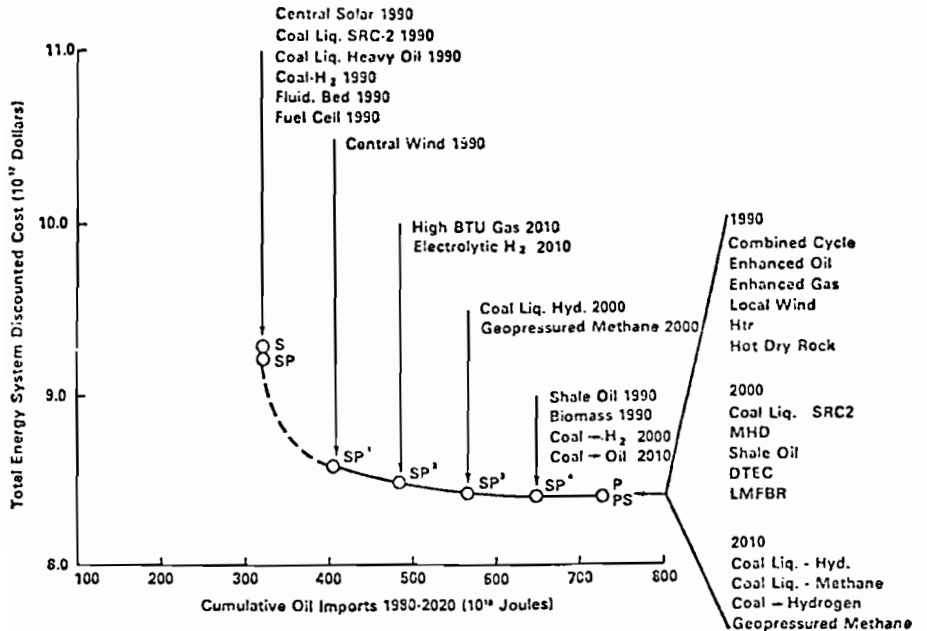

Figure 3: COST-SECURITY TRADEOFF FOR SAMPLE UNITED STATES RUN



Formal analysis and modeling can support the R&D planning process in a number of ways. Given the many uncertainties and subjective parameters that operate in the energy analysis, care must be taken to ensure that the results of the analysis are properly used. In any given policy analysis of technology assessment, quantitative results may provide only a small portion of the information required to support decision making. In other instances, quantitative analysis may play a larger role in the decision. Regardless of the extent of its impact, it is still important to do the analysis correctly to the highest standards of documentation and validation of the methodologies employed. The major benefit of quantitative analysis is the discipline and structure that it provides to the analysis and discussion of complex relationships between energy, economic, and environmental factors. In general, the structure and relationships among elements of a policy or decision will be of greater importance than the actual numerical results. In this spirit, formal analysis and modeling can support the R&D planning process in the following ways:

1. Rank technology options with respect to economic, technical, and environmental criteria;
2. Determine R&D targets for technical, economic, and environmental characteristics of a new technology, so that it will be competitive in commercial markets;
3. Identify those technologies that can support national plans and policy in the most effective way;
4. Estimate the regulatory and financial incentives required to commercialize a desirable technology;
5. Develop long term projections of technological change and substitution.

It is clear that formal R&D assessment methods are not applicable to the early stages of research in a new technology. At that stage the new technology is not sufficiently characterized to make the comparison with alternative approaches. Further, the costs of research at this early stage are low, and it is desirable to encourage the innovative process. At the advanced research and development stage, however, the program costs increase significantly and a formal screening and decision process is needed. At this point in the R&D cycle, it is extremely important to demonstrate that the program will lead to an improvement, in comparison with conventional and currently available systems.

Future development of analytical methods for R&D assessment will probably continue to use a combination of methods, including mathematical programming, dynamic simulations, and econometrics. No single methodology can address the variety of issues that must be analyzed. Specific problems in the current state of the art that must be addressed through further research include:

1. Probabilistic and stochastic approaches that can handle the uncertainties in technology characterizations and market descriptions;
2. Methods of evaluating risks in the R&D portfolio;
3. Standardized methods of cost estimating for new technologies;
4. Consistent characterization of the technical efficiencies, material inputs, and labor requirements for the construction, operation, and maintenance of both supply and end-use technologies.

It should be noted that, in the Bechtel Energy Facility Data Base,<sup>10</sup> that characterizes the cost and inputs to a number of energy supply technologies, an excellent start has been made on the last item above. This work should be extended to cover

end-use devices, as well as to include the range of uncertainty that exists for the descriptive parameters.

REFERENCES

<sup>1</sup>Kenneth C. Hoffman and David O. Wood. "Energy System Modeling and Forecasting," Annual Review of Energy, Volume 1, 1976.

<sup>2</sup>John Weyant. Quantitative Models in Energy Policy, in preparation.

<sup>3</sup>Edward Cazalet. A Western Regional Energy Development Study: Economics, SRI Project 4000, Stanford Research Institute, Menlo Park, California.

<sup>4</sup>Kenneth C. Hoffman and Dale Jorgenson. "Economic and Technological Models for Evaluation of Energy Policy," Bell Journal of Economics, Volume 8, Number 2, Autumn 1977.

<sup>5</sup>Alan Manne. "ETA-MACRO: A Model of Energy-Economy Interactions," in C.J. Hitch (ed.), Modeling Energy-Economy Interactions: Resources for the Future, Washington, 1977.

<sup>6</sup>V. Sailor and S. Rath-Nagle, the MARKAL Energy Technology Model, in preparation.

<sup>7</sup>George Dantzig. Formulating a PILOT Model for Energy in Relation to the National Economy, SOL75-10, Stanford University, April 1975.

<sup>8</sup>R.D. Belden. "Report on the Forum Project: FOSSIL 1 Analysis of Future Trends in the U.S. Coal Industry," DSD-96: EMF Report 2, Volume 3, September 1978.

<sup>9</sup>J.R. Adler and E.G. Cazalet. The DFI Energy-Economy Modeling System, Decision Focus, Inc., Palo Alto, California, May 1978.

<sup>10</sup>J.M. Gallagher and P.F. Paskert. Resource Requirements, Impacts, and Potential Constraints Associated with Various Energy Futures, Bechtel National, Inc., PAE-3794-9, March 1978.

# TECHNOLOGY ASSESSMENT IN ENERGY SUPPLY-DEMAND MODEL

**Z. Falecki and J. Ordega**

*Energy Economy Research and Development Centre, Katowice, Poland*

The fundamental factors influencing the overall energy economy of Poland are considered in a complex concept. Principles are formulated for the construction of the OBPE models system permitting effective analysis of the national energy demand/supply programme, with the aim of coordinating existing energy demand and supply potential. The system proposed enables the structure of the national energy balance to be rapidly corrected to allow for various strategies adopted in plans for the development of the national economy and also enables feasibility evaluation for choice of most advantageous technologies and energy carriers. A straightforward calculation technique is employed, suitable for application with virtually every type of computer currently in use.

This model is a valuable instrument making it possible to assess the effect on the fuel-energy economy of feasible options in substitution of energy carriers and of energy-intensive technologies.

## 1. INTRODUCTION

To find satisfactory solutions to problems of national energy strategy it is essential to take a complex view, envisaging various time horizons, of the total factors governing requirements for fuel and energy and also the feasible methods of satisfying this requirement.

Hence the basis for decision making in matters of energy economy must be an analysis of energy consumption considered in con-

junction with methods of obtaining energy from domestic production or from import. It is a sign of the times that in virtually all industrialised countries energy policies have become of first priority, mobilising administrative efforts at all levels and also major scientific research efforts. Inextricably bound up with this undertaking is another aspect of the problem, that is confrontation of the effects of energy policy implementation with the social requirements for environment protection.

A mutli-variant evaluation of this kind should provide the necessary data for establishing development tactics for the country's energy economy, and hence for both management and design decisions. It is understood that this process of establishing development lines for the economy in general and for the energy industry in particular is one with no finite end, since both time and the advance of knowledge have their inter-related influence on the state and development of energy programmes.

This process, by its very nature, is a reflection of the mutual relations between relevant component elements and occurrences, together governing the ultimate development of the system: energy - environment. It is of signal importance to consider the problem matter in its entirety, not only from the aspect of balancing material substance and energy produced, but allowing also for organisational and legislative conditions which are frequently the deciding factors in matters of priorities and basic values.

It is essential to include the relations between the economic, technological, ecological and organisational sectors with particular allowance for the elements of uncertainty and changes occurring with time, while determining definitively the information flow paths, both input and output /results/.

The purpose of the system described is to provide a method for analysis of the energy economy enabling a comparison of practically feasible strategies, which can then serve as a basis for decision making.

Since the total energy-environment system comprehends a very large number of human activities and also organisational structures it needs to be presented in a manner practically applicable for the user, that is for those responsible for making executive decisions.

The contemporary approach requires that the energy issue should be treated in a complex manner, that is considering the

total of problems associated with the obtaining, processing, transport/transmission and consumption of fuels and energy in all forms,

In the search for optimum solutions one of the known approaches is to analyse the possibilities of mutual substitution of the particular energy carriers and also to choose the most advantageous of the feasible applicable technologies for supplying the varied production and services demands. The assessment enabling the correct solution to be selected must be developed using suitable optimization parameters, which will be discussed in a further part.

The constituent elements forming together the solution to the problem as posed above are described here together with principles for the construction of a models system given the name OBPE.

## 1. SYSTEM PRINCIPLES

The specific nature of the energy economy means that it appears in the total national economy in two forms:

- a/ as a distributed set of elements forming constituents of particular sectors, departments, branches or production/services sequences /direct consumption of fuel and energy/,
- b/ as a compact economic system forming a part of the whole national economy /the energy winning and processing industries together with a complex of distribution systems/.

This formulation is chosen to stress the fact that the energy economy can be separated from the total national economy only to a certain extent. In this context there can be distinguished three fundamental and reciprocally inter-related spheres of operation determining the energy supply/demand programme for the whole country, i.e.

- choice of energy carriers at the user's end /taking into account substitution possibilities and choice of basic technologies/
- programming of generation and winning of fuels and energy and also energy exchange with foreign countries,
- establishing a rational scheme for energy supply/demand balance and also costs of its implementation /using, among others, the parameters as in the WELMM method/.

Figure 1 shows the relations between the constituent elements forming the basis for programming of the energy supply/demand pattern for the whole country. It is clear that such a programme correc-

tly determined must embody a balance between energy requirements and the possibilities of satisfying these requirements, assuming the current national energy base and taking into consideration the system of energy supply and distribution. Investigations on the development of fuel-energy economy must be conducted using successive and step by step balance analysis as a function of time, allowing for multi-variant set of input data and multi-variant results parameters.

The multi-variant nature of the solution found will result from the varied probable development strategies for the national economy /input data/ and the varied probable structures of fuel-energy economy /results parameters/.

Both the number of input parameters and the values of indices obtained from these calculations on projected energy supply/demand programmes are time-related, and decrease as the time horizon becomes more distant.

Moreover the qualitative and quantitative structure of the fuel-energy balance is subject to changes and any assessment becomes increasingly problematical as further time horizons are considered. In the same way the costs relations vary as the time horizon recedes and become increasingly difficult to determine with any precision.

### 3. DETERMINING ENERGY REQUIREMENTS

The set of input data necessary for establishing energy requirements in the given time horizon are determined from the programme for national socio-economic development, elaborated by the appropriate central government offices. Taking into consideration the feasible variants of this programme an all-round assessment of the future situation may be achieved. On Figure 1 the area of these topics is indicated in the upper part of the diagram, distinguishing two basic groups of topics, i.e. natural conditions and human activity.

After establishing a set of suitably selected indices characterising unit energy consumption it is possible to determine both quantitative and qualitative energy requirements. It is important at this point to programme the directions of energy utilisation so as to avoid excessive detail while maintaining a sufficiently representative profile.



#### 4. NATIONAL ENERGY BASE

The national energy base is indicated in the lower part of the diagram on Figure 1 and comprehends the Polish energy production and processing industries plus the whole area of energy exchange with foreign partners together with all the associated issues. The actual magnitude of the national energy base, and in particular its development, is very largely decided by the possibilities of construction of new or redevelopment of existing energy sources and distribution systems, which again is governed by the size of the investment funds made available and also foreign currency questions.

The most important requirement is that the energy base should be programmed in such a way as to ensure full availability, i.e. that the total energy needs of the national economy are met both quantitatively and qualitatively.

#### 5. ENERGY SUPPLY AND DISTRIBUTION SYSTEM

This system is an element of signal importance for ensuring availability as defined above. On Figure 1 this element is indicated on the left side of the diagram. The system must be suitably developed and organised to be able to guarantee effective energy supply to the users. The most important distribution systems are:

for electric energy - the electricity transmission network

for gas fuels - long distance piped transport, local networks and individual containers

for liquid fuels - rail, inland waterways, road and piped transport

for solid fuels - rail, inland waterways, road and hydraulic transport

for heat energy - municipal and local thermal network systems

#### 6. OBPE METHOD FOR ANALYSIS OF NATIONAL FUEL-ENERGY BALANCE

As stated previously, to find a rational solution to the problems involved in the future predicted national fuel-energy balance demands a complex evaluation of the total factors determining energy requirements and feasible means of satisfying these requirements. Hence the basis for making decisions concerning energy economy must be an analysis of energy consumption plus methods of obtaining energy

from domestic production or alternatively from import.

The principal aim of the studies conducted at the Energy Economy Research and Development Centre /Katowice - Poland/ was to coordinate the existing or predicted /multi-variant/ schemes for social-economic development of the country with the national energy economy, basing on the available data obtained from practical experience and from official predictions.

The three-stage OBPE method was proposed for modelling the national energy economy, i.e.

stage 1 - determining the structure of the outgoings side of the energy balance, allowing for variations in direct energy requirements /model OBPE-1/

stage 2 - determining the structure and also quantitative and qualitative conditions on the income side of the energy balance, i.e. winning the energy carriers /model OBPE-2/

stage 3 - integrating these two models in order to balance the two sides of the energy account.

The solution algorithm is presented in Figure 2. If there is no solution to the system, this signifies that for the assumed potential of production and import of energy the energy requirements cannot be covered. In this case it is necessary to correct the input data as indicated on Figure 2, i.e. correction of elements 1.01 or 1.03 for model OBPE-1, 2.01 and 2.03 for model OBPE-2, or elements 1.01 and 2.01 for the whole.

If the system can be solved, then for the given assumptions for socio-economic development of the country /1.01 and 2.01/ the following results are obtained:

- a - energy balance for the country
- b - magnitude of expenditure necessary to meet energy supply
- c - optimum distribution of energy carriers among the energy users.

The proposed system of models to be solved by linear programming is a valuable instrument for rapid determination of the basic constituents of the national fuel-energy balance, allowing for varying models of socio-economic development of the country.

The system described was checked by means of appropriate calculations which showed its operational effectiveness, that is

its suitability for practical prediction techniques applicable with a time horizon of 15 years.

The model matrices are of sparse type. The assumed aggregation depth for strategic analysis of the national energy balance appears to be sufficient /90 groups of energy consumers, 26 types of energy sources, 31 types of energy carriers/ and relates to macroscale consideration of the problem, i.e. for the whole country.

In this proposed system it is of vital importance to take natural /commercial/ measurement units for the various energy carriers, which considerably facilitates all types of substitution analysis.

Figure 3 shows the diagram of the proposed system of two models, i.e. OBPE-1 and OBPE-2. The accurate mathematical and factual descriptions are given in /6/.

Model OBPE-1 deals with the so-called direct energy requirements, comprehending both production and services sectors by means of indices for energy consumption and energy requirements. For optimization parameters economic, work-intensity, capital-intensity and similar coefficients may be taken or alternatively complex indices, as for instance in the WELMM system.

The model OBPE-1 forms a matrix with the elements: set of equations describing energy needs for selected directions of utilization, at the same time taking into account the possibility of energy carriers substitution, dovetailing with a set of equations allowing for possible limitations in the available carriers. In this system it is also possible to take into account substitution of technologies applied for the implementation of necessary production or services duties.

Model OBPE-2 comprehends total energy preparation, i.e. considers the processes of winning the primary energy, energy transformation and import of energy carriers. Suitable coefficients similar to those in OBPE-1 are used for optimization parameters.

This model forms a matrix with the elements: set of equations describing volume of production from the various energy carrier sources, dovetailing with a set of equations comprehending limitations in supply of these carriers. The problem to be solved in this model is to cover the requirements resulting from the solution found from OBPE-1 and also to cover energy carriers consumption to

produce these carriers plus that for export of fuel and energy. In this system feasible substitution in choice of energy carriers both in winning and in processing of fuels and energy is allowed for.

The set of input data is compiled from outside, i.e. from data prepared by central planning, and then fed to the model by means of which the calculations are performed.

The calculations procedure, as indicated in Figure 2, is performed for each alternative choice of socio-economic development, the results obtained forming the basic data for decision making on development lines for the national economy.

Bearing in mind that the economic life of the country is developing both in time and space it becomes essential to consider these problems for various time horizons, taking into account elements involved in spatial development of the country. To get a clearer view of the reciprocal relations in the national economic structure the model needs to be broken down, initially in two directions, i.e.

territorially - allowing for differentiated natural background and associated human material activities

sector-branchwise - to give a closer review of energy carriers choice, considering substitution feasibilities in various types of production and services.

## 7. CONCLUSIONS

The proposed system described here is based on previous research plus currently applied methods of planning and prediction, using relevant accessible statistical data, and aims to coordinate energy requirements with energy production and import potential, for all energy sectors existing in the country.

Simultaneously this system allows the structure of the energy balance to be rapidly corrected depending on various strategies in the planned development of the national economy.

The essential features of the proposed system are:

- a/ complex approach to the problem on a nation-wide scale for analysis of energy economy development with a time horizon of up to 15 years
- b/ creation of an instrument facilitating rapid review of the nat-

- ional fuel-energy balance for each variant of planned economic development, simultaneously choosing the optimum solution for distribution of available fuel and energy, at the level of supply
- c/ adjusting the system of models to the accessible input data
  - d/ taking into consideration mutual substitution of the various energy carriers
  - e/ enabling choice of applied technology most advantageous from the aspect of energy economy, for the implementation of production or services duties
  - f/ using a straightforward and universally applied calculation technique based on known methods of modelling and programming /simplex/, making it possible to employ virtually every type of currently used computer
  - g/ allowing for a number of reciprocal relations resulting from the basic propositions of national development, and affecting the structure of the energy balance.

The proposed system was checked by test calculations, both for a simplified example and for a variant embodying the full range of relevant data. Test results showed that the OBPE system of models is operationally sound and suitable for practical utilisation.

Correct choice of the models system, both central and in breakdown, makes it possible to achieve a reasonably comprehensive assessment of variants arising due to the various practically acceptable structures both of energy consumption and of energy winning, and also due to siting of individual industrial projects.

R e f e r e n c e s

1. H. Fiszal "Wstęp do teorii gospodarowania" /Introduction to the theory of economic management/ PWE Warsaw 1970
2. S. J. Glass "Programowanie liniowe" /Linear programming/ PWN Warsaw 1976
3. Z. Hellwig "Zarys ekonometrii" /An outline of econometry/ PWE Warsaw 1970
4. W. Niemczynow "Metody i modele ekonomiczno-matematyczne" /Economic-mathematical methods and models/ PWE Warsaw 1969
5. J. Ordęga "Optymalizacja Krajowego Bilansu Paliwow-Energetycznego" /Optimization of the national fuel-energy balance/ PTMTiS - Symposium on "Optimization in mechanics" Beskid Śląski 1976
6. J. Ordęga "Metoda Dostosowania Zaopatrzenia Kraju w Energię do zmieniających warunków jego realizacji" / A method for adapting the national energy supply programme to varying conditions of implementation/ OBR GE Katowice - Warsaw 1977

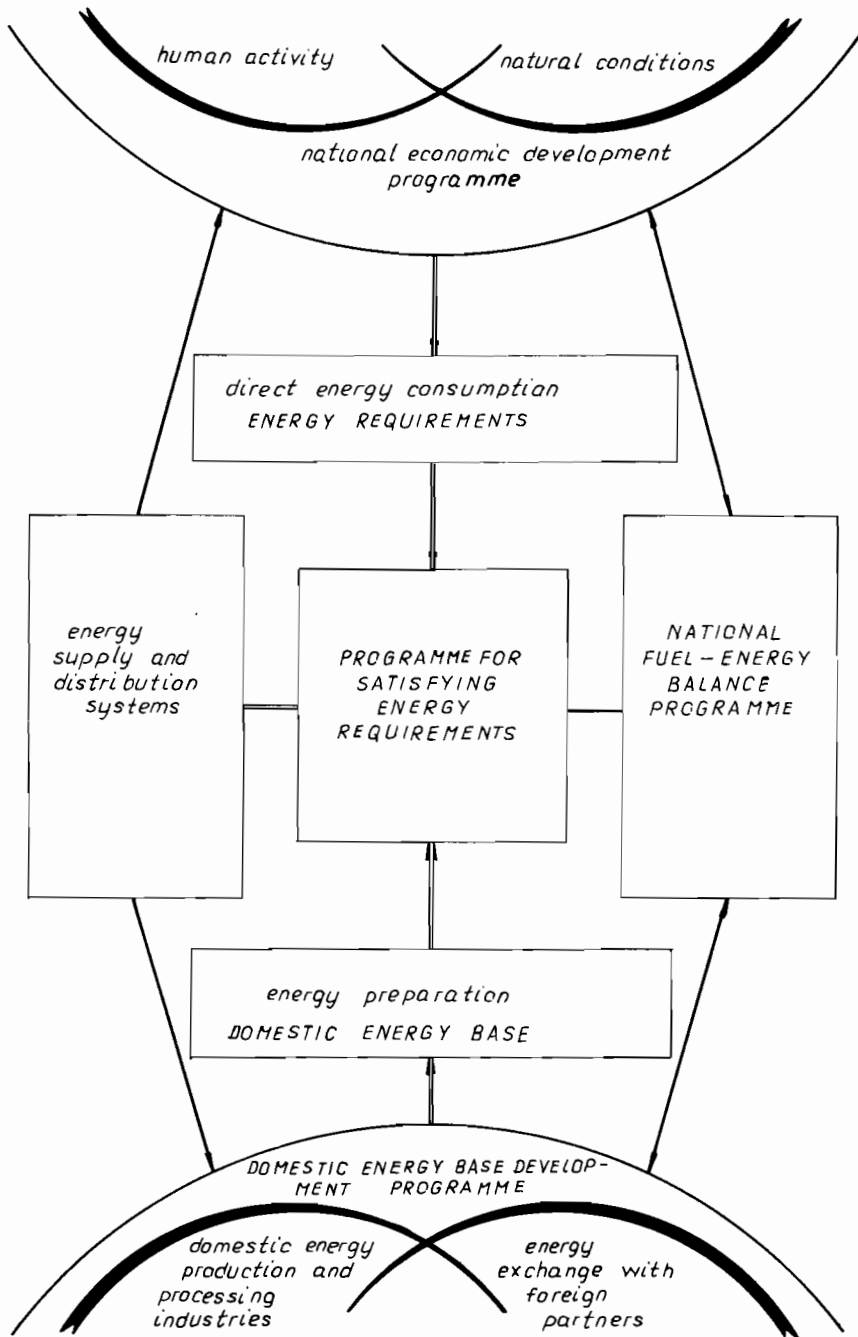

Fig. 1. Diagram of inter-relationships for programming national fuel-energy balance

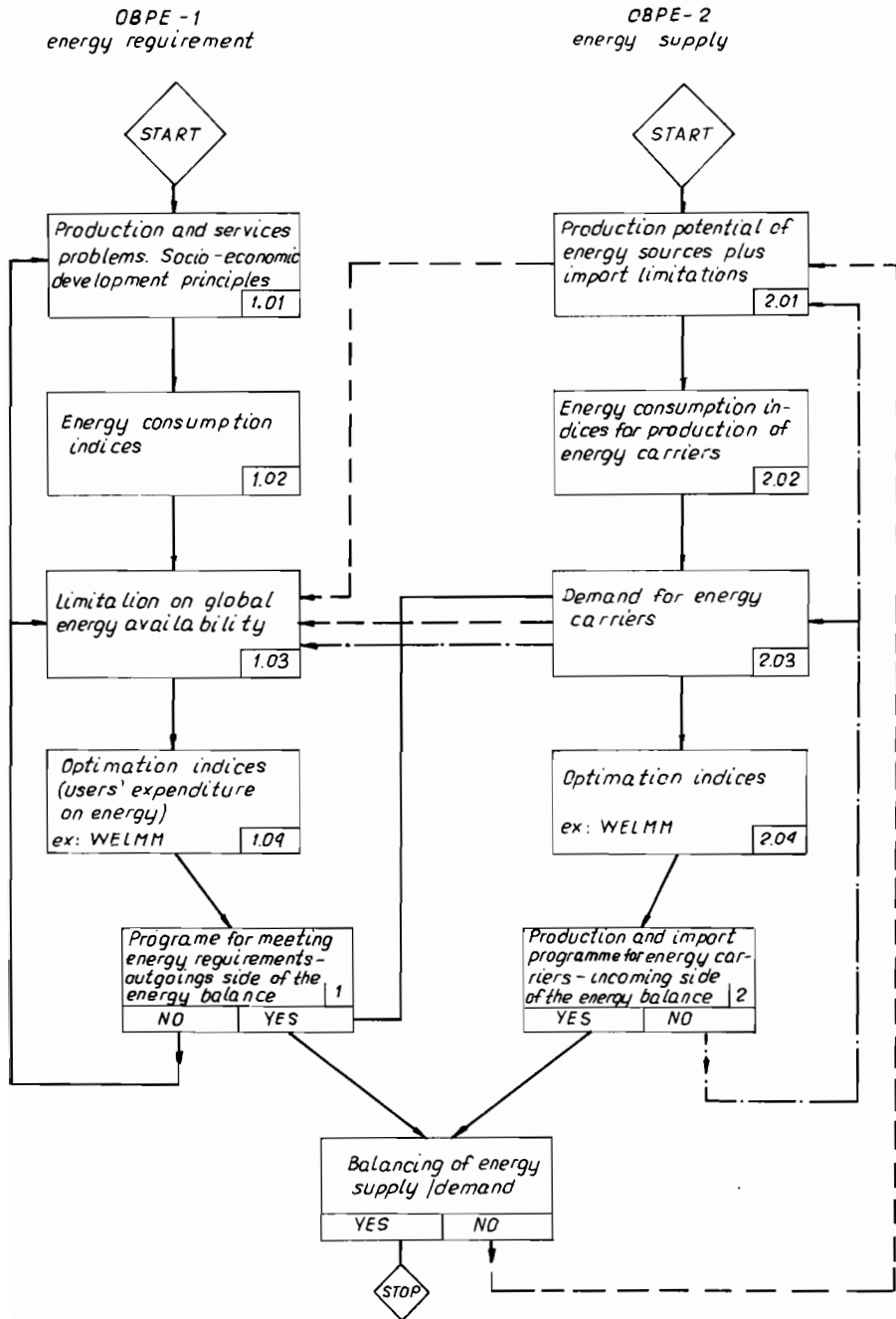

Fig. 2. Algorithm for solving the OBPE models system



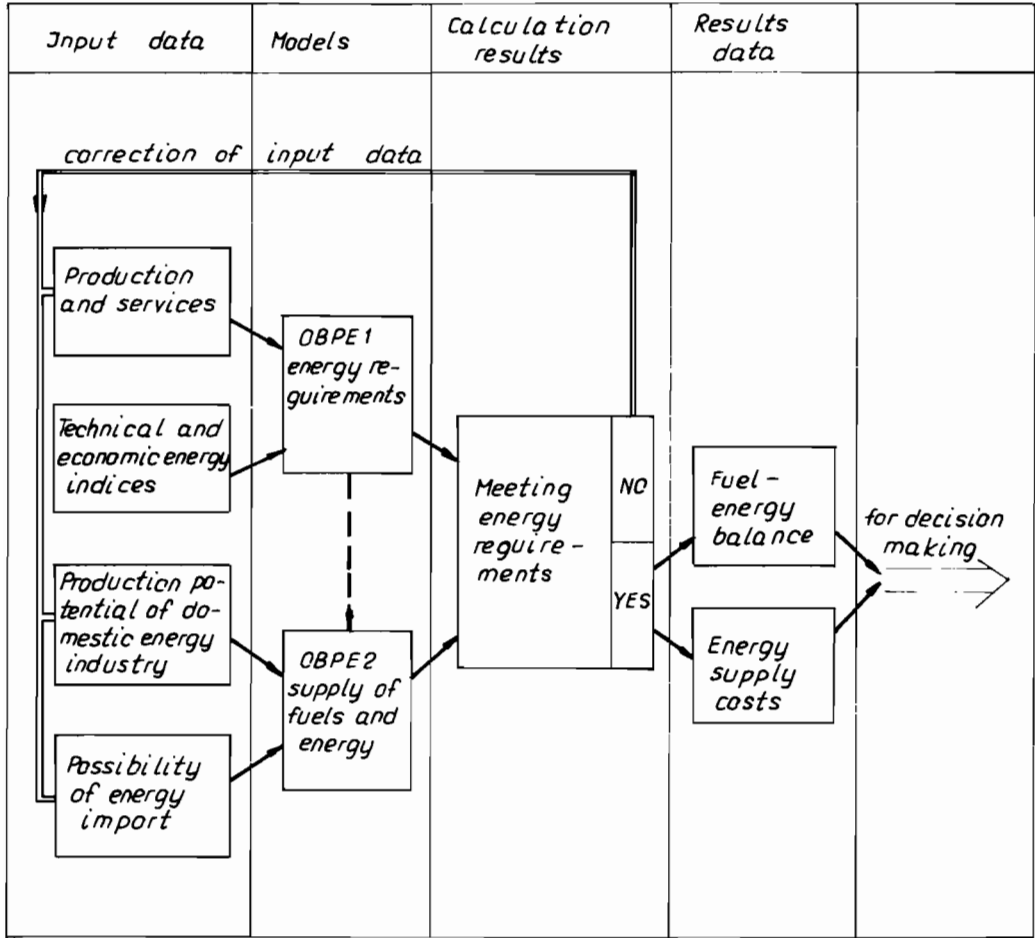

Fig. 3 Proposed system of two models.



# ENERGY SYSTEMS AND ENERGY DEPENDENCE: A COMPARATIVE STUDY IN TECHNOLOGY ASSESSMENT FOR VARIOUS IEA COUNTRIES

**G. Egberts, K. Leimkühler and St. Rath-Nagel**

*Programmgruppe Systemforschung und Technologische Entwicklung,  
Kernforschungsanlage Jülich, Federal Republic of Germany*

## ABSTRACT

The dependence on imported oil in many countries clearly shows that strong efforts become necessary to provide economies with new energy technologies that draw on different resources. Examples of these are Shale Oil and Tar Sands, Enhanced Recovered Domestic Oil and Gas, Coal Derived Liquids and Gases, Electricity generated from Breeders or Advanced Converters, Application of Solar, Wind, Ocean and Geothermal Energy, Fuels from Biomass, Heat Pumps, etc.

Research, Development and Demonstration (R,D&D) for these technologies has typically long lead times and requires large investments that may be difficult to allocate for a single country. The International Energy Agency (IEA) in Paris aims at stimulating, pooling and coordinating these activities in multi-national cooperative projects. To support these, the agency elaborates an energy R,D&D strategy, that uses systems analysis results obtained from a large scale energy model. The model, which is applied by 15 member countries, some important input parameters, the generated scenarios and the approach for technology assessment are presented in the article.

## KEYWORDS

Energy Systems Analysis, Energy Research Development & Demonstration, Technology Assessment, New Energy Technologies, Linear Programming Model, International Study.

## INTRODUCTION

New energy technologies play an increasingly important role in many countries' efforts to reduce the dependence on imported oil. But technology development typically has very long lead times and often has large investment requirements that may compete with other national objectives or cannot be carried by a single country. Technology development may, however, become more effective and rapid through international cooperation and multi-national projects. This principle led the 20 member countries of the International Energy Agency (IEA)<sup>1</sup> in Paris to call for establish-

---

<sup>1</sup> Member countries of the IEA are: Australia, Austria, Belgium, Canada, Denmark, Germany, Greece, Ireland, Italy, Japan, Luxembourg, Netherlands, New Zealand, Norway, Spain, Sweden, Switzerland, Turkey, United Kingdom, United States.

ing an international strategy for energy research, development and demonstration (R,D&D).

The objective of the IEA R,D&D strategy project is to provide guidance as to which new energy technologies should be made available at economically and environmentally acceptable cost, when and to what extent.

The elaboration of the strategy follows a systems analysis effort that has been underway since 1976 with the objective of developing the methodology, collecting the necessary data and producing the projections of future energy technology impacts. The systems analysis work is carried out by a staff seconded from 15 participating member countries, working at two national research laboratories as host institutions, one at Brookhaven, USA and the other at Jülich, Germany.

The objective of the systems analysis part of the project is to obtain quantitative estimates of the market penetration of individual new energy technologies over the 1980 to 2020 time period under a variety of strategic assumptions, so that through analysis their effects on total energy system costs, oil import dependence and environment could be assessed. In the conduct of this work an analytical model has been developed, which uses linear programming techniques to generate national scenarios.

#### CHARACTERIZATION OF TECHNOLOGIES

One of the most important factors in the application of the model for energy R,D&D planning is the data base on technologies. Two categories of technologies can be distinguished:

##### a) Demand Device Technologies

These are technologies that provide a useful service, such as oil burners, heat pumps or electric motors. The input data consists of efficiency, a fractional allocation of each energy type required by the device, investment cost, operating and maintenance cost and fuel delivery cost. In the case of improved insulation measures, this "service" has to be specified with the energy savings and installation costs.

##### b) Technologies for Converting Energy Carriers from one Form to Another

These technologies include systems such as refineries, coal gasification plants, power plants. Input data comprises the type of energy input and output, efficiencies, investment cost, operating and maintenance cost and fuel delivery cost.

The 34 generic new technologies that were characterized for the model are displayed in Fig. 1. All countries' runs are required to use all 34 technologies unless excluded by a policy constraint or by a separate analysis indicating that the technology excluded would never be a viable option.

#### MODEL CHARACTERISTICS

The model used (called MARKAL, an acronym for MARKet ALlocation) is a multi-period, linear programming (LP) model of a generalized energy system. Thus instead of just optimizing an energy system at a certain time and in a certain state, MARKAL optimizes the system's development within a time period of up to 40 years. The total time span to be considered is divided into 5-year intervals. For intervals centered at 1980, 1985, ... up to 2020, the total energy system (including energy supply and energy use) is optimized; a set of additional constraints is responsi-

<p><u>COAL TECHNOLOGIES</u>            COAL LIQUEFACTION            HIGH QUALITY GASIFICATION            LOW - MEDIUM QUALITY GASIFICATION            COMBINED CYCLE VIA LOW QUALITY GASIFICATION            COAL COMBUSTION (FLUIDIZED BED)            MAGNETOHYDRODYNAMICS (MHD)            FUEL CELL            UNDERGROUND COAL GASIFICATION</p>	<p><u>GEOTHERMAL</u>            HYDROTHERMAL            HOT DRY ROCK</p> <hr/> <p><u>CONSERVATION</u>            RESIDENTIAL AND COMMERCIAL:                BUILDING EFFICIENCY (SHELL)                BUILDING EFFICIENCY (EQUIPMENT)</p>
<p><u>OIL AND GAS</u>            ENHANCED OIL RECOVERY            ENHANCED GAS RECOVERY            SHALE AND TAR SANDS            GEOPRESSURED METHANE</p>	<p><u>TRANSPORTATION</u>            IMPROVED EFFICIENCY            ALTERNATIVE FUELS            NEW SYSTEMS - ELECTRIC AUTO            NEW SYSTEMS - OTHER</p>
<p><u>SOLAR TECHNOLOGIES</u>            RESIDENTIAL AND COMMERCIAL SOLAR            WIND POWER            OCEAN POWER            FUELS FROM BIOMASS            DISPERSED SOLAR ELECTRIC            CENTRALISED SOLAR ELECTRIC</p>	<p><u>INDUSTRY</u>            HEAT MANAGEMENT            PROCESS SPECIFIC</p>
<p><u>OTHER</u>            NON-FOSSIL HYDROGEN SYSTEMS</p>	<p><u>UTILITY</u>            DISTRICT HEATING</p>
<p><u>NUCLEAR TECHNOLOGIES</u>            EXISTING CONVERTER REACTORS            ADVANCED CONVERTER REACTORS            BREEDER REACTORS            FUSION</p>	

Fig. 1 List of technologies to be included in energy R&D strategy development

ble for logical connections between time intervals. In this way, an integral optimum for the total time considered is reached. The multi-period property of MARKAL naturally leads to the distinction between "static" restrictions (valid for one year between adjacent 5-year intervals only) and time-dependent or 'dynamic' restrictions. Figure 2 shows the matrix structure of the resulting model. Shaded areas indicate sub-matrices with non-zero coefficients.

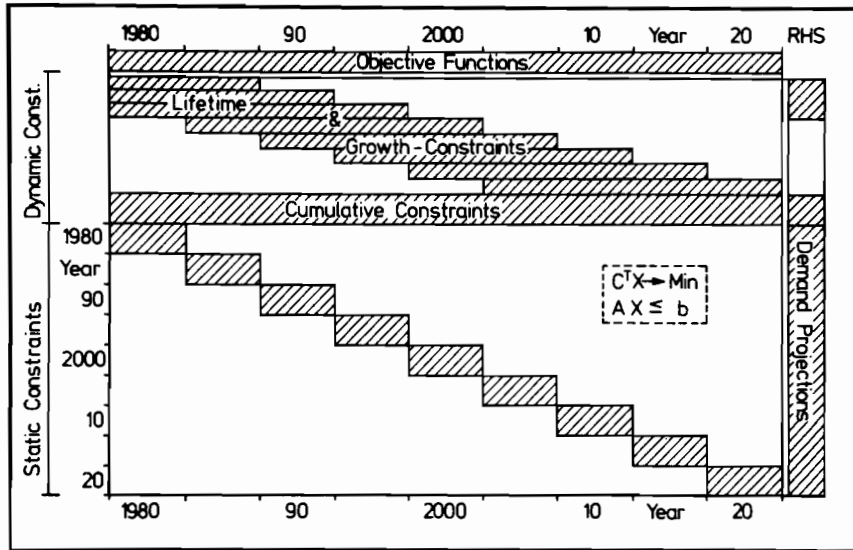

Fig. 2 MARKAL - Matrix structure of the multi-period model

Taking the general formulation of a linear optimization problem

$$\begin{aligned}
 \min! \quad & Z = c^t \cdot x \\
 \text{with} \quad & A \cdot x \leq b \\
 \text{and} \quad & c, x \in \mathbb{R}^n \\
 & b \in \mathbb{R}^m \\
 & A \in \mathbb{R}^n \otimes \mathbb{R}^m
 \end{aligned}$$

the right hand side vector  $b$  then contains projection figures of the useful energy demand to be met by the energy supply and conversion system. Thus, feasible and optimal solutions may be obtained only if all specified end-use demands for energy are satisfied for every time period; the block diagonal sub-matrix in Fig. 2 contains the static constraints.

In effect, the model simulates the energy flow from energy supply through transformation systems to demand devices which have to meet the exogenously given end-use demand. Alternative supplies, transformation processes and end-use devices compete for the respective markets, where the number and specification of competitors and end-use sectors is at the discretion of the user. Figure 3 gives a pictorial representation of the energy flow within an energy system mapped by the MARKAL model.

#### SCENARIO RUNS AND THE TRADE-OFF CONCEPT

Of course, with a model like the one described above, no definitive forecast is intended, rather an interpretation of results under different scenario assumptions. Without going into a detailed discussion of various inputs here, one may list a

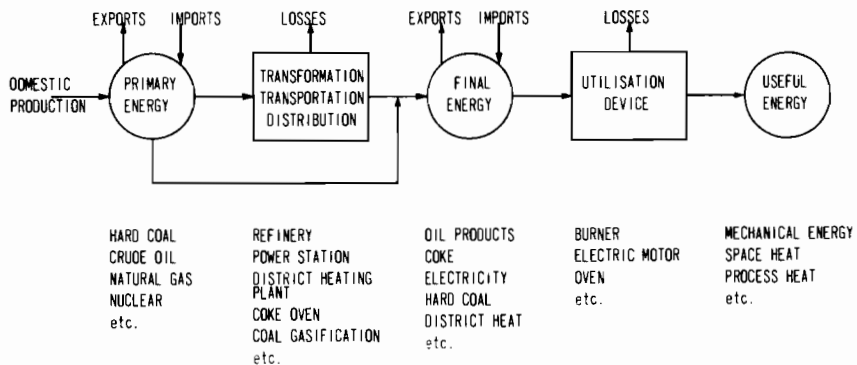

Fig. 3 The MARKAL energy system

few important categories of assumptions, which distinguish particular scenarios. The input variations compared with the 'reference scenario' are:

- accelerated implementation and faster growth rates for new technologies (accelerated scenarios)
- varying assumptions on the development of the price of imported oil and oil products (higher and lower oil price scenarios)
- restrictions on the total installed nuclear capacity (limited nuclear scenarios)
- restrictions on the total fossil fuel use (limited fossil scenarios)
- restrictions on the total net oil import ('supply security' scenarios), and
- implementation levels of renewable technologies specified exogenously to their upper limits (renewable scenario).

Usually with an LP-problem every non-constrained row may serve as an objective function; the ones used most commonly with MARKAL were

- P = PRICE INDICATOR  
= total discounted cost of the energy system for the time considered
- S = SECURITY OF SUPPLY INDICATOR  
= total net oil import for the time considered

The reference scenario has been obtained by minimizing the objective function P with no constraints on S. Constraining the total net oil import to lower values which must not be exceeded subsequently leads to higher system costs (while more expensive technologies will enter the solution) until a lower limit of oil import will be reached where solutions will be infeasible due to a shortfall in the systems oil supply. The corresponding values of system cost and oil import in between those extreme scenarios constitute a 'trade-off curve'. Trade-off curves have been computed for individual countries which show individual degrees of flexibility between both variables. Figure 4 shows trade-off curves for two acceleration levels of new technologies (level 1 and level 4) for all 15 IEA member countries for which systems analysis work has been done in Brookhaven and Jülich.

Some interesting conclusions may be drawn from Figs. 5 and 6 which display the

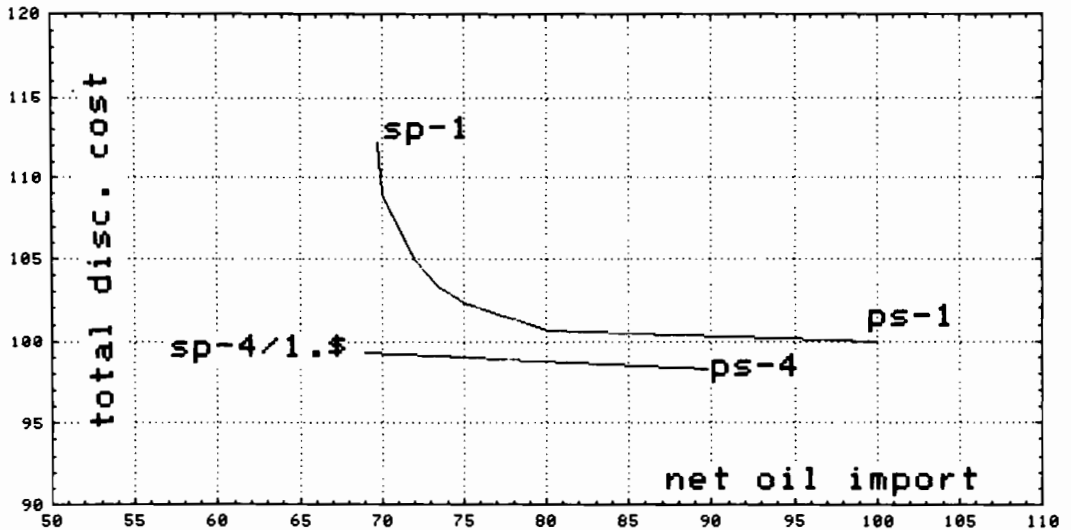

Fig. 4 Trade-off curve for 15 countries

grand total of primary energy demand for 15 IEA countries and show the energy contribution from the use of Residential and Commercial Heat Pumps in 6 European IEA countries. While from Fig. 5 one may draw conclusions if the aggregated values were realistic to be achieved or may signalize energy supply shortcomings, the latter gives information on the implementation level of a particular new technology and shows how it differs nation-wise.

#### TECHNOLOGY ASSESSMENT

In order to support the development of an R,D&D strategy it is important to assess the relative benefits of new technologies.

The scenarios calculated with the MARKALmodel show implementation levels of new technologies in different scenarios. This is an important information but certainly not sufficient for technology assessment. The implementation level does not relate to the specific market of a technology and shows neither the energy input requirements of the technologies nor the economics and as such does not really reveal how crucial the technologies are in terms of a relative benefit.

Some attempts were made, however, to shed more light on the expected benefits of these technologies using analytical methods. The limitations of these approaches should be kept in mind. Examples of factors that they do not take into account are:

- relative weighting of scenarios,
- need for R,D&D,
- cost of R,D&D (including impact of R,D&D on technology characteristics),
- technology impact on environment and society,
- special properties of new technologies (e.g. fluidised bed combustors can use low grade fuel),
- unit size of technologies (MARKAL uses continuous variables and can decide to implement technologies at only a fraction of their unit size).



SINGLE SCENARIO FOR 15 COUNTRIES      RUN TADR401      SCENARIO: RP - 4      DATE: 24/11/79

TABLE 1: PRIMARY ENERGY (FOSSIL FUEL EQUIVALENT) (EER/JOULES)

1980	1985	1990	1995	2000	2005	2010	2015	2020	LINE	CODE
31.2	37.8	45.1	48.3	52.2	57.0	62.1	64.4	106.7	1	SOLIDS
71.5	70.8	68.3	68.2	67.2	64.7	62.5	64.4	66.4	2	LIQUIDS
29.1	28.9	30.8	30.4	29.2	29.2	23.5	22.0	20.3	3	ORSES
9.4	13.4	18.8	20.0	20.8	48.8	67.0	82.2	98.8	4	NUCLEAR
10.1	11.8	13.4	16.1	18.7	17.1	17.8	17.5	17.4	5	HYDRO
0.8	4.2	8.3	14.8	21.3	28.8	31.4	36.4	41.4	6	OTHER RENEWABLES
148.8	187.7	185.7	205.8	228.0	249.5	274.1	287.0	319.2	*****	T O T A L *****

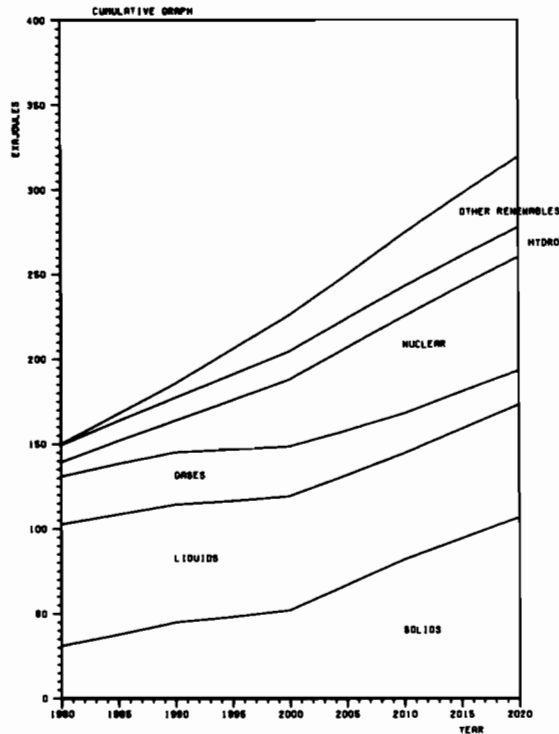

Fig. 5 Primary energy consumption for 15 IEA countries

For this reason the approaches described below should not be used without simultaneously making judgements about those factors that have not been quantified.

Three approaches were studied for individual countries using MARKAL to measure the relative benefits of new technologies. In the first one an index had been defined measuring the economic attractiveness of new technologies. It assesses the impact of each technology on the total energy system cost at marginal prices. In another case a competitiveness indicator for technologies had been used which shows the marginal profitability of technologies in terms of the objective function applied. In the third case the contribution of new technologies to a particular policy objective was studied. The latter approach has been adopted for the particular case of Germany, which is summarized in the following as one example:

a) The sixteen scenarios computed for Germany are all cost minimum cases. All demands are satisfied and the technology mix and resource consumption depend on the particular constraints implied in the scenario. In order to differentiate among new technologies in these scenarios from an energy R,D&D policy viewpoint, additional policy criteria have been applied.

SINGLE SCENARIO FOR JUELICH GROUP

SCENARIO: SP-4/1-0

DATE: 18/11/79

TABLE 27: OUTPUT OF RESIDENTIAL & COMMERCIAL HEAT PUMPS (PJ/YEAR)

1980	1985	1990	1995	2000	2005	2010	2015	2020	LINE	CODE
0.0	3.8	7.5	14.1	30.1	38.8	44.9	60.4	82.8	1	U.K.
0.0	0.0	0.0	24.0	40.0	58.0	64.0	64.0	64.0	2	BELGIUM
0.0	0.7	2.2	10.1	18.5	22.7	28.4	35.5	41.7	3	DENMARK
0.0	17.0	102.0	237.3	440.2	437.8	883.3	1078.4	1345.1	4	GERMANY
38.2	50.9	71.0	99.6	133.1	162.4	201.0	231.8	303.8	5	ITALY
0.0	2.0	12.0	22.4	32.4	34.4	36.0	29.4	33.4	6	SPAIN
38.2	74.5	202.7	407.4	692.3	750.2	1240.6	1859.8	1950.8		***** T O T A L *****

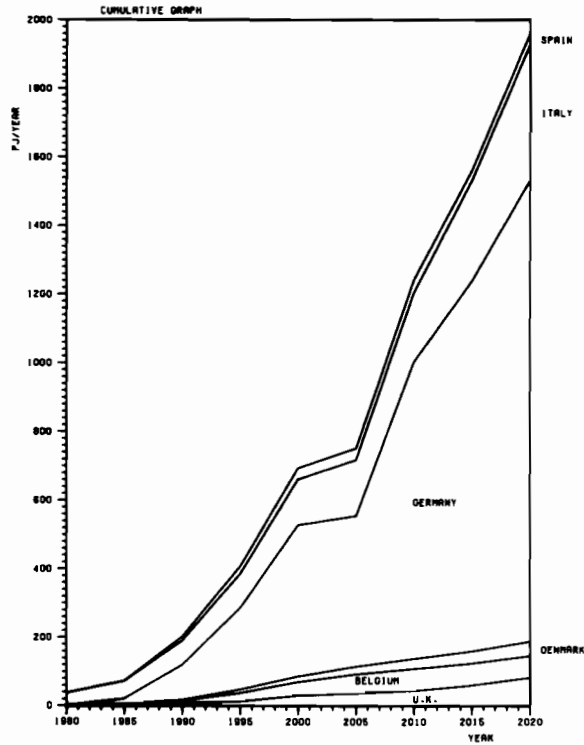

Fig. 6 Output of residential and commercial heat pumps for 6 countries

b) Germany's current oil consumption is at a level of about 210 Mtce/yr. It is assumed that an energy policy is favoured that gradually decreases the amount of oil imports, but at reasonable expense for the economy. A reasonable oil consumption target compared with today's level is at 75% by 2000 and at 50% by 2020.

c) The application of these criteria leads to the selection of a particular 'supply security scenario' as a preferred scenario among the set of sixteen scenarios computed for Germany.

d) If the oil consumption target is applied to technologies that are implemented in this scenario the grouping as displayed in Fig. 7 can be inferred.

Vital Technologies are those that would cause a violation of the oil policy target in case they were unavailable and had to be replaced by other technologies.

Essential, but Non-Vital Technologies are those that would allow the achievement of the oil policy target but at a significant cost increase, in case they were unavailable and had to be replaced by other technologies.

<u>VITAL TECHNOLOGIES</u>	<u>ESSENTIAL, BUT NON-VITAL</u>
1. Conservation technologies	1. Heat Pumps
2. Nuclear technology	2. Coal electricity
3. Coal Liquefaction	3. Coal gasification
	4. Transportation sector
	5. Solar technologies
	6. Enhanced oil and gas
	<u>LESS ESSENTIAL</u>
	1. Hydrogen technologies
	2. Geothermal technologies

Fig. 7 Assessment of technologies for Germany

Less Essential Technologies are those that are neither required for oil policy target nor for a low cost solution, but are possible contributors to the energy supply.

Individual technologies belonging to one of the groups displayed above have finally been ranked by measuring their energy contributions and applying judgemental criteria.

#### REFERENCES

- Abilock, H. (1979). User's Guide for MARKAL. Brookhaven National Laboratory, Upton, N. Y.
- De Terra, N. (1979). The IEA systems analysis effort for the development of an RD&D strategy: examining the potential energy impacts of new energy technologies. Seminar on Co-operative Technological Forecasting: Solar Energy, Tenerife 2-7 July, organised by the Economic Commission for Europe.
- Egberts, G., Giesen, G., Hymmen, A., Leimkühler, K., Rath-Nagel, St. (1979). Energy scenarios and impacts of new technologies for Germany. Status Report to the IEA Steering Group on Energy R&D Systems Analysis Draft, July.
- Egberts, G., Giesen, G., Hymmen, A. (in preparation). MARKAL Documentation and User's Guide. Programmgruppe Systemforschung und Technologische Entwicklung, Kernforschungsanlage Jülich.
- Fishbone, L. G. et al. (1979). MARKAL, a multi-period linear programming model for energy systems analysis (BNL version). To be included in the pre-conference set of contributed papers to the International Conference on Energy Systems Analysis, Dublin, 9-11 October.
- IEA Systems Analysis Project Staff at KFA Jülich (1978). Standard characterisation of energy technologies. Status Report on Conversion Technologies. Programmgruppe Systemforschung und Technologische Entwicklung, Kernforschungsanlage Jülich, August.
- IEA Systems Analysis Project Staff (1978). Technology Review Report. Programmgruppe Systemforschung und Technologische Entwicklung, Kernforschungsanlage Jülich, October (currently being updated and extended for final edition.)
- Rath-Nagel, St. (1979). The Systems Analysis Strategy Project of the IEA. Seminar at Stanford University, 15 May. Paper reproduced at Programmgruppe Systemforschung und Technologische Entwicklung, Kernforschungsanlage Jülich.
- Wene, C. O., Leman, G. (1979). Conservation versus substitution treated by a multiperiod LP-model. To be included in the pre-conference set of contributed papers, International Conference on Energy Systems Analysis, Dublin, 9-11 Oct.



# DECISION ANALYSIS IN THE ENERGY SECTOR: NUCLEAR CHOICES FOR TURKEY

**I. Kavrakoğlu**

*Department of Industrial Engineering, Boğaziçi University, Istanbul, Turkey*

## ABSTRACT

A model has been developed for the planning or analysis of the energy sector. This dynamic linear programming "mini-model" is presently used to analyze nuclear strategies for Turkey. The decision variables include four primary energy sources, three types of secondary energy, investment as well as production activities in the refining, conversion, and transmission of energy. There are 226 rows and 186 columns, and the planning horizon is fifteen years.

## KEYWORDS

Decision analysis; energy modelling; dynamic linear programming; nuclear strategies.

## INTRODUCTION

In a few years, Turkey will reach a point at which certain key decisions must be taken concerning the future of the energy sector in general, and the electricity system, in particular. The basic problem is that there is no obvious strategy: soon, the hydro potential will have been almost fully developed; hard coal production levels can hardly be maintained; brown coal (lignite) resources have to be shared among several consuming sectors; petroleum reserves are small and the actual potential is unknown. In about ten years, an additional resource is probably going to be required so as to avoid a shortage of electricity, as well as severe shortages of other fuels.

One of the most urgent decisions involves the electricity generation mix. If no new conventional sources are discovered, extensive buildup of nuclear power plants seems unavoidable. In order to analyze future possibilities, the "energy mini-model" described below is currently being used to assess the role that nuclear energy can play in Turkey in the future. The study is commissioned by the Turkish Electricity Authority.

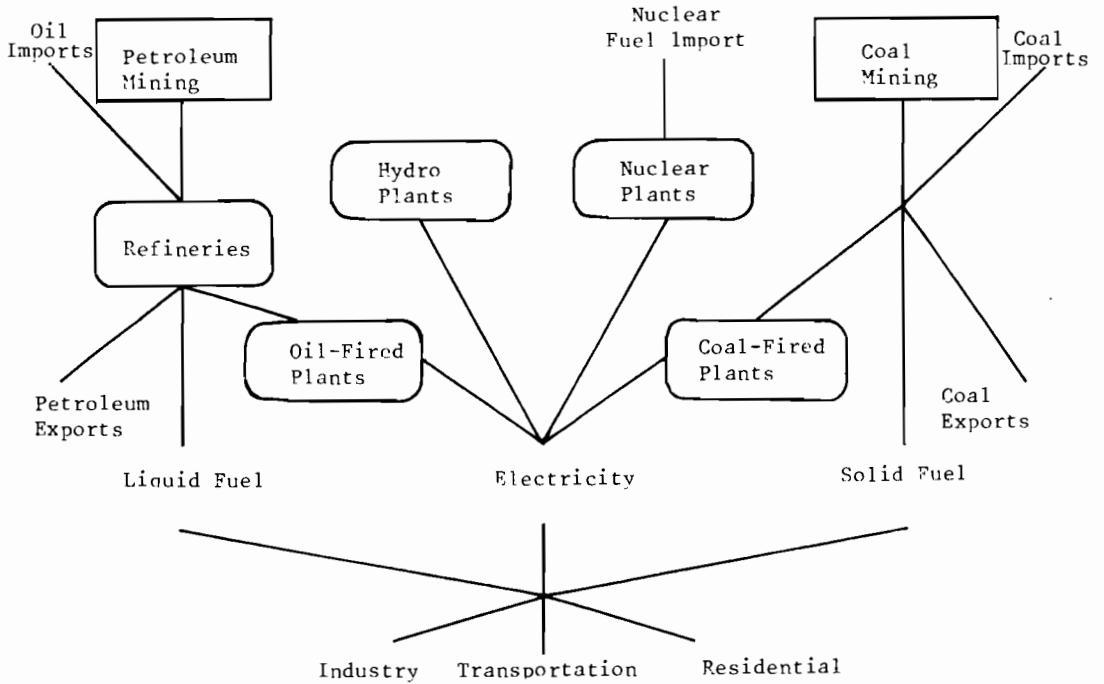

Fig. 1. Energy Flow Network

#### MODELING THE NATIONAL ENERGY SYSTEM

It is possible to model the national energy system in many different ways. The important factor that will influence the final choice; i.e., the level of aggregation, the method of approach, type of mathematical representation of the relations, etc. are largely dependent on the characteristics of the system as well as on the type of policy decisions that are to be analyzed. The approach taken here is to keep the model as small as possible while retaining all the elements that are needed for a meaningful analysis of the system as a whole. Furthermore, since the model will be applied to Turkey, it should reflect all likely developments in the energy sector of the country.

The energy flow diagram of the model is shown in Fig. 1. The primary energy sources include only oil, coal, nuclear and hydro potential. Other sources such as natural gas, geothermal, and solar energy are used in negligible quantities. Noncommercial sources like fire wood and cow dung are utilized locally and are not really influenced by policy decisions.

Major conversions take place in the refining of petroleum and in the generation of electricity. Transportation of petroleum or coal and the transmission of electricity have associated energy losses. The final form of energy reaches the consuming sectors as solid fuels, liquid fuels, and electricity.

Investment activities are in the areas of coal and oil mining; refining facilities; power plants utilizing coal, petroleum (fuel oil and diesel oil), nuclear, and hydro sources; and transmission of electricity.

The time horizon is 15-years, with another six years for end-effects. There are

five planning periods of three years duration.

Fuel demands are treated exogenously, as are quantities that are decided on outside of the energy system. The import prices of fuels and energy technology equipment; unit local costs of energy investments; operating and maintenance costs; conversion efficiencies; time lags between payments and investments, and between investments and actual production; and calorific values of energy sources and carriers constitute the "technology coefficients" of the dynamic linear programming model. The objective of the model is to minimize the weighted sum of: fuel import costs; energy technology import costs; and costs of unsatisfied demand. The details of the model are given in the following,

### THE MATHEMATICAL MODEL

#### Fuel Demand

The sum of fuels (F) of type  $\ell$  supplied to consuming sector  $s$  at time  $t$  and the unsatisfied demand (UD) must equal the demand (D) of those sectors:

$$F_{\ell t}^s + UD_{\ell t}^s = D_{\ell t}^s \quad s \in S; \quad \forall \ell t \quad (1)$$

#### Energy Balance

Fuels are obtained from primary energy (P) of type  $j$  obtained from source  $i$  and converted at facility  $k$  with thermodynamic efficiency  $E$ :

$$\sum_k \sum_j \sum_i p_{\ell t}^{ijk} E_{\ell t}^{jk} = F_{\ell t} \quad \forall \ell t \quad (2)$$

$i \in I; \quad j \in J; \quad k \in K$

#### Energy Reserves

Indigenous resources of energy are limited by the reserves of those resources. For fossil resources,

$$\sum_{p=1}^t P_{jP} \leq R_{jt} \quad j \in J_{\text{fossil}} \quad \forall \ell t \quad (3)$$

So that the total amount depleted by time  $t$  does not exceed the reserves discovered up to that time. For hydraulic potential

$$P_j \leq R_j \quad j: \text{hydro} \quad (4)$$

#### Production Levels

The quantities of fuels produced at any time are limited by the production capacity that exists at that time:

$$F_{k\ell t} \leq K_{\phi k\ell} + \sum_{p=1}^{t-t_k} K_{k\ell p} \quad \forall k t \quad (5)$$

Here,  $K\phi_{k\ell}$  denotes the capacity that existed at the beginning of the planning period for the production of fuel  $\ell$  at plant  $k$ ;  $KA$  is the capacity added, and  $t_k$  is the delay that occurs between the capacity increase and actual increase in the production level. This delay depends on the nature of the plant and is usually proportional to the size of the construction.

The total amount of fuel produced is the sum of the production levels at time  $t$ ,

$$F_{\ell t} = \sum_{k \in KL} F_{\ell t}^k \quad \forall t \quad (6)$$

where  $KL$  is the set of facilities used for the production of individual fuels.

#### Capacity Increases

The new capacity that can be added ( $KA$  in Eq. 5) in any time period is limited. Usually, the limitation is technological in nature. The personnel, accumulation of experience and knowhow, and accumulation of capital equipment needs increase proportionally to the required capacity additions. New capacity added in a given period is restricted by a certain factor ( $KAF$ ) of the capacity addition in the preceding period,

$$KA_{kt} \leq KAF_k KA_{kt-1} \quad \forall kt \quad (7)$$

#### Foreign Currency Shortage

In the majority of developing countries a fast growth rate calls for large payments for the imports of capital goods and materials. These requirements usually result in chronic trade deficit problems and foreign currency may constitute a bottleneck in certain time periods. In such periods, a sort of "rationing" the available foreign currency between competing sectors becomes inevitable. In order to represent this possible limitation, the total foreign spending for the energy system is restricted by the amount ( $Y$ ).

$$\sum_{k \in KI} CKA_t^j KA_t^j + \sum_{j \in JI} CP_t^j P_t^j \leq Y_t \quad \forall t \quad (8)$$

KI : Set of plants requiring imported equipment.

JI : Set of imported primary resources

where the  $C$  prefix denotes unit costs of imports.

#### Objective Function

The objective function of the model is the discounted sum of the costs of: imported primary energy, imported energy technology equipment, local investments and operations; idle capacity of existing plants, and unsatisfied fuel demand. These costs are weighted with different coefficients  $W_i$ , where  $i=1, \dots, 5$  in the order given



above, so that:

$$\begin{aligned}
 Z = & \sum_t \frac{1}{(1+r)^t} \left[ W_1 \sum_{j \in JI} CP_t^j P_t^j + W_2 \sum_{k \in KI} CKA_t^k KA_t^k \right. \\
 & + W_3 \left( \sum_{k \in K} KKA_t^k KA_t^k + \sum_{\ell \in L} F_{kt}^\ell \right) \\
 & \left. + W_4 \sum_{k \in K} (K\phi_t + \sum_{p=1}^t KA_p^t - F_t^k) + W_5 \left( \sum_{\ell \in L} UD_t^\ell \right) \right] \quad (9)
 \end{aligned}$$

#### MODEL VALIDATION

In order to validate the model, it was applied to the Turkish energy sector for the years 1960-1975. Since the details of validation trials have already been described elsewhere (1,2,3), only the crucial points will be mentioned here. In the validation runs, the following assumptions were made:

- i. The (physical) technology coefficients were taken from average aggregate values;
- ii. Fuel demands and primary resources were assigned values equal to their observed or officially recorded values;
- iii. Values of 2.5, 1.5, 1.0, 1.0, and 10.0, respectively, were assigned to  $W_1$  through  $W_5$ .

During 1960-1975, the energy sector did not develop very smoothly; certain abrupt changes took place which had to be reflected to the model. The first such change was a halt in hydroelectricity increase, while the second one was a rise in oil prices. The halt in hydroelectricity growth was the result of a 4-5 year delay in a large hydro project.

In order to take account of these two events, the model was run interactively, much like a simulation model. For the first run which covered the 15-year horizon, oil prices were assumed constant at the 1960 price.

The results of this run were assumed to be valid up to 1968, when the delay in the hydro project began. For the second run, which covered the years 1968-1975, a 6-year delay was introduced, and the results up to 1973 were assumed to be valid, at which time the oil prices went up. In the third run where the oil prices were assigned their higher costs, the model was run for the 1974-1979 period. The results of these runs are summarized in Figures 2 and 3 where primary energy mix and electricity generation mix are given for the 1960-1975 period. The actual data for the same variables are shown in Figures 4 and 5.

#### PRELIMINARY RESULTS FOR 1980-1995

In order to generate possible growth alternatives for the energy sector—and thereby assess the role that nuclear energy can play—the model was run for the next 15-year period. The following assumptions were made concerning the coefficients and parameters of the model:

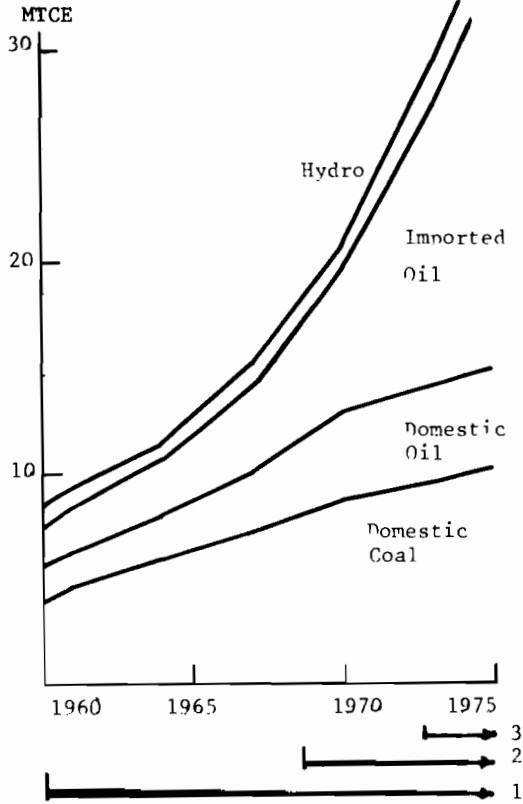

Fig. 2. Primary Energy Mix

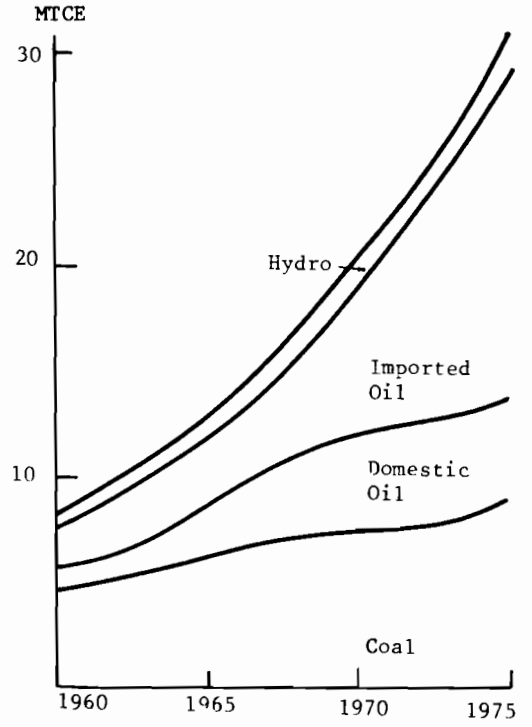

Fig. 4. Primary Energy Mix-Actual Data

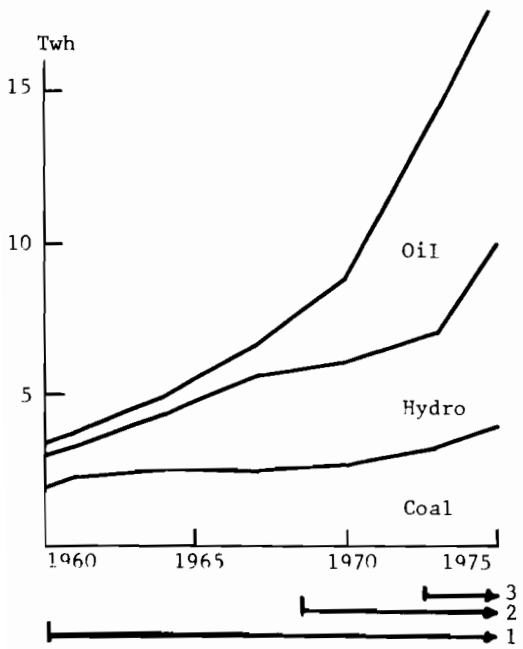

Fig. 3. Electricity Generation Mix

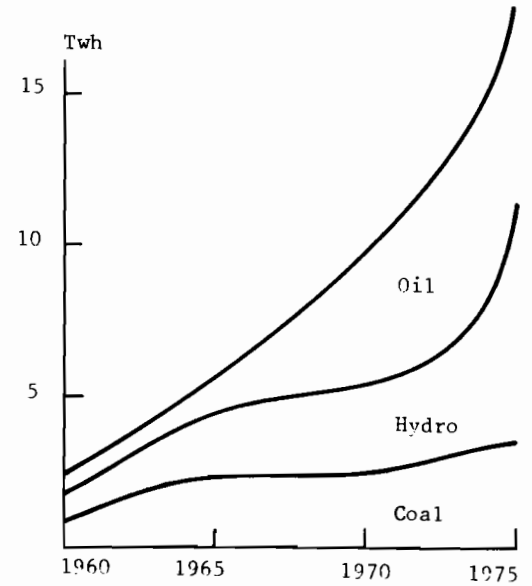

Fig. 5. Electricity Generation mix-Actual Data

- i. Oil import prices were increased by 3% per annum in real terms, starting by \$ 20/barrel in 1979.
- ii. Coal import prices were increased by 2% per annum in real terms, starting by \$50/ton in 1979.
- iii. Indigenous coal extraction capacity increase rate ceiling was allowed to increase.
- iv. Recoverable domestic oil reserve was increased to 90 million tons, two thirds of which being available only after the year 1988.

Except for these, all other values found suitable for the historical growth were retained. Sample results from the preliminary runs are presented below. Scenarios A and B are two such results from about twenty different runs.

For the two scenarios presented, only the energy demand parameters were changed. In scenarios (A), and (B), the annual rates of increase of demand were taken as follows:

	(A)	(B)
Liquid fuels	7%	5%
Solid fuels	7%	10%
Electricity	11%	12%

Furthermore, the present shortage of foreign currency was reflected to the model by reducing the available foreign funds for the years 1980-1985.

Results of these two scenarios are given in Figures 6 through 9, for primary energy mix, and for electricity generation mix. Among other things, it can be seen from the results that the faster growth in coal demand in Scenario (B) forces coal imports, as well as pushing a more rapid development of the hydro resources.

So far, about a dozen scenarios have been tried, to see the influence of different growth rates, energy costs, moratoria, depletion rates, etc. It is expected that as a result of running a large range of possible scenarios, certain robust strategies will emerge. In Figure 10, we can see from the plot of electricity generation mixes of the available scenarios that likely ranges of various sources are already discernible. Once the analysis is completed, it will be possible to extract several other interesting conclusions concerning various trade-offs, shadow prices, costs of alternative strategies, etc..

#### DISCUSSION

The model described above has been used essentially to answer questions of the "What if..." type, both for the analysis of past decisions, as well as for future planning of the energy sector. As a matter of fact, this type of approach is probably the most useful one for the decision-making authorities. There are considerable uncertainties in various aspects of energy planning, and it would be naive to assume that these uncertainties can be resolved by the use of a model, no matter how sophisticated the methodology.

Interactions with decision-making authorities also indicate a need to keep the model as simple as possible. There are several reasons for this, the predominant one being the ease with which communication can be established between modeller and decision-maker. Furthermore, the interpretation of results is also simpler to make.

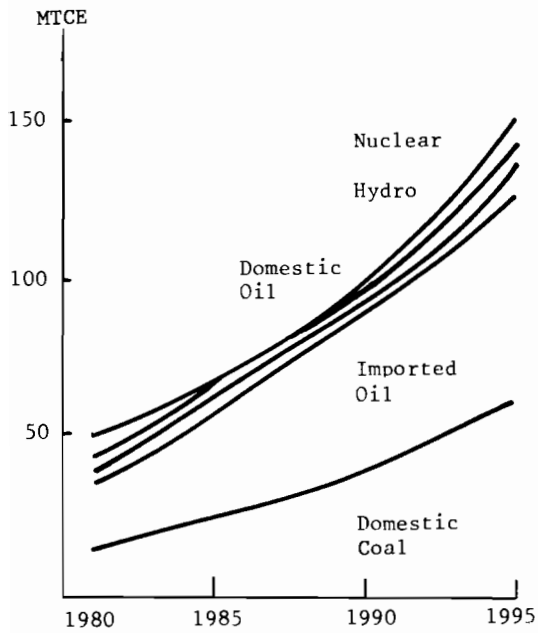

Fig.6. Primary Energy Mix-Scenario A

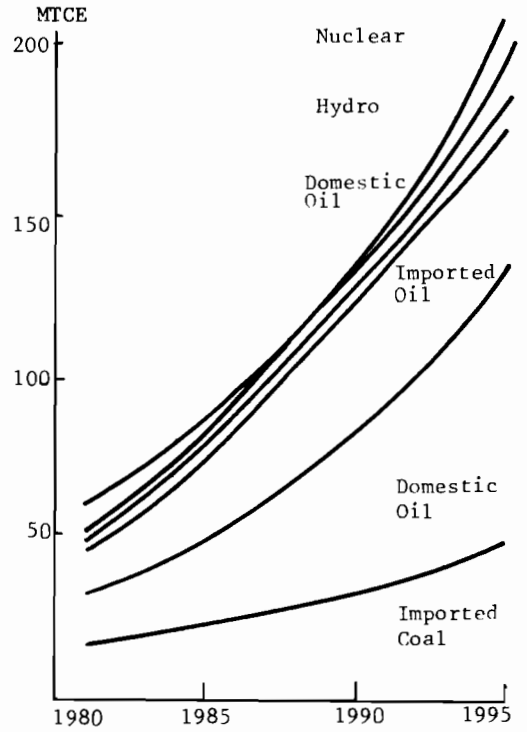

Fig.8. Primary Energy Mix-Scenario B

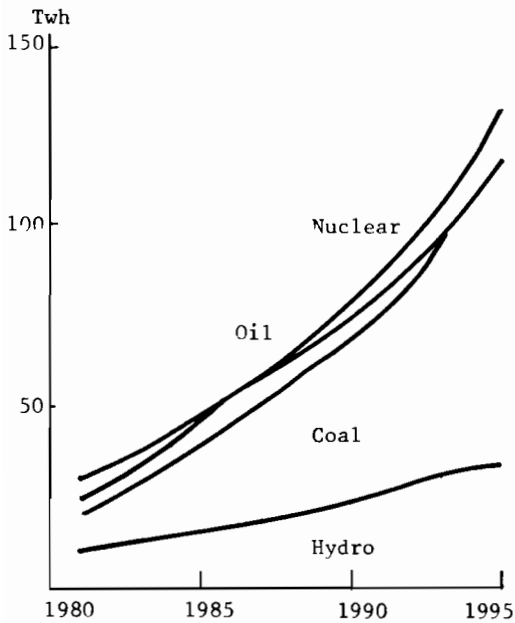

Fig.7. Electricity Generation Mix Scenario (A)

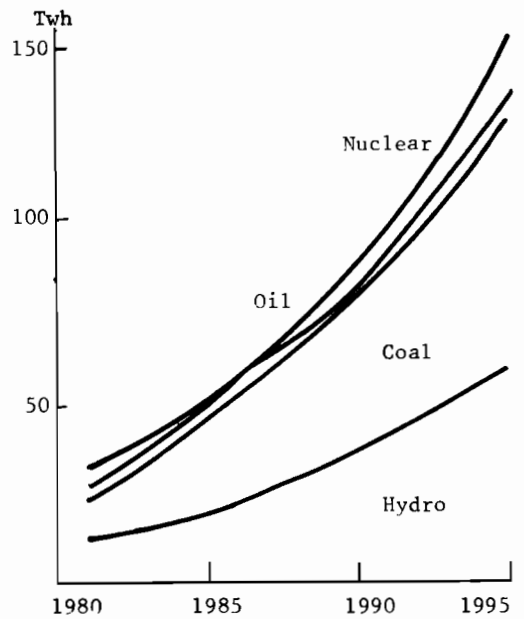

Fig.9. Electricity Generation Mix Scenario (B)

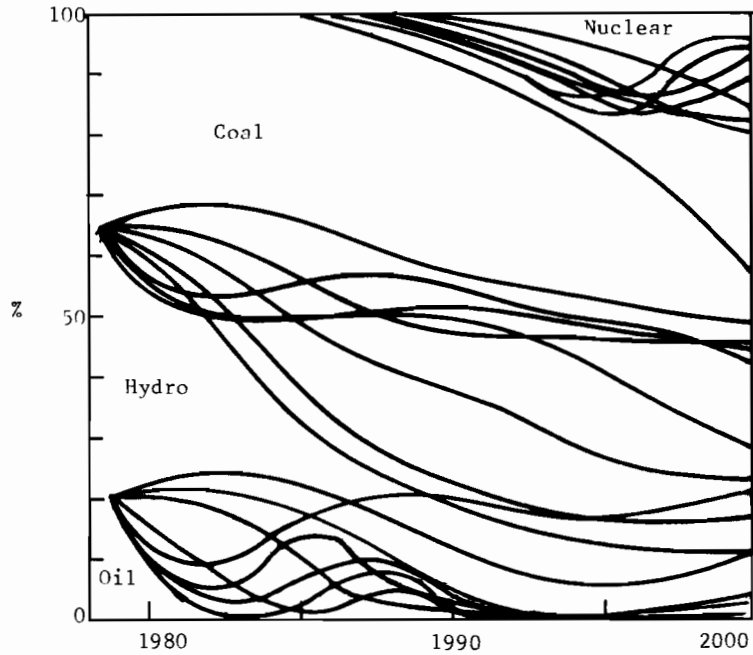

Fig.10. Electricity generation mix in eight different Scenarios

It is difficult, and probably futile, to judge models on the basis of their mathematical formulation. The structure and size of a model depend on the expected use of the model. Furthermore, it is difficult to categorically ascribe potential uses for different types of models. For example, a simulation model can be structured in order to yield near-optimal solutions, while an optimization model can be so formulated as to represent system behaviour much like a simulation model.

Finally, a point must be made concerning the ultimate objectives of formal models. Since the final decisions are actually based on mental models, probably the best use of a formal model is to help improve the capabilities of that mental model.

#### REFERENCES

- Kavrakoğlu, I. (ed), Mathematical Modelling of Energy Systems, Sijthoff and Noordhoff, Holland, 1980.  
Kavrakoğlu, I., "Decision Analysis in the Energy Sector", IFAC Symposium on Control of Economies, Warsaw, June 1980.



# ALTERNATIVE ENERGY FUTURES - A CASE STUDY FOR AUSTRIA

**W. K. Foell\* and J. Richter\*\***

*\*Energy Research Center, University of Wisconsin-Madison, USA*

*\*\*Bundeskammer der gewerblichen Wirtschaft, Vienna, Austria*

## ABSTRACT

Alternative energy/environment futures for Austria for the period 1977-2015 are presented. These futures provide a means of examining alternative energy strategies for Austria and of considering some of their environmental implications. Each future is developed within a framework of policies and assumptions about socio-economic structure, lifestyle, technology of energy use and supply, and environmental management. A range of policies related to issues such as energy conservation, fuel choices and strategies, and environmental protection are examined by comparing the scenario results and their sensitivity to varying parameters. The main tool used in the study is a system of regional energy/environment models developed at IIASA and the University of Wisconsin. The results of the study include descriptions of future Austrian Energy consumption by sector and fuel, of alternative energy supply systems, and of many of the environmental impacts associated with the Austrian energy system. The findings show a strong departure in the downward direction from historical trends in growth of energy use. The study was conducted in an institutional format which provided frequent interaction with a large number of individuals and Austrian institutions for whom the results would be of interest.

## KEYWORDS

Energy planning; energy management; energy policy; Austria; energy models; energy demand; comparative energy studies.

## INTRODUCTION

The main purpose of this paper is to show how a system of models can be used in a systematic way to describe alternative energy futures and the environmental effects related to energy use. The assumptions and major results of a case study for Austria<sup>1</sup> are presented here to illustrate the possible role of the general approach as an instrument to solve problems of resource management. The contribution does not aim at a detailed discussion of methodological aspects of the work;

---

<sup>1</sup>For a detailed documentation of the IIASA Energy/Environment Case Study for Austria, see (Foell, 1979).

they are described in several of the references.

This work is the fourth of a series of IIASA regional case studies of energy/environment management; the first three were conducted in 1975/76 on three greatly differing regions, namely, the German Democratic Republic, the Rhone-Alpes region in France, and the State of Wisconsin in the U.S.A. They are described in detail in (Foell, 1979).

The Austrian study had two primary objectives: (1) To examine alternative energy futures and strategies for Austria and to consider some of their environmental implications; and (2) to investigate concepts and methodologies for energy/environment management and policy design in Austria.

The establishment of these objectives was based upon the conviction that in Austria, as in most regions and nations of the world, there is an urgent need for the development and application of methods for studying energy systems and for testing the impact of alternative policies. In view of the major role which energy plays in the determination of environmental quality, this study was designed to aid in the integration of energy and environmental management from a systems perspective.

The issues and strategies studies were chosen through an iterative procedure, beginning with suggestions at a three-day workshop attended by 28 members of Austrian energy and environmental communities (private and public sectors), followed with exploration by the IIASA team to see whether they could be analyzed within the time and resource limitations of the study. One major decision was that this study would address broad mid- to long-term strategies and policies. Consequently, the time horizon of the study was 2015. The major issues fell into the following categories: Energy Demand; Energy Conservation; Energy Supply Options and Strategies; and Environmental Impacts and Protection Strategies.

## BASIC CONCEPTS

### Scenario Writing

The Austrian case study used scenario building and energy system modelling as a formal quantitative approach to policy analysis and the examination of energy/environment strategies. To present a more comprehensive picture of the use of the energy/environment models described in the following paragraphs, it is appropriate to summarize here the scenario framework.

In order to specify a policy set or a framework within which a scenario could be built, it was necessary to develop a means for expressing a policy in terms of a limited number of characteristics. Each characteristic is associated with one of four main categories of Scenario Properties, namely:

- 1) Socio-Economic Structure; 2) Lifestyle;
- 3) Technology; 4) Environment

Within the framework of these four general categories, a large number of assumptions about future events and/or policies and strategies can be combined. This framework then provides the exogenous functions, boundary conditions, and constraints for the models and data bases with which the details of the energy/environment scenario are calculated.

As an example of the specification of scenarios, Table 1 displays a matrix overview of the four scenarios developed in the Austrian case study. The rows of the matrix constitute scenario characteristics within the four main categories. They



TABLE 1 Overview of scenarios S1 – S4.

Summary characteristics		Scenario S1 (Base Case)	Scenario S2 (High Case)	Scenario S3 (Low Case)	Scenario S4 (Conservation Case)
Socio-economic structure	Population	Average Austrian growth rate of 0.22%/yr			
	Human settlements	Migration important: rural to urban; Vienna declining; western cities grow more rapidly			
	Economy	Medium growth rate 1970–1985: 3.30%/yr 1985–2015: 1.76%/yr	High growth rate 1970–1985: 3.43%/yr 1985–2015: 2.73%/yr	Low growth rate 1970–1985: 3.23%/yr 1985–2015: 1.21%/yr	Low growth rate 1970–1985: 3.23%/yr 1985–2015: 1.21%/yr
Lifestyle	Personal consumption	Current trends in personal consumption	Higher consumption than in S1	Lower consumption than in S1	Lower consumption than in S1
	Transportation	Car ownership 300 vehicles/1,000 population	Car ownership 400 vehicles/1,000 population	Car ownership 250 vehicles/1,000 population	Car ownership 300 vehicles/1,000 population
	Housing	Bigger new homes (0.8 m <sup>2</sup> /yr) Emphasis on electrical appliances and convenient fuels	New home size increases faster than in S1 High emphasis on electrical appliances and convenient fuels	New home size increases more slowly than in S1 Less emphasis on electrical appliances and convenient fuels	Same as S3
Technology	Industry	Overall decrease in energy intensiveness through significant penetration of energy conserving technology	General increase in intensiveness	Overall decrease in energy intensiveness through significant penetration of energy conserving technology	Significant decrease in energy intensiveness through vigorous development and implementation of energy conserving technology
	Transportation	Car efficiency 8.9 liter/100 km	Car efficiency 12.3 liter/100 km	Car efficiency 8.9 liter/100 km	Car efficiency 7.0 liter/100 km
	Housing	1971 insulation standard	1971 insulation standard	By 2000 new homes 40% better than 1971 insulation standard	By 2000 new homes 55% better than 1971 insulation standard
	Energy supply	Decreased emphasis on coal Electricity demand grows more rapidly than total end-use energy demand			
		Adequate oil and gas supply	Adequate oil and gas supply	Adequate oil and gas supply	No nuclear growth Constrained oil supply
Environment	Environmental regulations	Proposed SO <sub>2</sub> oil desulfurization regulations by 1981 plus U.S. emission limits of SO <sub>2</sub> , all sources, by 2000			
		0.50 of U.S. emission limits on SO <sub>2</sub> , point sources, by 2015	0.42 of U.S. emission limits on SO <sub>2</sub> , point sources, by 2015	0.71 of U.S. emission limits on SO <sub>2</sub> , point sources, by 2015	Same as S3
		1.18 of U.S. emission limits on particulates, industry point sources, by 2015	1.0 of U.S. emission limits on particulates, industry point sources, by 2015	1.60 of U.S. emission limits on particulates, industry point sources, by 2015	Same as S3
U.S. emission limits of particulates, electric power plants, by 2015					

are specified for each of the four scenarios studies (Base Case, High Case, Low Case, and Conservation Case) in the four right-hand columns of the table. As indicated in the first row, some of the specified characteristics were common to all Austrian scenarios, e.g. population growth. In contrast, among scenarios (row 7). Considerable attention must be devoted to internal consistency among the specified characteristics, although one can never ensure complete consistency.

Characteristics such as those in Table 1 provided the major inputs to the models. Some of the models have direct links to several of the characteristics in the table. For example, inputs to the personal transportation model are directly specified by several of the characteristics in Table 1, including 1) human settlement patterns, 2) transportation lifestyle (car ownership), 3) technical efficiency of cars, and 4) car emission standards.

#### A System of Energy/Environment Models

The overall system of models is a set of submodels which combine data and information about energy flows to describe or simulate the energy system and its relationship to other characteristics, e.g., demography, the economy and the environment. An overall simulation framework integrates the variety of analytical techniques employed.

The system of models has five major components:

- I Socioeconomic Activity Models
- II End-use Energy Demand Models
- III Energy Conversion and Supply Models
- IV Environmental Impact Models
- V Preference and Decision Models

The general flow of information between these models, shown in a highly simplified manner in Figure 1, is summarized as follows.

- I) Regional socio-economic information (e.g., population settlement patterns, economic activity) is provided exogenously and/or by models.
- II) The socio-economic information serves as input to energy demand models which are structured according to economic sector (e.g., industrial, service, agriculture,) or by technological process (e.g., heating, cooling, lighting).
- III) The outputs of the energy demand models form the input to energy supply models which in turn are used to calculate primary energy requirements, needed conversion and transport facilities, supply system costs, etc. Supply requirements are directly matched to demand or related to demand within a framework of constraints; in addition, a resource allocation model based on minimization of a cost function was used in the Austrian study.
- IV) The energy flows in the supply system and the end-use energy serve as inputs to the environmental impact models; these models calculate a broad spectrum of impacts, including human health and safety, on both a systemwide and subregional localized basis.
- V) Indicators from the demand, supply and environmental models are linked to formal quantitative "Preference models" which allow the use of a multiattribute objective function for the evaluation of alternative strategies (Buehring, 1978).

There are additional flows of information between the major components as indicated by the dashed lines in Figure 1. In general, although not in all cases, the

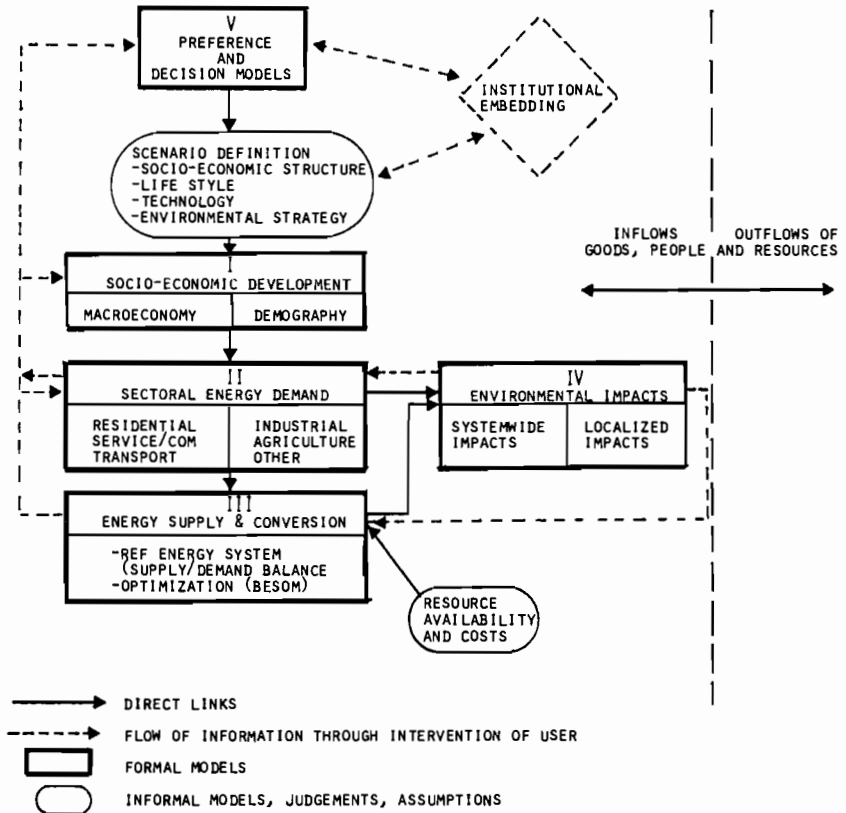

FIGURE 1. SIMPLIFIED DIAGRAM OF OVERALL INFORMATION FLOW WITHIN THE SYSTEM OF MODELS.

dashed flows (feedbacks) are implemented by intervention of the model user and not by formal mathematical links. Some of the models in the system are highly formalized; others are of rather simple structure, depending on the relative importance of the aspect covered and on the availability of data. The following paragraphs illustrate briefly the diversity of approaches within the system. For a fuller description see (Foell, forthcoming, and Foell, 1979).

Socio-economic development. Socio-economic development was simulated by the help of a demand-oriented input-output model (Richter, 1973) which was originally designed for medium-term simulations. Based on specific assumptions about the overall economic development of Austria's foreign trade partners and on technological changes in Austria, this model provides for each year full input-output tables at constant prices and thus consistent forecasts for all the 31 sectors distinguished. This great sectoral detail has three advantages for deriving energy demand projections: (1) one can capture the change in the level and structure of energy demand that is attributable to different rates of expansion of the intermediate sectors (it has been shown (Bayer, 1975) that the elasticity of energy consumption in Austrian industry observed between 1960 and 1974 would have been considerably smaller if all branches had grown at the same rate as the average for the whole industry); (2) the introduction of assumptions about technological changes and changes in the evolution of final demand is transparent; and (3) it facilitates the analysis of environmental effects associated with the production and consumption of energy.

Energy demand. The energy demand modeling and assessment was carried out at the point of final or end-use demand. A four-sector classification of energy demand was used for Austria: Residential, Commercial and Service, Industrial, and Transportation. Each user class is the basis for a demand model which examined the energy consumption within the sector. Further sector disaggregation within each demand model is determined by policy issues of the region and by data availability. Analysis of energy consumption was done by fuel type and, when possible, by physical process.

The models are simulation models with one year time steps. The models might best be characterized as technological process models, with socio-economic variables as the exogenous inputs. Socio-economic feedbacks from the demand models are in general not implemented formally within the models but rather by intervention of the model user. The general structure of these relationships is shown in Figure 1. Brief overviews of the models are given below.

The residential model (Poenitz, 1978 and Buehring, 1979) focuses on the household, which is analyzed in terms of base (space and water heating, and central air conditioning, if appropriate) and secondary appliances (e.g. refrigerator, stove, television). Important aspects of the model included determination of the number, type, and quality of housing units, their heating source as well as the number of appliances and the energy use of these appliances.

In the commercial and service, industrial, and agricultural sectors, the models were based upon 1) the level of economic activity in the sectors or sub-sectors (as described by the input-output model); and 2) the energy intensity per unit of activity. In a first step the overall energy intensity was determined by sectors; in the second step the fuel mix in these sectors was projected.

In the transportation sector (Hanson, 1979) the model divides the sector into personal travel and freight components. The procedure for projecting personal travel energy use was to estimate personal travel in terms of person kilometers by mode, convert this to vehicle kilometers based on vehicle use characteristics, and finally to convert vehicle kilometers to energy use based on vehicle technological characteristics. For the freight component, ton kilometers by mode were directly related to industrial, commercial and service, and agricultural activity. In the Austrian study, transportation activity was included as a sector in the input-output model.

Energy supply. In the Austrian case study two approaches were used to examine energy supply questions. First, a demand/supply balance technique was employed, in which energy supply was matched to energy demand; however, it was necessary to evaluate supply options for electricity and district heat generation. Although no formal computer-implemented model was used in this analysis, it reflects Austria's historical experience and future plans.

To complement the demand/supply balance approach, a formal resource allocation model was applied to the S1, S2 and S3 1990 end-use demands. This analysis was performed using the Brookhaven Energy System Optimization Model, BESOM (Hoffman, 1973), which is a resource allocation model developed at Brookhaven National Laboratory and designed to examine interfuel substitution within a framework of constraints on the availability of competing resources and technologies and their associated costs. For this study, a version of the Brookhaven model was modified to reflect the specific characteristics and structure of the Austrian energy system, including appropriate technologies, coefficients, and costs. Three alternative reference energy systems were developed for Scenarios S1, S2, and S3, for the year 1990. These reference energy systems were based on a minimization of total system costs in that year.

Environmental Impact. A large set of environmental impacts due to energy use in Austria was calculated for each scenario by the environmental simulation models. The models, developed at the University of Wisconsin and IIASA for regional studies, have been reparameterized and adapted to Austrian conditions.

As shown in Figure 1, both end-use energy demand and primary energy requirements are inputs to the environmental models. Impacts at each point in the fuel chain are calculated, i.e. extraction, transportation, processing, conversion and direct use. This means that impacts occurring both inside and outside Austria are considered.

These fuel chain impacts were calculated for reference coal, nuclear, oil and gas systems, including impacts associated with electricity generation. A reference energy system represents the average characteristics of the fuel chain for the entire region; these so-called "system impacts" are not site-specific (Buehring, 1975; Buehring, 1976; Foell, forthcoming). In contrast, localized impacts were calculated for air pollution due to end-use combustion of fuels, taking spatial characteristics of the region into account. The air pollution impacts are primarily concerned with human health at the urban level (Dennis, 1976; Dennis, 1978)

The impacts calculated by the environmental models are called "quantified impacts". They do not represent all of the impacts known to occur; the quantified environmental impacts are the impacts which we judge to have an adequate scientific basis. Since not all quantified impacts were calculated, these models present only one perspective on the system of impacts. Impacts are for each simulation year; time-dependent calculated changes stemming from regulations or technological advances are taken into account.

#### MAJOR FINDINGS

The findings are not the result of any single scenario but rather were deduced from the analysis of the entire set of scenarios and sensitivity studies. Although the findings, in general, are applicable to the long run (2015), more attention has been devoted to the initial two decades of the study. The major findings of the study are as follows:

##### Energy Demand

- (1) Total energy demand will probably increase at a rate considerably lower than in the past two decades. If these lower demand estimates are valid, they imply major rethinking of Austrian energy supply policies that are based on higher overall projections.
- (2) An overall "societal energy intensiveness," defined roughly as primary energy use per unit of GNP, will probably decrease over the coming few decades.
- (3) Electricity will supply an increasing fraction of total end-use energy. Nevertheless, growth of electricity generation will be much lower than historical rates. Needs for future facilities should be examined in light of their dependence on the structure and rate of Austria's economic development.

Total electricity generation requirements for the four scenarios are illustrated in Figure 2, along with historical data for the 1945-1971 period. A comparison between the high growth scenario (S2) and the conservation scenario (S4) shows that S2 requires over twice as much electricity in 2015. This large increase would lead to extremely high levels of fuel imports. In all scenarios except S2, the growth in electricity is less than historical trends.

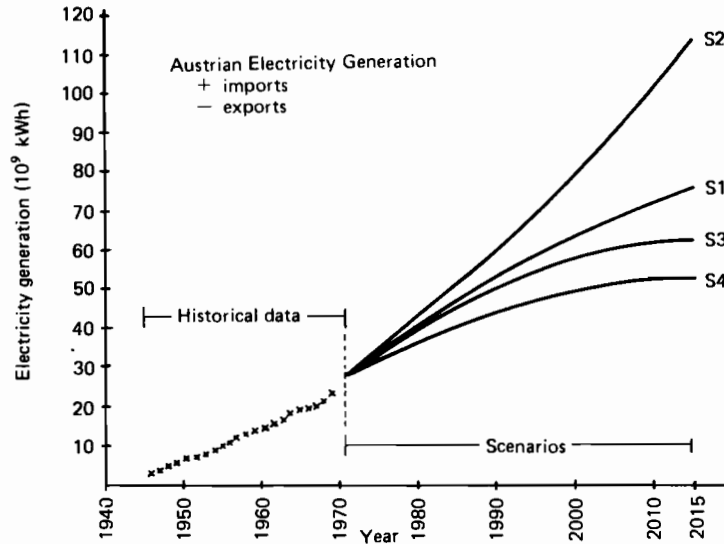

Fig. 2. Electricity generation: Historical data and scenarios, S1-S4.

(4) The continued dominance of the industrial sector in energy use suggests that policy measures for altering energy-use patterns must focus largely on this sector. However, energy demand growth in the next few decades appears to be greatest in the service sector of the economy, with the lowest growth likely in the transportation sector.

(5) There is considerable potential for energy conservation by means of improved insulation practices in the residential sector. Because of the institutional barriers related to initial costs, the realization of the economic benefits of this potential may require vigorous government support of conservation measures.

### Energy Supply

(6) Nuclear power could play a major role in electricity generation over the next several decades. However, during the time period considered, the continued slowing of electricity demand growth, coupled with further vigorous conservation measures, could make future nuclear plants unnecessary if hydropower were exploited fully\*.

(7) Coal is generally considered to be an unattractive long-term supply option for Austria. However, our economic analysis of the Austrian energy supply system, based on a resource allocation model for the year 1990, indicated that a shift toward increased reliance on lignite, coupled with decreased reliance on gas and petroleum, would be cost effective. However, the associated environmental impact would be significant.

(8) Extrapolation of most previous Austrian energy forecasts yields a continuation of the trend toward greater reliance on petroleum and natural gas. However, as-

\*In a national referendum on November 5, 1978, a majority voted against putting Austria's first nuclear plant (Zwentendorf) into operation. As a result, plans for developing nuclear power in Austria have been laid aside. In the study reported here, Scenario S4 describes a non-nuclear future.

assessment of world petroleum resources and future demands demonstrates a serious gap between potential petroleum demand and supply in Austria in the 1990's, even under the assumption of low growth (Conservation Scenario S4). It would be possible, from a technical standpoint, to close the gap in the conservation case by shifting to coal in the industrial sector. In the commercial and residential sectors, a continued reliance upon, or shift back to, coal and wood could help in avoiding shortfalls in rural areas. In urban areas a shift to district heat (possibly coal-fired) could decrease the reliance on petroleum.

### Environment

(9) Potential system-wide environmental impacts due to energy use and supply in Austria are appreciable. Because of continuing energy demand growth, the system-wide impacts would not significantly decrease over the time period studied, despite introduction of improved pollution control technology.

(10) Air pollution will be the largest contributor to energy-related impacts on public health. These air pollution impacts will be concentrated in the five major urban areas of Austria, namely, Vienna, Salzburg, Graz, Linz, and Innsbruck.

(11) Desulfurization of fuel oil for use in urban residential and commercial buildings would be an effective and important measure for protecting the public from health effects of sulfur emissions.

(12) Regional and local environmental effects due to Austria's energy system are significant. However, there is also a family of effects whose significance is better assessed from a global perspective. Examples of these are long term climate modifications due to CO<sub>2</sub> emissions from combustion of fossil fuels, and potential dangerous flows of fissile material within the nuclear fuel cycle. Such global concerns can and must be addressed from an international perspective to avoid the "tragedy of the commons" on a global scale.

### Sensitivity Studies

In addition to the scenarios studied, a large number of sensitivity analyses were conducted. Several of these proved to be of great interest to government and industrial organizations in Austria; two of these are summarized here.

Petroleum shortfalls - closing the petroleum gap. The present uncertainty surrounding world petroleum reserves and production rates, and its impact on future supply availability, was an extremely important concern in developing a comprehensive energy strategy. Results of recent studies forecast potential petroleum shortfalls developing in the mid- to late-1980's. This study estimated Austria's future oil supplies using a world forecast developed by the Workshop on Alternative Energy Strategies (WAES) (Wilson, 1977). The petroleum supply curve was based on the 33 Million Barrels of Oil Per Day (MBOD) production limit (non-communist countries) scenario with a reserve addition rate of 10 billion barrels per year and 3% economic growth. The WAES supply curve peaks shortly after 1990.

As a basis of comparison of supply and demand in Austria, petroleum imports to Austria were assumed to decrease at the same rate as total world production. This leads to a petroleum shortfall of 20 million barrels of oil per year (about 0.05 MBOD) by 2015. In scenario S4, as illustrated in Fig. 3, this sizeable shortfall develops despite the low growth in energy demand resulting from conservation measures, lower economic growth, and the phasing out of petroleum for electrical generation.

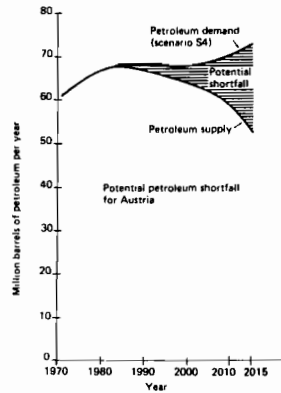

Fig. 3. Divergence between demand and estimated petroleum supply in scenario S4.

A sensitivity study was developed for Scenario S4 in the year 2015, in order to study the feasibility of relieving the petroleum "shortfall" through shifts to other fuels. In the sensitivity study, fuel shifts were assumed to occur in the industrial, commercial, and residential sectors. The rationale for shifts in the industrial sector was based upon a 1975 Viennese investigation of fuel substitutability in major industries (Bundeskammer, 1976). This study considered technical changes which must accompany such fuel shifts, as replacement of boilers, storage of solid fuels, and the construction of gas pipelines. The investigators found that the largest Austrian industries, which consume over 80% of the nation's heavy fuel oil, would be capable of reducing their reliance on this fuel by 40%, through shifts to coal, natural gas, and coke. In the S4 sensitivity study, similar substitutions were assumed for the industrial sector (with the exception of natural gas, because of uncertainty about the availability of this fuel in 2015).

A decrease in petroleum consumption in the residential and commercial sectors could be achieved by 2015 through stepped-up construction of waste- and coal-fired district heating plants, as well as through a slowing of the shift away from coal-burning ovens in urban apartments. In rural areas greater use of coal and wood for space-heating is feasible. It was also anticipated that new technologies, such as solar heating, could replace as much as 20% of petroleum requirements in the residential sector by 2015.

Figure 4 shows the results of the sensitivity study in terms of an alternative primary energy fuel mix. Because of the need to decrease the absolute quantity of petroleum by 30% in order to relieve the petroleum shortfall, the importance of this fuel dropped from 43% of primary energy requirements in the regular S4 case in 2015 to 31% in the sensitivity study. At the same time, the percentage of total primary energy requirements met by hard coal and lignite increased from 13% in the regular S4 case in the year 2015 to 24% in the sensitivity study.

#### Effectiveness of SO<sub>2</sub> Control

In a sensitivity study designed to address the effectiveness of the SO<sub>2</sub> emission standards, the U.S. standards and the oil desulfurization policy of Scenario S1 were sequentially removed to evaluate the effect of these regulations on emissions and on human health. The results are presented graphically in Figures 5 and 6. While all standards have a significant effect on SO<sub>2</sub> emissions, only the petroleum desulfurization has a significant effect on health impact. This is because residential and commercial emissions (not affected by the U.S. standards) more strongly



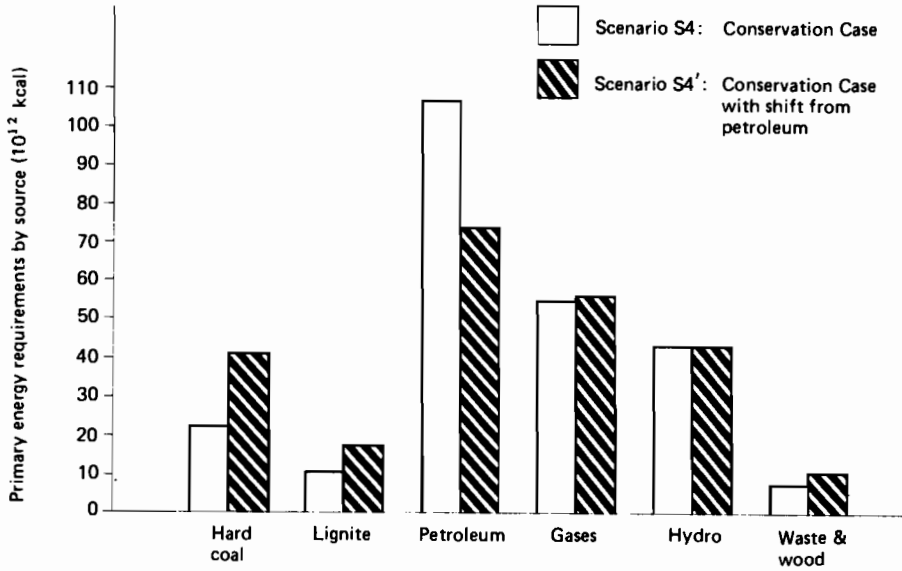

Fig. 4. Alternative primary energy fuel mix for closing the petroleum gap: Conservation case (S4) for the year 2015

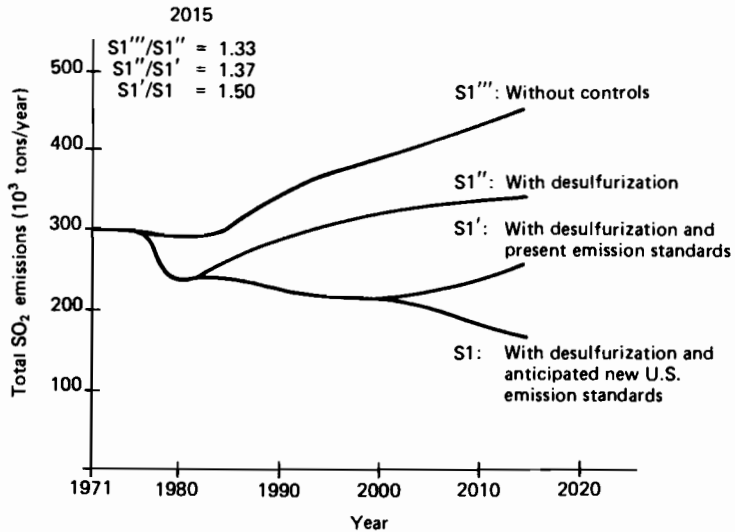

Fig. 5. Sensitivity of SO<sub>2</sub> emissions to SO<sub>2</sub> regulations.

affect health in urban areas per unit of emissions than industrial or electrical plant sources of emissions. A further significant reduction in the human health impact would require more stringent standards than assumed here for the sulfur content of the fuels used by the commercial and service and the residential sectors.

Another strategy to further reduce health impacts would be to implement conservation programs and insulation standards in the residential and commercial sectors to reduce the amount of fuel required for space heating; this would have the same effect as setting more stringent SO<sub>2</sub> emission standards. However, there can be a

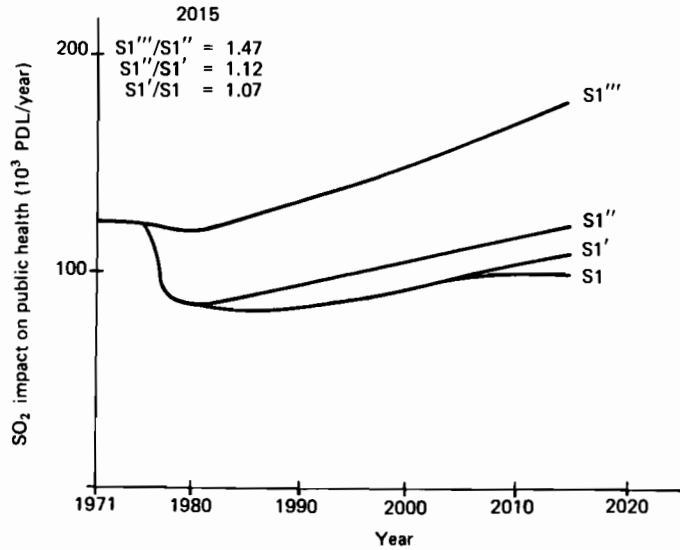

Fig. 6. Sensitivity of air pollution public health impacts to SO<sub>2</sub> regulations

long time lag before any conservation effect is seen, due to the length of the time involved in implementing insulation standards. Therefore, the SO<sub>2</sub> regulations of the nature described here should be considered as an effective means for protection of public health.

#### CONCLUDING REMARKS

The assessment of alternative energy/environment futures up to 2015 has, because of the broad systems perspectives that it provides, contributed to a better understanding of the overall energy and environmental problems of Austria. This perspective is particularly important in the current period of transition in Austria's energy use patterns. At the same time, the Austrian case study demonstrated the feasibility and usefulness of the adopted approach: building alternative scenarios on the basis of a system of linked quantitative models.

The dominant philosophy underlying the development of this system of models has been one of continuous evolution and refinement and an insistence upon the maintenance of flexibility. This strategy was an outgrowth of the perception of the energy problem as a rapidly changing one in a period of great uncertainty. This uncertainty led to a research approach which stresses flexibility and room for innovation. It also has underscored the importance of a continuing process moving through the sequential phases of modelling: 1) Model conception, 2) model development and testing, 3) implementation and use in policy formation and decisionmaking, and finally, 4) feedback bringing about refinement and further conceptualizing.

To avoid inconsistency, the general concept of combining submodels of various degrees of refinement in a flexible way requires careful consideration by the model user of all the interrelationships and feedbacks which are not implemented formally. On the other hand the same concept allows the general use of models developed for different countries and regions, and achieves a degree of flexibility which probably never can be achieved in one large model covering all aspects of the energy system. Although it is unlikely there will ever be a universal system of energy/environment models, a long range goal of this research continues to be the

generalization of the approaches into a coherent process for sound resource management in all regions of the world.

#### ACKNOWLEDGEMENTS

The work summarized was conducted by a core research team at IIASA, in collaboration with the University of Wisconsin-Madison, and in cooperation with a large number of individuals and institutions. Members of the core research team were R.L. Dennis (1), W.K. Foell (1,2), M.E. Hanson (1,2), L.A. Hervey (1), A. Hoelzl (1), J.P. Peerenboom (2), and E. Poenitz (1). Individuals who made substantial research contributions include: W.A. Buehring, J.L. Pappas, and J.R. Peerenboom (University of Wisconsin); A. Kydes (Brookhaven National Laboratory); J. Richter (Bundeskammer der gewerblichen Wirtschaft); and A. Toifelhardt (IIASA). The work was made possible through a generous grant from the Austrian National Bank. (1) IIASA; 2) U. of Wis.)

#### REFERENCES

- Bayer, K., "Der Energieverbrauch der Oesterreichischen Industrie 1960-1974", WIFO, Monatsberichte, 48, 8 (1975), pp. 348-358, Wien.
- Buehring, W.A., A Model of Environmental Impacts from Electrical Generation in Wisconsin, Ph.D. Dissertation, Dept. of Nuclear Engineering, Univ. of Wisconsin, Madison, 1975.
- Buehring, W.A. and W.K. Foell, Environmental Impacts of Electrical Generation: A System-wide Approach, RR-76-13, International Institute for Applied Systems Analysis, Laxenburg, Austria, 1976.
- Buehring, W.A., R.L. Dennis and A. Hoelzl, Evaluation of Health Effects from Sulfur Dioxide Emissions for a Reference Coal-fired Power Plant, RM-76-23, International Institute for Applied Systems Analysis, Laxenburg, Austria, 1976.
- Buehring, W.A., and others, "Examining Energy/Environment Policy Using Decision Analysis", Energy Systems and Policy, 2, (3), (1978).
- Buehring, J., A Model of Residential Energy Use in Wisconsin, Energy Research Center Memorandum, University of Wisconsin-Madison, 1979.
- Bundeskammer der Gewerblichen Wirtschaft/Sektion Industrie, Auswertung der Erhebung ueber die Substitutionsmoeglichkeit von Heizoel Schwer, Internes Dokument, Mai 1976.
- Bundesministerium fuer Handel, Gewerbe und Industrie, Energieplan 1976, September 1976.
- Dennis, R.L., Regional Air Pollution Impact: A Dispersion Methodology Developed and Applied to Energy Systems, RM-76-22, International Institute for Applied Systems Analysis, Laxenburg, Austria, 1976.
- Dennis, R.L., The Smeared Concentration Approximation Method: A Simplified Air Pollution Dispersion Methodology for Regional Analysis RR-78-9, International Institute for Applied Systems Analysis, Laxenburg, Austria, July 1978.
- Foell, W.K., and others, A Family of Models for Regional Energy/Environment Analysis, Forthcoming, International Institute for Applied Systems Analysis, Laxenburg, Austria.
- Foell, W.K. (ed.) Management of Energy/Environment Systems: Methods and Case Studies, John Wiley and Sons, Chichester, 1979.
- Foell, W.K., and others, Assessment of Alternative Energy/Environment Futures for Austria, 1977-2015, RR-79-00, International Institute for Applied Systems Analysis, (1979)
- Hanson, M., Personal Transportation Energy Policy Options, Energy Research Center Report, University of Wisconsin-Madison, 1979.
- Hoffman, K.C., A Linear Programming Model of the Nation's Energy System, Brookhaven National Laboratory, February 1973.
- Poenitz, E., Residential Energy Use Model for Austria (REUMA), RM-78-68, International Institute for Applied Systems Analysis, Laxenburg, Austria, 1978.
- Richter, J., und W. Teufelsbauer, Oesterreichs Wirtschaft bis 1985: Eine nach 31

Wirtschaftszweigen gegliederte Prognose mit Hilfe des Input-Output Modells AUSTRIA  
II, Forschungsbericht Nr. 10, Bundeskammer der gewerblichen Wirtschaft, Wien, 1973.  
Wilson, Carrol, Energy: Global Prospects 1985-2000, McGraw-Hill, New York, 1977.

# A STOCHASTIC MODEL FOR ELECTRICITY GENERATION

**F. Louveaux\* and Y. Smeers\*\***

*\*Facultés Notre Dame de la Paix, Département de Méthodes Quantitatives  
Namur, Belgium*

*\*\*Université Catholique de Louvain, Department of Industrial Engineering and  
C.O.R.E., Louvain-la-Neuve, Belgium*

## ABSTRACT

Uncertainty in energy policy modeling is usually handled by the technique of establishing scenarios. Various assumptions are made on the uncertain elements and deterministic models are run under the corresponding scenarios. A strategy is then derived based on the results of these runs.

In this paper we consider a specific model for the power generation planning problem when some future data are uncertain. The model is based on a particular non-linear programming formulation of the power generation problem which leads to a very compact mathematical program. As a consequence, rather complex event trees can be considered at reasonable computational cost. A realistic application is presented and its solution analyzed. It is shown that, even for problems where the value of information is expected to be low, the structure of the solution may be more satisfactory than that usually obtained from deterministic models.

## KEYWORDS

Stochastic programming, decision under uncertainty, power generation planning, piecewise quadratic programming.

## INTRODUCTION

Tackling uncertainty is probably one of the stumbling blocks of energy policy modeling. The difficulty of dealing adequately with an uncertain future is illustrated by the numerous energy planning studies done under various scenarios, and by the ongoing effort to update these scenarios as soon as new information becomes available. Notwithstanding its interest, the subject does not seem to have received, among energy modelers, the methodological attention that it would seem to deserve from its practical importance. Apart from the work of Manne and his co-workers (Manne, 1974) (Hung-po Chao, 1979) (Richels, 1979), stochastic energy models are seldom referred to in the literature (Manne, 1979) : instead the current approach of dealing with uncertainty is to run deterministic models under various assumptions and to derive, using more or less formalised approaches, a strategy from the set of obtained results.

Several reasons can probably be put forward to explain this apparent lack of interest in systematic techniques dealing with uncertainty. Among them it seems clear that the complexity, and in particular the enormous size, of the optimization problems that one is naturally lead to when dealing directly with uncertainty is a strong deterrent from using formalized approaches to the problem. It should also be added that the value of information is often low in the usual planning models (Manne, 1974) and that it is mainly for the study of R-D strategies that stochastic models are most relevant.

In this paper we consider the case of a power generation system and provide a specific nonlinear stochastic model adapted to that problem. A major advantage of our formulation is that it leads to a mathematical program of much smaller size than the deterministic equivalent which would result from usual linear programming approaches. The model is then solved using a particular algorithm for piecewise quadratic programming which we think also presents definite advantages compared to more classical approaches (Louveaux, 1979).

The practical interest of focusing on the power generation system for illustrating the problems related to uncertainty is clear : this sector is characterized by important substitution possibilities in its inputs (oil-coal-nuclear), and hence exhibits quite broad options; on the other hand, the very long lead time and service life of its plants require the planning process to be based on rather long term projections where uncertainty can play an important role. The power system is also susceptible of significant developments in the future, as new technologies which are still in the realm of research and development (for example FBR, underground gazification, photovoltaic cells ...) come to maturity.

Because of the limited space allowed for this paper, the exposition will concentrate on the presentation of the model and on a relatively simple application. More involved problems are discussed in a companion paper (Louveaux and Smeers, 1979) and will be alluded to in the oral presentation. Although the example dealt with here does not belong to the class where stochastic models are most useful, its solution already exhibits some interesting features which are difficult to obtain by purely deterministic approaches.

#### THE NONLINEAR DETERMINISTIC MODEL

Power generation planning is commonly modeled using linear programming (Anderson, 1972) and only a few nonlinear programming versions of the problem seem to have been proposed (Breton and Falgarone, 1972), (Juseret, 1978). In this work we rely on a quadratic programming formulation of the problem already discussed in Louveaux (1979). In order to introduce the model we consider the piecewise linear approximation of the load curve represented in Fig. 1, where we distinguish three zones : the base load (rectangle  $\alpha\gamma\theta\tau$ ), the medium load (trapezium  $\alpha\beta\delta\gamma$ ), and the peak load (triangle  $\beta\delta\epsilon$ ). Let  $I = \{1, \dots, n\}$  denote the set of equipment types and  $e_i$  be the operating cost of a plant of type  $i$ ; we shall assume the elements of  $I$  to be ranked according to the merit order of the plant :

$$e_1 < e_2 < \dots < e_n$$

Let  $x_i$  be the available capacity of equipment  $i$  at some period. We shall write

$$x_i = b_i + m_i + p_i + s_i \quad (1)$$

where  $b_i$ ,  $m_i$ , and  $p_i$  designate respectively the capacity of equipment of type  $i$  operating in the base, and medium and peak loads during the period;  $s_i$  is the unused capacity



$$\phi(b, m, p) = \sum_{i=1}^n e_i \left[ b_i T + \frac{T-S}{2M} m_i (m_i + 2 \sum_{j=i+1}^n p_j) \right. \\ \left. + \frac{S}{2P} p_i (p_i + 2 \sum_{j=i+1}^n p_j) \right] \quad (7)$$

subject to the constraints (2), (3) and (4).

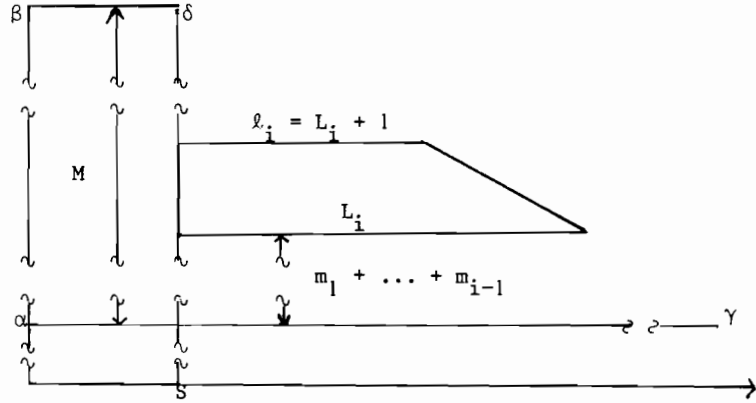

Fig. 2. Evaluation of the energy produced in the medium load

A few additional notions will be useful before stating the complete deterministic model. Besides unit investment and operating costs, power plants are usually characterized in generation planning models by technico-economic data such as the annual availability, the investment cost and the service life. In order to make our model as compact as possible (and hence to allow for more complex event trees when dealing with stochastic problems) we shall make the following assumptions. Following the tradition of power generation planning models, we shall assume the availability of each type of plant to be defined by a single coefficient which takes into account both planned maintenance and forced outages. This coefficient is strictly between 0 and 1; the product of the rated capacity of the plant by the coefficient is the available capacity. In order not to cloud the presentation with too many symbols, we did not include these coefficients in the written equations. Power generation planning models usually deal with a time horizon which is of the same order of magnitude as the service life of the plants. No great error is then introduced in the model if one assumes that plants that are commissioned and dismantled during the planning horizon are replaced, at the end of their service life, by equipment of the same type. Making this assumption, the investment cost of each set of equipment will then depend on the year of beginning of operation and will be equal to the present value at time  $t$  of the sum of the annual values of the investment cost from  $t$  until the end of the horizon.

Let  $I_i^t$  be the unit investment cost of plant beginning its operation at time  $t$ . The deterministic model can thus be written as :

$$\text{Min} \sum_{t=1}^T \alpha^t \left[ \sum_{i=1}^n I_i^t y_i^t + \phi^t(b^t, m^t, p^t) \right] \quad (8)$$

$$\text{s.t.} \quad \sum_{i=1}^n b_i^t = B^t \quad t=1 \dots T \quad (9)$$



$$\sum_{i=1}^n m_i^t = M^t \quad t=\dots T \quad (10)$$

$$\sum_{i=1}^n p_i^t = P^t \quad t=\dots T \quad (11)$$

$$m_i^t + b_i^t + p_i^t + s_i^t = x_i^t \quad \begin{matrix} i=1\dots n \\ t=1\dots T \end{matrix} \quad (12)$$

$$x_i^{t+1} = x_i^t + y_i^t \quad \begin{matrix} i=1\dots n \\ t=1,\dots,T-1 \end{matrix} \quad (13)$$

where  $\alpha$  is the discount factor.

It is easy to see that the nonlinear terms appearing in the objective function form a positive definite quadratic form. This allows for the application of the algorithm proposed in Louveaux (1979). It is also worth mentioning the drastic reduction of size, compared to usual linear programming formulation, brought about by this version of the model. This reduction is due mainly to the very compact representation of the links between available capacity and demand satisfaction. One should also note that pumping storage and reservoirs have not been represented here. Although hydropower can in principle be included without too much difficulty, in our formulation the resulting model could not be extended to the stochastic case in a form that would still permit the application of the algorithm in Louveaux (1979). A discussion of this problem would go much beyond the scope of this paper. For our purpose, it will be enough to say that hydropower has been kept out of the model for algorithmic reasons. This restriction does not seem to be a serious drawback ; indeed the economic advantages of pumping storage systems and reservoirs usually go much beyond the role of energy transfer which is the only function represented in planning models (Linard de Guertechin and co-workers, 1978). As a consequence investments in that technology are usually determined separately from the rest of the system, and it is not unusual to see planning models dealing with load curves which are assumed to be a net of hydraulic operations (Babusiaux and co-workers, 1978). Here, we assume this operation to have been made before introducing the load curve used in the model.

#### INTRODUCING UNCERTAINTY

Data used in the power generation planning process are often uncertain. A common approach used to overcome this difficulty is to set up various scenarios which one studies using some deterministic model; a final strategy is then arrived at more or less formally, taking into account the results obtained from these various runs. In the following we shall assume that the union of the paths representing these scenarios form an event tree. We shall suppose that the decision maker has some idea about the probability of occurrence of these various scenarios. The deterministic model can then be extended to the event tree by proceeding as follows : at each node  $k_t$  of period  $t$  in the tree is associated a set of information about different elements of the system at time  $t$ . Examples of these elements are the operating costs which depend on the fuel price of the plants, and the peak demand during the period. The availability of some new technology in some period can also be part of the information set associated with the node. Let  $\pi_{k_t}$  be the probability of this node as perceived by the decision maker.

Investment options are available at every node  $k_t$ . In contrast with the deterministic model, it is essential here to distinguish between the time period when a plant is commissioned and that when it starts its normal operations. To illustrate this let us assume all the time periods in the planning horizon to be of equal

length (in terms of the number of years), and let us consider a plant of type  $i$  whose construction lead time is  $\delta_i$  periods. We designate by  $k_t^1, k_t^2 \dots k_t^p$  a set of nodes of the event tree in a given time period  $t$ , and let  $\Delta_t^1 \dots \Delta_t^p$  be the additional capacities of plant  $i$  that are put in operation at time  $t$  in node  $k_t^1 \dots k_t^p$ . Let  $a(k_t^1, \delta_i), a(k_t^2, \delta_i) \dots a(k_t^p, \delta_i)$  be the ancestors at level  $t - \delta_i$  of  $k_t^1 \dots k_t^p$  respectively: the plant capacities  $\Delta_t^1 \dots \Delta_t^p$  were commissioned in  $a(k_t^1, \delta_i) \dots a(k_t^p, \delta_i)$  respectively and are clearly equal if all these nodes coincide. This phenomenon is most easily introduced in the model by considering, for the new capacity of some plant  $i$  introduced in node  $k_t$  the capacity  $y_i[a(k_t, \delta_i)]$  commissioned  $\delta_i$  periods earlier. Taking this into account the stochastic model can then be written as follows.

$$\text{Min } \sum_{t=1}^T \alpha^t \sum_{k_t \in K_t} \pi_{k_t} \left[ \sum_{i=1}^n I_i^{k_t} y_i^{k_t} + \phi^{k_t} (b^{k_t}, m^{k_t}, p^{k_t}) \right] \quad (14)$$

$$\text{s.t.} \quad \sum_{i=1}^n b_i^{k_t} = B^{k_t} \quad k_t \in K_t \quad t=1 \dots T \quad (15)$$

$$\sum_{i=1}^n m_i^{k_t} = M^{k_t} \quad k_t \in K_T \quad t=1 \dots T \quad (16)$$

$$\sum_{i=1}^n p_i^{k_t} = P^{k_t} \quad k_t \in K_t \quad t=1 \dots T \quad (17)$$

$$x_i^{k_t} = b_i^{k_t} + m_i^{k_t} + p_i^{k_t} + s_i^{k_t} \quad k_t \in K_t \quad t=1 \dots T \quad (18)$$

$$x_i^{k_t} = x_i^{a(k_t, \delta_i)} + y_i[a(k_t, \delta_i)] \quad \begin{matrix} i \in I \\ k_t \in K_t \end{matrix} \quad t=1 \dots T \quad (19)$$

#### A TEST PROBLEM

Various problems dealing with uncertain elements can be thought of in the context of power planning. Because of the lack of space, in this paper we shall only consider the classical problem of choosing the best mix of known equipment sets (i.e. assuming no new technology) in order to satisfy some future demand. Besides existing capacities which are assumed to remain in operation until the end of their service life, four types of plants can be commissioned in the planning horizon: namely, coal and fuel-gas fired plants, nuclear plants, and gas turbines. A main problem in this context is the treatment of uncertain future costs and demands. As already mentioned before, the value of information is usually low for this type of problem. Notwithstanding this fact the example can illustrate some interesting features of the approach compared to a purely deterministic approach as we

briefly discuss now. Experience with classical linear programming models dealing with this problem shows, that very small modifications of the costs can result in drastic changes in the mix of plants covering the base load. One of the aims of this test problem is to show that much smoother transitions are obtained by dealing directly with uncertainty using a model such as the one presented in the preceding section. Similarly moratoria have often been advocated for nuclear plants in order to acquire some new information. We shall see that this type of behavior comes quite naturally in the solution of the problem. We consider an horizon from 1979 to 2007, decomposed in seven periods of four years. We assume nuclear plants and fossil fuel fired plants to require respectively two and one period as construction lead times; gas turbines can be put in operation with a negligible delay. Demand is assumed to grow at 4.9 percent, per year, although that percentage could also be made random. We focus on the evolution of the various fuels that we represent on the event tree displayed on Fig. 3; it can be seen that the tree involves eight terminal branches and a total of 43 nodes. To each node is associated one or two vectors (N,C,F) and [N,C,GT]. The components of (N,C,F) correspond to the operating costs in Belgian Francs/KWh of nuclear, coal and oil plants respectively. The operating cost of gas turbine is proportional to that of oil fired plants.

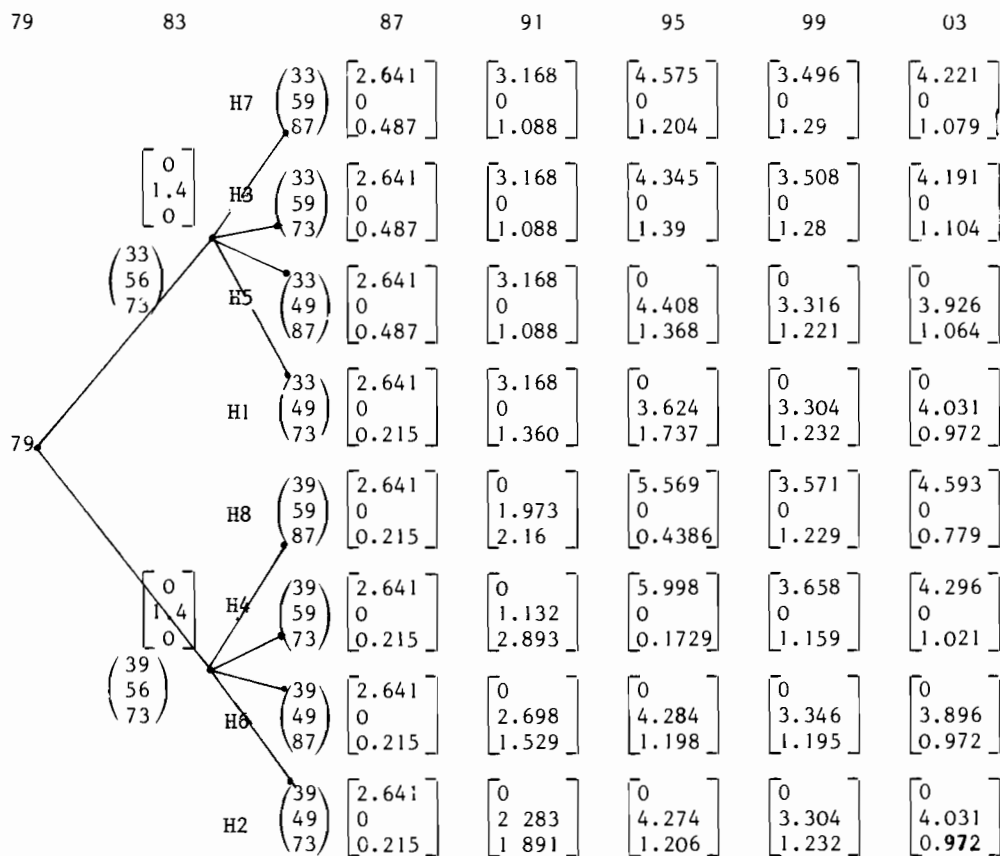

Fig. 3. Event tree : Data and optimal solution

The vector [N,C,GT] gives the new capacity of nuclear and coal fired plants and gas turbines installed at the node at the optimal solution. Oil fired plants are not represented because, as expected, they do not appear in the solution. Turning to the optimal solution represented on Fig. 3, we can see that it is much more

diversified than what is usually obtained in deterministic studies. We shall not consider the decisions made after 87 : indeed from that period on the tree reduces to a set of paths and a deterministic behavior can then be expected. For the decision taken in periods 79, 83 and 87, the obtained solutions usually lead to a mix of nuclear and coal (only in scenarios H7 and H3 do we have purely nuclear strategies). An interesting feature of the solution is illustrated by the decisions taken in period 83. Transforming the new capacities represented in Fig. 3 to commissioned capacities we see that when the fuel costs are given by (39, 56, 73) the optimal strategy is to abstain from any new decision concerning coal or nuclear plants and to wait until the next period when new information is available.

### CONCLUSIONS

A model for the stochastic power generation planning problem is presented and a simple application discussed. Because of the compact representation of the problem allowed by the formulation, it is expected that the model will permit the treatment of rather complex event trees at reasonable cost. As illustrated by the example, the method arrives at solutions that are more diversified than the usual deterministic approach.

### REFERENCES

- Anderson, D. (1972). Models for determining least cost investments in electricity supply. The Bell Journal of Economics and Management Science, 3, 267-299.
- Babusiaux, D., P. Offant and M. Valais (1978). Modélisation des secteurs de production et de transformation de l'énergie : le cas français. Revue de l'Institut Français du Pétrole, 33 n°2 780011 177-190.
- Breton, A. and Falgarone (1972). Application de la théorie de la commande optimale au problème de choix des équipements de production à Electricité de France. Proceedings of the V<sup>th</sup> Power System Computation Conference, Grenoble.
- Hung-poChao. (1979). Economics with exhaustible resources. Ph.D. thesis, Stanford University. Outstanding Dissertations on Energy, New-York Garland Publishing Co.
- Juseret, R. (1978) Long term optimization of electrical system generation by convex programming. Mathematical Programming Study 9 186-195
- Linard de Guertechin, F., T. Lekane and Y. Bouffioulx (1978). Evaluation économique du service attendu d'une centrale de pompage associée à un parc thermique. Proceedings du Congrès International des Centrales Electriques Modernes AIM; Rapport n° 46.
- Louveaux, F. (1979). A solution method for multistage stochastic programs with recourse with application to an energy investment problem. Operations Research (forthcoming)
- Louveaux, F. and Y. Smeers (1979). Decision analysis of some R-D strategies for power generation. Working paper, Faculté Notre Dame de la Paix and Université Catholique de Louvain.
- Manne A.S., (1974). Waiting for the Breeder, The Review of Economic Studies; Symposium on the Economics of Exhaustible Resources, 47-65
- Manne A.S., Richels R.G. and J.P. Weyant (1979). Energy policy modeling : a survey. Operations Research, 27, 1-34
- Richels R.G., (1979). R and D under uncertainty : a study of the U.S. breeder reactor program. Ph.D. thesis, Harvard University. Outstanding Dissertations on Energy, New-York : Garland Publishing Co.

# ENERGY MODELING AND AGGREGATION OF REFINING

**D. Babusiaux and M. Valais**

*Institut Français du Pétrole, France*

## ABSTRACT

The "Institut Français du Pétrole" has compiled several dynamic linear programming models (energy planning model with the assistance of "Electricité de France", refining and petrochemicals models) that need an aggregate representation of the refining industry.

In order to simplify, it might be conceivable to assimilate the whole set of French refineries with a single refinery. In fact, this can hardly give a satisfactory formulation. As a matter of fact, the value of the dual variables found in this case may be rather different from the values of marginal costs that can be observed in real-life. This is due to structural and regional differences from one refining center to another.

The accuracy of an aggregation method (taking into account the above-mentioned differences) is evaluated by studying the marginal costs of products. Such a study is always important; especially, in the case where the model (refining) is to be connected with the model of another sector (electricity production for instance) employing as an input the output of the first sector (heavy fuel oil).

## KEYWORDS

Energy model; Refinery model; Linear programming.

## INTRODUCTION

For several years now, the Institut Français du Pétrole has owned and has been using models representing the refining industry. These models are used either for modeling one or several specific refineries (process evaluation, inserting a unit into an existing complex) or on an aggregate level (e.g. national) for examining the desirable evolution of the structure of the refining industry as a function of forecasts concerning the consumption demand which will have to be fulfilled in the years to come.

As part of a research project for CNRS (Centre National de la Recherche Scientifique), IFP built a model integrating all the energy production and transformation sectors in France (oil, electricity, coal, gas). The aim was to analyze the consequences of variations in the demand for electricity and petroleum products, variations quite different from the ones used in the most frequently used scenarios, as the result of various restructuring policies for French industry. The formalization of the submodel relating to electricity production was performed by the Service of Economic and General Studies of EDF (Electricité de France) and was calibrated on more sophisticated models.

Building a model representing the French refining industry raises aggregation problems at the level of supplies, products, regions, etc. Dual variables make up an indispensable indicator for evaluating the validity of the simplifications adopted. The analysis of these variables (mainly marginal production costs) is of particular importance when the refining model has to be coupled, as mentioned above, with representative models of other energy sectors. We begin by describing a few elements relating to the aggregation of crude oil supplies and finished product demands and then we take up the problem of aggregating different refining structures.

## I - REPRESENTING THE REFINING INDUSTRY BY A SINGLE-REFINERY MODEL

### a) Model Representing a Refinery over one Period of Time

The models used in the refining industry are linear programming models. For a single-period model, the main variables are product throughputs (amounts of crude oils and intermediate products) to which must be added, for long-range planning models, variables corresponding to the capacities of units to be built. The main equations are :

- . material-balance equations (e.g. for intermediate products, indicating that the sum of the amounts used downstream is equal to the amounts available at the outlet of the upstream units;

- . demand equations, explaining the fact that the sum of the amounts of intermediate products used in making up a finished product must be able to meet the consumption demand for this product;

- . quality equations expressing the need to respect, for each finished product, the legal or technical specifications (e.g. specific gravity, vapor pressure, octane number of automotive fuels, sulfur content, viscosity for distillates and fuel oils).

The models used for refinery management, corresponding to a fairly detailed representation, generally include several hundred or even several thousand constraints and variables. In building a dynamic (multiperiod) model and integrating other energy sectors while maintaining a reasonable size, the representation of refining over one period of time must be done in a simplified manner.

### b) Aggregation of Products

The planning of investments does not require a model to distinguish each finished product manufactured by a refinery. For example, engine diesel fuel

and home heating oil can be manufactured from the same base stocks. The only difference between these two products (apart from coloring additive used for tax reasons) is in the specification for the cetane number. But selecting base stocks of sufficient quality to manufacture engine diesel fuels is generally done without any additional cost. Engine diesel fuel and home heating oil are thus considered as a single product in long-range models.

Likewise, various special products produced in relatively small tonnages will be assimilated with the major products having the most similar properties.

The number of products to be taken into consideration is thus relatively limited (e.g. half a dozen: automotive fuels, naphtha, heating oil, heavy fuel oil, liquefied petroleum gas).

### c) Aggregation of Crude Oils

French refineries process several dozen types of crude oil. But the size of a linear programming model is approximately proportional to the number of crude oils considered. Therefore, it is impossible to introduce all the crude oils corresponding to French supplies into a refining model. These supplies must thus be represented by a restricted number of crude oils so as to lose as little accuracy as possible.

In the industry, specialists in crude oil evaluation usually make this reduction empirically as the result of their experience, and they consider a few "typical" crude oils to which others can be assimilated by analogy. A more systematic method can also be used, involving multidimensional data analysis techniques<sup>1</sup>.

A crude oil is defined by a certain number of properties, i.e. qualities (specific gravity, sulfur content), yields in distillation products (naphtha, middle distillates, heavy distillates, residue) and their qualities (octane number of gasoline, PONA analysis of feedstocks for catalytic reforming units, viscosity and freeze points of distillates, etc.).

Let us consider the problem of representing any supply by means of a number  $n$  of given basic crude oils (e.g. from 3 to 5). Each crude oil will be represented by the vector of the properties defined above. An effort can then be made to define a crude oil not belonging to all the  $n$  basic crude oils by means of a linear combination of the vectors associated with the basic crude oils. The linear combination coefficients enabling the errors committed to be reduced will be defined by linear regression<sup>2</sup>.

In practice, a regression method under constraints is generally used (positive coefficients) so as to avoid having to define a crude oil on the basis of negative amounts of one or several basic crude oils. (In some cases, if the entire supply has to be represented by negative amounts, it cannot be introduced into a linear programming model. Furthermore and in all cases, the introducing of negative coefficients makes it more difficult to interpret and present results).

---

<sup>1</sup> A more detailed presentation of this method is available in Bond, Majorga, Offant (1977).

<sup>2</sup> Properties are standardized to prevent any bias introduced by the use of heterogeneous physical units.

The selection of the basic crude oils set is very important. This set will be chosen so as to minimize the weighted sum of the errors obtained during the regressions defined above.

This might lead to a large-size combinatorial problem (analyzing all combinations including  $n$  crude oils). A principal components analysis of all the crude oils may be useful in this search. It makes it possible to spot the crude oils most liable to represent a group of crude oils after having isolated groups of similar crude oils. At the same time, in making this selection it is natural to retain only the crude oils representing a significant proportion of national supplies.

The number  $n$  of basic crude oils is the result of a compromise between the objective of accuracy and that of the size of the model. The quality of the representation obtained can be tested by introducing, into a refining model (linear programming), a reduced supply by means of this method and by comparing the results with those obtained by introducing a supply described in greater detail.

For long-range planning models, a set of three or four basic crude oils can generally be considered satisfactory.

## II - AGGREGATION OF REFINING STRUCTURES

A process often used in energy optimization models consists in representing the entire refining industry of a country as if it were a single refinery. However, in France there is some disparity between existing refinery types. Some are simple (and include distillation, hydrodesulfurization and reforming units), while others have one or several conversion units (catalytic cracking, visbreaking, etc.).

These disparities occur on two levels:

- . On a national level: different refining zones are equipped quite differently in catalytic cracking capacities. This can be explained by the existence of larger or smaller regional markets for heavy fuel oil. For example, the location of heavy industries in the North and in Alsace-Lorraine results in a high regional demand for heavy fuel oil, and this reduces the local need for conversion.
- . On a regional level, the distribution of conversion units is no longer homogeneous among refineries in the same zone. The example of the Seine-Maritime department illustrates this situation.

If the long-range marginal costs of production corresponding to different types of refinery are analyzed, very great differences can be seen.

A primordial factor explaining the values of these marginal costs (dual values in linear programming) is the proportion of heavy fuel oil in total production. If the demand for heavy fuel oil is parametrized and if the value of the marginal costs of finished products is considered as a function of the demand for heavy fuel oil, the following observations can be made :



- . For a simple refinery (distillation and reforming) there is considerable discontinuity, i.e. when heavy fuel oil production drops below a given threshold (approximately 30%), the marginal cost of this product decreases very quickly since the excess amounts cannot be upgraded by conversion.
- . Conversely, for a refinery having conversion units, the long-range marginal cost, with suitable capacities, evolves much less abruptly.

To illustrate a few analysis elements of the mechanism of price setting on the market, let us consider a simplified diagram. Let us assume that there are only two types of refinery (complex and simple; simple refineries being not equipped with conversion units).

Let us neglect costs of transportation and let us discount any possibilities of exporting and importing products.

If a demand pattern similar to that of France is to be met by each type of refinery, the marginal cost of heavy fuel oil from the simple refinery will be quite appreciably lower than that from the refinery having conversion units. If certain "competition" assumptions are made or if an overall optimum is being sought after for both refineries, the simple refinery will increase its production level, and the refinery with conversion units will decrease its production level so that the marginal costs are equal for both refineries (fig.1)<sup>3</sup>.

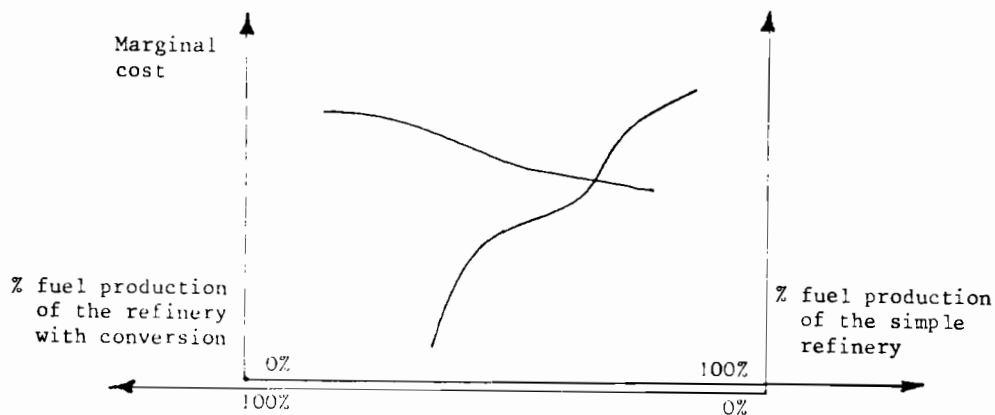

Fig. 1 Marginal Cost Evolution vs. % fuel production

---

<sup>3</sup> This is a rough scheme. Obviously such a price decomposition is impossible when using linear programming.

This type of mechanisms explains that the prices of heavy fuel oils observed on the market are generally on a lower level than that shown by a model representing the whole French refining as a single refinery having a structure that is perfectly suited to demand.

The implicit use of shadow prices in multi-energy models for exchanges between the refining sector and the electrical sector requires careful attention to be paid to the significance of the marginal costs calculated by the model and particularly to the marginal cost of heavy fuel oil. A first approach might be to distinguish the two or several refinery types (simple and conversion) in the model. But this solution is very costly in terms of computing time because the size of the corresponding matrix is nearly doubled (at least).

So as to obtain a formulation similar to that for two refineries, while also reducing the size of the matrix, a single topping unit is modelled. It provides separate supplies for the finished-product blending units by using either a single reforming unit for light gasoline or a more complete group of conversion units (including reforming). (fig. 2).

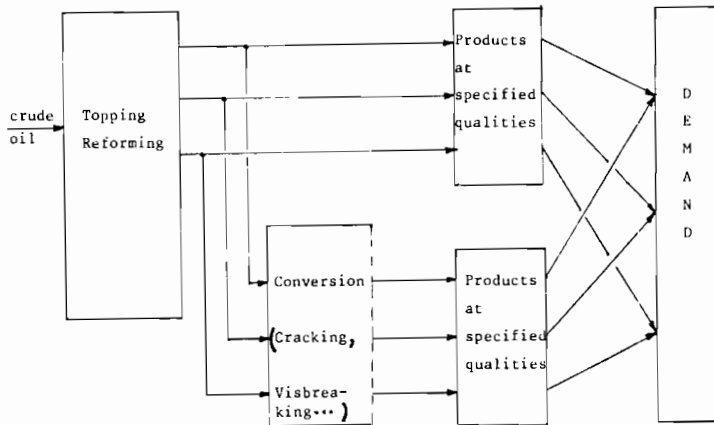

Fig. 2 Aggregation of two refinery structures

The justification of such a procedure is mainly empirical; the value of the primal variables and especially the value of the dual variables are note very different from those obtained with more sophisticated models.

## II - APPLICATION EXAMPLES

### 1) The IFP "Energy" Model

As part of the project it was carrying out for CNRS, IFP with the assistance of EDF built a linear model for the optimization of the energy production and transformation sectors<sup>4</sup>. The dynamic (multi-period) structure of this model is similar to those of models built by other organizations.

---

4 Babusiaux, Offant, Valais (1978)

Among the specific features of the model (beyond the techniques used to define an aggregate representation of the refining industry), mention can be made of the formulation of the electricity production sector (formulation worked out by EDF). This formulation includes the random nature of the demand for electricity, with the objective function being an expected value of the production cost. Possibilities of supply default are introduced, and high costs are associated with them.

## 2) Multi-energy Models and Organic Chemistry

The raw materials requirements for organic chemistry (plastics, synthetic fibers, synthetic rubber, detergents, etc.) and for nitrogen fertilizer chemistry are taking an increasing share of the supplies of primary fossil fuels. At the same time, the rapidly rising prices of hydrocarbons, and especially those of crude oil, coupled with the progressive widening of the price differentials between light and heavy oil fractions are resulting in doubts as to the validity of traditional schemes for supplies of raw materials for the chemical industry.

The coupling of oil, gas and petrochemical linear models enables the basic petrochemical sector (production of basic intermediates) to be linked to its upstream hydrocarbon supplies with an extremely wide range of feedstocks (going from the lightest components of natural gas all the way to vacuum distillates from oil refining). The static or dynamic models thus built can be used more effectively for analyzing the consequences, for the petrochemical sector of events or energy trends, or, on the contrary, the secondary effects of a given evolution of the petrochemical sector on the energy sector. Lastly, this coupling provides a particularly effective tool for analyzing the importance of new raw manufacturing processes with regard to both refining and petrochemicals.

## CONCLUSION

The increasing importance of energy problems in the economies of the leading industrialized countries makes it necessary to built aggregate energy model on a nationwide scale. However the construction of such models raises particularly acute problems with regard to their degree of representativity.

In the field of oil refining in particular, special care must be taken to integrate not only quantitative phenomena and structural upheavals (drastic changes in the patterns of demand for finished products and refining processes) but also the intensification of qualitative problems (increasing difficulties in manufacturing low-sulfur products, products having reasonable viscosity, etc.).

It should be borne in mind that a rough aggregation in the modelling of the oil refining sector on a nationwide scale can only lead to unsatisfactory or even dangerous representations.

REFERENCES

- Babusiaux, D., P. Offant, and M. Valais (1978)  
Modélisation des secteurs de production et de transformation de l'énergie -  
Le cas français.  
*Revue de l'Institut Français du Pétrole*, 33, 2, 177-190.
- Bond, J., E. Mayorga-Alba, and P. Offant (1977)  
Réduction des approvisionnements pétroliers multiples dans les programmes  
linéaires de raffinage.  
*Revue de l'Institut Français du Pétrole*, 32, 6, 959-971.
- Jomaux, F., D. Babusiaux, and M. Valais (1977)  
Structure optimale du raffinage en Belgique.  
*Revue de l'Institut Français du Pétrole*, 32, 4, 647-664.
- Offant, P., D. Babusiaux, J. Le Duigou, and M. Valais (1978)  
Niveau de vie, croissance et énergie.  
*Revue de l'Institut Français du Pétrole*, 33, 2, 165, 175.

# A MATHEMATICAL PROGRAMMING MODEL FOR ASSESSING ADVANCED OIL TECHNOLOGIES

**A. Suzuki\***

*Department of Nuclear Engineering, The University of Tokyo, Tokyo, Japan*

## 1. INTRODUCTION

In the long-term perspective, it seems unavoidable that light and easy-to-handle crude oil will decline because of the limited nature of its reserve and heavy and hard-to-handle one will take its place instead. In the demand side, however, the higher quality of oil products is required from environmental safety. The demands for fuel oil, for instance, are changing qualitatively as well as quantitatively; the market share of heavy residual oil with high sulfur content and/or high pour point is going down while the demands for light fuel oil with low sulfur content and/or low pour point are increasing.

A number of alternative advanced technologies for refining heavy oil is now considered so that they may fill up this qualitative gap between supply and demand aspects. Most of those technologies are highly capital-intensive and therefore a long-range decision making is required for choosing the alternatives. This paper describes a dynamic mathematical programming model of the petroleum industry in Japan as a whole, being intended to provide an analytical tool for simulation studies on the question as of when, how and which kind of the technologies should be introduced and thereby to serve as a framework for that long-term planning.

## 2. SPECIFICATION OF THE MODEL

### 2-1. Basic Structure

The basic structure of the model is quite the same as the one being now used at many petroleum industries. I.e., the constraints which must be satisfied at each point of time are the followings;

- (1) supply constraints: the upper bounds are imposed upon the availability of each imported oil,
- (2) crude oil balance: once imported, crude oil goes either to refinery or to direct use,
- (3) intermediate product balance: intermediate products of each refinery units are produced with given yield and then used as raw materials for other products or

\* The author was indebted to Messrs. T. Hirano, K. Ogawa, K. Osada, K. Takeda and N. Tani for their intensive cooperation, and to Profs. T. Furusawa, Y. Kunugi and Y. Yamamoto for their encouragement. Throughout, helpful suggestions have been received from Messrs. K. Matsui and M. Seki.

as final products,

(4) home fuel and hydrogen balance: fuel and hydrogen required for each refinery units are provided a hundred per cent by home products, and

(5) demand constraints: final products must meet demand conditions at the market, both qualitatively and quantitatively.

## 2-2. Dynamics

One of the salient features of the model is that it is dynamical. The model employed here is formulated so that it may make distinction between capital and current cost inputs, while the petroleum LP model which is widely used today fixes capital recovery factor and thereby the capital input is represented in current basis since usually it is used to simulate static situations in yearly terms. Specifically, the model takes into consideration the inequality:

$$dX/dt \leq f \cdot (Y-Z); X(0) = X_0, \quad (1)$$

where,

X = production activity level of refinery unit [Kl],

Y = new installation capacity [Kl/year],

Z = retired installation capacity [Kl/year],

f = capacity factor [-], and

t = period of time [year].

And then oil refining costs C are expressed as,

$$C = vX + kY, \text{ [Yen]}, \quad (2)$$

where,

v = per unit current cost [Yen/Kl], and

k = per unit capital cost [Yen/Kl/year],

while, in case of static models,

$$C = (v + rk)X, \text{ [Yen]} \quad (3)$$

with r = capital recovery factor [ /year].

The difference in cost assessment between dynamic and static models is clear. Suppose now there are two technologies (A and B) which provide exactly the same technical performance but require different structure of cost input, i.e., the technology A is far more labor-intensive than technology B ( $v_A >> v_B$ ) and on the contrary B is far more capital intensive than A ( $k_A \ll k_B$ ). In case of static models, there is no distinction between A and B if the static cost inputs are the same, i.e.  $v_A + rk_A = v_B + rk_B$ . In dynamic ones, however, there must be much difference even if statically at the break-even level. For simplicity, let  $v_B$  and  $k_A$  be nearly zero and the technology B has an infinite life, and then the total cost inputs for A and B are,

$$TC_A = v_A (X_A(0) + X_A(1)e^{-\rho} + X_A(2)e^{-2\rho} + \dots), \quad (4)$$

and

$$TC_B = k_B Y_B(0), \quad (5)$$

respectively, where  $\rho$  = discount rate [ /year], It should be noticed here that the cost for B is independent of the production activity  $X_B(t)$  while the cost for A relies upon the activities for each point of time. Hence, if the future demand condition:  $X_A(t) (=X_B(t))$  is large enough to secure the maximum availability of the technology B, i.e.  $X_B(t) = X_B(0)$ , the costs for the two are break-even also dynamically. If otherwise, however, they are not the same and A is more economical than B.

## 2-3. Demand Projections-Objective Function

There are a couple of candidates of objective function. One is the total cost incurred during planning horizon. That is,

$$F = \int_0^T e^{-\rho t} (eR + vX + kY) dt \rightarrow \text{minimization}, \quad (6)$$

where,

e = CIF price of imported oil,  
R = quantity of imported oil, and  
T = planning horizon.

It is clear that if it is possible that  $R=X=Y=0$ , then it gives an optimal solution for the criterion (6). In actual, however, it is impossible because we must meet demands for each products, which is formulated as

$$yX \geq D, \quad (7)$$

where,

y = product yield or conversion efficiency, and  
D = exogenously given demand level.

The other candidate is the utility function defined by the demand function for each final products. In this case, demand level is determined endogenously. Specifically, the demand level q is defined by using the utility function  $U(q)$  as,

$$dU(q)/dq \equiv p = p_0 (q/q_0)^{1/\sigma}, \quad (8)$$

where,

p = price level,  
 $p_0$  = price level at the beginning,  
 $q_0$  = demand level at the beginning, and  
 $\sigma$  = price elasticity.

And then the objective function:

$$G = \int_0^T e^{-\rho t} U(q) dt - F \rightarrow \text{maximization} \quad (9)$$

determines q as well as R, X and Y. So, the demand constraint (7) is replaced by  $yX \geq q$ .

The objective function (9) is useful if we are interested in the price-responsive demand projection where marginal production cost increase results in some reduction of demand level, while the other (6) is useful for the price-inelastic demand conditions. The reason why the criterion (9) is price-responsive is as follows. If q is optimal, then the relation:

$$dU/dq = \partial(eR + vX + kY)/\partial q \quad (10)$$

must be valid. Since the left-hand-side of this equation implies the market price and the right does the marginal production cost, the above relation indicates that an optimal demand level be determined so that it may equal the price to the marginal production cost. There are two modes of production cost rise; one is the price increase of oil ( $\partial(eR)/\partial q$ ) and the other is the refining cost increase expressed as ( $\partial(vX + kY)/\partial q$ ). According to the equation (10), both effects cause the price increase ( $dU/dq$ ) and result in some reduction of demand level q, since usually the price elasticity  $\sigma$  is negative.

#### 2-4. Mathematical Programming Formulation

Methodologically, the mathematical problem considered here is very similar to the long-term energy planning problems treated by the investigations (1-3), where the mathematical programming approach was employed for optimization. Almost all the constraints and the mathematical equations mentioned above can be formulated in terms of the linear programming without special modifications. The only equation that needs the modification is one of the candidates of objective function (9). With the aid of piece-wise linear approximation, however, the use of the linear

programming can be made, too. Figure-1 is the fundamental structure of the final tableau.

### 3. COMPUTATIONAL RESULTS

#### 3-1. Reference Case

The schematic description of the reference system of petroleum refinery is shown in Figure-2, where the following refining units are included as the alternative technologies for heavy oil processing which at the moment are relatively easy to introduce: (1) thermal cracking unit for producing cokes from vacuum bottom, (2) gasification unit for producing gaseous fuel from cokes, (3) catalytic cracking unit for processing atmospheric residue, (4) hydrocracking unit for processing vacuum bottom, and (5) advanced type of desulfurization of atmospheric residue with very high sulfur content.

At present, these technologies are not used widely. It mainly rests upon the extent of heaviness of the imported crude oil whether these are required in the future. Figure-3 represents one of the reference cases estimated by the Japanese petroleum industry, indicating that the shift toward heavier oil seems inevitable especially after the year 1990. Thus, if this is the case, it is expected that some of the advanced technologies listed above will be introduced around that year.

#### 3-2. Illustrated Examples

The model provides a cost-minimal or utility-maximal dynamics of the refinery system for given conditions on future oil supply and demand. Figure-4 is used to show its typical example for atmospheric distillation unit, which implies that the initially existing capacity will be large enough to the 1983, and thereafter some new installation will be required every year to meet growing demands.

With respect to the advanced technology units, the introduction schemes are heavily dependent upon whether the cost-minimal or the utility-maximal. In Figure-5, the marginal production costs of final products for the cost-minimal case where the price-inelastic demand projection is made is shown, and in Figure-6, for the utility-maximal case where it is assumed that the demands are price-responsive with constant elasticity. The difference between the two cases is striking; in the price-inelastic demand case the petroleum industry must meet the demand by any means, and therefore the marginal production costs will rise remarkably in particular for the products with relatively high growing rates, such as kerosene, gas oil and fuel oil (A). The fact that the costs for these products will increase rapidly since the year 1990 is obviously due to the introduction of the advanced technology units. Except for the gasification unit, all the alternatives considered in the reference system are introduced with fairly high rates since around that year.

As shown in Figure-6, in case of price-responsive demand projections, however, the marginal production costs do not change significantly but rather will be stabilized. The reason is that the price elasticity a priori fixed there is large enough for consumers to behave in such a way that the utility decrease from reducing the consumption of products is better than the cost increase associated with such high market price hike as in Figure-5. Naturally, the introducing manner of the advanced technology units is far modest compared with the other case; the hydrocracking unit disappears as well as the gasification unit and as for the remaining three technologies their contribution is rather minor.

### 4. CONCLUDING REMARKS

A dynamic mathematical programming model was constructed to assess advanced tech-



nologies for processing heavy oil. As long as it is inevitable that the quality of crude oil will worsen to a certain extent, we cannot avoid to introduce some of those technologies in some years. The results obtained here suggest that it rests closely upon the future market condition of oil products, particularly whether effectively price-responsive or not. It is known that the past structure of Japanese oil business was of the special feature that is unable to extrapolate for the future. Our country is now at the turning point in this regard as well.

#### REFERENCES

- (1) Nordhaus, W.D. (1973). The Allocation of Energy Resources. Brookings Papers on Economic Activity, 3.
- (2) Hafele, W., and Manne, A.S. (1974). Strategies for a Transition from Fossil to Nuclear Fuels. International Institute for Applied Systems Analysis RR-74-7.
- (3) Suzuki, A. (1977). An Energy Model for a Transition from Fossil Fuel to Advanced Technologies. Proceedings of the Second Pacific Chemical Engineering Congress, AIChE.

ROW (RHS)	Column	Oil Availability	Non-refinery Oil	Refinery Unit Activity	Swing	New Installation	Refinery Products	Gasoline Blending	Gas and Fuel Weight	Gas and Fuel Oil Blending	Imported Product	Demand Index	Oil Availability	Non-refinery Oil
	Unit	10PKL/Y	10PKL/Y	10TON/Y	10TON/Y	10PKL/Y	10PKL/Y	10PKL/Y	10TON/Y	10PKL/Y	10PKL/Y	(n, t)	10PKL/Y	10PKL/Y
	Unit	(t)	(t)	(n, out, t)	(u, t)	(n, t)	(n, t)	(y, n, t)	(n, t)	(y, g, n, t)	(t)	(n, t)	(t, t+)	(t, t+)
	Unit	CIF price	Current Cost	Swing in Swing out	Capital Cost	Non-Blending Products Home Fuel Production Refined Quantity Gasoline Spec Gas and Fuel Oil Spec Gas and Fuel Oil Volume Gasoline Volume	Gas and Fuel Blending	Gas and Fuel Blending	Gas and Fuel Blending	Imported Quantity	CONST			
Objective Function (MINIMIZATION)	10Yen													
Supply Constraints (Upper) (t, t)	10PKL/Y	+												
Crude Oil Balance (O.O.)(t, t)	10PKL/Y	-	+											
Refinery Unit Availability (Existing Capacity)(t, t)	10PKL/Y													
Intermediate Product Balance (O.O.)(y, g)	10TON/Y													
Home Fuel Balance (O.O.)(t)	10PKL/Y													
Final Product Balance (O.O.)(n, t)	10PKL/Y													
Sulfur, P.P., vis. Constraints (O.O.)(n, s, t)	10PKL/Y													
Gas and Fuel Oil Volume Balance (O.O.)(n, t)	10PKL/Y													
Gasoline Volume Balance (O.O.)(n, t)	10PKL/Y													
Gas and Fuel Oil Density Balance (O.O.)(n, t)	10TON/Y													
Demand Constraints (CONSTANT)(n, t)	10PKL/Y													

• Crude Oil No  
 t : Time Period  
 y : Intermediate Product No  
 k : Refinery Residue Group No  
 n : Product No  
 s : Blending Constraints No  
 r : Refinery Unit No  
 in : Swing in  
 out : Swing out  
 f : Demand level  
 u : Refinery Unit No  
 (Coefficient 1 : + 1)  
 Y : Year  
 + 1 : Hydrogen Production Unit  
 10NM/Y  
 Gasification Unit  
 10TON/Y  
 + 2 : LPG, COKES, ASPHALT :  
 10TON/Y  
 + 3 : Blending Constraints  
 COKE, GAS 10NM/Y  
 (Gas and Fuel Oil)  
 S = 1 Sulfur (VOL. %)  
 S = 2 P Index (VOL. %)  
 S = 3 V's Index (VOL. %)  
 S = 4 Density (BLDG. %)  
 S = 1 Aromatic (VOL. %)  
 S = 2 Oxidane (VOL. %)  
 S = 3 Volatility (VOL. %)  
 S = 4 Olefine (VOL. %)

NEXT PERIOD

Figure - 1. Basic Structure of Programming Tableau.

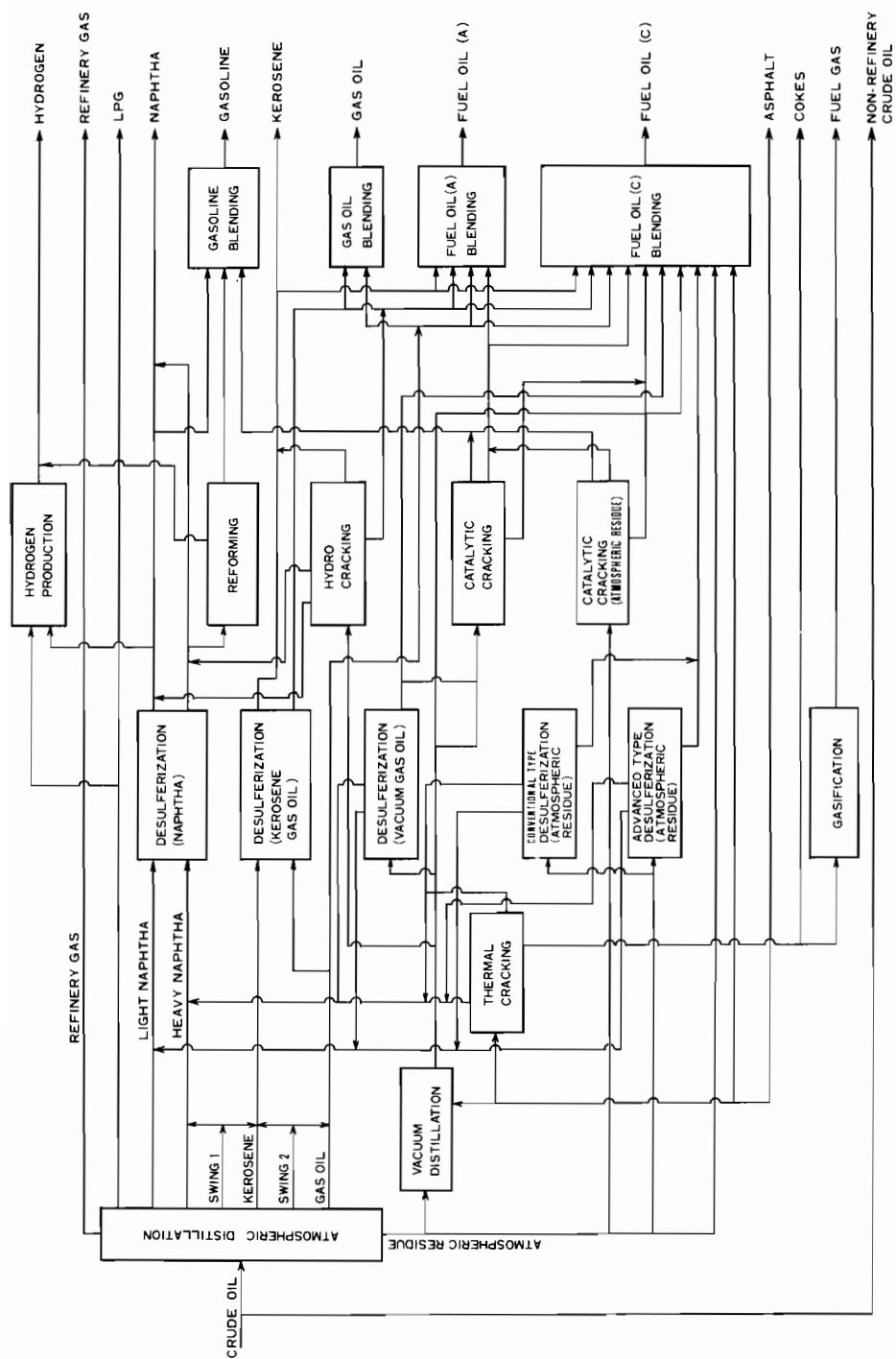

Figure - 2. Reference Refinery System.

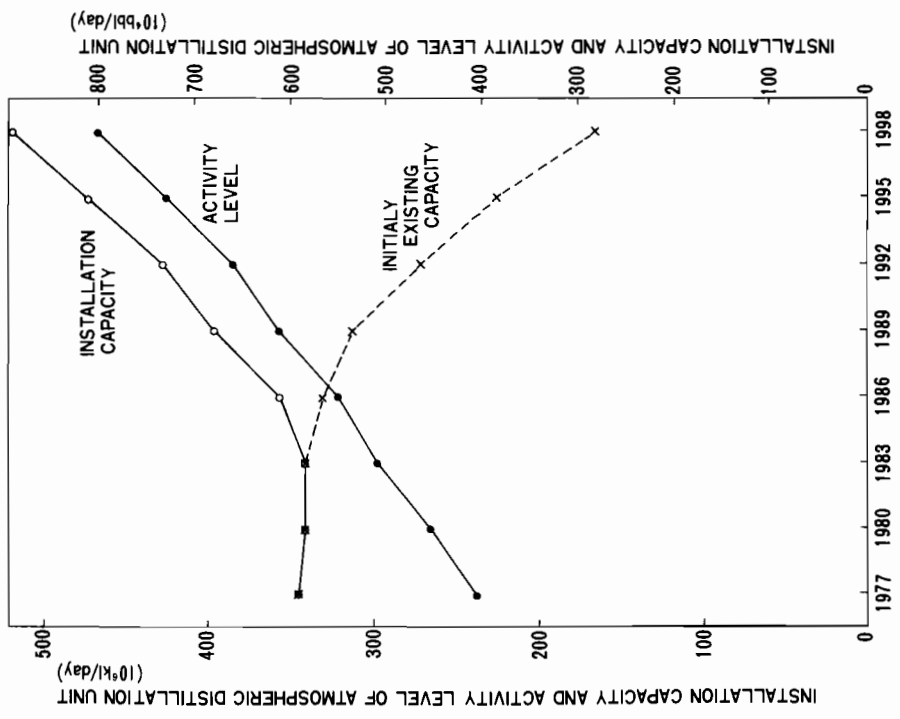

Figure - 4. Evolution of Atmospheric Distillation Unit Capacity, Estimated for the Reference.

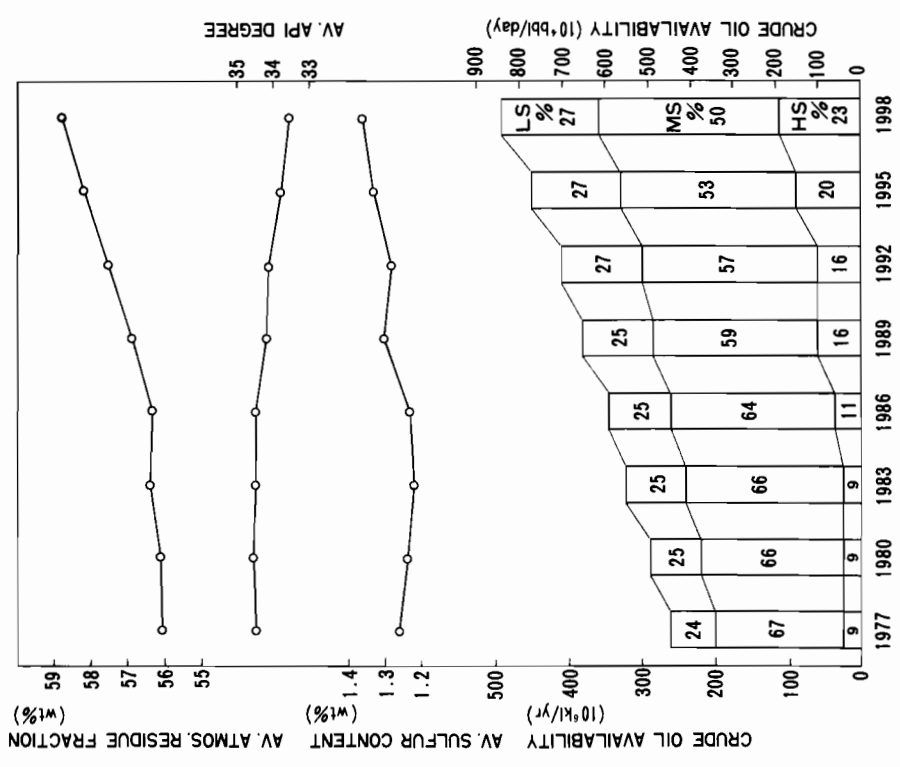

Figure - 3. Reference Crude Oil Supplying Conditions: Availability and Some Properties.

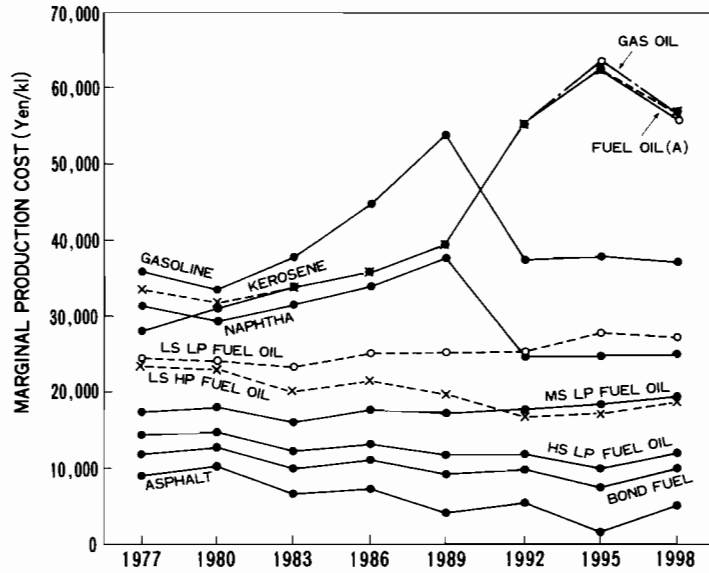

Figure - 5. Marginal Production Cost of Oil Products for the Price-inelastic Demand Projection Case.

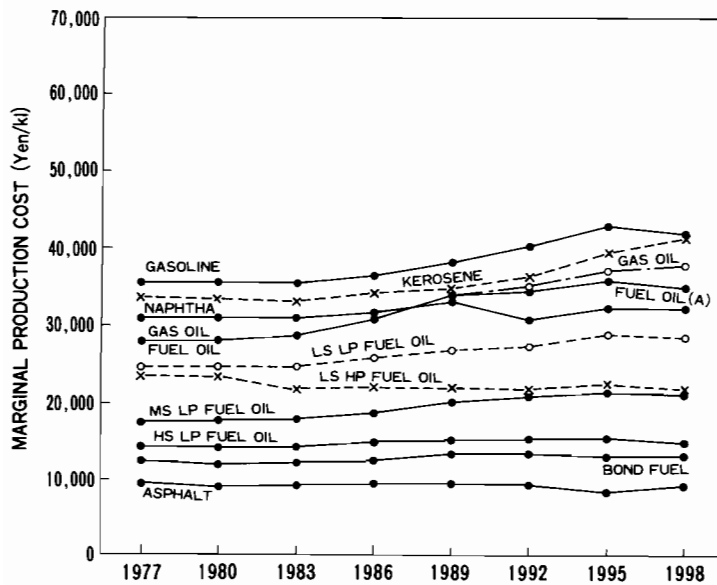

Figure - 6. Marginal Production Cost of Oil Products for the Price-responsive Demand Projection Case.



# AL-EDIS: AN ENERGY INFORMATION SYSTEM FOR DEVELOPING COUNTRIES

**V. Mubayi, R. Chatterjee and T. D'Errico**

*Institute for Energy Research, State University of New York, Stony Brook,  
New York, USA*

## ABSTRACT

This paper provides a brief description of an interactive, graphics-oriented, computerized energy information system intended for use as a tool in energy sector planning in developing countries. A brief review of the methodology used for constructing the system framework is followed by a description of its current capabilities and planned future extensions as warranted by user requirements.

## KEYWORDS

Energy; information system; developing countries.

## INTRODUCTION

In September 1978, under a grant from the aL Dir'iyyah Institute, The Institute for Energy Research at the State University of New York, Stony Brook, began a project to develop an energy information system designed to help energy sector planning in developing countries. The project was initiated in response to the urgent need felt by energy sector planners in these countries to obtain updated information and suitable analytical tools in order to project future energy requirements, evaluate various energy options and carry out national energy assessments.

The information system, AL-EDIS, that has been developed is designed to provide a system of access to relevant energy information specifically directed to the needs of policymakers. A special emphasis has been placed on graphics capability to provide information in a form readily understandable to policy and other non-technical decisionmakers. Since the requirements of energy sector planning go beyond just information on energy supplies and demands, AL-EDIS has also been designed to offer users a methodology for carrying out national energy assessments in addition to containing a data bank on energy resources and technologies.

Two broad categories of information are designed to be contained in the system. First, generic data on energy resources worldwide, energy technologies, process efficiencies, capital and operating costs, etc.,. Second, country-specific data on domestic energy resources, consumption patterns (including non-commercial fuels),

and related ancillary data important for energy planning such as national economic, industrial, demographic, geographic and sociocultural characteristics.

The users of AL-EDIS are expected to be, primarily, national planning organizations or similar agencies in developing countries. The system is initially designed to be used in conjunction with a national energy assessment for which a basic set of data on energy supply and consumption will be generated. AL-EDIS will help in categorizing and organizing the data collected into a form suitable for further analysis. As the data base expands and improves, the system may be used by policy analysts for answering more detailed and specific questions related to the assessment process.

#### THE AL-EDIS FRAMEWORK

The principal form of access to information contained in AL-EDIS is through a computer-graphic energy network simulator. This network is based on the Reference Energy System (RES), developed at Brookhaven National Laboratory, which displays a nation's energy system in the form of a link-node network diagram of energy flows from primary energy resource sectors through conversion systems to final end-use sectors. An illustrative network suitable for developing countries is Fig. 1. (A more complete discussion of the RES framework and its use can be found in Beller, 1975; Reisman and Malone, 1978; Mubayi, Palmedo, and Doernberg, 1979.) This framework provides a complete policy-oriented description of a country's energy system. The simulator is designed for on-line, interactive use by which the user queries the system obtaining an immediate response.

In using the system for energy assessments, one first constructs a "reference" or "base case" network by making projections of the demand for energy services in various end-use sectors. Depending on the available data, the level of detail involved in making projections can vary, from those making simple assumptions between energy use and sectoral output to more sophisticated approaches based, for example, on input-output analysis. The allocation of fuels and technologies to supply these energy services can be performed either on informed engineering-economic judgment or, in more sophisticated methods, through the use of energy optimization models. Once the reference case network is constructed, the impact of introducing new technologies or new energy resources on the energy system as a whole and its implications for some important national policy goal, e.g., reducing the level of oil imports, can be quantitatively assessed by making perturbations to the reference case.

#### CURRENT STAGE OF DEVELOPMENT

A demonstration of the country-specific component of the information system has been a major goal of the first year of the project. The major categories of national data contained in the data base are shown in Fig. 2. The data base assembled for demonstration has been programmed with data from the Peru Energy Assessment (U.S. DOE, 1979).

Two major considerations guided us in constructing the graphic displays. The amount of information which can legibly be displayed on a graphics terminal is limited. Thus a physical constraint is imposed on the amount of information contained in a given network diagram. A second consideration was related to the "human engineering aspects" which govern the use of an interactive computer system. The amount of information displayed at any given time should be only as much as can usefully be absorbed by the user. Our solution to this particular problem has been to provide views of the national energy system at varying levels of aggregation allowing a user to select the level of detail determined necessary for the



purposes at hand.

Three levels of aggregation are provided for in the graphic displays. At the highest level of aggregation, a summary view of the entire national energy network describes energy flows from extraction of fuel resources to end-use demands. Figure 3 displays this for the year 2000 "business as usual" or reference case projection for Peru. At a medium level of aggregation, under each of the major activity headings shown in Fig. 1, (extraction, refining and conversion activities, central station conversion, transmission, distribution and storage, decentralized conversion), the user selects a particular fuel or demand sector for viewing. For example, he may look at the oil subsystem of a country to examine the flow of oil into each major end-use. Alternatively, a particular demand sector may be examined in greater detail to obtain an immediate visualization of the fuels that feed it. It is also possible at this level of aggregation to select groups of fuels, or groups of demands for review. At the highest level of aggregation, the fine details of each fuel supply subsystem or demand sector are shown. In the case of fuel subsystems, detailed views are available for: coal, oil, nuclear, hydro, gas, geothermal, wind/solar, agricultural/animal waste, wood and animal/human labor. In the case of demand, for each of the seven demand sectors (industry, transport, commercial, urban households, rural households, agricultural, and government) fuels flowing into each end-use are detailed. The networks available in AL-EDIS for displaying various levels of aggregation are shown in Fig. 4.

Development of the necessary computer software to support the graphic network simulator has been completed. This software is composed of a number of computer programs which, in conjunction with the data base, provide the interactive capability described earlier. These programs are depicted in Fig. 5.

Color graphic capabilities designed into the system include the ability to view selected trends, shown in the networks, in the form of bar charts. For example, having viewed the reference-case national energy system, and selected future projections, a user may request a review of trends in national oil consumption under each scenario contained in the system. Figure 6 shows an example of this capability in which Peru's oil consumption projected under various strategies is displayed in the form of bar charts.

For simulation purposes, the software allows users to review data on which existing networks are based. It is possible for the user to select particular cases for manipulation, or, for the user to construct a scenario using his own data. (In Fig. 5 the set of programs allowing this capability are shown under the heading of "perturbation analysis.")

In addition, the completed software allows users to request selected output in printed form.

#### FUTURE DEVELOPMENTS

Work in progress is aimed at adding to the system a set of models which will allow more sophisticated simulation exercises in the network format. For example, it would be useful to allow users the capability of projecting energy requirements within particular sectors on the basis of econometric or input-output models of the economy whose output can be linked to the energy system network for projection purposes. Similarly, it is proposed to incorporate energy system optimization models to allocate the various fuel forms within the network on the basis of minimizing total system costs or any particular component such as capital costs. In addition, the country-coverage of the data base will be substantially expanded.

The data base on energy reserves and resources as well as on the characteristics of specific energy technologies will be expanded. The system will allow technical users to query it directly for such stored information and respond to such requests with output in both printed and graphic form.

A useful information system to support decisions pertaining to both energy systems and to energy and economic development linkages must successfully combine the technical language of energy engineering systems with the numerous socioeconomic parameters used in expressing development objectives. These are of primary concern to policymakers. The categories of information to be included in this system and the network simulator provided for in the system design are intended to effect such a synthesis.

Finally, Fig. 7 shows the various steps in the use of AL-EDIS as a tool for national energy planning.

#### REFERENCES

- Beller, M. (Ed.) (1975). Sourcebook for Energy Assessment. Brookhaven National Laboratory, BNL 50483, Upton, New York.
- Mubayi, V., P. F. Palmedo, and A. B. Doernberg (1979). A Framework for Energy Policy and Technology Assessment in Developing Countries: A Case Study of Peru. Brookhaven National Laboratory, BNL 27613, Upton, New York.
- Reisman, A. and R. Malone (1978). Less Developed Countries Energy System Network Simulator LDC-ESNS. Brookhaven National Laboratory, BNL 50836, Upton, New York.
- U.S. Department of Energy (1979). Joint Peru/United States Report on Peru/United States Cooperative Energy Assessment. U.S. DOE, Office of International Affairs, DOE/IA-0009-01, Washington, D.C.

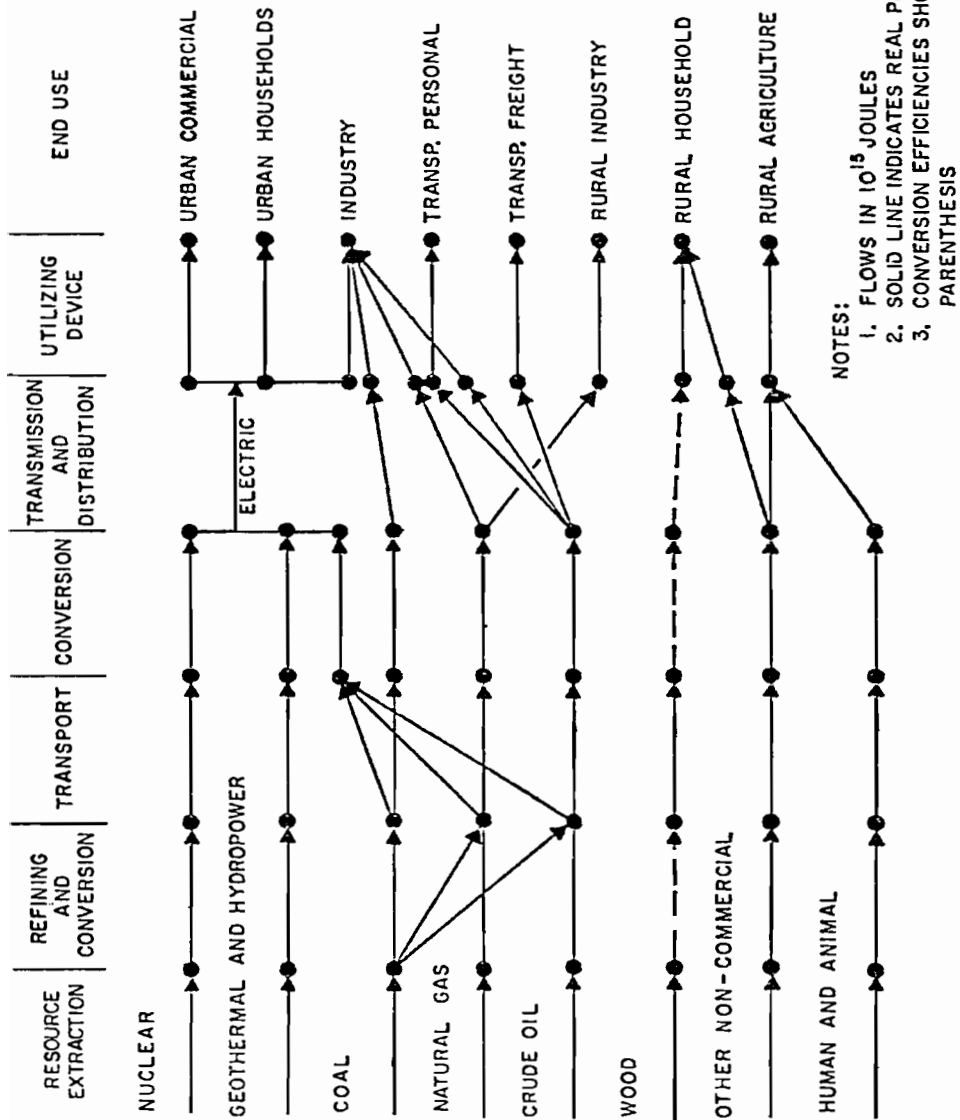

Figure 1 LDC Reference Energy System (ILLUSTRATIVE)

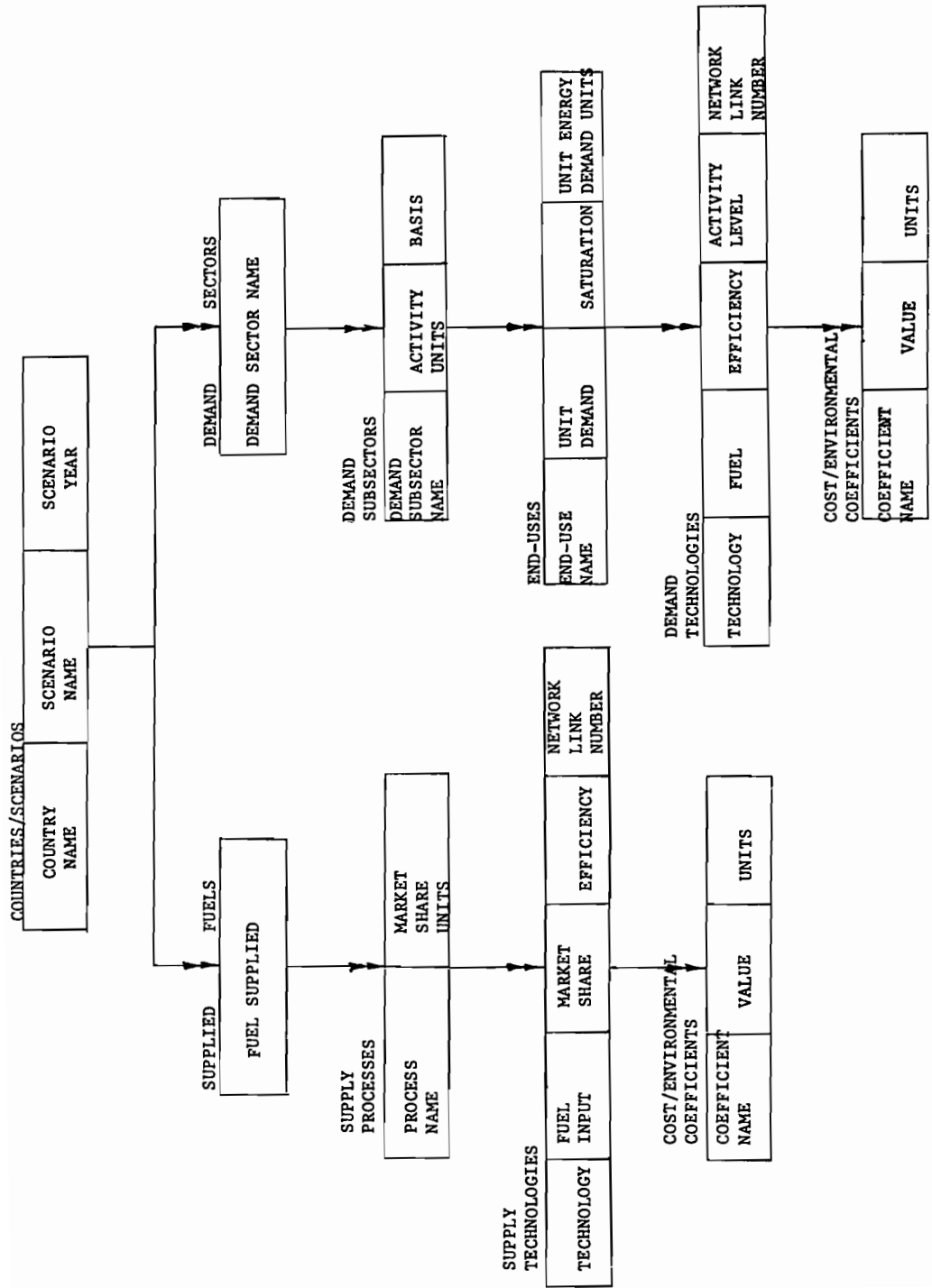

Figure 2 Al-Edis Data Base Schema

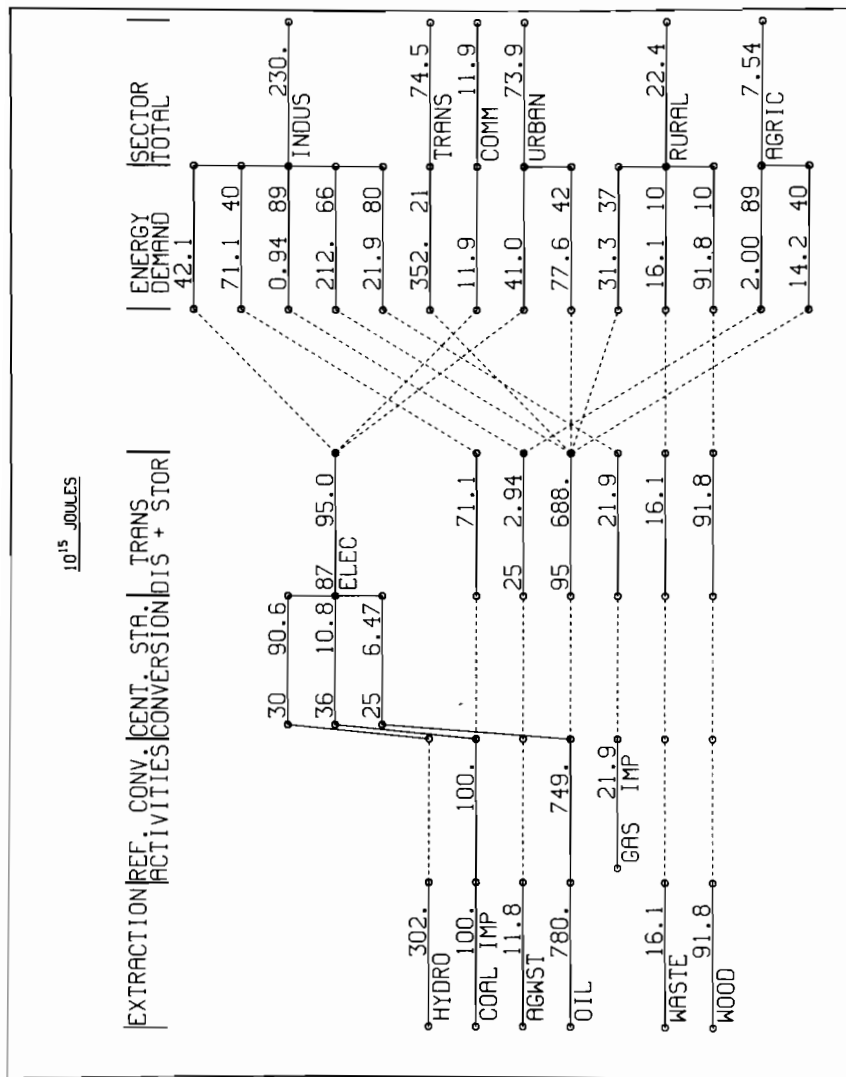

Figure 3 Peru 2000 Business as Usual Network Overview

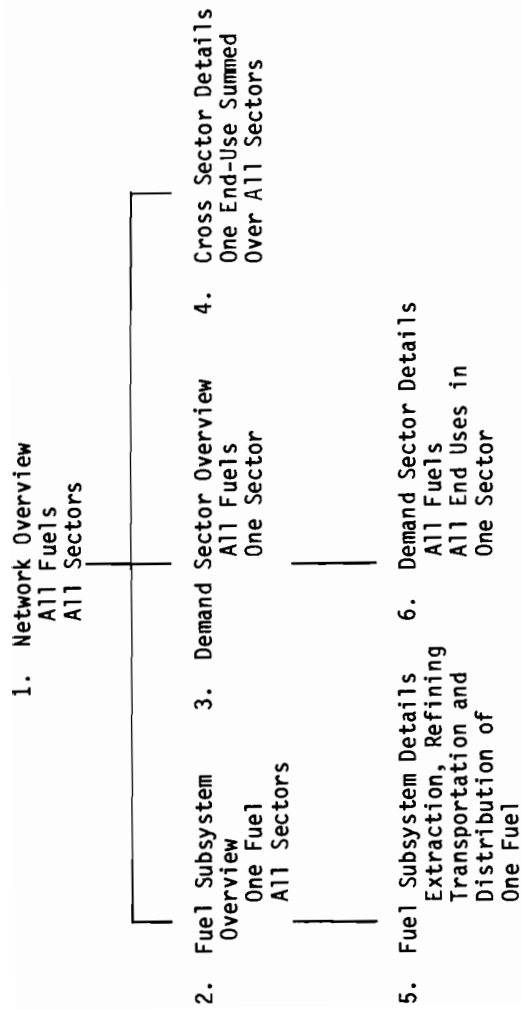

Figure 4 Available Networks in Al-Edis

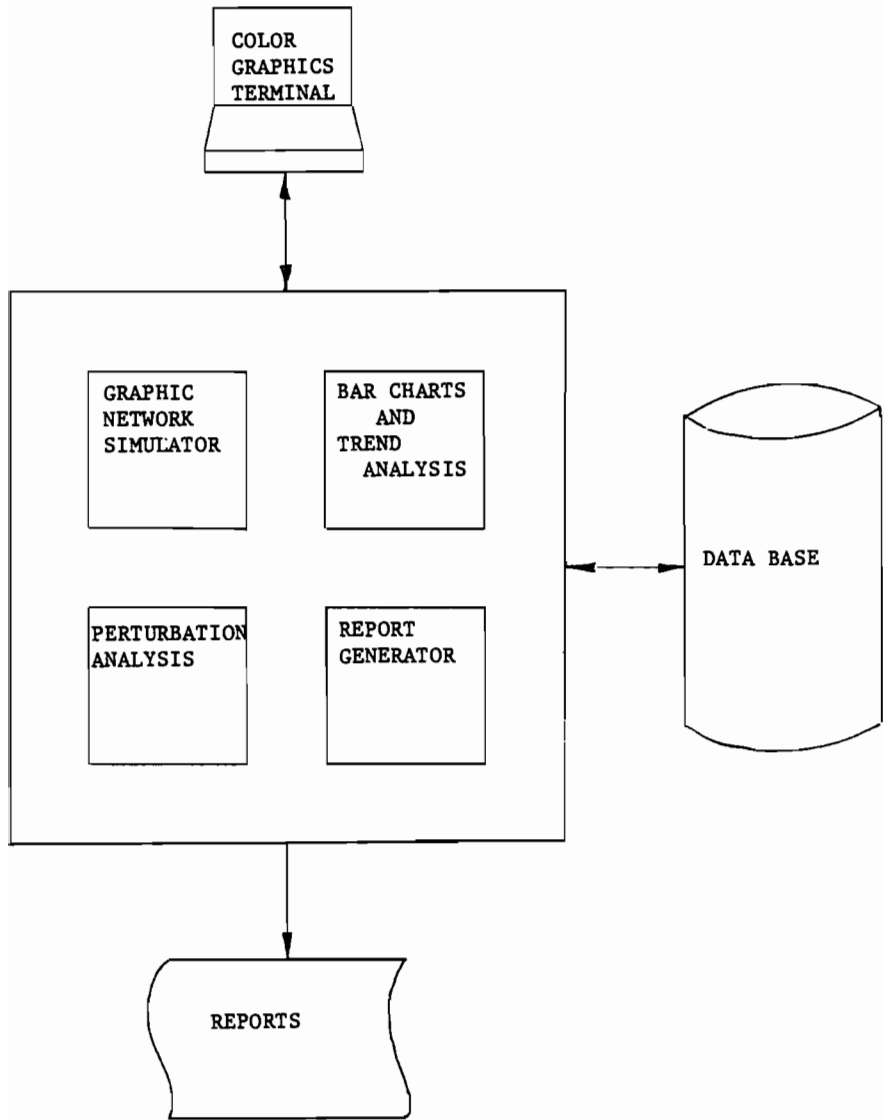

Figure 5 Al-Edis Components

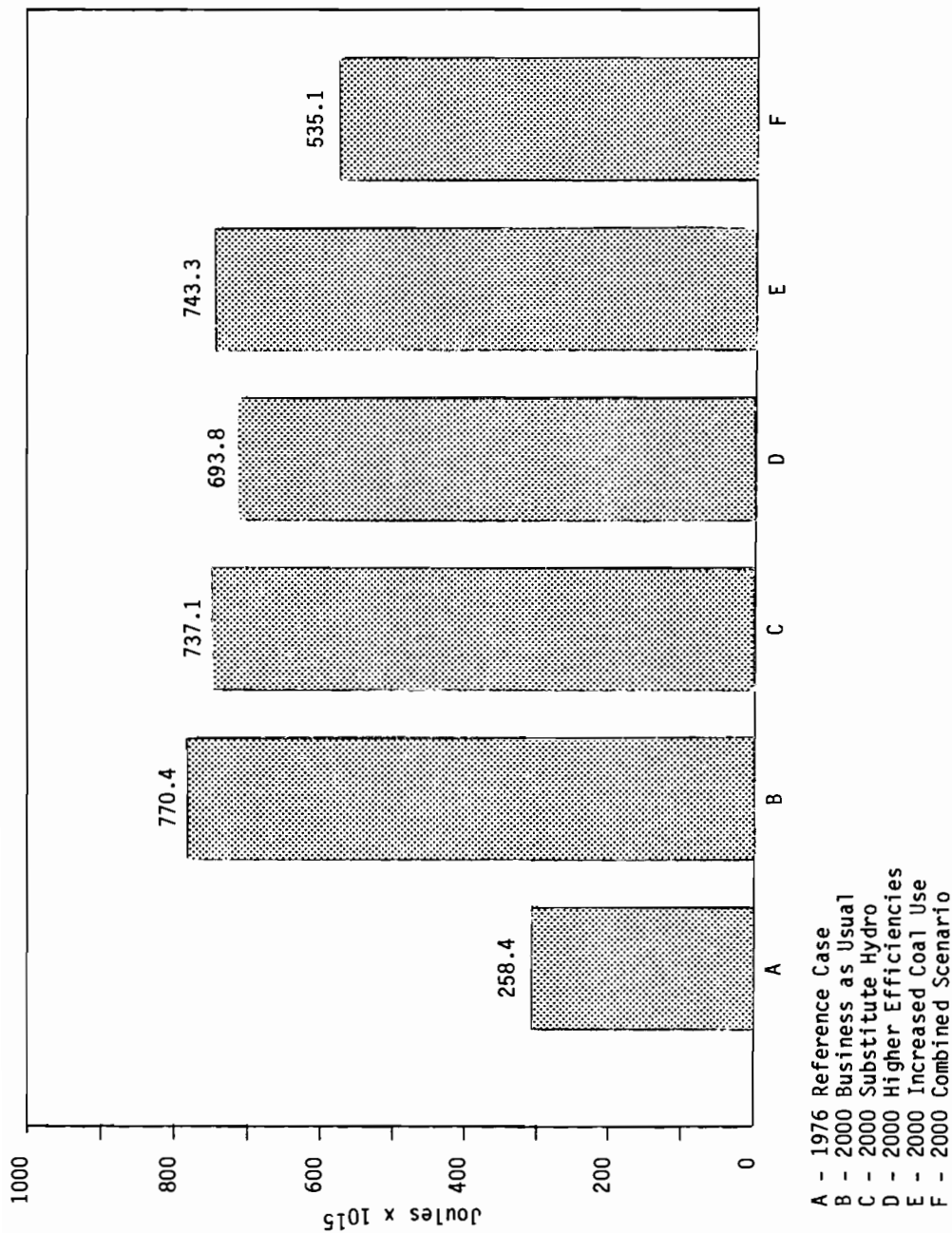
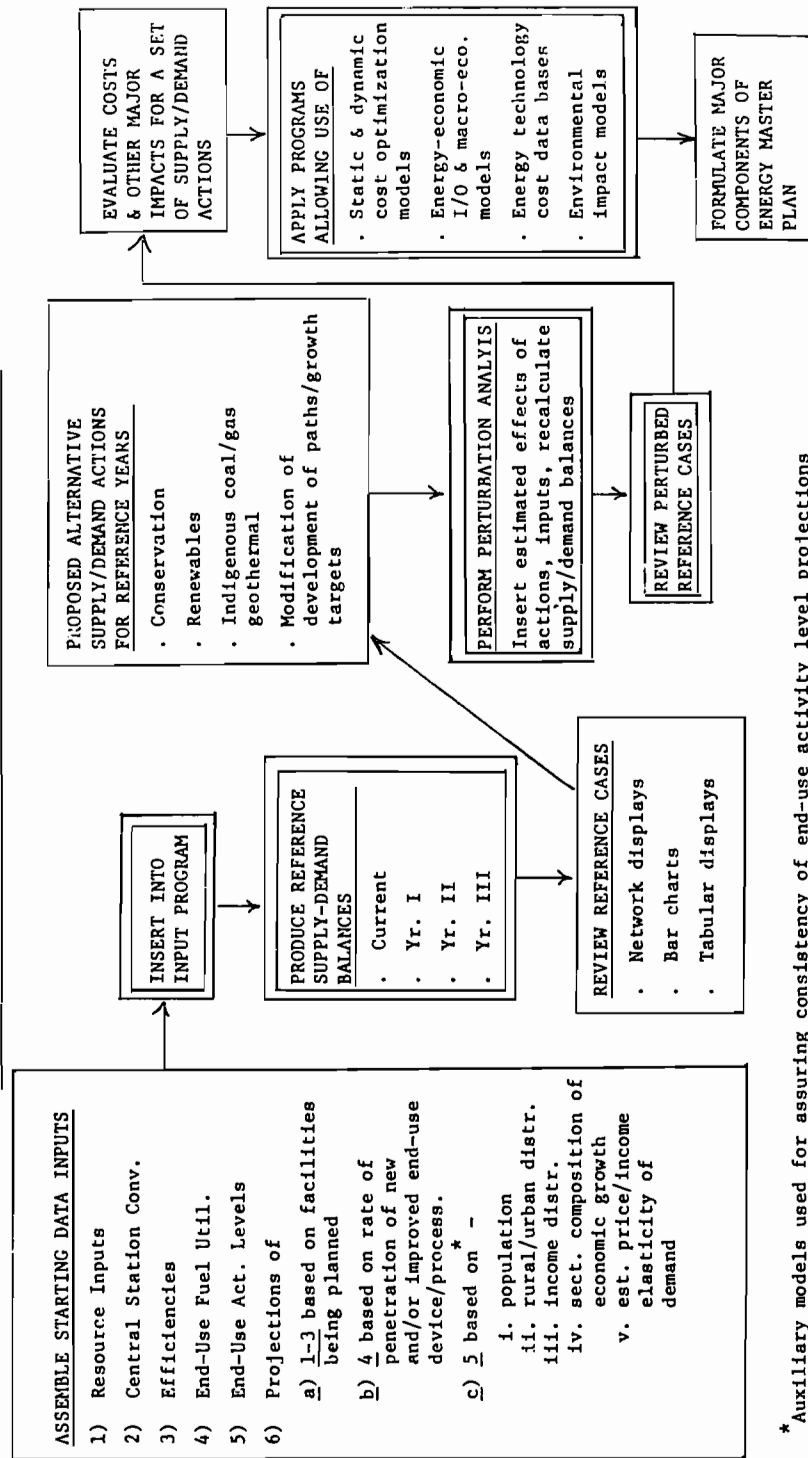

Figure 6 Peru Oil Consumption in 2000 Under Different Scenarios





\* Auxiliary models used for assuring consistency of end-use activity level projections

- 1) Macro-economic growth models
- 2) Activity energy price elasticity and fuel price cross-elasticity models
- 3) Demographic growth models
- 4) Transportation/Land use Models

Figure 7 Steps in the Use of AL-EDIS as a National Energy Planning Tool



*Session IV*

QUESTIONS OF DISTRIBUTION  
AND ALLOCATION OF  
RESOURCES



# ENERGY PRICE: PERVASIVE CARRIER OF INFORMATION

**A. F. Beijdorff and J. H. Lukas**

*Group Planning, Shell International Petroleum Company, Shell Centre, London, UK*

## ABSTRACT

The crude oil price increases of 1974 and 1979 are examined qualitatively with respect to their impact on final consumer demand for oil products. It is argued, that recent statistics suggest that price signals do influence the marketed consumption of energy much stronger and faster than sometimes thought. This evidence is used to suggest some plausible extrapolations of current trends which would imply that the world would use some 7 to 13 million bdoe less oil by 1985 than if 1979 consumption patterns were maintained and the economy grew at 2½% p.a. 1979-1985.

In the second part, some comments are made concerning the costing of alternative forms of energy. It is argued that costing of future technology should be done on a dynamic basis, distinguishing an "estimation phase", a "learning curve" phase and a "maturity" phase.

## INTRODUCTION

As the invited paper on the topic of 'Allocation of Resources' this article will attempt to contribute some thoughts on the subject of the effectiveness of price signals in the market place. It reflects the underlying philosophy of the authors that energy production and consumption are much too complex processes to be effectively centrally regulated in any detail. Thus, the aim of a "resource allocation" policy should be to ensure a maximum benefit to a maximum number of participants with a minimum number of regulations. Such a policy would recognise that the relative price of any commodity has an important role as carrier of information, pervasively reaching all participants.

This article will not attempt to expound a comprehensive and waterproof "theory of optimum pricing", it merely aims at presenting some recent price and consumption statistics in such a way that a pattern suggests itself. The story is told mainly by the graphs and their legends, and the text is mainly intended for "asides".

The article consists of two, loosely interrelated, parts. The first traces qualitatively the impact of the crude oil price increases in the seventies on oil product consumption, the second floats some observations on the desirability of dynamic rather than static costing of new technologies.

PART I : THE IMPACT OF CRUDE OIL PRICE RISES ON OIL PRODUCT CONSUMPTION

The crude oil price over most of this century (that is up to 1970) never exceeded \$3/bbl in money of the day. (See Fig. 1). This implied that from 1948-1970 the crude oil price decreased steadily in real terms. Most of the infrastructure currently in place in the OECD countries was designed with this comfortable prospect of falling real prices in mind. Since 1974, this has obviously changed (See Fig. 1). It should be noted, that the technical potential for (further) energy efficiency improvements is very substantial (say 20-40% of 1973 average practice) and that much of the existing stock of buildings and industrial plant can successfully and gainfully be improved. As this potential has been well documented elsewhere it will not be further elaborated upon (this article has no reference list, due to difficulties of "embarras du choix" and for fear of discrimination). It should suffice, that few experts disagree nowadays that considerable savings would be possible at economical cost, provided the energy consumers "get the message".

It is generally believed that the "elasticity" of oil consumption is very low. This article attempts to illustrate the authors' notion that this elasticity is not so very low after all. It should be said before hand, that the material shown is not conclusive proof, and much of the assertions made in this article have yet to rely on "hunch" and "notion" techniques.

If we trace the impact of the ten fold crude oil price increase (in real terms) between 1970 and 1980 on the final consumer selling price, than we see that the selling price, in real terms, increased by a much lower factor than ten-forinstance in the EEC by only a factor of roughly two across the barrel.

We should now distinguish two main components of the price mechanism: the income effect and the price effect (See Fig. 2).

As the price of imported crude oil shoots up, direct effects (such as loss of spending power in the non oil sector, recycling delays etc) and indirect effects (consumer's increased savings ratio, loss of business confidence, a switch in government policies towards deflationary measures, etc) will cause a recessionary slow-down in economic growth of consuming countries. This results in a lower economic output than otherwise would have resulted. This is referred to as the income effect. One can estimate this impact: some detailed studies suggest that every additional \$1 crude oil price increase reduces economic growth in the World Outside the Communist Areas (WOCA) by  $\frac{1}{4}$  to  $\frac{1}{2}$ % over the next year or so.

One can then also calculate the loss of economic output in money terms and divide this by the amount of oil thus saved. This illustrates that imported crude oil has a very high "nuisance value", in the order of \$250-\$500/bbl.

The second link in the price mechanism is the price effect, i.e. the reduction in consumption per constant unit of income. This is expressed by a decrease in oil/GDP for an increase in the oil price. It is interesting to note that the costs of substitution and conservation are significantly lower than the "nuisance value" indicated above. Although few energy consumers will realise this consciously, it is nevertheless an illustration of the strong incentive that is implicitly administered by the "invisible hand" of the imported crude oil

price.

If we now examine how the crude oil price increases hit the consumer in the main oil consuming markets, then - again for the EEC - we see that the spread has not been even at all (See Fig. 3). The transport sector saw hardly any increases in fuel prices, whereas the industrial sector saw a virtual doubling (in real terms) of the fuel oil price.

(As a humorous aside, we could compare the erosion of the consumption tax per barrel in real terms in the EEC with the sharp increase in taxation of oil and gas production. For policies that profess to aim at curbing consumption and maximizing indigenous supplies, such a taxation policy makes obvious sense).

Focussing now on the price effect (as opposed to the income effect) we can examine the consumption of the main oil products per unit of GDP (See Fig. 4). Qualitatively, we see - again in the EEC - a very good agreement between the reductions in consumption per unit of GDP (in constant money) and the corresponding increases in relative prices.

Without wanting to draw too strong conclusions from such a short time series, and recognising that roughly half of the reduction shown is substitution rather than conservation, we still would like to submit this evidence as an indication that Adam Smith's "invisible hand" is still as active as ever, and still very effective.

A similar analysis (not presented here) has been carried out for the USA. There the price signals were not as clear as in the EEC, for well known reasons, but qualitatively, the same conclusions can be drawn. In real terms, 1979 was the first year that gasoline prices really went up significantly since 1968 or so in the US, and the reaction was clear: a 5% reduction in gasoline consumption in 1979, (i.e. a 7% reduction in consumption/GDP) over one year, in response to a real price increase 1978/1979 of not more than 30%.

In 1978, the US consumers spent roughly 5% of total Consumer Private Expenditure on gasoline. With oil price deregulation now a firm fact one can predict that, in real terms, the gasoline selling price will go up by at least 60% and possibly as much as 100% as compared with 1978. This would imply that the percentage of CPE spent on gasoline would go up to 8-10%.

However, at such a percentage level, the consumer will have to take notice, and the signs are everywhere loud and clear that the US motorist is taking notice.

We can therefore now confidently predict that the US government's compulsory miles-per-gallon legislation will be able to boast some spectacular results over the next five years.

Another little example of how price signals can work fast in the market place comes from the Netherlands. During the car-less Sundays in 1973 (as a result of the Arab oil embargo) vehicles powered by LPG and diesel fuels were exempt. This made the public suddenly much more aware of the existence of such fuels. Added to that, the fact that LPG is not taxed in the Netherlands ensured a rapid penetration of LPG powered passenger cars. A loss of 10% in kilometres driven on gasoline over just 5 years is a very fast reaction indeed (See Fig. 5).

Finally, one can examine the expenditure on fuels as a percentage of total expenditure. After all, if the price of a commodity doubles and your income

doubles too (all in real term of course) then you are not all that much worse off, in fact, none at all. Plotting expenditure on oil products as % of GDP, CPE, and Manufacturing Output in the EEC (See Fig. 6), reveals a surprising tendency "back towards the norm", (a similar tendency can be observed in the US). If it were indeed true that there are certain universal percentage ranges that consumers of different income levels tend to spend on certain categories of fuel consumption, then the corollary would be that the long term price elasticity of oil products is one, and that "long term" in this sense would mean only some five years or so.

The above observations, (together with all the little signs in the newspapers) have led the authors to the notion that over the next five years, simply due to the fact the "the consumer will get the message", the world could be in for a surprise on oil consumption. Rather than an inelastic demand that grinds inexorably into the inevitable medium term oil supply constraints, a scenario could be foreseen in which the world finds itself (rather to its own surprise) in a situation where the call on OPEC oil has fallen below 25 million barrels per day by 1985, whereas WOCA GDP still has managed an average growth of some 2½% p.a. (See Fig 7 and Fig. 8).

Although this scenario still has all the chances of sliding into a crisis situation at any time over the next five years, it is interesting to note that it presents a plausible solution to the current dangerous situation (by allowing Saudi Arabia, for instance, to come down to more comfortable levels of production), and that the makings of this solution are, unbeknownst, already emerging all around us. A careful monitoring of oil/GDP over 1980/81 will be a rewarding task for virtually all policy makers.

## PART II : THE COSTING OF ALTERNATIVE ENERGY SUPPLIES

In terms of energy resources substitution (i.e., coal gasification, liquefaction etc.), the result of the 1973 oil crisis was anything but a crash program in the OECD countries. EEC expenditures for research in this field increased by 66% between 1974 (which was budgeted before the crisis) and 1976. While this is not much in relative terms as a reaction to the tripling of crude oil prices, the absolute figure of less than \$60 million in 1976 demonstrates even more the lack of significant response. Overall expenditure on energy R & D went up by 40% in the same period (these figures are not deflated!). Half of this figure went into nuclear energy, an energy conversion system which was well into its disappointment scenario.

US government energy R & D exceeded that of EEC member states from 1976 onwards. Between 1975 and 1978, expenditures doubled. Industry figures are available only to 1976, at which time they amounted to half of government expenditures. Even with the above increases it must be realized that total energy R & D expenditures amounted in recent years to no more than money spent on the space program, and one quarter of defence R & D costs.

A number of factors specific to the development of new energy resources and conversion systems and to their environment have contributed to the 'much-talk, little action' situation prevailing between 1975-79 in the three regions: USA, Europe, Japan.

1. Oil prices remained stable in dollar terms and supplies appeared sufficient for the time being. For Japan and some European countries, prices actually declined in terms of local currencies. In the USA, price controls on indigenous crude oil dampened the effect of OPEC price rises.



2. The technology necessary was, with few exceptions, basically known - although (as in coal conversions) it had lain dormant for decades. In reality, very few people had actual experience with them. This led to underestimation of costs in time, money and manpower needed to establish viable modern processes.
3. Classically, the system size of a new technology serving a new (self-created) market grows in parallel to the growth of that particular market. The situation concerning energy conversion systems (coal, gas, geothermal) is different in that they will supply existing markets. Therefore, after having gone through the development stages of pilot, demonstration and/or pioneer plant, they are likely to arrive at their ultimate size more or less immediately on commercialization.

The very large initial size and cost of installations for a new technology leads undoubtedly to hesitation in decision-making. This hesitation is exacerbated by an unusual degree of uncertainty, due to the unprecedented influence of politics on this particular market.

4. Most importantly, cost estimates of alternatives appear to float upwards over time ahead of conventional energy costs (See Fig. 10 and 11), while individual cost estimates reckon with a fixed cost (See Fig. 9).

The present situation for coal gasification and liquefaction in particular shows, for the reasons given above, overruns on lead time and cost estimates.

Rand Corp., in a report to the US Dept. of Energy (August 1979), assesses the cost of a 'first-of-a-kind' energy process plant at  $2-2\frac{1}{2}$  times initial cost estimates. Not the least of reasons for optimistic cost estimates is to attract money for a project - particularly when external funds are sought. Nevertheless, it is wrong to expect the cost trend to continue into the future: as the body of know-how has accumulated over the years, the date of possible innovation has come nearer and areas of uncertainty have shrunk, so the growth in costs has receded in newer estimates. The Iranian supply short-fall and subsequent price rises have led to a flurry of activities which are reminiscent of the oil crisis of 1973. However, given recent development work - and after deduction of rhetoric - a good deal more is now expected to be converted into actual hardware - and with reduced lead times - than in the period 1974-1978.

We have already alluded to the escalation of cost estimates for alternative hydrocarbon fuels over time. In addition, there is a myriad of sources of cost estimates, differing in basic assumptions, so that a 'marker' cost in terms of a league table is nearly meaningless. Moreover, factors other than purely economic considerations play a decisive role in determining which feedstock to use in what process to produce which products.

Necessary briefness leads in the following analysis unavoidably to superficiality and incompleteness!.

Fig. 9 (for coal-derived liquids) exemplifies the conventional approach to costs of alternative energies - i.e. a time-independent level of costs versus an increasing price of imported/OPEC crude, leading to a breakeven point.

Unease about the reality of escalating cost estimates has led the US Department of Energy to commission studies investigating the underlying reasons, and to attempts by cost engineers to include factors perceived by them to contribute to

the escalation. The conclusions reached can best be divided into factors external and internal to the particular estimate.

External factors include:

- Change of scope and objective.
- Post-facto changes of governmental rules.
- Management by committee, especially where non-economic actors are involved (government).

Internal factors are:

- Deliberate underestimation in order to procure funds.
- Insufficient project and process contingencies.
- 'Static' estimation.

The conventional approach (static estimation) to project evaluation using discounted cash-flow (DCF) calculation can be briefly typified as consisting of: an assessment of process parameters and their uncertainties, resulting in a total erected cost; and an assumption of feedstock and other operating costs. A required DCF return is then used to calculate sales revenue, i.e. product values - the latter being cited as the cost of a "barrel of oil equivalent". In order to avoid underestimation of future costs, use has occasionally been made of a general inflation factor (e.g. 5% a.a.i.) for all costs and for sales revenue. However, since costs are smaller than sales revenue, this only boosts cash-flow artificially and thus the resultant DCF return. A better approach is where capital costs of a future plant are escalated along past cost index curves. However, this has not been applied to operating costs and sales revenue, and furthermore it is a purely mechanical trend extrapolation.

Instead, this paper suggests the use of scenarios for such cost estimates. In such a "scenario dependent project evaluation", historic trend lines for costs and prices are modified to be consistent with a particular scenario.

To demonstrate the principle, a coal liquefaction study was used evaluating the supercritical gas extraction process for a US site. Without giving quantitative data we will briefly describe the methodology.

For simplicity's sake the scenario-dependent variables can be lumped together under 4 headings:

- Total Erected Cost
- Feedstock Cost
- Operating Cost
- Product Values

Total erected cost was assumed to follow the Chemical Plant Index (Chemical Engineering, continuously updated). Between 1970 and 1978, this index seemed to follow the GDP in an anti-cyclical fashion. It can be argued that this anti-cyclical mode is in reality a time-lag of half a business cycle, which coincides with the 2-3 years between an investment decision and actual conclusion

of contracts and equipment orders. Over the longer term, low economic growth results in higher unit prices due to a lack of innovative investment.

Feedstock (coal) Costs can be assumed to follow oil prices, as they have over the period of 1970-8. Other Operating Costs, mainly labour, can be expected to follow the general GDP/cap increases. Finally, Product Values can be linked to the oil price index. The resultant cash-flows are then used to determine the DCF returns.

Our findings were that the static approach can overestimate the profitability of a venture considerably (15% rate of return versus 2-9% depending on plausible scenario assumptions).

#### SUMMARY

---

##### Scenario Dependent Project Evaluation

---

- Derive - Plant cost index (= Chem. Plant Index) to calculate:
    1. Total erected cost in year 1 (=1985)
  - Feedstock price index (= oil price index) to calculate:
    2. Actual feedstock costs per year.
  - Operating costs index (= GDP index) to calculate:
    3. Operating cost per year.
  - Product value index (= oil price index) to calculate:
    4. Sales revenue per year.
  - Calculate % DCF return.
- 

This exercise was done for demonstrative purposes. A considerable amount of refinement can and should be done to establish better future sensitivities to input factors.

Over the somewhat longer term one should distinguish for each technology an "estimation phase", a "learning phase" and a "maturity phase (See Fig. 12). This will show that the relative advantage of different types of technology and their combined impact on the average energy price can vary considerably over time. The method can then be used to determine the main sensitivities, optimal start-up date and the best production site-market correlation - in a world in which costs, prices and economic activity levels will increasingly reflect regional (rather than global) developments.

#### CONCLUSIONS

It is said that if one were to put all energy price experts in the world head to foot they would never reach a conclusion.

We leave it to the reader to draw his own inferences from the thoughts and material presented.

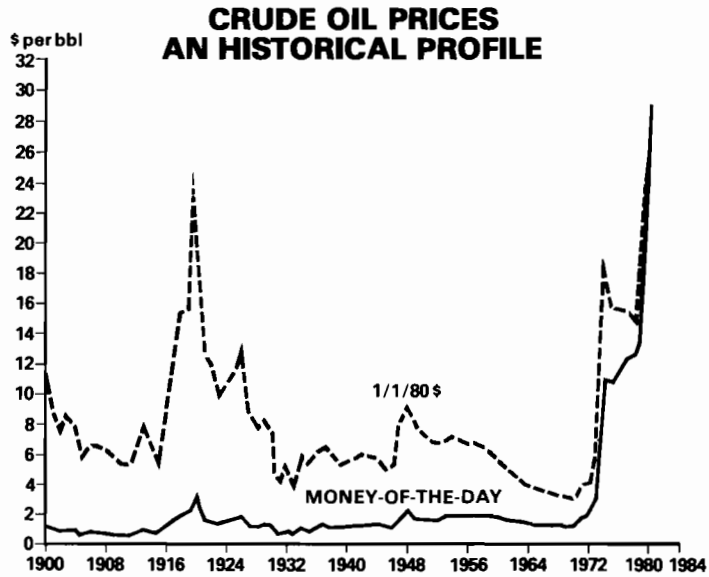

Fig 1. Since the turn of this century until 1979 the average crude oil selling price has ranged from \$0.5 to 3/bbl in terms of money of the day. This implied, that, since 1948, crude oil became steadily cheaper in real terms. Most of the current oil consuming equipment was designed with this prospect in mind. Since 1970, when oil provided more than half of the total world primary energy, its price has gone up by roughly a factor of 25 in terms of money of the day, that is about 10 in real terms. With two price shocks behind us, we can now wonder what the demand elasticity for oil is.

### REDUCTION IN OIL CONSUMPTION

PRICE	Works through	Details	Cost
	<b>Income elasticity</b>	<b>GDP</b>	<b>\$/boe</b> <b>250 – 500</b>
	<b>Price elasticity</b> • <b>Substitution</b>	<b>Oil/GDP</b> • <b>Coal/Nucl</b> <b>in el. gen.</b>	<b>10 – 15</b>
		• <b>Gas</b> <b>in Ind/Dom</b>	<b>20 – 40</b>
	• <b>Conservation</b> – <b>Efficiency</b>	• <b>Transport</b> • <b>Domestic</b> • <b>Industry</b>	<b>30 – 50</b> <b>20 – 40</b> <b>5 – 25</b>
	– <b>Economies</b>		<b>?</b>

Fig 2. Crude oil price increases work through to oil demand at two levels: income effects (expressed as a reduction in GDP growth) and price effects (expressed as a reduction in oil/GDP). The latter works through substitution and conservation, which in its turn can be subdivided into technological energy efficiency improvements (e.g. home insulation) and economics (i.e. improved heat management). The estimated loss of economic output (due to the income effect) divided by the reduction in oil demand due to this economic recession gives a measure of the overall economic cost of saving oil by economic deflation (i.e. \$250–500/bbl). The costs of alternatives and conservation are considerably less.

### OIL PRODUCT PRICES: EEC

\$/bbl 1/1/1980 prices and exchange rates 1st of Jan. each year.

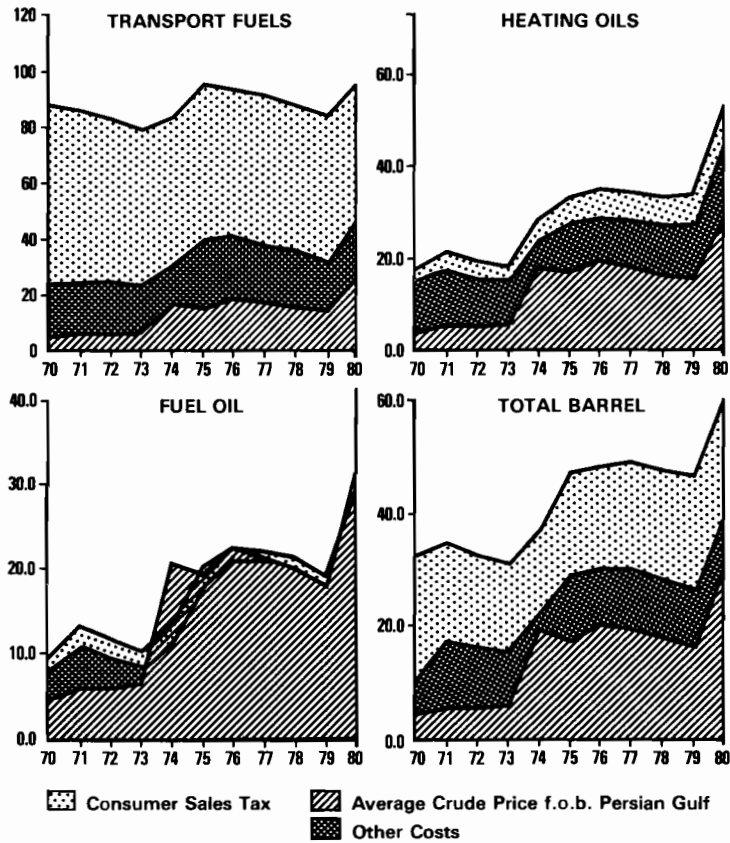

Fig 3. The crude oil price increases of 1974 (see Fig 1.) hit the consumer in a much dampened way, due to the other price elements in the final selling price. Shown are (for Transport Fuels, Heating Oil, Fuel Oil and Total Barrel) the listed final consumer price in the EEC in constant 1980 money, broken down into: average crude price (f.o.b. Persian Gulf), sales tax (excise and VAT) and (by difference) all other costs. From this it is clear that on balance the motorist saw very little real price increase (as a result of the sales tax erosion in real terms), whereas heating oil went up by some 70% and fuel oil by some 90% in real terms. In contrast to 1970, where the share of the crude price in the final average selling price was some 12%, currently it is over 50%, so that further real price increases will hit the final consumer much more directly than in 1974.

### Recent Trends in Oil Consumption in the EEC

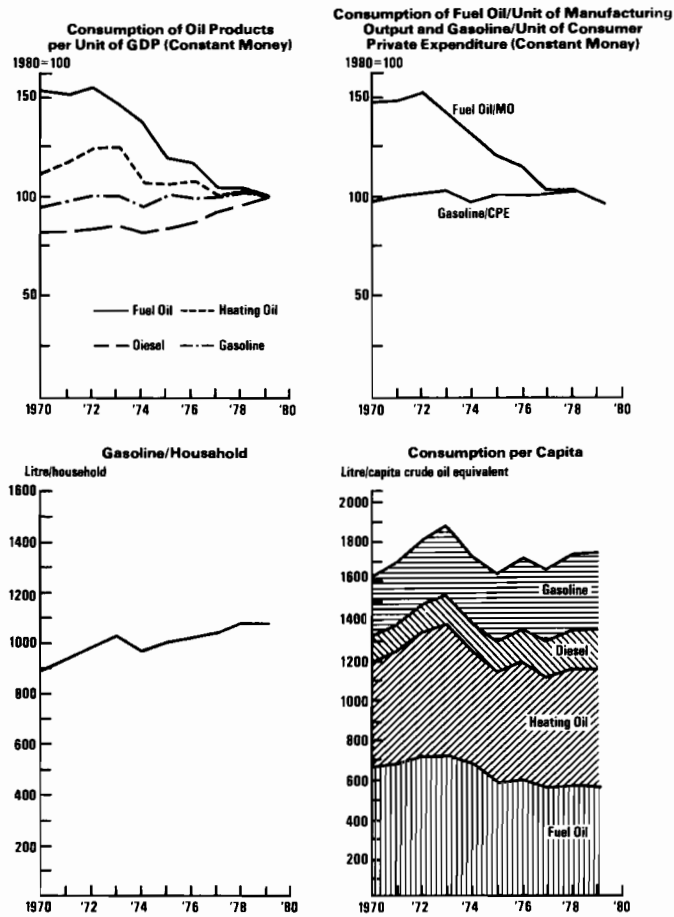

Fig 4. The relative price increases shown in Fig 3. can be traced to their effect on consumption. So as to eliminate the income effect, consumption of Oil Products is shown per unit of GDP (in constant terms). After steady increases over the sixties, 1974 was a turn around point for all main products except diesel fuel. Fuel Oil/GDP came down by a third and heating oil by a quarter over just five years, whereas gasoline ceased to grow. This is in good qualitative agreement with the size of the corresponding relative price increases. (Diesel fuel increased its share since 1977 mainly due to the first time availability of a new range of diesel powered passenger cars and to taxation policies in some countries). Gasoline shows a marked plateauing in trend, (either as consumption per unit of private consumer expenditure or as consumption per household), a significant change, considering the small absolute increase in gasoline selling prices. On balance, the EEC now consumes less oil per capita than it did in 1973. Roughly half of the observed effects are due to substitution, the other half to a mixture of structural changes and conservation. These data suggest that the market reacts much faster to price signals than is commonly thought.

### An Example of Market Reaction to Shock & Price Signals Recent Displacement of Gasoline in the Netherlands

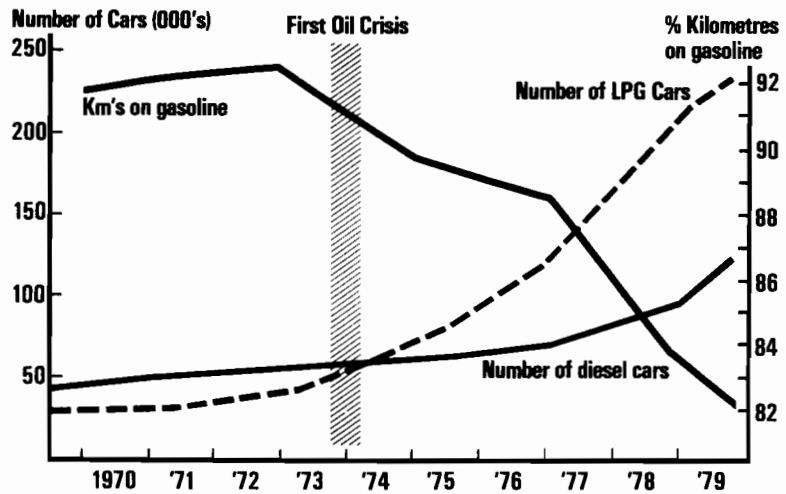

Fig 5. Another illustration that the market does react fast to clear signals. After the carless Sundays in 1973/1974 in the Netherlands, when drivers of LPG and diesel powered cars were exempt from the driving ban, interest in LPG powered cars increased sharply, notwithstanding an extra installation cost of roughly \$900 per car. LPG is not taxed in the Netherlands, so that the selling price of a litre of LPG is roughly half that of gasoline. Diesel is taxed well below gasoline, with a resultant selling price roughly halfway between gasoline and LPG. It is interesting to note that gasoline cars lost some 10% of kilometres driven over just 5 years. The diesel cars only began to make an inroad after 1977, when for the first time a good range of diesel powered passenger cars came on the market.



### Recent Trends in Expenditure on Oil as Percentage of Income in the EEC

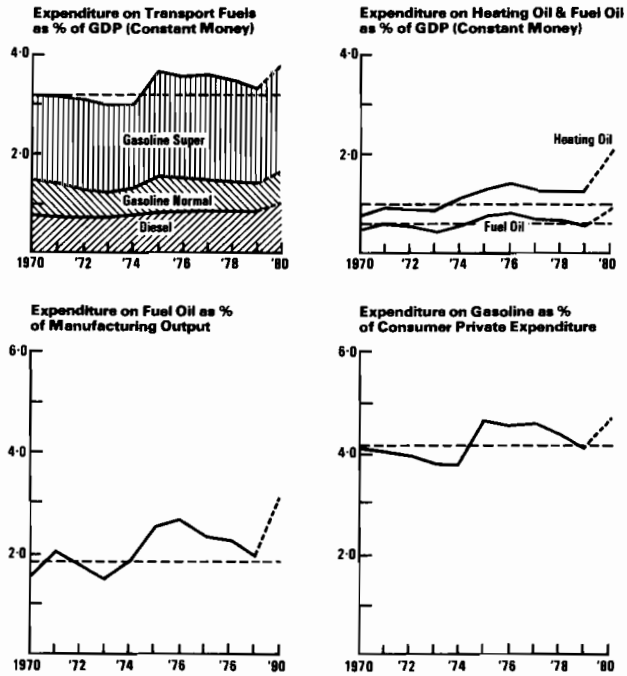

Fig 6. The oil product consumption data of Fig 4. can be combined with the price data of Fig 3. to give the expenditure on oil products as part of total expenditure (or value added). One can observe, at least for transport fuels and for fuel oil, a trend of "constant percentage of income". If true, this would imply that the long term price elasticity of oil products is one, higher than commonly thought.

### Energy and Oil Consumption per Unit of GDP (at 1970 prices)

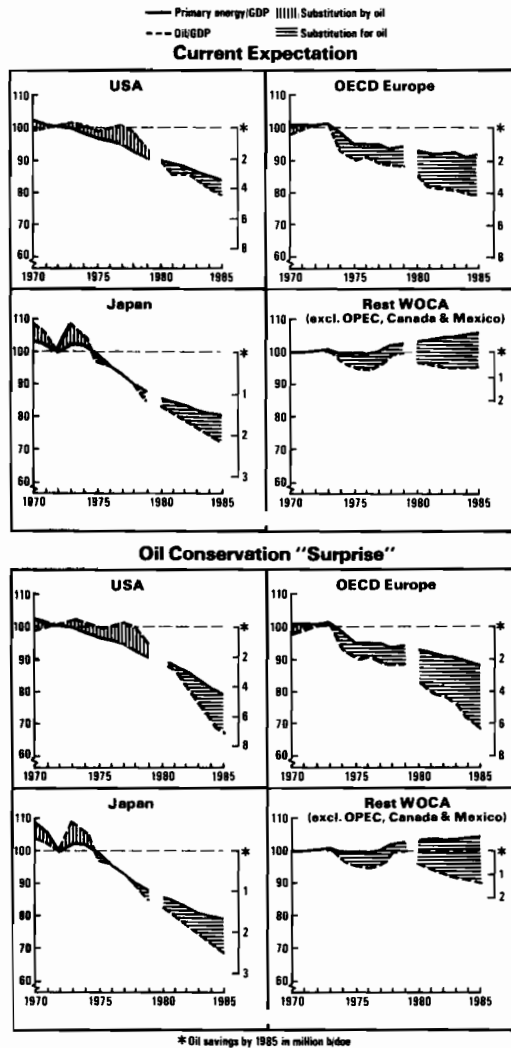

Fig 7. By plotting both total primary energy and oil per unit of GDP, indexed to the last pre-crisis reference year (1972), one can illustrate the overall reduction in energy and oil intensity, and, by difference, the amount of substitution by or for oil. USA, OECD Europe and Japan have all significantly reduced their energy intensity. Whereas OECD Europe and Japan had decreased their oil intensity by some 10 – 15%, the USA in 1978 was almost back where it was in 1972. Last year, however, saw a sharp turn-around which, given the certainty of oil price decontrol, now can be expected to continue if not accelerate. Given a conservative extrapolation of current trends and estimated availability of non oil energy, the World outside Communist Areas (WOCA) would consume some 7 million bdoe of oil less than it would have on 1979 consumption patterns. One can foresee an extra effect due to the 1979 price shock, this could possibly reduce consumption by a further 6 million bdoe by 1985, given the same level of economic output.

## A HYPOTHETICAL REFERENCE CASE

### Contribution of Non-OPEC Energy, and Reduced Energy Intensity to reducing the Call on Opec Oil

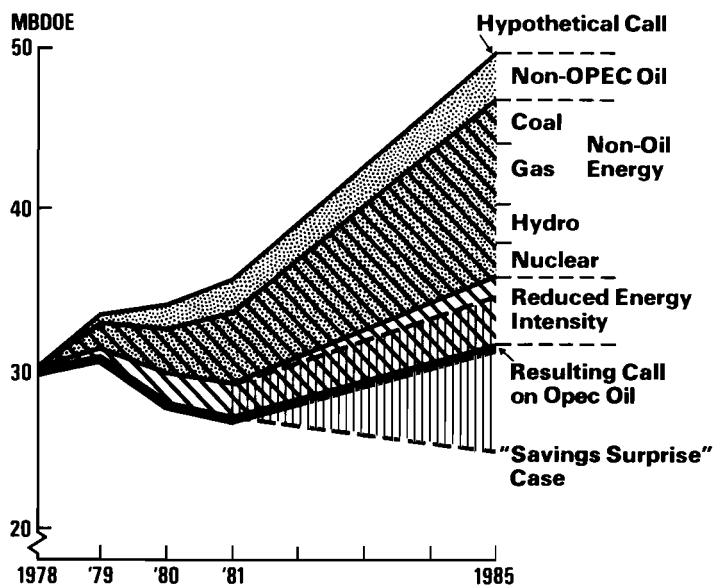
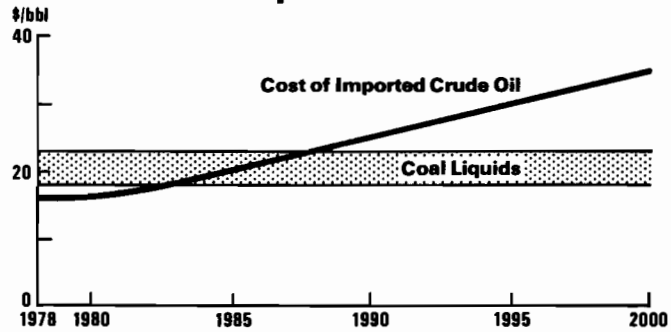

Fig 8. The relative significance of substitution and conservation are illustrated by their effect on a hypothetical call on OPEC oil (corresponding to an economic growth of some 2½% p.a. for WOCA 1979-1985). If oil were the only balancing fuel, call on OPEC oil would increase to 50 million bdoe by 1985 (which would obviously not be met). With the anticipated net increases in non-OPEC oil production and the "conservative" extrapolation of energy intensities and availability of non oil energies of Fig 7., this call reduces to some 30 million bdoe by 1985. The "plausible oil conservation surprise" (or "the consumer gets the message" scenario) of Fig 7. would reduce this call to some 25 million bdoe, which would ease the potentially tense oil supply situation considerably.

### Cost Comparison: Coal Derived Liquids and Imported Crude Oil



Source: US Department of Energy, 1978

Fig 9. Without going into details of oil pricing, one can observe that in the long run the cost of large-scale alternatives will be a limiting factor for the currently foreseen upward trend in the real price of crude oil. Nevertheless, the following figures illustrate that there is no such single figure as "the cost of alternative energies". The above graph indicates a method of cost comparison which should be considerably refined if it is not to lead to erroneous conclusions. One should not reflect on the obvious fact that the crude oil price forecast as shown was "wrong" since the medium term crude oil price is virtually "unforecastable". However, the notion that an alternative energy – such as coal liquids – has a constant fixed cost, which will make it competitive at a certain crude oil price level, is not correct. As shown in the following figures, one should adopt a more dynamic approach.

## The General Perception of Capital Costs of Alternative Energy - 1975 to 1976

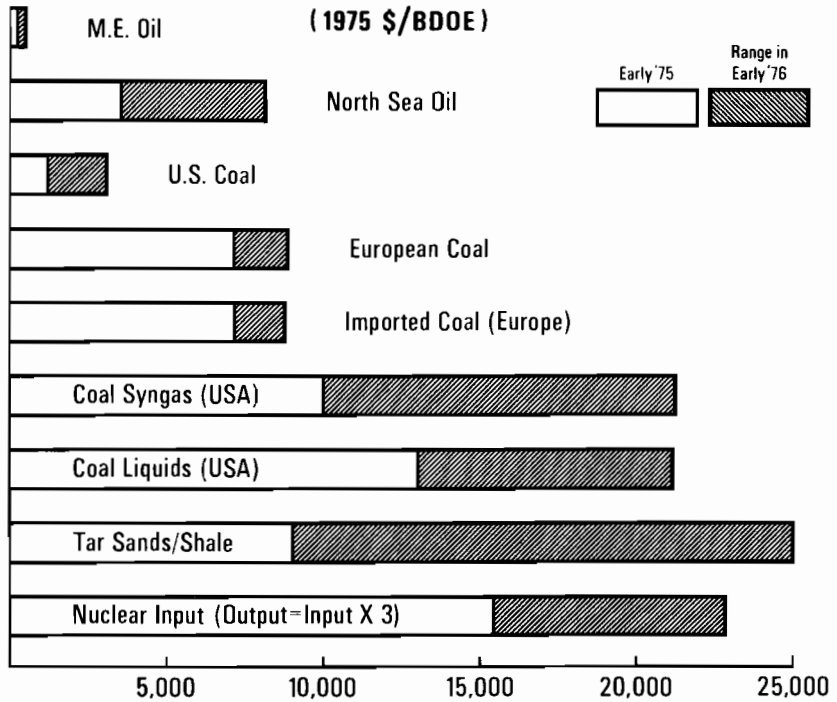

Fig 10. This graph illustrates that cost estimates of new technologies which are not yet in large-scale commercial operation, are to be treated with extreme care. The estimates of North Sea Oil, Coal Conversion and Tar/Shale virtually doubled (in real terms) between 1975 and 1976.

## What keeps Shale Oil non-competitive

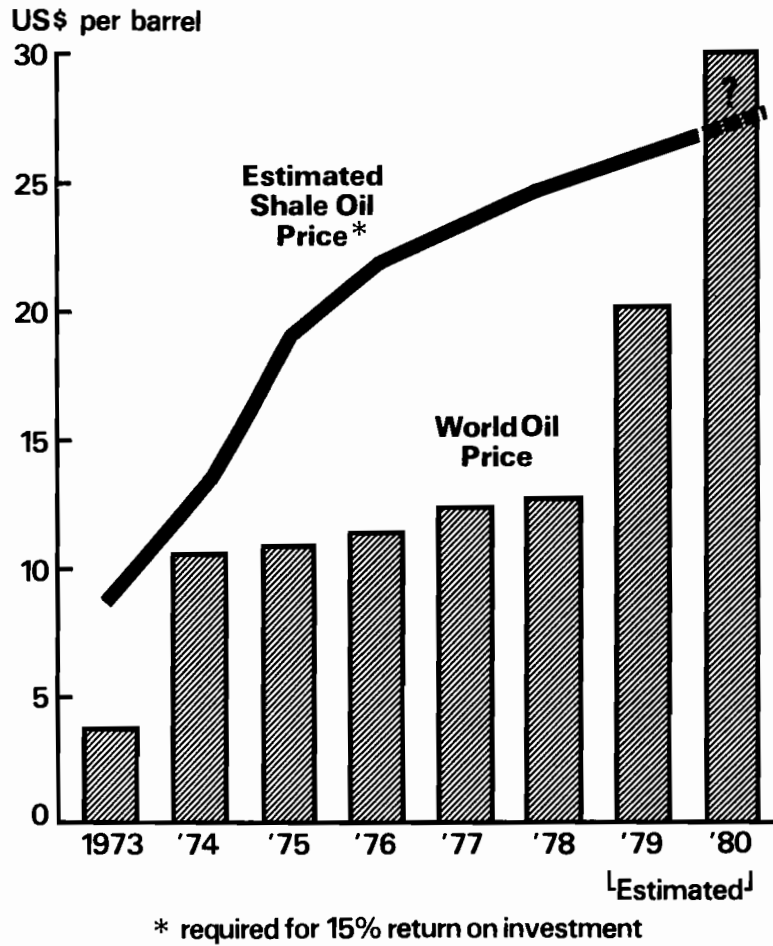

Fig 11. This is another example of how cost estimates escalate during the development phase of a new technology. Shale Oil, costed at \$8/bbl in 1973 was costed at \$25 /bbl in 1979. It will be interesting to monitor further cost estimates, now that the world crude oil price has finally exceeded last year's estimated cost.

## The Three Phases of Costing of New Technologies

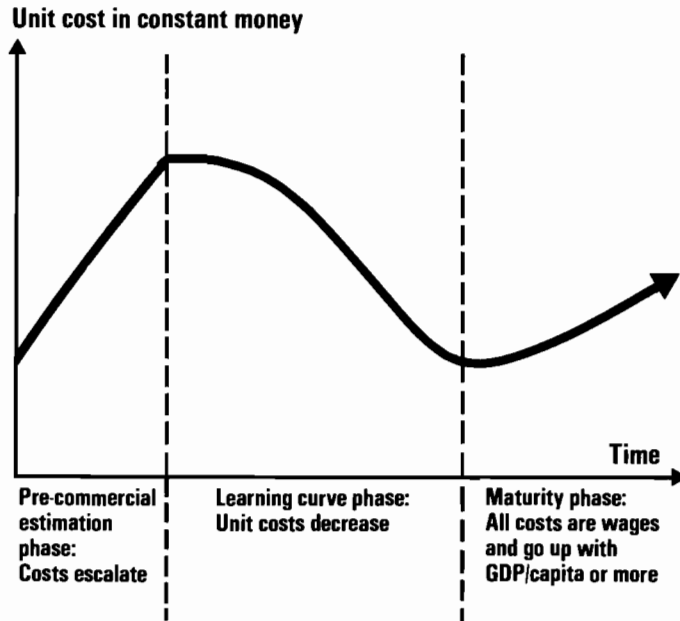

Fig 12. In order to get at least some qualitative idea of the interaction of the various forms of energy-other than conventional oil- with the average oil (and energy) price, one should adopt a dynamic approach in which the various technologies are distinguished as to the "development phase" they are and will be in. One should distinguish at least three phases as illustrated above. Tentatively, one could perhaps put conventional oil production and transportation, pipeline construction and LNG technology in their "mature" phases, solar thermal and voltaic, nuclear, heat pumps and energy storage in their "learning curve" phase, and options like tar/shale, heavy oils and coal conversion still in their "estimation" phase.





# WORLD FOSSIL RESOURCES: AVAILABILITY AND CONSTRAINTS

**M. Grenon**

*International Institute for Applied Systems Analysis, Laxenburg, Austria*

## ABSTRACT

World oil resources assessments lack, to a certain extent, scientific foundation inasmuch as the methods used and data utilized are most often not disclosed. The changing prices also call for an urgent reappraisal of world oil resources. The situation is the same, or even worse, for unconventional oil resources. These must be examined not only with regard to their potential occurrence in the ground, but also in connection with their systems interactions with other natural resources, which may constrain future availability.

## KEYWORDS

Oil; fossil; resources; unconventional oil; WELMM.

The growing awareness of the importance and irreplaceability of liquid fuels in the next four or five decades leads us to concentrate especially on these in this short review. In fact, part of our comments could also be applied to gaseous fuels and, partially, to solid fuels.

Fast increasing prices of energy, and especially of oil, in the world market since 1973 anticipate, in reality, the irreversible trend towards higher and higher energy production costs. Briefly stated, man has generally first, and sometimes at an unprecedented speed, exploited his cheapest fuels (and mineral resources) after the end of World War II. This trend is illustrated for the liquid fuels by what we have called the "three paths to costly oil".

Concerning conventional oil, the author has recently pointed out that there are, unfortunately, no reliable and scientific estimates of world energy resources (Grenon, 1979). Few of the estimates which have been published are really independent. Most of them do not disclose the method which was used, and still fewer the data which was utilized to obtain the results. A somewhat "magic" figure of  $2000 \cdot 10^9$  bbl (or about 300 billion tonnes) has attracted some "consensus", which, in fact, hardly stands up to a close examination. Moreover, among the assumptions

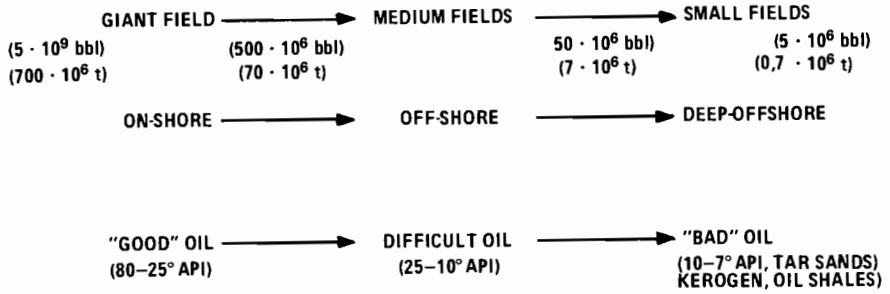

Fig. 1. The three paths to costly oil

which are possibly mentioned, prices were generally "conservative" by comparison with present standards or expectations. An interesting example is offered by the Delphi study performed by P. Desprairies for the Conservation Commission of the World Energy Conference (Xth Session, Istanbul 1977): world oil resources remaining to be produced have been estimated, using 28 carefully analyzed individual estimates, at 300 billion tonnes including deep offshore and polar areas, and at 260 billion tonnes excluding them, assuming a maximum production cost of \$20/bbl (1976 dollars) in 2000. The possible price-supply pattern is illustrated in Fig. 2.

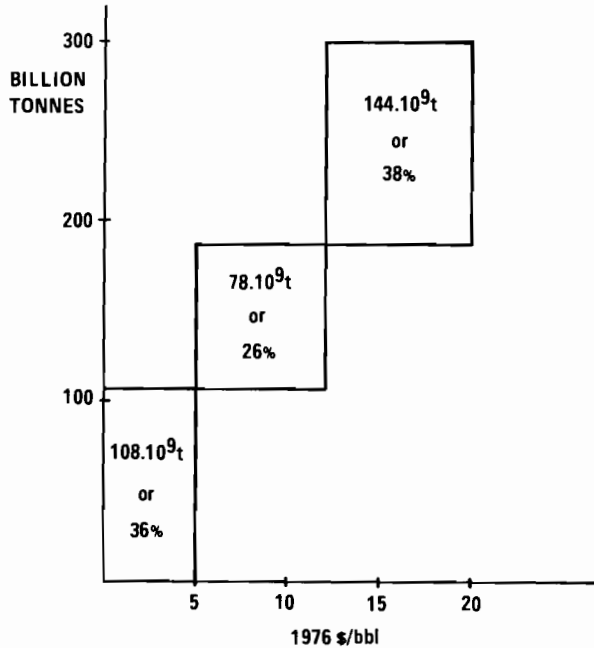

Fig. 2. World oil supply curve, according to Delphi (1977)

It is our opinion that the oil in the first rectangle (at less than \$5/barrel) corresponds to the giant and supergiant fields, most of which are in the traditional producing countries, in Fig. 1. For various reasons, it seems increasingly probable that, in spite of large remaining reserves (and probably also large remaining resources), the availability of this oil will be restricted and/or politically constrained.

We think that a good deal more oil may be expected from the intermediate area (\$5-12/bbl production cost) than previously anticipated, especially from NOPEC-LDC (non-OPEC less developed countries) which can no longer afford to import oil, however small their own requirements may be, at present and future world oil prices. This oil corresponds for us to the medium and small fields - which presumably exist in various NOPEC-LDC - and to the easy offshore. Constraints here could be the availability of materials and manpower.

The higher cost sector (\$12-20/bbl) relates to deeper and deeper offshore (or extreme weather conditions such as in the northern part of the North Sea) and/or polar regions. It is, in fact, not clear - and this uncertainty was clearly reflected in the Delphi study - what the final importance of these resources will be. After some enthusiasm a few years ago, many experts now voice their doubts and stress that only giant and even supergiant fields - assuming that there are such fields to be found! - will justify such high expenditures and risks.

Regarding unconventional oil (the last line of our Fig. 1), the high oil prices prevailing today, as well as evolving political conditions among the traditional producers, may change the picture drastically<sup>1</sup>. Unfortunately, unconventional oil resources are more poorly known still than the conventional ones, if at all possible. Most of the assessments (IIASA-UNITAR Conference, 1977) are many decades old and little or no work has really been done over the last five or six years to seriously improve our knowledge, except in a very few countries (essentially the USA, and Canada and Venezuela for tar sands and heavy crudes, all these countries owning huge deposits, which, curiously, are located on Nehring's ring of oil (Nehring, 1978).

To try to improve the above situation, IIASA has launched an up-dating survey of world unconventional oil resources (Grenon, 1979; Merzeau, 1979) by means of a survey of the literature, questionnaires sent to more than 50 countries, and direct contacts. Although our study is not yet completed, some preliminary conclusions may be drawn.

#### HEAVY CRUDES AND TAR SANDS

(Part of the up-dating information was gathered during the First International Conference on the Future of Heavy Crude and Tar Sands, held from June 4 to 12, 1979 in Edmonton, Canada and organized by the United Nations Institute for Training and Research (UNITAR) and from the ensuing discussions.)

In known areas - the ones, in fact, where knowledge has really increased further - there has generally been an increase in the estimates:

---

<sup>1</sup> The past picture may be summarized by the often quoted remark that "unconventional oil is always \$3/bbl more expensive than conventional oil, whatever the price of this latter may be...".

- Athabasca tar sands. 627 billion barrel in 1976, 869 billion barrels in 1979.
- Lloydminster heavy crudes. Range of 6 to 30 billion barrels probabilistic estimate in 1976, range of 25 to 40 (and possibly to 75) billion barrels in 1979.
- California tar sands. 270 - 323 million barrels in 1965, 966 million barrels in 1979.
- Italian heavy oil. 50 million tonnes upgraded to 350 million tonnes OOIP<sup>2</sup> in developed fields and possibly 1200 million tonnes OOIP in discovered but not yet developed fields.
- Peruvian heavy oil. Upgrading of 60 million bbl recoverable reserves to 1500 million bbl OOIP, which could, assuming a conservative recovery factor of 10%, lead to 150 million bbl recoverable, etc.

#### OIL SHALES

- France. According to Donnell (1977), 440 million bbl oil resources. After a three-year study, about 7000 million bbl have been identified.
- Morocco. According to Matveyev (Donnell, 1977) 600 million barrels in 1974, as against 1600 million bbl (and possibly 5 billion) in 1979.

It is worth mentioning that our study has also revealed some downward revisions, based on economic assessments (United Kingdom, New Zealand). Most answers to our survey indicate that presently - i.e. mid 1979 - such resources offer little or no interest. In fact, it seems that most - if not all - of the deposits are relatively smaller and of a smaller oil content than the Colorado oil shale deposits, and that no effort will probably be made elsewhere before the US really begin to exploit their huge oil shale reserves (apart, maybe, from the special case of Brazil), although present oil prices could, in our opinion, justify at least the exploration and/or initiation of such developments.

Important characteristics of these unconventional oil resources are the growing interaction, in the phase of extraction (and possibly upgrading) with other natural resources, especially water and land; the huge extent of their exploitation, involving major problems of materials handling; and their large manpower requirements. This means that, although these new energy resources are very large indeed, they appear as being possibly constrained by the availability of the other natural (or human) resources, and by the impacts on these other resources.

To better understand these constraints, as well as to bypass some difficulties of economic forecasting in a long term perspective, we have developed at IIASA a new systems approach, WELMM (standing for Water, Energy, Land, Materials and Manpower)<sup>3</sup> This approach assesses the WELMM resources requirements for various energy strategies, and analyzes the relationships (or systems aspects) between these different resources.

---

<sup>2</sup> OOIP: Oil originally in place.

<sup>3</sup> The spirit of the approach can be summarized by the formula: "Man does not consume energy, but WELMMITE...".

The development in the Athabasca Oil Sands, in Alberta, Canada, provides a good example of the requirements of a big unconventional oil program, in this case a major tar sands project. Alsands, a new project led by the Shell group, proposes to establish a \$4.9 billion oil sands mining plant near the centre of the Athabasca deposit. The 140,000 barrel-per-day capacity facility, scheduled for operation in 1986, would extract 1.25 billion barrels of bitumen over a period of 25 years. The quantity of materials handled could amount to 2.50 to 3 billion tons over the same period. The mining, upgrading and support facilities would disturb an area of almost 20,000 acres of wildland. The plant, which would use the hot-water separation process, would extract up to 1,500,000 barrels of water from the Athabasca River daily, which would amount to about 2.8% of the minimum winter flow. (Incidentally, this is a strong motivation for a major change in technology.) To produce about 1 million barrels per day, seven similar plants would be required (Grenon, Gröbler, Merzeau, 1979).

Such a plant would also involve 7000 to 8000 construction workers, which could mean a local population of 20,000 people in regions normally scarcely populated. In addition to public opposition to such a dramatic change, this population would also induce indirect WELMM requirements (drinking water, housing materials, energy facilities, etc.), the future of which would have to be planned for the time when the exploitation of the tar sands declines, etc....

The availability of water is already proving to be a bottleneck for coal or oil shale development in Colorado.

#### CONCLUSIONS

Growing constraints may limit the future availability of energy resources. Our studies point to a definite need for big improvements in technology, particularly with regard to in situ developments. so as to decrease environmental impacts on the other natural resources.

#### REFERENCES

- Grenon, M. (1979). World oil resources assessment and potential for the 21st century. Paper presented at the U.S. Geological Survey International Resources Symposium, October 14-19, Reston, Virginia, U.S.A.
- Grenon, M., A. Gröbler, and J. M. Merzeau (1979). Systems aspects of development of new liquid fuel sources. In pre-prints of the IIASA-RSI Conference on Systems of Energy and Mineral Resources, July 9-14, Laxenburg, Austria, Vol. IV. To be published commercially by Pergamon Press.
- Merzeau, J. M. Paper documenting IIASA survey. Publication forthcoming.
- Meyer, R. (Ed.) (1977) The Future Supply of Nature-Made Petroleum and Gas, International Conference sponsored by the United Nations Institute for Training and Research (UNITAR) and the International Institute for Applied Systems Analysis (IIASA), held July 5-16. 1976, Laxenburg, Austria. Pergamon Press, New York.
- Nehring, R. (1978). Giant oil fields and world oil resources. Prepared for the Central Intelligence Agency. R-2284-CIA. Rand Corporation, Santa Monica, California.



# DIVERGENCIES OF MARKET AND OPTIMUM PRICES FOR ENERGY RESOURCES

**H. Uzawa**

*Faculty of Economics, The University of Tokyo, Tokyo, Japan*

## Introduction

In this paper, I should like to discuss some of the more important factors which account for the divergence of market and optimum prices for energy resources and their implications to the allocative mechanism in a market economy. Market prices are established at those levels at which demand for and supply of scarce resources are equated at each moment of time, while optimum prices are those which result in an optimum time pattern of distribution and allocation of scarce resources, the concept of the optimum being defined in terms of an intertemporal preference ordering from a social point of view.

It is one of the main propositions in the neoclassical theory of welfare economics that market and optimum prices are identical, provided that scarce resources are all malleable, the period of production is zero, there exist neither internal nor external (dis-) economies, in the process of production, competition is perfect, and perfect foresight prevails.

In an actual economy, whether a purely capitalist economy or a mixed, none of these qualifying assumptions are fulfilled. In particular, the malleability of scarce resources, the absence of external (dis-) economies, and the perfect foresight hypothesis are hardly satisfied even in a purely hypothesised economic model.

The divergence of market and optimum allocations has particularly important implications for the situation where energy resources are mainly derived from crude oil and other non-renewable resources and are distributed unevenly among the nations or the regions. In this paper, I should like to examine in theoretical terms the circumstance under which such divergence occurs and single out the factors which account for it.

## The Optimality of Market Allocation

It is the salient feature of a market economy that, while each economic unit, either a business enterprise or a household, seeks the pattern of economic behaviour which is optimum from his own private point of view, the resulting

allocation of scarce resources is optimum from the social point of view. Indeed, it has become one of the basic propositions in the neoclassical theory of welfare economics to establish the conditions under which the optimality of market allocation prevails. However, a number of qualifying assumptions concerning the institutional premises of the market economy have to be made in order to prove the optimality of market allocation. Before I proceed with the discussion of the main theme, I should like to examine some of the more crucial conditions accountable for the identity of private and social optima.

The neoclassical theory of welfare economics has focussed its attention upon a market economy in which all the scarce resources that are limitational to economic activities are privately appropriated and transacted in the market. The assumption of private ownership, which has been regarded as a crucial element in the institutional framework of capitalism, precludes the existence of the class of scarce resources usually termed as social overhead capital. In most of contemporary capitalistic societies, even in its pure form, a significant portion of scarce means of production are not privately appropriated and are managed by the society as social overhead capital. Those scarce resources which are classified as social overhead capital are either produced collectively by the society, as is the case with highways, bridges, harbour, etc., or simply endowed within the society, as in the case of air, water, soil, etc. The optimality of market allocation crucially hinges upon the institutional premises of the private ownership of all scarce means of production. Otherwise, a complicated set of administrative and economic measures have to be introduced concerning the management of social overhead capital to ensure the optimality of market allocation (see, e.g., Uzawa [1,2]). This point has particularly importance bearings upon the present discussion where both energy production and consumption require the services to be derived from social overhead capital and at the same time have implications upon the institutional arrangements concerning the private ownership of means of production.

Next I should like to focus my attention upon the assumption of malleability of means of production which are indispensable to the neoclassical theory. It is assumed that each economic unit can change the way it is using factors of production, according to the conditions then prevailing in the market, and that neither time nor additional costs is required to change the manner by which they are used in the processes of production. This assumption of malleability, which is crucial in the neoclassical proposition, implies that the time required in production processes is zero.



The assumption of malleability of productive factors seems to have particularly important implications when we deal with the problems concerning energy resources. The nature of equipments and machineries in the productive processes and the mode of consumption are determined by the type of energy resources to be employed and it is almost impossible to change them even if they become unsuitable either due to the changes in the market conditions or in social circumstances.

The third assumption made in the neoclassical theory which is crucial in the present discussion concerns itself with the assumption of market equilibrium. Namely, it has been assumed that, at each moment of time, the price system under which demand and supply are equated for all goods and services is established in the economy. Indeed, under the assumptions of malleability and individual rational behaviour, the situation of market disequilibrium never occurs, since adjustments by individual economic units and markets are made instantaneously to reach a market equilibrium.

While the neoclassical theory has been formulated under such unrealistic assumptions concerning institutional arrangements and individual behaviour, the alternative approach which would be free from these deficiencies has been not yet developed. In the present paper, I should like to present a simple model of energy resources where some of the points raised above may be partly taken care of.

### The Model

In order to present the basic idea in the simplest manner, I should like to consider a model of two countries, one producing energy resources ("crude oil") and another producing industrial goods by using the crude oil produced by the first country. Let  $V$  be the amount of oil deposits (at time  $t$ ) in country 1 and  $Z$  be the annual rate of oil extracted in country 1 and expected to country 2. Then,

$$\dot{V} = -Z \quad (1)$$

where  $\dot{V} = dV/dt$  denotes the rate of change in the amount  $V$  of oil deposits in country 1.

The real cost  $W$  incurred by country 1 in producing crude oil by the annual rate  $Z$  depend upon the amount of oil deposits  $V$ ; namely, we have

$$W = W(Z, V) \quad (2)$$

where it may be assumed that

$$W_Z > 0, \quad W_V < 0 \quad (3)$$

$$W_{ZZ} > 0, \quad W_{VV} > 0, \quad W_{ZV} = W_{VZ} < 0 \quad (4)$$

$$\Delta W = W_{ZZ}W_{VV} - W_{ZV}^2 > 0 \quad (5)$$

Country 2 is engaged in industrial production and uses as its energy resources the crude oil imported from country 1 as well as alternative energy resources domestically produced. In order to simplify the discussion, let us assume that the amount of the domestically produced energy resources are indicated by  $K$  and the annual rate of energy resources being used up is denoted by  $X$ . Country 2 spends a certain amount of products to increase the capacity  $K$ ; let the amount

of real investment  $\Phi$  required to increase the capacity  $K$  of energy production by the annual rate  $u$  be described by the following functional relation:

$$\Phi = \Phi(u, K) \quad (6)$$

It is natural to assume that the higher the rate of increase  $u$  in the energy producing capacity the larger the amount of real investment  $\Phi$  required, and that the larger the current energy producing capacity  $K$  the more difficult it becomes to increase it further; namely, we may assume the following conditions:

$$\Phi_u > 0, \quad \Phi_K > 0 \quad (7)$$

$$\Phi_{uu} > 0, \quad \Phi_{KK} > 0, \quad \Phi_{uK} = \Phi_{Ku} > 0 \quad (8)$$

$$\Delta_{\Phi} = \Phi_{uu}\Phi_{KK} - \Phi_{uK}^2 > 0 \quad (9)$$

On the other hand, the costs (in real terms)  $C$  incurred from providing energy resources by the annual rate  $X$  depends upon the capacity  $K$ ;

$$C = C(X, K) \quad (10)$$

where it may be assumed that

$$C_X > 0, \quad C_K > 0 \quad (11)$$

$$C_{XX} < 0, \quad C_{KK} < 0, \quad C_{XK} = C_{KX} < 0 \quad (12)$$

$$\Delta_C = C_{XX}C_{KK} - C_{XK}^2 > 0 \quad (13)$$

Let  $F(X, Z)$  be the real national product function, to be dependent upon the use of domestic energy  $X$  and the imports of crude oil  $Z$ .

Let the price (in terms of industrial goods) of crude oil be denoted by  $p$ . Then the net income  $Y$  of country 2 becomes

$$Y = F(X, Z) - C(X, K) - \Phi(u, K) - pZ \quad (14)$$

On the other hand, the rate of change in the energy producing capacity  $K$  can be given by

$$\dot{K} = u - X \quad (15)$$

The optimum pattern of oil imports  $Z$ , consumption of domestic energy resources  $X$ , and investment  $\Phi$  in the domestic energy producing capacity  $K$  may now be defined as the pattern over time for which the discounted present value of the future path of net real income

$$\int_0^{\infty} Y_t e^{-\delta t} dt \quad (16)$$

where  $\delta$  is the social rate of discount, assumed to be exogenously given.

The technological constraints may be summarized as follows:

$$Y_t = F(X_t, Z_t) - C(X_t, K_t) - \Phi(u_t, K_t) - p_t Z_t \quad (17)$$

$$\dot{K}_t = u_t - X_t \quad (18)$$

with a given initial  $K_0$ .

The price  $p_t$  of crude oil changes over time, but it may be convenient to work in terms of the expected price  $p_t = p$  which would yield the same amount of the imports of crude oil  $Z_0$  and the use of the domestic energy resources  $X_0$ , at time 0, as in the case where future prices  $p_t$  may vary. The problem then may be solved by using the concept of the imputed price of domestic energy resources.

The imputed price  $\lambda$  is defined as the discounted present value of the marginal increase in the real income  $Y$  in the future due to the marginal increase in the domestic energy producing capacity. Let us denote by  $r$  the marginal decrease in the costs  $C$  due to the marginal increase in the capacity  $K$  and by  $s$  the marginal increase in real investment required for the marginal increase in the capacity  $K$ ; namely,

$$r = -C_K, \quad s = \Phi_K \quad (19)$$

Then

$$\lambda_t = \int_t^{\infty} [r_t - s_t] e^{-\delta(\tau-t)} d\tau \quad (20)$$

Differentiate (20) with respect to time  $t$  to get

$$\frac{\dot{\lambda}_t}{\lambda_t} = \delta - \frac{r_t - s_t}{\lambda_t} \quad (21)$$

On the other hand, the levels of crude imports  $Z_t$  and of the use of domestic energy resources  $X_t$  are determined so as to maximize the imputed real income

$$F(X, Z) - C(X, K) - \Phi(u, K) - pZ + \lambda(u - X) \quad (22)$$

Hence we have the following conditions:

$$F_X = C_X + \lambda \quad (23)$$

$$F_Z = p \quad (24)$$

$$\Phi_u = \lambda \quad (25)$$

Differentiating (23-25) we get

$$\begin{pmatrix} F_{XX} & -C_{XX} & F_{XZ} \\ F_{ZX} & & F_{ZZ} \end{pmatrix} \begin{pmatrix} dX \\ dZ \end{pmatrix} = \begin{pmatrix} 1 & C_{XK} & 0 \\ 0 & 0 & 1 \end{pmatrix} \begin{pmatrix} d\lambda \\ dK \\ dp \end{pmatrix} \quad (26)$$

Therefore,

$$\begin{aligned} \begin{pmatrix} dX \\ dZ \end{pmatrix} &= \frac{1}{\Delta} \begin{pmatrix} F_{ZZ} & -F_{XZ} \\ -F_{XZ} & F_{XX} - C_{XX} \end{pmatrix} \begin{pmatrix} 1 & C_{XK} & 0 \\ 0 & 0 & 1 \end{pmatrix} \begin{pmatrix} d\lambda \\ dK \\ dp \end{pmatrix} \\ &= \frac{1}{\Delta} \begin{pmatrix} F_{ZZ} & C_{XK}F_{ZZ} & -F_{XZ} \\ -F_{XZ} & -C_{XK}F_{XZ} & F_{XX} - C_{XX} \end{pmatrix} \begin{pmatrix} d\lambda \\ dK \\ dp \end{pmatrix} \end{aligned} \quad (27)$$

where

$$\Delta = (F_{XX}F_{ZZ} - F_{XZ}^2) - C_{XX}F_{ZZ} > 0 \quad (28)$$

Hence

$$\begin{pmatrix} dX \\ dZ \end{pmatrix} = \begin{pmatrix} - & + & + \\ + & - & - \end{pmatrix} \begin{pmatrix} d\lambda \\ dK \\ dp \end{pmatrix} \quad (29)$$

Furthermore,

$$dr = \left( \frac{-C_{XX} F_{ZZ}}{\Delta}, -C_{KK} - \frac{C_{KK}^2 F_{ZZ}}{\Delta}, \frac{C_{XZ} F_{XZ}}{\Delta} \right) \begin{pmatrix} d\lambda \\ dK \\ dp \end{pmatrix} \quad (30)$$

$$= (-, -, +) \begin{pmatrix} d\lambda \\ dK \\ dp \end{pmatrix}$$

$$ds = \left( \frac{\Phi_{uK}}{\Phi_{uu}}, \frac{\Phi_{uu} \Phi_{KK} - \Phi_{uK}^2}{\Phi_{uu}}, 0 \right) \begin{pmatrix} d\lambda \\ dK \\ dp \end{pmatrix} \quad (31)$$

$$= (+, +, 0) \begin{pmatrix} d\lambda \\ dK \\ dp \end{pmatrix}$$

On the other hand, differentiating (25) we get

$$du = \left( \frac{1}{\Phi_{uu}}, -\frac{\Phi_{uK}}{\Phi_{uu}} \right) \begin{pmatrix} d\lambda \\ dK \end{pmatrix} \quad (32)$$

$$= (+, -, 0) \begin{pmatrix} d\lambda \\ dK \\ dp \end{pmatrix}$$

Hence, the solution paths to the pair of differential equations (18) and (21) have the structure as described by Fig. 1.

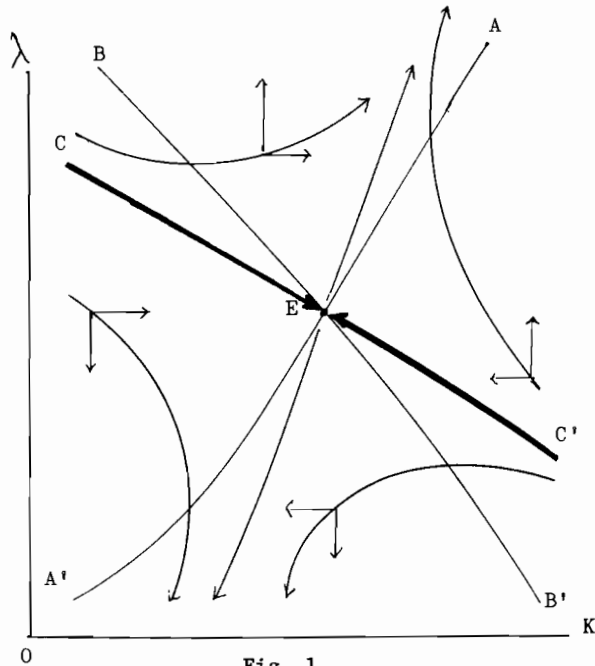

Fig. 1

The combinations of  $(K, \lambda)$  for which  $\dot{K} = 0$  are described by the  $AA'$  curve. The conditions (29) and (32) imply that the  $AA'$  curve must have an upward slope. On the other hand, the combinations of  $(K, \lambda)$  for which  $\dot{\lambda} = 0$  are depicted by the  $BB'$  curve, which, in view of (30-31), has a downward slope. The solution paths to (18) and (21) then are depicted by the arrowed curves in Fig. 1. Then there

exist a pair of solution paths CE and C'E which converge to the intersection of AA' and BB' curves. It is easily seen that the curve CC' gives the relationships between the present capacity of domestic energy resources K and the imputed price  $\lambda$  associated with it. The optimum path of energy consumption and investment in domestic energy resources is derived from the schedule of imputed prices  $\lambda$ , given by CC' curves.

An increase in the price p of crude oil results in a shift upward of both the AA' and BB' curves, implying an increase in the imputed price  $\lambda$  of the domestic energy resources. It will result in a decrease in the imports of crude oil and an increase in the investment in the domestic energy capacity.

Similar analysis may be developed for the optimum planning for the oil producing country. The net income of country 1 is given by

$$pZ - W(Z, V) \quad (33)$$

and oil deposits V of country 1 depreciates by the annaul rate Z:

$$\dot{V} = -Z \quad (34)$$

Country 1 then tries to maximize the discounted present value of future net real incomes:

$$\int_0^{\infty} [p_t Z_t - W(Z_t, V_t)] e^{-\rho t} dt \quad (35)$$

where  $\rho$  is the social rate of discount for country 1, assumed to be exogenously given. The optimum problem may be again in terms of the concept of the imputed price  $\mu$  of oil deposits V. It is defined by the following

$$\mu_t = \int_t^{\infty} (-W_V)_\tau e^{-\rho(\tau-t)} dt \quad (36)$$

Hence, we have

$$\frac{\dot{\mu}_t}{\mu_t} = \rho - \frac{(-W_V)_t}{\mu_t} \quad (37)$$

On the other hand, the rate of change in oil deposits V is given by

$$\dot{V} = -Z \quad (38)$$

and the optimum rate of the exports of the crude oil by country 1 is determined so as to maximize the imputed national income (39)

$$pZ - W(Z, V) - \mu Z \quad (39)$$

Hence,

$$\left(1 - \frac{1}{\eta}\right)p = W_Z + \mu \quad (40)$$

where  $\eta$  is the price elasticity for the imports of crude oil by country 2. Differentiating (40) yields

$$dZ = \left(-\frac{1}{A}, -\frac{W_{ZV}}{A}\right) \begin{pmatrix} du \\ dV \end{pmatrix} \quad (41)$$

where

$$A = \left(1 - \frac{1}{\eta}\right) \frac{P}{\eta_Z} + W_{ZZ} \quad (42)$$

Furthermore

$$d(-W_Z) = \left(\frac{W_{ZZ}^2}{A}, -W_{ZV} + \frac{W_{ZV}}{A}\right) \begin{pmatrix} du \\ dV \end{pmatrix} = (+, +) \begin{pmatrix} du \\ dV \end{pmatrix} \quad (43)$$

Hence the phase diagram of the pair of differential equations, (34) and (38), has the shape as depicted in Fig. 2, and the solution paths are described by the arrowed curves. Then the optimum path of extraction of oil deposits is obtained by the stable path  $CC'$ , as was the case for country 2.

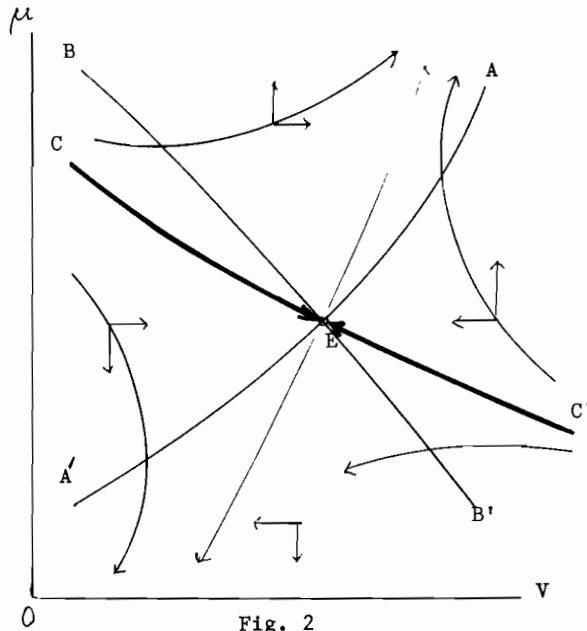

Fig. 2

It is possible to derive a number of propositions from the analysis outlined above concerning the optimum path of consumption of crude oil and investment in alternative energy resources. In particular, we can show the proposition that there exists a divergence between optimum allocation and market equilibrium. In order to obtain an optimum path of the imports of crude oil  $Z$  and investment in domestic energy resources  $I$ , it becomes necessary to use the expected price  $p$  which is an average over time of the imputed prices of crude oil to be calculated in terms of country's intertemporal preference ordering. However, in the market situation, each economic unit is compelled to use the current price level  $p_0$  in order to maximize his profit or utility, even though he is aware of the fact that future prices have to be taken into consideration if a social optimum is to be obtained. Thus a market equilibrium would be attained where each economic unit uses a price level which is lower than the optimum imputed price, resulting in an excess import of crude oil from country 1 and at the same time in an under-investment in domestic energy resources.

This proposition particularly implies that country 2 has to impose a surtax for the imports of the crude oil so that the divergence between market prices optimum prices would disappear, even though such a policy would certainly imply the increase the energy prices for both producers and consumers for country 2, while the rate of extraction of crude oil in country 1 would be decreased.

#### REFERENCES

- [1] Uzawa, H. (1974). La théorie économique du capital collectif social. Cahier d'Économétrie et Économique Mathématique, 101-122.
- [2] Uzawa, H. (1975). Optimum investment in social overhead capital. In Edwin S. Mills (Ed.), Economic Analysis of Environmental Problems, pp. 9-26.

# LONG-RANGE PRICING OF CRUDE OIL

**R. J. Deam**

*Energy Research Unit, Queen Mary College, UK*

## Introduction

In the world oil market the price of one crude oil is related to the prices of all others. There is a complex logic which defines the relationship between the prices of different crudes and between the overall price of crude oil and other energy sources. The fundamental nature of the world energy system is determined by its having, at equilibrium, only one degree of freedom - it is unidimensional in price (see reference). With one price fixed (the price of the 'marker' fuel) all others are determined through the various complex mechanisms that link different energy sources.

At present this marker fuel is Saudi Arabian light crude oil. In the 1950's it was Iran's Agha Jara; in the 1960's it was Kuwait's crude. Far into the future it will not be crude but an alternative energy source.

The amount of any energy source being produced will depend upon its price. A rise in the price of the marker crude would stimulate demand for alternatives and liftings of crude oil would be reduced. At an extremely high price, production of alternative energy, say synthetic crude oil from coal, would be stimulated to such an extent as to replace completely imports of crude oil into a particular country. On the other hand, if the price of the marker crude is set very low, say near cost, there will be no economic incentive to produce any alternative form of energy. In this case liftings of oil will be maximised, but revenue will be minimal.

Between these two extremes, there is an optimum price which will result in maximum revenue (net of cost) accruing to the producer. WEML's long-range World Energy Model will determine this optimum price. The logical reasoning behind the Model can be understood by considering the mechanics of inter-fuel substitution in a highly simplified case.

## Inter-fuel substitution

Why do consumers choose, for example, oil rather than coal; or substitute natural gas instead of oil? What factors control the choice and what would cause them to change?

Let us assume a closed, isolated energy system (i.e. one with no imports or exports) with only two energy sources:

- crude oil, and
- coal

Reserves of both are adequate to meet demand, but the crude is the cheaper to produce. In this closed system there is a demand for secondary energy:

- 20 tons of motor gasoline
- 30 tons of kerosene
- 50 tons of heavy fuel oil

All the heavy fuel oil is burnt to generate electricity. Only three processing routes are available (figure 1) to achieve this mix: one using oil only; one part oil and part coal; and the third all coal.

Within this system the government encourages the energy industries to choose the processing route which minimises the total energy bill. The producer of crude can determine which route the energy industries will select by his pricing policy, as we shall see.

Considering Alternatives I and II, the consumer will choose whichever is the lower bill of

$$110 \times \text{Price of crude} + \$110$$

$$\text{and } 70 \times \text{Price of crude} + 70 \times \text{Price of Coal} + \$900$$

If both bills were the same, the consumer would be indifferent as to choice of alternative routes. In this case:

$$110 \times \text{Price of crude} + \$110 = 70 \times \text{Price of crude} + 70 \times \text{Price of coal} + \$900$$

$$\text{Price of crude} = 1.75 \times \text{Price of coal} + \$19.75$$

The coal producer cannot lower his price below cost, so to ensure that the consumers follow Alternative I, the crude producer would set his price just below Price A

$$\text{where Price A} = 1.75 \times \underline{\text{Cost}} \text{ of coal} + \$19.75$$

If the crude producer wished Alternative II to be chosen, he would put his price above Price A. The question is: how much above? If he sets the price too high, Alternative III will be chosen and he will have no crude production. Alternative II will be preferred to Alternative III, when the consumer's bill for II is just below III:

$$70 \times \text{Price of crude} + 70 \times \text{Price of coal} + \$900$$

$$< 320 \times \text{Price of coal} + \$6450$$

$$\text{or price of crude} < 3.5 \text{ Price of coal} + \$79.30$$

Since the crude producer wishes to ensure that Alternative II is followed he would set his price just below the cost of coal, stifling competition from coal:

$$\text{Price of crude must be slightly less than}$$

$$\text{Price B} = 3.5 \times \underline{\text{Cost}} \text{ of coal} + \$79.30$$

The crude producer therefore has two alternative pricing policies:

Price A: to price crude at  $1.75 \times \text{cost of coal} + \$19.75$ ,  
in which case he sells 110 tons of crude

Price B: to price crude at  $3.5 \times \text{cost of coal} + \$79.30$ ,  
in which case he sells 70 tons of crude.

Being a rational person, he will select that pricing policy which maximises his net revenue, i.e. the larger of:

$$110 (1.75 \text{ Cost of coal} + \$19.75 - \text{cost of crude})$$

$$\text{or } 70 (3.5 \text{ Cost of coal} + \$79.30 - \text{cost of crude})$$



This situation can be shown graphically as in Figure 2, where the price of crude is plotted (horizontally) against the volume of crude lifted (vertically).

For any price up to  $P_A$ , 110 tons of crude are produced. Obviously, the maximum revenue occurs when the price is at its limit (1.75 cost of coal + \$19.75). At any price between  $P_A$  and  $P_B$ , 70 tons of crude are produced. The maximum revenue occurs when the price is set at the upper limit. The production of an alternative energy source is triggered at its substitution price.

This simple closed system illustrates the principles and the logic of the argument. The real world is, of course, much more complex because:

- there are numerous alternative energy sources
- extraction costs vary from place to place
- relative geographical locations of the source and the consumer have to be considered
- there are many proven conversion processes
- there are many crude oil sources
- environmental laws apply
- political considerations overlay the techno-economic factors.

All these parameters have to be considered in analysing the real world. And our highly simplified illustration has shown the importance of refinery costs in the determination of  $P_A$  and  $P_B$ .

The real-world system is so highly interactive that only by using the World Energy Model can meaningful answers be obtained.

The results from the model can be represented graphically as shown in Figure 3, plotting price against volume of crude lifted.

At a price  $P_1$ , it is just profitable for the cheapest alternative to be produced in volume equivalent to  $(V_1 - V_2)$ . At  $P_2$ , the second cheapest alternative is produced in volume equivalent to  $(V_2 - V_3)$  and so on. The Model's solutions give full details of these alternatives at each discontinuity.

Having the price elasticity 'curve' for the marker crude, we know the revenue at each discontinuity, e.g.  $P_1V_1$ ,  $P_2V_2$ ,  $P_3V_3$  and so on. These can be plotted against the price of crude ( $P_1$ ,  $P_2$ ,  $P_3$ , etc), the highest peak occurring when the price maximises revenue to the producer as shown in Figure 4. (In practice, net revenue is plotted.)

It is fortunate that this price maximises the net revenue to the producer and minimises the total fuel bill to the consumer in the long run. If crude oil is in short supply it should get its substitution value (see later).

To summarise, the marginal energy source at any time (currently the crude oil, Saudi Arabian Light) has an upper and a lower price limit. The lower price corresponds to its cost (currently estimated at about 10.15 £ per barrel for Saudi Arabian Light). Should the price fall below its cost, no oil would be lifted. Should the price rise above that of an alternative marginal source (syncrude, tar sands or whatever) then in due course, when sufficient of the alternative is being made, the production of the original marginal source would cease. Thus the realistic long-term price of light Arabian crude lies between these two very wide limits. The energy analyst's problem is to decide what will be the next marginal source of energy. One price in the energy system - that of the marginal source - determines all other prices.

Natural gas

Natural gas is a strong candidate to be the next marginal energy source in the medium term, bridging the gap until other forms of energy can be developed. Its attractions are twofold:

1. It is available in substantial quantities in many geographical regions (see Table 1).
2. It can be transported through pipelines, or as Liquefied Natural Gas, or it can be converted into 'methyl fuel' through catalytic reaction with steam. Methyl fuel is an approximately 2/3 to 1/3 mixture of methanol (methyl alcohol, CH<sub>3</sub>OH) and higher alcohols, particularly iso-butanol.

Reserves of natural gas have not been so rigorously proved as reserves of Middle East crude oil. However, present proven exportable reserves of gas are equivalent to two thirds of Middle East crude oil reserves and they are widespread.

The relationship between the price of crude oil and natural gas is quite complex. One possible relationship in the international market is via substitution of No 2 furnace fuel oil by 'methyl fuel' as a burning fuel provided they are at the same BTU equivalent price.

This relationship can be shown simply in the calculation in Table 2, which is based on the assumptions:

1. 1 ton of furnace fuel oil made by cracking requires 1.2 tons of crude.
2. The cost of catalytic cracking (conversion in the refinery) of \$15.00 per ton, used in the calculation, is a historical European average for 1967-71. The actual figure would depend on the extent of cracking required.
3. 'Methyl fuel' has 60% of the calorific value of furnace fuel.
4. Natural gas is generally closer to the market than crude, and one third the distance has been assumed.
5. The capital cost of 'methyl spirit' plant depends on location. The figure in 1973 dollars of \$67 per ton per annum, obtained privately from several contractors, leads to a manufacturing cost made up as follows:

	<u>\$/ton product</u>
Capital charges (15% over life)	12.06
Maintenance	2.68
Operating costs	4.10
	<hr/>
	18.84

6. 1 therm of methyl spirit requires 1.75 therms of natural gas.

The relationship:

$$\text{Well-head value of gas} = 1.18P_C - 1.38$$

where  $P_C$  is the price of crude

shows how the prices of gas and oil are necessarily connected. If Gulf crude is the marginal source, its price will determine that of gas. If some other process (e.g. LNG, Fischer Tropsch production of a naphtha-like artificial gasoline) were cheaper than methyl spirit manufacture, gas would have a higher value. Alternatively, if gas were the marginal source, its price would determine that of crude oil - this price would be the upper price limit on crude. The World Energy Model can be used to discover under what conditions this might be expected to occur and which gas source could become the marginal supply.

The case for blending methyl fuel with motor spirit

There is now a considerable body of practical evidence to support the addition up to 30% methyl fuel to motor spirit. Although pure methanol does not blend

with hydrocarbons, methyl fuel does. It has a high octane rating and is volatile. In traditional gasoline blends the straight-run front end components, which are good petrochemical feedstock have low octane ratings and require the addition of lead to raise the octane number to acceptable levels. A methyl fuel/hydrocarbon blend does not require lead, and this should reduce the necessity for constructing further octane-improving and cracking plants.

Methyl fuel gives more miles BTU than pure hydrocarbon mixtures. Extensive bench tests with a British Leyland Marina engine show that a 15% blend of methyl fuel, whilst improving power, gives about the need for adjustment of the engine. Even a 30% mixture, after optimum setting of carburettor and ignition tuning, reduces miles/gallon by only 8%. In the event that constraints are placed on the addition of methyl fuel to motor spirit, methyl fuel could be substituted for furnace fuel oil, again giving gas a higher value.

#### Methyl fuel vs LNG

There are, in the literature, many calculations of the relative merits of LNG and methyl fuel as means of transporting large volumes of natural gas over large distances. But they suffer from one or more of the following defects:

1. It is assumed that the price of gas is a necessary input to the calculation, and since this price can only be guessed at, the comparison is necessarily imprecise.
2. The possibility is ignored that the optimal supply routes for LNG and methyl fuel might be very different.
3. The comparisons are carried out on a calorific value basis.

The price of LNG or methyl fuel is fixed - at equilibrium - by the price of the oil products for which they are substituting (the energy system is unidimensional in price); the price of gas is that price less the prices charged for conversion and transport.

With regard to supply patterns, either the LNG or the methyl fuel route might be favoured in particular circumstances. For example, methyl fuel manufactured in Algeria might be absorbed in Europe and the oil products which it displaces exported to the USA, thus saving on shipping costs per BTU. Such a route might not be available for LNG in view of the indigenous gas production in Europe and the possibilities of importing pipeline gas from the USSR. WEML's model, with its representations of alternative supply possibilities and local demand patterns, permits us to analyse these complex interactions.

#### The WEML Model

The Model is a complex representation of the international oil and gas industry, based on linear programming to determine the least-cost strategy to meet a specified world demand, a technique used widely in the petroleum industry (see "Understanding Energy: a rational approach to Energy Planning" for a fuller description).

Refining and marketing are represented as taking place in 22 locations throughout the world, crude oil production at 25 (more than 50 crudes are taken into account) and natural gas production at 19 locations. Oil and liquefied-natural-gas transport is included using eight categories of ships and about 30 major pipelines are considered.

Natural gas from the 19 locations is considered to be transported by one of the following routes:

- by pipeline to meet local gas demand and to exports
- by exporting as LNG, which is regasified to meet a distant gas demand
- by conversion to methyl fuel, which may either be used locally or exported for use as a component of motor spirit, or as a substitute for middle distillates and fuel oils.

The operating costs of these facilities and the investment costs pertaining to their expansion are supplied as input data to the model.

Using the reserves figures in Table 1, a reserves/production ratio of 25:1 was assumed. A price was chosen for light Arabian which was high enough to cause its production rate to fall to zero - an exaggerated and unrealistic case which could then be moved away from or towards a meaningful value.

With a stated future demand for petroleum, the model will determine the theoretical programme (in capacity and capital expenditure) for refinery construction worldwide, giving details of the type, size and location of plant, the optimal crude supply pattern and the necessary tanker construction by size category, to meet this demand.

With a specified price for light Arabian crude - the current marker crude - equilibrium prices for all other crudes and products and for natural gas at each location are determined. The model system also determines the cost of harbour and pipeline constraints and the equilibrium spot charter rate of vessels by class category. The results from running this model are given in Tables 3 and 6. This shows a time in the future when demand has increased and when oil refinery plant and tankers would need to be built if the methanol route were not used. With the high price chosen for light Arabian, its production falls to zero. Refinery capacity unused leaps to 35-40%: none is built. LNG is made in competition with methyl fuel up to the existing capacity of LNG tankers: no further tankers are constructed. Oil tanker construction is non-existent in this case and some 19 m dwt of 25,000 ton vessels are left idle - stemming from the relative closeness of methyl fuel to the market. Some 640 mta of methyl fuel is made in eight different locations, 470 mta being used as burning fuels. All motor spirit worldwide is at maximum methyl fuel content.

Although this is not a realistic solution, since a cutback in OPEC production would never be allowed to fall entirely on one member, it gives us the starting point from which we can move towards the optimum price of light Arabian crude.

By reducing the price of this crude in stages, and running the model, natural gas liftings are found to decrease and crude liftings increase. The revenue to the crude producer, volume lifted multiplied by price, follows a saw-tooth curve passing through a global maximum (see Figures 5 and 6). At this point, the producer's revenue is maximised and the consumer's total cost minimised. If the producer sets his price too low, the alternative sources will not be developed. The industry will build too much conventional refining and shipping facilities. Since alternatives take time to build and commission, there is a period in which the producer has no competitive alternative sources available in significant volumes, and therefore no upper limit to his price. As he capitalises on this situation, the consumer's bill increases and previously uneconomic alternatives are developed, and slack appears in crude refining and shipping capacities reflecting previous over-building.

This single demonstration gives the flavour of the technique and the logic behind it. To give a definitive price, further runs are required to cover a range of scenarios including variations in:

- possible OPEC prorationing schemes
- gas production rates and potential discoveries
- gas processing costs (LNG and methyl spirit plants, pipelines)
- demand assumptions

- for the longer term other forms of energy (coal, shale oil, nuclear etc.) have to be included
- discounting over time (the current model is static).

### Conclusions

It is in the best long-term interest of both the producer and the consumer of oil that an economic price be established for crude oil. The producer should wish to avoid risking lower future revenues which would result from competition from substitution by other energy sources which would become relatively economic at higher prices. The consumer will wish to avoid being forced into uneconomic capital expenditure connected with these energy substitutions. WEML's model can help in the analysis of possible future consequences of today's political decisions.

It is possible that in the future a monopoly of gas producers (OGEC?) could replace the existing monopoly of crude oil producers. But this situation could only arise when energy demand has increased to the point where the crude producer's maximum revenue corresponds to the physical limits of production of the marginal source. The price of gas would then be subject to lower and upper limits - the cost of production and the cost of the next alternative energy source - in the same way as crude is now. The next alternative might then be coal, tar sands, shale oil, nuclear power, or some as yet undiscovered form of energy.

This thesis is developed fully in "Understanding Energy - a rational basis for planning alternative strategies" (available on request from World Energy Models Limited, 41-47 Bow Road, London E3 2AD).

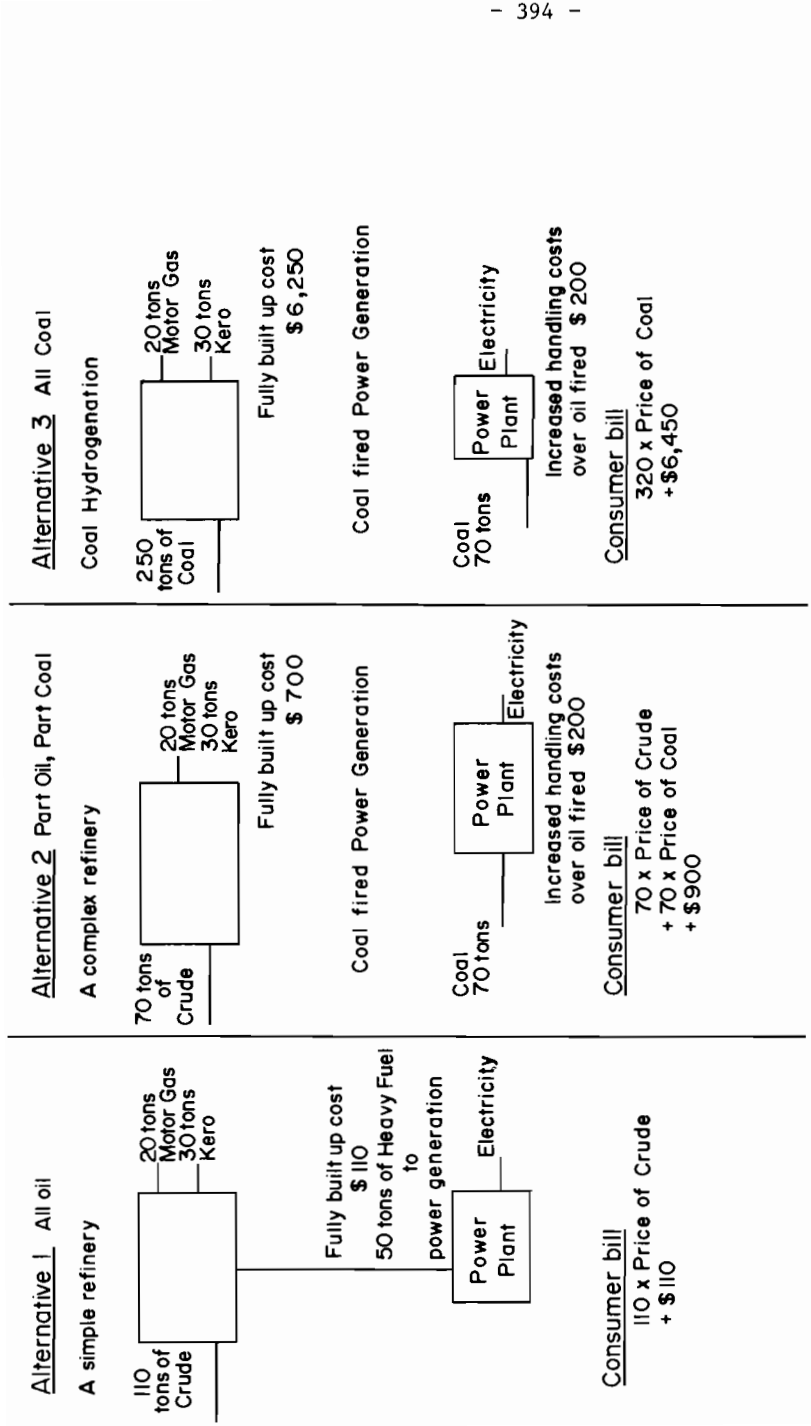

Fig 1. Possible Processing Routes

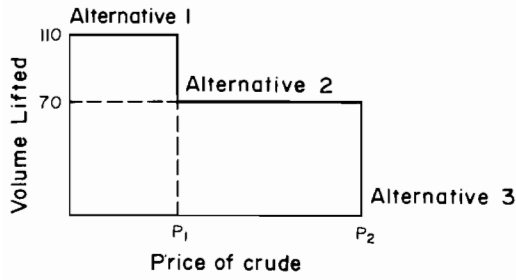

Fig. 2.

Price elasticity of the marker crude

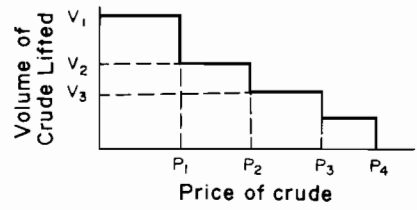

Fig. 3.

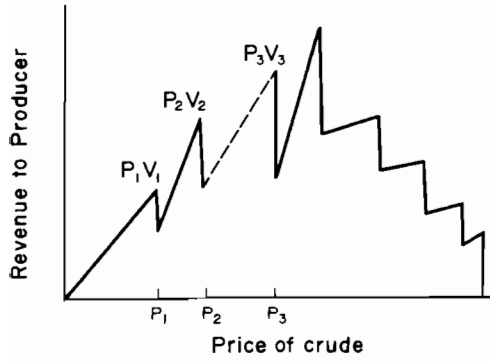

Fig. 4.

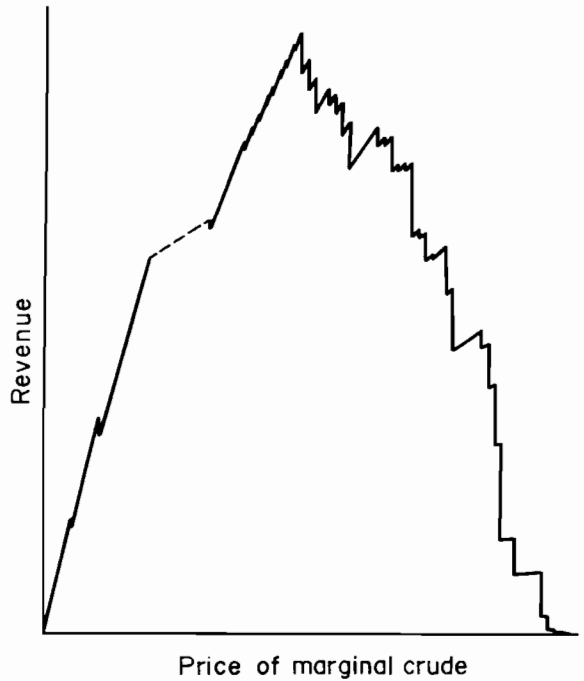

Fig. 5.

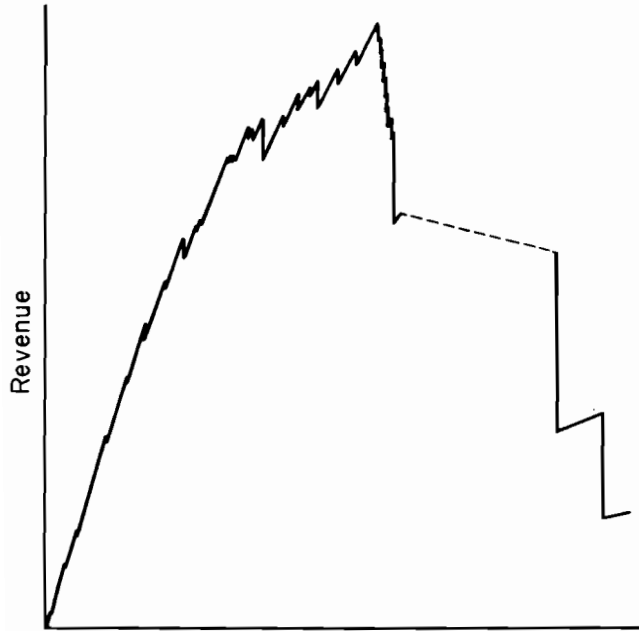

Fig. 6. Quantity of marginal crude



Table 1 World ownership potential gas export sources

Export "favourable" areas	Proven resources Jan 1 1975 10 <sup>12</sup> cu.ft.
USSR	812
Canada	52 (including Arctic)
Algeria	229
Nigeria	45
Iran	330
Abu Dhabi	200
Indonesia	15
	-----
	1683
Export "unfavourable" areas	
Libya	27
Venezuela	43
Middle East (ex. Iran and Abu Dhabi)	143
	-----
	213
Other areas	
Australia	38
Latin America (excl. Venezuela)	36
Pakistan	16
	-----
	90
	-----
	1986
	-----

Source "Petroleum International" Jan. 1974 p.22-4 updated using "Oil and Gas Journal" 30.12.74.

At 500 cf of natural gas equivalent to 1 bbl of crude oil, the potential gas export reserves amount to some  $400 \times 10^9$  bbl of crude equivalent, which is to be compared with the proven Middle East reserves of  $403 \times 10^9$  bbls (BP Statistical review of the World Oil Industry, 1974, p.4).

Table 2

Let  $P_C$  be the price fob in \$/bbl of the marginal crude

	<u>\$/bbl</u>	<u>\$/ton</u>	<u>£/therm</u>
Crude (fob Persian Gulf) per unit of furnace fuel oil	1.2 $P_C$	8.88 $P_C$	
Freight to US East Coast per unit of furnace fuel oil	1.62	12.00	
Built-up cost of cracking per unit of furnace fuel oil	<u>2.03</u>	<u>15.00</u>	
Value of furnace fuel oil	$1.2P_C + 3.65$	$8.88P_C + 27.00$	$2.07P_C + 6.28$
<hr/>			
Hence value of methyl fuel at US East Coast		$5.28P_C + 16.1$	$2.07P_C + 6.28$
(Less) Freight per unit of methyl fuel		(3.33)	
(Less) Manufacturing cost per unit of methyl fuel		(18.84)	
Netback per unit of methyl fuel		$5.28P_C - 6.16$	$2.07P_C - 2.42$
(Less) Fuel and loss			$0.89P_C - 1.04$
Well-head value of gas			<hr/> $1.18P_C - 1.38$ <hr/>

Table 3 Methyl Spirit Production

	Solution A*			Solution B*		
	Quantity (10 <sup>6</sup> tonnes)	Disposal	Investment (10 <sup>6</sup> \$)	Quantity (10 <sup>6</sup> tonnes)	Disposal	Investment (10 <sup>6</sup> \$)
Australia	35.2	18.8 local 16.4 Japan	2358	3.1	All local	208
North Africa	115.1	25.6 local 89.5 France, UK, Spain, Italy, US	7712	64.4	2.5 local 61.9 UK, France Spain, Italy US, Benelux	4315
Caribbean	50.9	8.3 local 42.5 US	3410	58.3	8.9 local 49.4 to US	3906
Persian Gulf	243.4	167.0 local + E. Africa	16308	4.4	All local	295
E. Siberia	8.7	76.4 Japan, S. Africa	583	NIL	-	NIL
Alaska	35.0	All to Japan 22.4 to US	2345	22.1	14.6 to US 7.4 Canada	1481
Nigeria	42.6	12.5 Canada 16.6 local	2854	1.9	0.5 local 1.5 S. Africa	127
Pakistan†	108.8	25.9 US, Scand. 59.4 local 49.6 SE Asia	7290	15.9	3.9 local 11.9 SE Asia	1065
W. Siberia	NIL	-	NIL	2.3	Scandinavia	154
Total	639.7		48369	172.4		11551

\*In this and subsequent tables the solutions referred to are:

A - Price of light Arabian set high enough to shut in production (Section 4).

B - The minimax solution (Section 5).

†An error in the model gave a gas availability of  $133 \times 10^9 \text{ m}^3$  instead of  $33 \times 10^9 \text{ m}^3$ . The minimax solution B in fact used only  $27 \times 10^9 \text{ m}^3$ .

Table 4 Overall Disposal of Methyl Spirit

	Solution A		Solution B	
	(10 <sup>6</sup> tonnes)	(%)	(10 <sup>6</sup> tonnes)	(%)
To motor spirit	169.7	26.5	169.3	98.3
burning kerosine	75.1	10.2	2.9	1.7
substitution				
gas oil substitution	108.2	16.9	NIL	NIL
LSFO substitution	98.3	15.4	NIL	NIL
HSFO substitution	198.1	31.0	NIL	NIL
Total	639.4	100.0	172.2	100.0

Table 5 Refinery Plant Utilisation-Existing and Planned Capacity Left Idle

Process	Solution A		Solution B	
	(10 <sup>6</sup> tonnes/year)	(% total)	(10 <sup>6</sup> tonnes/year)	(% total)
Alkylation	22.8	81	28.9	100
Catalytic cracking	72.8	21	203.4	59
Crude distillation	896.3	36	432.2	17
Hydrofining	143.2	65	82.3	37
Catalytic reforming	96.2	33	37.8	13
Residue desulphurisation	20.0	100	3.1	15
Vacuum distillation	343.5	57	410.6	68
Hydrocracking	27.9	52	34.2	64

Table 6 Total Capital Investment

	Solution A	Solution B
Pipelines	47.2	33.4
Shipping	NIL	NIL
LNG plant	2.5	0.4
Methyl spirit plant	42.9	11.6
Refining plant	0.0	0.2
Total	92.6	45.6

# APPLICATION OF GENERALIZED TRANSHIPMENT AND INTEGER PROGRAMMING ALGORITHMS IN REGIONAL ENERGY PLANNING MODELS

**J. Debanné**

*Faculty of Administration, University of Ottawa, Canada*

## ABSTRACT

Regional energy policy and planning models can be efficiently represented and solved using two constructs: a generalized network to represent and simultaneously solve for supply, distribution, transformation and demand of energy in every region and time period considered in the planning study; and a binary integer program to represent and solve for all discrete variables relevant to the planning study, such as investment and technology options, subject to investment sequencing constraints as well as other constraints that cannot be represented in a generalized network construct. The global optimization algorithm alternately generates investment and technological option plans with the binary program; then evaluates these plans with the generalized network optimization algorithm. This network optimization produces a total discounted cost for the plan as well as activity levels and opportunity costs. These activity levels, opportunity costs as well as the total plan cost are in turn used to set up the integer program in order to produce an improved investment plan, and so on... until no further reduction in the total discovered cost can be achieved.

## KEYWORDS

Mathematical Programming, Integer Programming, Generalized Networks, Generalized Trans-shipment, Decomposition Algorithm, Energy Modelling, Regional Modelling, Multi-Period Models. Energy Planning, Binary integer programming, zero-one programming.

## INTRODUCTION

Network flow models to solve single period, regional energy supply-distribution problems for oil (Debanné 1969, 1971), natural gas (Brooks, 1976), oil and natural gas (Debanné, 1975), oil, natural gas and coal (Debanné, 1977), oil, natural gas, coal, syncrude, nuclear and renewable power (Debanné 1979, 1980) use either standard transshipment network optimization algorithms or generalized network algorithms. Multi-period aspects of the problem at hand, such as expansion of facilities or the choice of technological options are solved for "myopically" in all above models, using the minimum cost criterion at the period or time step when a particular investment or option becomes economical to introduce, without regard for conditions prevailing in subsequent time steps. A demonstration pilot energy model featuring optimization over a multi-period planning horizon was developed (Debanné, 1976) in which integer variables are solved for by a specially designed "generalized" network flow optimization algorithm. This technique proved to be inefficient for large problems and

proved to be too restrictive in terms of integer programming formulation.

Progress in the field of decomposition techniques, (Benders, 1962), has led to the development of single period optimization models (Geoffrion 1974, 1979) in which that part of the problem featuring the 0-1 variables, i.e. the investment options and corresponding fixed charges, are solved by an integer programming code, while the trans-shipment part of the problem is solved for with a standard network optimization code. One of the most successful applications of this decomposition scheme is a management support system currently on stream at General Foods Inc. and other enterprises. (Geoffrion, 1979) The efficiency of the solution algorithm combined with a well designed supporting data base, report generator and problem formulation package has considerably enhanced the utility of this application as a planning and decision aid for production and distribution managers of multi-product, multi-plant, multi-customer operations such as General Foods. This particular application of Benders' decomposition algorithm (1962) disconnects the trans-shipment portion of the problem into as many subnetworks as there are commodities to store (or manufacture) in the various warehouses (or plants) and allocates these commodities to the various consumption centers. Expansion and investment options are solved for with a binary integer program for the period of interest. This application imposes however a "single sourcing constraint", whereby a consumption center is supplied with all products consumed at this center, from one and only one warehouse or plant. Adaptation of Geoffrion's management support system to regional energy planning models could not however be implemented despite the strong similarities between a food products supply-distribution operation and an energy supply-distribution system. The main difficulty is the single sourcing constraint which is the cornerstone of Geoffrion's decomposition algorithm and which definitely does not apply in energy supply-distribution systems. For example, oil imported to the United States or Eastern Canada originates from a variety of overseas supply sources. Moreover, other energy commodities such as natural gas or hydro power originate wherever natural gas fields and hydro sites happen to be located... In other words all energy sources are not available like all food products at every production or warehousing facility.

Another peculiarity of regional energy supply distribution systems is the long term implications of certain decisions such as the building of a tar sand plant, the expansion or building of a pipeline or of a hydro power generation facility. Accordingly, a "look ahead" capability would considerably enhance the value of a regional energy planning model.

Moreover, energy supply distribution systems featuring electric power generation and distribution and/or energy transformation processes incurring energy losses cannot adequately be represented in standard networks, i.e. networks in which flow is conserved around all nodes, hence that preclude losses proportional to throughput or flow. This aspect of total energy supply-distribution systems has two implications: Firstly, a generalized network optimization algorithm must be used for the "evaluation" phase of the procedure instead of a standard network flow optimization algorithm; and secondly it becomes highly cumbersome and impractical to disconnect the multi-commodity network into single commodity sub-networks.

In summary, in order to adequately represent and solve for optimal energy supply-distribution-demand plans over a multi-period planning horizon, it is necessary to combine the binary integer program that generates investment plans, with a generalized network flow optimization algorithm that evaluates these investment plans. Moreover the decomposition scheme to solve the global optimization problem must not feature the single sourcing constraint imposed in Geoffrion's management support system and cannot easily be decomposed into single commodity sub-networks.

The model described in this paper answers all above requirements using a novel decomposition algorithm which follows in broad terms the familiar alternating sequence of investment plan generations and investment plan evaluations initially proposed by Benders (1962), and adapted by Geoffrion (1974), and Debanné, Beaubien and Roohy Laleh (1980) for particular industrial supply-distribution systems. However, the substitution of a generalized network to the standard network flow algorithm and the lifting of the single sourcing constraint precluded the adoption of computational strategies comparable to those featured in Geoffrion's management support system (1979) or even Debanné et al's algorithm (1980) for multi-period supply-distribution systems where the single sourcing constraint is lifted. This is due to the impossibility of devising (as yet) efficient commodity demand constraints to guide the binary integer program, if losses (or gains) in commodity flow occur between the sources or production nodes of the network and the sinks or consumption nodes.

CONSTRAINT MATRIX

The constraint matrix of the binary integer program is outlined in Fig. 1 for the multi-period total energy supply-distribution system:

zero-one investment variables	<div style="display: flex; justify-content: space-around;"> <div style="text-align: center;"> <p>Period 1</p> <math>y_{1,1} \ y_{2,1} \ \dots \ y_{n,1}</math> </div> <div style="text-align: center;"> <p>Period 2</p> <math>y_{2,1} \ y_{2,2} \ \dots \ y_{n,2}</math> </div> <div style="text-align: center;"> <p>Period 3</p> <math>y_{n,T}</math> </div> </div>	
Cost Coefficient	$P_{1,1} \ P_{2,1} \ \dots \ P_{n,1} \ P_{2,2} \ \dots \ P_{n,2}$	$P_{n,T}$
	<div style="display: flex; justify-content: space-between;"> <div style="width: 30%;"> <p>Period 1 constraints</p> </div> <div style="width: 30%;"> <p>Period 2 constraints</p> </div> <div style="width: 30%;"> <p>Period 3 constraints</p> </div> </div>	Right Hand Side
	Inter-period constraints, e.g. investment precedence constraints	
Budget constraint	$f_{1,1} \ f_{2,1} \ \dots \ f_{n,1} \ f_{2,1} \ f_{2,2} \ \dots \ f_{n,2}$	$f_{n,T} \ I$

Fig. 1 Staircase Constraint Matrix for Binary Integer Program.

Given a profit contribution vector  $[P_{k,t}] = [P_{1,1}, P_{2,1}, \dots, P_{n,1}, P_{2,1}, P_{2,2}, \dots, P_{n,2}, \dots, P_{n,T}]$  where each profit or cost reduction coefficient  $P_{k,t}$ ;  $k = 1, 2, \dots, n$ ;  $t = 1, 2, \dots, T$  is associated with a binary variable  $y_{k,t}$  representing the  $k$ 'th investment option at period  $t$  and given investments  $f_{k,t}$  corresponding to binary variables  $y_{k,t}$  the staircase constraint matrix outlined in Fig. 1 representing the form of the information supplied to the binary integer program. This program produces an investment plan, i.e. a vector  $[y_{k,t}]$ ;  $k = 1, 2, \dots, n$ ;  $t = 1, 2, \dots, T$  of zero

or one variable which are in turn used to set up a generalized network flow representation of the energy supply distribution system. This network problem is in turn solved as a series of T subnetwork flow cost minimization problems in order to produce a global minimum cost flow allocation, node prices and arc constraint opportunity costs, notably the opportunity costs  $Z_{i,j}$  associated with the investment option arcs (i,j) corresponding to the respective binary variables  $y_{k,t}$  of the binary integer program. These node prices and opportunity costs are in turn used to update the "profit" or cost reduction contributions  $P_{k,t}$  in the objective function of the binary integer program. Since it is impossible to relate plant capacities  $H_{k,t}$  to the demand  $D_t$  at every period t, because of flow loss due to energy production, transformation and transmission, it is impossible (as yet) to feature constraints at every "step" of the staircase constraint matrix to ensure that the investment plan produced at the next iteration by the binary integer program results in a feasible network flow solution.

**Guaranteed Feasibility**

The above difficulty is resolved by constructing the generalized network flow representation of the problem in a manner that ensures problem feasibility for any investment plan produced by the integer program, including the case where all investment options  $y_{k,t}$  are "out", i.e. are equal to zero. Network feasibility is "guaranteed" by replacing all energy demand constraints in the network by price-demand elasticity mappings, using the method described by Debanné (1976, 1979, 1980) This method essentially consists in constructing as many "dummy flow" arcs as needed for a proper representation of every price-demand elasticity curve. These arcs originate at the source node of the network and terminate at the appropriate sink or demand node as illustrated in Fig. 2.

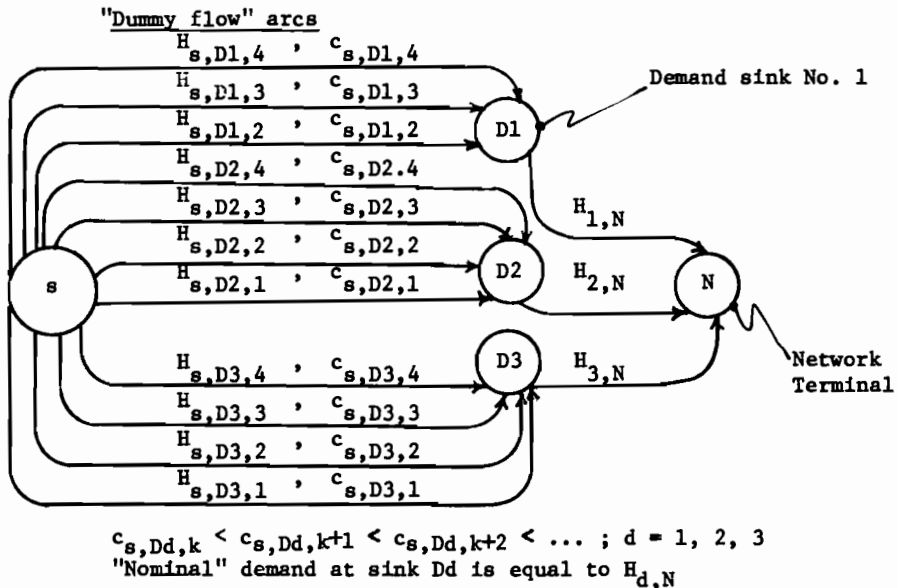

**Fig. 2 One Period Sub-Network Representation of Price Demand Elasticities by the "dummy flow" arcs method**

Nominal demands at the respective demand nodes  $D_d$ ,  $d = 1, 2, 3 \dots$  are set sufficiently high above the real life demand levels anticipated in the solution. The respective costs  $c_{s,Dd,k}$ ;  $d = 1, 2, 3, \dots$ ;  $k = 1, 2, 3, \dots$  and the respective



upper bounds  $H_{s,Dd,k}$  are such that the net demand consumed at node  $Dd$  and supplied from the energy supply-distribution-transformation network is the equilibrium demand corresponding to an opportunity cost or node price  $p_{Dd}$  at node  $Dd$ .

By specifying a total flow input  $DN$  input into the sink  $N$  of the network terminal (or a minimum flow requirement  $DN$  on the circulation arc of the network) such that  $DN$  is equal to the sum of "nominal" demands at nodes  $Dd$ ,  $d = 1, 2, 3, \dots$  at the respective demand sinks of the network and by setting the upper bounds to flow  $H_{d,N}$  respectively equal to the nominal demands at nodes  $Dd$ ;  $d = 1, 2, 3, \dots$ , the net flow reaching demand nodes  $Dd$  as well as network terminal  $N$  remain constant. Dummy flow arc costs are derived from the price demand elasticity curve for the commodity of interest at the demand node and period of interest and form a convex cost function. In other words arc  $(s, Dd, l)$  having the lowest cost  $c_{s, Dd, l}$  will be the first to become active in the  $(s, Dd, k)$  dummy flow arc set, if node price  $p_{Dd}$  becomes equal to or larger than  $c_{s, Dd, l}$ . Care must be exercised however in order to ensure that the last arc costs, i.e.  $c_{s, Dd, k}$  in Fig. 4 are high enough such that if all potential energy generating capacity increase options are "out", i.e. all binary variables  $y$  are set equal to zero, the optimal solution to the generalized network flow problem would result in a total cost  $T$  which is larger than if any energy generating capacity expansion was "in". This ought not pose a problem since the social cost of energy shortages is as a rule costed very high.

Subject to this last caveat, the global cost  $T$  versus total investment  $I$  function,  $T(I)$ , illustrated in Fig. 3 is piecewise linear non-increasing for  $I = 0$  up to an investment value  $\underline{I}$  corresponding to a minimum global cost or optimum solution; and is piecewise non-decreasing from  $\underline{I}$  to  $I_{max}$ , the maximum amount of investments if constraints, e.g. mutual exclusivity constraints are lifted.

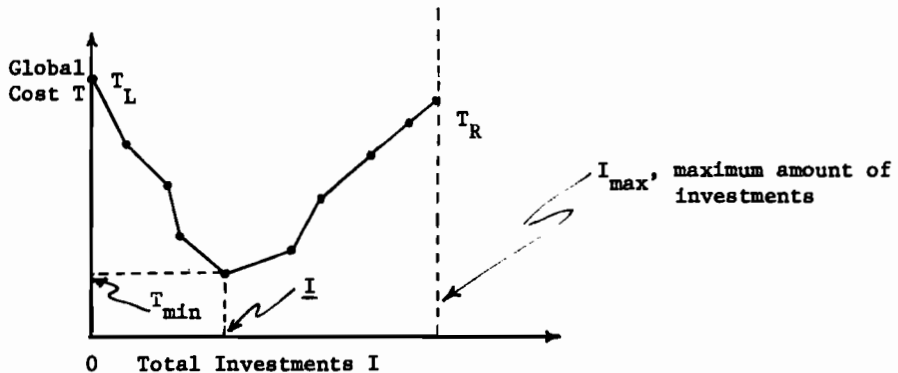

Fig. 3 Global Cost  $T(I)$  Curve as a Function of Total Investments  $I$ .

The computational strategy consists therefore in starting at one end of the investment spectrum, e.g.  $I = 0$  corresponding to all investment options "out" and evaluating the global cost  $T$  with the generalized network flow algorithm. The optimum investment schedule corresponding to a minimum global cost  $T_{min}$  is obtained by determining  $\underline{I}$ , the investment or budget constraint imposed on the binary integer program (see Fig. 1), beyond which global cost  $T$  increases. Note that if  $\Delta T/\Delta I = 0$ , i.e. if  $T$  ceases to decrease,  $\underline{I}$  may not as yet have been reached. An alternative strategy would be akin to a binary search in the interval  $I_0$  to  $I_{max}$ , corresponding to  $T_L$  and  $T_R$  in Fig. 3. By successively halving the adjacent intervals and evaluating the global cost  $T$ , the optimum investment plan is determined in a small number of steps. Starting at  $I_{max}$  in order to reach  $\underline{I}$  is yet another strategy.

In short, "guaranteed feasibility" of the generalized network flow optimization problem simplifies the primary or first stage decision process of this decomposition scheme to one decision variable, namely the budget constraint I. However, it is necessary that the second stage decision process, i.e. the integer program, produce for any budget constraint I an optimal investment plan [y]. To this effect, the profit or cost reduction coefficients  $\underline{p}$  associated with every integer variable y must be appropriately estimated. This issue is more appropriately discussed in the formulation of the problem, which follows.

#### FORMULATION OF THE PROBLEM

Given a typical energy supply-transformation-distribution-demand system, see Debanné (1980) this system can be formulated as a generalized network flow problem [G] supplemented by a binary integer program featuring a set [F] of zero-one variables  $y_{i,j}$  with fixed charges  $f_{i,j}$ . This optimization problem can be formulated as follows:

$$\text{Minimize } \sum_{(i,j) \in G} c_{i,j} \cdot x_{i,j} + \sum_{(i,j) \in F} f_{i,j} \cdot y_{i,j} \quad (1)$$

$$\text{subject to: } \sum_i e_{i,j} \cdot x_{i,j} = \sum_k x_{j,k} ; e_{i,j} > 0 \quad (2)$$

$$L_{i,j} \leq x_{i,j} \leq H_{i,j} ; (i,j) \in G \quad (3)$$

where -  $L_{i,j}$ ,  $H_{i,j}$  are the lower and upper bounds to flow entering arcs  $(i,j) \in G$   
 -  $e_{i,j}$  is the flow "efficiency" or "gain" in arc  $(i,j) \in G$ , such that the flow leaving arc  $(i,j)$  at node  $j$  is equal to  $e_{i,j} \cdot x_{i,j}$ .

Note that since price-demand elasticities instead of demands are used to drive the model, a generalized network flow optimization code that restricts  $L_{i,j}$  to be equal to zero, e.g. Jensen's code (1974) can be used in this decomposition scheme. In this case  $\Sigma d$  the total input into the network terminal is specified.

Therefore, in order to guarantee feasibility of the generalized network flow problem, the following constraint is imposed

$$L_{i,j} = 0; (i,j) \in G \quad (4)$$

This constraint is not expected to affect the applicability of the algorithm in the great majority of cases as it is usually possible to replace an arc  $(i,j)$  featuring a lower limit to flow  $L_{i,j} > 0$  by two arcs  $(i,j)'$  and  $(i,j)''$ . Arc  $(i,j)'$  is assigned  $L'_{i,j} = 0$ ,  $H'_{i,j} = L_{i,j}$  and  $c'_{i,j} < 0$ . Arc  $(i,j)''$  is assigned  $L''_{i,j} = 0$ ,  $H''_{i,j} = H_{i,j} - L_{i,j}$  and  $c''_{i,j} = c_{i,j}$ . Caution must however be exercised in this in this case to make sure that the negative  $c'_{i,j}$ 's do not result in a negative circuit. In addition to constraints (2), (3), (4) which apply to the generalized network partition of the problem, the following constraints apply to the binary integer program partition, i.e.:

$$\text{Integrality constraints: } y_{i,j} = 0,1 \text{ (binary integer); } (i,j) \in F \quad (5)$$

$$\text{Precedence constraints: } y_{i,j,t} \leq y_{i,j,t+1} \quad (6)$$

### Extended Constraint Capability

Moreover, constraints peculiar to the investment problem at hand, such as mutual exclusivity constraints applying to any two or more "y<sub>k</sub>" variables can be imposed, e.g.:

$$y_1 + y_2 + y_3 \leq 1 \quad (7)$$

$$\text{or } y_1 + y_2 + y_3 + y_4 \leq 2 \quad (7')$$

If a particular investment  $y_{i,j,t}$  at period  $t$  necessitates a subsequent investment  $y_{k,m,t+n}$ ,  $n$  periods hence, this constraint is specified as follows:

$$y_{i,j,t} = y_{k,m,t+n} \text{ or } y_{i,j,t} \leq y_{k,m,t+n} \quad (7'')$$

depending on whether or not project  $y_{k,m}$  is viable without the existence of facility represented by project  $y_{i,j}$ .

Any set of constraints governing investment and technology variables  $y_{i,j}$  and here referred to as "type 7" constraints, may be specified, provided that the binary integer program, e.g. Balas' Additive Algorithm (1964) is set up to accommodate such linear constraint sets. This constraint specification capability enhances considerably the modelling flexibility that can be brought to bear in order to solve real world energy planning problems. Indeed, there is no reason why an efficient binary integer program that can accommodate non-linear constraints could not be used, thereby extending further still the applicability domain of this algorithm.

### Linkage Constraints

Finally a linkage constraint between each zero-one variable  $y_{i,j}$  in the binary integer program and the corresponding arc  $(i,j) \in F$  in network  $G$  must be specified:

$$L_{i,j} = 0 \leq x_{i,j} \leq y_{i,j} \cdot H_{i,j}; (i,j) \in F \quad (8)$$

If  $y_{i,j} = 1$ , the corresponding arc  $(i,j)$  in network  $G$  has a capacity  $H_{i,j} > 0$ ; conversely, if the option is "out", i.e. if  $y_{i,j} = 0$ , the corresponding arc  $(i,j)$  in  $G$  has zero capacity.

### Arc Costs $c_{i,j}$

Costs  $c_{i,j}$  assigned to arcs  $(i,j) \in [G - F]$  are unit costs and represent unit production, transmission, trans-shipment or transformation costs. These costs are here referred to as variable costs  $v_{i,j}$ . Arcs  $(i,j) \in F$  representing investment options are assigned a "composite" cost defined as follows:

$$c_{i,j} = f_{i,j} / \underline{x}_{i,j} + v_{i,j}; (i,j) \in F; \underline{x}_{i,j} \neq 0 \quad (9)$$

where  $\underline{x}_{i,j}$  is the utilisation level of any arc  $(i,j) \in F$

### Utilization Levels $\underline{x}_{i,j}$

The "utilisation level"  $\underline{x}_{i,j}$  is defined as an expected activity level  $x_{i,j}$  used to calculate arc costs  $c_{i,j}$  assigned to arcs  $(i,j) \in F$  prior to a network flow optimization pass or used to compute the profit contribution coefficients  $P_{i,j}$ , corresponding to the respective binary variables  $y_{i,j}; (i,j) \in F$  in the binary integer program. Utilization levels  $\underline{x}_{i,j}$  are updated after every network optimization pass according to the following rules:

$$\left. \begin{aligned} \underline{x}_{i,j} &= x_{i,j} ; x_{i,j} > 0 ; \underline{x}_{i,j} \neq x_{i,j} \\ \underline{x}_{i,j} &= x_{i,j}^{\max} ; x_{i,j} = 0 \end{aligned} \right\} \quad (10)$$

where  $x_{i,j}^{\max}$  is the maximum flow previously recorded in arc  $(i,j)$ .

Note that to initialize the iterative process, each  $\underline{x}_{i,j}$  is initially set equal to  $H_{i,j}$  the capacity of the option represented by arc  $(i,j) \in F$ .

If one or more activity levels  $x_{i,j}$  of "in" arcs are different from their corresponding utilization levels  $\underline{x}_{i,j}$  after a sub-network optimization, utilization levels are updated according to Eq. (10), the corresponding arc costs are then updated according to Eq. 9 and the affected sub-network re-optimized. Note that if the generalized network is not partitioned into sub-networks, (one for every time period), the entire network must be re-optimized. The purpose of repeating the network optimization if utilization levels  $\underline{x}_{i,j}$  are different from actual activity levels  $x_{i,j}$  is to ensure that correct arc costs  $c_{i,j}$  are used, hence that shadow prices  $p_k$  at nodes of the network and opportunity costs  $Z_{i,j}$  for investment option arcs  $(i,j) \in F$  are correct. These economic measures are in turn used to derive the profit or cost reduction coefficients  $P_{i,j}$  needed in the objective function of the binary integer program. Moreover, a network optimum solution using the correct arc costs  $c_{i,j}$  yields a correct global cost  $T$  since:

$$T = \sum_{(i,j) \in G} c_{i,j} \cdot x_{i,j} = \sum_{(i,j) \in G} v_{i,j} \cdot x_{i,j} + \sum_{(i,j) \in F} f_{i,j} \cdot y_{i,j} \quad (11)$$

Total variable    Total investment  
Costs  $V$             Cost  $I$

Shadow Prices  $Z_{i,j}$  and Cost Reduction Coefficients  $P_{i,j}$

The shadow prices  $Z_{i,j}$  in a generalized network flow minimum cost solution is for all arcs  $(i,j)$

$$Z_{i,j} = p_i + c_{i,j} - e_{i,j} \cdot p_j ; (i,j) \in G \quad (12)$$

where  $e_{i,j}$  = the flow efficiency (gain or loss) in arc  $(i,j)$

$p_i, p_j$  = the shadow price or equilibrium value of one unit of commodity delivered at node  $i$  (or  $j$ )

Arc cost  $c_{i,j}$  represents a variable cost for all arcs except arcs  $(i,j) \in F$ , where  $c_{i,j}$  is defined according to Eq. 9; we then have

$$Z_{i,j} = p_i + f_{i,j}/x_{i,j} + v_{i,j} - e_{i,j} \cdot p_j ; (i,j) \in G \quad (13)$$

At equilibrium, two states are possible: either the capacity constraint  $H_{i,j}$  on arc  $(i,j) \in F$  is binding, in which case  $Z_{i,j} < 0$ ; or else  $H_{i,j}$  is not binding, in which case  $Z_{i,j} \geq 0$ . The profit or cost reduction coefficients  $P_{i,j}$  to be used in the objective function of the binary integer program is then defined as follows:

$$P_{i,j} = Z_{i,j} \cdot \underline{x}_{i,j} - f_{i,j} ; (i,j) \in F \quad (14)$$

which represents the expected reduction in variable cost  $V$  if option  $(i,j) \in F$  is "in" and attains an activity level  $x_{i,j} = \bar{x}_{i,j}$  in the next network flow optimization. Note that according to Eq. 14 all options with a  $Z_{i,j} = 0$  will have a  $P_{i,j} = -f_{i,j}$  and will be negative. Those options with a  $Z_{i,j} < 0$  will also be assigned a negative cost contribution  $P_{i,j}$ . Likewise, some options with a  $Z_{i,j} > 0$  may also be assigned a  $P_{i,j} < 0$ . As a result, the objective function of the binary integer program, i.e.

$$\text{Minimize } \sum P_{i,j} \cdot y_{i,j} ; (i,j) \in F \quad (15)$$

would tend to maximize the introduction of options, subject to the budget constraint:

$$\sum f_{i,j} \cdot y_{i,j} \leq I \quad (16)$$

where  $I$ , the budget constraint is the only first order decision variable. Note that the other constraints imposed to the binary integer program optimization, which are outlined earlier and which are schematically represented in Fig. 1, still hold, but remain invariant throughout the computational scheme. The essence of this optimization problem is therefore reduced to the issue of how best to vary the budget constraint  $I$  in order to locate  $I$  and determine or approach  $T_{\min}$  efficiently (see Fig. 3). The guaranteed feasibility construct and the formulation presented in this paper can be exploited by different strategies.

A detailed computational strategy based on the above formulation will be presented in a forthcoming paper.

#### REFERENCES

- Balas, E. (1964). "An Additive Algorithm for Solving Linear Programs with Zero-One Variables", Operation Research, July-August 1965, pp. 517-549.
- Benders, J. (1962). "Partitioning Procedures for Solving Mixed Variables Programming Problems", Numerische Mathematik 4, pp. 238-252.
- Brooks, R. E. (1976). GASNET: A mathematical programming model for the allocation of natural gas in the United States. Working Paper #34-1976 Graduate School of Business Administration, University of Southern California, Los Angeles.
- Debanné, J. G. (1971). A continental oil supply and distribution model, Journal of Petroleum Technology, pp. 1089-1100.
- Debanné, J. G. (1971). A systems approach for oil and gas policy analysis in North America. Proceedings of the 8th World Petroleum Congress, Moscow.
- Debanné, J. G. (1975). A regional techno-economic energy supply-distribution model for North America. Computers and Operations Research, pp. 153-193.
- Debanné, J. G. (1976). Cybernetics and large systems optimization. Cybernetics and modeling of large systems, ed. T.I. Oren. Doc. 3, Association of International Cybernetics Publications, Namur, Belgium, pp. 57-86.
- Debanné, J. G. (1980). "Network Based Regional Energy Planning Models", Energy Policy Modelling, Vol II, W. Ziemia, Editor, TKM Productions Publ., Peabody Mass. 01960, pp. 155-184.
- Debanné, J. G., Beaubien, P., Laleh, I.R. (1980). "Multi-Period Investment Planning and Supply-Distribution Management Support System", paper to be presented at the Journées de l'Optimisation, Montreal, May 21-22, 1980.
- Geoffrion, A. and Graves, G. "Multicommodity Distribution System Design by Benders Decomposition", Management Science, January 1974.
- Geoffrion, A. and Powers, R. "Management Support Systems", Western Management Science Institute Working Paper. No. 287B, September 1979.
- Jensen, P. A. and Bhaumik, G. (1974). "A Computationally Efficient Algorithm for the Network with Gains Problems", Presented at the 45th National Meeting of ORSA, Boston.



## *Session V*

### ISSUES OF DECISION MAKING UNDER UNCERTAINTY





# RISK STUDIES FOR NUCLEAR POWER PLANTS — MERITS AND LIMITATIONS

**A. Birkhofer**

*Lehrstuhl für Reaktordynamik und Reaktorsicherheit, Technische  
Universität München, Federal Republic of Germany*

## ABSTRACT

Main results of the German Risk Study for nuclear power plants are presented. On the basis of these results merits and limitations of risk analyses are discussed. It is shown that such analyses can give objective criteria for the design of engineered safeguards and help to harmonize the safety concept.

## KEYWORDS

Reactor safety; risk analysis; technology assessment.

## INTRODUCTION

It has always been a most important aspect in the development and the application of technology, to avoid hazards to man and environment as far as possible. It is in the nature of new developments to extend the scope of applications into areas where not all potential problems are fully understood. In this situation it is important to recognize new hazards on the basis of the available experience. In general, however, this goal can be reached only partially. Therefore, the principle of "trial and error" has always played an important role in technology, in addition to the well-directed protection against hazards already recognized. This learning process is acceptable, as long as the loss resulting from a single technical failure is relatively small. Corrective actions are feasible in due time to avoid large extent damages.

A basically different situation exists in case of big industrial installations with inherent high hazards potential. Large damage could result from a single accident. In such cases the higher hazards potential has to be compensated for by higher graded safety measures. This reflects a basic principle in technology that the hazards potential is a measure of the amount of safeguards required. As long as the safeguards are properly operating, severe damages will very rarely occur as a result of an accident. The still remaining hazard - one might also call it risk - can then hardly be assessed on the basis of really occurred damages.

Proper decision making requires objective information on hazards. While in the past the solution of problems of this kind has always a task of the experts in the technical field, it has recently become an issue of great public interest. This is particularly true for problems of air pollution posing health hazards and other

environmental impacts. Increasingly, also accidental risks from large industrial installations are attracting public attention. If risks cannot directly be quantified from experience, there remains the possibility to assess potential hazards by means of analytical methods.

In the following, efforts are made to outline merits and limitations of such analyses. This is done mainly on the basis of the methods developed for WASH-1400 and applied also to the "German Risk Study" for nuclear power plants with pressurized water reactors.

#### RESULTS OF THE GERMAN RISK STUDY FOR NUCLEAR POWER PLANTS

Each risk can be characterized by probability and extent of possible damages of various kinds (e.g. health damage, loss of life, property damage). The safety concepts applied in nuclear power plants ensure that accidents do not cause dangerous release of radioactive material into the environment as long as the engineered safeguards are properly operating. Therefore, only those events contribute significantly to the risk which result from failure of systems required to cope with an accident.

The sequence of events, starting from an "initiating failure" is dependent on the functioning or failure of actuated engineered safeguards. Since a number of different systems are actuated, a multitude of different courses of events is conceivable, depending on the possible combinations of system success and system failure.

The frequency of a specific sequence of events is determined by the frequency of the initiating failure and by the probabilities of success or failure of the different systems required. For highly reliable systems these probabilities are frequently not known from direct experience. Therefore, they have to be calculated analytically.

This is done mostly by means of fault tree analyses. A fault tree represents the logical structure of the functional interaction between different system components. On the basis of this structure the probability of system failure is calculated as a function of probabilities of component failures. In doing so, also the influence of human behaviour and of external events on system reliability may be considered.

To analyze the risk from a nuclear power plant mainly events leading to the melt-down of the reactor core have to be traced. Only in this large amount activity releases could happen.

In the German Risk Study a core melt frequency of about 1 to 10,000 per year was estimated, using a nuclear power plant with pressurized water reactor as a model. Quite a number of accident sequences contribute to this number. About 70 have been analyzed in some detail. Fig. 1 shows the influence of the different initiating events on the overall core melt frequency. The loss main coolant through a small leak in a reactor coolant pipe dominates all other contributions. In comparison, a large break in the main coolant piping is of very little significance, although it could be deemed much more serious in the first instance. This fact has mainly two reasons.

- Small leaks may occur more frequently than medium or large breaks.
- In order to remove the decay heat, the reactor has to be cooled down by the secondary system. For this task operator action is necessary. In this case the influence of manual actions reduces system availability significantly.

Fig. 2 shows, that consequently about two third of the overall core melt fre-

quency result from human errors.

The risk analysis thus finds great significance in seemingly unimportant operational disturbances which lead to insufficient core cooling as a result of multiple technical and human failures. On the other hand, more spectacular initiating events, like the guillotine break of a main coolant pipe, is of less importance.

After fission products have been released into the containment, their impact onto the environment depends on the state of containment. Containment integrity may be lost due to fast or delayed overpressure failure, or due to failure of containment isolation. By combining results of core melt analysis with the analysis of containment failure modes, amount and frequency of fission product released from the plant to the atmosphere are obtained. Further more, the atmospheric dispersion of fission products, and the resulting radiation exposures are calculated.

Finally, health effects and - according to the population data - the number of individuals afflicted by health damage have been estimated. Emergency procedures like evacuation of contaminated areas have been taken into account based on government recommendations existing in Germany.

Fig. 3 shows the correlation between number and frequency of acute fatalities which could be caused by radiation exposure to the public after a nuclear accident. With 25 plants in operation a frequency of about  $10^{-5}$  per year has been estimated that acute fatalities are caused. The study has made an attempt to quantify confidence intervals of the results. These are shown at selected points. From this figure it can be concluded that large consequence events are extremely unlikely. Fig. 4 shows that these low frequencies result as the product of several factors. Considering 25 plants, calculations show a core melt frequency of 1 to 400 per year. Given a core melt down, fission product release to the atmosphere is limited by the containment in most cases very effectively. There is only a chance of 1 to 16 that potentially lethal doses would appear after severe containment failure. In this case, consequences depend on weather conditions and population distribution. The chance for this situation is 1 to 10 that acute fatalities are caused. Given a core melt accident, the probability is higher than 99% that no acute fatality will occur. A great number of fatalities could only occur if after the most severe accident unfavourable weather conditions coincide with specific site conditions. Given a lethal activity release, the probability is in addition less than 1% that 2,000 or more acute fatalities are caused.

Besides acute fatalities, similar to WASH-1400, late health effects were calculated. Late health effects reflect the possibility of an increased risk of cancer or leukemia due to radiation. These effects may show up after a latent period of some decades. They have therefore been traced over several generations. From Fig. 5 it can be concluded that late effects are estimated also for less severe accidents. With a frequency of about 1 to 200 per year for 25 plants a considerable number of late fatalities has been calculated. It has to be born in mind that a linear dose-risk relationship has been used by the study. That means that even the smallest radiation exposure is assumed to cause an increase of risk of cancer. Late health effects which have been calculated would appear over large areas. As an average about half of these effects may occur outside the Federal Republik of Germany.

This emphasizes the international importance of reactor safety. Applying the assumptions of the study - the linear dose-risk relationship - it can be calculated that about half a percent of all cancer fatalities are caused by natural radiation. Although this influence is rather small, the absolute numbers amount to more than 50,000 for Germany and about 600,000 for Europe, if the whole period of life is considered.

The study also estimated the number of people and the extension of areas affected by evacuation or relocation. However, the models are very crude in this respect so that the results can only be considered as rough estimates and are not presented here.

#### UNCERTAINTY MARGINS OF RISK ANALYSIS

If all quantities influencing a risk analysis were either deterministic or subject to stochastic variations according to a known law, then the probability of occurrence of a certain event could be calculated as a single number, just like the probability that a thrown dice shows a certain face can be determined as 1/6. However, risk analysis of complex technical systems has to account for other kind of influencing quantities which cannot be determined exactly because of incomplete knowledge.

For illustration, consider the failure probability of an electric circuit consisting of components like transistors, diodes, resistors etc. The failure probability of each of the components will depend on operating and environmental conditions, and will be subject to nonstochastic variations, influencing the uncertainty margins. In order to explicitly exhibit this kind of uncertainty, density distributions reflecting the existing knowledge are used for the description of such parameters. Consequently, a density distribution is obtained for the circuit failure probability.

In complex systems there are many other uncertain parameters besides component failure probabilities, which influence the calculated probabilities. However, the general way of treatment follows the pattern outlined above. Thus, finally, subjective density distributions are obtained for the probability of a certain damage.

In practice, various problems arise, which restrict the accuracy of the analysis and widen the range of uncertainty beyond the theoretically unavoidable measure.

#### Problem of completeness

It is practically impossible, to analyze all conceivable initiating events and their consequences. Thus, the detailed analysis has to investigate such initiating event which cover all the others with regard to consequences. Accordingly, the estimated frequency of an initiating event has to include contributions from other subsumized events. The possible sequences of accident resulting from an initiating event are systematically arranged and their frequencies and consequences are assessed. Of course, there remains in principle the eventuality to miss essential effects or to underestimate frequencies.

At the time of the TMI-accident the German Risk Study had been almost completed. The question has been asked, if the sequence of events occurring at TMI had been considered in sufficient detail.

The transition from a transient to a small leak, like in TMI, had been recognized as an important contribution to risk in the early stage of the work. At TMI the leak could be closed after some time. However, significant portions of the coolant had already been lost. Thus, the reactor had to be cooled with only a portion of its normal coolant inventory.

Because the study pessimistically did not take account for the reestablishment of failed system functions, the actual sequence of events occurring at TMI has not been considered, but it has been assumed a total core meltdown for this case. Explicit treatment of time-dependent effects would require much more detailed simu-

lation of the physical phenomena during an accident. A systematic approach renders omissions improbable. However, a positive proof of completeness is not possible. In any case, the qualification of the analyst and the detailed knowledge of the respective systems play an essential role. Certain risks may not be considered deliberately. So, the German Risk Study did not attempt to quantify frequency and extent of damages, which could be caused by military actions or by acts of sabotage.

### Data

Another problem results from the fact that reliability data are required for all components considered in reliability analysis. Since these data can only be derived from statistical evaluations of experience or by experts estimate, they are inevitably affected with uncertainties. It is obvious, that uncertainty margins are larger, the less experience is available. Frequently data have to be used which have been determined not for the component considered but for one of similar design and similar environmental conditions. In this case, the calculated reliabilities are, strictly speaking, not valid for a specific plant, but serve as model for plants of the type analyzed.

### Human influences

The safety design of nuclear power plants also provides measures against human failures. Safety actions, especially if they are required within a short time, are actuated automatically, as far as possible. This provides for the operators the opportunity to become acquainted with an upset plant condition and - if necessary - to respond with well planned actions. A number of other measures, mainly intensive training of operators is aimed to reduce the probability of false actions.

Despite such provisions operator errors cannot be fully excluded. Therefore, they have to be considered in reliability analyses. Though it is rather straight forward to identify cases in which human errors could lead to system failure, it is difficult to quantify probabilities of such erroneous actions. Since it is unfeasible to frame human behaviour into a rigid pattern, one has to operate with estimates. For example, the failure probability is rated the higher, the less time is available to react, the more complicated the required action is, or the less the "personal redundancy" is.

Particular problems may be encountered in the identification and quantification of operator actions not planned in operator manuals. The effects of such actions could be adverse as well as favourable. It is likely, however, that primarily the frequencies of events will be influenced by such actions. Basically new accident sequences are not to be expected.

### Common-Mode Failures

This term means cases, in which several components and one or several systems are put out of order by a single cause. A fire, impairing several redundant system at the same time, could be a typical example. Analysis of common-mode failures poses some serious problems. Reliability analysis is particularly suitable, to recognize system configurations, which could give rise to common-mode failures. A portion of such failures will be picked up by the systematics of fault tree analysis. However, for other cases it depends on the knowledge of the analyst to recognize potential common-mode failures which could have been missed by the analysis.

Probability assessment often is only possible on the basis of estimates, since there is only little experience available with common-mode failures. Moreover, frequently experience is not applicable to actual design, since recognized causes of common-mode failure will lead to design modifications.

### Accident simulation

Risk analyses have not only to calculate system reliabilities, but also to simulate the physical course of accidents by means of computer codes. In the first place, this is necessary to determine requirements for the safety systems. However, the German Risk Study - just like WASH-1400 - in this point relies mainly on the accident analyses, which have been performed for the safety assessment for the reference or similar plants during the licensing procedure. That means, that for the risk analysis safety systems are considered as totally failed, if fewer redundant subsystems are available than have been assumed as functionable in the safety assessment.

In the next step, the further course of accidents, which follow from system failures, have to be simulated. The models, on which the computer codes are based, usually describe the real events only approximately. Therefore, one tries to model the phenomena in such a way that the calculations always give pessimistic results. For risk analyses, which should supply realistic results, this is unsatisfactory. Presently, these uncertainties can hardly be quantified.

Calculation of damage, caused by radiation exposure, plays an essential role in risk analysis. Also this calculation depends on various parameters, which either can be described only statistically or which have to be estimated. The first category contains for instance the meteorological conditions, which prevail at and after an accident. Examples of the second category are the biological-medical parameters, like dose-effect-relations, or parameters of the emergency procedures. In the German Risk Study it was attempted to assess uncertainty margins. The corresponding confidence intervals have already been shown together with the results of the study.

### USE OF RISK ANALYSIS TO ASSIST DECISION MAKING

On the background of the situation described one may ask to what extent risk analyses are an appropriate instrument to assist decision making.

In the Federal Republic of Germany, like in many other countries, today courts have the last word on licensing of nuclear plants. They have to decide whether the provisions are sufficient to exclude undue hazards to the public from the operation of nuclear power plants. In evaluating the required provisions the state of science and technology has to be applied.

Problems always arise, when the undefined legal terms "state of science and technology" and "required provisions" have to be concretized. The idea is self-suggesting to fix by law a permissible risk and to prove that this risk will not be exceeded. The proof, that the risk from a specific plant does not exceed a specified level, is a technical problem. The discussed difficulties in the methods of risk analysis suggest that it is presently not feasible to furnish legally unquestionable evidence about the absolute level of risk remaining in spite of all safety measures. With our present knowledge it is doubtful if the problems mentioned can be solved in a satisfactory way.

The problem of fixing a permissible level of risk is primarily of political nature. Legislative action of parliament would be required and it must be doubted that the willingness to do so could be stimulated. Presently, the public does not seem to be used to proper dealing with and interpretation of risk numbers. As long as this situation persists, it is understandable that politicians have reservations about declaring certain risks, and thus implicitly certain damages, as acceptable.

However, there are indications of change of opinion. From the discussion of risks

it has been learned, that the eventuality of large extent damages, although expected with very low probabilities, could play a role in decision making. The demand seems to arise, to limit frequencies as well as the potential extent of damage by inherent engineered safeguards.

The situation is complicated by the fact that the individual perception of risk may largely differ from actual or estimated risk. I believe IIASA to be one of the most experienced institutions in this field. Also recent investigations conducted at MIT have shown that the quantitative measure of accepted risks may differ by several orders of magnitudes. According to this work, individual risks of death by accident resulting from well known causes, being tolerated voluntarily, considered controllable, and affecting only a few persons simultaneously with some time delay, are accepted if their probability is  $10^{-2}$  to  $10^{-3}$  per year and person. For risks of death by accident of complementary nature, like novel causes, involuntarily tolerated, immediate consequences assumed to be uncontrollable and catastrophic as a single event, the acceptance level is as low as  $10^{-9}$  per year and person.

Below the level of formal decision making, risk analyses, may influence public opinion. In this process, two opposite reactions become visible: On the one hand the intention to analyze risks, and the potential to minimize them, is appreciated by the public. On the other side, the public may be made conscious of a certain risk through its detailed analysis which conflicts with the human reaction to suppress the notion of risk. The evolution of technology has always taken account of this attitude. Technical products are declared safe, and also considered safe by the public, if they are produced according to the current safety standard. In many instances, the "amount of safety" is expressed in terms of a safety factor. However, also by determination of safety factors, one implicitly accepts failure probabilities and, in consequence, certain damages.

Normally, this becomes evident only through the occurrence of accidents resulting in damages. The public seems to be largely unaware of these interrelations. Consequently, the determination of safety factors and similar safety requirements is left to the experts. Yet, if the expert expresses in the same situation the amount of safety in terms of corresponding failure probabilities and of possible consequences of failure, he may easily be accused to decide over life or death.

It will become necessary to make the public better acquainted with the approach of risk analyses (which is also new to many engineers and scientists). Among other things, this requires to make available suitable measures of comparison in order to enable realistic evaluation of the analyzed risks. Obviously, comparisons are accepted more easily, if they are made mainly between technical systems serving equal purposes. This could provide a basis for decisions between several alternative technologies.

However, one of the problems of such comparisons is that damages of different kinds may occur. It is still unclear how a uniform and commonly accepted measure of evaluation can be defined for such damages as early and late health effect, large area contamination, and long range meteorological effects - to name a few typical kinds of damages. On the other hand, comparison of risks of technologies serving different purposes, like nuclear energy systems or big chemical plants, could be used primarily to show the level of risk we are living with. Another point is, to what extent can probabilistic investigations influence decisions in the technical field considering nuclear plants, mainly three areas may be distinguished:

Determination of accidents and accident sequences which have to be accounted for in the safety design

In the assessment of safety of nuclear plants one always has made use of probabili-

ties - at least implicitly. This is already indicated by the use of terms like "maximum credible accident" in the 60's. Also the concept of "design basis accident", as it is used today, is partly based on probabilistic considerations. Probabilistic aspects, however, are mostly transposed into deterministic criteria. So, assumptions about the safety systems to be used in the analysis of an accident, are determined by convention.

By quantitative probabilistic methods a well-balanced concept can be reached, since possible sequences of event are not assessed according to rigid criteria, but judged according to their respective contribution to risk.

#### Comparison and optimization of systems

In order to optimize systems design it is necessary not only to analyze the performance of individual systems, but to consider the interactions of the different systems required to cope with accidental situations. This is particularly important because system design in general as well as later system modifications can cause undesirable effects in other systems. Here, a quantitative probabilistic analysis advantages over rigid deterministic criteria, applied mostly only to individual systems. Also the licensing procedure for nuclear plants makes use of probabilistic analyses when evaluating systems design. Yet, this is frequently done only for selected systems, thus losing the advantage of a systematic global analysis.

#### Test and maintenance strategies

Maintenance is a crucial aspect for the reliability of safety systems. On the basis of reliability analysis test intervals and permissible repair times are fixed. In all three cases it is sufficient to perform reliability analysis. Consequence calculations, necessary to determine the risk, are not required in this context. Risk analysis, however, could be employed in order to obtain reference values for the required systems reliabilities.

Probabilistic methods have been used in various technical disciplines for designing systems of high reliability. E.g., in licensing commercial airplanes, many countries require the applicant to demonstrate that the probability of failure of vital systems does not exceed predetermined values. In determining the probabilities of system failure human errors seem to be considered only to a limited extent. A complete risk analysis is not performed. Contrary to nuclear technology, cases concerning licensing of commercial airplanes have rarely been taken to court. Therefore, it is not so urgent to furnish legally unquestionable evidence on the level of risk.

### CONCLUSIONS

Merits of risk analyses lay mainly in the field of technical assessment. They can give objective criteria for the design of engineered safeguards and help to harmonize the safety concept. In many instances, however, also reliability analysis could give the required information. For a proper interpretation and use of results of risk analyses it is essential to provide for comparative numbers.



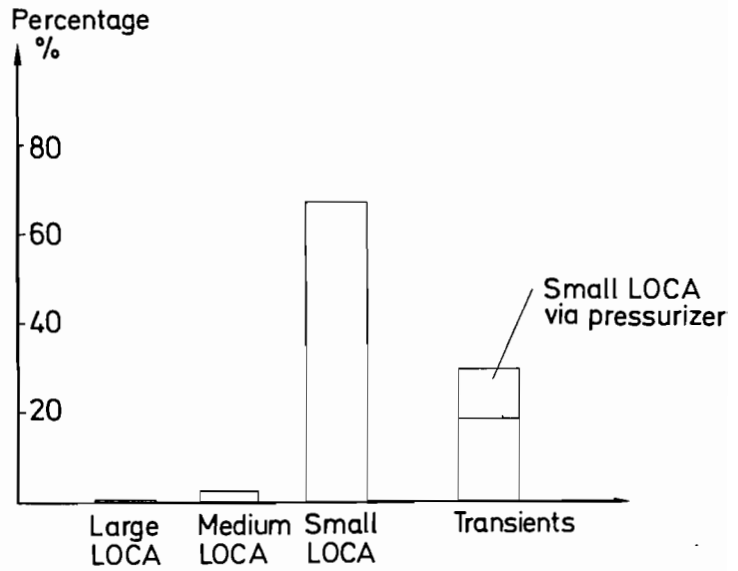

Fig. 1. RELATIVE CONTRIBUTION OF VARIOUS INITIATING EVENTS TO CORE MELT FREQUENCY

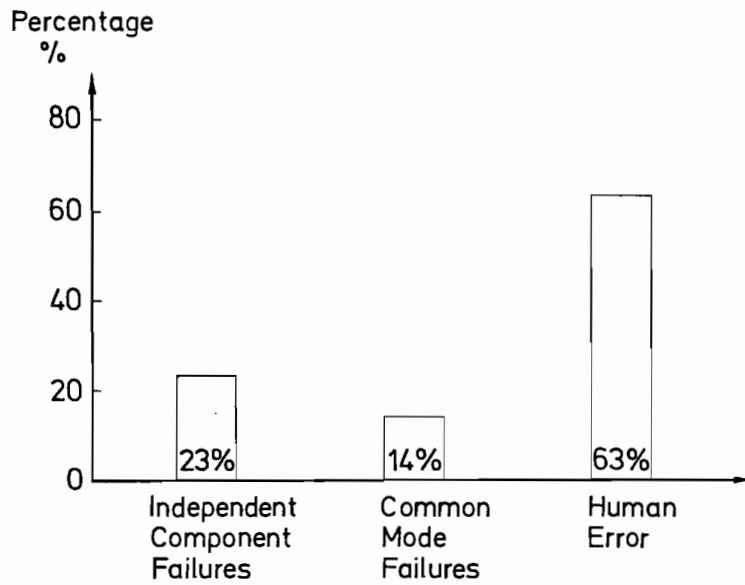

Fig. 2. RELATIVE CONTRIBUTION OF DIFFERENT FAILURE MODES TO CORE MELT FREQUENCY

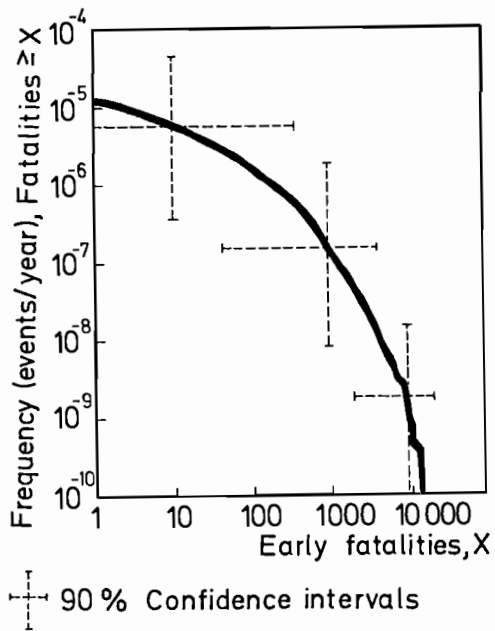

Fig. 3. FREQUENCY OF EARLY FATALITIES (25 PLANTS)

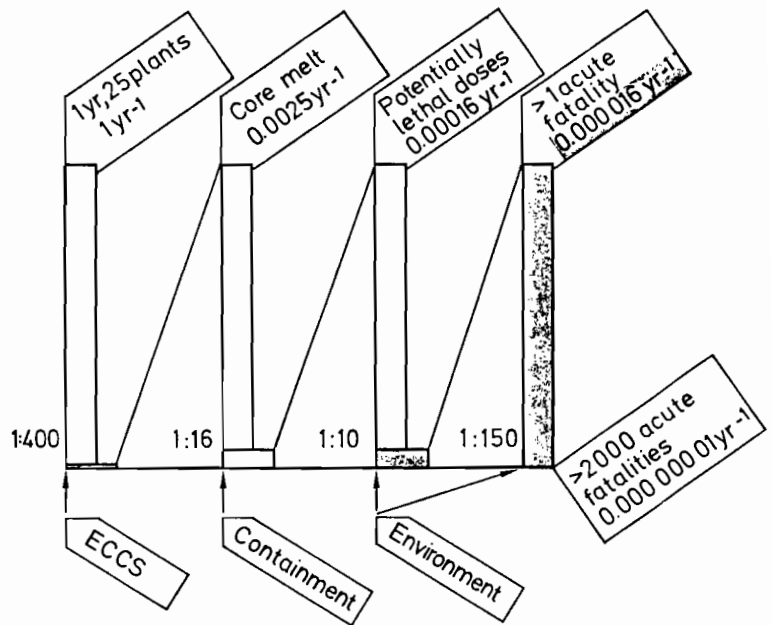

Fig. 4. FREQUENCY OF ACCIDENT CONSEQUENCES (PER YEAR, 25 PLANTS)

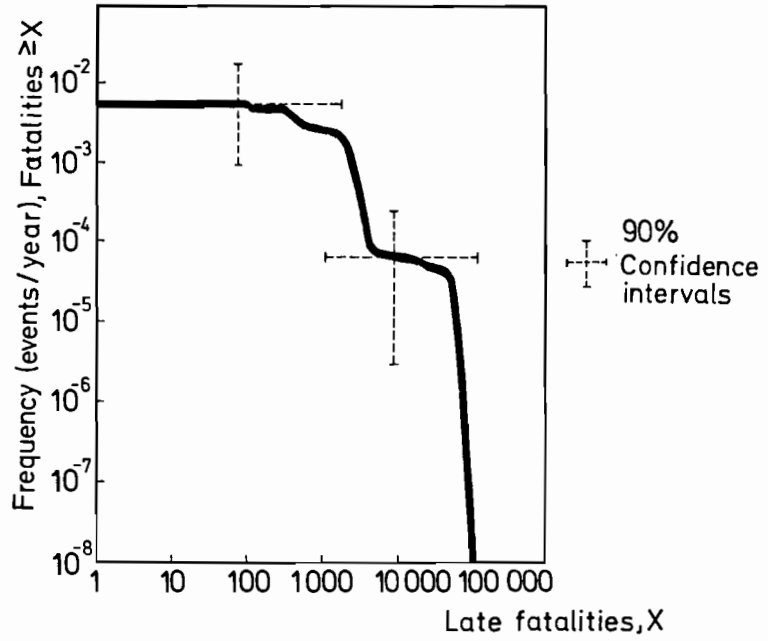

Fig. 5. FREQUENCY OF LATE FATALITIES  
(25 PLANTS)



# SOME PRINCIPAL ASPECTS OF FORECASTING AND DECISION-MAKING AND THE ISSUES OF DECISION-MAKING UNDER UNCERTAINTY IN THE AUSTRIAN ELECTRICITY SUPPLY SYSTEM

**F. Pober**

*Verbundgesellschaft, A-1010 Vienna, Am Hof 6A, Austria*

## ABSTRACT

The forecast of demand and the planning of electricity supply systems have to be made in a political and economical environment of growing uncertainty. In the first part some basic notions related to systems, operations and models are mentioned. The concept of probability forecast is discussed and a new notion is defined, the preciseness of forecasts to evaluate different kinds of forecasts like point forecasts, band forecasts and probability forecasts. The basic weakness of the forecasting models is also indicated. In the second part some data of the Austrian electricity supply system are given and indications of the planning problems in the short, medium and long term and of the uncertain factors. Coordination, flexibility, diversification and regular revision of expansion programs are some of the answers to uncertainty.

## KEYWORDS

Forecast; probability; demand; preciseness; model; planning; Austria; electricity; supply; system; uncertainty.

## PART 1: SOME PRINCIPAL ASPECTS OF FORECASTING AND DECISION-MAKING

As an introduction some fundamental notions are to be mentioned. The real world is extremely complex. A first step towards a *weltanschauung* would be to divide into the world and the persons as bearers of certain roles. A language is for communication between persons. The words of the language are codes for things and are an appeal to experience and conceptions. The sciences determine domains of the world, as there are economy or energy. On synthesis it is possible that existing relations between the domains are omitted. Specialized languages are used. The domains still are extremely complex. Therefore only certain aspects which are essential for the problems are considered. At first the description of the problem is done verbally. A model comprises only a subset of all aspects. Various domains show common properties as for example electricity, gas and water supply. This leads to

systems theory. One can also speak of systems research. The aspect of language is especially important and systems theory could be justified by the creation of standardized conceptions. The keyword is system. It is possible to speak about a pre-model, a general model or universal model. Systems theory is an interdisciplinary tool, a weltanschauung. Basic terms are system, element, component, hierarchy of systems, organisation, input, output, auxiliaries (resources, capital, personnel), objective function, environment, complementary system. Functional notions applied in supply systems are transport, transformation, storage. Systems exist in time. Besides of a generally spatial dimension the time dimension also has to be regarded: past, presence and future. The notion of process has to be added. Something will be changed within a certain span of time (dynamics of systems). When a system is constructed, components will be added. When a system is operated, the states (of components) are changed. Transitions take place. A system is static only under a certain view. In order to define the task of systems theory in a short way one has to say that systems theory should provide the transition from a verbal description of a problem to a formal (mathematical) model.

Some fundamental operations can be defined when persons are dealing with systems. The operations theory (operations research) lists the following operations:

Identification: Perception and description of components and of the design of the system. Recently, in case of uncertainty, the notion of fuzzy systems has been introduced.

Analysis: Perception and description of processes, that is, the operation of systems.

Prognosis: It is related to the future design of the system and to the future operation of the system (process) or to the input and the output of the system.

Planning: A list of alternatives has to be assumed. As not all can be known about future possibilities, the list of alternatives will always be incomplete.

Decision-making: A choice between several alternative plans has to be made. A sensitivity analysis will support a certain choice.

An analysis of the final decision and plan will end a sequence of such operations which usually are iteratively applied.

Models are a tool of planning and decision-making. Models comprise restrictions on the variables of the problem and an objective function. Models make possible simulations of design and operation of systems. Optimisation is a choice out of many simulations. A sensitivity analysis shows the dependence of solutions on certain parameters. A robust solution would be an interesting result. Knowledge and conscience of the persons participating in these operations (analyst, forecaster, planner, decision-maker) are the foundations for the final decision. A certain subjectivity is always involved.

Data and data collection are also very important. Data collection can be very costly. Availability and accuracy of data can strongly influence model building. A choice can be made between available data. The objective methods of statistical analysis cannot prevent subjective manipulation by selection of data. But also for the models of planning subjective influences cannot be excluded. This may be true

for the choice of restrictions or for the choice of the objective function.

Therefore the acute question of approval and validation of the models always presents itself.

Event and utility are two concepts which are very important in the theory of decision under uncertainty. In the models of electricity supply systems a minimum cost objective function is included (investment and operating costs). Sometimes, outage costs to the economy and even indicators for environmental and health factors are also included. The notion of utility is still discussed in theory and practice. The notion of (uncertain) events and forecasting of future events will be discussed even more. The object of these discussions will be some fundamental considerations which often are disregarded. A forecast is a statement about a future event or about several (mutually exclusive) events only one of which will occur. It is characteristic that the truth of the statement can only be checked in the future. The statement, the next throw of a dice will show a six, can only be checked after the throw and the statement is true or false. The knowledge of the conditions which lead to the throw of a six can only be incomplete. Therefore, it follows that no accurate forecast is possible. This is confirmed especially in case of repetition. This situation leads to an extension of the language, to the introduction of the concept of probability. The statement, the next throw will show a six, is probable and will be assessed by a probability  $p$ . Incomplete knowledge and probability are related and therefore the generally subjective character of probability is understood. A probability theory which to a greater extent takes into consideration the needs of forecasting than the needs of analysis, as it is almost exclusively the case today, would be more valuable. Notions like conditional probability which can be directly related to the notion of conditional forecast or the adaptive theorem of Bayes can be more easily understood in relation to the notion of information. The forecasting of electricity demand should be considered as an example of application. But this should not be a restriction on the considerations. It is necessary and usual to classify forecasts. According to time there are short-term, medium-term and long-term forecasts. The short-term forecast of the load dispatcher reaches from hours to days, eventually to months (maintenance plan). The medium-term forecast of the energy planner reaches from months to several years and is the base for the planning of supply, especially imports and exchanges, for estimation of costs and income and for the consideration of tariffs. The long-term forecast of the energy planner is the base for the investment program for new power stations and the transmission and distribution system, for estimations of resources (primary energy) and extends to a horizon of 10 or 15, eventually 20 or 30 years. Horizons beyond these figures were subjects of sophisticated studies by IIASA. The notion of prognosis generally provokes the question of accuracy which even experts cannot guarantee. Therefore, instead of long-term forecasts the notion of scenarios is now used. An analysis of such long-term forecasts or scenarios should give some idea of the future. According to the kind of statements there are point forecasts, band forecasts and probability forecasts. The latter are given by a probability distribution. Point and band forecasts can also be viewed as probability forecasts. Band forecasts implicitly define a uniform distribution. Point forecasts imply a paradox. As these would have the probability zero, nothing should happen. They would never be true.

This is certainly not the case. In order to avoid this paradox (which obviously could also be done by the use of the mathematical concept of a distribution function) discrete variables defined on intervals will be used. The size of the intervals should be adapted to the problem. A point forecast should be treated like a band forecast (with a small band). The use of discrete variables also allows for the introduction of the notion of entropy which will be used for the definition of the preciseness of a forecast.

The question arises how the planner and decision-maker appreciates these different kinds of statements, for example in case of the electricity demand. A builder of power stations only can be told to build a certain power station or not, but not to build it with a certain probability. Therefore it is clear that the point forecast which could also be denoted as a bold forecast will be preferred by the planner and decision-maker as it is the keenest statement and the forecaster is most strongly bound by his responsibility for accuracy. It has to be stated that in case of the prognosis of electricity demand the investments are already determined to a high degree by the forecast, at least according to quantity. Only the quality has to be evaluated in detail by the planner. Sometimes, it is maintained that only probability forecasts are admissible. It is completely overlooked that especially in case of forecasting electricity demand it is practically impossible to assess a probability distribution. It can only be stated that there is a probability of demand. Beyond this it seems to have been completely omitted that on principle a probability forecast is of a not-binding character and therefore the forecaster is more or less released from his responsibility for accuracy. What is really interesting is the next event, the demand of the next year, but probabilities (of intervals) are given. Any demand is possible. The statement (forecast) is really related to probabilities and not to demand. Probabilities cannot be checked in one step as the measure of probability is the relative frequency in a large number of repetitions. As there is a growth process the character of repetition is missing and therefore probabilities are not measurable. This criticism shows that the concept of preciseness of a forecast (statement) should be introduced and a numerical value should be evaluated. The notion of entropy will be the base of such a measure for forecasts. The notion of entropy is derived from the measure of information. When a probable event occurs, a dice shows six, the observer can transmit the relevant information to a person who knows the forecast. The transient character of information should be emphasized in comparison to knowledge. The value of information can be measured by the probability of the event: The smaller the probability of the event the greater the value of information to the interested person, the greater the surprise. The value of information has additive property. This can be seen when the information to the person is divided into two parts. The first part of the information would be, the dice shows an even number. This partial information induces a new forecast for the possible events according to the theorem of conditional probabilities. Then the second part of the information follows, the dice shows a six. From this it follows without difficulty that the measure of information is  $\log_2(1/p)$ . The (non-negative) entropy is the expectation of the information. In case of the uniform distribution and a given number  $n$  of intervals the entropy  $H$  is  $\log_2 n$ . This is also the maximum value of the entropy. For any other distribution the entropy is smaller. For the point forecast it is zero. The entropy is related to the expected information. For the notion of preciseness of a forecast it should be regarded that for



a greater probability of an event there is a greater expectation that the event will occur and this forecast will be more useful for the user of the forecast. Moreover, a uniform distribution can always be quoted according to the principle of indifference (missing knowledge induces a uniform distribution). Therefore the preciseness  $R$  of a forecast can be defined by  $\lg n - H$ . In case of a uniform distribution  $R=0$  and in case of a point forecast  $R=\lg n$ , the maximum value. From this it follows that it is of no great value to increase the number of intervals beyond a certain level.

Moreover, one should put the question what a decision-maker should do, if he has at hand two forecasts about the same event. In relation to this question there appear notions like expert and trust. Especially the nuclear debate shows the importance of these notions. In case of the existence of two equally ranking forecasts, that is, two probability distributions, one could use the notion of information to escape from the dilemma. Suppose a certain event has occurred. The probabilities were  $p(1)$  and  $p(2)$  according to the two forecasts. There are also two information values. It is obvious that the interested person would prefer to pay only for the information according to the smaller of both information values. This means that the greater of both probability values is assumed to be valid. Thus the adaption of two or more probability forecasts can be made by the acceptance of the maximum of the probability values related to the same event. Finally a factor has to be applied to make the sum of the probabilities equal to 1. It follows that the adaption of the forecasts always is directed to a more uniform distribution.

In general a forecast will not be made for only one future date but for a sequence of dates. The forecast is related to a process (stochastic process). In such a case one also speaks of a model (of a development). For example, in case of a Gaussian (stochastic) process, mean and standard deviation should be given as functions of time. A diagram of a past time-series shows a rather irregular trend still giving the notion of a certain underlying curve, for example a straight line. The deviations of the actual values from this line are thought to be distributed at random (not explained). By the principle of least-square estimation or by stochastic considerations it is possible to evaluate a special curve out of a given class of curves. This is the method of stochastic interpolation. The future development is interesting. In physics given three points of the parabola of a thrown stone, the parabola and its development are determined by the theorems of mechanics (but also under the assumption that the forces will not change or that they are given). There are no such fundamental theorems for the behaviour of persons, especially the future behaviour. Thus the future development of social systems cannot be predicted by extrapolation of the development in the past. Also it is not possible to predict the future development based on the knowledge of other predictions. There is only the conditional forecast: If there is no change in the forces of the development in the past, then the future development will be the continuation of the development in the past. Clearly, this is a permanent source of failures of forecasts. One need not even bring about such striking examples as the crisis of crude oil supply in 1973/74 or the Austrian law of 1979 forbidding the commissioning of the nearly finished nuclear power station near Zwentendorf. Generally, short-term forecasts - the type of model will not be too critical - are of a better quality than long-term forecasts. On the other hand, in case of long-term forecasts there should

be greater chances for an adaption of the forecasts avoiding wrong decisions following a cybernetic analogy while periodically revising the forecasts.

Summarizing, it can be said that in principle there is uncertainty about the future on account of incomplete knowledge. Knowledge is basically related to forecasts and a forecast is only a synopsis of other forecasts. A probability forecast is of a rather non-obligatory character when compared to a point forecast. Taking this point forecast as expectation of a distribution the actual value will deviate from it at random. Remembering the basic property of irregularity of a sequence of stochastic events and the consequent principle of the impossibility of a system of gambling according to R.v.Mises the principle of the impossibility of accurate forecasts could be stated, as the deviations from the model values are at random (not explained) or even the models are doubtful, at least for long-term forecasts.

PART 2: THE ISSUES OF DECISION-MAKING UNDER UNCERTAINTY  
IN THE AUSTRIAN ELECTRICITY SUPPLY SYSTEM

For the better understanding of the Austrian electricity supply system some important data of Austria are given in the sequel. With a few exceptions these data are valid for 1977. According to the constitution of 1920 Austria is a federal state of nine provinces. The population was 7 518 300 in 1977. The gross national product amounted to 790 500 MAS. The total consumption of energy was 806.7 PJ. The following quantities of energy were supplied:

	Austria PJ	%	Import PJ	%	Sum PJ	%
Solid fuel	45.8	14.2	104.5	17.4	150.3	16.3
Liquid fuel	78.6	24.2	399.1	66.4	477.7	51.5
Natural gas	87.2	26.9	88.6	14.8	175.8	19.0
Hydraulic energy	112.5	34.7	8.7	1.4	121.2	13.1
Total	324.1	100.0	600.9	100.0	925.0	100.0

The dependence on foreign supplies amounted to

	Austria %	Import %
Solid fuel	30.5	69.5
Liquid fuel	16.4	83.6
Natural gas	49.6	50.4
Hydraulic energy	92.8	7.2
Total	35.0	65.0

There is a strong dependence on Eastern European countries and on OPEC-countries.

The domestic reserves are (estimates):

Brown coal	116	Mt
Crude oil	22	Mt
Natural gas	14	Gncubicmetre
Hydraulic energy	49.2	TWh/a

For the import of energy 23 847.7 MAS were paid to foreign countries and 3 029.1 MAS was the income from exports of energy (mainly electricity).

The public electricity system shared 87.4% of the total electricity supplies of Austria. According to the Second Nationalisation Act of 1947 which takes into account the federal structure of Austria, the public electricity system comprises the Verbundkonzern (Verbundgesellschaft, special companies, Vorarlberger Illwerke AG), the nine provincial companies, some municipal utilities and other (small) utilities. The state is the proprietor of the Verbundgesellschaft. The fundamental duties of the electric utilities are the reliable supply of electricity to the population at economical tariffs. The electrical energy is distributed by the provincial companies. The provincial companies also construct and operate power plants. The special companies and the Verbundgesellschaft produce and transport electric energy and supply it to the provincial companies. The consumption of electrical energy amounted to 35 020 GWh. The share of domestic consumption was 81.9% and that of export was 18.1%. The high share of exports can be explained by historical and economical reasons and by the fact that there is a very high share of hydraulic energy in the production mix. Besides there are some difficult problems of data collection which cannot be explained in a few words. The share of electricity consumption related to the domestic energy consumption amounted to 15.8%, respectively 12.7% for the domestic electricity consumption only. The supply of 35 020 GWh is shared by

	GWh	%
Hydraulic production	23145	66.1
Thermal production	9491	27.1
Imports	2384	6.8

The hydraulic energy is shared according to type:

Production type	Capacity MW	Average production		Production	
		GWh	%	GWh	%
Run-off river	2068	11698.2	52.4	16302	71.1
Run-off, modulated	888	4480.2	20.1		
Storage, daily	292	919.0	4.1		
Storage, weekly	98	325.5	1.5	6626	28.9
Storage, seasonal	3768	4884.3	21.9		
Total, hydro (without supplies from industrial power plants)	7113	22307.2	100.0	22928	100.0

The thermal production is shared between:

	Capacity MW	Thermal production GWh	%
Brown coal	614.5	1645.5	17.6
Oil/gas (without gas turbines)	1851.0	6729.5	71.8
Base- and intermediate load	2654.9	9243.7	98.6
District heating power plants	189.4	807.6	8.6
Gas turbine power plants	297.0	130.6	1.4
Total, thermal (without supplies from industrial power plants)	2997.8	9374.3	100.0

Pumped storage power plants (with a small storage volume) are of minor importance in Austria. There are pumping installations in several power plants which are used for seasonal storage and/or in a daily cycle of pumping and generation. The total installed pumping capacity amounts to 1124.2 MW.

The electricity demand shows seasonal character. The demand of the winter period (October-March) is higher than the demand of the summer period. Also the hydraulic production shows a seasonal variation even much stronger than the demand. There are important differences between summer and winter, the winter production being smaller than in summer. The consequence is a high share of thermal production and of imports during winter time and hydraulic surplus production in summer time which will be exported or exchanged against imports in winter time. The hydraulic production can strongly deviate from the mean values. These deviations are measured by a production coefficient which is distributed according to empirical probabilities. Other stochastic parameters which determine the necessary reserve and the reliability of supply are the unavailability of power plants, especially of thermal power stations and first of all the demand. It is very difficult to find a probability distribution for the demand. The same is true for the guarantees of imports to be assessed as probabilities. Therefore an analysis of the risk not to meet the demand is very doubtful in terms of probability. During winter time long-lasting periods of low temperature increase the risk of supply outages.

The potential of hydro resources is assessed to 49.2 TWh/a. Thereof 67% are for run-off river and 33% for storage power stations. Presently 50% of the potential are used. At the end of the current planning period of ten years this percentage will be 76% of the total, 85% of the run-off river plants and 57% of the storage plants. For the current planning period the growth rate of demand is assumed to be 5%. After this period there will still be a (reduced) growth of demand. Therefore the question arises how a growing demand could be met in future as Austria has no appreciable resources. The application of nuclear energy is prevented by law and a further increase of imports of electricity seems to be doubtful for reasons of system reliability. Besides, it remains to be doubted that in future there will be enough options for new import contracts at a high level of guarantee.

Before entering on the details of the planning and decision-making process for energy planning (power stations, imports, exports) it will be remarked that the planning of the transmission system faces difficulties in an increasing measure (uncertainty of licences). Also the

problems of short-term planning by the load dispatcher for the scheduling of plants can only be entered upon in a short way. The task of energy planning is to provide the load dispatcher with the means for meeting the actual demand. These are power plants and feasible import contracts. It is up to the decision of the load dispatcher to schedule the operation of power stations and pumps and to make arrangements for exports or imports at short notice or to arrange for the operation of the thermal power stations other than those he is responsible for. The uncertainties which render difficult the task of the load dispatcher are related to demand (weather, television, scheduling of power stations of resellers), hydraulic situation, forced outages of power station and transmission lines. The necessary reserve could be provided by the international interconnected system and by the seasonal storage plants which would take over load during the start-up period of an idling thermal power station. For the control of demand the load dispatchers of the provincial companies could also use the means of peak shaving, that is, the disconnection of certain consumers. As the load dispatcher is aware of the dependence of consecutive states depending on the time elapsed the stochastic element diminishes for him the more, the shorter the period of foresight is chosen. There must always be sufficient reserve to cope with the forced outage of the biggest unit. This will be provided by the seasonal storage power stations which have also to match the biggest variations of the daily load.

The base for the cooperation between the Verbundgesellschaft and the provincial companies are the coordination contracts and also the contracts of the provincial companies for participation in certain power stations of the Verbundkonzern. The coordination contracts refer to the quota of energy which the provincial companies have to buy from the Verbundgesellschaft, to the validity of the tariffs of the Verbundgesellschaft, to the observance of the contractual maximum load during winter time, to the readiness of reserve and to the frequency control by the Verbundgesellschaft. The coordination contracts are also the base for a common forecast of the demand and the planning of the system expansion for a period of ten years. This is done by the coordination committee of the Austrian association of the electric utilities and its experts. On account of many uncertainties of the electricity demand forecast and of the projects (delayed begin of construction and/or delayed commissioning of projects due to the obstruction of various parties for different motivations) the expansion program will be thoroughly revised every one to two years. If an enlarged increase of demand is foreseen, some of the projects of the expansion program will be constructed earlier and in case of a reduced increase the begin of construction will be postponed. Thus the fundamental principle of control is introduced into this dynamic process of planning in order to adapt to the uncertainties. This generally suffices -at least up to now- to maintain the reliability of supply. Whereas for the coordinated expansion planning the system in its entity is investigated (matching of demand, matching of demand separated into base-, intermediate- and peak-load, necessary reserve, base load reserve, reserve at short notice, pumping, exports, imports) the preparation of projects requires intensive and detailed planning. On the level of system planning only recommendations for planning of subsystems (for example storage power plants) can be given which are not binding for a certain project. This means that the individual project can be designed and optimized more or less independent of the system. The projects are prepared by the planning staff of the com-

panies. In the Verbundkonzern reports upon the projects are given by the project council and his experts. The maturity of a project for construction will also be declared by this project council. Expert reports are given upon geological problems, upon the areas influenced by the project (environment), buildings, mechanical and electrical equipment, integration of the project into the system (energy planning) and upon the economy of the project. For multipurpose projects, joint power station projects in border areas political and economical issues and also fiscal and other legal promotions by the state are involved. Therefore the planning and the construction of power stations depend on the state for many aspects.

Energy planning in the medium term cannot be based on power stations on account of their long design and construction periods. To ensure system reliability in the medium term it is necessary to contract for imports or exchange of electric energy (base load in summer time for base load in winter time depending on a certain rate of exchange, peak-load for base-load in the same or in the forth-coming period). This is often done within the framework of existing contracts. On account of the central position of Austria within Europe and on account of a great number of international high capacity transmission tie lines which connect the Austrian electricity supply system to the neighbour systems there are many opportunities for the exchange of electricity. Not only neighbour countries but also countries without common borders like Poland or Roumania had been or are contractual parties of Austria. These import contracts provide manifold options ranging from the guaranteed continuous supply of band energy to the energy offered at random and at short notice and to mutual assistance contracts which have the character of insurances in kind and could be claimed in case of a major event in one of the systems to the best of the abilities of the other contractual parties. As far as there are no events comparable to force majeure which would simultaneously influence all parties which are operating an interconnected bulk power grid these exchange contracts give expectation of high reliability of imports. Thus the principle of diversification reduces the risk of not meeting the demand and contributes to a reliable electricity supply. These contracts as a total imply a high degree of flexibility to adapt to changing situations. Another means which increase the flexibility and reliability of the Austrian system in an especially high degree are the seasonal storage power stations. Austria is rather well equipped with seasonal storage power stations which on account of large energy storage capacity are preferable to pumped storage power stations.

For carrying out its planning the Verbundgesellschaft applies several demand and planning models which at least partially take into consideration the random nature of the future and therefore consider decision-making under uncertainty. A simulation- and optimisation-model based on the principle of dynamic optimisation had been developed. The model is rather detailed. In spite of this the application is limited to general statements. A recent application of this model supplied the result of increasing economy of hydro-power due to rising fuel costs. The result shows a high sensitivity to the rate of interest. A stochastic model for the determination of the necessary reserve incidentally had been applied to evaluate the reliability of a given expansion program or to assess a guaranteed output of the sub-system of thermal power stations. Finally a planning model has to be mentioned which could be called a plan adaption model according to its

application. This model is frequently applied because it considers the knowledge about the system and its components in many details and on a monthly base. Contractual details of demand including the participation contracts of the provincial companies are considered, the extended commissioning time of hydro-power stations with several aggregates (as these aggregates are individually set to operation at certain times the total commissioning time can last longer than one year), import and exchange contracts, seasonal storage, reasonable assumptions about base-, intermediate- and peak-load, pumping, scheduling of storage power stations, hydraulic situation like mean, mean-dry and extreme-dry situation, as well as the scheduling of thermal power stations (under different definitions of the order of merit: fuel costs, priority of kind of fuel) and assumptions about outages. The plan adaption model is implemented on a compact computer. This allows for a flexible and quick application of the model. It is important to be aware of the fact that these models are only an auxiliary means of calculation. They cannot supply automatic decisions.

Referring to decision-making under uncertainty there are several other important factors to be mentioned which scarcely could be evaluated in terms of models and of probabilities:

- The political development in Austria and in the world.
- The economical development in Austria and in the world.
- The problems of resources.
- The technological developments.
- The development of demand (this will be influenced by micro- and macro-decisions, by the behaviour of persons, by voluntary or legal measures).
- The development of costs (capital, personnel, fuel).
- The financial situation (tariffs, capital market, rate of inflation).

Summarizing, it has to be stated that the planning of the Austrian electricity supply system takes place in an environment of growing uncertainty in the short, the medium and the long term. Austria, a small country, not abundant with resources depends on the political, economical and energy developments in the world which also influence the Austrian electricity supply system, directly or by means of its political and economical environment. The incalculable attitude of the politicians and their lack of comprehension for the real energy situation generate this uncertain environment which cannot be predicted. The same is true for a certain press. This causes increased difficulties for the construction and operation of the system. In spite of this uncertain and difficult situation the Austrian electricity supply companies will try their best to fulfil the legal obligation to provide for a reliable and economical supply of electric energy to the population and the economy of Austria.





# DECISIONS UNDER FUZZY STATE DISTRIBUTION WITH AN APPLICATION TO THE HEALTH RISKS OF NUCLEAR POWER

**E. Kofler and P. Zweifel**

*Institute for Empirical Research in Economics, University of Zurich,  
Switzerland*

## ABSTRACT

The traditional theory of decision-making under uncertainty does not allow for the formal incorporation of weak a priori knowledge such as, "Among the three states A, B, and C, A is more likely than B". This can be done using Linear Partial Information (LPI) analysis. Being a natural generalization of uncertainty as a risk, LPI also calls for the introduction of a generalized decision rule, the MaxEmin criterion. The elements of the analysis are combined and put to work in an evaluation of the relative health risks of nuclear power, where information concerning risks is very incomplete indeed.

## KEYWORDS

Decision theory; uncertainty; fuzzy systems; technological assessment; cost-benefit-analysis; nuclear safety; energy supply.

## INTRODUCTION

When faced with an actual decision problem, the economist often finds that his tool kit is incomplete. His advice is most needed and heeded for non-routine decisions. But these are precisely the situations where uncertainty and not risk prevails. This means that information is insufficient to establish a well-defined probability function over the relevant states of Nature. Traditionally, there have been two ways out of this difficulty. Either additional information must be sought or even fabricated with very rough guesses. Or a minimax strategy of complete uncertainty is adopted, which implies throwing away the fuzzy information there may be.

In this paper, we propose a method for evaluating linear partial information (LPI) that allows the analyst to exploit whatever knowledge he has. The basic idea of LPI analysis is that a finite number of different probability functions over states is relevant under conditions of fuzziness (Kofler, 1974; Kofler and Menges, 1976). It constitutes a natural generalization of the concept of uncertainty as a risk (Knight, 1921). In our example, LPI analysis enables a policy-maker to reach a final judgment on the relative health risks of nuclear power, although information

concerning risks is far from complete. LPI analysis therefore emerges as a viable alternative to the theory of fuzzy sets, the applicability of which remains an open question (Zadeh, 1971; Negoita and Ralescu, 1975).

BASIC PROPERTIES OF LINEAR PARTIAL INFORMATION (LPI)

Suppose that an individual is faced with a situation where the outcome of his decision depends on the state of the system that will be realized. Let  $\{\beta_j\}$  ( $j=1, \dots, n$ ) be the discrete set of such states and  $\rho = (p_1, \dots, p_n)$  an arbitrary probability function defined over that set. For  $n = 3$ , the distribution simplex is given by the barycentric triangle ABC in Fig. 1 below.

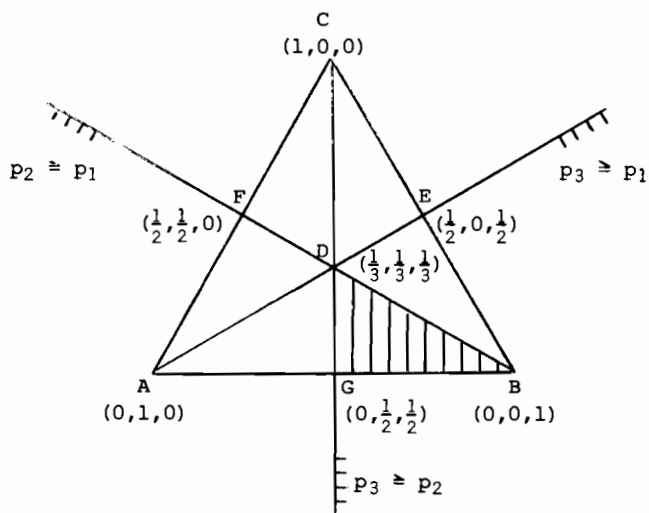

Fig. 1. The distribution simplex and the set of admissible probability distributions  $n = 3$ ;  $LPI(\rho): p_1 \leq p_2 \leq p_3$ .

Now let us assume that there exist linear (equality or inequality) restrictions on  $\rho$ ,  $LPI(\rho)$  for short. For example, consider the weak ordering  $LPI(\rho): p_1 \leq p_2 \leq p_3$ . Then the set of admissible probability distributions is contained by the closed shaded triangular area BDG ( $B(0,0,1)$ ;  $D(1/3,1/3,1/3)$ ;  $G(0,1/2,1/2)$ ).

This geometric representation has of course an algebraic counterpart. The set of points in BDG is equivalent to the set of vectors  $\{\rho\}$  that solve the system of linear inequalities

$$LPI(\rho) = \{ \rho \mid A\rho \leq b, \rho \geq 0, \sum_{j=1}^n p_j = 1 \} . \tag{1}$$

Here, A is a corresponding  $k \times n$  matrix,  $\rho$  a  $n \times 1$  vector, and b, a  $k \times 1$  vector; therefore, (1) contains a total of  $k+n+1$  restrictions. Specifically in the example of Fig. 1, we have

$$A = \begin{bmatrix} 1 & -1 & 0 \\ 0 & 1 & -1 \end{bmatrix} \quad \text{and} \quad b = \begin{bmatrix} 0 \\ 0 \end{bmatrix} . \tag{2}$$

For reasons that become clear below, we are interested only in the vertices BDG in Fig. 1. The algebraic counterparts of these vertex points can be found using

Theorem 1: A solution  $\beta = (\beta_1, \dots, \beta_n)$  to the system of inequalities (1) is a base and hence corresponds to a vertex point iff the variables  $(\beta_1, \dots, \beta_n)$  satisfy  $n$  of the  $k+n+1$  restrictions contained in (1) as independent equations. The restriction  $\sum p_j = 1$  must be among these  $n$  equations.

The proof of this theorem follows immediately from well-known theorems of linear algebra (Hadley, 1961, p.179). Subsequently, such an extreme point will be called an extremal (admissible) distribution. For the example given above, the set of extremal distributions is given by the columns of the matrix

$$M(p_1 \leq p_2 \leq p_3) = \begin{bmatrix} 1/3 & 0 & 0 \\ 1/3 & 1/2 & 0 \\ 1/3 & 1/2 & 1 \end{bmatrix} \quad (3)$$

(D)    (G)    (B)

The letters in parantheses denote the relevant vertices of Fig. 1.

#### THE MAXEMIN PRINCIPLE

In any decision problem, the set of actions  $\{\alpha_i\}$  at the disposal of the decision-maker and the utility matrix  $[u_{ij}]$ , characterizing his evaluation of possible outcomes, must be known for the determination of the optimal choice. If the distribution over states  $\rho$  is not subject to any restrictions, then the decision has to be made under complete uncertainty, and the optimal strategy  $\alpha_{i^*}$  is chosen according to the Maximin criterion:

$$\max_i \min_j u_{ij} = \min_j u_{i^*j} \quad (4)$$

If on the other hand  $\rho$  is fully known, uncertainty in the classical sense of risk prevails, and the almost universally accepted Bernoulli criterion can be applied. The action  $\alpha_{i^*}$  maximizing expected utility is the optimal one:

$$\max_i \sum_{j=1}^n u_{ij} p_j = \sum_{j=1}^n u_{i^*j} p_j \quad (5)$$

Neither of these criteria is satisfactory for the case where a LPI( $\rho$ ) exists. We therefore propose a modification of the Maximin principle. First, calculate expected utility for each admissible probability distribution and each action in the set  $\{\alpha_i\}$ . Second, find the minimal expected value of utility warranted by each action. Finally, choose as  $\alpha_{i^*}$  the action that maximizes the minimal warranted expected utility value. This is the MaxEmin criterion:

$$\max_i \min_{\rho \in \text{LPI}(\rho)} \left[ \sum_j u_{ij} p_j \right] = \min_{\rho \in \text{LPI}(\rho)} \left[ \sum_j u_{i^*j} p_j \right] = v(\alpha_{i^*}) \quad (6)$$

$$\text{with } \rho = (p_1, \dots, p_n) \quad .$$

The right hand side expression in (6) symbolizes the stochastically warranted utility associated with the optimal action  $\alpha_{i^*}$ ; it is very reminiscent of a game's value. In fact, there is a perfect equivalence, established by

**Theorem 2:** Let the matrix  $M(LPI(\rho)) = [\delta^{(1)}, \dots, \delta^{(r)}]$  contain the extremal distributions according to (1). Then the optimal action  $\alpha_{i^*}$  in (6) is identical with the optimal pure strategy of player I in the LPI zero-sum game

$$[\{\alpha_i\}; \{\delta^{(k)}\}; [E(\alpha_i, \delta^{(k)})] = [u_{ij}] \cdot M(LPI(\rho))]. \quad (7)$$

Moreover, this LPI zero-sum game can always be enlarged from the set of pure strategies to the set of mixed strategies, in accordance with the Minimax theorem of von Neumann and Morgenstern.

In the expression (7),  $\{\alpha_i\}$  denotes the set of pure strategies at the disposal of the decision-maker. The set of admissible states of the system is now viewed as the set of strategies of player II, who may be conveniently thought of as Nature. The set of Nature's strategies is given by the set of extremal distributions  $\{\delta^{(k)}, k=1, \dots, r\}$  satisfying the LPI restrictions. The expression  $E(\alpha_i, \delta^{(k)})$  is shorthand for the expected utilities associated with strategy  $\alpha_i$  and state distribution  $\delta^{(k)}$ .

To prove theorem 2 for the pure strategy case, we note that any strategy  $\alpha_i$  guarantees an expected utility given by

$$v(\alpha_i) = \min_{\rho \in LPI(\rho)} [E(\alpha_i, \rho)] \quad (8)$$

According to the MaxEmin criterion, this warranted value is maximized over the set of player I's strategies such that

$$v(\alpha_{i^*}) = \max_i v(\alpha_i) = \max_i \min_{\rho \in LPI(\rho)} [E(\alpha_i, \rho)] \quad (9)$$

But due to the linearity of the expectation operator  $E(\cdot)$  and a fundamental theorem of linear programming (Intriligator, 1971, p. 75), minimization can be confined to the set of extremal distributions  $\{\delta^{(k)}\}$ . Then, player I's decision problem amounts to selecting a pure strategy in the two-person zero-sum game

$$[\{\alpha_i\}; \{\delta^{(k)}\}; [E(\alpha_i, \delta^{(k)})]; i=1, \dots, m; k=1, \dots, r] \quad (10)$$

Finally, it is easy to see that the payoff matrix is given by

$$[E(\alpha_i, \delta^{(k)})] = [\sum_j u_{ij} \hat{p}_j^{(k)} \mid \delta^{(k)} = (\hat{p}_1^{(k)}, \dots, \hat{p}_n^{(k)})] = [u_{ij}] \cdot M(LPI(\rho)) \quad (11)$$

This completes the proof. The game (10) must always be generalized to include mixed strategies, as required by the Minimax theorem of von Neumann and Morgenstern. However, the strategy necessarily is of the pure type in situations involving risk only. In that case,  $\{\delta^{(k)}\}$  shrinks to a single element, i.e.  $M(LPI(\rho))$  in (11) contains but one column.

#### EVALUATING THE RELATIVE HEALTH RISKS OF NUCLEAR POWER

Nuclear power from light water reactors (LWR) and coal will be the two most important sources of energy in the intermediate future. Public debate has been focused on the health risks of nuclear power, with less concern for the loss of lives associated with the mining and combustion of coal. For simplicity, we disregard the issues relating to the economic costs of foregoing the LWR alternative as well as the issues relating to radioactive waste, proliferation of nuclear weapons, and nuclear terrorism. They have been analyzed by the Nuclear Energy Policy Study Group (Keeney, 1977); their work will be referred to as the NEG report. For all its great merits, this

report fails to reach a final judgment on the relative health risks of coal and LWRs. On the one hand, emphasis on the consequences of an extremely serious LWR accident suggests application of the Minimax rule (pp. 224-226). This, however, would unconditionally favor coal as long as a major LWR accident remains an albeit remote eventuality. On the other hand, the risk data on LWRs gathered so far are of rather low reliability. This becomes evident from a comparison of the NEG calculations with those of the earlier Rasmussen report (Nuclear Regulatory Commission, 1975, RAS for short). The RAS report is criticized for averaging risks over different sites, without distinguishing between serious and catastrophic consequences ( $q_2 = q_3$  in Fig. 2). But then, a similar averaging procedure is still adhered to by the NEG when assessing the health impact of coal-fueled power plants.

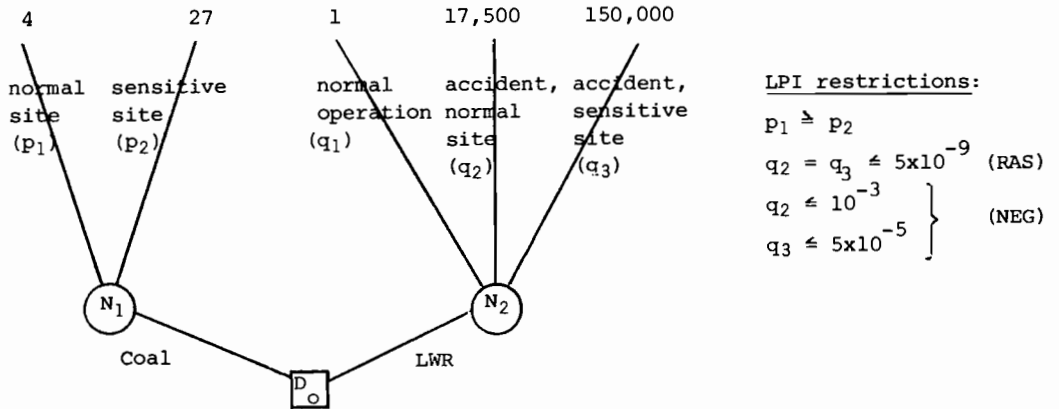

Fig. 2. The risks of coal and LWR (discounted human lives per 1000 MWe of energy and year)  
Sources: For the payoffs, see appendix. For the restrictions, NEG report (1977, pp. 226, 230, 231).

These deficiencies can be remedied by LPI analysis. The upper bound of 27 fatalities per 1000 MWe and year for coal in Fig. 1 was obtained from electricity generation plants in the New York metropolitan area (NEG report, 1977, pp. 190-194). For the U.S. as a whole, the probability of operating at such sensitive sites is certainly smaller than one-half. Since additional information seems to be lacking, we introduce the LPI:  $p_1 \cong p_2$  as in Fig. 2. Applying theorem 2, we immediately obtain the matrix of extremal distributions

$$M(p_1 \cong p_2) = \begin{bmatrix} 1 & 0.5 \\ 0 & 0.5 \end{bmatrix} . \tag{12}$$

For simplicity, we proceed to determine the optimal pure strategy only, calculating the vector of expected losses:

$$E(\alpha_1, \rho) = [4, 27] \begin{bmatrix} 1 & 0.5 \\ 0 & 0.5 \end{bmatrix} = [4, 15.5] . \tag{13}$$

Should the decision be made in favor of coal, then the stochastically warranted maximum loss (minimal utility) is 15.5 per 1000 MWe and year.

In contrast, the health impact of nuclear power is small as long as operation of the LWR is normal. In the event of a core meltdown followed by a breach of containment, up to about 100,000 prompt fatalities must be reckoned. Delayed deaths are estimated to occur over a period of 30 years at a rate of 1500 per 1000 MWe and year; for details, see the appendix. At a discount rate of 10% p.a., this amounts to a present value of 150,000 lives. If, however, the reactor were located at a site of only average population density, this figure is much lower (17,500, cf. Fig. 2). Now let us first assume that the findings and assumptions of the RAS report (1975) are correct. Then we have

$$E(\alpha_2, \beta_{RAS}) = [1, 17,500, 150,000] \begin{bmatrix} 1 & 1-10^{-8} \\ 0 & 5 \times 10^{-9} \\ 0 & 5 \times 10^{-9} \end{bmatrix} = [1, 1.0008] \quad (14)$$

At worst, the expected loss of lives is about 1 as compared to 15.5 in (13). Under the MinEmax criterion and disregarding aspects other than health-related ones, we would therefore unambiguously opt for the LWR alternative. This was also the conclusion of the RAS report, and the NEG, lacking a formal evaluation procedure for fuzzy information, did not think that their criticisms would change it (NEG report, 1977, p. 196). However, introducing the revised NEG risk estimates given in Fig. 2, we obtain

$$E(\alpha_2, \beta_{NEG}) = [1, 17,500, 150,000] \begin{bmatrix} 1 & 1-10^{-3} & 1-10^{-3}-5 \times 10^{-5} \\ 0 & 10^{-3} & 10^{-3} \\ 0 & 0 & 5 \times 10^{-9} \end{bmatrix} \\ = [1, 18.5, 26] . \quad (15)$$

Again applying the MinEmax criterion, we would now have to opt for coal, with a stochastically warranted maximum loss of 15.5 lives per 1000 MWe and year. Space limitations preclude determination of the optimal mixed strategy. However, the resulting decision rule, "choose coal with probability P and LWR with probability (1-P)" would have practical relevance, fixing the optimal share of nuclear power in total energy supply with regard to the health risks involved. Such a conclusion goes far beyond the endeavors of the NEG report but becomes possible with LPI analysis. In passing, we note that fuzzy information concerning the relative credibility of the RAS and NEG estimates could also be incorporated in the evaluation along similar lines (Kofler and Menges, 1976, pp. 111-112).

Assuming the NEG corrections to the RAS estimates to be true, we may approximate the value of the new information. Following Marschak (1971), it is given by

$$v(\beta_{NEG}) - v(\beta_{RAS}) = -15.5 - (-26) = 10.5 , \quad (16)$$

i.e. the difference between the values of the two LPI games. The calculated saving of 10.5 lives per 1000 MWe and year is an approximation because only pure strategies have been considered. We tentatively conclude that since LWRs under construction or on order in the U.S. amount to a total capacity of 170,000 MWe, the information contained in the reassessment of risk by the NEG is worth 1785 discounted lives per year. According to a study by Jones-Lee (1976, p. 150), an adult values his life at some 6 million dollars. The total value of information would therefore amount to about  $10^9$  dollars per year - sufficient for financing many more large-scale investigations into the economics of energy ...

SUMMARY AND CONCLUSION

This paper presents a new tool for exploiting linear partial information (LPI) in an arbitrary decision problem. While the traditional theory of decision under risk admits of one single state distribution only, a set of admissible probability distributions is derived. In a second step, this set is reduced and made finite. Fuzziness regarding the set of actions at the disposal of the decision-maker, the payoffs associated with actions, and the credibility of partial information itself can also be modeled. These generalizations of LPI analysis, not reported here, are relevant to the energy debate because e.g. alternative sources of energy may become economically efficient, depending on choices made now. Hence, the set of strategies is fuzzy (Kofler and Zweifel, 1979). The transition from risk to uncertainty calls for the introduction of a generalized choice criterion to replace the maximization of expected utility. The new MaxEmin rule leads to a warranted minimal expected payoff. It also enables the decision-maker to assess the value of low-quality information that had to be disregarded in traditional decision theory. In an illustrative application of LPI analysis to the energy choice problem, it is shown how risk estimates of a fuzzy nature can be exploited to derive a clear-cut recommendation for action.

APPENDIX

TABLE 1 Health Impacts of Coal and LWRs (in terms of Human Lives, per Year and 1000 MWe Energy Produced)

	State independent		State dependent			Discounted total		
	Min- ing	Trans- port- ation	Pollution (Coal) Radiation (LWR)			30 years 10% discount rate		
Coal	0.5	1.3	(p <sub>1</sub> ) 2	(p <sub>2</sub> ) 25		(p <sub>1</sub> ) 2	(p <sub>2</sub> ) 25	
LWR	1.0	0.0	(q <sub>1</sub> ) 0 +0/yr	(q <sub>2</sub> ) 3300 +1500/yr	(q <sub>3</sub> ) 104,400 +4740/yr	(q <sub>1</sub> ) 0	(q <sub>2</sub> ) 17,500	(q <sub>3</sub> ) 150,000

Sources:

Coal NEG report (1977, pp. 187, 188, 196).  
 LWR NEG report (1977, pp. 186, 224, 227-229). The entries for the catastrophic accident (q<sub>3</sub> in Table 1) are based upon the following criticisms leveled at the RAS estimates (p. 228):  
 "The (Rasmussen) report essentially averages conditions over sixty-eight sites, ignoring the high correlation of meteorological conditions and population densities at several sensitive sites ... In fact, the assessments of prompt casualties are averages of individual situations that may differ by as much as factors of 100 or 1000. Latent casualties will also vary, but by a smaller amount". The case q<sub>2</sub> corresponds to

these RAS averages. For the case  $q_3$ , we increased the number of instantaneous fatalities by a factor of  $1000^{1/2}$  and the yearly loss rate by a factor of  $10^{1/2}$ .

#### REFERENCES

- Hadley, G. (1961). Linear Algebra. Addison-Wesley, Reading, Mass.
- Intriligator, M. D. (1971). Mathematical Optimization and Economic Theory. Prentice-Hall, Englewood Cliffs, N.J.
- Keeney, S. M. (1977). Nuclear Power. Issues and Choices. Report of the Nuclear Energy Policy Study Group. (NEG report in the text). Ballinger, Cambridge, Mass.
- Knight, F. H. (1921). Risk, Uncertainty, and Profit. Houghton Mifflin, New York.
- Kofler, E. (1974). Entscheidungen bei teilweise bekannter Verteilung der Zustände. (Decisions under partial knowledge of the state distribution). Zeitschrift für Operations Research, 18, 141-157.
- Kofler, E., and G. Menges (1976). Entscheidungen bei unvollständiger Information. (Decisions based on Incomplete Information). Lecture Notes in Economics and Mathematical Systems, 136. Springer, Berlin.
- Kofler, E., and P. Zweifel (1979). Decisions under fuzzy state distribution, with an application to the health risks of nuclear power. Working paper 7902. Institute for Empirical Research in Economics, University of Zurich.
- Jones-Lee, M. W. (1976). The Value of Life. An Economic Analysis. Martin Robertson, London.
- Marschak, J. (1971). Economics of information systems. In Intriligator, M. D. (ed.), Frontiers of Quantitative Economics. North Holland, Amsterdam, pp. 32-107.
- Negoita, C. V., and D. A. Ralescu (1975). Applications of Fuzzy Sets to Systems Analysis. Halsted, New York.
- Nuclear Regulatory Commission (1975). Reactor Safety Study. (RAS report in the text). Document WASH-1400, U.S. Government Printing Office, Washington, D.C.
- Zadeh, L. A. (1971). Similarity relations and fuzzy orderings. Information Sciences, 3, 177-200.



# THE EFFECT OF UNCERTAINTIES ON ESTIMATES OF THE ECONOMIC BENEFIT OF INTRODUCING ALTERNATIVE REACTOR TYPES INTO AN ELECTRICITY GENERATION SYSTEM

**C. Scrogg**

*Risley Nuclear Power Development Establishment, United Kingdom Atomic Energy Authority, Risley, Warrington, Cheshire, UK*

## ABSTRACT

One way of assessing the economic advantage of a nuclear station is to determine the financial benefits from incorporating stations of that type into a computerised model of the electricity generating system. Such a model will give the number of stations of the different types installed at different times, partly as a result of input data and partly as a result of imposed conditions. The computer code could then be used to calculate the present worth of expenditure on the system so that if the calculation is repeated with one type of station replaced by another the economic benefit of this replacement can be determined. However, uncertainties in factors affecting expenditure and capacity commissioned introduce uncertainties in the total system expenditure and therefore in any estimate of the economic benefit of one strategy over another. A computer code, RISKAN, has been developed which carries out a large number of system benefit calculations for a pair of alternative strategies, each calculation incorporating perturbations in some or all of a set of items of input data (ie fabrication costs, capital costs, generating system growth rate, reactor introduction date, etc); the perturbations are selected individually from freely specified frequency distributions. The set (order 10,000) of results is then processed to determine the frequency distribution of the cost benefit and to indicate the probability of exceeding different levels.

## KEYWORDS

Nuclear strategy; economic benefits; economic uncertainties; RISKAN; DISCOUNT; MONTE CARLO.

## INTRODUCTION

With a suitable choice of input data the computer program DISCOUNT (Iliffe, 1973) can be used to obtain the total discounted expenditure associated with a particular reactor commissioning pattern and therefore to compare the cost benefits of one pattern over another. Initially the reactor commissioning pattern is determined to meet a given long-term programme of electricity demand, the different types of reactors commissioned at different times depending partly on the input data and partly on imposed constraints.

Uncertainties in factors affecting expenditure (eg cost data) and affecting capacity commissioned (eg system parameters, policy decisions) introduce uncertainties in the system expenditure and therefore in the estimate of the cost benefit of one commissioning programme over another. It is therefore important to assess the range of confidence which might be ascribed to a given estimate of system cost benefit. Some estimate can be made of this uncertainty by the repeated application of the DISCOUNT program using suitably perturbed values in the input data, but the interpretation of the results is usually difficult and the practical difficulties of carrying out a sufficiently detailed study are prohibitive. A computer program, RISKAN, has therefore been developed to estimate with a high degree of precision, and with a reasonable expenditure of computing time, the uncertainties in system benefits which would arise due to uncertainties in constituent items.

#### DEVELOPMENT OF EQUATIONS

The cost benefit of one commissioning pattern over another is simply expressed as: Cost benefit = (Expenditure with Pattern A) - (Expenditure with Pattern B) and therefore

$$\delta (\text{Cost benefit}) = \delta [(\text{Expenditure with Pattern A}) - (\text{Expenditure with Pattern B})] \quad (1)$$

Thus, to find the "uncertainty" in cost benefit (ie possible range of variation) due to the uncertainty in a variable X, we have to evaluate the expenditures for each pattern for a selection of values of the variable X and examine the distribution of the cost differences. This is essentially the basis of the method developed in the RISKAN computer program.

The discounted expenditure of a particular commissioning pattern is given by the expression

Discounted expenditure =

$$\begin{aligned} & Q \sum_k \left\{ \sum_{t=D1}^{D3-n_k} N_k(t) \left( \frac{1}{1+r} \right)^{t-D2} IV_k(t) \right. \\ & + \sum_{t=D1}^{D3-n_k} N_k(t) \left( \frac{1}{1+r} \right)^{t-D2} FV_k(t+n_k) \left( \frac{1}{1+r} \right)^{n_k} \\ & + \sum_{t=D1}^{D3-n_k} N_k(t) \left( \frac{1}{1+r} \right)^{t-D2} l_{nk} OC_k(t) \\ & + \sum_{t=D1}^{D3-n_k} N_k(t) \left( \frac{1}{1+r} \right)^{t-D2} \sum_{m=1}^{n_k} \frac{L_k(t+m)RC_k(t+m)}{(1+r)^m} \\ & \left. + \sum_{t=D1}^{D3-n_k} N_k(t) \left( \frac{1}{1+r} \right)^{t-D2} \sum_{m=1}^{n_k} \frac{L_k(t+m)HV_k(t+m)r}{(1+r)^m} \right\} \quad (2) \end{aligned}$$

where  $N_k(t)$  = Number of stations of type k commissioned at time (date) t.

$L_k(t)$  = Annual load factor of stations of type k at time t.

r = Discount rate.

$IV_k(t)$  = Initial value of stations of type k commissioned at time t.

$FV_k(t)$  = Final value of stations of type k withdrawn at time t.

$OC_k(t)$  = Fixed operating cost of stations of type k commissioned at time t.

$RC_k(t)$  = Variable running cost of stations of type k at time t.

$HV_k(t)$  = Hold up value of stations of type k at time t.

Q = Full load electrical output/station.

$n_k$  = Lifetime of stations of type k.

$l_{nk}$  = Discounted lifetime for stations of type k.

D1 = Date of start of study.

D2 = Date to which quantities are discounted.

D3 = Date of last year of study.

and the summation is over all reactor types and over all the years covered by the study with the proviso that no station is commissioned within the period  $D_3 - n_k$  to  $D_3$ .

Writing the above expression for simplicity, in the form

$$\text{Discounted expenditure} = \sum_k (A_{1k} + A_{2k} + A_{3k} + A_{4k} + A_{5k}) \quad (3)$$

then the perturbed value of the discounted expenditure (DE) due to some uncertainty in the system is

$$(DE + \delta DE) = \sum_k [(A_{1k} + \delta A_{1k}) + (A_{2k} + \delta A_{2k}) + (A_{3k} + \delta A_{3k}) + (A_{4k} + \delta A_{4k}) + (A_{5k} + \delta A_{5k})]$$

Assume that the uncertainty in some variable X introduces uncertainties in the items of cost data. Consider the component of discounted expenditure which corresponds to the initial value (IV) of the kth reactor type; then

$$\begin{aligned} (A_{1k} + \delta A_{1k}) &= Q \sum_{t=D1}^{D3-n_k} N_k(t) \left( \frac{1}{1+r} \right)^{t-D2} \left( IV_k(t) + \delta IV_k(t) \right) \\ &= Q \sum_{t=D1}^{D3-n_k} N_k(t) \left( \frac{1}{1+r} \right)^{t-D2} IV_k(t) \left( 1 + \frac{\delta IV_k(t)}{IV_k(t)} \right) \end{aligned}$$

When the uncertainty in IV is independent of time

$$\begin{aligned} (A_{1k} + \delta A_{1k}) &= \left( 1 + \frac{\delta IV_k(D1)}{IV_k(D1)} \right) Q \sum_{t=D1}^{D3-n_k} N_k(t) \left( \frac{1}{1+r} \right)^{t-D2} IV_k(t) \\ &= \left( 1 + \frac{\delta IV_k(D1)}{IV_k(D1)} \right) A_{1k} \\ &= M_{1k} A_{1k} \end{aligned}$$

$\delta A_{1k}$  and  $M_{1k}$  take up a range of values corresponding to the distribution of uncertainty in  $X$ . Thus  $M_{1k}$  can be interpreted as a factor multiplying  $A_{1k}$  and distributed according to some frequency distribution about a mean value  $\bar{M}_{1k}$  which would generally, but not necessarily, be equal to 1. This distribution will be represented as  $D_{1k}(\bar{M}_{1k}, \sigma_{1k})$  and although in general it might approximate to a GAUSSIAN distribution there are no restrictions as to the form it may take. Realising that the IVs may be made up of several component parts, each of which have different uncertainties associated with them, the last equation can be generalised to

$$\begin{aligned} (A_{1k} + \delta A_{1k}) &= \sum_i M_{ilk} (C_{ilk} A_{1k}) \\ &= A_{1k} \sum_i C_{ilk} M_{ilk} \end{aligned}$$

where the  $C_{ilk}$ 's are the fractional contribution of the commodities  $i$  to the total  $A_{1k}$  such that

$$\sum_i C_{ilk} = 1.0$$

However, uncertainties in some variable  $X$  may well affect a number of components of discounted expenditure and thereby introduce uncertainties in them which show some degree of dependence (ie correlation). To allow for this type of dependence between uncertainties the expression is extended to the form

$$(A_{1k} + \delta A_{1k}) = A_{1k} \sum_i C_{ilk} K_i K_{ilk} \tag{4}$$

where  $K_i$  is distributed as  $D_i(\bar{K}_i, \sigma_i)$  and  $K_{ilk}$  is the same for the  $i^{\text{th}}$  fraction of all the station type costs of both commissioning patterns.

The  $K_{ijk}$  distributions are specified for each of the station types ( $k$ ) in each strategy, for each of the 5 cost components ( $j$ ) and for each of the commodities ( $i$ ) entering into them. They will be referred to as the commodity quantity uncertainty factors. The 5 cost components IV, FV, OC, RC, HV are denoted by  $j = 1, \dots, 5$ .

$$K_{ijk} \text{ is distributed as } D_{ijk}(\bar{K}_{ijk}, \sigma_{ijk})$$

This formulation, with a suitable choice of the  $C_{ijk}$ , enables the effects of uncertainties in the component parts of the cost data to be studied individually, or collectively.

The discounted system expenditure appropriate to a given commission programme can be expressed in the general form

$$\text{Discounted system expenditure} = \sum_i E_i C_i$$

where  $E_i$  = Discounted capacity commissioned (GWe)

$C_i$  = Discounted expenditure/unit of discounted capacity (eg £M/GWe) and the summation is over all the station types commissioned.

So far the effect of uncertainties in  $C_i$  have been considered. We next consider those variables whose uncertainties influence the discounted system expenditure through their effect on the discounted capacity commissioned. Let  $z_1, \dots, z_m$  represent a set of such variables. Then, for a specified set of cost data, we can write

$$A_{jk} = G_{jk}(z_1, \dots, z_m)$$

where  $G_{ijk}(z_1, \dots, z_m)$  represents some function of the  $z$ 's and  $A_{jk}$  are the components of discounted expenditure referred to above.

Then, including cost data uncertainties,

$$A_{jk} + \delta A_{jk} = G_{jk}(z_1 + \delta z_1, \dots, z_m + \delta z_m) \sum_i C_{ijk} K_i K_{ijk} \quad (5)$$

This is the equation used in RISKAN to generate the perturbed values of  $A_{jk}$  corresponding to uncertainties in the data. In the program the  $G_{ijk}$  have been restricted to the sum of several linear relationships and one quadratic as follows:

$$G_{jk}(z_1, \dots, z_m) = a + bz_1 + cz_1^2 + \sum_{i=2}^m d_i(z_i - z_{Ri})$$

where  $a, b, c, d_i$  are coefficients to be determined to give the required relationships and the  $z_{Ri}$  are reference (ie datum) values of the  $z_i$ .

Typically  $z_1$  might be  $E$ , the discounted capacity commissioned, whilst the remaining  $z_i$  cover such variables as the date of, and rate of introduction of fast reactors,  $Pu$  reprocessing delay,  $Pu$  loss, etc.

#### CALCULATION METHODS

It is convenient to consider first the calculation of the effect of cost uncertainties only. Sufficient information from DISCOUNT runs is entered into the program to allow for the calculation of the  $A_{jk}$  as defined in Equation 2 for each station type and commissioning pattern. The 5 cost components, IV, FV, RC, OC and HV are each divided into at most 5 fractions, representing, for example, the contributions of capital costs, fabrication costs, uranium value etc, by associating multipliers ( $C_{ijk}$ ) with each which usually, but not necessarily, total to unity; associated with each of these fractions are "uncertainty" distributions  $K_{ijk}$  and  $K_i$ . To allow for long-term changes the  $K_i$  and  $K_{ijk}$  may be completely re-specified at any 2 dates during the period under study. The  $K_{ijk}$  and  $K_i$  distributions are expressed in the form of cumulative probability distributions where the chance of getting a value of the variable less than, or equal to, a given value is represented on a scale from 0 to 100. Each distribution is represented by up to 21 pairs of "x, y" values so that a wide range of distributions can be represented reasonably accurately. In particular there is no restriction to distributions of a particular form (usually Gaussian) as is often the case in

analytic methods. Random numbers between 0 and 100 are generated by the computer and, by linear interpolation within the pairs of "x, y" points, the corresponding random values of the uncertainty are obtained. It is a feature of this method of sampling that repeated application generates the form of the original frequency distribution of the variables. If an uncertainty distribution is assumed to be exactly normal then it is only necessary to indicate this by the appropriate marker in the code and input the mean and standard deviation of the distribution. Provision is also made for a variable to be specified at any desired constant value, if this is appropriate. The use of the last 2 facilities significantly reduces computer running time.

For the non-zero elements of each  $C_{ijk}$  matrix random values of  $K_i$  and  $K_{ijk}$  are selected from the appropriate distributions. The perturbed values of  $A_{ijk}$  as calculated using Equation 4 are then summed over station types to give the perturbed expenditures for each commissioning pattern. The difference between the 2 expenditures gives the perturbed value of system cost benefit (Equation 1). This procedure is repeated until a satisfactory representation of the distribution of uncertainty in cost benefit has been set up. Provision is made for up to 10 "blocks" of samples to be taken, the number of samples within each "block" being unlimited. The first hundred sample values are used to set up a histogram to represent the distribution of both those values, and subsequent values, as they are generated. The overall mean and standard deviation of the expenditures associated with each commissioning pattern, and of the system cost benefits, are calculated as each sample block is completed.

At the end of each sample block the updated histogram is processed to determine values corresponding to a number of percentage points of the distribution thus providing extra information which is particularly useful when the resulting distribution is non-normal. A simple test of convergence is carried out on the standard deviation calculated at the end of each sample block and this may be used to terminate the calculation.

Consider now those factors such as programme size, reactor type introduction date and early installation rate, etc which may introduce uncertainties in system cost benefit through the effect of their uncertainties on the precise manner in which electrical demand is satisfied. The approach adopted in RISKAN is to determine the appropriate  $A_{ijk}$ 's from a library of cases in the form of DISCOUNT results. For example, 3 values of programme size could be studied using the DISCOUNT code and the results entered into RISKAN together with the probability levels assigned to each of the 3 programmes and some quantitative measure of programme size, (eg discounted capacity commissioned; total number of stations installed at a given date). The  $A_{ijk}$  are then calculated from the data for each station type, of each commissioning pattern, at each programme size, and quadratic curves fitted to them within the code. In a similar way the effects of uncertainties in up to 4 more variables can be considered in a simple linear relationship, each variable requiring 2 sets of DISCOUNT results to provide the necessary information to determine the coefficients. As in the case of the  $K_i$  and  $K_{ijk}$ , numbers between 0 and 100 are selected at random to give corresponding random values of the programme size and each of the other variables. The values of  $A_{ijk}$  are then determined by substitution in the quadratic and linear expressions.<sup>jk</sup> At each selection the perturbation due to uncertainties in the cost data are incorporated as in Equation 5. The results are tabulated in histogram form and processed as described above in the treatment of cost uncertainties.

#### APPLICATION

The RISKAN approach has been used to assess the uncertainties in the economic benefits of introducing a fast reactor type into an otherwise all-thermal nuclear

strategy which forms part of an electricity generating programme. The study was confined to the variables listed below.

TABLE 1 List of Variables

Variable	Level	
Fast Reactor Capital Costs	£/kw	standard, ± 50 (quartiles)
Fast Reactor Core Fabrication Costs	£/kg	standard, ± 30 (quartiles)
Fast Reactor Breeder Fabrication Costs	£/kg	standard, ± 5 (quartiles)
Fast Reactor Introduction rate (in first 9 years)	GWe	8.75, 18.75
Uranium Ore Scale	\$/lb U <sub>3</sub> O <sub>8</sub>	standard, high
Fast Reactor plutonium held in residues	%	standard, standard + 3
Delay in fast reactor reprocessing cycle	months	standard, standard + 3
Fast Reactor Introduction date	years	reference, reference + 10

The first 3 variables affect only the system expenditure and were taken to be normally distributed about the standard values, with the given quartiles. The remaining variables, with the exception of ore price, affect the fast reactor capacity commissioned and DISCOUNT calculations were carried out at each of the levels given above in order to generate the necessary input data for RISKAN.

For each variable studied an assumption was made of its likely range of uncertainty. These were firstly expressed in terms of plausible probability distributions which were then processed into the inverse cumulative probability distributions required by the program.

The results of applying the RISKAN program to the data are summarised in Table 2 in terms of the percentage points of the distributions of fast reactor benefits as each new variable is introduced in turn; the benefits have been calculated using a 10% discount rate.

TABLE 2 The Effect of Additional Sources of Uncertainty on Fast Reactor Benefits (£M)

Variable	Percentage Points of Distribution of Fast Reactor Benefits %				
	2.5	25	50	75	97.5
Costs	7630	5610	4540	3470	1460
+ FR Introduction Rate	7840	5550	4380	3250	1150
+ Ore Price	8130	5790	4560	3370	1240
+ FR Pu in Residues	8130	5760	4560	3380	1240
+ FR Pu Delays	7990	5590	4430	3340	1340
+ FR Introduction Date	7000	4860	3790	2800	1070

The above values for each variable are based on between 12,000 and 24,000 sample values, at which stage the accuracy at which the percentage points of the distribution were determined was judged to be adequate; generation of such sample sizes take of the order of 30 minutes on an ICL 472 computer.

It can be seen that with the cost uncertainties assumed, and before considering variations in other variables there is a 97.5% chance that the discounted fast reactor benefit will be greater than £1460M and a small chance (2.5%) of it being as high as £7600M. As each additional source of uncertainty is introduced there is a variation in the spread of the distribution of benefit and a shifting in the general level (Fig. 1). The inclusion of uncertainties in fast reactor introduction rate, ore price, plutonium held in residues and plutonium delays result in only relatively small changes to the distribution. However, uncertainties in the fast reactor introduction date are much more serious, reducing the general level of economic benefit by about £700M and reducing the probability that an economic benefit will be achieved. It is seen that the most likely benefit has been reduced from about £4500M to around £3800M with a 25% chance of the benefit being more than £4869M.

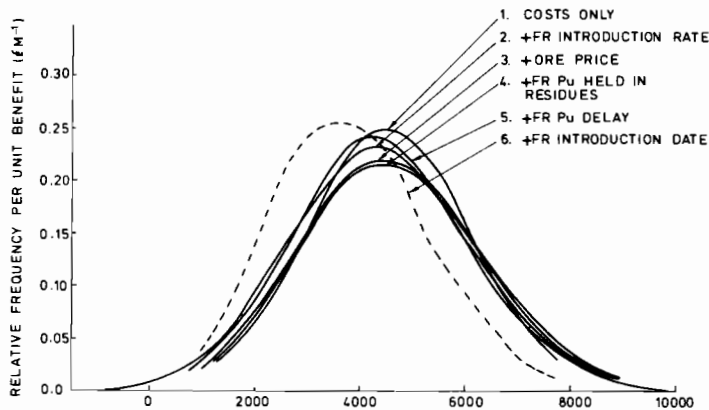

Fig. 1 Distribution of discounted fast reactor benefits (£M)

#### SUMMARY

A computer program has been described which relies on the repeated sampling of freely specified probability distributions to generate fluctuations in, and therefore a distribution of, possible values of the economic benefits of introducing particular reactor types into an electricity generating system. The importance of particular variables can be easily investigated, as can the effect of various assumptions about the possible distribution of their uncertainties.

The example which has been given above, the levels of the variables considered, and their effect on benefits are purely illustrative for the purpose of this presentation.

#### REFERENCE

Illiffe C E (1973). Discount G - a digital computer code for assessing the economics of nuclear power. TRG Report 2285(R). HM Stationery Office, London.



# DISCUSSION AND DECISION IN THE CASE OF POWER PLANT OBERJÄGERWEG IN WEST BERLIN. MODELS, EXPERIENCE, CONCLUSIONS 1976-1978

H. Maier

*Fachhochschule für Wirtschaft Berlin und Institut für Stadt-und Regionalplanung,  
Technische Universität Berlin, Berlin (West), Federal Republic of Germany*

Abstract. The paper contains items of the decision process of a power plant in West Berlin the realization of which was stopped in 1977. It shows that mathematical models for energy demand and supply have no high priority in the whole decision process, which is a game between institutions and persons inside and outside of public administration. The conflict *cutting about 35000 trees to provide more energy for the eighties* versus *keep the trees to provide good air* was solved by law-court. Result: Keep the trees and provide more energy. Consequence: Population in central districts has to suffer more pollution in the air.

Keywords. Air pollution; decision theory; environment control; game theory; modelling; pollution; social and behavioural sciences; urban systems.

## GOALS

Object of this paper is to examine the so-called power plant *Oberjägerweg* in West Berlin, a power plant which has been planned until 1976 but for which realization was stopped in 1977.

First goal is to show that models for energy demand and supply are only one element in the field of planning power plants. They appear in the planning phase of a power plant in the form of expert opinions. Their effect should not be overestimated, because for each expert opinion there will exist a different one.

Second goal is to show that the whole administrative process leading to the realization of a power plant is one

which can well be modeled by means of systems analysis. In the past this has not been done to the extend possible. There is no reason why it should not be done, because the rules laid down for public administrations (on national level) are laid down in written form. The persons, groups, departments of public administration, and law-courts which have to co-operate are clearly defined; their interests may be in opposition.

The power plant *Oberjägerweg* is an example which shows how the different administrative levels and groups may act and react in the Federal Republic of Germany to provide or to prevent the realization of a particular power plant. It is not an atomic power plant and therefore the dis-

discussion is free from many of the emotional arguments usually found in those projects. On the other hand, it is my hypothesis that the problems of attaining special investments in the energy sector are the same. To make this hypothesis plain is the third goal.

#### APPROACH

The approach used to verify the three goals in this report is the following: The main part of the paper contains items of the discussion and decision process as they appeared in the newspapers in West Berlin. For simplification there were taken abstracts and excerpts from about 150 articles of the newspaper *DER TAGES-SPIEGEL*, given with the date of issue. Those articles which refer to atomic power plants and to general energy development in West Germany will not be used in this presentation. The whole period of planning and decision is also restricted to the period *October 1976 to February 1978*, when the main decisions and conflicts occurred.

#### PARTICIPANTS

Participants were: the senate of West Berlin as government and as administration; the political parties represented in the parliament in West Berlin, Social Democratic Party (SPD), Free Democratic Party (FDP), Christian Democratic Union (CDU); the government - a coalition between the SPD and the FDP; the parliament and its fractions and committees; the Berlin Power and Light Cooperative (BE-WAG); the trade unions; experts on energy demand and supply; single citizens and citizen groups; law-courts, Verwaltungsgericht (VG) and Oberverwaltungsgericht (OVG); and the Allied of the western sectors of Berlin.

#### LOCAL SITUATION AND RESULT OF DECISION PROCESS

Power plant *Oberjägerweg* was to be built in the north-west-part of West Berlin in a forest (Spandauer Forst) to provide additional energy in the 1980s with a capacity of 600 Megawatt (and possibly later 1200 Megawatt). The plan was based on an increased need of energy of between 5,5% and 6,5% per year in West Berlin.

In a closed region such as West Berlin the loss of many hectares of forest had to be compared with the actual need of energy. The final decision, not to realize the power plant *Oberjägerweg*, was not initiated by the senate of West Berlin. Rather it was the highest court of justice of public administration (Oberverwaltungsgericht) which pointed out that there should be other possibilities to realize new capacity for the energy supply in West Berlin in the 80s. The following items begin with the conflict in October 76 about the decision whether or not to have a power plant at *Oberjägerweg* amongst the parties of the coalition. They end with the decision of the senate of West Berlin to realize a new power plant near an existing power plant (*Ernst-Reuter-Kraftwerk*, Ruhleben). It should be noted that the chosen items are of purely scientific interest and that they do not describe the complete discussion.

#### MAIN ITEMS OF THE DISCUSSION AND DECISION PROCESS

- 1 Parties: The Free Democratic Party (FDP) wants her senators to vote for location *Oberhavel* instead of *Oberjägerweg* (6.10.76).
- 2 Coalition: Heads of coalition partners (Schütz, SPD; Lüder, FDP) do not agree. Lüder fights for location *Oberhavel*. Arguments: the power plant *Oberjägerweg* affects adversely the so-called value of the free time in West Berlin to a considerable extent.
  - o At the *Oberhavel* location only 3800 trees need be cut, and at the *Oberjägerweg* location 35000 to 50000 possibly, when the power plant has the capacity of 1200 Megawatt.
  - o The *Oberhavel* location does not add to the heating load of the Havel river and no more noise from machines because there already exists a power plant.
  - o At *Oberjägerweg* location the forest will become an industrial region. (6.10.76)
- 3 Trade unions: They criticize the long duration of the decision process. Only by quick planning and realization can negative effects on jobs in West Berlin be

avoided (6.10.76).

4 Parliament: SPD-fraction in parliament of West Berlin renounces a discussion of the subject *Oberjägerweg*. The situation is difficult (8.10.76).

5 Parties: Head of CDU-party in West Berlin declares that his party has no definitive decision for location of the power plant (8.10.76).

6 Parliament: The senate must inform the German Democratic Republic (DDR). (10.10.76)

7 BEWAG: In cooperation with the administration of the forests, cutting trees should start in December (12.10.76).

8 Citizen group: Citizen groups with the names *Oberhavel* and *Bauschutt* are against the *Oberjägerweg* location and ask for an expert opinion (12.10.76).

9 Senate: SPD-majority in the senate votes for *Oberjägerweg* location. Eight steps justifying the loss of forest in Spandau in West Berlin:

- o district heating from Spandau power plant,
- o location *Dischinger Brücke* for a possible location of a power plant is canceled,
- o the ground north of the present power plant at the Oberhavel should become an area for a new forest,
- o Spandau will get a High School center,
- o Spandau will get a new sporting center,
- o in the region *Eiskeller* of Spandau should be a new forest,
- o the present dump site will be moved from Spandau,
- o and a special program to provide more green space in Spandau will be started (so-called *Spekte-Grünzug*). (13.10.76)

10 Senate: New facts relating to the power plant *Oberjägerweg* (600 Megawatt).

- o area: 22 hectares, 19 of them being forest, and not 25 as before.
- o 29000 trees to be cut, and not 35000 as before.

Comparison to the alternative location *Oberhavel*:

- o loss of 7 hectares of forest,
- o 3800 trees to be cut,
- o loss of 1300 plants.

Costs:

- o for buildings 930 000 000 DM (40 000 000 DM more than for *Oberhavel* location),
- o for running 318 000 000 DM per year,
- o for a new forest in surroundings 24 300 000 DM. (13.10.76)

11 Citizen group: Will fight against the power plant in the forest of Spandau in West Berlin (13.10.76).

12 Senate: New idea for the power plant in Spandau: It should be moved to the boarder to the DDR at the *Niederneudorfer Allee*, a suggestion of the administration of the forests (15.10.76).

13 Senate: Power plant is moved back to *Oberjägerweg* location (23.10.76).

14 Parliament: The CDU-fraction throws before the senate that the decision was made for political needs (29.10.76).

15 BEWAG: Cutting of trees in the present year. The following licences are necessary:

- o licence for changing the use of the area,
- o licence for cutting the trees,
- o licence to construct buildings,
- o licence to construct and to work with steam boilers,
- o licence to make more noise and to emit gas.

All persons are allowed to bring legal actions against the administrative processes (2.11.76).

16 Senate: Increasing the *Oberjägerweg* power plant to 12000 Megawatt depends on the energy situation (5.11.76).

17 Parliament: The committee for administration of the public property takes note of premature change of ground at the *Oberjägerweg* location to the BEWAG (12.11.76).

18 Parliament: CDU-fraction votes 50 to 5 against premature change of ground at *Oberjägerweg* location to BEWAG. It is suspected that the senate wants to do

this change before a new law is valid at 1.1.77 which provides more possibilities to citizens (§ 2a Bundesbaugesetz). (12.11.76)

19 Citizen group: The hot phase in the conflict about the power plant; to keep the ground at *Oberjägerweg* is self-defence (14.11.76).

20 Single person: Decrease the demand for energy. Destroying nature forces us to save energy (21.11.76).

21 Citizen group: Occupation of the forest at *Oberjägerweg* has prevented BEWAG from drilling (23.11.76).

22 Senate: The senate will face the protest with calmness. No thought of police (24.11.76).

23 Citizen group: A special group is not against drilling in the forest. This group (Aktionsgemeinschaft *Oberjägerweg*) will bring an action before the law-court (Verwaltungsgericht) against the *Oberjägerweg* location (24.11.76).

24 Citizen group: Occupation prevents again drilling in the forest (25.11.76).

25 Senate: Decides that an exception is made in the so-called *Landschaftsordnung* to provide cutting of trees in the forest of Spandau (26.11.76).

26 Law-court: The Verwaltungsgericht attests the request of the citizen group to forbid the senate to give permission to cut trees in the regions no. 35 and 37 in the forest of Spandau to the BEWAG (1.12.76).

27 BEWAG: Ground for the buildings of the *Oberjägerweg* power plant has been bought, price 16 000 000 DM. The senate may use a special regulation (§ 30 Bundesbaugesetz) to enable the constructing of the power plant before the end of December 1976. BEWAG requests the licence for constructing buildings at the *Oberjägerweg* location (1.12.76).

28 Senate: The senator for Housing etc. will delay the decision of the Verwaltungsgericht. He sees no necessity to de-

cide the request of BEWAG in the present year (2.12.76).

29 Citizen group: Plans to use the instrument *Normenkontrollverfahren* after 1.1.1978 (2.12.76).

30 Senate: There exists no definite contract to buy the ground at *Oberjägerweg*. Licence of supervisory board is missing as well as the licence of a special committee of the parliament. (2.12.76)

31 BEWAG: A shareholder of BEWAG protests in the main meeting of the BEWAG, suggesting, members Schütz (Regierender Bürgermeister), Lüder (Wirtschaftssenator), and Riebschläger (Finanzsenator) of the supervisory board should be discharged (3.12.76).

32 Law-court: The Verwaltungsgericht forbids the senate, temporarily, to give permission to BEWAG to cut trees in the forest at *Oberjägerweg* location. First there should be a decision due to the law for defence of emissions about the location of this power plant. The chamber is of the opinion that cutting the trees is an anticipation of the final location of the plant. Weighing the arguments *necessity of energy and interest in having the forest*, one should not overlook that the plans are already very late. Short time delays should be normal (7./8.12.76).

33 Expert opinion: Expert Kisker, Free University of West Berlin, is in opposition to the concept of the senate that the power plant is urgent. The next basic power plant need be ready only in autumn 1982, possibly in autumn 1984. That would mean that constructing buildings could wait until 1978 or even 1980. Present concept of senate: power plant with 300 Megawatt power is necessary in 1980/81 and therefore construction must begin in 1976/77.

Kisker: The supply capacity of 2257 Megawatt at the end of 1976 will be exceeded only in winter of 1983/84 (2239 Megawatt) when increase per year is assumed to be 4%, and in winter of 1982/83 with 2298 when increase per year is assumed to be 5% (and not 5,5% to 6,5% as in the conception of the senate). The assumption

of 4% - 5% increasing of energy demand seems to be realistic because the long term trend has weakened. The rate of growth of the GNP should not be multiplied by 2,0 as in the concept of the senate, but only by 1,5 to estimate the demand for energy. Furthermore it should be noticed that in 1990 there could live 300 000 less people than now in West Berlin (11.12.76).

34 BEWAG: Criticizes expert Kisker, because he operates with wrong data. BEWAG points out that the expert opinion of the *Forschungsstelle für Energiewirtschaft*, expert Schäfer, Technical University Munic, is the basic concept for the plans of the senate (15.12.76).

35 Law-court: The Verwaltungsgericht, chamber 13, forbids the senate to allow the BEWAG cutting of trees in the forest of Spandau. First should be licences for constructing the buildings, for the boilers, and for the cooling towers. Cutting trees is anticipation of the power plant (15.12.76).

36 BEWAG: Informs that in 1976 about  $7,5 \cdot 10^9$  Kilowatthours have been produced, that is more than in 1975. The peak of demand was in 1976 at 1436 Megawatt on 16th December. The capacity of all power plants is 1977 Megawatt (3.1.1977).

37 Senate: Decides to inform population in advertisements in newspapers. Schütz (Regierender Bürgermeister) argues for speedy beginning of construction (3.1.77 and February 77).

38 Senate: The drilling to control the ground for buildings at *Oberjägerweg* should be made (15.2.77).

39 Citizen group: The so-called Aktionsgemeinschaft does not agree in reactions to drilling (22.2.77).

40 Senate: Warnings, not to prevent drilling in the forest (22.2.77).

41 BEWAG: More drilling is not necessary in the forest; 21 out of 25 drills are sufficient (1.3.77).

42 Single person: In response to ad-

vertisements by the senate in newspapers: In West Berlin there are only two more locations for power plants, one in Ruhleben near to the present power plant, and one in the channel in Zehlendorf (Zehlendorfer Stichkanal). Increasing energy supply in West Berlin is in the long term only possible when new or combined heat and power of DDR is used (6.3.77).

43 Single person: An architect has an alternative plan for a power plant at the *Oberhavel*. Cool reaction of the senate (2.4.77).

44 Citizen group: A group wants to call the audit office (Rechnungshof) because of the advertisements by the senate in the newspapers. Suggestions of new expert opinions (16.4.77).

45 Expert opinion: Two experts (Bauer, TU Berlin, and Knigge, FHW Berlin) say that there will be enough energy in West Berlin until 1983/84 (16.4.77).

46 Law-court: The Oberverwaltungsgericht wants to have the expert opinion of the German Institute for Economic Research (DIW) about the economic development of West Berlin, which has been proposed for the senate (16.4.77).

47 Law-court: Questions as to different locations for the power plant in a seven hours session of Oberverwaltungsgericht (OVG). Experts of the senate (Schäfer, TU Munic) and of the citizen group (Kisker, FU Berlin) give forecasts about the energy demand in the eighties. They say 1980 (and opposite 1984) would be the year for new power supply. The possibilities to extend one of the present power plants in Ruhleben (*Ernst-Reuter-Kraftwerk*) or at the Oberhavel are discussed. Notes have shown that there existed earlier ideas to construct an atomic power plant in Ruhleben (29.4.77).

48 BEWAG: The drillings are positive. The ground at *Oberjägerweg* is good for buildings when compacted (29.4.77).

49 Law-court Oberverwaltungsgericht: Basic principle: *energy is good, nature is better*. The OVG points out that in Ruhleben near the *Ernst-Reuter-Kraftwerk*

will be a possible location for a new power plant. The court (chairman: Grundeil) is not against a new power plant in West Berlin, but against the location at the *Oberjägerweg*. And the court is against proceeding without including the citizens. The temporary prohibition to cut trees in the forest of Spandau is unimpeachable. And moreover:

- o Given that large power plants create emissions over the whole town, each citizen is allowed to look for protection at the law-court.
- o The plan to cut the trees in the forest of Spandau was de facto a finite decision of the location without hearing the citizens, whereas in normal planning processes citizens should be heard.
- o Viewing the special geographical and political situation of West Berlin it should be possible to suffer a larger pollution of the air than in West Germany, on the other hand one needs intensive protection of the present meadows and forests.
- o A location at the present power plant in Ruhleben should be better than the location at the *Oberjägerweg*. The area at the power plant *Ernst-Reuter* will be not used for an atomic power plant, because the old plans are not valid in the future. This area lies in the largest and closed industrial region of West Berlin. No tree has to be cut. Buying the industries at this location will be expensive but could be expected.
- o The administration should be interested that very soon there will be a control by the court. The court could not permit the cutting of 30 to 50 Thousand of trees, and wait until buildings were constructed with high costs, and then say: pull them down. The forest with 800 tons of oxygen production has a high economic value as well as the power plant.
- o A lack of supply for power in 1980 had been argued by the BEWAG for 15 years. The administration is not allowed to delay the planning in such a way that there is a case of emergency and participation of citizens is by-passed. A gas turbine could be used for 3 years until legal planning process for the new

power plant has finished (3.5.77).

50 Parties: FDP-party sees confirmation of their decision against the power-plant *Oberjägerweg*. CDU-party: The law-court (OVG) has stated a lecture in planning to the senate of West Berlin. (3.5.77)

51 Newspaper *Der Tagesspiegel*: The forest in Spandau has been damaged during the protests against *Oberjägerweg* power plant (4.5.77).

52 Senate: The senate looks for a different location for the new power plant and has until now no alternative to the forest in Spandau (4.5.77).

53 Citizen group: The huts of the opponents were pulled down (14.5.77).

54 Senate: The senate plans to decide about the location of the new power plant in August 1977. To avoid a narrow pass, gas turbines should be used, 180 Megawatt (21.7.77).

55 Senate: The senate follows the suggestion of the Oberverwaltungsgericht (OVG). Plan: 300 Megawatt until 1982/83, 300 Megawatt until 1983/84, in the north and in the east of the power plant *Ernst-Reuter*. (7.9.77).

56 Newspaper *Der Tagesspiegel*: Critical remarks to the prognosis of demand and supply of future energy of the senate, BEWAG, and experts. High reserves in energy supply (7.11.77).

57 Senate: The problem of the chimneys in the power plant Ruhleben is not solved. Height of chimneys should be 120 to 140m. The Allied have protested because the location of the chimneys is in the zone of security for flights, where buildings up to 100m are allowed. BEWAG looks to buy the ground. At the present power plant *Ernst-Reuter* in Ruhleben should be built 3 blocks with 300 Megawatt each; 208 present Megawatt should be closed in the old power plant (13.1.78).

58 Parties: CDU-party criticizes power plant planning. Necessary are 1200 Megawatt, 900 are planned and 208 are

closed. This is too few (13.1.78).

59 Single person: Their was no comment about the expected emission of sulphur of the chimneys. The values for sulphur in parts of West Berlin, Charlottenburg and Siemensstadt, are as high as in several towns of the *Ruhrgebiet* in West Germany. It is almost cynism, when 1000 to 5000 excursionists have a possibility for excursions in the forest and on the other side a part of the population which is 20 to 30 times as large will suffer 168 hours per week, when the power plant is situated in Ruhleben. (29.1.78)

60 Senate: Surprising decision in the power plant Ruhleben: 600 Megawatt proposal west of present power plant Ruhleben, two blocks, chimneys 120 m high, cooling towers 110 m high; Allied have agreed. Need to take 5 hectars of industrial region. The blocks are at least 450 m away from the next dwelling houses. Extending the capacity in Ruhleben to 600 Megawatt and in Neukölln to 200 Megawatt (for top demand) the supply of energy should be secured for the eighties. At present time there is 2250 Megawatt in West Berlin, with the planned power plant in Ruhleben and the additional in Neukölln the maximal power supply will be 3050 Megawatt. The senate orders the senator for housing etc. to provide new possible locations for power plants until the end of 1979. The senator for health and protection of environment has to look for possibilities to save energy (1.2.78).

#### CONCLUSIONS

The previous example should not be overestimated because West Berlin has a special geographical and political situation. But it shows evidently:

- (1) Citizens or citizen groups, using legal instruments, have a possibility to control large planning projects on the energy field in the Federal Republic of Germany. In the case of the power plant *Oberjägerweg* this control lead to a quite different solution of the power plant than either the administration nor the citizen groups had thought before.
- (2) The conflict *35000 trees to be cut versus less energy in the eighties* was not accepted in this form by the law-court *Oberverwaltungsgericht*. The OVG solved the conflict at a very early stage. For this court the goods *need of energy and interest in the forest (who provides 800 tons of oxygen)* were both high economic values. The solution was to provide both, and population has in consequence to suffer more pollution of the air.
- (3) The senate of West Berlin followed hints of the law-court OVG and planned the location of new power plants near to the present power plant in Ruhleben (so-called *Ernst-Reuter-Kraftwerk*). One is obliged to say, the law-court is responsible for urban and regional planning; but this argument is merely superficial. Rather the law-court has stated that normal planning procedures have not been observed. The more it has stated that administration is not allowed to agree with pre-decisions, here: *cutting of trees*, which give a point of no return in the decision process before its end.
- (4) According to the first goal of the report the items show, where (simple) models for prognosis of energy demand and supply have been used. They appear in the expert opinions of Schäfer, Kisker, Bauer, Knigge et.al., and are in details opposite. Surprising is, that the law-court OVG could refer to all these expert opinions because no expert denied the need of a future supply of additional energy in West Berlin, only the year of this supply was in dispute. Therefore we can say that these studies had only second priority in the decision process.
- (5) According to the second goal the items of the discussion process show indeed that there is a chance to model this discussion process. Not in this sense that the result is predicted, but in the sense that all stages of the decision are well known. One can make

checklists of all licences which are necessary in the process of planning, of all administration departments which have to cooperate, and so on. The sources for these informations are the laws for administration, laws for buildings like Bundesbaugesetz (BBauG) in the Federal Republic of Germany. They may be different in different countries, but they exist. Having this list one can make simple systems analysis, in form of flow diagrams or in form of lists with activities, to show what is possible in which time. Time delays in project planning are then normal and necessary in the realization process of a power plant, when the planning phase is superficial. In some sense the flow diagram of ongoing of the planning process is an interface between models for future demand and supply of energy on the one side, and the realization of a special project on the other side.

#### REFERENCES

The following articles of the newspaper *Der Tagesspiegel* without author's name contain more and detailed information:

- FDP weist ihre Senatoren an, für den Standort Oberhavel zu stimmen. *Der Tagesspiegel*, Oct. 6, 1976, West Berlin
- Lüder kämpft in letzter Minute für Standort Oberhavel. *Der Tagesspiegel*, Oct. 9, 1976, West Berlin.
- Schütz: Am Dienstag fällt die Entscheidung über das Kraftwerk. *Der Tagesspiegel*, Oct. 8, 1976, West Berlin.
- Kraftwerk im Walde. Leserzuschriften. *Der Tagesspiegel*, Oct. 10, 1976, West Berlin.
- Im Dezember reißen Bulldozer schon die ersten Bäume aus. *Der Tagesspiegel*, Oct. 12, 1976, West Berlin.
- Trostpflaster des Senats für Verlust des Grüns in Spandau. *Der Tagesspiegel*, Oct. 13, 1976, West Berlin.
- SPD-Mehrheit im Senat entschied für Kraftwerk-Standort Oberjägerweg. *Der Tagesspiegel*, Oct. 13, 1976, West Berlin.
- Neue Überlegungen zum Kraftwerksbau in Spandau. *Der Tagesspiegel*, Oct. 15, 1976, West Berlin.
- Spandauer Kraftwerk rückt wieder an den Oberjägerweg. *Der Tagesspiegel*, Oct. 23, 1976, West Berlin.
- Fragen nach der künftigen Energieversorgung. *Der Tagesspiegel*, Oct. 29, 1976, West Berlin.
- Noch in diesem Jahr soll für das Kraftwerk gerodet werden. *Der Tagesspiegel*, Nov. 2, 1976, West Berlin.
- Weiterer Kraftwerk-Ausbau hängt von Energie-Situation ab. *Der Tagesspiegel*, Nov. 5, 1976, West Berlin.
- Senat soll DDR über geplanten Kraftwerksbau informieren. *Der Tagesspiegel*, Oct. 10, 1976, West Berlin.
- Kraftwerksgelände vorzeitig an BEWAG übertragen. *Der Tagesspiegel*, Nov. 12, 1976, West Berlin.
- Von heißer Phase des Konflikts um das Kraftwerk gesprochen. *Der Tagesspiegel*, Nov. 14, 1976, West Berlin.
- Atomkraftwerksbau. Leserzuschrift. *Der Tagesspiegel*, Nov. 21, 1976, West Berlin.
- Geringerer Stromverbrauch. Leserzuschrift. *Der Tagesspiegel*, Nov. 21, 1976, West Berlin.
- Waldbesetzer verhinderten Probebohrungen der BEWAG. *Der Tagesspiegel*, Nov. 23, 1976, West Berlin.
- Senat will Protestaktionen mit Gelassenheit begegnen. *Der Tagesspiegel*, Nov. 24, 1976, West Berlin.
- Besetzer verhinderten erneut Bohrungen auf Kraftwerksgelände. *Der Tagesspiegel*, Nov. 1976, West Berlin.
- Ausnahmeregelung ermöglicht Rodungen im Spandauer Forst. *Der Tagesspiegel*, Nov. 26, 1976, West Berlin.
- Kraftwerksgelände für rund 16 Millionen DM gekauft. *Der Tagesspiegel*, Dec. 1, 1976, West Berlin.
- Bewag stellte ersten Antrag auf Baugenehmigung für das Kraftwerk. *Der Tagesspiegel*, Dec. 2, 1976, West Berlin.
- Die WUB opponiert nun auch unter den Bewag-Aktionären. *Der Tagesspiegel*, Dec. 3, 1976, West Berlin.
- Gericht verbot vorläufig Rodung für Kraftwerksbau. *Der Tagesspiegel*, Dec. 7, 1976, West Berlin.
- Das Kraftwerk Oberjägerweg vor Gericht. *Der Tagesspiegel*, Dec. 8, 1976, West Berlin.
- Energie-Gegenrechnung mit unbekanntem Größen. *Der Tagesspiegel*, Dec. 11, 1976, West Berlin.
- Bürgerinitiative berichtet über Kernkraft-Unglück in der DDR. *Der Tagesspiegel*, Dec. 11, 1976, West Berlin.



Zweite einstweilige Anordnung gegen Senat im Kraftwerksstreit. *Der Tagesspiegel*, Dec. 15, 1976, West Berlin.

6,6 Prozent mehr Strom erzeugt. *Der Tagesspiegel*, Jan. 3, 1977, West Berlin.

Bund und Länder einig über Notwendigkeit der Atomenergie. *Der Tagesspiegel*, Feb. 12, 1977, West Berlin.

Warum die BfA ein eigenes Heizwerk braucht. *Der Tagesspiegel*, Feb. 1977, West Berlin.

Schutz für baldigen Beginn des Kraftwerkbaues. *Der Tagesspiegel*, Feb. 1977, West Berlin.

Stromversorgung wird bald kritisch. *Der Tagesspiegel*, Feb. 13, 1977, West Berlin.

Probebohrungen am künftigen Standort des Kraftwerkes in Spandau. *Der Tagesspiegel*, Feb. 15, 1977, West Berlin.

Aktionsgemeinschaft über weiteres Vorgehen uneinig. *Der Tagesspiegel*, Feb. 22, 1977, West Berlin.

Auf weitere Bohrungen verzichtet. *Der Tagesspiegel*, Mar. 1, 1977, West Berlin.

Energie für Berlin. *Der Tagesspiegel*, Mar. 6, 1977, West Berlin.

Insel in der Havel als Blickschutz vor dem Kraftwerk. *Der Tagesspiegel*, Apr. 2, 1977, West Berlin.

Kraftwerk-Bürgerinitiative will sich an Rechnungshof wenden. *Der Tagesspiegel*, Apr. 16, 1977, West Berlin.

Fragen nach Ersatzstandorten für ein Kraftwerk. *Der Tagesspiegel*, Apr. 30, 1977, West Berlin.

Grundsatz: Energie ist gut, Natur ist besser. *Der Tagesspiegel*, May 3, 1977, West Berlin.

Wald blieb nicht ungeschoren beim Protest gegen Kraftwerk. *Der Tagesspiegel*, May 4, 1977, West Berlin.

Bürgerinitiativen lehnen Spandauer Modell ab. *Der Tagesspiegel*, May 4, 1977, West Berlin.

Senat sucht Ersatzstandort für neues Kohlekraftwerk. *Der Tagesspiegel*, May 4, 1977, West Berlin.

Elektrogeräte: Stromfresser im Haushalt. *Der Tagesspiegel*, May 8, 1977, West Berlin.

Hütten der Kraftwerksgegner werden abgerissen. *Der Tagesspiegel*, May 14, 1977, West Berlin.

Stromverbrauch nur wenig höher. *Der Ta-*

*gesspiegel*, July 20, 1977, West Berlin.

Senat will im August über Standort für Spitzenlastwerk entscheiden. *Der Tagesspiegel*, July 21, 1977, West Berlin.

Bei extremer Kälte wird das Spitzenheizwerk eingeschaltet. *Der Tagesspiegel*, June 1977, West Berlin.

Stromverbrauch. Leserzuschrift. *Der Tagesspiegel*, July 1977, West Berlin.

Das Kraftwerk Reuter soll bald Zuwachs bekommen. *Der Tagesspiegel*, Sep. 7, 1977, West Berlin.

Wie die Bewag das Waldopfer rechtfertigt. *Der Tagesspiegel*, Nov. 7, 1977, West Berlin.

Schornsteinproblem für Kraftwerk Ruhleben weiterhin ungeklärt. *Der Tagesspiegel*, Jan. 1978, West Berlin.

Kraftwerk Ruhleben. Leserzuschrift. *Der Tagesspiegel*, Jan. 29, 1978, West Berlin.

Überraschender Senatsbeschluss über neues Kraftwerk in Ruhleben. *Der Tagesspiegel*, Feb. 1, 1978, West Berlin.

#### APPENDIX

The author is very grateful to Dr. Malcolm Slesser, Director of Energy Studies Unit, University of Strathclyde, Glasgow, Scotland for reading the paper before presentation.

Mailing address of the author:  
Dr. Helmut Maier, Professor  
Fachhochschule für Wirtschaft Berlin  
Badensche Straße 50-51  
1000 Berlin 62  
F.R.G.





---

## MODELING OF LARGE-SCALE ENERGY SYSTEMS

Proceedings of the IIASA/IFAC Symposium on Modeling of Large-Scale Energy Systems

February 25–29, 1980

W. Häfele, Editor, and L.K. Kirchmayer, Associate Editor

The problem of the seventies was energy, and the business of modeling energy systems boomed. As models became more sophisticated, and as the international and intercontinental aspects of the energy problem became clearer, the boundaries of the energy systems being modeled grew to the point where it was useful to distinguish a special category of energy models: those dealing with large-scale energy systems.

Practical experience in building and applying models for large-scale energy systems has been accumulating at a rapid rate in recent years. Thus, to contribute to communicating and assimilating some of the lessons learned in the seventies about modeling large-scale energy systems, the Systems Engineering Committee of IFAC (the International Federation of Automatic Control) and the Energy Systems Program at IIASA (the International Institute for Applied Systems Analysis) organized an international symposium on this subject.

This volume contains the 43 papers given at the symposium.

---