

NOT FOR QUOTATION
WITHOUT PERMISSION
OF THE AUTHOR

**MITSIM-2: A SIMULATION MODEL FOR PLANNING
AND OPERATIONAL ANALYSIS OF RIVER BASIN SYSTEMS**

Kenneth M. Strzepek

October 1981
WP-81-124

Working Papers are interim reports on work of the International Institute for Applied Systems Analysis and have received only limited review. Views or opinions expressed herein do not necessarily represent those of the Institute or of its National Member Organizations.

INTERNATIONAL INSTITUTE FOR APPLIED SYSTEMS ANALYSIS
2361 Laxenburg, Austria

PREFACE

Water resource systems have been an important part of resources and environment related research at IIASA since its inception. As demands for water increase relative to supply, the intensity and efficiency of water resource management must be developed further. This in turn requires an increase in the degree of detail and sophistication of the analysis, including economic, social and environmental evaluation of water resources development alternatives aided by application of mathematical modeling techniques, to generate inputs for planning, design, and operational decisions.

This paper is part of a collaborative study on water resources problems in South Western Skåne, Sweden, pursued by IIASA in collaboration with the Swedish National Environmental Protection Board and the University of Lund. The paper describes the MITSIM-2 river basin simulation model and its application for analysis of a regional water supply system in South Western Skåne region, Sweden. The MITSIM-2 model is an extended version of the MITSIM-1 model developed earlier at the Massachusetts Institute of Technology Cambridge, Massachusetts, USA. The results of the model application, although still of a preliminary nature, provide a good illustration of the usefulness of MITSIM-2 as an aid in water management decisions.

Janusz Kindler
Chairman
Resources and Environment Area

ACKNOWLEDGEMENTS

The author is indebted to Janusz Kindler, leader of the South Western Skåne Case Study ,who directed the overall project and provided valuable comments for this work and to Lennart de Mare who provided insight to the water management policies of South Western Skåne and without whom this research would have only been a theoretical exercise.

The author would also like to thank Robert Anderson , Susan Arthur, Donald Erlenkotter, and Tsuyoshi Hashimoto for their contributions to this work.

ABSTRACT

Mathematical simulation models have become a common tool for the analysis of water resources problems . The models fall in two categories, those for studying long range planning of water resources development and those for the analysis of detailed operation of water resource systems. The planning models tend to be of a longer time step usually on the order of one month, while the operational models may need a time steps of days and in some cases hours. This paper presents a model that incorporates features of both planning models and operational models. MITSIM-1 , a river basin simulation model for long range planning was modified to account for daily operational rules and complex institutional constraints within a basin. A new model ,MITSIM-2 , was developed that provides quasi-daily operational rules for reservoirs and irrigation requirements, while retaining the features necessary for efficient long range planning of basin development . MITSIM-2 is applied to the regional water supply system of South Western Skåne to demonstrated its applicability to incorporate planning and operational analysis successfully in one model.

CONTENTS

Use of Simulation Models in Water Resources Engineering	1
MIT River Basin Simulation Model- MITSIM	3
Basic Structure of the MITSIM Models	3
Arc/Node Representation	4
Governing Principles of the Model	7
Measure of System Performance	8
Overall System Performance	9
Modifications to MITSIM-1 to Create MITSIM-2	10
Reservoir Nodes	10
Irrigation Nodes	13
Diversion Nodes	14
Overview of Water Use in South Western Skåne	15
Municipal and Industrial Water	15
Irrigation Water	17
Use of MITSIM-2 for Analysis of the South Western Skåne Water Supply System	17
Data , Procedures and Scenario Generation	18
Results	20
Conclusions	22
References	23

MITSIM-2: A SIMULATION MODEL FOR PLANNING AND OPERATIONAL ANALYSIS OF RIVER BASIN SYSTEMS

Kenneth M. Strzepek

USE OF SIMULATION MODELS IN WATER RESOURCE ENGINEERING

The use of mathematical simulation models for the analysis of water resource problems is not a new concept. In the late 19th century, Rippl (1883) devised the mass-curve analysis to determine the storage capacity of a reservoir necessary to provide a desired pattern of reservoir releases given historic reservoir inflows. These calculations were performed graphically or arithmetically by hand.

The implementation of simulation models for use in planning and operational analysis of water resource projects continued to grow as data processing equipment improved. However, even with the use of desk calculators the task was time consuming and provided problems in processing of data. These restrictions limited the use of the technique to simple situations. Typically, very few alternative plans were analyzed in the final stage of design by making a simulation or operational study covering the few years of critical flow. These studies were limited to investigating at most one reservoir and one category of a water use. No attempts were made to simulate the performance of a large number of alternative designs, nor were simulations extended to handle time periods as long as the selected periods of economic analysis (Hufschmidt and Fiering, 1966).

The development of high speed digital computers in the early 1950's allowed water resources engineers to use computers to perform the same analyses that were previously done by desk calculators. As the computers developed in speed and capacity it became possible to simulate the performance of large and complex river basin systems over extended periods of time.

*River Basin Systems is used in this paper as a general term to describe a water resource system which includes the natural hydrologic system of a river basin as well as man-made

Simulation modeling of large river basins began in the United States in 1953 with a study of hydropower potential on the main stem of the Missouri River by the U.S. Army Corp of Engineers (1957). The first full river basin simulation was performed on the Nile Basin in 1955 by Morrice and Allan (Morrice,1958, Morrice and Allan,1959).The U.S. Army Corps of Engineers also performed a simulation study of the Columbia River system for development of hydropower(Lewis and Shoemaker,1962). In the late 1950's the famed Harvard Water Program was initiated, as described by Maass ,et al(1962). This program was the first to systematically present the modern, inter- disciplinary systems analysis approach to water resource planning. In this work a simulation model was applied to the hydrologic and economic analysis of a complex river basin. The model analyzed hydropower, irrigation and flood control purposes in a multiproject system.

The simulation modeling work of the Harvard Water Program was later discussed by Hufschmidt and Fiering(1966), who presented a detailed description of their simulation model and discussed its use in the multipurpose planning of the Lehigh River Basin. Fiering(1967) later presented some further discussion of the simulation techniques on the Lehigh basin.

The Texas Water Board(1970), Jacoby and Loucks(1972) , Kindler(1977) ,and Alarcon and Marks (1979) have used simulation in combination with optimization techniques for planning of water resource systems. These are only a few accounts reported in the literature of the many applications of simulation modeling in water resource engineering.

The reader should be aware of the limitations of simulation modeling. When a simulation model is used in a planning or operational analysis one must be careful not to interpet the results as a true representation of reality. Moreover, we are warned:

"... the simulation model is not to provide exact answers, but rather it is a tool to make available the necessary information so that policy and decision makers can use this to make their decision"(Shah,1975)

Within this framework simulation modeling is a powerful tool to assist decision makers and planners when confronted with water management decisions on complex river basin systems. The simulation results allow them to look at the response of the system under varying inputs and system configurations. This provides information about the interaction of the system components and allows decisionmakers to combine this information with political and social consideration to design a system which provides the greatest benefit to society.

components .

MIT RIVER BASIN SIMULATION MODEL- MITSIM

A series of river basin simulation models have been developed by the Water Resources and Environmental Engineering Division of the Department of Civil Engineering at the Massachusetts Institute of Technology (MIT). The model described in detail by McBean, et al (1973) was the first one, and was developed for use as part of the MIT project on the river Colorado in Argentina (Major and Lenton, 1979). An improved version was developed by Schaake, et al (1974) as part of a project entitled "Systematic Approach to Water Plan Formation". It was based on the previous model, but was simpler and included an input error detection routine. These changes made it more efficient to use and easier for those not familiar with the internal workings of the model. MITSIM-1, a further extended version of the Schaake's model was developed as part of the UNDP sponsored study of the Vardar/Axios River Basin in Yugoslavia and Greece. MITSIM-1 provides a detailed simulation of both the physical and economic performance of the river basin system including multipurpose, multiobjective, surface water projects as well as groundwater projects. The model and its use are described in Lenton and Strzepek (1977) and Strzepek and Lenton (1978).

All the above versions of the MIT simulation model were for planning purposes only and modeled water withdrawal priority to upstream users over downstream users and reservoir operation by the "Standard Operating Rule" (Fiering, 1967). These features are sufficient for planning purposes where detailed institutional or operating rules for water management are not in use. However, when analyzing changes to existing systems, modeling the development of detailed reservoir operating rules, or when the institutional framework requires downstream priority for water use these models are inadequate.

To overcome these difficulties a new version of the MIT simulation model, MITSIM-2, was developed at IIASA in collaboration with MIT. This model is an extension of MITSIM-1, retaining its multipurpose and general features but providing the capabilities of modeling detailed operational features of Water Management Systems.

This paper will describe modification made to MITSIM-1 to make it applicable for more general cases of long range planning analyses. A new model, MITSIM-2, was the result of these modifications and was applied to a case study in South Western Skåne, Sweden to show the usefulness of the approach for analysis of regional water resource systems.

BASIC STRUCTURE OF THE MITSIM MODELS









In order to simulate the behavior of a river basin in the MITSIM models, the system under analysis must be represented by means of a network of nodes and arcs. A node represents a structural or non-structural component (e.g., reservoir, irrigation site, power plant, confluence, etc.) of the river basin system at which water enters the river system, leaves the system by consumption or diversion, has its temporal distribution altered, or is to be observed for some special purpose. Nodes are linked together by arcs which represent the natural or man-made connections of the river system. As will be described, this arc/node

abstraction enables the model to trace water flows through the river system both temporally and spatially, providing an analysis of hydrologic performance of certain nodes under various conditions.

ARC/NODE REPRESENTATION

The simulation model has been designed to model features typical of most river basin systems. To do this , nine different types of nodes have been incorporated in the model as listed in Table 1.

Table 1. Simulation Model Node Types

<i>1.Start Nodes (streamflow or G.W. recharges input)</i>	
<i>2.Reservoir Nodes</i>	
<i>3.Irrigation Nodes</i>	
<i>4.Municipal and Industrial Water Supply Nodes</i>	
<i>5.Diversion Nodes</i>	
<i>6.Hydrograph Nodes</i>	
<i>7.Confluence Nodes</i>	
<i>8.Groundwater Nodes</i>	
<i>9.Terminal Nodes</i>	

To represent a river system properly in a simulation model ,a great deal of data about the natural system and about existing and proposed water resource projects is needed. This data serve as a basis for the specific inputs to the model.

Once the data is gathered , the modeler must take the river basin's physical layout and schematize it into an arc/node network. The size and complexity of the schematic is dependent upon the level of detail that exists in the data,the objectives of the analysis, and the computer budget.

Suppose, for example, that the hypothetical river basin layout in Figure 1, Layout1, represents a possible development plan for a river basin.

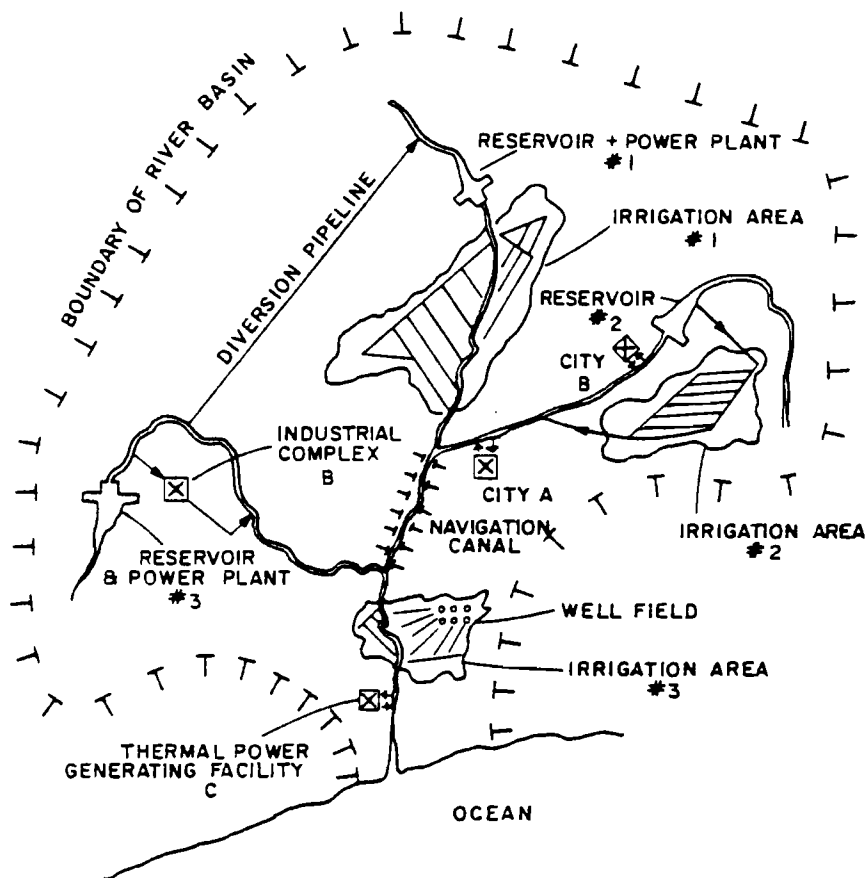

Figure 1. Hypothetical River Basin Layout-Layout1

Of the projects shown, some may be existing some proposed. To simulate the operation of this river basin, it is necessary to develop an arc/node schematic corresponding to Layout-1 using the nine different types of nodes available. A possible schematic for Layout1, Schematic1 is presented in Figure 2.

Schematic1 incorporates all the features of Layout1 at the same level of detail. However, in some other river basin systems the size of the basin may be too large to allow for all projects to be modeled because the storage capacity of the computer is exceeded, the data may exist at a more aggregated level or the repeated simulation of such a large system may exceed the budget for computer time.

In these cases it is necessary to aggregate projects within the basin. For example, to combine two adjacent irrigation areas into one, or to represent a Municipal and Industrial pipeline network as a single demand node. However, when aggregating, the modeler must take extreme caution not to violate the basic hydrology of the system layout at the

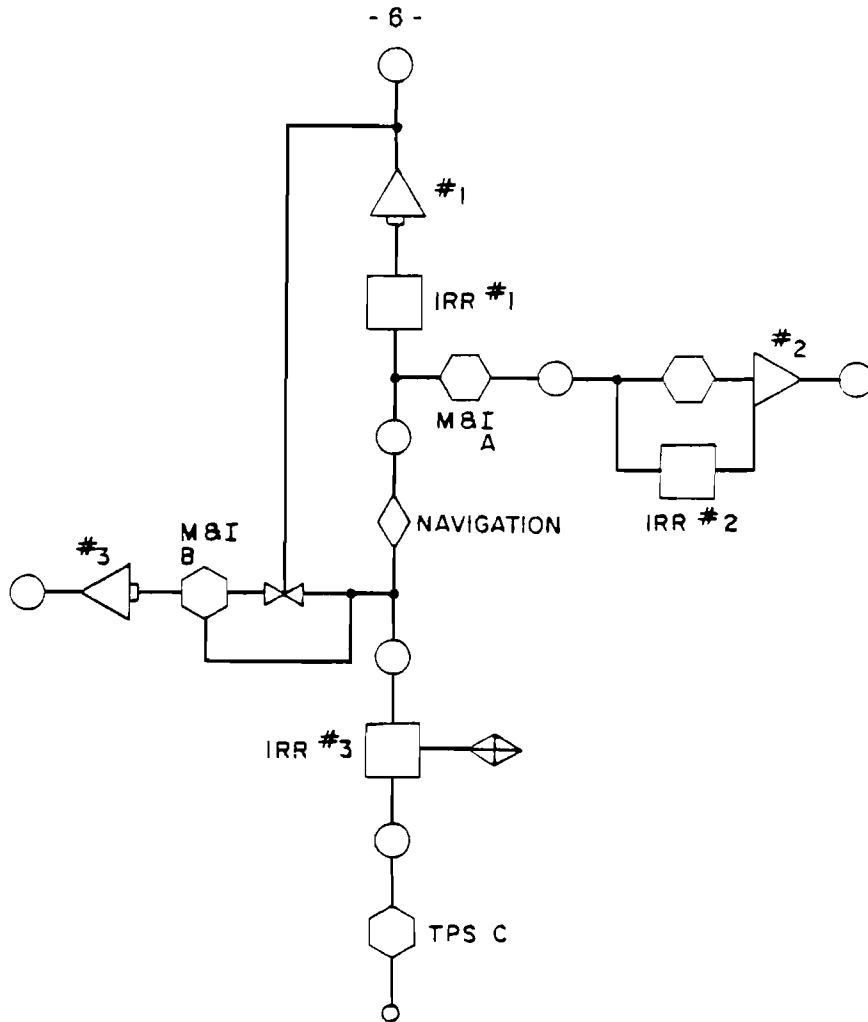

Figure 2. Schematic for Layout-1: Schematic-1

disaggregated level. One must also be careful when attempting to use aggregated results to draw conclusions on separate projects that make up the aggregate system due to the non-linearities of the system.

The arc/node network is the basis of the MITSIM simulation approach. The model has general applicability since the arc/node connectivity is input into the model. This allows the model to be used on any river system for which a schematic can be developed based upon the nine node types of the model.

Once a schematic has been developed for the model, detailed data must be input for the calculation of flow within each node. This data is related to the engineering parameters of each of these nodes. In some version of the MITSIM models the economic performance of the system is evaluated as well, in these cases data on costs and benefits must be input to the model. For a detailed discussion of data needs see Lenton and Strzepek (1977), Strzepek, et al (1979), and Strzepek (1981).

With the arc/node network and the node parameters defined the driving function for the system must be input. As mentioned above water enters the system through start nodes as well as nodes that transform precipitation to flows that may enter the system. The simulation models do not generate monthly streamflow or precipitation within the model, but rather read in the streamflow and precipitation from a data file. This requires that the streamflow and precipitation data be prepared before the simulation analysis begins. This streamflow and precipitation data can be historic data or synthetically generated data which preserve certain statistical properties .

GOVERNING PRINCIPLES OF THE MODEL

The basic operation of the model consists of calculating the monthly flows at all nodes in the basin and for all months in the simulation period. To do this, the model introduces flow at all the start nodes and traces the flow through the entire network of arcs and nodes for a single month; it then repeats the process for each month of the simulation period.

The algorithms that govern the flow within each of the nodes will not be discussed in this paper except for the nodes modified in MITSIM-2. The details of the algorithms for the other nodes in the MITSIM models are discussed in Lenton and Strzepek ,(1977), however ,the details of the basic flow equations of the model will be discussed below.

The result of each set of equations that operates on the flow at each node ,s, will be the downstream flow at the node s, for month m of year t, $D_s(m,t)$, given the inflow to node s , $Q_s(m,t)$. The flow between the nodes is assumed to have no losses or gains. If there does exist gains or losses of flow between two points in the basin represented by an arc connecting two nodes, these losses or gains can be accounted for by a third node (one of the nine types) being introduced between the two nodes which will act as a source or sink of flow. Therefore for any two nodes s and s+1 it is possible to describe the exchange of flow as

$$Q_{s+1}(m,t)=D_s(m,t).$$

This exchange is illustrated graphically in Figure 3.

The time step of one month used in the model was chosen taking into account the trade-off between the need for accuracy (credibility) and the cost of each computer simulation. In principle, other time steps may be used as long as the length of the time step exceeds the travel time of the water from the sources to the terminal points. This restriction is necessary because of the use of continuity equations to propagate flow. In practice, however, changes in time steps require substantial changes in the output routines of the model which are designed for reporting monthly values.

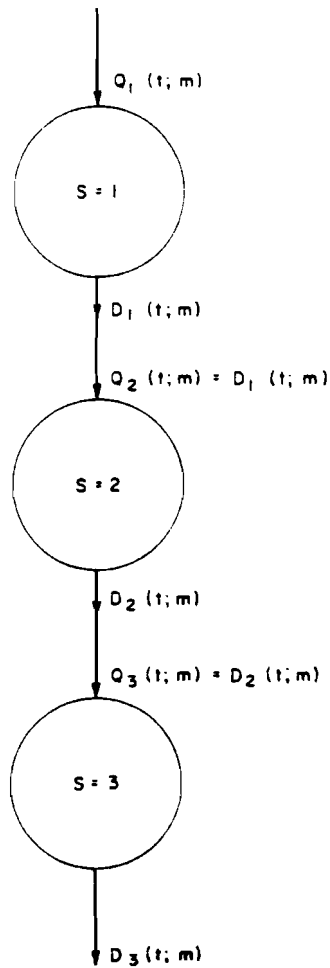

Figure 3. Arc/Node Flow Exchange

MEASURE OF SYSTEM PERFORMANCE

The physical performance of a water resource system is measured by the level of water flow at different points in the system. In water resource systems the problem that faces the analyst is that the inputs to the systems, (precipitation, streamflow, irrigation water use, etc ...) possess natural variability. This variability can be described statistically by considering these inputs as random variables. The response of the system to these random inputs will be random as well. There are various methods for determining random system output from random inputs. The method used in MITSIM is monte carlo simulation. The stochastic input variables are represented by a time series of monthly values. The model then simulates the system for each month and produces a times series of monthly system responses. The time series of systems responses is then used to determine statistics on system performance.

The measure of performance used in MITSIM is the "reliability" of the target supply of water, where the target is the amount of water required at each node for the desired performance of the water use. The term "reliability" is used to describe the expected frequency with which

the different water use nodes in the configuration attain given physical targets. The annual and monthly reliability of water use nodes are recorded in MITSIM.

An important point is that this measure of reliability fails in distinguishing between the magnitude of failing to meet the target values. If the system does not meet the target by .05 or 45 m³/sec there is no difference and they are both counted equally as a failure. However, the model also provides more detailed statistical information such as mean and standard deviation of actual flows for individual nodes. As well as, a diversion histogram that provides the information on the frequency of diversion within certain ranges and a hydrograph that records a monthly time series of all diversions are available. Utilizing all this information provides quite a bit of data on the performance of each node. Examples of this output can be seen in Lenton and Strzepek (1977).

OVERALL SYSTEM PERFORMANCE

The above discussion about reliability was focussed on the performance of individual locations within the system. However, for some analysis the reliability of the entire system or of specific water uses is desired. The system or use reliability requires a special measure of reliability. Therefore, the definition of a system or use failure is

"if any one of the nodes of the system or specified use fails to meet its target value the total system or specified use is considered to fail".

This means that total system reliability is not the minimum reliability of the reliability of the different uses but rather another value that must be calculated within the simulation analysis, annually or monthly. In this case the total reliability is some times less than that of any of the component reliabilities if the components fail in different years. Although in many cases one component may be the weak link and be responsible for the reliability of the total system.

Even when the total system performance is the primary measure of performance, the performance of the individual uses is of value when evaluating alternative system configurations.

The following overall statistics are calculated for each simulation analysis: the annual and monthly reliabilities for irrigation, lowflow, and M&I and the monthly and annual joint reliabilities of irrigation and low flow; irrigation and M&I; and low flow and M&I. reliability, and the annual and monthly M&I reliability.

An important point to be stressed is that the simulation analyses that are performed by MITSIM-2 are static simulations. The same configuration is assumed to be static over the period of the simulation. What the simulation provides is a statistical analysis of the performance of a system subject to a time series of possible future inflows and water uses. It does not provide a dynamic simulation of a system that is changing over the years of simulation. Rather, it provides a "snapshot" view of a single point in the development of the basin. It is possible however, to perform a number of "snapshots" that reflect various stages of the basins

development and synthesize the data to provide information on the dynamic behavior of the system.

MODIFICATIONS TO MITSIM-1 TO CREATE MITSIM-2

MITSIM-2 has been developed as an extension of MITSIM-1 in order to model the case of developed river basin systems featuring many existing project with detailed operational procedures and institutional constraints. The goal in developing MITSIM-2 was to provide a general hydrologic simulation model that will allow for the analysis of policy decision regarding operation of present regional water system as well as analyze policies regarding long range development of regional water supply systems. Therefore the objectives were to develop a model that was sufficiently detailed to model complex operational procedures of the various water resource components yet simple enough to model proposed development alternatives without being prohibitively large in computer storage or costly to run over statistically significant simulation periods. At the same time the model should be general enough to allow for use in many different river basin location and provide ease in examining alternative policies or system configuration. These objectives are clearly conflicting and the model presented in this paper is a compromise solution that the author feels is the best possible given the resource constraints and the desire to make a generalized transferable tool for regional water management.

MITSIM-2 is based on the basic properties and structure of MITSIM-1 presented above and those which are described in Lenton and Strzepek, (1977) and Strzepek, et al (1979). This basic structure provides for a general transferable tool that allows for easy analysis of many alternative systems or policies.

However, to more accurately represent the dynamic nature of operational systems modifications were made to the algorithms that calculated flow at three of the nine nodes found in MITSIM-1, reservoirs, irrigation, and diversion nodes. These modifications are described below.

RESERVOIR NODES

Reservoirs are usually the most significant components of a river basin system. The reservoir can act to distribute flow within the year (Within Year Storage) and store water from one year to the next (OverYear Storage). The construction of a reservoir usually entails large economic investments and the impact of a reservoir upon a river system can be quite substantial. Therefore, decisions regarding reservoir construction or operation have major effects on a regions economy and water supply system. The importance of reservoirs makes it essential that any analysis of their operation or feasibility be done as accurately as possible.

In the case when a reservoir is being proposed as part of a overall basin development plan little data is usually available and detailed rules for the reservoir operation do not exist. Under these conditions the simulation of the reservoir by a simple operating rule such as "the

standard operating rule" is often all that the data permits (see Lenton and Strzepek,1977). However, when modeling existing reservoirs or proposed reservoirs with detailed rules a simple operating rule is not sufficient to represent the reservoir's operation.

MITSIM-2 has incorporated a more detailed modeling of the reservoir node to allow for a more accurate simulation of reservoir operating practices. A " Discrete State-Discharge Operating Rule" has been introduced. This rule provides for the downstream discharge from the reservoir to be a function of : (1) the storage state of the reservoir and (2) the month of the year,(see Figure 4).

21m												
20m	12	12	12	12	8	6	6	6	8	12	12	12
				10								
19m	8	8	5	4	6	4	4	4	6	8	8	8
	6	6	4								6	6
18m	5	5								5	5	
	4	4								4	4	
	3	3								3	3	
17m	2*	2	2	2	2	2	2	2	2	2	2	2
	Jan	Feb	Mar	Apr	May	Jun	Jul	Aug	Sep	Oct	Nov	Dec

*Releases in m³/s

Figure 4. Discrete State-Discharge Operating Rule

The storage state is defined by discrete intervals . The reservoir volume at the beginning of month m ,plus the anticipated monthly inflow volume defines the discrete storage state of the reservoir from which the target downstream release is determined. The target release is then subtracted from the reservoir volume to determine the storage volume at the end of month m. Since many operating rules have continuous daily operating curves rather than discrete monthly zones, an algorithm to simulate a daily varying operating curve in monthly terms was developed. The

method is an iterative procedure. First, the model based upon the assumption that the monthly inflow is perfectly known at the beginning of each month and is evenly distributed over the month, determines the reservoir releases as discussed above. The storage level at the end of month m , after making the releases, is used to determine the release corresponding to that level, for month $m+1$. This release that is defined at the end of month m , is then combined with the release from the beginning of the month m , to determine a mean release assumed constant over the month m .

Another feature that has been added to the modeling of the reservoir node in MITSIM-2 is the ability to incorporate the stochastic behavior of downstream water use into the release rule for the reservoir, thereby establishing a "Dynamic Release Policy" as an option of the "Discrete State Discharge Operating Rule". When an agricultural area uses irrigation as a means to supplement water from precipitation the water withdrawal from the system are a function of precipitation. Also the supply of water from downstream tributaries or interflow can reduce the need for water from the reservoir to meet the irrigation water requirements. When the "Dynamic Release Policy" is invoked, the value in the Discrete State Discharge Operating Rule does not represent the amount of water to be released from the reservoir, but rather the amount of flow that must be achieved at some point downstream. This downstream amount could represent a minimum flow required in the stream for environmental, navigational, or industrial purposes. This option is achieved by inputting to the reservoir nodes the source and use nodes that occur between the reservoir and the downstream point of interest.

At the beginning of each month the inflows and precipitation are read into the model, the irrigation requirements for each month are calculated from the precipitation or read into the model for each of the irrigation nodes before the routing occurs. (See section below on irrigation node.) Thus the reservoir knows the amount of water that will enter the system from the start nodes and the actual amount of irrigation water demanded by the irrigation nodes. With this information the net gain or loss of flow between the reservoir and the downstream point can be calculated. The net flow over this portion of the system is added to or subtracted from the amount specified in the Discrete State Discharge Operating Rule to determine the amount of water needed to be released by the reservoir to meet this target. The amount that is released from the reservoir to meet this downstream requirement will vary for each month of the simulation period. This portion of the reservoir release is defined as the variable $VARREL(m,t)$, which has a minimum value of zero. The other water uses that require water from the reservoir that vary from month to month, but do not vary from year to year are input data to the reservoir node as $CONREL(m)$. This constant release is added to the variable release to arrive at a Total release for month m , and year t , $TOTREL(m,t)$,

$$TOTREL(m,t) = VARREL(m,t) + CONREL(m).$$

The Discrete State Discharge Operating Rule with Dynamic Release Policy allows the reservoir node to more realistically simulate the behavior of reservoir operators who do not have static rules, but adapt to the conditions in the reservoir, the inflow, downstream flow, and varying requirements. This level of reservoir modeling is necessary especially when dealing with a system which has supplementary irrigation or institutional constraints requiring downstream minimum flows, but can be easily simplified for the case when this level of detail is not necessary.

MITSIM-2 has added the possibility of joint multiple reservoir operation. It allows up to six reservoirs in parallel to operate jointly to meet a common water requirement. These reservoirs can not be in series. The algorithm that exist for the joint operation is that each reservoir releases all water that has been assigned higher priority than the common requirement. When all reservoirs in the joint operation mode have made these first priority releases the model samples all the reservoirs to calculate the amount of useable storage available in each. The total available storage in all the reservoirs is determined. If this is greater than the water requirement then the total joint release will be equal to the water requirement. If the total available storage is less than the water requirement the joint release will be equal to the total available storage. The percentage of the total joint release to be released by each reservoir is equal to the percentage of the total available storage that is found in each reservoir .

IRRIGATION NODES

The irrigation node represents agricultural land that withdraws water from the water resource system to provide all or part of the crop water requirement. Thus the irrigation node can represent an agricultural area under full irrigation or lands under supplementary irrigation . Due to the variety of possible irrigation systems, practices , and policies that can exist in all climatic zone MITSIM-2 has three different options for calculating irrigation water requirements at each node. These three different options may be used by different irrigation nodes in the same system during the simulation run since, the option is defined for each node and not the system as a whole.

The first and simplest option that is available is to consider irrigation requirements as constant from year to year. Each month m of the simulation period the amount of water to be withdrawn for irrigation purposes is assumed to remain constant. This could represent a situation where there is so little variation from year to year in precipitation and other water use factors that one can assume that the crop water requirements are deterministic. If one assumes the monthly precipitation to be a constant value and subtracts this value from the monthly crop water requirements then the remaining water requirements can be used as the monthly irrigation target to be met by the irrigation node.

The second option assumes that irrigation demands varies only as a function of precipitation. In this case the monthly precipitation time series is available for each irrigation node as input to the model for each month and year of the simulation period. Using the water available from

precipitation and the crop water requirements, the monthly water deficit is calculated. The amount of supplementary irrigation water that is needed will depend upon the irrigation practices and can be as a continuous function of precipitation or a step function with the step equal to the fixed amounts of water applied at each irrigation. This method also assumes that the time distribution of the precipitation over the month can be ignored. As mentioned above the time series of precipitation that is input to the model must correspond to the time series of streamflow to preserve statistical consistency.

The third option is to input a time series of monthly irrigation demands for any individual irrigation node. This time series must be calculated separately from the model and correspond to the time series of streamflow and precipitation as discussed earlier. This final option provides for a great deal of flexibility in the modeling of irrigation requirements. For example, if the irrigation demand is a function of daily temperature and precipitation, or some complex irrigation practices a separate irrigation simulation model could be used to calculate the daily water requirements and then aggregate to monthly values for input to MITSIM-2, (See Arthur, 1980).

DIVERSION NODES

The final extension incorporated in MITSIM-2 is the allocation of water at diversion nodes when there is a shortage of water. To provide for a more dynamic operating rule two options are possible. The first option is to allocate the water at a diversion node on the basis of the proportion of the target diversion for each downstream node to the sum of both diversion targets. For example, if downstream node1 requires 5 units of water in a given month and downstream node2 requires 10, then if there is less than 15 units entering the diversion node, downstream node1 will receive $5/15$ or $1/3$ of the entering water and downstream node2 will receive the remaining $2/3$. Since, the diversion targets may vary monthly the proportion allocated to each downstream node will depend upon the month of the shortage.

The other option is to give priority to one of the downstream nodes. This priority allows that node to have available a certain percentage of the flow entering the diversion node. This percentage, P , can vary from 0 to 100 percent. If the downstream node1 has a priority of 100 percent, then the model will try to provide it with 100 percent of the water entering the diversion node to a maximum of the diversion target, remainder will go to downstream node2. If the flow entering the diversion node is less than the target of downstream node1 then downstream node1 will receive all the water and downstream node2 will receive none. If the percentage is less than 100 percent then downstream node2 will be assured of at least $100-P$ percent of the entering flow. The percentage is constant over the year, but the targets are monthly values.

The remainder of this paper presents an illustration of the application of the MITSIM-2 model to an analysis of aggregated version of a regional water supply system in South Western Skåne, Sweden. The primary purpose of this study is to show the applicability of the MITSIM-2

model as a tool in policy analysis for short-term operational decisions and long-term regional water supply development alternatives

OVERVIEW OF WATER USE IN SOUTH WESTERN SKÅNE

The region upon which this study is based, South Western Skåne, is located in Southern Sweden and is delineated by the political boundaries of Malmöhus County (See Figure 5). Malmöhus is approximately 5,000 km² with a population of 740,000 inhabitants. It is approximately 70% agricultural land with a few large urban-industrial areas. Malmöhus county consists of 20 municipalities which are the basic unit of decision making in the Swedish political system. Within the region there is a potential for growth in both the industrial and agricultural sectors, which would bring about demographic as well as economic changes in the region. These demographic/economic changes are presently being studied by the Regional Development Task at IIASA (Snickars, 1981).

In the past the region had undergone a rapid growth in industrial development resulting in a shift in the regions population centers. Due to this past growth and the need to provide adequate water supply for municipal and industrial (M&I) demands the government in the early 1960's undertook a study of "how to meet the long range water supply needs of South Western Skåne". This study was completed in 1965 (SOU 1965:8).

MUNICIPAL AND INDUSTRIAL WATER

Until the late 1950's most water for municipal and industrial use was provided by groundwater. However, the observed trend in the growth of its urban population lead the city of Malmö in 1939 to petition the Swedish government for permission to extract 0.5 m³/sec from Vomb lake (see Figure 5). The Second World War slowed construction during which time the city of Lund also joined the project. In 1948 the waterworks and pipeline system was completed. In 1964 the Water Court allowed an increase in the extraction to 0.850 m³/sec and finally in 1969 it was raised to 1.5 m³/sec.

Following the lead of Malmö and Lund, Helsingborg and Landskrona, cities in northern Malmöhus county, began exploring surface water as a means to augment their groundwater sources. In 1950 they applied for .66 m³/sec to be withdrawn from Ring lake in Malmöhus county (see Figure 5.). In 1956 Eslöv joined the project. After Malmö and Lund joined the Ring project, the Water Court, in 1973, allowed the extraction from Ring lake to be increased to 1.125 m³/sec in 1980.

Over 65% of industrial water use is met by municipal water supply. The remaining 35% is met by self-supplied water from groundwater or small surface resources. If there is a growth in the industrial sector and the proportion of self-supplied to municipally supplied remains the same there will be a increase in demand for total municipal water.

The 1965 study of future water use in South Western Skåne attempted to forecast the demand for M&I water for the years 1980 and 2000. This study concluded that there were not enough water resources within the region of Malmöhus county to meet the projected demands. So

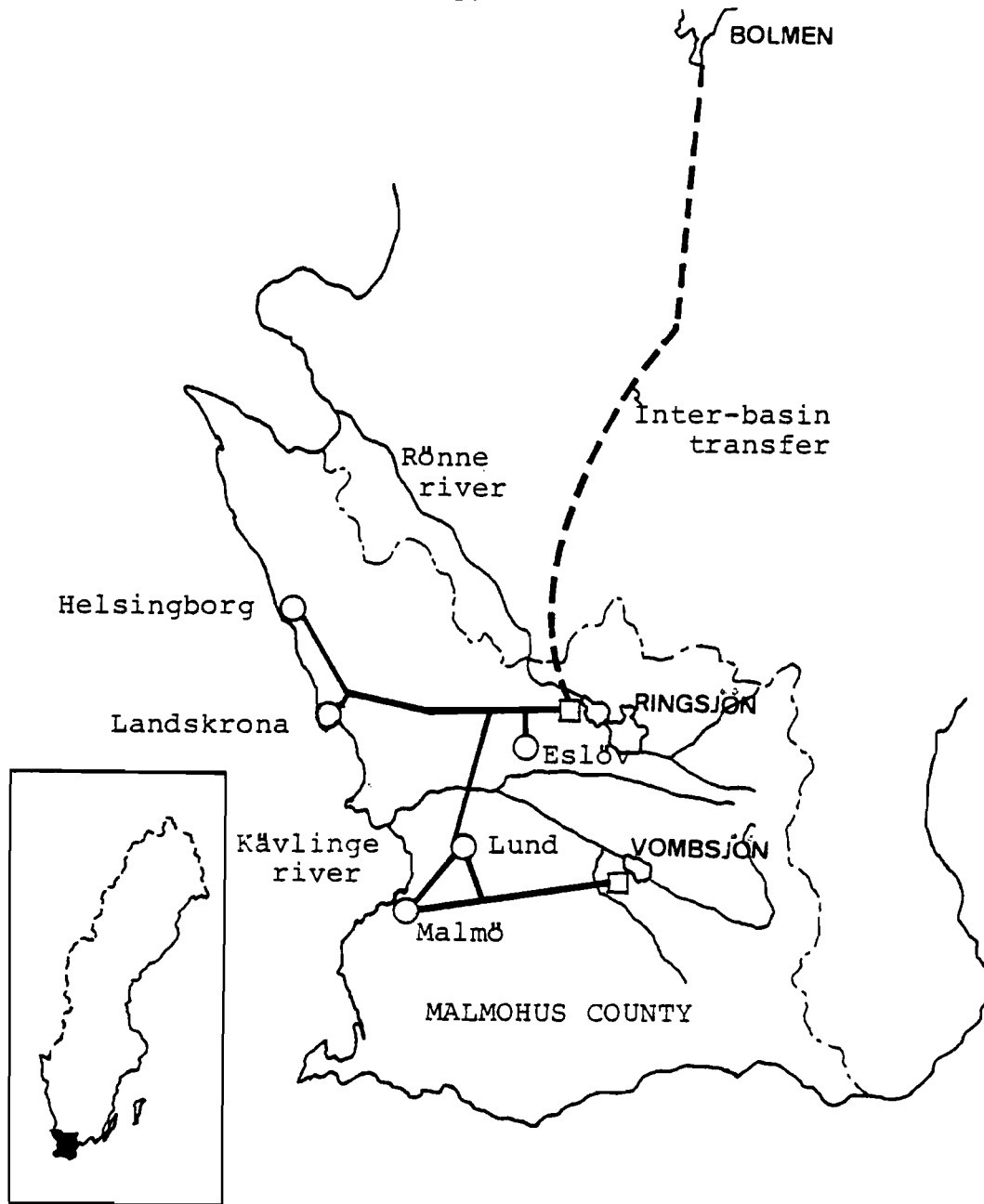

Figure 5. Case Study Region: South Western Skåne

the study proposed three alternative plans for the import of water from sources outside Malmöhus county.

After the study was released a group of five municipalities, which later grew to twelve, formed the Sydsvatten company to develop an adequate water supply to meet the long range future demands. They examined the alternatives and decided to petition the government to allow an extraction $6.5 \text{ m}^3/\text{s}$ from Bolmen lake and to transport the water by an 80 km tunnel and a pipeline to connect with the present Malmöhus water supply system. (See Figure 5.). In 1970 the government gave permission

for an extraction of $6.0 \text{ m}^3/\text{sec}$. The final design of the tunnel was completed and the construction began in 1975.

In the early 1970's it appeared that the M&I demand was not growing at the rate forecast by the 1965 government report. In 1974 the Ringsjön and Vombsjön water supply system were partially joined to allow for joint operation. This allowed the completion of the Bolmen project to be delayed until 1985. Finally in 1978 a thorough reexamination of future M&I water demand based upon the data of the 70's allowed for a another extension of the completion date until 1989. (Andersson, et al., 1979)

There are presently underway new studies of the projected regional economic development and population growth to provide for consistent and realistic forecasts of resource needs for the future, (Snickars, 1981). These studies will be used to forecast future water demands.

IRRIGATION WATER

An expansion of supplementary irrigation occurred in many areas of Sweden during the 1970's. This expansion was felt greatly in South Western Skåne, where about 70% of the land is agricultural and has easy access to waters of the two main river basins, the Kävlinge and Rönne River Basins.

The reasons for this expansion were threefold:

1. The six years of abnormally dry summers 1970-1975
2. The discovery that supplemental irrigation can help achieve high productivity and quality of crops.
3. The availability of low-cost and easily handled irrigation machinery. (Andersson, et al 1979).

The amount of land under supplementary irrigation, although it grew at a fast pace, now accounts for only approximately 10% of the land that potentially could be irrigated. Even though the present requirement for water for supplementary irrigation is small it is enough to conflict with the other use of the water in South Western Skåne (Fahlstedt, 1978).

With conflicts existing over water use with only a small portion of the total potentially irrigated land under irrigation there will be greater problems as irrigation expands in the future.

USE OF MITSIM-2 FOR ANALYSIS OF THE SOUTH WESTERN SKÅNE WATER SUPPLY SYSTEM

The objective in using simulation modeling in this study is to analyze the performance of the water resource system of South Western Skåne under various water demand scenarios and institutional constraints. As was mentioned above there are presently two major sub-regional M&I water supply systems in South Western Skåne, Vombsjön and Ringsjön. These systems are operated separately, but are weakly linked through the city of Lund. There is the possibility to totally integrate the two system into one jointly operated regional system. In addition there is the option to import water to the regional system by means of the Bolmen Project. The goal of this analysis is to study the effect of natural

variability in hydrologic phenomena and the variability of demand on the performance of the regionally integrated water resource system. This analysis is primarily carried out to demonstrate the applicability of the MITSIM-2 model, therefore it is not concerned with the performance of each individual M&I demand, but rather with the performance of the supply system as a whole.

To apply MITSIM-2, first it is necessary to conceptualize the water resource system of South Western Skåne into a series of water supply and use nodes linked by arcs. For this aggregated analysis of the whole system the spatial distribution of the demand is not relevant, therefore all M&I demand is represented as one node. This conceptualization is shown in Figure 6 for the regional integrated system.

With the conceptualization of the system and the data on precipitation, streamflow, irrigation requirements and M&I use, it is possible to simulate the performance of the water resource system.

DATA , PROCEDURES AND SCENARIO GENERATION

The length of the simulation runs that were performed was 75 years. The precipitation data were historic daily values from Lund from 1900-1974 aggregated to monthly values. Due to the small size of the basin the precipitation was assumed to be homogeneous over the basin on a monthly time scale . This allows the Lund data to be used for all points in the basin. It should also be recognized that no other precipitation stations in the basin had a sufficiently long record.

The 75 year precipitation record at Lund was the driving function for several other stochastic inputs to the simulation runs. Arthur(1980) developed a model to simulate farmers irrigation practices as a function of daily precipitation. With this model it was possible to determine the monthly water requirements for the different crops grown in South Western Skåne on a per hectare basis for each month of the 75 years. This data was then combined with information on the cropping pattern at the various irrigation nodes in the basin to determine the monthly water requirements for supplementary irrigation for the entire 75 year period. If the cropping pattern or amount of land under irrigation changes , it is possible to calculate a new time series of water requirements , by multiplying the water per unit crop area values by the new areas. These monthly water requirements are then fed into the model as input.

Streamflow data for the two basins exists for approximately the last 25 years. A statistical analysis was performed to examine the correlation between monthly precipitation at Lund and streamflow at several points in the two basins. It was found that monthly precipitation data at Lund could be used to reconstruct missing monthly streamflow values throughout the basins. Using this information a 75 year time series of monthly streamflow was generated for various inflow and interflow locations in the basin, (Kindler and Feiuch, 1981).

By using the 75 year historic record of precipitation at Lund to generate the irrigation requirements and the streamflow it was possible to obtain a consistent set of data to analyze the interaction of a complex water resource system. Since one of the important interactions to be

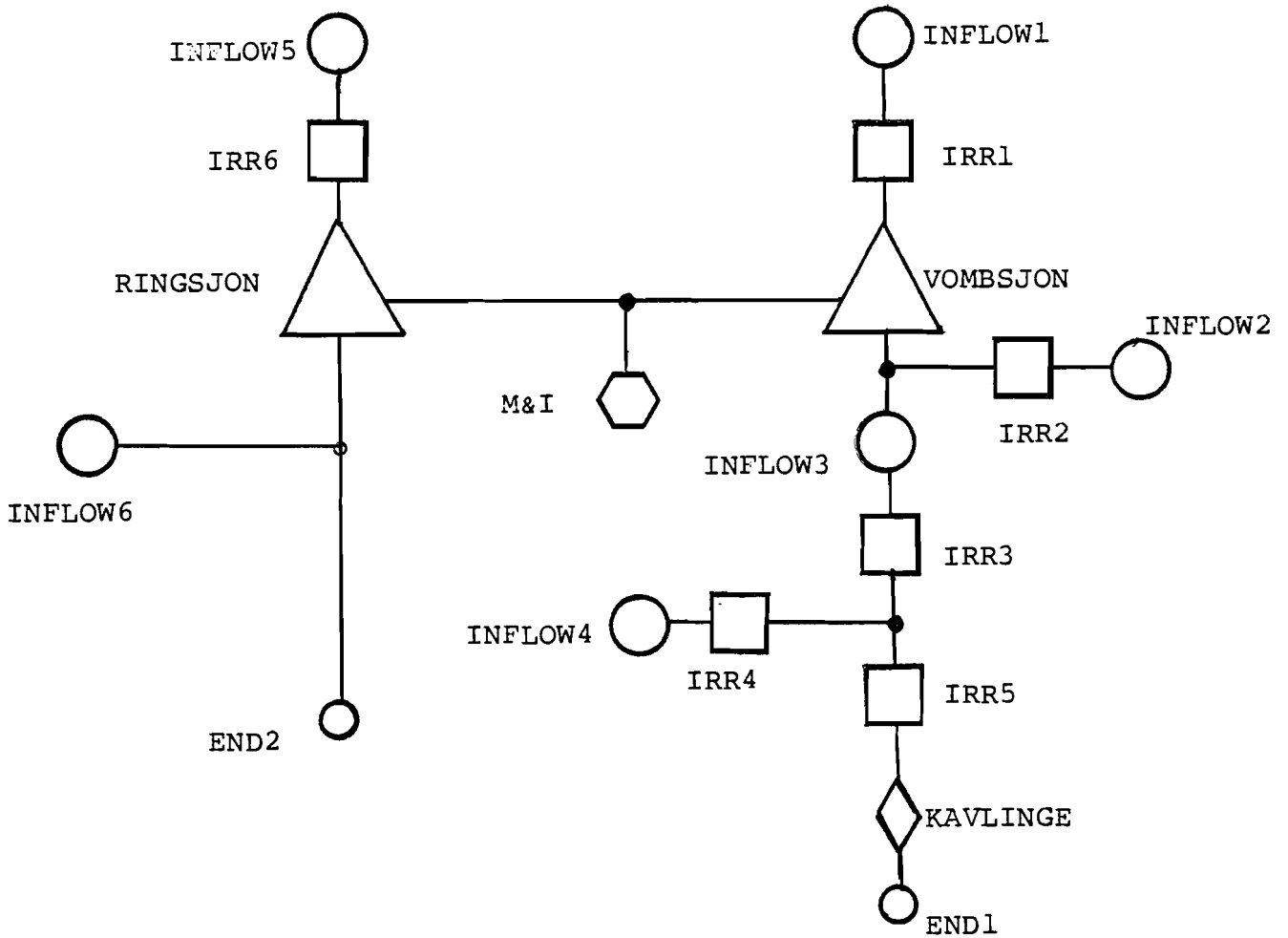

Figure 6. Integrated Regional System

analyzed is the conflict between M&I and irrigation water uses it was important to preserve the temporal correlation between precipitation, streamflow, and irrigation requirements which is important to expose a lack of water resources during times of drought.

For this analysis groundwater is considered to have a long time response and not greatly effected by short term fluctuations in precipitation on a regional scale. Therefore groundwater is considered as a constant source of water for M&I use which is adjusted to account for only the use that must be supplied from surface sources. Thus groundwater is

not considered in the simulation analysis for such a regionally aggregated system.

The nature of this analysis is to examine the reliability of the regionally integrated water supply system of South Western Skåne under various water use scenarios. The system that will be examined is that shown in Figure 6. For this analysis the two reservoirs, Ringsjön and Vombsjön, are operated jointly to meet the given aggregate M&I requirements at node M&I. The reservoirs will operate based on the available storage in each reservoir as describe in the section above. There will be two major water use scenarios that will be investigated. The first scenario assumes no irrigation in the basin and the second assumes irrigation withdrawals to be at the potential maximum for the basin as forecast by the County Board(Fahlstedt,1978).

The objective of this study was not to provide an analysis of the problems facing water planner in South Western Skåne, but to show the applicability of the simulation approach and MITSIM-2 in particular to provide information for water management decisions that must be made. In this regard there is no attempt in this study to predict future M&I water requirements. Instead , a parametric analysis of M&I water use was made . By examining a wide range of water use scenarios ,from no irrigation with low M&I use to full potential irrigation with high M&I use, the ability of the model to provide useful information for decision makers and planner would be tested.

RESULTS

Two series of runs of the model were made for the each of the irrigation scenarios in the basin. Each run in the series was performed with a different target for the annual M&I water use. Monthly M&I water use targets were obtained by assuming that water use is uniform over the year .With this assumption the monthly targets are defined as a percentage of annual target calculated by the ratio of the number of days in the month to the total number of days in the year(365).

Although the model provides much detailed information on the performance of the system , some aggregate indicators of system performance that may be of interest to water managers for this system are presented in the tables of results. These indicators ;the mean annual supply of M&I water by the system ,the reliability of the annual and monthly M&I water use target, and the magnitude of the monthly and annual deficit if the target supply is not met .

The results of the system's performance to each level of M&I target water use as describe by the aggregate performance indicator are presented in tabular form below. Table 2 present the results for the no irrigation scenario and Table 3 provides the results for the potential maximum irrigation scenario. These tables provide useful information about the response of the system to various M&I water use targets. With this data a decisionmaker or planner can compare the performance of the system under the two irrigation scenarios and examine the effects of irrigation development on the ability of surface water to supply different levels of M&I water use. This is the type of information that is helpful in

Table 2. System Performance with No Irrigation Scenario

Annual M&I Target MCM	Mean Annual M&I Supply MCM	Jan	Feb	Mar	Apr	May	Jun	Jul	Aug	Sep	Oct	Nov	Dec
		Monthly Reliability (%)											
		Mean Monthly Deficit (MCM)											
25.	25.	100.	100.	100.	100.	100.	100.	100.	100.	100.	100.	100.	100.
		0.	0.	0.	0.	0.	0.	0.	0.	0.	0.	0.	0.
50.	49.98	100.	100.	100.	100.	100.	100.	100.	100.	100.	99.	100.	100.
		0.	0.	0.	0.	0.	0.	0.	0.	0.	.04.	0.	0.
60.	59.9	100.	100.	100.	100.	100.	100.	100.	100.	100.	97.	100.	100.
		0.	0.	0.	0.	0.	0.	0.	0.	0.	.08	0.	0.
75.	74.3.	100.	100.	100.	100.	100.	100.	99.	98.	95.	96.	99.	100.
		0.	0.	0.	0.	0.	0.	.06	.11	.24	.19	.06	0.
82.	80.7	100.	100.	100.	100.	100.	99.	97.	95.	87.	93.	97.	100.
		0.	0.	0.	0.	0.	.02	.10	.25	.52	.28	.10	0.
90.	87.5	100.	100.	97.	100.	100.	99.	95.	91.	77.	88.	96.	99.
		0.	0.	.02	0.	0.	.08	.24	.39	1.02	.58	.16	.01
100.	95.1	100.	99.	96.	100.	99.	97.	93.	80.	67.	79.	91.	99.
		0.	.02	.10	0.	.04	.11	.43	.93	1.95	.97	.32	.02
120.	109.3	99.	96.	96.	99.	99.	92.	79.	67.	57.	75.	84.	93.
		.08	.15	.22	.04	.11	.30	1.39	2.56	3.38	1.71	.60	.14
150.	124.5	97.	95.	92.	97.	92.	76.	64.	45.	25.	48.	72.	84.
		.21	.40	.46	.19	.41	1.66	3.52	5.33	7.21	3.97	1.37	.83
200.	140.9	92.	89.	83.	88.	77.	53.	37.	13.	3.	23.	60.	71.
		.57	.93	1.40	1.04	2.16	5.29	8.29	12.13	13.74	8.33	3.20	2.06

deciding the adequacy of the system to meet present and future demands.

This study was to show the applicability of MITSIM-2 to address long range planning issues for systems that have detailed operational rules or important hydrologic phenomena that occur at a small time scale. It was not intended to provide an analysis of the water management problems facing the planners and decisionmakers in South Western Skåne . It did show that MITSIM-2 can be a valuable tool to answer some of the questions related to the long range planning of Water Resources in South Western Skåne, when confronted detailed operational questions such as supplemental irrigation, M&I water use and complex institutional constraints.

Table 3. System Performance with Potential Maximum Irrigation Scenario

Annual M&I Target MCM	Mean Annual M&I Supply MCM	Jan	Feb	Mar	Apr	May	Jun	Jul	Aug	Sep	Oct	Nov	Dec
		Monthly Reliability (%)											
		Mean Monthly Deficit (MCM)											
25.	25.	100.	100.	100.	100.	100.	100.	100.	100.	100.	97.	100.	100.
		0.	0.	0.	0.	0.	0.	0.	0.	0.	0.	.05	0.
50.	49.5	100.	100.	100.	100.	100.	100.	99.	97.	92.	95.	99.	100.
		0.	0.	0.	0.	0.	0.	.00	.08	.28	.17	.03	0.
60.	58.9	100.	100.	100.	100.	100.	100.	97.	93.	84.	93.	99.	100.
		0.	0.	0.	0.	0.	0.	.07	.22	.51	.29	.05	0.
75.	71.7	100.	100.	100.	100.	100.	97.	95.	81.	68.	87.	98.	100.
		0.	0.	0.	0.	0.	.11	.30	.72	1.52	.50	.13	0.
82.	80.7	100.	100.	99.	100.	99.	97.	92.	71.	64.	81.	96.	100.
		0.	0.	.00	0.	.01	.15	.41	1.30	2.03	.72	.15	0.
90.	83.1	100.	99.	97.	100.	99.	96.	85.	68.	57.	75.	92.	97.
		0.	.03	.04	0.	.05	.22	.70	2.04	2.47	1.13	.24	.02
100.	90.1	99.	99.	96.	100.	99.	95.	77.	63.	51.	75.	89.	97.
		.03	.04	.10	0.	.11	.33	1.45	2.67	3.34	1.43	.37	.05
120.	102.4	99.	96.	96.	99.	97.	80.	67.	55.	35.	60.	81.	92.
		.09	.17	.22	.04	.14	1.02	3.01	3.90	5.35	2.70	.71	.24
150.	115.8	96.	95.	92.	97.	89.	67.	51.	32.	16.	37.	68.	84.
		.23	.40	.46	.20	.79	2.97	5.00	7.63	8.98	4.95	1.72	.83
200.	131.7	92.	89.	83.	88.	73.	47.	23.	9.	0.	20.	59.	71.
		.57	.83	1.40	1.05	2.85	7.20	10.90	13.90	15.13	8.96	3.39	2.06

CONCLUSIONS

The analysis of the various water use scenarios for South Western Skåne provide some valuable insight the type and limitation of data available from MITSIM-2. The ability to model the important short term operational as well as long range issues facing regional water management in South Western Skåne shows the usefulness and applicability of MITSIM-2 as a planning and operational tool. The inability of MITSIM-2 to model precisely the daily operational rules of the reservoirs and the integrated systems shows one of the limitations that results from the trade-off between costs and accuracy. No model can perform all tasks and this demonstrates the need for a variety of tools to perform the analyses that are needed in regional water management. However, MITSIM-2 does provide valuable information for decisionmakers for planning long term water management systems.

REFERENCES

- Alarcon, L.F., and D.H. Marks, (1979) *A Stochastic Dynamic Programming Model for the Operation of the High Aswan Dam*, Technical Report No. 246 Ralph M. Parsons Laboratory for Water Resources and Hydrodynamics, Department of Civil Engineering, Massachusetts Institute of Technology, Cambridge, Massachusetts
- Andersson, A.E., P. Hjoirth, L. de Mare, and A.S. Thelander, (1979) *Water Resources Planning and Management in Advanced Economies: The Case Study of Western Skåne, Sweden- A Background Report*, Working Paper WP 79-23. International Institute for Applied Systems Analysis, Laxenburg, Austria
- Anderson, R.J. (1981) *The Economic Analysis of Supplementary Irrigation in Skåne*, Research Report (Forthcoming). International Institute for Applied Systems Analysis, Laxenburg, Austria
- Arthur, S.P., (1980) *Irrigation in Skåne- Estimated Water Needs and Effect on Water Available to Crops*, Working Paper WP 80-112. International Institute for Applied Systems Analysis, Laxenburg, Austria
- Fahlstedt, T. (1978), *Betvattning inom Kaulingeans avrinningsområde*, Lantbruksnamnden i MA.
- Fiering, M.B., (1967) *Streamflow Synthesis*, Harvard University Press, Cambridge, Massachusetts
- Hufschmidt, M.M. and M.B. Fiering (1966), *Simulation Techniques for Design of Water Resource Systems*, Harvard University Press, Cambridge, Massachusetts
- Jacoby, H.D., and D.P. Loucks, (1972), "Combined Use of Optimization and Simulation Models in River Basin Planning", in *Water Resources*

Research, vol.8.No.6.

- Kindler,J.,(1977)," The Monte Carlo Approach to Optimization of the Operation Rules for a System of Storage Reservoirs", *in Hydrological Sciences Bulletin*, XXII,1 3/1977.
- Kindler,J. and H. Feluch ,(1981) *Hydrologic Analysis of the Kävlinge and Rönne River Basins*, Working Paper (Forthcoming). International Institute for Applied Systems Analysis, Laxenburg, Austria
- Lenton,R.L.,and K.M. Strzepek,(1979), *Theoretical and Practical Characteristics of the MIT River Basin Simulation Model*, Technical Report No. 225 Ralph M. Parsons Laboratory for Water Resources and Hydrodynamics, Department of Civil Engineering, Massachusetts Institute of Technology, Cambridge, Massachusetts
- Lewis,D.J., and L.A. Shoemaker,(1962),"Hydro System Power Analysis by Digital Computer", *in Journal of Hydraulics Division* , American Society of Civil Engineers 88(HY-3): 113-130.
- Maass,A.M.,M.M. Hufschmidt,R. Dorfman,H.A.Thomas,S.A. Marglin, and G.W. Fair, (1962), *Design of Water Resource Systems*, Harvard University Press, Cambridge, Massachusetts
- Major,D.C. and R.L.Lenton,(1979), *Applied Water Resource Systems Planning*, Prentice-Hall,Inc.,Englewood Cliffs,New Jersey
- McBean,E.A.,R.L. Lenton,G.Vicens, and J.C. Schaake,(1973), *A General Purpose Simulation Model for Analysis of Surface Water Allocation Using Large Time Increments*, Technical Report No. 160 Ralph M. Parsons Laboratory for Water Resources and Hydrodynamics, Department of Civil Engineering, Massachusetts Institute of Technology, Cambridge, Massachusetts
- Morrice,H.A.W.,(1958) "The Use of Electronic Computing Machines to Plan the Nile Valley as a Whole", *International Association of Scientific Hydrology*, vol 3. Publication No. 45: 95-105, Gentbrugge,Belgium
- Morrice,H.A.W.and W.N. Allan,(1959),"Planning for the Ultimate Hydraulic Development of the Nile Valley, *Proc. Institute of Civil Engineers*, 14:101-156
- Rippl,W.,(1883),"The Capacity of Storage Reservoirs for Water Supply", *Proc. Institute of Civil Engineers*, vol.71
- Schaake,J.C.,T.B.Facet,K.M.Leytham, and E.A.McBean,(1974), *Systematic Approach to Water Resources Plan Formulation*, Technical Report No. 187 Ralph M. Parsons Laboratory for Water Resources and Hydrodynamics, Department of Civil Engineering, Massachusetts Institute of Technology, Cambridge, Massachusetts
- Shah,M.M., (1975) "System Engineering Approach to Agricultural and Rural Development Systems" in *Computer Simulation of Water Resource Systems*, edited by G.C. Varrsteenkiste, American Elsevier Publishing Company
- Snickers, F. (1981) *Comparative Studies of Regional Planning Models-with Special Emphasis on a Case Study of South Western Skåne*, Working Paper WP 81-48. International Institute for Applied Systems Analysis, Laxenburg, Austria

- SOU 1965:8 (1965) *Skånes och Hallands Vattenförsörjning*, Ministry of Communications, Stockholm, Sweden
- Strzepek, K.M., (1981) *A User's Manual for MITSIM- 2: A Planning and Operational River Basin Simulation Model*, Working Paper (Forthcoming). International Institute for Applied Systems Analysis, Laxenburg, Austria
- Strzepek, K.M. and R.L. Lenton, (1978), *Analysis of Multipurpose River Basin Systems: Guidelines for Simulation Modelling*, Technical Report No. 236 Ralph M. Parsons Laboratory for Water Resources and Hydrodynamics, Department of Civil Engineering, Massachusetts Institute of Technology, Cambridge, Massachusetts
- Strzepek, K.M. and D.H. Marks, (1981), "River Basin Simulation Models: Guidelines for Their Use in Water Resource Planning", *Water Resources Bulletin*, Vol. 17, No. 1
- Strzepek, K.M., M.S. Rosenberg, D.G. Goodman, R.L. Lenton, and D.H. Marks, (1979), *User's Manual for the MIT River Basin Simulation Model*, Technical Report No. 242 Ralph M. Parsons Laboratory for Water Resources and Hydrodynamics, Department of Civil Engineering, Massachusetts Institute of Technology, Cambridge, Massachusetts
- Texas Water Development Board Report, (1974) *Economic Optimization and Simulation Techniques for Management of Regional Water Resources*, Report No. 179
- U.S. Army Corps of Engineers, (1957) *Report on the Use of Electronic Computers for Integrated Reservoir Operations, Vol. 1, DATAmatic Corporation*, prepared in cooperation with the Raytheon Manufacturing Company for the U.S. Army Corps of Engineers, Missouri River Division.