

CP - 74 - 1

INTERNATIONAL INSTITUTE FOR **IIASA** APPLIED SYSTEMS ANALYSIS
CONFERENCE PROCEEDINGS

MULTILEVEL COMPUTER MODEL
OF
WORLD DEVELOPMENT SYSTEM

April 29–May 3, 1974

SUMMARY OF THE PROCEEDINGS

M. Mesarovic & E. Pestel, Editors

SCHLOSS LAXENBURG
2361 Laxenburg
AUSTRIA

CP-74-1

MULTILEVEL COMPUTER MODEL OF WORLD DEVELOPMENT SYSTEM

April 29 - May 3, 1974

SUMMARY OF THE PROCEEDINGS

M. Mesarovic & E. Pestel, Editors

The views expressed are those of the contributors and not necessarily those of the Institute.

The Institute assumes full responsibility for minor editorial changes made in grammar, syntax, or wording, and trusts that these modifications have not abused the sense of the writers' ideas.

TABLE OF CONTENTS

Agenda	1
List of Participants	4
MINUTES OF THE RESEARCH PLANNING CONFERENCE ON GLOBAL MODELLING	
Preliminaries: Introduction by Professor Howard Raiffa	15
Introduction and Overview of the Symposium	20
Motivation, Objectives, and Conceptual Foundation M. Mesarovic and E. Pestel	21
Overall Methodology of Model Construction and Its Use as A Planning Tool	31
Discussion	33
Discussion on "World Population Model and Analysis of Population Policy" by Dr. W. Paul	34
Prof. Rademaker's Remarks	36
Discussion on "Food Production and Nutrition Model" by Dr. P. Clapham	38
Discussion on "Integrated Food Supply and Need Model and Assessment of Long Term World Food Crisis" by Dr. J. Richardson	40
Discussion on "The Energy Resources Model" by Dr. H. Maier and "The Energy Supply Model" by Dr. H. Bossel	42
Discussion on "The Energy Demand Model" by Prof. B. Hughes	44
Discussion on "The Integrated World Model" by Prof. B. Hughes	45

Discussion on "The Macro-Economic World Model"	47
Informal Evening Session	49
Discussion on "Scenario Type Analysis" by Prof. P. Gille and Prof. T. Shook	52
Discussion on Global Modelling	54
Discussion on "Ergonomics of Man-Machine Interaction" by Prof. J. Klabbers	57
Discussion on "The Environmental Impact Model"	61
Discussion on "Development of Norm Stratum Model" by Dr. H. Bossel and Prof. B. Hughes	64
Session on Thursday Afternoon	66
An Austrian Simulation Model for Socio-Economic Policy Making P. Fleissner	67
Some Remarks about the Dynamics of the Economic System and Its Links Especially with the Technological Field H. Mottek	70

PAPERS CONTRIBUTED BY PARTICIPANTS

Modelling Growth Factors in Israel Prof. Nathan Buras	
Dynamic Population Model A. R. Demirdache	
Notes on the "Doubling of Population" Study Prof. H. Linneman	
Conflict Dynamics in the Context of Global Modelling P.K. McPherson	
The General Production Function as a Contribution to Global Modelling H. Millendorfer and C. Gaspari	
Theses to Model-building and Possible Consequences M. Peschel	
Project Group Global Dynamics Progress Report No. 1 and 2 ir. O. Rademaker	

Modelling Work of the Systems Analysis Research
Unit in the Department of the Environment,
United Kingdom
P.C. Roberts

A System Theoretic Consideration of the
World Model
Yasuhiko Takahara

Roberto Vacca - Italy

AGENDA

April 29 to May 3, 1974

Hotel Gutenbrunn, Baden near Vienna

Chairmen: Professor Mihajlo Mesarovic, Case Western Reserve University, Cleveland, Ohio; and Professor Eduard Pestel, Technische Hochschule Hannover

Monday, 29 April

- | | | |
|---------------|---|---------------|
| 9:00 - 9:30 | Welcome and introduction to IIASA by the Director, Professor Howard Raiffa | |
| 9:30 - 10:35 | Introduction and overview of the symposium | M. Mesarovic |
| | Motivation, Objectives, and Conceptual Foundation | E. Pestel |
| 10:35 - 10:55 | Coffee | |
| 10:55 - 12:15 | Overall Methodology of Model Construction and Its Use as A Planning Tool | M. Mesarovic |
| 12:15 - 14:00 | Lunch | |
| 14:00 - 15:50 | World Population Model and Analysis of Population Policy Alternatives | W. Paul |
| | Food Production and Nutrition Model | P. Clapham |
| 15:50 - 16:10 | Coffee | |
| 16:10 - 17:30 | Integrated Food Supply and Need Model and Assessment of Long Term World Food Crisis | J. Richardson |

Tuesday, 30 April

- | | | |
|--------------|---|-----------|
| 9:00 - 10:30 | Energy Resources Model | H. Maier |
| | Energy Supply Model and Its Use for Technology Assessment | H. Bossel |

10:30 - 10:50	Coffee	
10:50 - 12:15	Energy Demand Model	B. Hughes
	Integrated World Oil Model and Assessment of Competition in Oil Supply and Demand	B. Hughes
12:15 - 14:00	Lunch	
14:00 - 15:30	Structure for Regionalized Macro- Economic World Model	L. Klein B. Hickman
	Estimation for Macro-Economic Model	M. McCarthy
15:30 - 15:50	Coffee	
15:50 - 17:30	Implementation of Macro-Economic Model	P. Gille
	Implementation of Micro-Economic Model	W. Ströbele
	Analysis of Statistical Error in World Economic Model	G. Blankenship

Tuesday Informal Evening Session*

Wednesday, 1 May

9:00 - 10:30	Scenario Type Analysis	P. Gille T. Shook
	Interactive Mode Analysis	F. Rechenmann M. Warshaw
10:30 - 10:50	Coffee	
10:50 - 12:15	Computer Software Support	J. Mermet
	Ergonomics of Man-Machine Inter- action	J. Klabbers
12:15 - 14:00	Lunch	
14:00 - 17:30	Demonstration of Scenario	
	Analysis of Interactive Model Simulation	P. Gille F. Rechenmann T. Shook M. Warshaw

* The conference participants had agreed among themselves that an informal, extra-curricular session to discuss modelling would be beneficial, and so a session was held Tuesday evening.

Thursday, 2 May

9:00 - 10:35	Environmental Impact Model	M. Gottwald R. Pestel
	Regionalized Model of Global Water Cycle	M. Cardenas H. Kleeberg
10:35 - 10:55	Coffee	
10:55 - 12:15	Development of Norm Stratum Model	H. Bossel B. Hughes
	Mathematical General Systems Research for Analysis of World Systems	Y. Takahara

LIST OF PARTICIPANTS

Chairmen

Professor Mihajlo Mesarovic
Case Western Reserve University
Cleveland, Ohio

Professor Eduard Pestel
Technische Hochschule Hannover
Lehrstuhl A für Mechanik

Nominations by National Member Organizations

Austria

The Austrian Academy of Sciences

Professor Leopold Schmetterer
Österreichische Akademie der
Wissenschaften
Kommission für Sozio-Ökonomische
Entwicklungsforschung
Fleischmarkt 22
1010 Wien

Dr. Peter Fleissner
Österreichische Akademie der
Wissenschaften
Kommission für Sozio-Ökonomische
Entwicklungsforschung
Fleischmarkt 22
1010 Wien

Dipl. Ing. Wolfgang Blaas
Institut für Finanzwissenschaft
und Infrastrukturpolitik der
Technischen Hochschule Wien
Karlsplatz 13
1040 Wien

Dr. Christoph Gaspari
Studiengruppe für Internationale
Analysen
c/o ÖFSE
Turkenstrasse 3
1090 Wien

Bulgaria

The National Centre for
Cybernetics and Computer
Techniques

Prof. Ivan Nicolov
The National Centre for
Cybernetics and Computer
Techniques
8, Slavjanska Street
Sofia

Bulgaria (con't)

Mr. Ognian Panov
Senior Research Worker
The National Centre for
Cybernetics and Computer
Techniques
8, Slavjanska Street
Sofia

Canada

The Canadian Committee for
the IIASA

Dr. J. A. Coleman
Mathematics Study Group
Science Council of Canada
Kent-Albert Building
Ottawa, Ontario

Dr. A. R. Demirdache
Director of TF/TA Division
Cooperation Branch
Ministry of State for
Science and Technology
Ottawa, Ontario

Federal Republic of Germany
The Max-Planck Society

Prof. Dr. Carl Friedrich
Frhr. von Weizsäcker
Max-Planck-Gesellschaft zur
Erforschung der Lebensbedingungen
der wissenschaftlichtechnischen
Welt
Starnberg

Dr. Walter Bonhoeffer
Max-Planck-Gesellschaft zur
Erforschung der Lebensbedingungen
der wissenschaftlichtechnischen
Welt
Starnberg

France
A.F.D.A.S.

German Democratic Republic
The Academy of Sciences

Prof. Dr. Manfred Peschel
The Academy of Sciences of the GDR
Forschungsbereich Mathematik/
Kybernetik
Rudower Chaussee 5
1199 Berlin

German Democratic Republic
(con't)

Prof. Dr. Hans Mottek
Rat für Umweltgestaltung
Academy of Sciences of the GDR
Leipziger Strasse
108 Berlin

Italy
Italian Committee for Liaison
with IIASA

Prof. Luigi Mariani
Istituto di Elettrotecnica
ed Elettronica
University of Padova
35100 Padova

Ing. Giorgio Bolognesi
Direttore di Pianificazione
e Sviluppo
FIAT
Torino

Prof. Sergio de Julio
Istituto di Automatica
University of Rome
Via Eudossiana, 18
Rome

Japan
The Japan Committee for the IIASA

Dr. Shumpei Kuman
University of Tokyo
Bunkyo-ku
Tokyo

Dr. Yoichi Kaya
Associate Professor
University of Tokyo
Bunkyo-ku
Tokyo

Dr. Takehiko Matsuda
Tokyo Institute of Technology
Meguro-ku
Tokyo

Poland
Polish Academy of Sciences

Professor Roman Kulikowski
The Polish Academy of Sciences
Palace of Culture and Science
00-901 Warsaw

United Kingdom
The Royal Society

Dr. J. F. Coales, O.B.E., F.R.S.
University Engineering Department
Control Engineering Group
Cambridge, CB2, ISF

Mr. P. C. Roberts
Department of Environment
2 Marsham Street
London

Prof. P. K. McPherson
Department of Systems Science
City University
St. Johns Road
London

U.S.A.
The National Academy of Sciences

Dr. Martin Shubik
Cowles Foundation for Research
in Economics
Yale University
New Haven, Connecticut

U.S.S.R.
The Academy of Sciences

Dr. Ivanov
The Academy of Sciences
State Committee for USSR
Council of Ministers for Science
and Technology
11, Gorky Street
Moscow

Dr. Fatkin
The Academy of Sciences
State Committee for USSR
Council of Ministers for Science
and Technology
11, Gorky Street
Moscow

Dr. Kichatov
The Academy of Sciences
State Committee for USSR
Council of Ministers for Science
and Technology
11, Gorky Street
Moscow

U.S.S.R. (con't)

Dr. Dyokalov
The Academy of Sciences
State Committee for USSR
Council of Ministers for Science
and Technology
11, Gorky Street
Moscow

Dr. Tokarev
The Academy of Sciences
State Committee for USSR
Council of Ministers for Science
and Technology
11, Gorky Street
Moscow

Other Invited Participants

Prof. Gert v. Kortzfleisch	Industrieseminar der Universität Mannheim
Prof. Dr. B. Fritsch	Institut für Wirtschaftsforschung der Technischen Hochschule Zürich
Dr. Carlos A. Mallmann	Fundacion Bariloche Prov. de Rio Negro Argentina
Dr. Amilcar O. Herrera	Fundacion Bariloche Director of Latin American World Model Program Prov. de Rio Negro Argentina
Dr. Sam Cole	University of Sussex Science Policy Research Unit Brighton, Sussex
Prof. ir. O. Rademaker	Technische Hogeschool Eindhoven Eindhoven, Netherlands
Prof. Maurice F. Strong	United Nations Environment Program Executive Director Nairobi, Kenya
Dr. Eleonora Masini	IRADES Rome
Prof. Ferenc Rabar	INFELOR Budapest
Prof. John A. Hrones	Case Western Reserve University Cleveland, Ohio
Dr. Maurice Guernier	7, avenue de la Bourdonnais 75007 Paris
Dr. Kaarlo Larna	The Research Institute of the Finnish Economy Managing Director Helsinki
Prof. Dr. Bert G. Hickman	Department of Economics Stanford University Stanford, California

Professor Roberto Vacca	Compagnia Generale Automazione S.p.A. Rome
Prof. Walter Labys	Insitut Universitaire des Hautes Etudes Internationales, Geneva
Dr. Michael Abkin	Michigan State University East Lansing, Michigan
Prof. S. Bjørnholm	University of Copenhagen Niels Bohr Institutet Copenhagen
Ing. G. C. Garcia	Ministry of Water Resources Mexico
Dr. Sandor Ganczer	President of the Hungarian Committee for Applied Systems Analysis Director, Research Insitute for Economic Planning Budapest
Lord Kennet (after April 30)	Commission of the European Communities London
Mr. Manfred Siebker	S.C.I.E.N.C.E. Managing Director Bruxelles
Mr. John Garbutt	VRIJE Universiteit Amsterdam Economische en Sociaal Instituut
Mr. J. Kumpf	Chief, Environmental Health World Health Organization (WHO) Copenhagen
Dr. Erich Zahn	Industrieseminar der Universität Mannheim
Dr. Mary Mauksch	ITT-Europe, Inc. Bruxelles
Dr. Jürgen Seetzen	International Institute for the Management of Technology Milano
Dr. Sinclair	International Institute for the Management of Technology Milano
Prof. Roger Garandy	69 rue de Suez 94 Chennevieres France

Observers

Prof. G. Bergendahl	European Institute for Advanced Studies in Management Bruxelles
Mr. Edsbacker	European Institute for Advanced Studies in Management Bruxelles
Prof. Nathan Buras	Department of Agricultural Engineering Technion Haifa, Israel
Prof. "Skip" Porter	University of Louisville Louisville, Kentucky
Prof. Sergio Limberti	IRADES Rome
Mr. Farmer	FIAT Torino
Prof. T. Murakami	University of Tokyo
Univ. Prof. Dr. W. Clement	J. Schrafflstrasse 27 6020 Innsbruck
Dr. Hans Peter Aubauer	Alserstrasse 12/8 1090 Wien
Dr. Klaus Draxler	Österr. Studiengesellschaft für Atomenergie GMB Forschungszentrum Seibersdorf
Doz. Dr. Robert Trappl	Österr. Studiengesellschaft für Kybernetik Schottengasse 3 1010 Wien
Dipl. Ing. E. Deutsch	Institut für Ökonometrie der Technischen Hochschule Wien
Dr. Wolfram Schläffer	IBM-ROECE Wien
Dr. Gerold Patzak	Technische Hochschule Wien
Bohuslav Herman	UNIDO Industrial Development Officer

IIASA Staff

Professor Howard Raiffa	Director
Dr. Andrei Bykov	Secretary to IIASA
Dr. Istvan Abraham	Head of Computer Services
Mr. Konrad Grote	Head of Scientific Recruitment

Research Scholars

Prof. Wolf Häfele	Project Leader	Energy Systems
Dr. Rudolf Avenhaus		Energy Systems
Dr. Jean-Pierre Charpentier		Energy Systems
Dr. Michel Grenon		Energy Systems
Dr. Nikolai Kourochkin		Energy Systems
Prof. Alan S. Manne		Energy Systems
Dr. Cesare Marchetti		Energy Systems
Dr. Richard Patzak		Energy Systems
Dr. Atsuyuki Suzuki		Energy Systems
Prof. George Dantzig	Project Leader	Methodology
Prof. Gerhart Bruckmann		Methodology
Prof. Tjalling Koopmans		Methodology
Dr. Jean-Pierre Ponsard		Methodology
Mr. Carlos Winkler		Methodology
Dr. Martyn Cordey-Hayes		Management of Urban and Regional Systems
Mr. D. H. Kelley		Integrated Industrial Systems
Dr. Heinz Hübner		Integrated Industrial Systems
Dr. Yuri Rosanov	Acting Leader	Complex Use of Water Resources
Dr. Igor Belyaev		Complex Use of Water Resources
Dr. Pavel Koryavov		Complex Use of Water Resources
Dr. Eric Wood		Complex Use of Water Resources

The Mesarovic-Pestel Group

Dipl. Ing. R. Bauerschmidt	Technische Hochschule Hannover Lehrstuhl A für Mechanik
Dipl. Ing. M. Gottwald	Technische Hochschule Hannover Lehrstuhl A für Mechanik
H. H. Maier	Technische Hochschule Hannover Lehrstuhl A für Mechanik
Dr. R. Pestel	Technische Hochschule Hannover Lehrstuhl A für Mechanik
Dr. W. Ströbele	Technische Hochschule Hannover Lehrstuhl A für Mechanik
Dr. W. Paul	Institut für Landtechnische Grundlagenforschung der Forschungsanstalt für Landwirtschaft Braunschweig
Dipl. Ing. P. Gille	Medizinische Hochschule Hannover
Dr. H. B. Kleeberg	Institut für Wasserwirtschaft, Hydrologie und Landwirtschafts- wasserbau Hannover
Dipl. Ing. H. Billib	Institut für Wasserwirtschaft, Hydrologie und Landwirtschafts- wasserbau Hannover
H. J. Bäsler	Botanisches Institut der Universität Heidelberg
Dr. J. Mermet	Institut national polytechnique de Grenoble
F. Rechenmann	Institut national polytechnique de Grenoble
Dr. H. Bossel	Institut für Systemtechnik und Innovationsforschung, ISI, Karlsruhe

Dr. R. Denton	Institut für Systemtechnik und Innovationsforschung ISI, Karlsruhe
Prof. L. Klein	University of Pennsylvania Philadelphia
Dr. M. A. Cardenas	Ministry of Water Resources Mexico
Dr. J. Klabbers	Katholische Universität Nijmegen
Dr. B. Hughes	Case Western Reserve University Cleveland, Ohio
T. Shook	Case Western Reserve University Cleveland, Ohio
M. McCarthy	Case Western Reserve University Cleveland, Ohio
G. Blankenship	Case Western Reserve University Cleveland, Ohio
P. Clapham	Case Western Reserve University Cleveland, Ohio
J. Richardson	Case Western Reserve University Cleveland, Ohio
M. Warshaw	Case Western Reserve University Cleveland, Ohio
Y. Takahara	
Mr. Jäckl	

MINUTES OF THE RESEARCH PLANNING CONFERENCE ON
GLOBAL MODELLING

Preliminaries

Introduction by Professor Howard Raiffa

Welcome to Baden! Baden is an Austrian village that is known by some people primarily as a health resort. All of us here know its true distinction: namely, it is that pleasant place near Laxenburg where IIASA has its international conferences.

I would like to take this opportunity to thank the chairmen of this conference, Mike Mesarovic and Eduard Pestel, for their splendid preparation for the conference. The arrangements from IIASA's side were the responsibility of Dr. Andrei Bykov and Professor Gerhardt Bruckmann. They have been ably assisted by Mrs. Ilse Beckey and Miss Claudia Staindl. I am sure you all join me in expressing our appreciation for their efforts.

Let me say a few words about IIASA. As most of you know, our charter was signed in October 1972, but it was not until last summer--the summer of 1973--that scientists began to arrive in Laxenburg. We now have about fifty scientists in residence, and if one fits an exponential growth curve to the time series of scientists present at IIASA, then by the year 2000 we shall have all the people in the world in Laxenburg. But since our infrastructure will not permit this unimpeded growth, we have decided on a more orderly growth pattern: we expect to increase our numbers slowly from now on, and we anticipate reaching a steady state of about ninety research scholars.

Our funds come from thirteen national academies of sciences, or similar types of institution, and I expect that other institutions representing other countries will join our family. Like most other institutions the world over, we do not have enough money to do what we would like--or what we deserve--and some of our marginal efforts will have to be curtailed.

IIASA Program

The Council of our institute has authorized us to pursue research in the following nine project areas:

METHODOLOGY

General

Reviews on the State of the Art of ASA

Proposal for research on optimization of large scale systems

DESIGN AND MANAGEMENT OF LARGE ORGANIZATIONS

COMPUTER SYSTEMS AND COMPUTER SCIENCE

LARGE INTEGRATED INDUSTRIAL SYSTEMS

MANAGEMENT OF URBAN AND REGIONAL SYSTEMS

ECOLOGICAL SYSTEMS PROJECTS

BIOLOGICAL AND MEDICAL SYSTEMS

ENERGY SYSTEMS

WATER RESOURCES

These nine projects are divided into two groups. The first three (Methodology, Design and Management of Large Organizations, and Computer Systems and Computer Science) have primarily a service orientation, the other six an applied orientation. We can view our research program in a matrix framework (Fig. 1).

Along one dimension we feature in the service-oriented projects a host of analytical skills ranging from specialties in applied mathematics (mathematical programming, control theory, statistics, modelling, etc.), in computer sciences, managerial sciences, behavioral sciences, policy analysts, engineering of different types, and even international law and history. In the other dimension, we list our applied areas: energy, water, ecology-environment, regional development, bio-medical, and industrial systems.

The choice of projects was arrived at by a complex process of international negotiations. It was impossible to agree on one or two projects on which to concentrate, so we have proceeded with a portfolio of interrelated projects. We used the following criteria for their selection:

- a) Interdisciplinary-Applied-Policy or Managerially Oriented
- b) Global or Universal

		A P P L I E D					A R E A S		
M E T H O D O L O G Y		ENERGY	WATER	ECOLOGY	REGIONAL	BIO-MEDICAL	INDUSTRIAL		
Applied Mathematics									
Math, Programming									
Control Theory									
Statistics									
Stochastic Process	,								
	,								
	,								
Computer Sciences	,								
	,								
	,								
Managerial Sciences	,								
	,								
	,								
Behavioral Sciences	,								
	,								
Economics	,								
Sociology	,								
	,								
	,								
Legal									
Historical									

Figure 1

- c) Important (to NMO's and others)
- d) Feasible
- e) Non-redundant
- f) Phased Output--Balance of Risks
- g) Integration Across Projects

The criteria are self-explanatory and need no amplification except perhaps for Criterion b): Global or Universal. Global projects include such topics as man's effect on the climate, or the law of the sea, or the activity at this conference on global modelling; universal projects deal with concrete problems that each country faces such as how to get rid of our solid waste, how to manage our forests, how to provide emergency health services, and so on. IIASA will feature a mix of both kinds of activity: global projects and universal projects.

Our aim, of course, is not to have nine separate projects but to integrate them in some creative manner. Now all of you know, only too well, how difficult it is to get scholars from different disciplines to interact. And we cross not only disciplinary barriers, but cultural and ideological barriers as well. One way of achieving such interdisciplinary and cultural-ideological integration is to get scientists to focus on a few important real-world problems: another way is to select scientists who have already demonstrated an ability to work across disciplinary lines, and yet another is to identify some themes which cut across our project areas. One such theme is the subject matter treated in this symposium.

Let me now say a few words about IIASA's research strategy as regards modes of research activities. We hope that over the years IIASA will be recognized as a place where top scientists from all over the world congregate to pursue joint research on important world problems. We hope to establish a community where there is an on-going, open, sophisticated interchange of ideas on problems where applied systems analysis has a relevant input. From my admittedly biased viewpoint, we have gone a long way already in achieving that end. But IIASA can only make a meager impact if our researchers work in isolation of the work done elsewhere. It is IIASA policy to collaborate with other institutions both international (like such U.N. agencies as IAEA, WHO, UNESCO, and so on) and national (such as the Institute of Control Sciences in the USSR, various U.S. universities, Electricité de France, and the like).

Besides doing research by ourselves and in collaboration with others, we have an obligation to be an information exchange agency--a so-called sophisticated clearing house, if you will. We want to collect, synthesize, and disseminate information that pertains to our research interests. Finally we can, either by ourselves or in collaboration with others, host various international conferences dealing with subjects relevant to our program.

Now let me turn to the subject matter of the symposium. It is IIASA's intention to host not a single symposium, but a series of symposia on global modelling efforts. In this respect we are fulfilling our information-exchange agency role, in this case through the medium of convening international conferences. We would ourselves like to concentrate on methodological aspects of such modelling efforts. We hope we can play a constructive role in helping to identify critical methodological areas where more basic research work is needed. And we intend, in collaboration once again with others to work on improving the methodology of such large-scale modelling efforts as this one. So we enter with the spirit of being a friendly critic. I know Eduard Pestel and Mike Mesarovic understand this role that IIASA would like to play.

We decided for purely pragmatic reasons to start with the work of Mesarovic-Pestel. They were ready for such an exchange and Professor Pestel has been an advisor in IIASA's development. In no way whatsoever does IIASA by its desire to host this particular meeting assert that we think this modelling effort is the best one available, nor do we as an institution necessarily endorse any of the conclusions of this modelling project. Our choice of this project does not imply that IIASA thinks that the modelling or data collection techniques used by the Mesarovic-Pestel task forces are appropriate or correct. In other words, we wish to strike a neutral pose in all these matters. We do assert, however, that we think that the problems addressed in these symposia are important ones for humanity, and we do hope that by such open and frank discussions of these methodological issues we collectively will become more sophisticated, more accurate, and more relevant.

As you undoubtedly know, the Club of Rome has played an imaginative, constructive role in partially supporting several global modelling efforts, including the present work of Mesarovic-Pestel. Although IIASA and the Club of Rome are quite distinct entities, we share many aspirations.

Thank you for attending this symposium. We look forward to your participation.

Introduction and Overview of the Symposium

Prof. Pestel expressed his thanks to Prof. Raiffa as host for the conference. IIASA played an important role in providing a forum for exchange of information on the scientific background to global modelling studies. Essentially, the present meeting would provide an opportunity for open discussion, not only of the conclusions so far reached in the project but on methodology. Prof. Mesarovic also thanked Prof. Raiffa and IIASA for providing the means by which a valuable exchange of views could take place. He emphasized that the project was concerned with specific problems: the modelling techniques were dependent on the specific issues treated in the project, i.e. food and energy, etc.

Prof. Pestel then presented his paper on motivation, objectives, and conceptual foundation of the project.

Motivation, Objectives, and Conceptual Foundation

M. Mesarovic and E. Pestel

If you--as I believe--agree with me that honest, genuine, dedicated motivation is the most important prerequisite for doing a good job, be it in business, administration, or research, then you will find it a natural beginning of this symposium if I tell you first what moved Prof. Mesarovic and myself to undertake the quite demanding task of developing a new construct for the description and study of certain world-wide critical relationships, a new world model, as it is somewhat improperly called by most people.

First, there is the conviction--shared by some half a dozen members of the Club of Rome that met in 1969 in an Austrian mountain village to spell out their concern for future world development, and to which I had the honor of belonging already then--the conviction that the world was beginning to face a cluster of crises of unprecedented type and magnitude that might very well appear during, say, the next fifty years, in fast succession, especially if measured in historical perspective.

It is this cluster of crises which the Club of Rome has characterized as the "world problematique" in order to draw attention to the uniqueness and magnitude of the problems involved, and to the extreme difficulty in understanding the evolving situation, not to mention finding a remedy and means to avoid disaster. What are some primary characteristics of the world problematique which set it apart from earlier events in world history?

- 1) The problems are global: for some of them, as, for example, in the case of the energy crisis, this is quite obvious. For some others, for example, the threat of starvation in particular regions, the global character is felt through either socio-political or economic interdependence. The global character of the problems makes them very difficult to solve at the national and regional levels which more often than not have conflicting concerns.
- 2) The changes are felt through the entire society. Economic, technological, environmental, socio-political and many other aspects appear to be interacting in such a way that what might appear as a desirable strategy in one domain only makes the situation worse in others. It seems, as was often stated, that everything is related with everything else. This hinders the solution of problems by traditional

means designed solely within one domain, i.e. technology, economics, environment, etc.

- 3) There is a conflict between short and long range actions and goals. A short range solution often only compounds the long range problem, making it worse when it reappears the second time around.
- 4) There are considerable delays between the time when a corrective action is applied and that when its remedial action is felt. For example, a successful population control policy aimed at achieving an equilibrium level of population will take thirty to fifty years, and possibly more, until such a goal is reached. Delaying the action until the "last minute" will nullify any beneficial influence it might have had.
- 5) Traditionally, crises were the results of negative actions by man or nature. The current crisis, in contrast, seems to be the result of actions traditionally considered as most desirable; e.g. to have a large family, or to use as much energy as possible to save human labor, or to exploit nature to the utmost for the benefit of man. The adjustment will have to involve changes in the basic value system traditionally considered as sacrosanct.

These are certain essential aspects of the world problematique as we see it, which led us from the very beginning of our work to look at the world as a whole, and not just at national or regional problems and crises in isolated fashion. Next, let me make a few remarks about the history of our project, because this leads up to our second motive for undertaking this challenging enterprise.

In 1970 the Club of Rome was in search of a methodology, both practical and comprehensive, which could be applied to its envisaged global modelling project on "The Predicament of Mankind." During that process Prof. J. Forrester made a presentation of his industrial and urban dynamics methodology to the Club of Rome at its first Plenary Meeting in Bern. Support was obtained from the Stiftung Volkswagenwerk to enable him to carry out a preliminary test project. He developed the first world dynamics model in rather abstract terms and then entrusted its further refinement and documentation to his student and associate, D. Meadows. This led ultimately to the development of the model World 3 which was presented for a rather general audience in the highly successful book Limits to Growth.

When I first, so to speak, inspected the Meadows project in early 1971, half a year after it had gotten underway, in my capacity as a member of the Executive Committee of the Club of Rome, I realized with some disappointment that the project, when completed, would not satisfy the objectives of a world modelling project as envisaged initially by the Club of Rome. This was due not to any lack of effort on the part of the participating researchers, but rather to the inherent shortcomings of the methodological approach. Now, while I was at MIT, it happened that Prof. Mesarovic gave an introductory lecture of the multilevel, hierarchical approach to the analysis and control of large scale complex systems that he had developed at the Systems Research Center of Case Western Reserve University during the past ten years. Here, for the first time, I became acquainted with this theory, which is described in his book Theory of Multi-Level Hierarchical Systems and has further been developed in his forthcoming book General Systems Theory. It was quite apparent to me that this was a much more sophisticated approach that would have a better chance to reach the goals which the Club of Rome had set itself when it conceived its major project, entitled "The Predicament of Mankind." Hence, on the spot, Prof. Mesarovic and I designed and initiated the first stages of what later became a rather sizeable project which was then also supported by the VW Foundation. Obviously, this was to be a much more ambitious attempt than the Forrester-Meadows study, and at this symposium we shall publicly describe our findings so far for the first time and in full.

Our presentation will provide enough material to support this contention. Here let me illustrate only what difference it makes in terms of the essential theses which embody the conclusions, the results of analysis, and the strategy for remedy of the world situation, using on the one hand the industrial-urban dynamics methodology of Forrester, and the multilevel, hierarchical systems methodology in our project, on the other.

The Forrester-Meadows theses regarding the world problematique can roughly be summarized as follows:

Forrester-Meadows Theses

- a) The world can be viewed as one system.
- b) The system will collapse sometime in the middle of the next century.
- c) To prevent collapse an immediate slowdown of economic growth must be initiated, leading to no growth in a relatively short period of time.

For the sake of contrast, the results of the analysis in our project can be presented in the following form:

Our Theses

- 1) The world can be viewed only in reference to the prevailing differences in culture, tradition, and economic development. The world can be viewed as a system only in terms of interacting regions: a monolithic view of such a system is misleading.
- 2) Rather than collapse of the world system as such, catastrophies or collapses on a regional level would occur possibly even long before the middle of the next century, but in differnt regions, for different reasons, and at different times. Since the world is a system, such catastrophies will be felt profoundly throughout the entire world. Causes for such potential catastrophies are the population, food, and economic relationships in Africa and South Asia; energy and raw material scarcity and production growth in the developed world; employment and population relationships in Latin America, etc.
- 3) The solution to such catastrophies of the world system is possible only in the global context and by appropriate global actions. If the framework for such joint action is not developed, none of the regions will be able to avoid the consequences. For each region, its turn will come in due time.
- 4) Such a global solution could be implemented only through selective and balanced growth, not uniform, but greatly differentiated throughout the world. From the viewpoint of the total world system this means growth analogous to organic growth rather than undifferentiated growth. It is irrefutable that the second type of growth is cancerous and would ultimately be fatal.
- 5) The delays in devising such global strategies are not only detrimental and costly, but deadly. It is in this sense that we are truly talking about a "strategy for survival."

With these theses in mind, Prof. Mesarovic and I then formulated the following two basic objectives in our project:

- a) to develop a system's representation of the world development process that can provide us with an insight

into the causes and effects within such a system, and subsequently allow us an assessment of alternative sequences of events that might take place in the future; and

- b) to develop a planning and decision-aiding tool that can be used for the evaluation of alternative policies and be applied in practice when searching for solutions of various problems involved in the problematique.

Both these objectives require a computer-based model of the system involved. This is no mean task and we shall have quite a bit to say as to the methodology, assumptions, data, and other aspects of the model-building process.

What are the goals we want to accomplish with our project? They are again twofold. The first goal is action-oriented. We are convinced of the reality and gravity of the crisis conditions enveloping the world system, as well as of the urgency of searching for solutions and indeed applying them. Having this conviction, it is our responsibility to do our part in initiating such a process. As a matter of fact, we hope that the computer-based planning and decision-aiding tool developed within our project will be actually used and thereby influence future developments. In this respect our project is not an academic exercise but an activist's response to concern. The ultimate success will have to be measured by the influence and the consequences the project will have in practice. The second goal is academic. We do not share the prevailing cynicism regarding responsible policy- and decision-makers. Of course, they act too often in their own interest and with the time horizon for which they are elected or appointed. But it is also true that they are not being helped to any worthwhile extent by the academic community to plan and act otherwise. Indeed, it might be argued that by and large the decision-makers are perhaps more aware of the problematique than the family of scientists. There are possibly two reasons for this: (1) The academic concerns revolve around academic disciplines. Yet the real world, particularly under crisis conditions, is not divided into nice compartments as our universities are. (2) The research in academic disciplines is by tradition analytic and oriented toward the past. The world problematique, however, requires an orientation toward the future and indeed over a rather long time horizon. It is surely not to be denied that the future is conditioned by the past, by historical patterns of development. However, it must be expected to be also fundamentally different, and its analysis requires a different mental attitude and a different methodological approach than is applied to the classical scientific

domains. Future events will take place under conditions fundamentally different from the past, whose texture is far more interwoven than ever before. It is therefore necessary to develop a basis for such research on an interdisciplinary basis; and it is our second goal, by developing a solid foundation for the study of future development processes, to enable the mobilization of many good minds in academia not only for a better understanding of these problems--possibly the most challenging in our era--but also for a salutary engagement in the search for solutions. I might add here: It seems that the great turnout for this conference offers proof that this second goal is already being approached.

When developing a model for a real-life system one does not describe all the relationships that actually exist. In principle, there would be no end to such a process. Rather, one considers only those relationships which seem to be relevant for a certain objective, i.e. for a certain issue or problem of interest. The validity of the model and the usefulness of the analysis based on such a model depend on how judiciously one selects the relevant relationships. In the case of the world system we are interested in a very long term development, e.g. in the order of fifty years, and the relationships selected--economic, social, technological, ecological, etc.--reflect that fact. So it is not a "model of the world" that we are constructing but rather a model of certain world-wide relationships of importance for the assessment of alternative long term trends in global development.

The key problems in developing a model of the world system are complexity and uncertainty. Complexity results from the enormous number of variables and relationships involved and the different ways in which the total system can be viewed. Uncertainty is the result of our ignorance of certain aspects of the system, of the essential unpredictability of events in the future, and of the subjective factors involved in value judgments, political actions and the like that affect or are part of the system. Success in developing a model for a large scale system depends on how well these two problems--complexity and uncertainty--are handled.

The complexity of the world system appears in two ways: (1) by the number of its constituent parts, i.e. countries; (2) by the interaction of a diversity of factors that must be taken into account, and that are traditionally considered in separate and unrelated domains of human knowledge, i.e. scientific disciplines such as economics, demography, ecology, technology, social and political science, etc.

Regarding the constituent parts of the world system it is essential to recognize that the present system is at the same time one and many. It is one because of the ever-increasing interactions between its various components, and it is many because each of its geopolitical constituents has had a different past, has a different present, and will have a different future. Recognition of both of these sides is a sine qua non for a world model if it is to be accepted as a credible representation of reality. We have solved that problem by representing the world system in terms of ten mutually interacting and interdependent regions.

The selection of the regions is made in reference to shared traditions, history and style of life, stage of economic development, socio-political arrangements as determinants of economic and political management, and commonality of the major problems to be encountered in the future. Our model does not presuppose any formal or informal regional supra-national arrangements, although we believe that some such arrangements will be necessary for a balanced development of the world.

The second aspect of the complexity of the world system is approached by a methodology we call "stratification." It involves two steps. In the first step one describes a given system using different scientific disciplines and thus derives appropriate models of the system consistent with the laws and principles of the given disciplines; in our case, we consider a given region and describe it in terms of economics, population change, ecology, technological transformations induced by man, etc. In the second step all these models (which, again, refer to one and the same system in space and time, but viewed from a different angle) are arranged in a hierarchical structure so as to form the total system model. Each of the models or rather submodels is considered as being on a different level in the hierarchy, referred to as stratum, and the whole procedure of describing a large system in this way is termed stratification.

The type of representation used for the processes on different levels depends on the scientific knowledge and data available, and ultimately on the nature of the processes involved. Regarding the latter we recognize two types of systems representation: causal, in which the system is described in terms of cause-effect relationships, i.e. in a passive manner, and goal-seeking, in which the system is represented in reference to certain objectives or goals and the ways it responds to the changing environment to preserve those goals. The lower strata are represented in general as causal while the higher are represented as goal-seeking. The causal strata can be represented, at least in principle, by a computer model, depending on the data and information available. For the representation of a goal-seeking

model we use, in general, a man-computer combination in order to be able to reflect the uncertainty and adaptivity involved in human judgment and behavior and in its value base. In such a combination, the quantitative and logical aspects of the goals as well as the options from which a response has to be selected are represented on the computer; the actual selection is being made by man who, through his choice, reflects his own judgment of the situation.

The problem of uncertainty we approach similarly through a man-machine combination. The computer model, after its construction, is an open model in the sense that there is a set of parameters or inputs that are not, or at least not fully, specified but rather only in terms of a range in which they must lie. The model cannot "run" without these parameters being specified; it therefore is not "closed" and cannot "predict" the future by itself. It needs the help of man, who through the selection of the unspecified parameters reflects a view as to the outcome of the uncertainties.

Two processes are used in such a choice procedure, scenario analysis and interactive mode analysis. In the scenario analysis, one postulates a sequence of plausible events which determine the choices to be made which are then applied to the causal part of the model, and hence the evolution of the system in time is described and analyzed. If the uncertainty prevails, one tries a whole set of scenarios.

As an example, assume that one would like to investigate the prospects for economic development of a region over the next twenty years and is given as a scenario variable the savings as a ratio of the total national income which can be used for investment. Although the changes of the savings ratio over a past period is very helpful in deciding on the values of the ratio for the future, the choice ultimately depends on the regional socio-political conditions and one's own assessment of what kind of change will prevail over the future time period of concern. Such a selected change of savings ratio is applied to the model and the effect of such a choice on the future development is observed. The likelihood of such a development taking place depends upon the likelihood of occurrence of the selected input. In order to arrive at a more definite conclusion one tries in general an entire spectrum of alternative scenarios. If the analysis of the computer runs for all of them leads to essentially the same conclusion, such an event could be expected with a higher degree of certainty, e.g. if the capital transfer to certain developing regions is kept below certain levels, such that they cannot reach the economic take-off point for a whole

set of alternative regional development policies, then the necessity for transfer of investment at least above a given level is inferred.

In the second type of analysis--the "interactive mode"--the inputs to the causal part of the model are not fully specified for the entire period of time, but rather, in increments; after an incremental input is applied to the computer model the next increment is applied only after the response of the system to the earlier input is evaluated. The policy analysts, decision-makers (or members of any staff participating in the planning or decision-making process) analyze the outcome of applying an increment of the input and specify the next increment on the basis of the response of the system and the desired direction of development. The interactor, who observes the evolution of the model through time and specifies the incremental inputs when needed, becomes actually part of the model; i.e. the total model is a man-machine symbiosis in which man provides judgment and value assessments and the computer provides logical and numerical operation.

In conclusion, several remarks regarding the particular view of the world should be mentioned:

- a) The difference between the methodology used here and prevailing techniques used in other types of modelling by computer should be noticed (e.g. systems dynamics, linear programming, etc.). Our approach is not based only on a numerical representation of the system nor only on an optimization algorithm for narrowly defined criteria. Rather, it includes qualitative and logic-type relationships whenever appropriate, and also relies on the heuristic approach to decision-making, involved in a manner consistent with institutional and time constraints.
- b) The construction which we have developed could be more appropriately called a planning and decision-aiding tool for policy analysis, rather than a computer model in the traditional sense, though a model is part of the construction of the tool to be sure. However, it is not a "predictor" but rather an extension of one's logic and an implementor of one's vision of the future.
- c) It is often stated in reference to the present energy or environmental crises that it looks as though "everything depends on everything else,"

and furthermore that it is a consequence of the complexity of the system that it is "counter-intuitive." From the viewpoint of stratified systems, however, it is not the complexity of the system which makes it "counterintuitive," i.e. hard to comprehend, and makes it also tightly coupled, forming a "mess" hard to control; rather, such a state of affairs is a sign that the system is in disorder, in a crisis. Under normal circumstances the strata in a hierarchical system are, by and large, independent and remain so, as long as the behavior of each is satisfactory. Under crisis conditions, however, when various strata cannot cope with the changes in their environment they merge into one, with the result of everything becoming dependent on everything else and the total system becoming counterintuitive. It is only because of such relative independence between strata under normal conditions that the world appears comprehensible. How else would progress over so many centuries have been possible? This observation is of importance when considering the remedies which are needed to bring the system out of the crisis and into a "normal" set of conditions. What is needed is not to change the path of development by outside steering into the direction of further growth or no growth. What is needed is a restructuring of the system so as to return to the "normal" type of conditions where the subsystems are in mutual harmony so that each of them, by solving its own problems, is contributing to the solution of the whole. The analysis of present-day and future problems and crises during the next days will indicate that a "horizontal" restructuring of the world system is needed in order to solve energy, food, and other crises; i.e. the solution is feasible only if the problems of needs and supplies are approached in the global context. And it is in this sense that the world is at the end of the era of independence and at the threshold of a new era of global development, an era which is born not out of good will and generosity but out of necessity.

Overall Methodology of Model Construction and Its Use
As A Planning Tool

Prof. Mesarovic opened the discussion on overall methodology of model construction and its use as a planning tool. First he outlined the major characteristics required in the modelling activity for the project. They were:

- a) regionalization,
- b) multi-level stratification, and
- c) man-machine symbiosis.

For regionalization it was necessary to represent ten inter-dependent and interacting regions:

- 1) North America,
- 2) Western Europe,
- 3) Japan,
- 4) rest of developed countries,
- 5) Eastern Europe,
- 6) Latin America,
- 7) Middle East,
- 8) Africa,
- 9) Southeast Asia, and
- 10) China.

For some analyses it was necessary to aggregate the regions into total world:

- 2 regions (1) to (5) and (6) to (10),
- 3 regions (1) to (4): (5) and (6) to (10),
- 4 regions (1) to (4): (5): (6) to (9), and (10).

In some cases a regional model based on 11 regions was used, dividing region (9) (Southeast Asia) into two regions (9a) (Pakistan, India, and Bangladesh) and region (9b) (the remainder).

Prof. Mesarovic went on to discuss the basic requirements for regional models and introduced the concept of stratification. Stratification was not only necessary to consider problems from the level of population groupings but also from the point of view of goal setting and causation.

With regard to handling the complexity, in general the philosophy was to try to understand the system at a higher level of aggregation, and then proceed to select the most appropriate level at which to interact with it. As an illustration of how strata were crossed in the project, Prof. Mesarovic used the food model as an example: agriculture was obviously a prime area of examination particularly with respect to protein availability, e.g. possible changes in main crops, the economic consequences of agricultural policy, and the relation between protein availability and mortality. The linkages between the food model and the population model were obviously extremely important as was the necessity to take into account all the factors which could limit growth in these areas. Prof. Mesarovic stressed the differences between a monolithic view of the world and the regionalized and stratified concept expressed in the project. Diversity had a high value in survival but diversity and stability represented two opposing forces.

In the use of the models, the essential method was a computer interaction by the researcher at both the decision strata and causal strata level. At the policy level of the decision strata a set of policy options was presented, and at the strategy level options were available to the decision maker and through computer interaction he could appreciate how good these options were to achieve the selected policy. Finally, at the implementation level, the consequences of the selected policy and the chosen strategy would be demonstrated. In this sense the system of models was essentially a practical tool to enable decision makers to make forecasts. Thus, the philosophy of the project was based on the need for scientists to contribute, through model building, to the solution of real world problems.

Discussion

The short discussion of the introductory papers by Prof. Pestel and Prof. Mesarovic centered on two areas: methodology and optimization.

Data Problems: Methodology

There were obvious gaps in the data and a major problem was how to identify the relationships when such gaps were important. In such a case assumptions on the relationships involved were necessary. Other problems were related to the future evolution of the system, for example, the maximum yield to be obtained from fertilizers for different types of soil. A technique of analysis for "future" data was necessary. In this connection some participants raised the problem of identification of endogenous and exogenous variables in this type of modelling activity. Prof. Mesarovic stressed the need for a reasonable balance in this respect; the model-building activity was concerned with issues and these issues dictated structure and provided the basic parameters. Other comments related to the possibility of a utility index and pricing factors for the allocation of scarce resources.

Optimization

One participant raised the problem of how optimization of individual well-being in specific regions could be built into the models. In discussion it was pointed out that it might be premature at this stage to introduce optimization: this would become relevant at the level of practical application. Prof. Mesarovic was of the opinion that it would be academic to try to determine what is optimal for individual parts of the model: it was necessary to look at the system as a whole. Another participant stressed the difficulty of the problem of identification in making new policies: this was bound up with the general problem of the level of confidence which could be placed in the reality of the models. In replying to this discussion, Prof. Mesarovic stressed the main concern of the team: they were essentially concerned with critical world-wide relationships in areas of obvious global significance rather than with issues of fine adjustment.

Discussion on
"World Population Model and Analysis of
Population Policy"
by Dr. W. Paul

Technical Clarification

The first questions and comments following Dr. Paul's presentation were addressed to the technical and mathematical properties of the population model. Prof. Pestel briefly showed the sensitivity of population projections and of the starvation feedback to the age profiles at any point in time. He also pointed out that the age profile for any steady state population depends entirely upon the mortality statistics and thus is independent of the level at which the population is stabilized and the policies used to bring about the steady state.

A participant asked whether the dependence of fertility and mortality rates upon the standard of living had been examined. Prof. Pestel replied that such relationships were difficult to model functionally. The group therefore felt on firmer ground in examining the effects of population measures instead of modelling these as effects deriving from changes in living standards. A number of tools could be applied to achieve the desired population policy but it was upon the effects of this policy itself that attention was focused. Prof. Pestel noted also that the necessary changes in real income to achieve the desired population effects might be so infeasible as to lie outside the realm of policy options. Thus, it is not useful to say that China needs only a tenfold increase in per capita real income whereupon its fertility will drop to more satisfactory levels.

One attending scientist argued that a population equilibrium result was impossible in that the policies applied would most likely overshoot and lead to a declining population. It was agreed that no constant mix of measures would lead to a perfectly steady population but argued that subsequent adjustments could lead to a population level stabilized within sufficiently narrow bounds. Another participant pointed out that the strategy of encouraging prospective parents to wait had not been included in the model.

The Mode of Presentation

Prof. Rademaker* praised the development and presentation of the population model but urged the group as modelling colleagues not to couch their findings in chiliastic terms. Specifically one should avoid such stirring closing sentences as the claim to have "demonstrated convincingly the urgency of drastic population measures in order not to let nature take its cruel course." The model is after all a model and as such depends vitally upon its conceptual assumptions. It should not indiscriminately be confused with the real world. The projected time to equilibrium population of seventy years depends crucially upon the specific conditions assumed--this was confirmed by Dr. Paul--and should not be presented as an immutable law.

Prof. Mesarovic agreed that models should be constructed and used in flexible ways. When, however, a family of models is derived from reality in such a way that reality under a broad range of assumptions seems to fall within the family and when the entire family leads to a calamitous conclusion, the modeller has the responsibility to report this. The group has sought not simply to develop a model but to analyze its relationship to reality across a broad range of sensitivity checks. The medical examination of a child may be intended originally as no more than an academic demonstration, yet if the child is found to be sick, it should be reported. Prof. Mesarovic agreed that seventy years was no magic number for the achievement of a constant population level but noted that even more pessimistic was a recent UNESCO study predicting that the world population would grow for at least a century.

Prof. Klein pointed out that many of the equations presented were mathematical truisms and as such not subject to validation. He urged the expositors of the model to make clear just where were hidden the behavioral assumptions that could be subjected to validation and which might lead the model projections to stray drastically from reality. Without such validation, he questioned the wisdom of making projections out to 2100.

Prof. Pestel stated that none of the group would argue or expect their scenarios for the year 2100 to be even approximated. The run to that point was made partly out of curiosity and partly to firmly make the point that the assumptions underlying the model would have to change. He reminded the conference that the population model was not designed to be run in isolation but to be used in conjunction with other models and other assumptions.

* Prof. Rademaker has asked that a verbatim record of his remarks be published in the Conference Proceedings, and they appear in the next section.

Prof. Rademaker's Remarks

Prof. Rademaker of the Eindhoven University of Technology, Project Group Global Dynamics: Mr. Chairman, I think many of us have read this paper with considerable interest, if only because of the interesting differences between various regions it reveals. But, being among our own kind as people who work with systems and modelling approaches, it appears to me that we have an obligation to warn each other as soon as there is a chance that we get too much faith in our models or that we lose sight of the thin line dividing models from reality.

After all the reservations and qualifications that were made this morning, this paper ends with: "[this] demonstrates convincingly the urgency of drastic population policy measures in order not to let nature take its cruel course." If I may paraphrase this sentence: this demonstrates convincingly how easily the mind slips from findings based upon a certain model to conclusions presumed to be valid in the real world. Personally, I am inclined to believe that the conclusions are correct, but the step from model to reality should not be made without seriously considering--and reconsidering--all "if's" and "but's." It should be a well-considered, conscious step and not something obviously self-evident.

A related point was, in fact, already raised by Mr. de Julio when he asked about those seventy years that seem to be the time needed to approach equilibrium in almost all "scenarios." Before those seventy years become a holy number, we ought to ask ourselves the question, "are they characteristic of the world or are they characteristic of the model's assumptions?"

In my opinion, this figure has come out because the only change has been simply a change in fertility, chosen so as to ensure equilibrium in the long run. There cannot be any doubt that this is a very interesting exercise but--again--this should not be translated into the real world without a very thorough rethinking of the whole subject: people are not very likely to behave in such a way as to stabilize the population seventy years later. The actual development might be either far worse or far better. For example, it is conceivable that food-per-head, cultural aspirations, education, and the like do not simply change a fertility coefficient, but may give rise to one or more feedbacks based on comparison of the actual development with the desired development. As any control engineer

can tell you, this may reduce the dominant time by a very considerable amount indeed (pole-shifting). Maybe we are witnessing such a process now in West Europe and North America.

So it is important to realize that the seventy years is a not a natural constant but the consequence of building a particular assumption about the change of fertility into the model. Here, again, the step from the model to the real world should not be made without considerable caution.

Discussion on
"Food Production and Nutrition Model"
by Dr. P. Clapham

Technical Clarification

A participant inquired how ocean fishing fit the assumptions of food as a return on capital in a regionalized world. Dr. Clapham responded that the problem was tough-- in part because the oceans are a commons and thus cannot be regionalized. He noted though that only certain areas-- estuarial waters and upwelling zones--were especially suited for fish production. A geographical model would be necessary to study the situation in detail, but the finiteness of productive fishing zones was--through data on present operations--already incorporated in the model.

Several members of the audience, in noting the dependence in the model upon available agrarian land, inquired how the possibility of feed lots might be incorporated. Dr. Richardson explained that the most capital intensive end of the livestock scenario included existing feed lots. As live-stock becomes still more capital intensive, the proportion of feed lots would grow. Prof. Bruckmann pointed out, however, that by the assumptions of the model the fraction of cattle in feed lots remained constant.

One participant was bothered by this assumption that fractional proportions of land use remained constant. Why, for instance, should the ratio of land for cereal foods to non-cereal vegetables remain unchanging? Would not a way of avoiding or minimizing starvation be to shift to foods with the highest caloric and protein content for the reserve units invested. Dr. Clapham conceded that the model could have allowed changing proportions of land uses. He argued that, as the modeller, he had judged that making this factor an additional exogenous variable was unnecessary and unwarranted. It was unnecessary because their research showed that the ratios remained relatively constant, and it was unwarranted because of the additional complication this would have contributed to the model.

Two scientists had reservations about the single term treatment of capital investment based upon data from fertilizer yields. This assumption, they felt, rooted the model irrevocably in the past. Dr. Clapham responded that you could certainly trade off fertilizers against farming more land but felt that

the fertilizer-yield relationship was fundamental enough that one did not need to incorporate explicitly such factors as machinery and biocides. The green revolution, for instance, was simply the use of new crops which had been developed to respond dramatically to fertilizers.

It was then argued that this simple measure of output as food per capita missed important considerations as the distribution of food geographically and over the age profile. This distribution would affect the starvation margin but itself depends upon such uncapturable variances as the way that money is lent. Dr. Clapham said that preparations already were underway to include the distribution factor in the next generation of the model.

Ecological Considerations

It was pointed out that the productivity of various units in the food model would be vastly affected by environmental pollutants. Food production would in turn contribute to overall despoliation of the environment. Prof. Mesarovic answered that pollution models were under development, would be presented later in the week, and would be incorporated within the model.

A participant pointed out two areas of special concern: that biocides injured the ecosystem and that the genetic pool of the world's animals might be endangered in an important, unknowable way that was not addressed by the model. Dr. Clapham felt that the majority of the animal species could exist on the untilled land. He admitted a reservation of his own: that a drawback of the green revolution is that, without careful preservation, the older plant varieties might be forever lost.

Prof. Leibnitz noted that good results had been obtained through fertilization over the past half-century but wondered about the stability of the synthetic soil system that was being built up. Dr. Clapham agreed that this problem was of urgent concern but regretted that he had been unable to find any treatment of it in the ecological literature.

Discussion on
"Integrated Food Supply and Need Model and Assessment
of Long Term World Food Crisis"

by Dr. J. Richardson

One participant noted that land reform measures were not a salient part of the model and wondered if this might not be a failing. Dr. Richardson said that his own experience had indicated the importance of land reform and hoped that it would be more explicitly treated in later versions. Prof. Pestel agreed that American productivity figures required land reforms to achieve the economies of large scale operations. He also showed how the model was able to regard productivity as the function of fertilizer capital with the assumption that significant changes in land holding policies would shift one to a different functional curve within the class of functions.

The discussion turned toward the philosophy of the modelling and the modes of its presentation. It was argued that, from a practical viewpoint, the most important aspects of any modelling effort were its policy handles which were felt here to be insufficiently clear. Another participant restated this as a fundamental skepticism for general purpose simulators. He urged that they be question-specific and asked what questions had guided the construction of this model and how they had been chosen. Prof. Pestel said that the model had not been specifically geared toward answering questions, but that important questions--as in the energy model to be presented tomorrow--had arisen in the course of the work. Prof. Mesarovic agreed, but sensed that concern over the food supply had been a focal point from the start. Prof. Dantzig felt that there was an adequate fundamental question for any model in the prospect of millions of babies starving to death.

A scientist stated his personal axiom that any modelling work should be accompanied by an estimation of possible error. His own modelling work had run World 3 under what he judged to be reasonable error assumptions. It showed that after a number of years these errors were so compounded that the final probability distribution was impossibly broad. As a philosophical aside he repeated the opinion of political science that the only valid model is adaptive learning.

Prof. Mesarovic said that his group was concerned about possible error, and strove to make the model clear. He noted that certain findings were error-free. Prof. Pestel said that after many favorable assumptions had been made, all scenarios

still led to the blackest of results. Their tentative conclusions were thus couched in these terms and did not rest upon assumptions of infallibility.

A participant summarized his own reaction to the food and population presentations. He felt it critical to identify normal states of the world model as these would affect many constraints. We all agree that population for the immediate future will continue to grow. Our task is to extrapolate this growth and to apply a feasible control policy. We should work to reduce the fringe at which food acts upon the population. His personal view--although it may be a hope--is that education will have more effect upon population than will the shortness of food.

Discussion on
"The Energy Resources Model"
by Dr. H. Maier
and
"The Energy Supply Model"
by Dr. H. Bossel

Discussion was opened by Prof. Häfele, who questioned the hierarchical approach to energy problems followed by the Mesarovic-Pestel group. The group's view of energy problems seemed essentially to be regarded mainly as a question of resources supply. He suggested that the question of resources in other areas should be considered in the long-term perspective of unlimited amounts of energy. Secondly, he questioned the assumption of a constant growth rate of energy consumption, valid for all periods in the model; a levelling-off parameter dictated by constraints other than resources might be a better approach. He stressed that the long-term perspective of unlimited amounts did not amount to an easy future. The price we might have to pay in case of the solar option was the possibility of creating an unforeseeable impact on climate; the geothermal option if used on a large scale might increase the risk of earthquakes.

Prof. Pestel agreed that the energy resources problem might have been overemphasized, but at least for the transition period this procedure was applicable. The time span considered was one in which certain resources problems would dictate the policy choices. The model served to investigate certain allocations of available resources; ultimate resources were outside the period considered.

Prof. Manne also considered that the hierarchy of energy problems should be reviewed. He did not agree with the technical parameters for solar energy incorporated in the model: he did not think that the water split options involved were "on the shelf of things that could be ordered from the technologists of the near future."

Then followed a longer discussion about advantages and disadvantages of simulation on the one hand and optimization on the other. Prof. Manne emphasized that optimization models permitted the calculation of marginal costs, whereas Dr. Bossel remarked that the use of optimization algorithms as a direct decision criterion was not applicable.

Dr. Shubik asked for more information on the scenario structure. From the user's point of view was this in terms of numerical reaction of inputs, and if so, how many parameters would have to be supplied to initialize this model? Dr. Bossel replied that for this model about 100 parameters had to be specified in time series. Ten basic equations had produced most of the results presented. It could be programmed in one hour. Specific inputs with respect to coal, oil, gas, and nuclear power were provided. A more complicated model would take two days to prepare and run.

Prof. Leibnitz was surprised that the energy supply was absolutely correlated with demand. Demand in different regions of the globe would increase at different rates, and there was no possibility to include transportation and distribution options in the model. For some regions, assumptions on the investment cost of distribution would be necessary.

Another participant pointed out that the model did not assume any particular decision making structure on a world or regional scale. When a policy option was being studied using the model, this was in scenario form.

Prof. Mesarovic pointed out that this was one of the reasons why optimization in the classical sense had not been used. The testing of policy options had the character of an interactive analysis as a tool for the decision makers. This could highlight what options were available to which regions.

In conclusion, Prof. Häfele expressed the view that in the long-term perspective the problem of our technology and energy and the unlimitedness of energy could possibly have an alleviating effect on other material shortages. The use of optimization methods (e.g. price optimization) by the IIASA Energy Project was relevant to the transition period: it was in any case only one facet of IIASA's work in energy systems.

Discussion on
"The Energy Demand Model"
by Prof. B. Hughes

The very short discussion was opened by Prof. Koopmans who observed that in the model as presented, energy use per capita is based on a single causative factor, namely GNP. In most demand analyses the second most important factor is price. This factor was omitted from the model. One reason might be that the single factor GNP gives a good fit in almost all diagrams. However, there is a negative correlation between energy price and GNP in several countries in the recent past. Therefore the effects of price may have been incorrectly attributed to GNP. But it is important for valid projections that the relative influences of GNP and of price be distinguished, because the correlation in question might not continue to hold. There have been a number of studies which emphasize the role of user equipment. If that is important, the effect of the energy price is delayed making it still more difficult to determine. A second factor would be the population density.

Another question is that of the effect of climate through its influence on the mixture of heating and cooling demand. These suggestions were offered for further research into the relation that determines energy demand, keeping in mind the intended use of the relationship in simulations.

Prof. Hughes recognized that price is an important factor (also for feedback), but his suggestion is that the change in relative prices in the period 1950 to 1965 was not so substantial that it was necessary to implement it in the model. Regional differences in population density, climate, etc., were recognized, but research into the impact of these differences had not yet been made in this model. It seemed likely, however, that regional differences would not have a major influence on the model.

Prof. Klein remarked that in the period considered by Prof. Koopmans (an inflationary period), the price of consumer durables fell considerably. In North America and Europe, the price of energy consuming items had been reduced perhaps indicating a wasteful use of energy.

Prof. Mesarovic added that there were other important factors as well as price. Prices were omitted in the model because of the difficulties of allowing for price changes in the future.

Prof. Pestel suggested that the problem might be tackled by starting with different demand curves, and then distort them by a selection of possible future price changes.

Discussion on
"The Integrated World Model"
by Prof. B. Hughes

Prof. Pestel stated that the application of this model, which would be demonstrated on the computer via Hannover and Grenoble, had posed a range of different questions. For example, various scenarios could be played and optimized, but there remained a question of acceptability of the results.

Prof. Fritsch asked about the possibility of incorporating the declared price policy of the oil-producing countries, which was recently put forward by the Shah, in this model.

Prof. Hughes replied that the question of the impact of that kind of price mechanism on other sources of supply cannot be satisfactorily answered at present with the help of this model.

Prof. Pestel mitigated Prof. Hughes' statement by explaining that all these alternatives could be embedded in Bossel's model. It was necessary to have a single estimate of substitution costs versus oil costs. But even with that model there would be difficulties because the substitution pattern would cover equivalent prices; whatever is used for substitution will determine the substitution cost for the fuel.

Prof. Klein proposed that greater emphasis should be placed on the question of the extent to which oil companies participate in the profits from these prices. At present, prices generate a great balance of payments deficit in the developed nations, and thus exert severe pressure on interest rates. This has already caused inflation which in turn resulted in the oil-producing countries increasing their prices.

Prof. Hughes replied that it was difficult to know the impact of capital pull. A number of different procedures have been experimented with for the transference of capital from the importing to the exporting countries covering the various ways of linking back to the investment patterns, safety, and role patterns of the developing countries.

Prof. Mesarovic added that much more complicated relationships are involved. The real problem was how to compare different behavioral patterns: cooperation, retaliation, and squeeze. Other systems which had not been considered explicitly have been assumed in some of the changes incorporated in the model. There are assumptions which could be tested and, if necessary, be changed. More complicated systems are assumed

to respond in a certain way and responses are then incorporated, e.g. as suggested by Prof. Klein, at what point would the multi-national oil companies withdraw and their earnings cease.

Professors Hughes and Pestel discussed the assumptions made by them in more detail when calculating with this model: the prices referred to the tax element on the oil from the Middle Eastern countries. The profits also included transportation. It was assumed that both transportation and profit factors were relatively small; furthermore, a decrease in the proportion of energy costs had not been examined in respect of its differential impact on regions. They emphasized that if methodology were the first step in assessing the impact of certain aspects, it would be necessary to study for those aspects which had not been considered exponentially, but only involved implicitly, whether they would override the other points completely or not. This means on a more philosophical level that even without the ability to manipulate such a model extensively it is gratifying to see that it gives the best results to everyone concerned with the allowance for the criteria used.

Discussion on
"The Macro-Economic World Model"

Prof. Rademaker began the discussion by asking why diagonal elements of the trade-matrix are unequal to zero. Prof. Hickman said that this is due to the aggregation of countries to regions. For a nation, diagonal elements would be zero.

Asked for the accuracy and time scale of data, the authors state that the data base is the UN-statistical year-book, 1950-1970. Where data were not obtainable, data estimates by UN were used. Prof. McPherson said that the coefficients in the expressions $X = GX \cdot Y$, etc. in the Klein-Hickman model are not constant. Prof. Hickman answered that these coefficients are assumed to be time-invariant but in general they can be assumed as functions.

Dr. Mallmann asked if it was possible that a developing country could become a developed one within the model. Prof. Mesarovic declared that there were certain warnings implemented in the model by which the changed classification would be indicated.

Dr. Dyokalov asked for the difference between market and planned economics in the model. Prof. Klein answered that in the planned economies full employment is assumed, and exports are assumed equal to imports. Production is first geared to the needs of the home economy, and the rest is exported. In the market economies, decisions concerning exports and imports are made according to their profitability.

Prof. Kulikowski asserted that in Cobb-Douglas functions the structural factor $A(t) \cdot s$ is assumed as time dependent. He suggested that the labor share α should change with time. Prof. McPherson explained that in the long run better and more complicated constructs than Cobb-Douglas functions were needed.

Prof. Mottek had two criticisms:

- 1) exclusion of cyclical fluctuations, which lead to structural changes and to an increasing role of the state; and
- 2) that there are linking problems. There is no sector which produces technology; therefore crisis possibilities are not included in the model.

Prof. Mesarovic pointed out that while in the agricultural model technological and ecological strata are implemented, in the other models this is, so far, not the case.

Prof. Hickman said that the capacity utilization or distributed lag models are not relevant for the model in the long run. Moreover, there are difficulties in endogenizing the activity of the public sector.

Informal Evening Session

Prof. Pestel in his opening remarks welcomed all participants and invited them to interact as freely as they wished in this extra-curricular session.

Model Builder versus Decision Maker

A substantial part of the discussion centered on the question to what extent models of this kind could be used by the decision makers. It was obvious that the model builder himself should be well aware of the functioning, sensitivity, and limitations of his model. The decision makers (or his experts) should also have a fair understanding of the model and an interest in the design of possible scenarios. This could possibly be achieved by involving the decision makers themselves in their construction. The model can never be a presentation of the (real) system, but it should try to be a representation of the behavior of the system.

Model builders should also be aware of the constraints on the decision makers' side; e.g. it is very difficult to find policy instruments which can raise the GNP growth rate. It is important to try to build policy instruments that can be made available to policy makers and that involve interactions between available systems and the results one wants to achieve. This is not only the case on the national level, but could also be applied to the regional level as provided by the Mesarovic-Pestel model.

On the one hand, it makes sense to try to endogenize many variables, including political and social values (of higher strata); on the other hand, instrument variables should be exogenized, however, with caution.

Increasingly, the Civil Service is becoming aware of the value of using models as advice to politicians. To bridge the gap that still exists, model builders should not expect politicians to learn everything about the models, but rather should themselves learn to think and speak in terms of the politicians' problems, or, even more important, in terms of the average citizen. If, for instance, people yearn for peace, security, and a higher quality of life, quantitative models, alone, cannot provide the answer. These qualitative aspects should provide a foundation for quantitative variables.

Model builders should also forget their scientific caution. If they never release a statement unless it is 99% certain, they would leave the arena free to charlatans with a much lower level of information.

Limits to Modelling

Models can never predict the one and only future. In this sense, models will always be wrong. They serve rather to illuminate interconnected developments.

In the natural sciences control theory was successful in satisfactorily describing simple systems, but it cannot be deduced that it is capable of depicting sufficiently well far more complicated social systems. In particular, socio-economic models should clearly state the values that they are (often tacitly) based upon. If these values and the theory underlying the model structures were clearly expressed, many misunderstandings could be avoided. The Mesarovic-Pestel model, it was claimed, does not reflect such dimensions as politics, poverty, or power (e.g. the multinational corporations who might control 80% of world trade by the year 2000). From its basic concept, however, the model is defined in a way such as to admit incorporation of such a norms stratum. The model as it stands now is certainly not the last step of development.

Statistical Accuracy

At first glance, all functional relationships in this model are of a deterministic kind. Part of the uncertainty of the forecasts could be expressed by introducing a variance. It was pointed out that Prof. Blankenship would take up the topic (analysis of the statistical error) the next day. Introducing a variance, however, makes the model extremely fuzzy, even over a medium range. Experiments carried out in the UK (McPherson), assuming a 90% accuracy over a given period, no longer resulted in a tangible answer after four of five such periods. It seems better, therefore, to stick to deterministic relations, in full awareness of their limitations.

To test the sensitivity of the model, one may vary one variable at a time. This does not, however, take care of possible interactive (synergistic) effects.

Use of Exponentials

There was some dispute as to what extent it makes sense to explicitly use exponentials in certain functions. It is obvious that no development can go on in an exponential way forever. For a medium range forecast, an exponential seems permissible insofar as it is not too different from the lower branch of a logistic curve. Historical data, e.g. on agricultural fertility, have shown that exponentials

depict true developments for surprisingly long periods of time.

Price and Cost

The model does not differentiate too well as to prices and costs. Furthermore, some variables (like energy demand) are determined solely by cost and not by (physical) availability.

Conclusion

In his concluding remarks, Prof. Pestel stressed again the necessity to try to speak the language of the user of a model, and to understand his concern; this would be the quickest way to a more widespread use of models.

Discussion on
"Scenario Type Analysis"

by Prof. P. Gille and Prof. T. Shook

Prof. Mesarovic introduced the discussion topic, and he then focused on problems involved in using the model, especially on those of software problems, implementation, and the methods of analysis.

Prof. Gille presented the two possible ways of analysis in his lecture:

- 1) Scenario analysis; and
- 2) Interactive mode analysis.

In scenario analysis he noted that:

- a) certain assumptions must be made about future development;
- b) it is necessary to identify what the special concern is;
- c) a time horizon must be specified; and
- d) certain boundaries must be set.

Formulation of the scenario is the task of the expert, and the problem is simply how to implement what the expert recommends. The implementation is made easy by the data structure and by the software available. A data bank consisting of primary, secondary, and trans-generated data is already organized, and different submodels also already exist: e.g. energy, economy, technology, food, population, resources, etc.

When building up a scenario, generally only parts of the different models are needed. So a new model is composed for the specific issue from the data bank. The programs for doing this are available. The necessity of a computer language that can be used both by the computer and by the person who will have to use the data afterward was acknowledged. In order to make efficient use of the computer, man and the machine must be able to interact in a certain way.

Dr. Fritsch pointed out that if the model must be handled as a tool for crises management and immediate answers are required, the time for constructing such a model is very short. Prof. Mesarovic stressed the need to be able to predict crisis situations by means of the models. They were flexible in this respect. The procedure used was, in essence, to assemble a series of relationships and data out of which a problem-specific model could be constructed to determine what is the most important of the issues. Prof. Klein argued that it was not necessary to construct a new model at the time of crisis, because by simply changing the inputs to the model and re-simulating, the model would give all the necessary indications. The changes could be effected in two days.

The discussion then turned to the question of application of the models by individuals and institutions outside the research community. Prof. Pestel indicated that briefing meetings with policy and decision makers were planned. Prof. Pestel informed the conference that he planned a separate meeting for the policy and decision makers on the questions of concern to them. Dr. Carlos Mallmann suggested that users of the models in the developing regions might find their structure alien to them. Prof. Pestel pointed out that if particular regional users found the data biased, they could use their own data. Other participants stressed the importance of interactions at all levels and the tactical problems involved.

Further comments were addressed to the problem of the time span covered by the models. It was pointed out that different issues involved different time spans, but that the longer the time span the coarser the model.

Discussion on Global Modelling

Prof. Pestel opened the meeting by saying that Prof. Klein had been pressing for this discussion. On the whole, the discussion is generally centered on the modelling project, and Prof. Klein was asked to begin.

Prof. Klein said that the motivation for suggesting this meeting stemmed from a proposal made in 1973 that IIASA should organize several such conferences. This implied that there could be other approaches to global modelling.

During the previous two days a particular way of implementing a global model project had been presented. However, if anyone else was starting out from scratch, they may have a different procedure. He had three personal ideas for approach:

- 1) to use the traditional approach of economics and econometrics, i.e. to first obtain a body of data (historical or present structure) and to fit a structured model of different processes, and then study historical and technical performances before extrapolation;
- 2) to use technical information, e.g. from engineering and agronomy relating to how certain world processes work, or a mixture of the two; and
- 3) to build up very loose relationships such as age-specific fertility and mortality rate, which reproduce history, and then put in whatever values require to be tested.

Prof. Pestel added that the history of the project had undergone several mutations during the process of its evaluation: for example, from the different approaches (theoretical, optimization, etc.) the present pragmatic approach was chosen. Prof. Abkin gave information about the Korean model and emphasized the problems of collecting data. Prof. Pestel considered that it was possible to build a model as a mental construction into which an image of a real system can be projected, regardless of the availability of data. Data cannot be found in this case because they have been collected and compiled under a different image of the system. When new statistics are compiled in an area, the first task should be to construct an image of that system in order to have the right data. Generally one must compromise: it is impossible to construct

a model for which there is no data, and so one has to stay within the boundaries provided by the data, without sacrificing the mental picture.

After some remarks by a participant about the possibility of integrating different methodological approaches, Prof. Weiszäcker asked to what degree could past catastrophic events (such as the two World Wars) be identified. Prof. Pestel replied that a war cannot be predicted by the model. If some alternative decisions were tried in the model, certain developments would be seen that could later on be interpreted as such. Vast masses of unemployment and indications of starvation can imply that there is a region of great instability, but one could not say what this actually leads to.

Prof. Labys said that during the course of this project someone should very seriously look at the question of validation and do some theoretical work on validating these types of models. According to Pestel the lecture of Blankenship will answer this question. Nevertheless, though the future is to a certain extent conditioned by the past, the past is actually no guide to the future. Prof. Labys argued that in the professional field of model building it is necessary to validate; otherwise it is impossible to judge the quality of the work. A short discussion between Professors Peschel and Pestel followed about the extrapolation of future development.

Dr. Shubik said that concerning the doomsday predictions and crises analysis there are three things to be considered:

- 1) perception of the problem;
- 2) dimensional analysis of variables of the problems;
and
- 3) sensitivity analysis of the models.

He gave an example of how the crime rate appeared to be rising although reading back through history it would appear that only the reported crime is increasing. The problem is in the perceptual mechanism and the quality of analysis. It is precisely in this area that we have to face up to problems of how we go into model specification and interactive procedures.

Prof. Demirdache asked if conflict situations are reflected in the model or not. Prof. Pestel answered that

in a limited way it is done. A discussion followed concerning the historical validation between Professors Demirdache, Klein, Rademaker, and Cole. Prof. Kumon then stressed the importance of deciding what type of model to use in every special case. Prof. Mottek spoke about the necessity of having a research strategy. According to Prof. Rabar's remark, while the Forrester-Meadows model was overdetermined, this new model is underdetermined by giving too many options to the user. Prof. Pestel referred to the following meeting which will make everything clear.

Discussion on
"Ergonomics of Man-Machine Interaction"
by Prof. J. Klabbers

Prof. Klabbers' presentation dealt with the "interactive mode" analysis as opposed to the scenario type discussed in the earlier session. Particularly, his work focused on the human machine configuration in which the human being provided judgment guided by norms and values, and the computer program provided logical and numerical operation. Thus the computer is programmed with a causal stratum as well as a decision stratum. The functioning, or process, of the human-machine decision-making system was illustrated with a series of overhead projections showing first the general "index of hierarchy" consisting of the:

- 1) goal layer;
- 2) policy layer;
- 3) strategic layer;
- 4) tactical layer; and the
- 5) implementation layer.

These indices were further defined, showing the various responses inherent at the various "layers": i.e. the "goal layer" has an index to hierarchy showing economic growth, minimal interference (change), and environmental enhancement, and so on. The hierarchy should be constructed in such a way that search-time is minimized. The different possibilities should then be as few as possible, and a part-prediction will be required. The inputs might be changed and some decisions could be taken during the run. Some decisions will naturally be implemented. There must be a specified level for the variables from which they could influence the decisions. In order to be able to evaluate human decision-making and planning properly, it was emphasized that one has to be sure that the interface, as such, does not interfere with the actual task, i.e. planning the evolution of the system under consideration.

Prof. Klabbers went on to discuss the aspects of information retrieval from the point of view of the objectives of the human decision-maker in planning the future developments of the system. He followed this up with a brief definition of the task of the interactor, and an explanation of the control skills necessary in controlling a complex social system.

In the discussion of "decision-maker display interaction," the work on computer interface developed and applied by Thompson (1971) and Clauer (1972) was used as an example. Dr. Coales discerned a number of points relating to the actual functioning of the interactive system and the principle involved. Considering the information retrieval aspects, he was concerned with whether the system had the facility for going right back to the beginning. He considered this as a particularly fundamental question. Prof. Richardson in reply pointed out that the variables which characterized the incidences were quite different. The variables in control interfaces were those which could be manipulated, at least in that sense the distinction was meaningful. After a brief discussion the presentation of Prof. Rechenmann followed.

The system of cooperative work between man and computer was described by Prof. Rechenmann. Basically, a division of labor is made between the two; man makes the decisions on values, priorities, costs, and the level of risks to be taken, and the computer indicates the breadth of choices and likely consequences. The computer component of this team is comprised of a decision stratum, where the various functions performed in the process of arriving at a decision and the conditions and constraints under which those decisions are made, are modelled, and the causal stratum which represents the model of the regional economy and the basic energy relationships. This model reproduces the evolution of the basic economic processes and functions of the economy over time: production, consumption (government and public), export-import, capital formation, etc.

A further definition of the decision level showed that it is composed of four levels, or decision layers: the goal layer, policy layer, strategy layer, and implementation layer. Each layer or level is assigned a specific role, with the functions of the upper layers being broader and concerned with longer time periods, while the lower layers are more technical and concentrate on immediate objectives. Final decision is determined as a functioning of the coordinated response of all layers. Prof. Rechenmann went to explain the responsibilities and characteristics of each layer in detail.

Communication by the decision-maker with the machine is, of course, the prime issue in inputting commands and in obtaining feedback from the machine. For these purposes

an elementary command language has been implemented. There was some discussion of the decision-maker's role in "requesting" and "instructing" the machine, and of the computer's method of responding in a natural language with desired graphs and data. While "requests" on the part of the decision-maker are generally a set of policy alternatives or actions available, "instructed" inputs are primarily decisions on policies, actions, parameters, on implementation or on return to a previous stage for additional considerations. Some of the problems encountered in this language and interaction system between man and computer were further discussed by Prof. Rechenmann.

Dr. Mermet began his presentation by making some general remarks about the goal and specification of sophisticated software tools. He felt it was necessary to make a distinction between the person who builds the software tools and the person who must ultimately use these tools to build models. Work in the computer can be compiled in two ways:

- 1) by programs; and
- 2) by description.

The importance of syntax and syntactical description was stressed.

In the discussion of his presentation, Dr. Mermet dealt in particular with:

- 1) the goal and specifications of the software tools;
- 2) the structure of the simulation systems;
- 3) descriptive languages;
- 4) data base management: SOCRATE;
- 5) the kinds of scenario languages; and
- 6) the interactive system/multi-user, multi-models, multi-processor, systems.

He also included some general identifications of procedure hierarchy, as given in the Mesarovic books. Hierarchy was defined as "an oriented network without a cycle." Explanations were offered for "Precedence Hierarchy," which can be described as an interconnected set of sub-systems

forming a network without a cycle, and "Inclusion Hierarchy," in which each part of the described system may be divided into sub-parts, thereby giving a relation of order. Inter-strata connection and physical strata were considered as another important dimension.

On the matter of timing and the problem of time generally, it is considered necessary to describe the parallelism between the strata. Dr. Mermet pointed out the doubtfulness of being able to define one computer language for all models, and said that, rather, an arbitrary set of initial instructions will be defined.

A diagram of "Data Base Management" relating the computers of Grenoble, Hannover, and Cleveland was supplemented by a discussion of the problem of data base management, which is considered as one of the most crucial. A short discussion followed between Professors Coales, Mesarovic, and Mermet about how the hierarchy is represented in the model. Some additional remarks were made by Professors Herrera, Hughes, Mallmann, McPherson, and others concerning the interconnection between the sectors, regions, and strata. These connections were not clearly explained. After some explanations of Prof. Mesarovic the meeting was adjourned.

Discussion on
"The Environmental Impact Model"

Prof. Häfele opened the discussion by referring to his earlier statement that the models presented were too resource oriented. Furthermore, he felt that environmental considerations and assessments should be put before the resource questions. Prof. Pestel responded by stating that Prof. Häfele's view is a matter of personal judgment and that he feels there exist acute resource problems today which will only become worse in the future. Prof. Mesarovic, in response to Prof. Häfele's question, expressed the idea that one must look at the whole strata. He felt that the issues between resources and the environment would become more important after the year 2000. He expressed the need to face the problems of time immediately.

Prof. Fritsch expressed the feeling that the strategic issue is the carrying capacity of the ecosystems. These ecosystems, he feels, are the super-resources of mankind. Prof. Mesarovic responded by stating that they are concerned with the resource question, and what will be limited in the short run. Prof. Pestel added that it would be useful to discuss the time question.

Prof. Häfele stated that this group at IIASA agreed that most of the serious problems begin after the year 2000, and that governments should start preparing to meet these problems by 1985 or 1990. In order to evaluate the acceptability of something in 2000, you must begin to do something now.

Prof. Mottek expressed the idea that regional impact on the environment was a critical issue. Environmental questions start locally but spread, and affect broad areas including both the industrialized and non-industrialized areas. He stated that the environmental decay is almost instant, and research into its impact upon the climate and human activities is vital. We should not wait for the year 2000. Prof. Pestel responded by stating that the emissions due to energy production raises environmental considerations of a different nature. Some energy methods produce environmental effects beyond localized effects. For example, Pestel feels that coal will play a larger role during the transition period up to the year 2000.

Prof. Raiffa, in response to Prof. Mottek, stated that IIASA is concerned with the present, as well as the year 2000. Some of the approaches being studied include: monitoring

systems, linkage between pollution effects, mortality, fertility, etc. It is hoped that an integrated systems approach will make the research more homogeneous. Prof. Häfele also included that IIASA will soon begin looking at climatic questions.

Prof. McPherson raised the issue about single issue models which give rise to serious secondary environmental effects when applied in planning. He gave the High Aswan Dam on the Nile River and the Irrawaddy Dam as examples. He asked whether the models presented will fit into a "total" ecological model and expressed his belief that a set of models does not constitute a "total" model. Prof. Mesarovic responded by stating their concern with the global aspects. The single-issue models were presented to show the progress being made.

Prof. Mallmann stated that the integral approach to modelling should concentrate upon human needs and ways to satisfy these needs. The real problems, he feels, are related to yesterday and today, not the year 2000. People are dying today and we should concentrate our efforts on health, education, housing, urban problems, etc. Prof. Pestel responded by stating that they are concentrating their efforts on the transformation period of the next twenty-five years.

Prof. Clapham also responded by stating that the long term problems are the important problems.

Prof. Häfele raised the issue of identifying "resilience parameters" in ecological systems. Prof. Pestel responded that he felt their approach was the correct approach and that they were asking the right questions.

Prof. Shubik recognized the difficulties in handling detailed technical questions concerning the models, but he wanted to know how they planned to integrate the various models into a "world model" in a way that he could, operationally, understand them.

Specifically, Prof. Shubik wanted to know their institutional manifestations, if they were to be funded with \$200 million. Prof. Pestel responded that they could use 500 man years over the next five years to resolve certain real issues and to achieve integration. Prof. Mesarovic responded by stating that, inherent in Shubik's question, there exist basic intellectual and conceptual issues. A funding level of \$200 million would be moving too fast. He would like to get academicians, politicians, and decision-makers involved together in the hope of influencing decisions.

Prof. Pestel added researchers are constantly lagging behind the problems. One of their objectives is to get ahead of the problems, but this is difficult since this involves putting priorities on problems and identifying the most important scenarios.

Discussion on
"Development of Norm Stratum Model"
by Dr. H. Bossel and Prof. B. Hughes

Dr. Masini pointed out that the resistance to changes in value have to be taken into account, especially in this model, where it is attempted to forecast the future and the change in values. Dr. Masini thought that it was the monetary variables that would be able to indicate the changes.

Prof. Bonhoeffer said that norms are also a question of social conflicts. Skipping these interrelations avoided almost every problem. He thought that conflict was treated too aggregated, since it may appear in the model only among regions, but it should occur also within the regional boundaries.

Dr. Bossel answered that they were quite aware of the problem and that they were trying to incorporate it into their model. Their more recent concepts foresaw a normative and a decision strata for each interest group involved in the conflict. Presently work was going on on a research project on conflict to see what strategies each group would select.

Prof. Coales found this the most interesting paper presented at the conference. He was interested in the criteria used in choosing a policy. He put three questions:

- 1) Are all quantities turned into money terms?
- 2) Are opportunity costs considered on alternative policies?
- 3) How are alternative policies ordered and ranked?

Prof. Hughes replied that their approach is not geared to select a single policy but rather a mix of policies. Prof. McPherson then asked how the best mix is selected.

Prof. Hughes explained that they have a search procedure which begins at the old policy (usually a mixed one). They then looked at the dissatisfaction and the policies that seemed most promising, and they searched for a more refined set within that. This also tied in with the question of units in which dissatisfactions are evaluated. Once again, it was impossible to express everything in the same units. A way around was to express dissatisfaction in terms of normalized distance from the goal.

Prof. Dantzig asked why terms appeared squared on the formula for the objective. Prof. Hughes said that it was due to their belief that deviations had to carry a bigger weight the further you were from your goal. Of course this occurred only when the goal has not been achieved and the measure of dissatisfaction was obtained by summing up the normalized squared distances for those goals that had not been achieved.

Prof. Mottek asked if in avoiding a catastrophic situation it was enough to look at it in terms of decisions only, or if attitudes too should have been considered important, since they definitely can have an effect on decisions. Dr. Bossel replied that attitude changes could only become manifest through the decision for some action. This may not have been an explicit decision, but some action results out of it. He thought that in this fashion it could be modelled.

Session on Thursday Afternoon

Outside the presentation of the Mesarovic-Pestel model, the Thursday afternoon session was devoted to short presentations of the Global Modelling efforts of other groups.

As the spoken contributions had to be limited to ten minutes each, it was agreed that elaborated versions would be included in the proceedings. The following section contains these versions as sent in by the participants in the Thursday afternoon session.

An Austrian Simulation Model for
Socio-Economic Policy Making

P. Fleissner

I would like to make two comments, the first a technical one. If one is working with the model and he is politically naive, and maybe will change a certain structural coefficient, the model can read to this disturbance by changing political behavior of one or more power groups. It could be that the initial naive change is corrected or amplified by the political feedback loop built in the model.

The second comment is a private and political one. I do not think that necessary political measures can be undertaken in time if we do not leave the ivory tower of the scientific community and cooperate with the social groups which are most concerned with crisis symptoms, although it could happen that these groups are not necessarily the prevailing ones.

Listening to the comments made by Cole, Mallman, Mottek, Shubik, and others I have been encouraged to present some experiences with an Austrian pilot study. We tried to look at reality, especially at our Weitean reality, not only in technical, scientific, technocratic, or interactive terms, but in terms of political, ideological, and economic power too. We think that in our country there exist certain structural constraints which will come to the surface if one is making plans for certain policies. These facts are not reflected, as far as I have seen, in the P-M model and therefore conclusions can be misleading, although much more information is available. Further on, the P-M model does not assess the antagonistic or conflicting interests of different social classes which are indeed very often responsible for social or economic changes and development within a region.

In this respect I will now give an example which could easily be generalized to the world's model structure, within and between regions, and how we looked at these problems in our model. At the Institute for Advanced Studies, in collaboration with the Austrian Academy of Sciences, we are developing a simulation model for socio-economic policy making. We do not think that there is harmony in this process of policy making and we stress the point that power force is influencing decision making.

1. SOCIO - ECONOMIC STRATUM

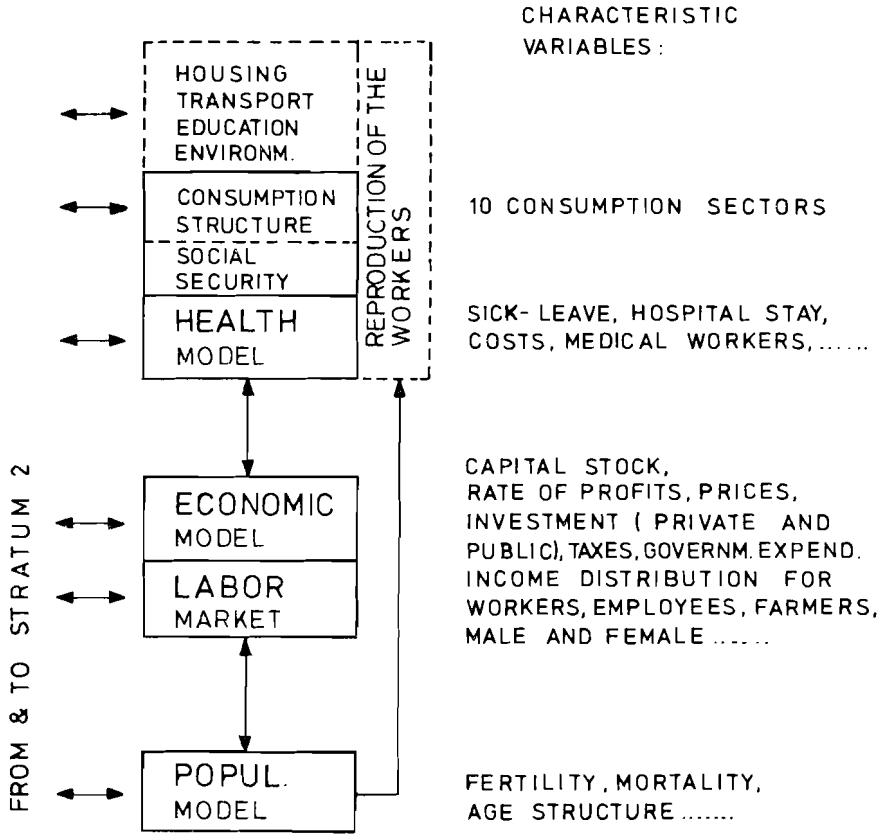

DATA BASE 1954 - 1970
SIMULATION 1961 - 1995

~ 500 EQUATIONS, NONLINEAR, PARTLY SIMULTANEOUS,
PARTLY ECONOMETRICALLY ESTIMATED, IF DATA AVAILABLE
PROGRAMS IN FORTRAN

FIGURE 1

2. POLITICAL STRATUM (ONE POLITICAL ISSUE)

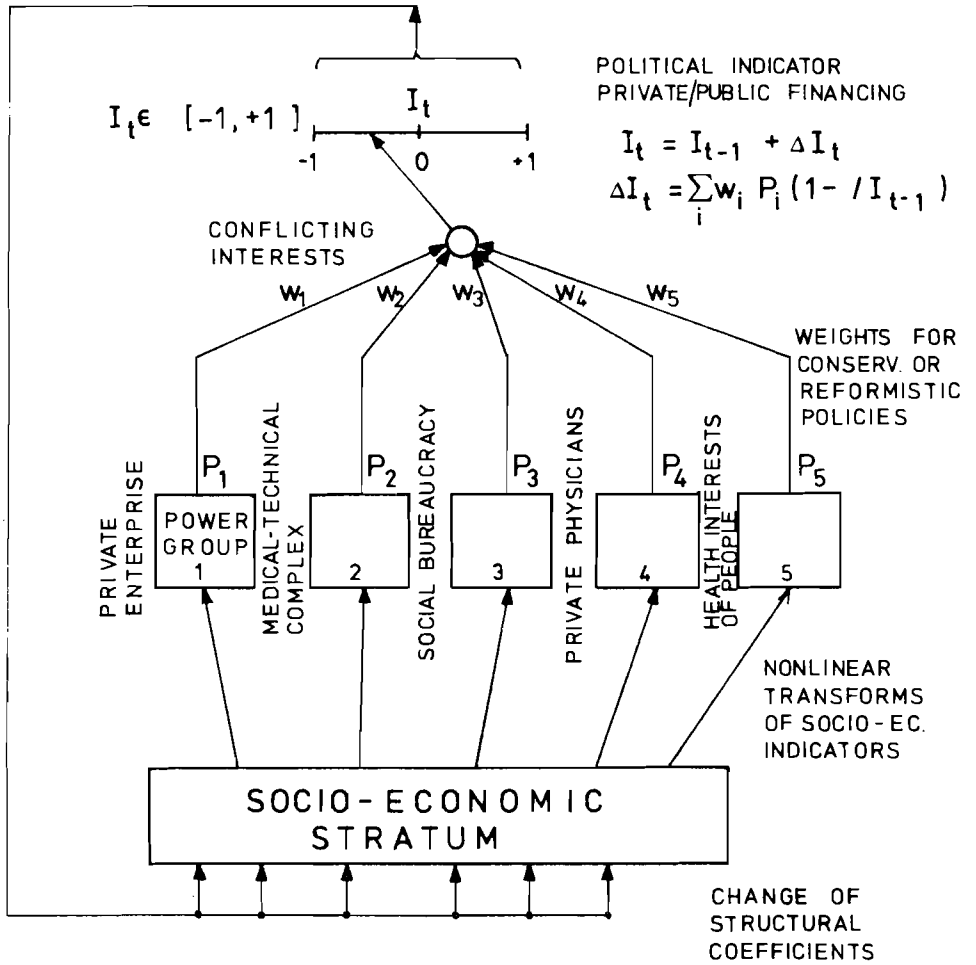

FIGURE 2

Some Remarks About the Dynamics of the Economic System
and Its Links Especially with the Technological Field

H. Mottek

The trend in the quantitative changes of input and output, of growth in terms of an increasing gross product as shown in the data appendix to the reports on the economic world model by Mesarovic-Pestel as well as in other documents, can obviously continue in the future only if the necessary conditions of these changes remain. Many of these conditions lie outside the economic system, though they are influenced by it. There are, however, some indigenous, necessary conditions for the trend. To realize this, let us have a look at what the authors of the report call the developed market countries. (At the conference, the word "market," by the way, was used so that a highly industrialized country such as the German Democratic Republic appeared to be not developed.)

In these developed market countries the historical experience shows that changes of structure had been necessary to avoid a long-term change of trend such as a stagnation of output. The authors robbed themselves of the opportunity to recognize that by neglecting such relative short disturbances as the cyclical fluctuations. But in economic history there have been periods with very many short-term fluctuations with predominant influence of the downs. For example, this occurred in the period from 1873 to 1894, and the period known in the Anglo-Saxon countries as the Great Depression of 1929 to 1938. Both of these periods led to structural changes in the so-called developed market countries. I only want to mention the restriction of competition for the first period; for the second period, the enormously increased intervention of the state became a characteristic feature of the economic system in those countries from then on. What interests us now is the fact that these structural changes (and the driving forces arising from them) were a necessary condition for keeping up the long-term trend of growth: they prevented short-term retardation from becoming long-term.

The stagflation of our time has, however, made doubtful whether the changes of structure in the past are sufficient for keeping up the trend. The question arises therefore, whether structural changes are to be expected in the future, or whether there will be a radical change of trend, i.e. a long-term stagnation, or finally, whether the whole system of the so-called developed market economies will perish. Whatever the outcome will be, the fact remains that structural changes--although they find their quantitative expression in

short-term fluctuations of the main parameters of the model--have not found their right place in the model.

It is obvious that the continuation of the quantitative trend in the economic system in the past as well as in the future depended and will depend not only on structural, but also on technological changes which are therefore important for every regional or world model. If we consider a long enough time horizon, then, without technological changes, even the high investment income ratio cannot stop a slowing down of the increase in output per head so that the rate of increase approaches zero; it might even become negative. Without what is called labor saving technological changes, the labor force would be the limiting factor. Whereas under these conditions the increase of output must eventually stop in any system, under the developed market system this would mean an economic crisis, a sharp decrease of production, because of the collapsing demand for machines and other investment goods.

But limits of this kind are not those now so much under discussion after the book by Meadows, but rather those caused by increasing pollution or decreasing resources. It is very often forgotten, however, that, for example, a trend of increase in pollution can only continue if there are no technological changes which diminish pollution to a sufficient extent without diminishing capital productivity on the same scale. The same holds for mineral resources. It is an assumption implied in the model by Meadows that the decrease of certain mineral deposits is not compensated by resources-saving technical progress, increase in resource productivity, resources enlarging technical progress in other fields, such as recycling, discovery of new deposits, making deposits useful for which there was no use before, finding substitutes, and so on. We might call this "resources enlarging technological progress," when we define resources as such parts of the natural environment that are economically available or are being made available for production by increase of technological knowledge. If we take the investment income ratio as given, and put aside such a question as the infrastructure, then the necessary technological changes might not be forthcoming for two reasons:

- 1) As the technological changes are directed by the goals of the economic system, there might not be such goals and the corresponding demands on technology. So it has become doubtful for more and more people in the "developed market countries" whether the economic system can effectively put forward demands in the direction of saving social costs, in the direction of a technology in harmony with environment. In this sense the development of technological changes is dependent on the social and economic system.

- 2) Even in the case of urgent demands by the economic system, certain changes might not be forthcoming because the answer given by what we might call the system producing technological knowledge is negative. Apart from the ability of this system, under the aspect of organization, personnel capacity, equipment, incentives, apart from the state and development of scientific knowledge, the negative power could be the consequence of a technological impossibility. It is perhaps noteworthy that statements of economic impossibilities can be transformed into statements of technological impossibilities. For example, at the conference during the discussion of the food question, the greenhouse was considered economically impossible as a basic solution because of its high costs. But this statement of economic impossibility could be transformed into a statement that it is impossible to develop a suitable technology of production and operation of greenhouses that makes them cheap enough for general use. So we can now see that there are implicit assumptions of such impossibilities in the model by Meadows. In a new world model those assumptions should be made explicit and then examined as to their validity. It is necessary to examine whether such impossibilities can or cannot be founded on the laws of physics or any other science. But even if this can be done, it is not so easy, and it might be the cause of many misunderstandings to translate a statement of impossibility made in the language of physics into the language of technology and economics.

Apart from this, there is still a lot of research that needs to be done to prove statements of technological impossibility to make these statements more reliable or to show them to be non-existent. Such research would be a very urgent task for making the consequences of an option of society more predictable and for producing new options.

Without theoretical progress in this and other fields the predictive capacity of any world model will not be large enough to carry conviction.

PAPERS CONTRIBUTED BY PARTICIPANTS

Modelling Growth Factors in Israel

Prof. Nathan Buras,
Technion, Haifa, Israel

We are in the initial phases of a multi-disciplinary and multi-institutional research effort in which critical relationships between factors assumed to have controlling influences on our future will be studied. The objective of this effort is to produce sets of alternative plans covering horizons of 10-15 years, to be submitted to the highest levels of policy makers in the country (different statutory parliamentary committees and the government), so that the rational basis of the political decision-making process would be strengthened.

Our approach is that these factors may be divided into two groups: socio-political and natural-technological. Economic aspects will appear in both groups, thus forming connecting links between them. We are now organizing research groups within each of these two avenues, and are seeking efficient mechanisms for their coordination and for increasing cooperation between them. We place special emphasis on the socio-political aspect of the growth factors, and have included in the guidance committee of this project a member of the parliament, representing the political process as it is manifested in Israel.

The research effort in the socio-political channel will be directed primarily toward the formulation of scenarios dealing with plausible internal and external situations. These scenarios will form then the framework within which optimal configurations of the natural-technological determinants will be sought.

We envisage our connection with global models in several ways:

- a) We would like to investigate the situation in which a crisis situation in one part of the world might produce a global "domino effect", and what can be done to increase the resiliency of our socio-technological fabric to withstand such shocks.
- b) What kind of "de-coupling" mechanisms, if any, might be available in the event of world-wide crisis in one of the factors controlling growth.
- c) Israel may be used as a case study, or pilot project, for problems of global interest. Within its population of slightly over 3.5 million there are self-governing

groups who own collectively the means of production and who abolished completely private ownership, living alongside other groups who epitomize free enterprise. This symbiosis exists within the context of a particular brand of welfare state.

- d) In at least one respect, we are close to the physical limit of development. More than 90% of the available water resources of Israel have been developed already. The adjustment of the socio-technological fabric to these conditions might be of interest to those engaged in global modelling.

NB/mf, 3 May 1974

Dynamic Population Model

- presented by A.R. Demirdache

A dynamic population model has been developed by the Department of Mathematics at Queen's University, Canada, under contract from Federal Government in Ottawa. The model simulates the evolution of population distribution as function of age and income level.

The basic structure of the model is such that birth-rates may be generated within the model as endogenous variables. This allows the inclusion of feedback effects from the population distribution to birth and immigration rates, and so provides a capability for simulations valid over longer time intervals than are possible with exogenous birth and immigration rate variables.

Traditional demographic methods project population estimates forward in time by means of an aggregation procedure, followed by a linear extrapolation procedure based essentially on a Markov-chain type of model. Such methods are reasonably accurate over the relatively short term; however, the model structure is such that the fertility curve (the age-specific distribution of the birth-rates) is treated as the "exogenous variable" which must be specified for each run. Some attempts (the so-called "cohort method") have been made to include in the model the observed fact that birth rates do

vary over time, but the problem of extrapolating birth-rates forward in time in order to increase the length of time that model results are valid remains.

It is clear that many factors affect birth-rates; economic conditions, perceptions of future economic conditions, ecological concerns, a host of other factors affect birth-rates to a greater or lesser effect. It is also clear that present population structure affects in turn the economic climate, and the general environment. The present population is in turn the result of past birth-rates (and immigration).

The observations indicate that it is impossible to decouple the dynamics of the birth-rates from those of population structure without compromising the long term validity of the model simulation. In effect, there exists a feedback path from population structure to birth-rates which may not be ignored over the long term.

Derivation of Equations of Dynamic Core

The core of the model consists of two partial differential equations: one for the evolution of the population density as a function of time, age, and income level, and one for the evolution of the fertility curve. These two equations are coupled in a non-linear fashion, although the non-linearity appears only in the boundary conditions for the population equation. This fact is of considerable use in connection with the estimation problems discussed in the

following section, and makes the derivations presented below simpler than might otherwise be the case.

A. Population Distribution Evolution

The model considered in this paper includes a partial differential equation for the population density $p(x,s,t)$ as a function of the three variables age x , income s , and time t . As will be shown below in Appendix A, it is unnecessary to specify at this point the units involved in the income scale s , that is whether s represents net income, disposable income, or some other measure. This is so because the form of the governing equation is invariant under a (non-linear) change of income scale, so that the units involved become an issue only during the processing of data for estimation purposes. This fact is a pleasant surprise which naturally arises out of the structure of the model equations.

To derive an equation for the population density on a realistic basis, it is necessary to account for effects neglected in the simplified model above, in particular to introduce terms

$$i(x,s,t)$$

representing the immigration rate (as a function of age, income level, and time) and the death-rate

$$r(x,s,t) .$$

It is also necessary to introduce a term which accounts for the change of income level of various segments of the population over time. To accomplish this, we introduce an economic mobility function,

$$u(x,s,t) \quad .$$

Even though income levels of individuals on a microscopic scale undergo changes at discrete instants of time, perhaps modelled by a Poisson process, on the macroscopic scale of its influence on the income distribution we model the effect as one of a continuous flow across income levels. With this effect in mind, a term of the form

$$u(x,s,t) \cdot \Delta t$$

has an interpretation as the fraction of people at income level and age x crossing through level s in the time interval from t to $t+\Delta t$.

With the above definition of terms, it is easy to use a "counting argument" entirely similar to the one above to arrive at an equation representing the evolution of population density. The result is

$$\frac{\partial p}{\partial t} = - \frac{\partial p}{\partial x} - \frac{\partial}{\partial s} (u(x,s,t)p) - r(x,s,t)p + i(x,s,t)$$

Just as in the above derivation, it can be seen that the appropriate boundary condition for this equation is again

$$p(x=0) = \text{birth-rate.}$$

B. Fertility Curve Dynamics

Although the observation that socio-economic conditions, social attitudes, and so on, exert an effect on birth-rates is a common one, there seems to have been little effort made to quantify these effects in a dynamic model. Undoubtedly, a major reason for this is that it appears impossible to "derive" such a set of relations in the sense of the derivation outlined above for the population density dynamics.

A simple partial differential equation capable of reproducing this observed behaviour has been adopted as the basis for the fertility curve dynamics. This is

$$\frac{f}{t} = -a(t) \frac{d}{dx} (d(x) f) - b(t)f .$$

The first term in this equation produces the effect of the shifting peak, while integrating the equation with respect to x shows that $b(t)$ is the percentage change of the area under the fertility curve per unit time. An equivalent interpretation is that it represents the percentage rate of average family size.

The justification of the representation of the fertility curve dynamics by the above equation may be carried on in several ways. In the first place, the interpretation given $b(t)$ guarantees the presence of the term $b(t)f$ in virtually any such equation. The appropriateness of the term representing the "shifts" may be supported on the basis of a time scale argument, combined with the fact that the model fits the observed data reasonably well. The "shifts" occur in the data on a time scale considerably faster than that of the dynamics of the population section of the model. In fact, the shifts appear correlated with variations in the economic climate, recessions, rising and falling unemployment, and the like. Since these effects are expected to be introduced into the model most likely on the basis of "standard" econometric and business cycle models, it is anticipated that it will be possible to include the function $a(t)$ and its dynamics in this section of the model. The dynamics of $a(t)$ are to be identified by means of either the usual econometric model identification techniques, or more recent work in the area of control theory. Since this identification problem presupposes knowledge of the term $d(x)$, work in this area is dependent on solving the problem of estimating $d(x)$, and applying the algorithm for this purpose is described in the following section.

Comments similar to the above also apply to the problem of determining the dynamics governing the term $b(t)$,

although it is suspected that this will be even more difficult than the above process. This is so because $b(t)$ is dominated more by social attitudes, education, and other effects much less easy to quantify than economic ones. It is felt that this area represents an example of the need for alternative sub-models and repeated simulations discussed above in Section II in connection with the overall structure of the model.

While the above discussion has been carried through as though the fertility curve were independent of income, an entirely similar derivation is possible on the basis of an income dependent fertility curve. If one also allows the possibility that the economic interactions occur unevenly across income levels, then the appropriate equation is

$$\frac{f}{t} = - \frac{\partial}{\partial x} (a(x,s,t)f) - b(s,t)f \quad .$$

Because of the meaning of the fertility curve (or surface, if s is included as an independent variable) as an age (and income) specific birth-rate, the formula for the total birth-rate is simply

$$b(t) = \int f(x,s,t) p(x,s,t) dx ds \quad .$$

Written contribution to the Proceedings of the IIASA Symposium on Global Modelling - May 1974.

Notes on the "Doubling of Population". Study - Free University of Amsterdam, under direction of Prof. H. Linnemann

The problems of a doubling of world population.

One of the major problems facing mankind in the remaining decades of this century - and most likely also in the next century - is the rapid growth of world population and the pressure on the world's limited resources created by greatly increased population numbers. Barring calamities of unprecedented magnitude, it would seem to be certain that world population in the near future - around 2010 - will double its present size. At the Free University in Amsterdam a study is being undertaken to determine whether it will be technically possible - even for a world population of twice the present size - to provide everyone of the world's citizens with the material requirements for a decent human life, and if so, what policies should be followed in the areas of production and distribution in order to meet these requirements in ways which appear consistent with what we know of resources and environmental constraints.

Making explicit the idea of minimum levels of living.

The basic package of material goods required for human life consists of four components:

- a. food
- b. housing and sanitation
- c. access to adequate health services
- d. the means to gain a basic education. In addition, a certain amount of
- e. "other goods and services"(like e.g. clothing, furnitures, kitchenware, transport, recreation) will be required.

It is a matter of judgement what levels of provision are adequate and acceptable; norms are being formulated, whenever possible, on the basis of internationally accepted standards.

Methods of the study

The scope of the study is worldwide; for obvious reasons, regional disaggregation is essential. In fact, part of the work is being done at the country level. Apart from economic magnitudes, demographic and environmental variables are being studied. It is extremely difficult to explicitly incorporate social and political factors and processes; in a rudimentary way this might be achieved by distinguishing different types or classes of social and political systems. One explicit goal included though, is an improved global income distribution. A dynamic model is being built, using methods and techniques as developed in mathematical economics and econometrics. The aim is to build firstly a descriptive, analytical model that will be used to analyze those problems which may arise as a consequence of population doubling if past behaviour and government policies were to remain unchanged.

Secondly, the model will be used as a policy or planning model - i.e. the descriptive or analytical model used "backwards" - in order to determine those policy measures which would be required if the basic package of material goods is to be available to everyone. Also the implications of additional targets - such as a high level of employment - may be studied.

Due to our conviction that problems connected with food supply are still pre-eminant, and agriculture basic to other economic growth, efforts in our limited time are for the present almost entirely focussing on the agricultural and food problems.

Underlying structure of the agricultural models

The common denominator of all agricultural production is the process of photosynthesis; this process is at the heart of the technical equation describing output per hectare as a function of inputs of plant nutrient (including water). Another technical relation shows how much labour and/or capital can effectively be used. Still another set of relationships describes the behaviour of the farmers or peasants. Technological progress in agriculture plays a role as well. Three models with basically different structure in the behaviour and economic aspects are being developed; for the developed market economics, the centrally-planned economies and the less developed economies. Where possible, data relating to the national level is being used.

Links to rest of economy; adequate supply factors

Obviously the agricultural sector does not function in isolation of the rest of the economy. There is an important link with several economic activities producing inputs for agriculture. First of all, inputs of fertilizer will usually be needed to reach higher levels of input. Mechanical equipment may be required to work together with labour, or partly to replace it. Transportation is required for bringing part of the output to the consumer, and for bringing fertilizer and other inputs to the farm. The production of fertilizer, the operation of machinery, transportation, sometimes even storage - all these activities cannot be performed without an input of energy. Availability of all these (direct or indirect) inputs into the agricultural sector have to be ensured and the consequences of scarcities or price changes in these ascertained (e.g. energy, capital for fertilizer production). Sub-models are therefore being built to reflect, especially the influence of fertilizer production, energy and transportation in the agricultural sector.

For the purposes of our study, restricted as it is to the coming forty years, population growth remains effectively an exogenous variable. Similarly we do not generate non-agricultural income within the model but rely on a certain set of judgements about its future growth. However, labour outflow from agriculture is generated within the model.

Water and pollution

Still other interrelations are being studied. An input of crucial importance is water - primarily produced by nature. Distribution of rainfall is rather uneven however, and local surplusses may be badly needed elsewhere (or at another time of the year) for irrigation. In large parts of Asia and Africa, agriculture could hardly be developed without irrigation water. On the other hand, not all the water falling or flowing on a piece of land is used up during the growing season. Water leaving the agricultural production process may carry with it part of the chemicals that have been brought onto the land. These agricultural residuals enter other parts of the biosphere; what are the effects? Toxic substances used in modern agriculture may also be transported through the air. Therefore, the pollution aspects of agriculture are where possible being incorporated. In a broader context the question arises: what ecological disturbances might be created by extending more and more the area under cultivation, with the consequent loss of variety in vegetation?

Demand limitations

It is not only a question of adequate production and supply potential, but the demand side has to be taken into account as well. Without sufficient demand for food, farmers will not produce (except for their own needs). Demand can effectively increase only if the (non-agrarian) population has enough buying power, and this in turn depends on productive employment at reasonable wages. Agricultural production (in particular food crops) in developing countries cannot gain momentum, while effective demand remains stagnant. But at the same time it should be remembered that an increase in effective demand does not necessarily stimulate the small farmer to produce more; this depends on the agricultural institutions that may or may not be conducive to a positive response by the farmer (type of land ownership, credit facilities, middlemen, etc.).

Trade and investment

Finally, our analyses of the agricultural sectors in the various parts of the world will take into account that countries and regions are not isolated units but are mutually linked through international trade and investment. With only few exceptions, all countries aim at a rather high degree of self-sufficiency in food production; nevertheless international trade in foodstuffs and other agricultural commodities is of great importance. Differences between countries in socio-political system (market economics vs. centrally-planned economies) and in development level (rich vs. poor countries) influence the way in which countries are linked to the world market.

Other sources of food

Agriculture is by far the most important source of food products for human consumption, either directly (vegetable products) or indirectly (animal products). Indirect consumption of plant material, i.e. through the intermediary of domesticized animals, is relatively inefficient in terms of the caloric value lost in the conversion process. A change in the ratio between direct and indirect consumption of vegetable products would change ultimate availability of food in terms of caloric value, and might therefore play a role in a world food policy. In addition to agriculture, the contribution of fishery to human food requirements should be taken into account. It will not be easy to assess the possibilities of non-conventional food production; expert opinion differs rather widely on this point.

John Garbutt
May 20, 1974

CONFLICT DYNAMICS IN THE CONTEXT OF GLOBAL MODELLING

P.K. M'Pherson (Professor of Systems Science, The City University, London)

1. Introduction

Some two years ago when the "Limits to Growth" study was made public and its many imperfections became apparent a group in the Department of Systems Science* formed to consider what contribution it might make to render the embryonic art of global modelling more realistic and less open to criticism. We were a group of dynamicists and political scientists** who, being busy faculty members, had little time to spare for an additional research project but we were also reasonably sure that global modelling was a legitimate enterprise in the Futures field and that it deserved serious attention. It seemed to us that the exercise of global modelling would (1) yield additional understanding of the various mechanisms that govern the interactions between regions, resources, economics etc., and (2) provide a promising test-bed for the evaluation of long-term policies and strategies. But it also seemed to us that the best climate for global modelling at present would be provided by a considerably reduced concern about what ought to be done about world issues balanced by a considerably greater attention to the development of global modelling as a valid technique for the study of such issues. Finally it seemed that the philosophical and scientific problems underlying both the exercise and technique of global modelling were of such an order that there was no question of letting a band of inexperienced Ph.D. students loose to research on the problems until those problems had been identified and ordered by maturer study.

So this group had neither the inclination nor the effort to produce yet another world model. But there was one thing that we could do: we could discover if it might be possible to bring real, behaving squabbling people into such

* The City University, St. John Street, LONDON, EC1V 4PB, U.K.

** Visiting Professor Maxwell Noton, F.J. Charlwood, F. Edmead, F.R. Janes, C.R. Mitchell, and the author.

models. The political scientists in the group are specialists in international relations and conflict research; this meant that our combined skills would allow us to bring some competence to the problems of constructing a mathematical model of conflict behaviour. So some two years ago we launched a very part-time project to explore the problems of representing conflict dynamics in the context of global modelling. In doing this we would be contributing both to political science and to the development of world modelling methodology.

Our progress has been slow: the part-time nature of the group has been noted already, but we have also proceeded at a rate which the discipline of political science can just bear. It would have been only too easy for the dynamicists themselves to have concocted an apparently plausible model of conflict within a week or two after some conversations with the political scientists. But that is not our method: our model was to be developed within the theoretical framework of political science as well as within the much more highly developed theoretical framework of control theory and model dynamics. Accordingly we spent many months searching for and arguing about appropriate theoretical structures for a conflict model and then trying to define behavioural indicators that would be both useful in a mathematical model and acceptable to at least some mainstream political scientists. Our political scientists provided the vital link between the orthodox study of political phenomena and the dynamicists who were all too anxious to bring their high level mathematical language to bear on the problem, (and often astonished that any discipline calling itself a science could be so spare of recognisable theory). Hence our progress has been slow because we refused to break the links between what we were doing in mathematicising conflict analysis and the parent field of political science. Our model is trivial by the standards of the systems engineer or operations researcher, but it is light-years ahead of what the more orthodox political scientist can tolerate. I labour this point because it seems to me that many of the woes that have descended on world-modelling are due to the impatience of some of the teams so engaged and their breaking of the links between their modelling exercises and the appropriate parent disciplines. We console ourselves in our slow progress with Aesop's fable of the tortoise and the hare.

Aims and Objectives of the "City" Conflict Dynamics Model

Aims: i) To investigate the application of mathematical modelling and control theory in socio-political systems, particularly in conflict resolution.

- ii) To gain insight into the structure and behavioural dynamics of complex socio-political systems under stress and deprivation.
- iii) To offer a method for adding models of human behaviour to the existing range of world models, (at present their "Population Model" treats people only as consumers, copulators and corpses).

- Objectives:
- i) To discover what socio-political data and indicators are required for the adequate mathematical representation of conflict behaviour.
 - ii) To construct a conflict model that will be compatible with the dynamics or causal layer of the current range of world models.
 - iii) To estimate a hostility indicator which would "measure" the increase of hostile attitudes between or within populations as a function of world model variables.
 - iv) To use this indicator to suggest conflict thresholds in world models. (Any slight acquaintance with the human animal leads one to suppose that he will be fighting his neighbour hard long before the onset of the final calamities "predicted" by some world models. Thus it is important for world models to trace human hostility as well as such quantities as resource scarcity, quality of life, etc.)

3. Problems encountered

The main problems encountered so far have been:-

- i) Conceptualisation: the social and political sciences are full of fuzzy concepts like political power, social stability, social integration, discontent etc. These need to have very clear operational definitions if they are to provide key variables in a mathematical model.
- ii) Theory: again there is a noticeable absence of rigorous theories of process and structure in the social and political sciences. Such as do exist are in verbal form, (and often very diffuse): these must be translated into mathematical equations in such a way that the underlying meaning and implications are retained.
- iii) Data: a) the difficulty of finding indicators which relate to the variables commonly used in the social and political sciences,

e.g.: (number of cars or number of doctors/person) → Modernisation,
(rates of suicide, alcoholism, emigration) → Discontent.

(b) the paucity of data relating to political and conflict theories
(There is nothing like a "Cobb-Douglas 'Hostility' Function"
carefully researched and compiled over the years!).

4. Structure of the model

There was no need, and even less justification to construct an overelaborate model so we contented ourselves with the concept of two distinct ethnic populations within one economic boundary - the conflict between the populations being engendered by the deprivation (actual and perceived) of one population relative to the other, (Fig. 1). Such a model, simple though it is, is typical of many conflict situations in the world today, e.g. Canada, Cyprus, Pakistan, South Africa, Ulster. (Good manners prevents us from suggesting that other empires, whether Imperialist or Socialist, might also have left behind, or be causing, similar conflicts!.) Such intranational conflict has the attraction that the data for only one distinct region need be researched: clearly amplification to represent economic hostility between, say, the developed and underdeveloped worlds is a matter mainly of aggregation, (not forgetting that, at this level, differences of cultures, needs and colour may have a more significant effect). To give focus to the construction of the model the team concentrated on the South African situation.

The basis of our model is taken from the work of Gurr, Rummel, Johnson, Tanter and Davies (1), particularly Gurr and Davies who suggest that discontent within a political community is one of the main causes of violent behaviour. A conceptual model of the manner in which discontent is converted into more or less violent behaviour proceeds as follows, (Fig. 2): a sense of Relative Deprivation (RD) is produced in a black-box which receives a set of unspecified inputs. The sense of Relative Deprivation is processed in another black-box amplifying or diminishing the sense to produce a feeling of Discontent (D): influencing variables would be such factors as the perceived legitimacy of the deprivation or the injustice of always being (apparently) the underdog. The feeling of Discontent is further modified in another black-box to provide a behavioural response output: Conflict Response (CR) which maps into a scale ranging from Resignation through Non-violent protest to Violent Conflict. Influencing variables on this last black-box are such factors as anticipated

punishment if caught, official opportunities for institutional protest. The black-boxes are, of course, the behavioural mechanisms of the individual person.

After considerable deliberation the group settled on seven socio-political variables to represent bipolar conflict within a regional population whereby the discontent in one segment of the population (B) arising from its sense of relative deprivation is transformed into hostility towards the other population segment (A) which appears to be impeding B's aspirations and expectations. The variables we selected were:-

- | | |
|--------------------------|---------------------------|
| 1) Community size: P | 2) Political Power PP |
| 3) Internal cohesion CHS | 4) Discontent DSC |
| 5) Hostility HOS | 6) Conflict Behaviour CFL |
| 7) External support ESP. | |

Suffices A, B denote the two groups within the community. A is assumed to be an initially dominant group while B is an increasingly restive group of low social and economic status. The model has been extensively reported elsewhere (2,3) and no detail will be presented here. Figure 3 summarizes the structure of the socio-political section for population A: the model for population B is similar. The underlying economic model is quite standard: as can be seen economic variables are reflected strongly in the socio-political sector but only the conflict behaviours of the two populations are used to interact with the economic model, (a rise in CFL_A and CFL_B reduces the rate of capital investment and hence causes a drop in production.)

The argument of the model follows the basic Gurr/Davies concept in that a feeling of discontent is externalized as hostility towards the other population (scapegoating) which causes, in turn, conflict behaviour to a greater or lesser degree, (thick lines in Fig. 3). This basic behavioural pattern is modified by each group's sense of cohesion and political power, (both of which are deemed to be self-reinforcing, hence the positive self-loops round CHS and PP). The variable representing aid and succour from the outside world, ESP, is thought to encourage a population towards self-realisation, but the support will be reduced if the level of conflict behaviour rises. The actual inter-dependency of the variables can be deduced from a detailed scrutiny of Fig. 3.

It will be seen that this model treats conflict largely as a matter of economic status and well-being. This is a gross simplification, but it ties in with the materialist bias of current world models and it is a not too inaccurate representation of the jealousies that presently afflict us.

5. Quantification of the model

Considerable thought has been given to the problem of defining the indicators for the socio-political variables in the model and a large number have been listed which are probably countable. For example some of the indicators listed for Cohesion are: geographical concentration, exclusiveness of organisations, (social, political and trade unions), level of intermarriage, separateness of education and religion, low level of social contact, distinct employment patterns, strong self-image. Such indicators come quite readily to mind but their relevance as proper measures for the variable in question must be demonstrated by careful analysis and correlation of the available data. Further many of the indicators either in the literature or suggested by the team are clearly not independent: for example a high voting turn-out for community-based parties is thought to be one good indicator for political power, but it is surely also a measure of cohesiveness as well; on the other hand voting absenteeism is often taken as a measure of discontent. Clearly an enormous amount of careful painstaking research is required before a set of valid, independent and inclusive indicators can be established. This work lies in the future and is one of the major issues that confronts political science.

To gain some experience with the use of such models the team indulged in a pseudo-quantification exercise to provide "reasonable and representative" numerical values for the coefficients and time constants in the model. The numbers were obtained via the Delphi method (a grand name for "guess"!) and after a few iterations a coherent set emerged which the team agreed represented their collective understanding of the generalities of economic apartheid. The insertion of the numbers allowed useful work to be done in eliminating some clearly unreasonable unstable economic behaviour, and subsequent runs indicated that the model responded in an interesting if limited way to changes in such basic parameters as rate of change of GNP and population. It will be understood why the team is unwilling to publish these response curves: the model is fiction in that the "data" was invented and the runs were made only to establish that the model was useable ... and of course we were curious to see what the responses indicated!

6. Further work

The immediate development is at a standstill due to the complete lack of data and validated socio-political indicators. To overcome this barrier is a major exercise and we are seeking support to finance full-time researchers to create the necessary data-base and establish the appropriate indicators. We now know what to look for. In the meantime we intend to repeat the work we have done, but this time for international conflict as the data at this macrolevel has been subject to more research. We will also look at alternative approaches such as simulation and gaming. We have examined already the use of fuzzy linguistic variables rather than fuzzy numbers, but our initial enthusiasm for Zadeh's ideas are beginning to wane. One interesting exercise has been undertaken using fuzzy sets to represent uncertainty in such models, but at present we cannot see that the use of linguistic variables offers any significant practical advantage in our kind of simulation: it's a lovely theory but is there any real increase in computing efficiency or realism?

7. Conclusions

At first sight our effort over the last two years or so might appear to be discouraging: we have made no breakthroughs, and we are only too aware of the magnitude of the task that lies ahead before validated and quantified mathematical models can be used as a matter of course in the analysis and prediction of socio-political behaviour. However our work has shown that

- i) it is possible to convert the verbal theories of political science (as referred to conflict) into mathematical form in a manner that is acceptable to political scientists.
- ii) such models promise to be representative of community behaviour and can therefore be used to acquire insight, to obtain better explanations, and - perhaps - to make predictions.
- iii) such models could be used to provide appropriate conflict indicators in world-models.
- iv) there is nothing in principle to prevent the modelling of many other aspects of socio-political behaviour.
- v) the undertaking of such an exercise identifies with considerable precision the areas of research required within political science to provide a formal basis for the model approach.

REFERENCES

1. T.R. Gurr, Why Men Rebel (Princeton University Press, 1969); R.J. Rummel, The Dimensions of Nations (London, Sage Publications, 1972); C. Johnson, Revolutionary Change (Boston, Little, Brown & Co., 1967); R. Tanter, "A Theory of Revolution", J. of Conflict Resolution, Vol. 11, 1967, pp 264; J.C. Davies, "Towards a Theory of Revolution", American Sociological Review, Vol. VI, No. 1, pp 5.
2. M. Noton, F.J. Charlwood, F. Edmead, F.R. Janes, P.K. M'Pherson, C.R. Mitchell, "A dynamical model of conflict", IFAC/UNESCO Workshop on Environmental Systems, Zakopane (Poland), Sept. 1973.
3. M. Noton, C.R. Mitchell, F.R. Janes, "The Systems Analysis of Conflict", Futures, April 1974, pp 114-131.

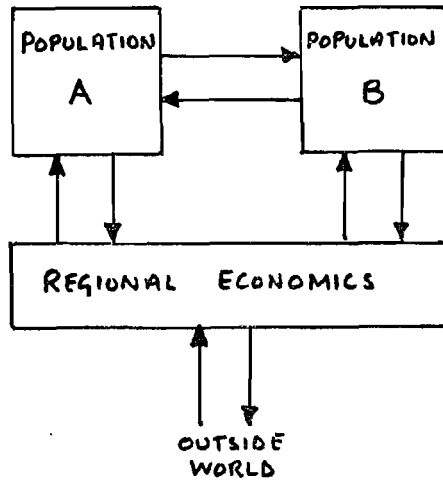

FIG 1 : BASIC STRUCTURE OF MODEL

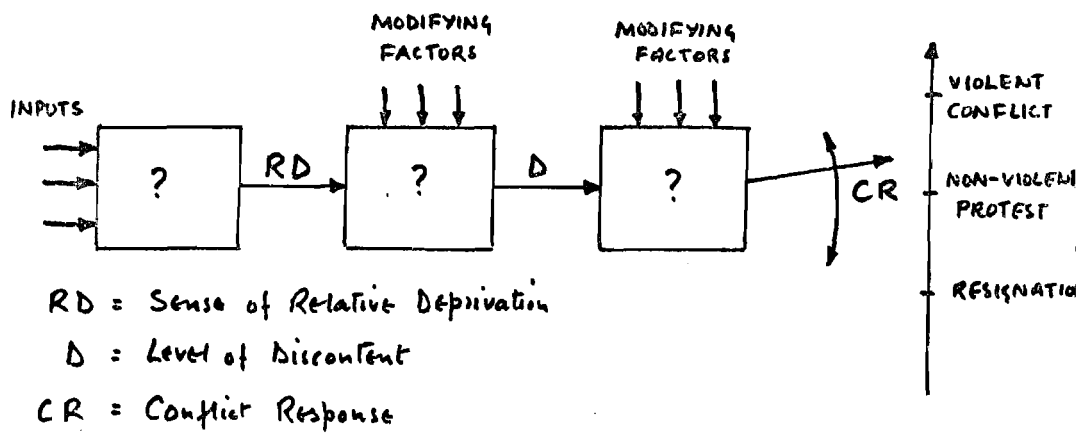
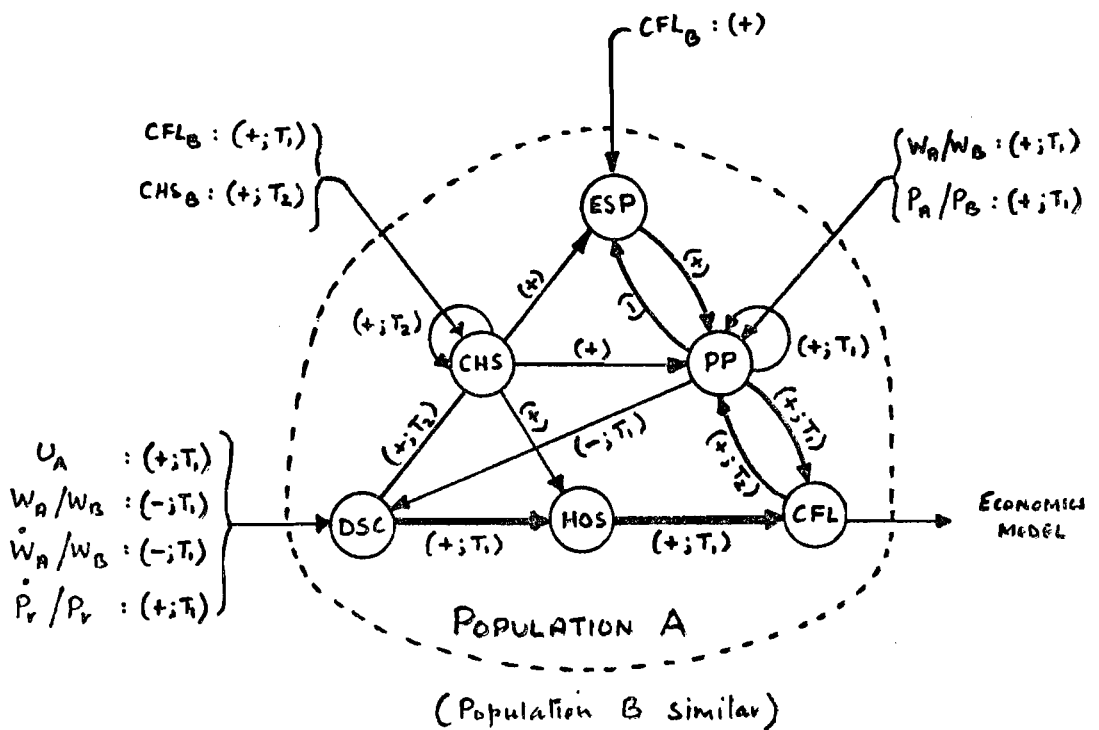

FIG 2 : BASIC CONFLICT BEHAVIOUR PROCESS



NOTATION

ESP : External Support
 CHS : Cohesion
 PP : Political Power
 DSC : Discontent
 HOS : Hostility Towards ...
 CFL : Conflict Behaviour

Variables in Economic Model
 that feed Conflict Model

U : Unemployment
 W : Wages
 P : Prices
 P : Population

$P \xrightarrow{(+)} q$: influence of p on q is positive and immediate.

$P \xrightarrow{(-; T)} q$: influence of p on q is negative and acts with a time lag T.

T_1 = short time lag.

T_2 = long time lag.

FIG 3: STRUCTURE OF CONFLICT MODEL

THE GENERAL PRODUCTION FUNCTION

as a contribution to global modelling

H. MILLENDORFER

C. GASPARI

STUDIA (Study Group for International Analyses)

A-1090 Vienna, Türkenstrasse 3 / III

AUSTRIA

Paper prepared for IIASA-Symposium on Global Modelling,
April 29 to May 2, 1974

I. A NEW TYPE OF PRODUCTION FUNCTION

1. CONCEPT

The development of the General Production Function is based on a certain understanding of the functioning of societal systems in general. Therefore, we think it will be useful to start with some remarks on the underlying concept. At first, it should be noted that society can be thought of as a complex, multihierarchical system. This system is characterized by the interaction of a great number of subsystems, and it is this interaction which enables the overall system to function. Economy is one of these subsystems. Therefore, if we want to understand how this subsystem works, we must go beyond the economic sphere proper and consider also the interrelations with other subsystems.

Society has another characteristic feature in common with other systems, namely its ability of processing energy and information. The economic output of a social system is therefore governed by its capacity to cope with these two fundamental processes. Arguing in such a way we are applying a concept which clearly shows the influence of K. W. Deutsch (9), who understands society as a self-developing cybernetic system: Superimposed on a control system, in which the material processes take place, there is a system of information receptors, information channels, information storing units and logical units. This network receives information on the actual situation, on environmental changes and on the internal structure of the system. It then processes this information using additional information stored in the past. This process gives

rise to new information which regulates the measures to be taken, that is to say the commands given to the control mechanism.

The energy processing capacity of a system as well as its capability of mastering information are not sufficient to determine a system's economic output. A third component is needed to describe adequately the complex processes just mentioned. On the one hand, this third factor reflects the objectives toward which the efforts of this system are directed. On the other hand, however, the way the system is organized, i. e. the regulation and coordination of the energy and, in particular, the information processing operations, also ought to play a certain role. These two components are the chief determinants of the third factor, i. e. structure. This factor, thus describes the objectives of the system and the organisation of its energy and data processing subsystems, that corresponds to these goals.

This model, of which only a short outline has been given here, has served as a basis for the investigation of the societal subsystem economy. The chapters which follow will show how a country's economic performance can be described as a function of its energy and data processing capacity and of its structure.

2. THE FACTORS INFLUENCING ECONOMIC DEVELOPMENT

Applying the concept described above to the study of economic development we are led to formulate the following hypothesis:

$$y = F (m, b, p, r)$$

per capita income (y) = economic output
energy consumption (m) = energy processing capacity
(capital)
education (b) = data processing capacity
structure (p) = values, type of organisation, types of behavior
and mineral resources (r)

The use of some of the above mentioned production factors is more or less common practice.

2.1 Capital

The factor capital - which, as will be shown below, shows a close correlation with energy consumption - constitutes a common component of almost any economic production function. The relationship between capital input and economic performance has been dealt with in a great number of previous studies, and we find also attempts to measure this relation on the basis of international comparisons. A study by Galenson and Pyatt (15) is such an attempt to test the assumptions underlying the theory of growth by means of an international comparison. Thereby it has become apparent that *too simple assumptions are not suited to explain the international differences in economic growth.*

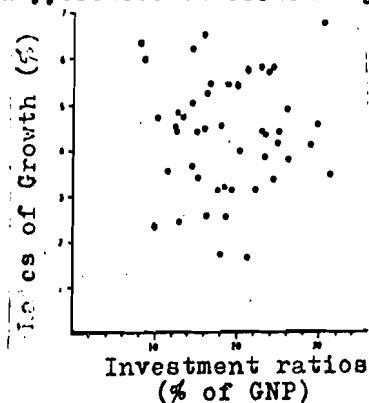

Fig. 1: Investments and growth rates in the countries of the world

Obviously this study has run into difficulties. The authors are confronted with problems which are very similar to those encountered in many other studies, relying on international comparison as a means of testing their hypotheses. For the most part these studies have not succeeded in taking account of the great number of geographical, cultural, climatic and political differences among the individual countries of their sample. In other words, the observed differences in income (dependent variable) result from heterogeneous influences which cannot be adequately explained by differences in capital inputs. They must be explicitly controlled and entered separately into the study. Not taking care of these influences corresponds to a non-fulfilment of the ceteris-paribus-condition.

2.2 Structure

This gives rise to the demand for an efficient methodology which takes account of these various influences. One such method would undoubtedly consist of forming groups of countries within which the combined effect of these non-observed but relevant influences on each country is nearly constant.

An important clue for the formation of such groups of countries could be provided by observing the health development in the different countries of the world since the beginning of this century. The time series from all countries of the world for which figures are available have shown, that the development of health is fairly uniform within groups of countries, these groups being at the same time sensible geographical aggregates. The differences between

the groups are big enough to decide to which group a specific country actually belongs.

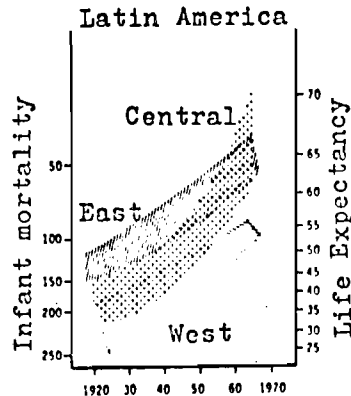

Fig. 2: Health development in South America.

There are three distinct zones, the La Plata States, the Central American States and the rest of South America (Andean States).

Without going into details of the problems encountered here, we may interpret this observation as follows: Health statistics provide one very fundamental indicator of the development of a society. Here we are measuring the "pulsation" rate of the societal system as it were. It is governed by many factors which cannot adequately be measured directly. We may consider the adoption of medical innovations as one part of a more general social process, which is the adoption of innovations in general and which we call "learning process" - this hypothesis will be supported below by international comparisons of the relationship between education and economic performance. Thus, the regions differ as to their readiness and capability of adopting innovations. This general statement is based on the observations made in one subsystem of the society, namely the health system. For it is the greater or smaller readiness to adopt medical innovations that is responsible for a more rapid or slower improvement of health conditions.

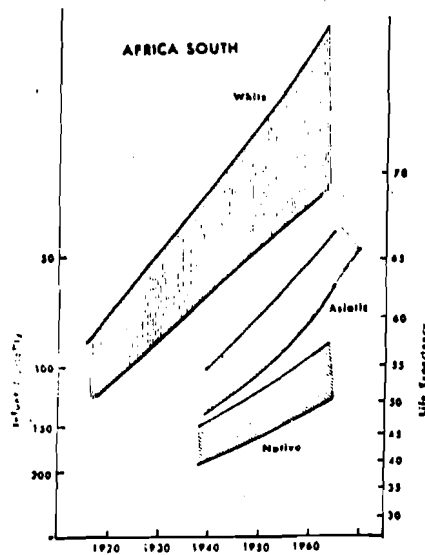

Fig. 3: Health development of the African, Asian and European population groups in South Africa

The diagram refers to the situation of countries whose population comes from three different civilisations.

The differences in health development in the various groups of the population are striking. The development in each of the groups resembles that of the corresponding region from which the groups originated. This leads to the interpretation, that the "structure", i. e. the value system, the patterns of behaviour and the types of organisation constitute an important factor responsible for the differences observed with regard to the development of health.

The European countries can also be classified into zones according to their different health development.

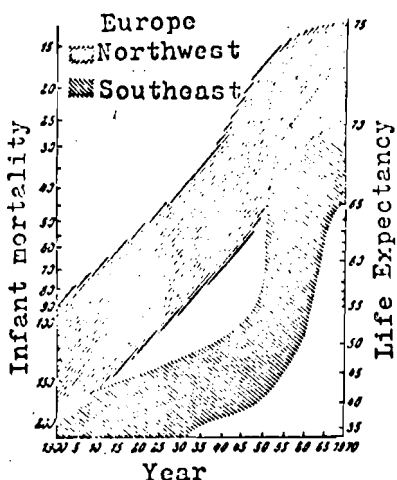

Fig. 4: Health development in Europe

There are three zones, Northwestern Europe, Southern Europe and Eastern Europe. Southern Europe and Eastern Europe show much the same development.

Applying the classification in groups of countries as presented in Fig. 4 to the data of Fig. 1 in order to separate the two groups of European countries we arrive at a meaningful relationship:

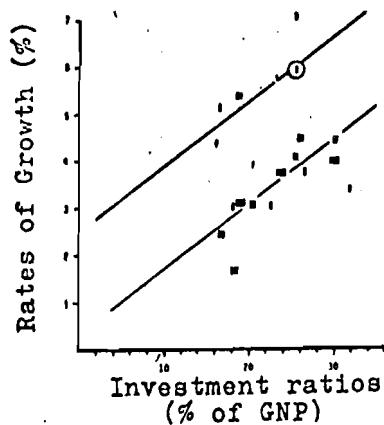

Fig. 5: Investments and growth rates in two groups of European countries

The observations in this diagram are data taken from Fig. 1. They show, that meaningful relationships exist within groups of similar countries.

The regression lines showing economic growth per unit of investment lie on different levels in countries with different political and cultural systems. This observation suggests, *that the differences of the political and cultural structure affect the effectiveness with which capital is used*, thus the energy processing capacity. In addition to this factual finding, the evidence presented gives rise to the methodological remark, that reliable results in international comparisons can only be obtained if due account is taken of the *ceteris-paribus-condition*.

2.3 Education

The majority of the studies made so far have considered man as an element of an undifferentiated factor "Labor" and have used just the number of people in the working force as one of the input factors. Various abilities, differences in the level of education (which correspond to differences in information processing capacity) have so far been neglected or have not been examined in relation to the other factors. But if we take a look at Fig. 6 we find, that it is obviously *a country's level of education* which happens to be *very significantly correlated with its economic performance* and that, therefore, this factor has to be included in a production function.

+ A relationship similar to that presented in Fig. 5 has been pointed out by Krelle (25) to confirm the close fit between capital investment and economic growth as formulated by the theory of growth. This study used essentially data from industrial countries. This, however, corresponds without being spelled out explicitly to the classification of countries according to the criterium of similar structure.

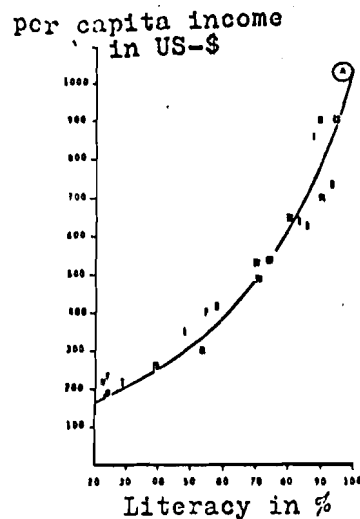

Fig. 6: Per capita income and literacy rates in groups of countries with similar structure

The diagram shows the close fit to the exponential relation between the economic output and level of education.

Closer examination of the relationship between education and income in a cross-section of countries reveals that the aggregation of countries according to the criterion of similar health development is also a good criterion for this purpose. The regression coefficient of the education is practically the same in all the regions.⁺ The intercepts of the regression lines however differ from one zone to the other. Significant differences however do occur only between five large zones of the world.

The evidence presented thus far can be summarized as follows: There is sufficient empirical support for concluding that a country's *economic performance is mainly determined by three factors, namely capital (energy), education (information) and structure.*

⁺ Regions are defined by the criterion of equal health development.

2.4 Natural resources

Examination of the output differences among the countries of the world reveals, that, apart from the factors discussed so far, the occurrence of *mineral resources* is an additional relevant factor.

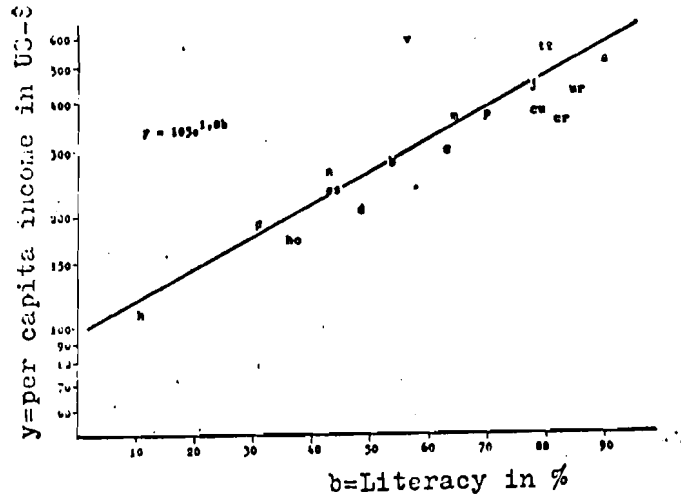

Fig. 7: The special position of Venezuela, Trinidad and Tobago in the comparison of per capita income and literacy in South America

Venezuela's large deviation from the regression line is very striking and can be explained, even quantitatively, by this country's important oil production.

The important influence of mineral resources on the level of economic output is supported by observations in other regions, in particular in the countries of the Near East and in Africa.

2.5 Combining the factors

If we now combine all the individual factors mentioned separately so far we end up by getting a functional relation-

ship which explains the international differences in economic performance very well. *The combination of capital, education, structure and natural resources has a much higher explanatory power than the simple regression on a single factor.* This is demonstrated graphically in Fig. 8.

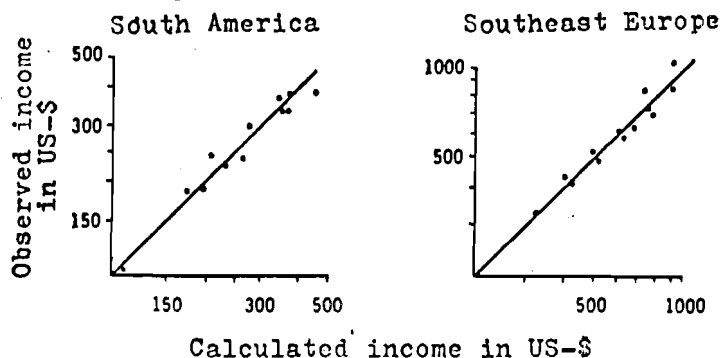

Fig. 8: Comparison of observed per capita income and its estimated as calculated value when account is being taken of all the factors

All factors combined yield a much higher explanatory power. Discrepancies between observed and calculated values are insignificant.

The individual factors are combined by means of the so-called General Production Function, which will be described mathematically in the paragraph which follows.

3. MATHEMATICAL EXPRESSION OF THE "GENERAL PRODUCTION FUNCTION"

$$y = P_{t,z} \frac{1}{m^4} a^{\frac{3}{4}} e^b \left[\frac{1}{2} \left(\frac{m^{0,25}}{e^b} \right)^{-f} + \frac{1}{2} \left(\frac{e^b}{m^{0,25}} \right)^{-f} \right]^{-\frac{1}{5}} + 0,8 r \quad (1)$$

y ... per capita income, measured in US-dollars per inhabitant (annual)

$P_{t,z}$.. efficiency parameters

a ... employment ratio

m ... per capita capital input, measured by means of energy indicators

- b ... qualification of labor, measured by using educational indicators
- r ... natural resources index, measured by the value produced by mining operations, etc.

Expression in parenthesis: limitationality parameter. This describes the diminishing efficiency of additional input units of capital or educational effort when departing from the optimal relationship (see below).

The exponent of m and the coefficient of b have been estimated in a cross-section of countries by econometric means. While the parameters are not exactly 1/4 or 1, respectively, they do not depart statistically significantly from these values used for the sake of simplicity.

A closer look at this equation reveals an interesting relation between the General Production Function and the well known Cobb-Douglas Function which is of the type most frequently used in computing and estimating macro-economic production functions. It has been estimated for the first time for the United States and describes the relationship between both capital and labor inputs and income. *The Cobb-Douglas Function can be regarded as a special case of the General Production Function: if the two factors education and structure remain constant (social technology, organisation and management, values system etc. remaining static). In this static case the General Production Function becomes formally identical with the Cobb-Douglas Function.*

If we convert the per capita relationships of equation (1) to total values, while assuming no major departure from the optimal relationship (leaving out the expression for complementarity) and disregarding natural resources, we get

$$y = \frac{Y}{V} = P_{tz} \left(\frac{M}{V} \right)^{\frac{1}{4}} \left(\frac{A}{V} \right)^{\frac{3}{4}} e^b ; Y = \frac{P_{tz} e^b}{\text{constant}} M^{\frac{1}{4}} A^{\frac{3}{4}} \quad (1a)$$

capital letter total value
 v population

Thus the time-series of American production from 1899 to 1922 explained by Cobb and Douglas could equally well be explained by the General Production Function, assuming education and structure to have remained more or less constant over this period. As a matter of fact (as can be seen in Fig. 9) the education explosion in the USA started after 1922. Similar observations might be true about the structure which possibly began to crumble and become dynamic only with the onset of the Depression.

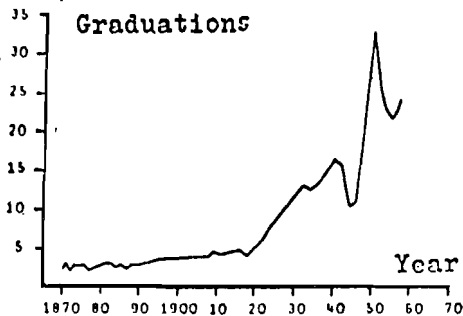

Fig. 9: Number of college graduates in the USA for the years 1870 - 1970

It is clearly evident from this diagram that the education explosion in the USA began only after 1920.

4. CONTRIBUTION OF INDIVIDUAL FACTORS TO THE PERFORMANCE OF THE ECONOMY

4.1 Education as a factor of production (qualification of labor)

When it came to the task of measuring the information processing capacity of the system - which is closely tied to the qualification of labor - figures pertaining to the educational structure were used. These figures were derived from en-

rolment data in three different levels. They represent the amount of primary, secondary and higher education in the respective countries.

Education appears to be a more reliable measure of qualification of labor than, say, length of employment - which could be taken as an indicator for learning-by-doing. This is so because the latter is not simply time-dependent, but is highly modified by the native intelligence, educational level, and willingness to learn of the person subjected to this process. If one, on the other hand, uses educational statistics as indicators, one arrives at a measure probably containing all the components just mentioned. Such educational data not only state mere length of training, but also - as a result of drop-outs and retardation - the components "adaptability" and "willingness to learn".

Summarizing the empirical evidence concerning the relation between education and the other factors of the General Production Function we may state: first we find an *exponential relationship between the qualification of labor (i. e. education) and economic performance*; then we observe that there exists a certain amount of *complementarity between qualification and capital*; and finally we see that a similar relationship holds for the subfactors of education, i. e. *primary, secondary and higher education are substitutable only in a very narrow range*.

4.1.1 Exponential relationship of education and income

As opposed to those concepts which understand the contribution of education to income as the rates of return to human capital (i. e. capital accumulated in the process of education),

the empirical evidence presented supports very strongly the existence of an exponential relationship between the two variables. This is to say, that *a linear increase in education produces an exponential increase in the economic output*. If we interpret, moreover, education as an indicator for the information processing capacity of the system, we see that this exponential relationship can be deduced from the basic concepts of information theory.

4.1.2 Time-lag between education and its economic effect

Another important aspect to be dealt with when scrutinizing the relationship between education and economic output is the fact, that *a time lag of ten to fifteen years exists* between an "injection" in one of the categories of education and its eventual effect on the economy. It is this time lag which makes a trial-and-error control of the educational system via the labor market so extremely difficult and which makes this type of empirical market feed-back so prone to oscillations.

4.1.3 Complementarity of factors

The factors education and capital do not occur in random combination, but we observe only a limited degree of substitutability between these factors. This implies, that *the information processing capacity is tightly connected to the energy processing capacity*. An expansion in one sector only produces a deviation from the optimum relationship. Such a deviation is characterized by a suboptimal use of the factor which is in surplus.

Empirically, we have arrived at the following optimal relationship:

$$m^{1/4} = e b \quad (2)$$

A departure of either education or capital from this optimal relationship results in *the relatively smaller of the two inputs becoming a bottleneck for the economic performance of the system*. In such a case, increasing the proportionately larger input will not yield a significant increase in production.

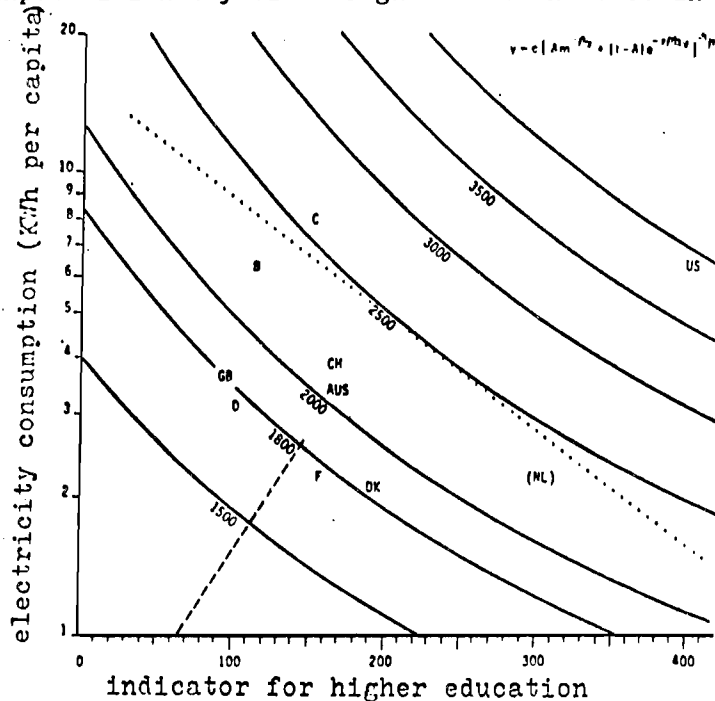

Fig. 10: Limited substitutability of education and capital. The curvature of the isoquant describes the limitation of substitutability of the two factors. Unlimited substitutability would correspond approximately to the dotted tangent of curve 2500. The interrupted line represents optimal relation.

4.1.4 Complementarity of subfactors

The concept of limited complementarity can be meaningfully applied also to the various categories of education. It turned out that the numerical relation between the various educational categories differed from one group of countries to the other. Furthermore, *there exists an optimal relationship, in the case of which the economic effect of education*

(as a whole) *is maximized*. If one of the educational categories is less developed, than this optimal relationship demands, that level becomes a bottleneck of education. Such a bottleneck exists e. g. in the Arabic countries in the field of primary education, while with the Latin-American nations the shortage is in secondary education. The latter applies to the countries of Southern and Eastern Europe, too. Great Britain and her former colonies show such a bottleneck when it comes to higher education. Investing in t h a t category of education which represents a bottleneck yields the highest returns. An identical investment in a "surplus category" produces much smaller gains.

4.2 Capital as a factor of production

In order to estimate the General Production Function the energy processing capacity is measured on the basis of data for the total energy consumption of a country as well as by using the figures for electric power consumption. In using these measures it became apparent, that for countries, for which capital stock time series exist, these time series have a remarkably high degree of correlation with an indicator reflecting the changes in total energy consumption and in the use of electric power. This can be expressed in the following relationship:

$$k = m_1^{0,5} \cdot m_2^{0,25} \quad (3)$$

k = capital per capita

m₁ = energy consumption per capita

m₂ = consumption of electricity per capita

The fact that energy consumption turns out to be such a useful capital indicator has its deep-lying causes. Intro-

duction of "artificial" energy into the production process was the characteristic feature of the First Industrial Revolution. If one wanted to put a point on it, one might even go as far as saying that capital stock were an indicator for the utilization of "artificial" energy in the production process. In any case, however, "artificial" energy turned out to be the prerequisite of mechanisation. This - at least in part - explains the close relationship between energy utilization and capital.

The contribution capital makes to the economic output remains more or less the same, regardless of whether we use the General Production Function or the Cobb-Douglas Function in its computation. Furthermore, in the General Production Function it corresponds at least approximately to the contribution of capital to output arrived at by using the Marginal Productivity Theory and assuming perfect competition, when viewing capital's empirically observed returns.

Another such observation relates to technological development in the production process. Looking at the world-wide development over time, the relation of electric power used to total energy consumption is changing, since the use of the former increases by a square ratio to the increase in total power needs. This relation of electric to total energy consumption is frequently used as a measure for the technological level of the stock of capital (machinery, etc.). Thus it is related to capital-induced technological progress. One study by P. B. Du Boff (10), amongst others, seems to support this interpretation. In dealing with the development of the United

States in the years from 1879 to 1962, Du Boff states: "... technological innovation frequently is difficult to represent quantitatively. Output per unit input does rise for non-technological reasons ... but there must be important cases where the reverse is true. One such case seems to be electrification of manufacturing industries. Here the rate of technical change can be reasonably well measured in terms of horse power capacity of power equipment and consumption of power. Furthermore, this 'revolution' in the application of power can be viewed against the background of clear, known changes in manufacturing productivity ...". And, after dealing with the various functions and uses of electric power in plant modernization, he states: "Electric power affected the whole scope of these processing services, by revolutionizing the application of energy to materials."

Summarizing we can say that *energy indicators can be used for measuring capital stock*. Doing this, we take, moreover, into account actual utilization of capital, which corresponds to what Solow calls "Employed Capital". It encompasses only that part of capital defined as "active" capital stock (viz. plant and machinery excluding buildings).

4.3. Structure as a factor influencing the production

4.3.1 Static features

Measured in a cross-section, the efficiency parameter $P_{z,t}$ of the General Production Function is the same for all countries belonging to one group at a given time. As previously stated, analyzing efforts in the field of health makes a division of countries in 14 distinct groups possible. Some of these groups have very similar efficiency parameters and thus can be aggregated into Greater Zones. The characteristic trait

common to all component states of each Greater Zone is a constant relationship between capital and education effort on one and economic performance on the other hand. *Countries within each zone are using capital and education with equal efficiency.*

In the mid-sixties, using these criteria, the world could be divided into five Greater Zones with differing efficiency parameters.

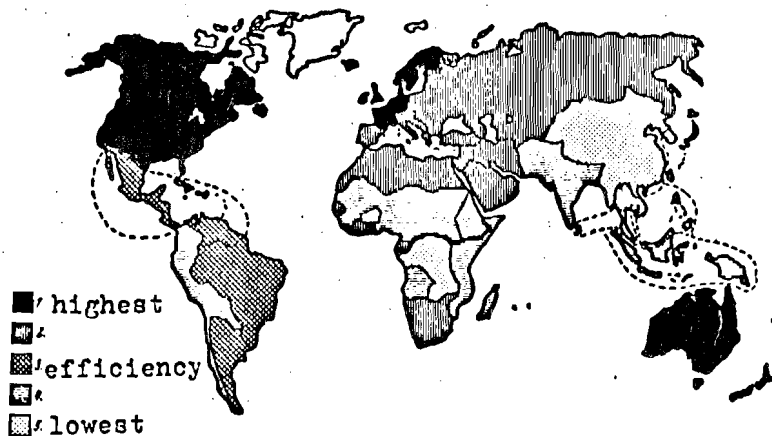

Fig. 11: A map of Greater Zones

It is interesting to note that Greater Zones with differing efficiency parameters - which were calculated using only the data for per capita income, education, capital and natural resources - strongly resemble the various groups of countries and areas of a map showing dominant religions. The zone of maximum efficiency consists almost exclusively of Protestant nations, the one ranking just below it of Catholic countries - including Greek Orthodox and formerly Christian countries of the Mediterranean region. This would seem to indicate that Max Weber's theories could be to some extent empirically verified (51). The results of McClelland's (31) research can be interpreted in a similar way.

The delineation of these Greater Zones of varying efficiency leads one to suspect that religion is of decisive importance

when it comes to economic development, i. e. that marked differences in efficiency are determined by cultural behavior patterns and their appropriate structure of social organisation.

4.3.2 Dynamic features

In a chronological analysis of world-wide development, or of the development of a specific group of countries, changes of the efficiency parameter over time become apparent. This - compared to the old residual factor of the Cobb-Douglas Function - *new residual factor of the General Production Function reflects world-wide increases in efficiency*. These increases result on one hand from the development of new technologies and their adaption to the production process and on the other from improvements in the organisation structure. The differences in the development of the efficiency parameter over time that exist between the separate groups of countries result from varying changes in the structure, i. e. the culturally determined behavior patterns and corresponding forms of social organisation.

4.3.3 Complementarity between production factors and structure

It is highly likely that the complementarity mentioned in 4.1.3 also exists between the production factors capital and education on one side and the structure of the system on the other. This means that *a quantitative increase in the factors capital and education must be matched by corresponding progressive changes in the structure of organisation* in order to enable the system to process and utilize effectively ever increasing quantities of data and energy. Changes in values and attitudes on one hand make changes in the structure of organisation possible, on the other hand they themselves

actively contribute to such changes. When structures have become rigid, and values are formally maintained, they soon become either hollowed out or changed from inside.

4.4 Natural resources as an input factor

Natural resources are taken into account according to an index based on the total value of mining and crude oil production. Using regression calculation, one finds that *approximately 80 % of the value of natural resources are added to the income determined by the other factors.*

5. SUMMARY OF THE RESULTS HITHERTO OBTAINED

The results thus far obtained by our method can be summarized as follows:

The effectiveness of the social sub-system economy can be described by the General Production Function, which shows certain characteristic traits. It describes economic output in terms of both material and non-material inputs, as well as of systemic structure. The input factors are related to each other according to limited substitutability (partial complementarity).

The concept of defining society as an energy and information processing system with varying structure has turned out to be extremely useful in international comparisons on country level, aimed at describing and explaining their varying economic performance. It is only natural that one should want to broaden this successful concept by adapting it to

other investigations. A particularly important aspect is, that the General Production Function is qualified for the whole world, considers the different regions using the econometrically estimated factor "structure" and connects economic and noneconomic factors.

From this point of view it seems to be useful to see it as a contribution to global modelling, especially to describe the supply-side of economies and their interdependence with other subsystems of society.

6. CONCLUDING REMARKS ON METHOD

An investigation about the application of the General Production Function to global modelling should also rely on the methods of research that have been successfully applied when estimating the General Production Function on the country level. The individual steps of our cross country study become apparent in Fig. 12.

Fig. 12: The General Production Function: Summary of methodology

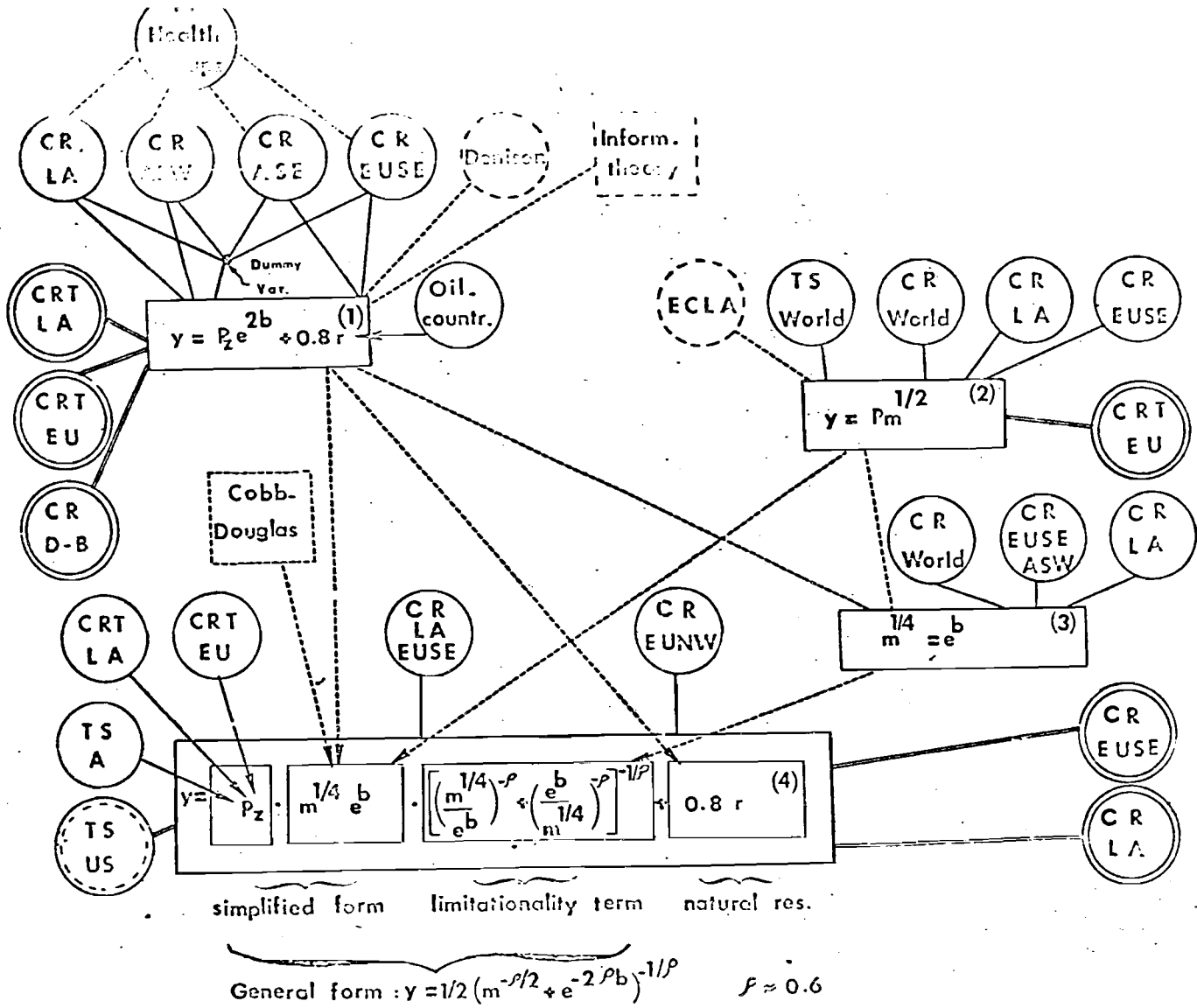

-----	<i>Hypothesis</i>
—————	<i>Initial testing of hypothesis</i>
—————	<i>Secondary testing of hypothesis</i>
○	<i>Empirical data base</i>
○	<i>Empirical data base from other sources</i>
□	<i>Theoretical source of hypothesis</i>
▭	<i>Results</i>
⊙	<i>Empirical data base for secondary testing</i>

ASE	Asia East	CR	Cross section
ASW	Asia West		
EU	Europe	TS	Time series
EUNW	Europe Northwest		
EUSE	Europe Southeast	ORT	Cross section combined with time series
LA	Latin America		
D - B	Districts of Brazil		
A	Austria		
US	United States		

It is important, however, to emphasize the step-by-step nature of our method. Its basic principle is the interaction between hypotheses arrived at in theory and the empirical testing of these hypotheses against reality, which in turn should lead to a modification, sophistication or correction of the hypothesis, which then again, in its revised form, must be put to the test of reality, etc.

This kind of procedure can become successful only if an extremely wide scope of data is available. In principle, one should attempt to check and test every assumed or found relationship empirically in a variety of ways. Thus, the goal has to be an over-defined system of information. This requires not only the mustering of sufficient empirical data, but also - and this is important - taking into consideration all previous studies which investigate more specific areas, as well as the results from consulting experts in various fields of specialisation.

It is consistent with our criterion of over-definition that such an investigation is to be based b o t h on cross-section comparisons as well as time series studies. Cross-section analysis compares different countries in one and the same branch of production, while the time series studies are to compare the situation of a specific branch of production over time.

Summing up, the method of investigation suggested requires collecting and compiling an absolute maximum of pertinent data on one hand, and a step-by-step process in developing the model on the other. The underlying assumption is that the model eventually arrived at will show marked similarity to the General Production Function we have found in our studies on the country level. In this sense the concept of General Production Function may serve as a framework to join the different approaches.

BIBLIOGRAPHY

- (1) ARROW, K. J., H. B. CHENERY, B. S. MINHAS & R. M. SOLOW: *Capital-Labor Substitution and Economic Efficiency, The Review of Economics and Statistics, Vol. XLIII, Nr. 3 (1961), pp. 225 - 250*
- (2) ATTINGER, E. O., & H. MILLENDORFER: *Performance Control of Biological and Societal Systems. Persp. Biol. Med., Vol. 12 (1968), pp. 103 - 123*
- (3) ATTINGER, E. O. (ed.): *Global Systems Dynamics, Basel - New York 1970*
- (4) BAIN, J. S.: *International Differences in Industrial Structure, New Haven - London 1966*
- (5) CHENERY, H. B., & L. TAYLOR: *Development Patterns: Among Countries and Over Time, The Review of Economics and Statistics, Vol. L, Nr. 4 (1968), pp. 391 - 416*
 ...NIELS, M. R.: *Differences in Efficiency Among Industries in Developing Countries, American Economic Review, Vol. 56, pp. 159 - 171*
- (7) DENISON, E. F.: *The Sources of Economic Growth in the United States and the Alternative Before Us, New York 1962*
- (8) DENISON, E. F.: *Why Growth Rates Differ, Washington D. C., 1967*
- (9) DEUTSCH, K. W.: *The Nerves of Government, London 1963*
- (10) DU BOFF, R. B.: *Electrification and Capital Productivity: A suggested Approach, The Review of Economics and Statistics, Vol. XLVIII (1966), pp. 426 - 431*
- (11) ECE: *Economic Survey on Europe 1971, Geneva 1972*
- (12) FELS, G.: *The Choice of Industry Mix in the Division of Labour between Developed and Developing Countries: Weltwirtschaftliches Archiv, Bd. 108, Heft 1 (1972), pp. 71 - 121*
- (13) FELS, G., K. W. SCHATZ & F. WOLTER: *Der Zusammenhang zwischen Produktionsstruktur und Entwicklungsniveau, Weltwirtschaftliches Archiv, Bd. 106 (1971), pp. 240 - 278*
- (14) FRANK, A. G.: *Industrial Capital Stocks and Energy Consumption, Economic Journal, Vol. 69 (1959), pp. 170 - 174*
- (15) GALENSON, W., & G. PYATT: *The Quality of Labour and Economic Development in Certain Countries, Geneva 1964*

- (16) GASPARI, C., & H. MILLENDORFER: *Prognosen für Österreich*, Wien 1973
- (17) GASPARI, C.: *The Structure of Education: An Empirical Approach*, *Konjunkturpolitik*, 19. Jahrgang, Heft 3 (1973), pp. 133 - 152
- (18) HAWTHORNE, E. P.: *The Transfer of Technology*, Paris 1971
- (19) HILDEBRAND, G. H., & Ta-Chung LIU: *Manufacturing Production Functions in the United States, 1957*, The New York State School of Industrial and Labor Relations, Ithaca, New York 1965
- (20) HILHORST, H.: *Production function in manufacturing industry*, *Stat. Studies No. 13*, The Netherlands Central Bureau of Statistics, 1962
- (21) HIRSCH, S.: *Location of Industry and International Competitiveness*, Oxford 1967
- (22) JÖRBERG, L.: *Growth and Fluctuations of Swedish Industry 1869 - 1912*, Stockholm - Göteborg - Uppsala
- (23) *Kommission der Europäischen Gemeinschaften: Vergleichende Analyse der sozialökonomischen Struktur der Bergbau- und Hüttenindustrieregionen der Gemeinschaft*, Luxembourg 1968
- (24) KOSTA, H., H. KRAMER & J. SLAMA: *Der technologische Fortschritt in Österreich und in der Tschechoslowakei*, Wien 1971
- (25) KRELLE, W.: *Investition und Wachstum*, *Jahrbücher für Nationalökonomie und Statistik*, Bd. 176 (1964), p. 21
- (26) KRENGEL, R.: *Anlagevermögen, Produktion und Beschäftigung der Industrie im Gebiet der BRD von 1924 bis 1956*, *DIW-Sonderhefte Nr. 42*, Berlin 1958
- (27) KUZNETS, S.: *Quantitative Aspects of the Economic Growth of Nations: II Industrial Distribution of National Product and Labor Force, Economic Development and Cultural Change*, 1957
- (28) LARY, H. B.: *Imports of Manufactures from Less Developed Countries*, London - New York 1968
- (29) LITTLE, I., T. SCITOVSKY & M. SCOTT: *Industry and Trade in Some Developing Countries, A Comparative Study*, London, New York and Toronto, 1970
- (30) MANSFIELD, E.: *The Economics of Technological Change*, Longmans 1968

- (31) McCLELLAND, D.: *The Achieving Society*, Princeton 1961
- (32) MERTENS, D.: *Die Wandlungen der industriellen Branchenstruktur in der BRD 1950 bis 1960*, Deutsches Institut für Wirtschaftsforschung, Sonderhefte Nr. 68 (1964), Berlin
- (33) MILLENDORFER, H.: *Systemtheoretische Aspekte der mittelfristigen Prognose*, Zeitschrift für Nationalökonomie, Bd. 29 (1969), pp. 371 - 384
- (34) MILLENDORFER, H.: *Input-Output Relations between Social Systems*, in: *Global Systems Dynamics*, E. O. Attinger (ed.), Basel - New York 1970
- (35) MILLENDORFER, H.: *Innere und äußere Grenzen des Wachstums, Wort und Wahrheit*, Bd. 5 (1973),
- (36) MILLENDORFER, H., & E. O. ATTINGER: *Global Systems Dynamics, Medical Care*, Vol. VI (1968), pp. 467 - 489
- (37) MILLENDORFER, H., & C. GASPARI: *Entwicklung als gesellschaftlicher Lernprozeß*, Wien 1970
- (38) MILLENDORFER, H., & C. GASPARI: *Immaterielle und materielle Faktoren der Entwicklung*, Zeitschrift für Nationalökonomie, Bd. 31 (1971), pp. 81 - 120
- (39) NIOCHE, J. P., & M. DIDIER: *Deux Etudes sur la Dimension des Entreprises Industrielles*, Les collections de l'INSEE, Paris 1969
- (40) OECD: *Productivity Measurement (Vol. III)*, Productivity Measurement Advisory Service, Paris 1966
- (41) PIETSCH, M.: *Von Wert und Würde menschlicher Arbeit*, Wien 1952
- (42) PHILIPS, L.: *Effects of Industrial Concentration: A cross-section Analysis for the Common Market*, Amsterdam - London 1971
- (43) PRYOR, F. L.: *The Size of Production Establishments in Manufacturing*, *The Economic Journal*, Vol. 82 (1971), pp. 547 - 566
- (44) RICHTA, R.: *Zivilisation am Scheideweg*, Prag 1968 (mimeographed)
- (45) ROSKAMP, K. W. & G. C. McMEEKIN: *Factor Proportions, Human Capital and Foreign Trade: The Case of West Germany Reconsidered*, *The Quarterly Journal of Economics*, Vol. LXXXII (1968), pp. 152 sqq.

Theses to Model-building and Possible Consequences

M. Peschel, GDR

1. General Considerations

1. With regard to real objects and their behaviour, models can play two different roles: They can give a formal description of the real relations between inputs y and outputs x or they can explain the properties of the objects, if they are constructed on the basis of profound theory with well-known physical laws.

2. Formal models are only an aggregation of information from the past. Therefore it can be dangerous to extrapolate their behaviour on inputs y , which were not used in the model-building process, or to forecast behaviour in the future. They can, however, already reflect laws in an implicit form without our explicit knowledge. They can be very important as a tool in the hands of experienced decision-makers, but their use demands cautiousness.

3. Theoretical models are reliable if the conditions of the corresponding laws are fulfilled. They allow for extrapolation into the future, and a view of the past. Yet for complex systems it is nearly impossible to get purely theoretical models.

4. It is most useful to combine, in the modelling of real objects, the formal and the theoretical approaches. In all

such cases we meet some parameters with unknown values. Fitting processes or parameter-adapting processes must be used to get acceptable values of the parameters.

II. The Description of Models Behaviour

1. For the success of the model-building process, the choice of the structure of the model or the class of possible models is very important.

2. Because real systems are always fuzzy systems we should want to get a fuzzy description of the real systems. This leads to deterministic description of some different levels of abstraction.

3. The 1st level belongs to a system description with the help of deterministic relations between deterministic inputs y and outputs x chosen from allowed areas Y and X respectively. A deterministic relation is a given subset of the direct product $Y \times X$

$$S \subseteq Y \times X$$

Given y defines a set $K_y \subseteq X$ with $(y,x) \in S$ for $x \in K_y$. This is the input-diffusion property which can be ordered by the introduction of state-variables. Given x defines a set $K_x \subseteq Y$ with $(y,x) \in S$ for $y \in K_x$. This is the input-pattern-recognition property of the system. Both properties are equivalent to each other.

4. We meet on the 2nd level, a first approximation to fuzzy systems behaviour. Here we find a deterministic

relation between probability distributions of the respective uncertainty functions inputs y and outputs x

$$S \subset P(Y) \times P(X)$$

5. In real systems also probability-distributions will be disturbed and become fuzzy functions. Thus, we find on the 3rd level deterministic relations between the probability distributions

$$S \subset P|P(Y)| \times P|P(X)|$$

and so on.

6. Statistics have the difficult task to connect the observations on the 1st level with the descriptions of all higher levels. Because of the lack of data, probability distributions are often substituted by some functionals, moments for example.

7. For sensitivity-analysis we need a description on the 2nd level.

III. Validity of Models and the Contradictory Influences in the Parameter Adapting Process

1. The aggregation of information about input-output relationship to a real system is performed by choosing first a convenient structure and then adapting its free parameters to data, which we can get on-line or off-line from the object.

2. For fitting the model-behaviour to the information from the object according to passive or active experiments, we need a comparison between object-output x and model-output x^* to common input-signals y . The parameter adaption process is organized on the basis of the evaluation or extimation of some criteria $Q_{x1}, Q_{xk}, \dots, Q_{xk}$ which are functionals on the error signal $e = x - x^*$. The criteria have values, which must all be small, and thus better enable us to describe the object behaviour.

3. Nevertheless, we intend to reach small values for all criteria Q_{xi} ; in the fitting process, we meet contradictions between the criteria--small values of some criteria demand greater values of the other criteria. For example, we get a small value of the mean value $M(e) = Q_{x1}$; this will be accompanied by a greater value of the variance $\sigma^2(e) = Q_{x2}$ and vice versa.

4. A great danger for the reliability of the model is the fact that the parameter identification is a mathematically incorrect problem. This means that some different sets of parameter vectors fulfill the same small values of the comparison criteria Q_{xi} . Having identified such a "wrong" set of parameters, the possibility of extrapolation of the model's properties is strongly restricted.

5. The dominating contradictory relation holds between the effort Q_1 and the aim-distance-criteria Q_{xi} . We want to achieve small values of all criteria Q_{xi} with a small effort Q_1 . The conclusion is that a given volume of object-information (Q_1) can lead only to a certain approximation of the object behaviour.

6. Often we look on the problem of parameter estimation as an optimal control problem: Given a certain effort Q_1 we want, through a choice of decisions, to reach the smallest possible values of Q_{xi} . This point of view leads to the demand to find a sequence of optimal experimental plans y_i to solve the optimization problems. But optimal plans need not be representative of the whole area of allowed input signals y . This is very critical only for descriptive models and less critical for theoretically better founded models.

7. Every parameter adaption process possesses an inner contradiction between memory in the form of the values of some state variables of the seeking process, and the actual information on Q_{xi} . In the strategy we must conclude a dynamic compromise between memory (influenced by past experience) and the actual information (influence from the present). This means, in fitting a global model to past data one should use forgetting functions on the values which will have relative weights of the data in different time intervals. With the decreasing distance between our actual position in the parameter space and the aim, the compromise between past and present should move into the direction of giving the past an increasing weight. Adaption and designing the compromise between past and present are equivalent.

8. The use of only adaption procedures in the parameter seeking process contradicts the fact that in reality, we have a problem of optimal control. Therefore we should

look for values of the model in the future by procedures of forward-playing, and combine such a strategy with that coming out from a pure adaption process.

9. In real model building processes the prescribed contradictions are related to each other; this means that the parameters for concluding the compromises are interdependent. It can be useful to use coordinating strategies to take into account the relationships between all these contradictory influences.

IV. Aggregation of the Information Included in a Set of Rough Models

1. Every model building method can only lead to a more or less rough model. This means it makes no sense to demand that in a rough model we can discriminate between parameter vectors having a small distance. It is a pattern-recognition problem with not disjoint classes.

2. Different model building procedures possess different parameter spaces A_j . A given object leads through the parameter estimation process to a point $P_j \in A_j$, which is a fuzzy point because of stochastic influences and the crudity of the model building process. By expert estimation or with cluster techniques we can approximately get a set of classes K_i^j in every parameter space A_j .

3. By expert estimation or with cluster techniques we can estimate a fuzzy mapping f_i , defined on the classes K_i^j and transform them into a common description-space A for all models in the spaces A_i .

4. By applying f_i to K_i^j we get the structure of fuzzy classes of models \tilde{K}_i^j in the common space A . We can use these class structures to construct a new structure \tilde{K}^j by the composition of the structures \tilde{K}_i^j using the technique of estimation of the fuzzy objects with the aim of getting classes \tilde{K}^j which are sharper than the classes in the different parameter spaces A_i .

5. We can also use a competition between the different models in the spaces A_i for the same object in the sense of mixed strategies (game theory) or in a switching process which time after time prefers one or the other model.

V1(1972-04-23)Rademaker

PROJECT GROUP
GLOBAL DYNAMICS
PROGRESS REPORT NO. 1

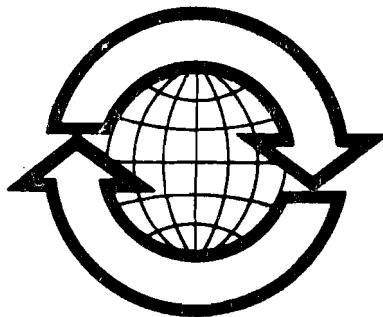

Note to the participants of the IIASA Symposium
on Global Modelling

Requests to be placed on the mailing list of the
Project Group Global Dynamics should be addressed
to:

Prof. ir. O. Rademaker

T.H.E. P.O. Box 513

EINDHOVEN

Netherlands



*On n'a pas besoin d'espérer
pour entreprendre
ni de réussir pour persévérer*

WILLIAM OF ORANGE



PREFACE

This is a report on the activities developed by the Project Group GLOBAL DYNAMICS in the first two months of its existence. The report aims at offering to a wide circle of persons interested as complete a picture as possible of the work, the directions into which it is developing, and the results that have been obtained. It is in particular presented to those who already expressed their interest and their willingness to cooperate but with whom no contact could be maintained owing to pressure of time.

It is a risky enterprise to write a report for such a wide and very diversified circle of persons interested, particularly on the subject of Global Dynamics. What has too little nutritive value for an insider may be all but indigestible for someone else. In addition, the chance of incorrect interpretation is not inconceivable. However, just as the study of the problems raised by the Club of Rome seemed necessary despite possible snares and pitfalls, so the drawing up of this report seems imposed upon us.

Those who like exciting reading and daring pronouncements will find little to their taste in this report on studies that aim above all at being thorough and reliable. So be it. One of the decisive motives to tackle this task was that with this important and urgent subject may be connected so great interests that it *must* be dealt with in the university world with its deep-rooted tradition of objectivity and independence. The type of reader referred to above will do best by skipping the whole report; the chance that he will interpret it incorrectly is not remote.

More important are those readers who *are* interested in the general problems but less in the control and systems engineering approach followed by us. We would recommend this group of readers to skip the chapter on the activities (Chapter 2) and to read only the chapters Introduction, Organisation, and Summary and Supplement.

And, finally: Names of members of the Project Group are seldom mentioned in this report. The Group presents itself here as a *team*, and, as behoves a good team, many important contributions from the individual members can hardly or not at all be isolated from the whole. Therefore, to all documents emanating from the Project Group (see *inter alia* the list at the end of the report), and hence also to the present report, applies that in principle a name identifies only the person who ultimately made up the text in question. Only two persons may claim to have contributed to virtually *all* documents, viz. Mrs. C.C.M. de Jong and Mrs. J.E.M. van Bergen, the unsurpassed members of our Group secretariat, whose world, owing to this project, has become even more dynamic!

CONTENTS

1. Introduction
 - 1.1 What went before
 - 1.2 Intentions
 - 1.3 Reservation

2. Report on the activities
 - 2.1 Insight into the model and understanding of its behaviour
 - 2.1.1 Forrester's model (World2)
 - 2.1.2 Meadows' World2
 - 2.1.3 Van der Grinten and De Jong's model
 - 2.1.4 The NC model
 - 2.1.5 The LINC model
 - 2.1.6 Final remark
 - 2.2 Sensitivity analysis
 - 2.3 Effect of dynamic improvements
 - 2.4 Correcting variables
 - 2.5 Effect of stabilising control
 - 2.6 Effect of optimising control
 - 2.7 Methods and techniques
 - 2.8 Evaluation and information

3. Organisation
 - 3.1 Members of the Group
 - 3.2 Course of procedure

4. Summary and supplement
 - 4.1 Forrester's world
 - 4.2 Model studies
 - 4.3 Possibilities of correction and criteria
 - 4.3.1 Possible correcting variables
 - 4.3.2 Criteria
 - 4.4 Stabilising and optimising control
 - 4.5 The report of the Club of Rome

Literature

Writings of the Project Group

Appendix

Some notes on Forrester's model



1. INTRODUCTION1.1. What went before

We assume that the reader is, at least superficially, familiar with *Limits to Growth* (3)*. This book was preceded by the book *World Dynamics* by Forrester (1) and two informal reports by Meadows et al. (2). It was primarily Forrester's book that attracted attention in several places in this country. One of these places was the Central Laboratory of the Dutch State Mines, where Van der Grinten and a number of associates responded to the invitation with which Forrester prefaced the presentation of his model: *"The reader should examine the assumptions and relationships (of the mathematical model about to be presented) for plausibility. If he were to engage in extending and refining the model, he would want to test his alternate hypotheses by altering the assumptions given here to determine which changes in assumptions result in significant changes in system behaviour. We are interested in the possible modes of behaviour of the world system. Before one is justified in devoting large amounts of time to individual assumptions, he should see something of the total system behaviour. Also, after a system model is operating, it is possible to examine sensitivity of the system to the various assumptions and to identify which are most important and need to be refined. One makes most rapid progress by following an iterative procedure in which he quickly comes to an approximate model, then examines behaviour of the system that has been described, and finally returns to improve the assumptions and the interpretations. This book is the first of such iterations; it is intended as much to present methodology as to yield conclusions"*.

In December 1971, Van der Grinten and De Jong published some provisional conclusions of their work (4). Starting from the results of simulations using a simplified model, they made it plausible that in Forrester's model *"there are a number of extremely critical quantities having a sensitive effect; so sensitive indeed that only very carefully following Forrester's assumptions leads to results as obtained by him. One wonders, then, why these situations and not other equally probable situations have been published, or why not a simulation has been set up with boundary conditions and parameters which fluctuate statistically within an acceptable range ("Monte Carlo" method)"*. Apart from this - i.e. not based on the simulation results - several other objections were raised, for example the objection that poorly known relations are supposed to be extrapolatable and reversible.

On February 11th, 1972, Van der Grinten in the Measuring and Control Seminar at the Eindhoven University of Technology held a lecture entitled *"The world of Forrester and the Club of Rome. Control and Systems Science considerations and suggestions concerning dynamic world models"*. With some fifty people interested, including many colleagues in the sphere of Control Engineering, views were exchanged regarding the contribution that might be made by control and systems science to the study of the problems brought up for discussion by the Club of Rome. The conclusion was that in view of the important social implications of this work for the world as a whole, in view of the importance to the Netherlands of being involved in it as closely as possible, and in view of the knowledge and skill with

* See Bibliography at the end of this report.

respect to working with dynamic models at the disposal of this country, it was of importance to create at a short date a project group whose nucleus would comprise the combined Measuring and Control groups of the E.U.T., in particular the section of the Department of Applied Physics (henceforth to be referred to as Section NC). From several sides active co-operation was promised, among which the Royal Dutch/Shell Laboratories at Amsterdam, the Central Laboratories of the Dutch State Mines, the Computer Centre of the Delft University of Technology and also the Subdepartments of Mathematics of all Universities of Technology and the State University of Groningen, and, of course, of the Universities of Tilburg and Eindhoven. Numerous others expressed their preparedness to take part in the thinking and the activities whenever they would be asked to do so. The *Work Group Future*, consisting of about a dozen very prominent scientists, business leaders and officials, for example, Nobel-price winner Professor J. Tinbergen, Royal Dutch/Shell president Mr. G.A. Wagner, Minister of Economic Affairs Professor H. Langman, Director of the National Bank and former prime minister Professor J. Zijlstra and Club of Rome member Professor C.J.F. Böttcher, was known to welcome such an initiative. The project and the project group had come into being.

1.2 Intentions

The name GLOBAL DYNAMICS was chosen to refer to the project as well as the project group, the word GLOBAL indicating the object as well as the character of the study.

Starting from mathematical models set up by others, the project group, in close consultation with specialists with respect to social science and/or management (henceforth to be referred to as *social specialists*), aims at making a control and systems science contribution to solving the problems brought up for discussion by the Club of Rome. Its attitude is professional, independent and objective, and on these grounds susceptible to ideas of - and co-operation with - others (also where persons or groups of persons with explicit and political views are concerned); its results and pronouncements should, however, be strictly reliable. All results are public, and hence available to others for interpretation.

What exactly does the handsome name *control and systems science* mean? *Control Science* is easily defined as the combination of control engineering and control theory, and this defines the term sufficiently well, but what has to be understood by the fashionable name of *Systems Science*? In our case it roughly means the knowledge and skill with respect to the study, based on mathematical models, of the dynamic and static behaviour of all kinds of systems, i.e. objects consisting of a number of interacting components, like a machine factory, a chemical installation, a natural gas network, the human eye, and the world.

The nature of the approach may be elucidated in two ways. First, by the enumeration of the weaker spots a control and systems engineer may discover in the MIT studies. To avoid misunderstanding it should be remarked that the work done by Forrester and Meadows et al. commands deep respect, in particular in view of the extremely brief space of time in which it was performed, but that this does not remove the necessity of identifying - and filling up - any gaps. Secondly, the character can be illustrated by the following list of action items in correspondence with which the activities will be reported on in the next chapter.

* See Appendix.

Items of action of the Control and Systems Science Approach

1. Insight into the model and understanding of its behaviour

The model presented by Forrester is essentially much simpler than it is suggested. Analysis of structure and functions, behaviour and inner working may render self-evident what at present still seems "counter-intuitive".

2. Sensitivity analysis

Systematic investigation of the effect of changes in initial values, coefficients and functions. *Usefulness*: it separates main things from details, it teaches model-makers what parts require further study and may indicate further simplifications.

3. Effect of dynamic improvements

Exploration of the effect of possible dynamic improvements including the introduction of a division according to age into the population model, of pollutions having different lifetimes, of the inhibition of the biological cleaning by chemical or thermal pollution, of the difference between poor and rich countries, and of a "refuse treasure". *Usefulness*: it teaches us to what extent the present simple model is or is not tenable, and through this can give hints to model-makers.

4. Correcting variables

Identification, definition and study of possibilities of influencing the behaviour of the world model. *Usefulness*: basis for stabilising and optimising control (see 5 and 6) and subject matter for the forming of thoughts with social specialists.

5. Effect of stabilising control

Exploration of the effect of various feedbacks with or without delay, taking into account the fact that the model on which this has been tried so far lacks almost all details which decide to what extent control can be effective at all.
Analysis of sensitivity of the model with control.
Usefulness: subject matter for the formation of thoughts with social specialists.

6. Effect of optimising control

Tentative calculations of the corrections that would be necessary in the course of years to realise the "best" development. This for various definitions of "the best" development. Perspectives of approximately optimal controls. *Usefulness*: as of preceding item of action.

7. Methods and techniques

Development of simulation techniques and other methods in the interest of the action items mentioned above, preferably in such a way that smooth switching over to a newer model is possible.

8. Evaluation and information

Evaluation of: formulations of problems, methods, results, opinions, and propositions, from the project group as well as from outside. Aiming at distinguishing:

- (a) what is almost sure to be correct or incorrect,
- (b) what might be correct or incorrect, and why this is not yet certain,
- (c) vague points that seem worthy of further study.

Objective information to insiders and outsiders. Contributing to the standardisation of formulations of problems, assumptions, methods, terminology and presentation of results.

Thus far this summary of the items of action. The composition and organisation of the project group will be described in Chapter 3.

1.3 Reservation

It is far from certain that Forrester's Method will lead to meaningful and usable results. In fact, the problem posed is awe-inspiringly complex, and in a number of far simpler cases this method has not yielded any new and usable results. In the future one will perhaps look back smiling and think "how naïve they were then".

However, a few things are clear. The method is in principle of the best kind available, and it is of great potential interest to try to improve it and to get what one can out of it. But at the same time it is clear that one must be extremely careful in attributing to the results the slightest realistic value. In fact, the behaviour of mankind is - even at short notice - so unimaginably unpredictable that no model is capable of indicating with certainty what is going to happen and what one will have to do. Those who do not realise how uncertain all predictions are, even those covering only a couple of years, are unfit for work in this area. However, those who are familiar with working with models *do* know that the most important usefulness is perhaps that one can get an impression of what is likely not to happen and of what one will not have to do. Such a restriction of problem formulation and possible results is often very valuable. And the point at issue is to utilise the information available at present as well as possible and in doing so to recognise possible developments in the long term, in order that the best frame-work of management-in-the-mid-long-term may be determined.

On the basis of these considerations the present writer is of the opinion that no better motto for the GLOBAL DYNAMICS project can be found than that of William of Orange:

Neither is hope a requisite for enterprise, nor success for perseverance.



2. REPORT ON THE ACTIVITIESIntroduction*

This report covers the initial period from Friday February 11th (when after Professor Van der Grinten's lecture the institution of the project group was decided upon) to Saturday April 15th (when after the lecture of Professor Meadows the latter placed his latest version of the *World3* model at our disposal). This is at the same time the period in which the long-awaited book *Limits to Growth* (3) was published.

The activities described in this progress report refer exclusively to studies based on the model constructed by Forrester (1), which in the current jargon is called *World2*. Whether ever a *World1* and perhaps even a *World0* and a *World00* have existed - in imitation of denominations of models current elsewhere - we do not know (perhaps we may assume that these names refer collectively to all non-mathematical models of world events used so far).

Our activities were carried out in anticipation of the *World3* model and our first concern was therefore to acquire insight into and experience with the kind of uncertainties, moot points, contrarities, obscurities, calculating difficulties, and similar problems which are inherent to the subject. (At the same time a substantial part of the internal and external organisation had to be created, but this is reported in Chapter 3).

It had been our intention to devote our attention also to the literature which considers subjects and methods germane to Forrester's *World Dynamics*. Further, we had wanted to examine, together with social scientists, the criteria one might apply to judge possible future developments and the possibilities of control.

Unfortunately, little has come of this. In retrospect it appears that two main causes may be pointed out. The first is that virtually every one who, starting from the same mathematical model *World2*, performed calculations produced different results. The differences diverged from a few per cent (for digital calculations!) to a few dozen per cent (for analog calculations with sensibly but drastically simplified models). Now it can rightly be argued that such difference of a quantitative nature are relatively unimportant in view of the enormous uncertainties inherent to the model itself. Since Forrester himself, however, presented results that clearly do not tally with his own definitions (see Section 2.1.1), and Meadows, at first apparently calculating with the same *World2* model, obtained results deviating in certain respects (see Section 2.1.1), it seemed to us of interest to find out to what such differences are attributable.

The second main cause is to be found in the fact that the maintenance of necessary contacts and responding to questions from all quarters demanded far and far more time and energy than had been anticipated. In itself it is an exceedingly gratifying phenomenon that so many in this country are interested in the problems, and that so many try to supply a meaningful contribution. However, it requires a considerable portion of the time and energy available.

Let us now consider the work that has been done. We use the division given in Section 1.2. Many of these activities run parallel to each other, but for the sake of clarity we shall discuss them consecutively.

* As explained in the "Preface", it is suggested to the more globally interested reader to skip this chapter.

2.1 Insight into the model and understanding of its behaviour

2.1.1 Forrester's model (World2)

Forrester's model has been studied thoroughly; some conclusions are:

Diagram:

The model is represented too intricately; the diagram can be drawn more surveyable and at the same time furnish more information (I26)*.

Functional relations:

Forrester himself points out that he considers certain functions to be dubious and that these require further study; we add to this a few more functions (I24). If, however, one considers only the credibility of the propounded causal relations, one incurs needless work. It is preferable to draw up a table in which for each function are mentioned:

- The range and the number of straight lines the input variable traverses in the standard run (the meaning of this is: the calculation of the nominal behaviour - in Forrester's terms also called the original, the normal, and the basic behaviour).
- Do. In the collection of all non-catastrophic runs.
- Do. In the collection of all catastrophic runs (if one is still interested in this**).
- The sensitivity of the behaviour of the model with respect to the coefficients of the function.
- The (subjective) credibility of the function.
- The part the function plays.

On the basis of such a table it can be decided which functions require further consideration (this analysis has not been carried out completely for *World2* in view of the advent of *World3*).

Studying the system as a whole:

Although so many proclaim that a system is more than the sum of its components, only few investigate in what respects a system manifests itself as a system. Generally one restricts oneself to:

- (a) the dissection of the system (definition of relevant variables and system components,
 - (b) establishing functional relations between variables (analysis of the system components), and:
 - (c) calculating the behaviour of the whole under various circumstances.
- Often, the structure and properties of the system as a whole are then not given the attention they deserve. This applies likewise to Forrester's *World*. Therefore, special attention has been given to this; before long we hope to be able to demonstrate what interesting insight such a study yields.

Reversal of history

A historian has been described as "Ein rückgängiger Prophet"***. In this spirit we have taken the liberty to calculate from 1900 *backwards* instead of forwards using Forrester's model. To this end one function was extended linearly (viz., F6, which determines the efficiency of the investments as

* This is a reference to Informal Note No. 26, see list at the end.

** Forrester shows a number of runs - considered by himself as unrealistic - in order to demonstrate the various limits to growth.

*** "A prophet looking backwards".

a function of the natural resources, was extended linearly in order to be able to calculate also with stocks larger than those of 1900). Within a year or so, the calculation came to a deadlock because the degree of pollution became negative. As this was an artefact, the degree of pollution POLR was put equal to 0.000 000 000 1 as soon as pollution became negative. With this adaptation the calculation ran aground in the summer of 1880, owing to the agricultural capital fraction (CIAF) becoming negative; see dotted parts of the lines in Figure 1. For safety, we next made a normal forward calculation with the standard programme, starting from the values of 1881 (solid lines in Figure 1). The results coincide before 1900 with those of the backward calculation, and after 1900 with Forrester's.

SCALE VALUES: P: $5 \cdot 10^9$, CI: $1 \cdot 10^8$, MSL: 1, FR: 2, CIAF: $\frac{1}{2}$.

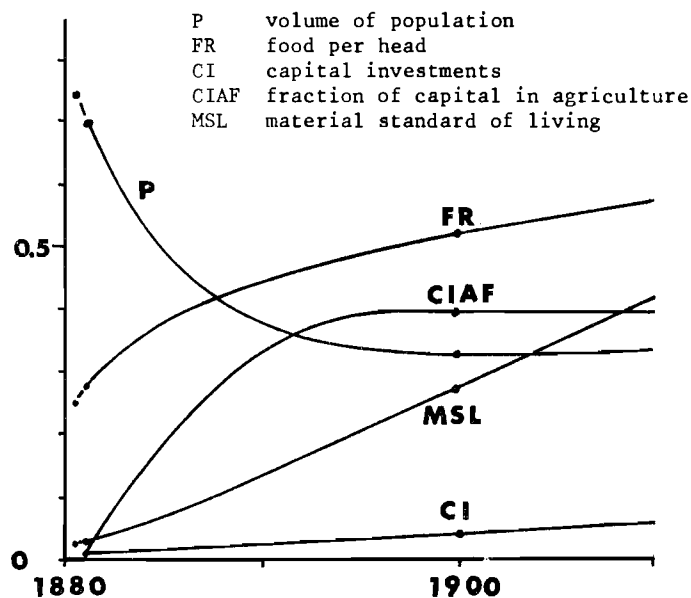

Figure 1

According to the model, the population in 1880 equals 3700 millions (more than in 1970!) and decreases in nearly twenty years by slightly over 2000 millions. This is caused by the low values of food production and material standard of living. At the outset, the capital investments are almost constant, but owing to the decrease in population the per-head investments rise rapidly enough to get the investments - and later also the population - going, all in accordance with the model.

So many premature and wrong "conclusions" can be drawn from these results that we publish them hesitatingly. The reader is advised to regard all this as a practical joke rather than to take it in good earnest. For the sake of brevity reference is made to the supplementary comments in Section 4.2.

To mathematically trained readers it is of interest to explain why, when calculating backwards from 1900, the pollution became negative after a year or so. This is the inevitable consequence of the choice of the initial value POLI, that is the value of POL in 1900. Apparently, Forrester

did not realize that the state variable POL is a so-called *stiff variable*, in the present case a quantity which tries to adjust itself to a value about equal to $0.61 \cdot CI$ with a very small lag (time constant 0.61 years). Now the initial value of CI was equal to $4 \cdot 10^8$ so that the corresponding initial value of POL would have been approx. $2.4 \cdot 10^8$; Forrester, however, assumed an initial value of $2 \cdot 10^8$. In 1900, POL can have this value only if it is on its way to the value of $2.4 \cdot 10^8$ at great velocity, and hence comes of even lower values at a high speed. Therefore, if one wants to start the calculation on January 1st, 1899, instead of 1900, one has to assign POL a rather large *negative* initial value in order to arrive on 1.1.1900 at Forrester's value of $2 \cdot 10^8$. If one takes the initial value on 1.1.1899 equal to zero, then POL already nearly reaches the value of $2.4 \cdot 10^8$ on 1.1.1900. In Forrester's own calculation POL must have run very rapidly to this value in the course of 1900, but maybe he has never noticed this because his graphs show no results between 1900 and 1904. The above emphasizes that the initial values of state variables cannot always be chosen freely.

Calculative aspects:

Forrester starts his calculations in 1900, but in order to eliminate a number of dimension and scale value problems he defines the units in which a number of quantities are expressed in such a way that these quantities must be equal to 1 in 1970 (i.e. per definition). Owing to this he has incurred a two point boundary value problem which he has solved reasonably well, presumably after a few iterations. But not all reasonings by which the values of the state variables in 1970 are converted in his book to those of 1900 are watertight (see, for example, Section 3.2 on the birth-rate and Section 3.8 on the natural resources). From his graphs it appears that a number of these quantities do not satisfy exactly the requirement introduced by himself that they should be equal to one in 1970. Why it does not seem to have occurred to him to calculate backwards from 1970 to 1900 is not clear. This would have been all the more plausible because he established (explicitly or implicitly) the values of all state variables in 1970, even those of the stock of natural resources, which he next took as starting value in 1900 (page 38 of the book).

Although the deviations are not great, it was important to ascertain to what they are to be imputed, first of all to prevent confusion between those who work with these models, and secondly because it is important to know the values in 1970 accurately if they are to be used as initial conditions of calculations with a simplified or non-simplified model. As we did not have Forrester's DYNAMO procedure at our disposal, a number of fellow-countrymen who probably have used it, have been requested to report their experiences and views (I32). Their findings will be reported on in due course.

2.1.2 Meadows' World?

Meadows and his associates apparently have at first (2) carried out calculations with Forrester's model, but their results show some remarkable deviations. Thus, in Forrester's model the peak of pollution in the standard run lies nearly 50% higher, viz. at $6 \frac{1}{15}$, while Meadows has it at only $4.4 \frac{1}{15}$. This is probably the reason why in Meadows' calculations the peak of the population curve is maintained some 25 years longer. The result is that after the year 2050 his model has approximately 800 million people more than Forrester's. In spite of this he manages a little more economically as regards natural resources. His quantity of food per head from 1900 to 2100 lies much nearer to the value in 1970 than according to Forrester (but in the definitive report of the Club of Rome this quantity appears to vary much more strongly according

to *World3* than according to Forrester, but in the reverse direction! - Compare Figure 4-2 of Forrester with Figure 35 in *Limits to Growth*. The explanation of these differences is not yet clear. It is possible that they were caused by Meadows solving better the two point boundary value problem mentioned above. On this point, too, questions have been lodged (I32).

In this connection it should be mentioned that the diagram of *World2* given by Meadows deviates slightly from Forrester's (I26).

Since Meadows has in the meantime developed *World3*, the differences mentioned above seem to be interesting only in so far as they lead to a better insight into Forrester's World.

2.1.3 Van der Grinten and De Jong's model

Van der Grinten and De Jong have made orienting studies with the aid of a partially linearised model in which the agricultural variables were taken constant - viz. equal to the values in 1970 - and the influence of crowding was left out of consideration. The period considered was 1970 - 2100 or 2300. By "partially linearised" is meant that the non-linear functions in the model are given by a series of linear sections joining each other, in other words: the graphs show an continuous series of straight lines. Forrester defined all his functions in this partially linearised form, probably assuming that this gave a sufficiently accurate approximation of smooth curves. The model calculations are, however, so sensitive to changes in certain functions that, using smooth curves (analytical functions through the points specified by Forrester) the Royal Dutch/Shell Laboratories at Amsterdam obtained results which substantially deviated from those of Forrester (at some points of time, for example, population and pollution deviated a factor 2). Therefore it is not surprising that Van der Grinten and De Jong, who replaced some functions showing one or more faint bends by a linear function chosen as well as possible, adapting, if necessary, the coefficients to some extent, in their turn obtained different results. For an exhaustive analysis of the deviations the reader is referred to the publications in "Chemisch Weekblad" (4-6) "Econonisch-Statistische Berichten" (7) and to report U5, as well as to the Informal Notes in which our findings have been laid down (I29, I30, I33, I35, I36; further I38 and I37).

Anyone who tries to reproduce the results of Van der Grinten and De Jong starting from the equations published, will find that his results do not agree exactly. This is because some coefficients in the publication have been rounded off; the model behaviour is so sensitive to the values of these parameters that reproduction calculations have to be based on more accurate figures. These are specified in an Informal Note (I30). See, however, the next section.

2.1.4 The NC model

Generally speaking, persons interested are advised to base calculations on a model in which the agricultural sector and crowding are present. Anyone who wants to study non-catastrophic developments may use, in addition to Forrester's model, the NC model constructed by us, which - naturally within the prescribed range of the variables - produces exactly the same results, but lends itself better to analog simulation and is also more suitable for digital simulation by means of a terminal, because the table manipulations take less time. This model has been specified in an Informal Note (I33) and will be published in IFAC-

AUTOMATICA in the spring of 1973.

The ALGOL programme which is used for this purpose on a Philips P9200 terminal, is available upon request. In general, it is, however, advisable to calculate with the complete Forrester's model, if only because Forrester goes beyond his own tables in certain runs. For the latter procedure a P9200 Algol programme is available.

2.1.5 The LINC model

For the purpose of analysing the model-as-a-whole, a completely linearised model (the LINC model) has been derived, starting from the situation in 1970. The idea is not to carry out calculations with it (although it yields rather good results as far as in the next century), but to get more insight into the system, for instance, by studying the feedback matrix and its eigenvalues. Some of the results are quite unexpected (I34). The analysis will be submitted for publication in IFAC-AUTOMATICA. The insight and results acquired may be useful for studies on the subject of stabilisation and optimising.

2.1.6 Final remark

As appears from the foregoing, the investigation of the model cost a greater amount of time and trouble than we expected. This was at the cost of other activities that had been proposed, viz. the contacts with specialists in the fields of economics, demography, ecology, agriculture, law, sociology, etc., and partly also at the cost of further explorations on the basis of *WORLD2*. We hope and expect that later on it will be concluded that the efforts to first control thoroughly the problems in the World of Forrester have been valuable.

2.2 Sensitivity analysis

Starting from Van der Grinten and De Jong's model (as specified in (I30), i.e. without the agricultural sector and crowding), an analysis of sensitivity has been carried out on an analog computer. Informal note I19 contains graphs showing how

- the natural resources,
- the population
- the capital investments,
- the pollution, and
- the material standard of living

vary according to this model from 1970 to 2100, if various values are assigned to

- BRN = birth rate coefficient,
- DRN = death rate coefficient,
- CIGN = re-investment coefficient,
- CIDN = rate of depreciation,
- POLN = coefficient of pollution generation,
- POLAT = pollution absorption time as a function of the degree of pollution,
- NRUN = coefficient of usage rate of natural resources.

These graphs, which naturally should be interpreted intelligently, are very instructive. For instance, in them the decomposition of the model - which can already be deduced from the original equations - is clearly reflected: variations in the population sector and the pollution sector have hardly any effect on the capital and natural resources sectors, except under very abnormal conditions. As appears from a qualitative summary in matrix form, the

following applies:

- An increase in population and a decrease in pollution generation have effect in the same direction on: population (positive), degree of pollution (negative), and material standard of living (negative).
- An increase in capital investments and a decrease in the usage rate of natural resources both lead to: higher investments, higher material standard of living and more pollution; both act equivocally on the population, but, naturally, larger investments lead to a larger consumption of natural resources, whereas economy with resources leads to a lower consumption.

We emphatically point to the fact that from the above only indications as regards the sensitivity of the *model* may be derived. Direct translation to reality is not allowed because in reality it is never possible to modify only one coefficient. The real world simply cannot invest more in means of production unless at the cost of something else, for example, at the cost of investments in the agricultural sector or in the service sector, or at the cost of the material standard of living of the consumer. Neither is it possible in reality to restrict the consumption of natural resources (in our case NRUN) to one fourth, without drastic alterations being brought about. If, in spite of this, Forrester devotes four diagrams to what would take place in such a case, he is trying to make clear that he is doing this with a view to learning to know the model better. However, while reading, one easily loses sight of the fact that only a (non-realistic) model experiment is concerned. In view of the totally incorrect interpretations attached to this kind of results by many persons - including many of whom more insight might be expected - we cannot state clearly enough that:

SENSITIVITY ANALYSES SERVE TO FIND OUT HOW GREAT IS THE INFLUENCE OF THE CHOICE OF CERTAIN COEFFICIENT VALUES, FUNCTIONAL RELATIONS, AND INITIAL VALUES, AND NOT OF FINDING THE EFFECT OF PARTICULAR REAL-WORLD MEASURES. Anyone who wants to do that should first carefully find out in what places and in what ways such measures have their effect (see further Section 2.4).

No systematic sensitivity analysis with respect to the choice of the *initial values* has been carried out as yet. Exploratory calculations have in the mean time shown that some initial values, or ratios of initial values, have a distinct quantitative influence.

Informal note I19 also shows the results of a sensitivity analysis of a model *with control* (see further Section 2.5).

2.3 Effect of dynamic improvements

Anticipating the publication of *World3* - which embodies a great number of improvements - not much attention has been given to this point (work has been done on the development of the simulation techniques required. See further Section 2.7).

- * Although it should give food for thought that restricting the winning of natural resources to the tune of 75% would lead to an enormous increase in the material standard of living!

Chiefly for the sake of the dynamic optimisation studies (Section 2.6), however, an exploratory investigation has been carried out with respect to the influence of the time lag of the pollution. In fact, this state variable adjusts itself to changes in the supply in a much shorter time than the other state variables in the model provided the pollution does not become more than, say ten times its value in 1970. It is interesting to find out if one may ignore this short lag*, for that would make it possible to save roughly a factor ten in calculation time in each digital simulation and another factor ten in dynamic optimisation studies.

The results of the calculations give reason to expect that the lag of the pollution - and hence the part this quantity plays as a state variable! - may be neglected in the present model (I20).

2.4 Correcting variables

As has been emphatically pointed out in Section 2.2, one does not get a realistic picture of the effect of corrective measures by altering a coefficient here or there. For example, to enable the effect of a particular measure for restricting environmental pollution to be investigated, one will at least have to find out what effect the measure has in the pollution sector and what effect its cost has in the capital sector. Little attention has been paid to this point so far neither by the M.I.T. nor by the Club of Rome.

Therefore the project group has given thought to and discussed appropriate formulations of the possibilities of introducing correcting variables into the model and the problems connected with this. No satisfactory solution has been found as yet, not even for the simple world of Forrester, but for the sake of dynamic optimisation studies a provisional formulation of correcting variables and of possible optimising criteria has been laid down in I28.

It is evident that in any case the *cost* of every measure has to be taken into account. However, as the capital sector in *World2* is so simple and as Forrester does not define the concept capital, it is no simple task to weave the cost into the model in a consistent way. In the mean time it has turned out that our early ideas (I13) agree rather well with the views of Meadows. Therefore, we intend to bring these problems up for discussion in wider circles before long.

2.5 Effect of stabilising control

At Dutch State Mines it has been investigated what would be the effect if the control proposed earlier (4, 5) were introduced not in 1970 but in 1980, 1990 and 2000, respectively. If the situation *in the year of introduction* is taken as the desired value, the curves of the state variables (natural resources, investments, pollution, population) show great shifts. If, next, simulations are carried out in which the situation *in 1970* is taken as the desired value, the curves of the state variables shift far less; however, action comes home much harder in proportion as control is introduced later.

Finally, a simulation has been made of the introduction of control in 1970

* To avoid a most likely misunderstanding: this does not mean that the influence of POLAT is eliminated from the connection between POLG and POLR, but only that the connection is taken to be without inertia (if you like, algebraic).

with the situation in 1950 as the desired value; but this hardly affects the curves of the state variables. The results mentioned above have been published (6).

Using the same model, it may be useful to investigate the effect of stabilising the *Quality of Life* defined by Forrester.

Finally, a sensitivity analysis has been carried out on the controlled model (I19). Comparison with the uncontrolled model shows that generally the curves of the state variables are smoother and less sensitive to parameter changes. The most important exception is that, owing to control, the resources and investments are now sensitive to changes in the parameters of the population and pollution sectors.

For safety, it should be emphatically pointed out that the results of these control studies should be interpreted with much caution, firstly because the proper correcting variables have not yet been used, and secondly because any model based on *World2* is far better controllable than the real world. The stabilisation studies will, therefore, not be continued until a model of *World3* with correcting variables is available.

2.6 Effect of optimising control

A special subgroup - including participants of the Royal Dutch/Shell Laboratories Amsterdam, the Dutch State Mines, the State University of Groningen, and the three technological universities - is going into the problems and possibilities of the application of the theory of dynamic optimising. At first the discussions centred for a long time round the formulation of the possibilities of correction and the criteria, partly because for many obvious formulations the Hamiltonian shows that they might give rise to bang-bang solutions.

In the mean time the Royal Dutch/Shell Laboratories Amsterdam have made available programmes and calculation time for dynamic optimising according to Pontryagin, which is used for a preliminary study based on the D.S.M. model. Parallel to this, the Dutch State Mines are investigating the possibility of a time → resources transformation, and the Twente University of Technology are studying the possibilities of application of a programme for optimum-time calculations according to Pontryagin and of dynamic programming according to Bellman, while the other institutes are making orienting studies.

2.7 Methods and Techniques

To supplement what has been said about methods in the foregoing, we will give the calculating facilities a moment's thought.

The D.S.M. model is implemented on an analog computer (EAI 680). This machine is coupled to a bigger one (EAI 231R) to simulate the NC model with agricultural sector and crowding. The great advantage of analog simulations is that a complete calculation covering the years 1900 to 2100 or 2400 can be carried out dozens of times per second, the results becoming visible on a monitor as a stationary collection of graphs. By turning knobs one can make alterations in the model; the results become visible at once.

This not only increases working speed, but above all deepens insight into the model.

In addition, calculations are performed - particularly for verification purposes - using an Algol program of *World2* according to Forrester's specification in Appendix B of his book. These calculations are carried out via a terminal of the Philips P9200 time-sharing system of the E.U.T. This program will be made available to others upon request.

For extensive calculations a program is written for the EL-X8 of the E.U.T. together with a few PDP8 program for automatic conversion of P9200-programs for the EL-X8 and vice versa.

The small digital machine PDP8 is not only used off-line to convert programs and data from one digital machine to another, but also on-line to take over certain tasks from the analog machines. This becomes of special importance to working with *World3*, to investigating the effect of dynamic corrections, and to studying stabilising and optimising control. By way of exercise, work has been done with the DSM model of which a certain cluster, i.e. a subsystem with relatively many internal and few external variables - in this case the population sector - was simulated in the digital way and the rest in the analog way. The PDP8 appeared to have enough calculating time and memory space, and accuracy was good. To get to know better the limitations of this procedure, the pollution sector was next chosen as cluster, because this influences the model's behaviour strongly and has a relatively small time constant. The results did not appear to become appreciably noticeable before the sampling frequency of the PDP8 was reduced below 5% of its possible maximum.

Combined with the analog machines, the PDP8 can fulfil other useful tasks, such as evaluating the results on the basis of those of previous calculations. It is, however, not the intention to proceed to complete hybrid simulation, because for this purpose it is much better to use the great hybrid calculating facilities already offered by the Delft University of Technology.

2.8 Evaluation and information

Evaluation of the publications of Van der Grinten and De Jong (4-6) and of Muller's criticism of them (7) is, as mentioned earlier, reported in a number of informal notes and in report U5.

The study of Forrester's model discussed in 2.1.1 and 2.1.5 has revealed some interesting points with respect to the nature of the model to which, after further verification, a few publications will be devoted.



3. ORGANISATION3.1 Members of the Group

Scientific management : Professor P.M.E.M. Van der Grinten, and
Professor O. Rademaker.

External coordination : Professor O. Rademaker, E.U.T., Post Box 513,
Eindhoven, Netherlands, Phone 040-472885.

Internal coordination : Mr. J.G.M. Cuypers, E.U.T., Post Box 513,
Eindhoven, Phone 040-472881.

Associates:

Professor J.F. Benders (E.U.T./Mathematics)
Mr. C.G.J. Buursen (E.U.T./Measuring and Control)
Dr. H.A.G. Chermin (Dutch State Mines/D.S.M.)
Mr. J.G.M. Cuypers (E.U.T./Measuring and Control)
Mr. G. Dekker (E.U.T./Measuring and Control)
Mr. J. van Drie (E.U.T./Measuring and Control)
Dr. M.L.J. Hautus (E.U.T./Mathematics)
Dr. J.L. de Jong (E.U.T./Mathematics)
Mr. P.J. de Jong (Dutch State Mines/D.S.M.)
Mr. A.C.P. de Jongh (E.U.T.)
Mr. E.J.H. Kerckhoffs (Delft University of Technology/Mathematics)
Mr. A.G.H. Kessels (E.U.T./Measuring and Control)
Professor H. Kwakernaak (Twente University of Technology/Mathematics)
Mr. M.J.B. Monen (E.U.T./Measuring and Control)
Mr. J. van Nierop (E.U.T./Measuring and Control)
Mr. Th.W. Oerlemans (Royal Dutch/Shell Laboratories Amsterdam)
Dr. G.J. Olsder (T.U.T./Mathematics)
Mr. G. Sijberden (E.U.T./Measuring and Control)
Mr. M.J.M. Strik (E.U.T./Measuring and Control)
Mr. A.J.M. Timmermans (E.U.T./Measuring and Control)
Mr. W.A.H. Thissen (E.U.T./Measuring and Control)
Mr. J.H.Voskamp (E.U.T./Measuring and Control)
Mr. Th. Zwietering (Dutch State Mines/D.S.M.).
Underling denotes full-time associates.

Professor Van der Grinten will be associated with the Measuring and Control Group of the Department of Applied Physics of the E.U.T. at Eindhoven as a part-time Professor as from September 1st, 1972.

The Netherlands Organisation for the advancement of pure research (Z.W.O.) has been requested to subsidise the cost of an associate who will especially go into the mathematical aspects of the optimisation studies.

3.2 Course of procedure

The group aims at losing little time on formalities. The work is characterised by numerous intensive, informal interactions; in connection with the size of the group and the fact that its members live in various parts of the country the interactions partly take place in writing (See list of Informal Notes). Some subgroups can be distinguished (optimisation, simulation, stabilising control) who

* Not only inside the work group but also, for instance, with the State University of Groningen.

take counsel with each other regularly. The intention is to extend this kind of contact gradually to workers in other fields (economists, ecologists, etc.), for the work of the group is only meaningful if in interaction with the appropriate students of other subjects and professions the appropriate answers to the appropriate questions are found. For this reason, too, it seems desirable to form one or more discussion groups of diverse composition to evaluate critically the direction in which the work proceeds and the results that are obtained.

The nucleus at Eindhoven looks after the internal and external coordination, the distribution and filing of documents, and reporting. A provisional sounding of personal interests led to drawing up a mailing list containing the names and addresses of about 100 persons and groups outside the E.U.T. many of whom have offered their services.

4. SUMMARY AND SUPPLEMENT

4.1 Forrester's World

Forrester's work - presented by him as no more than a first step concerning an enormously comprehensive subject - commands great admiration. The approach followed by him is sound, even though when applying it he drops an occasional stitch, indeed without appreciable consequences (Section 2.1.1).

Forrester's model *World2* can be improved upon in a number of respects. Improvements fitting into the scheme indicated by Forrester include:

- Splitting up a number of quantities. For instance: distinguishing between rich and poor parts of the world, and between different kinds of resources, investments and pollutants.
- More and better dynamic interrelations. For example, the model does not contain any time delay*, and the age-distribution of the population is not represented.
- To verify and, if necessary, to adapt functional relations based on mere suppositions.
- To verify whether existing correlations have not unjustly been represented as causal relations.

There are, however, also improvements that fit less well or not at all into Forrester's procedure and, hence, require extensions, such as:

- Taking into account the statistical character of certain quantities and causal relations.
- Taking into account non-reversible or discontinuous relations. Some relations, for example, are probably different during a decline from during a period of uninterrupted growth.
- Taking into account more complex interrelations. Forrester represents all relations as products and/or quotients (and sometime additions and/or subtractions) of one-dimensional functions. Closer study may reveal that certain relations have to be treated essentially as functions of more than one variable.

* Forrester's nomenclature differs from what is usual in control and systems science, where a delay means that a signal is *delayed* for a certain time but otherwise is *unchanged*, while the word lag is reserved for systems described by first or higher order differential or difference equations. The latter are occasionally referred to by Forrester as delays.

4.2 Model Studies

The sensitivity studies show what happens when certain model coefficients change. In first approximation it can be said that changes of less than 20% with respect to the values chosen by Forrester do not modify qualitatively the behaviour of the model: resources (naturally) continue to decrease, while population, investments and pollution usually pass through a maximum between 2000 and 2100. Only the "Material Standard of Living (MSL)" behaves more capriciously, sometimes falling sharply from 1970, sometimes rising, and in the other cases passing through a maximum more or less meanderingly.

In quantitative respect changes may, otherwise, be quite considerable; especially the peak value of the degree of pollution (according to Forrester's standard calculation already six times as high as the pollution of 1970) reacts markedly to modifications that are not great in comparison with the uncertainty with which the coefficient involved is known. Thus Forrester in essence supposes that the annual investment in means of production is approximately $0.05 \times \text{population} \times \text{material standard of living}$ if the latter is between $\frac{1}{2}$ and 1, the coefficient 0.05 being, in principle, constant from 1900 to 2100. However, as he himself has already shown, a rise from 0.05 to 0.06 as from 1970 brings about in his model over six times as high a pollution peak (i.e. nearly 40 times the present level!). From these and other results it appears that the model is indeed very sensitive to changes in the sectors *capital* and *pollution*, from which it may be deduced that it is probably desirable to construct better models for these sectors.

As expounded in Section 2.1.1, we are of the opinion that Forrester presents his world model in a rather complicated way and makes little effort to analyse the structure and the characteristics of the system as a whole in depth. We hope to be able to demonstrate before long that this aspect of *system analysis* deserves more attention.

As shown in Figure 1, Forrester's model does not lend itself to calculating backwards from 1900: in the summer of 1880 the calculation runs aground because the investments in agriculture become negative. In the meantime, the model has then shown a kind of inverse population explosion, for the number of souls "rises" within 20 years from 1,650 millions in 1900 to 3,700 millions (that is more than in 1970!) in 1880*. We hasten to add that nobody should draw rash conclusions from this statement with respect to the validity of the model, however tempting it may be! *No one* model represents reality completely. Reality is far too complicated. *Any* mathematical model gives a *partial description* for a *certain purpose*. Astronomers have for a long time and very successfully used a totally different model of our world than Forrester's model, and astronautic scientists who want to launch an earth satellite use still another model, also successfully. Thus it must not be expected that a model designed for exploration of the future allows of extrapolating towards the past without more ado. The results of before 1900 do not prove that those of after 1970 are

* To reassure insiders: the solid lines in Figure 1 have been calculated by making a normal calculation start in 1881 with as initial values: $PI = 3.45' + 9$, $NRI = 9.05' + 11$, $CII = 7.13' + 7$, $CIAFI = 1.22' - 2$, and $POLI = 1' - 10$ (rounded off values). After 1900 the results coincide exactly with Forrester's; as far as we know, it is impossible to achieve this when starting from a date before 1880.

incorrect. Here, too, much depends on the sensitivity of the model. However, as long as this has not been investigated further, and indeed so long as more attention has not been given to experimental verification, some scepticism with regard to all results of Forrester's model seem justifiable.

4.3 Possibilities of correction and criteria

4.3.1 Possible correcting variables

As an important problem it has been pointed out (in Sections 2.2 and 2.4) that the models do not yet embody realistic correcting variables. What is shown is what happens if one of the coefficients changes, for example, if the factor of pollution generation is lowered, but even the cost of such a change is not accounted for.

In view of the fact that this is overlooked even by many persons of whom more insight might be expected, we repeat here our warning: *SENSITIVITY ANALYSES SERVE TO FIND OUT THE INFLUENCE OF THE CHOICE OF CERTAIN VALUES OF COEFFICIENTS, FUNCTIONAL RELATIONSHIPS AND INITIAL VALUES, AND NOT TO STUDY THE EFFECT OF CERTAIN MEASURES.* Any one who wants to pursue that kind of study must first carefully search out in what places and how the relevant measures are effective. Not until then one can start investigating the effect of measures and controls.

4.3.2 Criteria

The standards that may be applied to judge the desirability of the behaviour of the model under the influence of the above measures and controls are called *criteria*. A criterion is in fact a prescription according to which one can assign a report mark to each and every behaviour of the model. Once the prescription has been established, one can start looking for the 'best' measures or the 'best' control algorithm, in which the 'best' is that which produces the highest mark. It will be clear that one can arrive at totally different conclusions if one starts from different criteria. Therefore, it is of importance to find out what criteria may be considered. Now the system scientist is not the best qualified man to draw up such criteria, but he can render great services to the more specialised men in this field by showing them what the consequences from any choice are.

The problem is made more complicated by the fact that many possibilities of correction so affect the life of the individual inhabitant of the earth that they will have to occur somehow in almost any imaginable criterion. It is therefore hardly possible to detach the defining of correcting variables and that of criteria.

The importance of proper consultation on criteria and possibilities of action can hardly be overestimated. For both, the model work and the philosophy embedding it can form the basis for a highly improved development of policies, nationally as well as globally. It can become a common discipline of thinking enabling industry, statesmen and authorities, and governments mutually, to communicate more effectively with each other. The chance that system scientists find under their own power exactly that approach of which those who exercise substantial influence on the development of society understand something, and with which they can do something, is almost nil. Proper consultation is therefore indispensable.

It should be observed that from the model in itself *no one* conclusion can be drawn about a definite social structure being desirable (or, more strongly: "correct") or not. Such a conclusion can in essence not be drawn until at least a criterion as well as model assumptions regarding the operation (preferable in the form of mathematical expressions) of the form of social organisation in question have been propounded. These are not present in the model, and the fact is that a model can only "pronounce judgment" on things regarding which rules and assumptions have been included in the model.

ANYONE WHO THINKS THAT THE RESULTS OF THE MODEL GIVE CLEAR DECISIONS ON THE DESIRABILITY OR UNDESIRABILITY OF A DEFINITE SOCIAL STRUCTURE, HAS - CONSCIOUSLY OR UNCONSCIOUSLY - INTRODUCED A NUMBER OF SUPPOSITIONS ABOUT ONE OR MORE SOCIAL STRUCTURES AS WELL AS A STANDARD OF JUDGMENT (CRITERION).

4.4 Stabilising and optimising control

Forrester in his book creates the impression that he thinks exclusively in terms of what we call here *measures* (as from 1970, 75% is economised on resources and/or the "normal" birth rate is reduced by 20%, etc.). In applying *control*, the procedure is essentially different. The magnitude of the action taken is then not constant but is related to the extent to which the *real* development deviates from the *desired*. This has two important advantages.

First, control can ensure that the corrections proceed more gradually and the developments in the system more evenly ("smoothly"). This is not only important because man can assimilate gradual changes better, but also because science and the art of government are then in a better position to prevent undesirable developments. Further, from a political point of view this might also make the chance of timely introduction of controls somewhat greater than of abrupt measures; experience with mechanisms already in operation (including inflation corrections in wage agreements and tax rates) is, however, not completely reassuring.

Secondly, the behaviour under control is, generally, less sensitive to erroneous initial estimates and unforeseen developments, because the *real* development is always compared with the *desired*.

These considerations render control studies indispensable. At the same time it is of importance to investigate in what ways one would have to control in order that the behaviour of the model develops optimally in accordance with different criteria, not because this would yield exact prescriptions for society, but because it may lead to valuable insight, not in the least into the consequences the various criteria bring about!

4.5 The Report of the Club of Rome

The reader may ask himself to what extent the foregoing interferes with the ideas and conclusions developed in *Limits to Growth*.

In the first instance the answer is: "Not at all, for the present interim report is wholly based on Forrester's model *World2*, and the Report of the Club of Rome on Meadows' model *World3*".

In the second instance, several observations can be transferred to *World3*, although in the form of suppositions still to be verified and with the necessary reserve. In *World3* several of the improvements mentioned in Section 4.1 have apparently been introduced to a greater or lesser degree, while there are also indications that more thought has been given in terms

of control and of allocation of investments. Further, sensitivity analyses have been carried out. However, comparatively little attention seems to have been given to acquiring insight into the system, to defining possibilities of correction and criteria, and to controls.

With regard to this first and simple world model the Club of Rome is *exclusively* interested in the general forms of behaviour; for instance, in the question: does a certain quantity continue to grow, or decrease, or does it show a maximum, a minimum, or a fluctuation?

Our findings with respect to *World2* leave no room for doubt as to the following points:

1. Unlimited growth of the population and prosperity is impossible.
2. What form of behaviour *will* occur is certainly not to be foreseen if the various sectors are not studied in mutual interaction and by means of a mathematical model. In fact, the studies based on *World2* clearly demonstrate that the mutual interactions can, in certain circumstances, cause unforeseen developments, and that the occurrence of surprisingly rapid changes is possible.
3. In the model studies referred to, such developments, if they occur at all, mostly take place between 1980 and 2080.
4. The inescapable conclusion from the three preceding points is that the message of the Club of Rome must be studied seriously and thoroughly.

The statements mentioned above may not be reversed. For example, from the second statement one may not deduce that the form of behaviour should be predictable with certainty if one *does* work with a mathematical model. This depends on its reliability.

Therefore, no unlimited growth, but what behaviour *is* realistic? *World2* does not give sufficient certainty of that, neither does *World3* yet, probably. It is even not certain if one will ever succeed in constructing a sufficiently complete model. But it appears necessary to take existing mechanisms of adaptation ("elasticities") better into account, such as the effect of recycling and substitution of materials. These might lead to a model showing a more even behaviour. However, against this must at once be set the fact that *World2* and *World3* recognise only one population, one raw material, and one kind of pollution, and that, for example, the introduction of distinctions between the rich and the poor parts of the world may lead to far more alarming results.

Conclusion: our knowledge is far too slight yet and we have no generations of time to live in order to become wiser. It is, therefore, necessary to work hard, soberly and objectively on the improvement of models and model studies. To attain this end, appropriate international coordination and experimental verification are indispensable.



* See Limits to Growth, p. 91.

LITERATUREReferences

1. J.W. Forrester,
World Dynamics.
Wright-Allen Press Inc., Cambridge, Massachusetts, 1971.
- 2a. D.L. Meadows,
Preliminary Draft, Phase One, Dynamics of Global Equilibrium.
Prepared for Club of Rome Meeting, April 4-6, 1971, Canada.
- 2b. D.L. Meadows c.s.,
The Limits to Growth: A Global Challenge.
Preliminary Draft of Report of the Club of Rome, July 9, 1971.
- 3a. D.H. Meadows, D.L. Meadows, J. Randers, W.W. Behrens,
Limits to Growth.
Potomac Associates/Universe Books, New York, 1972.
- 3b. D.L. Meadows c.s.,
Rapport van de Club van Rome (Dutch version of ref. 3a).
Het Spectrum N.V., Utrecht, 1972.
4. P.M.E.M. Van der Grinten, P.J. De Jong,
Werelddynamica gezien vanuit de systeem- en regeltechniek.
(World dynamics as seen from the point of view of systems- and control-
engineering).
Chemisch Weekblad (1971-12-10)9-11.
5. P.M.E.M. Van der Grinten, P.J. de Jong,
Werelddynamica, uitgangspunt voor een wereldbeleid?
(World dynamics, a basis for a world policy?)
Chemisch Weekblad (1972-03-10)9-11.
6. Redactie Chemisch Weekblad,
Milieu. Het is nog niet te laat.
(Environment. It is not yet too late).
(Editorial based on results furnished by Van der Grinten and De Jong)
Chemisch Weekblad (1972-03-24)5.
7. Drs. F. Muller,
Mythen rond de modellen van Forrester en de Club van Rome.
(Myths surrounding Forrester's model and the Club of Rome).
Economisch Statistische Berichten (72-04-12)356-360.
8. J.G.M. Cuypers, O. Rademaker,
Verschillen tussen wereldmodellen: een wereld van verschil?
(Differences between world models: a world of differences?).
Report on a controversy between refs. 4-6 and ref.7. See U5.

Additional Literature

- P71-01* J.W. Forrester,
Counterintuitive Behavior of Social Systems.
Technology Review (Jan. 71).
- P71-07 Club van Rome Nederland, Bulletin nr.1,
Club van Rome Nederland, Den Haag (Dec. 71).
- P72-01 De wereld als systeem (symposium),
(The world as a system).
Wiskundige Studievereniging T.H.Delft (March 8-9, 1972).
- P72-02 E.J. Tuininga,
Rapport van de Club van Rome; Het concept, de kritiek daarop
en de definitieve versie.
(Limits to Growth, draft report, criticism and final report).
De Ingenieur, 84 (March 1972)11, p.A216-220.
- P72-03 Club van Rome Nederland, Bulletin nr. 2,
Club van Rome Nederland, Den Haag (February 1972).
- P72-04 E.F. Boon,
Industry's Responsibility towards Pollution,
De Ingenieur, 84 (February 1972)5, p.A93-97.

WRITINGS OF THE PROJECT GROUP

With a view to making the activities of the work group available to outsiders as effectively as possible, a complete list of all notes, papers, articles, etc., produced is given below.

Informal Notes (ALL IN DUTCH)

In the Global Dynamics project a number of persons and groups are involved widely spread geographically. It is frequently desirable to inform a number of people about ideas regarding the set-up of a particular study, intermediate results, tentative conclusions, hypotheses, comments on a publication, conclusions or minutes of discussions and conferences, etc. An important role in the realisation of this exchange of information is played by the "Informal Notes", which are drawn up and distributed rapidly and readily, and to which one can react rapidly and readily by means of new I-notes. For the sake of complete reporting, all I-notes are mentioned below; a number in brackets denotes that the note has in the meantime been replaced by a newer version, or that it has been withdrawn by the author, or that it is of such a nature as to be irrelevant for an outsider without the addition of an extensive explanation.

- (I0) (72-01-10) Van der Grinten
Lecture notes.
- (I1) (72-02-12) Rademaker
Initial plan of studies and actions by the Project Group.
- (I2) (72-02-12) Rademaker, Van der Grinten
Proposal for the studies of the world models of the Club of Rome/M.I.T.

- * Identification number in the filing system of the Eindhoven University of Technology Measurement and Control Group.

- (I3) (72-02-18) Voskamp/Timmermans
Research notes regarding the dynamic optimisation of the simplified DSM world model.
- (I4) (72-02-23) Van der Grinten/De Jong
World dynamics, a basis for a world policy?
- (I5) (72-02-27) Cuypers
Schemes of dependences and analog computation scheme of World3.
- (I6) (72-02-29) Cuypers
Notes of discussion concerning the simplified DSM model with Ir. P.J. de Jong (D.S.M.).
- I7 (72-01-03) Cuypers
Project world dynamics. Minutes dynamic optimisation meeting 1973-03-01.
- (I8) (72-03-03) Thissen
Explanation of the analog scheme of World2.
- (I9) (72-03-07) Rademaker, Cuypers
About correcting variables.
- I10 (72-03-07) Hautus
Alternative description of the system.
- (I11) (72-03-07) Van der Grinten/De Jong
Consequences of delayed application of feedback control.
- (I12) (72-03-10) Chermin
System equations (analytical approximations).
- (I13) (72-03-13) Rademaker
Proposal concerning the introduction of correcting variables into World2.
- (I14) (72-03-13) Rademaker
Transformation of Forrester's model.
- (I15) (72-03-14) Cuypers
Minutes of a meeting of the THE simulation group with Ir. P.J. de Jong (D.S.M.).
- I16 (72-03-15) Chermin
World dynamics.
- (I17) (72-03-13) De Jong (D.S.M.)
World dynamics.
- I18 (72-03-17) Thissen
Possible simplifications of World2.
- I19 (72-03-20) De Jongh
Sensitivity analyses of the DSM model.
- I20 (72-03-20) De Jongh
Elimination of the state variable POLR.

- (I21) (72-03-23) Voskamp
Some remarks and suggestions in connection with Professor Rademaker's note I13(72-03-13).
- I22 (72-03-13) Rademaker
Possible subjects of study.
- I23 (72-03-23) Zwietering
Transformation of variables in dynamic programming.
- I24 (72-03-27) Rademaker
Questions raised by Forrester's book "World Dynamics".
- (I25) (72-03-28) Timmermans
Some remarks concerning the introduction of correcting variables in World2.
- I26 (72-03-26) Rademaker
Improvements of Forrester's flow diagram and differences with the scheme used at first by Meadows.
- I27 (72-02-16) Rademaker
A playful note of reservation in connection with the Project Global Dynamics.
- I28 (72-04-04) Cuypers
Minutes of meeting of subgroup dynamic optimisation on 1972-03-29.
- I29 (72-03-06) Thissen
Survey of the various symbols and abbreviations used in World2.
- I30 (72-03-15/72-04-07) De Jongh/Rademakers
Corrections of the simplified model of World2 (the DSM model) published by Van der Grinten and De Jong.
- (I31) (72-04-09) Rademaker
Verification of the DSM model.
- I32 (72-04-10) Rademaker
Questions about the results of World2-calculations published by Forrester and Meadows.
- I33 (72-04-10) Cuypers
The partially-linearised World2.
- I34 () Cuypers
Analysis of World2 by complete linearisation.
- I35 (72-04-10) De Jong (D.S.M.)
Sensitivity of the World2 model.
- I36 (72-04-12) Cuypers
Comparison between the NC-model and the DSM-model.
- I37 (72-04-13) De Jong (D.S.M.)
Response to I30 with reference to the original aims of the DSM analog model.

(I38) (72-03-17) V.d. Loeff
Program and results of digital calculations
Issued by a working party at Groningen University; address: Prof.dr.
Ph.B.Smith, Natuurkundig Laboratorium, Westersingel 34, Groningen.

I39 (72-04-13) Thissen
Response to I24.

Papers, non-periodical reports and other publications

- (U1) (72-02-12) Rademaker
World Dynamics Project.
- (U2) (72-08-18) Rademaker
Draft request for partial funding by Z.W.O.*
- (U3) (72-03-23) Rademaker
Request for partial funding by Z.W.O.
- (U4) (72-03-19) Rademaker
Information about the Project Group Global Dynamics.
- (U5) (72-05-10) Rademaker, Cuypers
Differences between world models: a world of differences?
Report on a controversy between refs. 4-6 and ref. 7.

Notes on procedures and methods of working

- (W1) (72-03-10) Rademaker
Documentation procedure Project Global Dynamics.
- W2 (72-03-10) Rademaker
Filing procedure Project Global Dynamics.
- W3 (72-03-24) Rademaker
Documentation procedure Project Global Dynamics.



* Netherlands Organisation for the advancement of pure research.

APPENDIXSOME NOTES ON FORRESTER'S MODEL

1. Of the statistical character of many quantities no account has been taken.
2. Very many different quantities have been aggregated into relatively few state variables (there is one kind of natural resource, one kind of pollution, one kind of capital investment, and one birth rate, all for rich and poor countries together).
3. All functional relations have been represented extrapolatable and reversible; as most of them have been borrowed from a period of growth, the question arises whether they also apply in the case of recession (hysteresis).
4. All non-linear functions are represented as sectionally-linear functions. The model's behaviour is so extremely sensitive to a number of these functions, particularly in the sectors Natural Resources, Capital Investment and Pollution, that widely different results are obtained if they are replaced by smooth analytical functions fitted as well as possible to the points specified by Forrester.
5. In a number of runs, the input variables of certain functions exceed the range over which the functions are specified. DYNAMO then keeps the value of the output equal to the nearest end-value of the function. This has drastic effects on the model's results. If, for example, the pollution generated per head is extrapolated linearly ($POLCM = 2CIR - 1$ for $CIR > 1$) which according to Forrester may be a plausible assumption, the population can no longer recover at all after a pollution crisis.
6. Certain dynamic processes have been greatly simplified, probably owing to the fear (not always justifiable) that simulation might otherwise become too difficult or impossible.
7. No sensitivity analysis has been applied, although Forrester did point out its importance.
8. Little effort has been made to arrive at deeper insight into the structure and inner workings of the system as a whole; the interpretation of the results thus remains too much on the surface.
9. No realistic possibilities of correction have been introduced (i.e. variables with which the behaviour might be controlled).
10. In certain instances, the change of a coefficient is interpreted as a real-world action. For example, the normal rate of natural resource usage is reduced from 1 to $\frac{1}{2}$ from 1970 onwards and the model's behaviour is shown to be very 'counterintuitive': while far less resources are extracted, the material standard of living soars to enormous heights! The explanation is that nowhere the costs of such a reduction in resource usage are accounted for. Hence the results represent the effect of a cheap change in a coefficient and should be interpreted in terms of sensitivity analysis. To discuss the behaviour as if it were the result of a measure is misleading, for the results are counterrealistic rather than counterintuitive.

11. Hardly any use has been made of control engineering knowledge. The prospects of feedback controls have not been investigated, although it should be known that
 - a. they are almost indispensable if a system is unstable or weakly stable;
 - b. they lend the whole a behaviour that is less dependent on the - imperfectly known - characteristics of the non-regulated system;
 - c. they may lead to more gradual corrections and to a smoother behaviour of the controlled quantities. This is in itself extremely desirable, if only for the reason that science and the art of government are then in a better position to prevent undesirable developments, and because man assimilates gradual changes better. This is an additional reason why in political respect the prospects of feedback controls rather than sudden, rigid changes might be greater, which in itself might be a decisive argument.
12. Not only the presence of statistic variations but also the knowledge concerning the behaviour and control of systems having a statistical character have been ignored.
13. It has not been investigated where attempts at improving the model's behaviour by dynamic optimisation lead to.



V2(1972-12-31)Rademaker, Cuypers

PROJECT GROUP
GLOBAL DYNAMICS
PROGRESS REPORT No. 2





*On n'a pas besoin d'espérer
pour entreprendre
ni de réussir pour persévérer*

WILLIAM OF ORANGE



PREFACE

This second report of our Project Group is arranged differently from its predecessor, chiefly because all kinds of things which in the previous report (V1)* had to be set forth for the first time, need not be explained again, but also because we are now concerned with two different world models, the one of FORRESTER and that of MEADOWS *et al.*, which are denoted by WORLD2 and WORLD3, respectively. Moreover, a separate section entitled *Summary and Supplements* this time seemed less essential in view of the nature of the activities, and the fact that most readers will by now be familiar with *Limits to Growth* (2), (at least with Chapters III and IV).

We shall, therefore, devote this Preface to a number of general subjects and then, in three sections, report on the Group's activities (Introduction, World2, World3), and, finally, furnish supplementary information in the Appendices on: A. Members of the Group, B. Lectures, Congresses, etc., C. Literature, and D. Writings of the Project Group.

First some notes regarding activities and events elsewhere in the world. Dutch readers are referred first of all to the information contained in the Bulletins of the CLUB OF ROME NETHERLANDS (3)** . As an addition, it is mentioned here that since the publication of *Limits to Growth*, a flood of responses has come forward, especially in the American and British Press. The Dutch version, *Rapport van de Club van Rome*, has sold many more copies than the original version, and has raised a great amount of discussion, which has given many people in this country the impression that the response in the Netherlands is far and away greater than anywhere else. However, in fairness, an accurate count would probably reveal that *Limits to Growth* has evoked many more responses - in total as well as per copy - than its Dutch translation. Therefore, it is very instructive to study the responses in English publications, however one-sided or biased many of them may be; an excellent summary of the American responses accompanied by a fairly comprehensive bibliography has been made up by Dr. S.H.Begeman, Scientific Attaché of the Netherlands Embassy in Washington, D.C. (4).

Apart from numerous reactions, the Report has stimulated numerous actions: in many places people are diligently studying and calculating. In fact, that was the intention of the Club of Rome. Therefore, it is remarkable that the Club does not yet seem to do anything about international coordination of these spontaneous activities; a list of groups who are working on the subject - something that might prevent much needless duplication and might promote valuable international contacts and cooperations -

* See list of publications in Appendix D.

** See Appendix C.

is the least one might expect of the Club*.

Meanwhile, we owe to Dr. Begemann's efforts a summary of the groups who occupy themselves with the problems in the U.S.A. (4), while we try to form an idea of the British activities with the help of the group of Professor Rosenbrock (University of Manchester). In this country the foundation Maatschappij en Onderneming (Society and Enterprise), which also took the initiative in forming the work group Toekomst (Future) (see previous report p. 4), has undertaken the function of national "letterbox" (Koninginnegracht 98, Den Haag), and to call together from time to time those who are active in this field. The Foundation is also preparing a publication in which a concise summary will be given of the activities in process in this country. The most important new activity is undoubtedly the follow-up project to be carried out under the guidance of Professor H. Linnemann and Professor J. Tinbergen. Our project group hopes to provide an essential contribution and is prepared to adapt its program drastically. The first contacts have been made and there is every reason to expect that a fruitful cooperation will grow between the two groups.

Our Project Group has, in the meantime, not been idle; on the contrary, the various activities have gone so fast that this report is published far later than intended. When considering Appendix A (*Members of the Group*) it will appear that the composition of the group has undergone some changes. As our Project Group presents itself in this report exclusively as a *team*, we will not mention names here but restrict ourselves to thanking for their contributions those who have withdrawn, and extending a hearty welcome to those who have joined. It is with feelings of deep gratefulness that we mention here that the Nederlandse Organisatie voor Zuiver-Wetenschappelijk Onderzoek (Netherlands Organisation for the advancement of pure research, Z.W.O.), whose interest in Global Dynamics has stimulated us from the first, has complied with our request referred to earlier (VI-p.17), which has enabled the group to be strengthened by a full-time member exactly at the moment at which he was most needed. This gentleman occupies himself particularly with the dynamic optimisation studies.

Our Project Group enjoys great and steadily increasing interest. The number of copies of the first report (1000) appeared to be too small; a second impression has already been issued. The informative conference on The World of Forrester (see also Section 2.4) drew a packed audience and led to so many enthusiastic reactions and requests to hold the conference again that it will be repeated on 5th January, 1973, a date which offers teachers and pupils of various types of secondary schools the opportunity to attend. Appendix B (*Lectures, Congresses, etc.*) tells of the many other lectures given and of the variety of the audiences.

In conclusion, a few remarks regarding our most important plan in this sphere. As soon as the definitive text of the Technical Report on World3 has been published by Meadows et al., we would like to organize three conferences; one dealing with the population sector, one with the agricultural sector, and one with the production sector. On each occasion we might give an exposition about the set-up of the model of the relevant sector and our insight into its behaviour.

* The necessity of international coordination - or at least: information - applies with greater force because in fields interwoven only *partially* with it activities *are* displayed, which might lead to chaotic developments and even disagreements about competence.

Then, in the afternoon we would like to exchange views with specialists in the field concerned regarding the model used, possible or desired improvements, necessary further studies, and so forth. Such discussions would not only teach the participants a great deal in a nutshell, but it is also hoped that they may lead to the formation of one or more new project groups to do things outside *our* competence, viz. go deeper into the motivation and the construction of the models.

Experience has taught that an attempt as described above will only have a chance of success if the group concerned is not too large and as competent as possible for the subject in question. This implies that attendance to these conferences will have to be by invitation. Dependent on the results, it will be considered whether large-scale informative conferences will also be organized concerning *World3*. In any case we hope to be able to inform you about the results in the next Report of our Project Group Global Dynamics.



CONTENTS

1. Introduction
2. Forrester's model
 - 2.1 Insight into the model and understanding of its behaviour
 - 2.1.1 Natural resources and capital investment sector
 - 2.1.2 Pollution sector
 - 2.1.3 Population sector
 - 2.1.4 Agricultural sector
 - 2.1.5 The system as a whole
 - 2.1.6 Final remark
 - 2.2 Effect of optimizing control
 - 2.2.1 Models and criteria
 - 2.2.2 Methods and results
 - 2.2.3 Plans
 - 2.3 Methods and techniques
 - 2.4 Evaluation and information
3. The model of Meadows (World3)
 - 3.1 Comparison of World3 with World2
 - 3.1.1 State variables
 - 3.1.2 Nonrenewable natural resources and capital sector
 - 3.1.3 Agricultural sector
 - 3.1.4 Pollution sector
 - 3.1.5 Population sector
 - 3.1.6 Final remark
 - 3.2 Insight into the model and understanding of its behaviour
 - 3.2.1 Behaviour of the quantities
 - 3.2.2 Main relations between sectors
 - 3.2.3 Effect of delays
 - 3.2.4 Population sector
 - 3.3 Correcting variables
 - 3.4 Effect of stabilizing control
 - 3.5 Methods and techniques
 - 3.6 Evaluation and information

Appendices:

- A. Members of the group
- B. Principal lectures, congresses, etc.
- C. Literature
- D. Writings of the project group
- E. Further explanation of Figure 1.



REPORT ON THE ACTIVITIES

1. INTRODUCTION

This second report covers the period from 15th April 1972, when Professor Meadows handed to us a preliminary version of the Technical Report to the Club of Rome (5), up to and including 31st December, 1972. In August, during a course in System Dynamics at Hannover (Germany), we were given a copy of a second and revised concept of the Technical Report (6), the official publication of which is expected early in 1973.

The activities reported on in the present report refer on the one hand to the continued study of the world model of Forrester, called "WORLD2", and on the other to the incipient study of the world models of Meadows, which are collectively denoted by the term "WORLD3".

As regards the development of the techniques of analysis and the acquirement of insight into structure and behaviour, the work on World2 has been given a conclusive character. The optimizing studies will for the time being be continued on the basis of a simplified version of this model.

Work on World3 has been started using several kinds of approach simultaneously and the experience gained while working with World2 has already proven to be particularly valuable. Therefore we expect to round off the first and most important phase of the investigation in the course of the first half of 1973.

For convenience, the list of action items is given below in a few words (further see VI, p.5):

1. *Insight into the model and understanding of its behaviour.*
2. *Sensitivity analysis.*
3. *Effect of Dynamic Improvements.*
4. *Correcting variables.*
5. *Effect of Stabilising Control.*
6. *Effect of Optimising Control.*
7. *Methods and Techniques.*
8. *Evaluation and Information.*

Evidently, all these items were not given equal attention; a couple of items, notably Nos. 2 and 3, will not be discussed at all in this issue.

Important

When writing this report it has been assumed that the reader has been able to form a good picture of the Project Group and its activities by reading the first report (VI of 1972-04-23), in particular as regards:

- | | |
|---|-------------------|
| ● Name of the Project, | Section 1.2 |
| ● What went before, | 1.1 |
| ● Reservation and Doubts, | 1.3 |
| ● Intentions (Program of Activities), | 1.2 |
| ● Organization and Mode of Working, | 3 |
| ● Accomplished Activities, | 2 |
| ● Marginal Notes to Forrester's Model, | Appendix |
| and remembers, at least vaguely, a few concepts and denominations, as | |
| ● the restricted meaning of a model, | Section 4.2 |
| ● possibilities of correction, | 1.2.4, 2.4, 4.3.1 |
| ● stabilising control, | 1.2.5, 2.5, 4.4 |
| ● optimising control and criteria | 1.2.6, 2.6, 4.3.2 |

The section numbers indicate in which sections of VI the essentials are to be found. Further, VI contains the first list of writings of the Project Group and other publications.

In the Preface of our previous report we wrote: *"It is a risky enterprise to write a report for such a wide and very diversified circle of persons interested, particularly on the subject of Global Dynamics. What has too little nutritive value for an insider may be all but indigestible for someone else"*. We are aware that this applies equally to the text below, for example, where optimizing studies or computing techniques are discussed, but we hope that the insiders will ask for further information (the accompanying notes are listed in Appendix D) and that the less conversant readers are prepared to wade through such parts or skip them, backed by the thought that we have done our best to write the text so that the thread can be picked up again at as many points as possible. However, criticisms, comments and suggestions for improvement will be very thankfully received.



2. FORRESTER'S MODEL

2.1 Insight into the model and understanding of its behaviour

As mentioned in the previous report, the study of the structure of the model and the way in which the various components operate and affect each other leads to a number of interesting findings. In connection with the work on World3 this study has been restricted mainly to the behaviour in more or less normal (standard-run) conditions. As this is probably the last report in which World2 is discussed in some length, we shall try to summarize the findings, including those that have been reported on before.

2.1.1 Natural Resources and Capital Investment Sector

One of the most interesting findings of the studies is that the natural resources and capital investments sector is almost completely independent of the rest of the system. Although in the original model the population acts on this sector in three different ways, it can be shown that these three influences counterbalance each other almost completely, so that the influence of the population on this sector virtually ceases to exist. Calculations have shown that with respect to this sector it hardly matters whether the world population is increased or decreased by 1000 million from 1970 onwards. The only other external influence acting on this sector is the fraction of the capital invested in agriculture which is of little or no consequence either, because it is virtually constant during the standard run.

These observations have rendered the model of this sector so simple and clear that it has become evident that it can normally show but one single mode of behaviour viz. the quantity of natural resources (NR) can only decrease continuously and the capital investments (CI) may at first rise for some considerable time, but is bound to decrease eventually because the natural resources run out and the model knows of no recycling or substitution. Further analysis has revealed that the possible developments of the model of this sector are determined by only one parameter (τ) which contains, among other things, the initial values of the natural resources (NRI) and the capital investment (CII) in 1900; in other words, under certain, somewhat simplifying conditions**, a single set of graphs is capable of representing all possible developments according to the model of this sector, see Figure 1. In this diagram, time is represented along the abscissa (the unit of time being the discarding period of the means of production $1/CIDN = 40$ years), while the capital investments and the amount of natural resources appear along the ordinate, the latter on a non-linear scale. What particularly strikes the eye is that the period in which the phenomena take place strongly depends on the choice of the initial values. If, for example, the initial estimation of the capital investments had been twice as large and that of the natural resources twice as small as in the standard run, the peak of the capital investments would not appear until *after* 2100, i.e. outside the time interval usually considered! If, however, the errors in the initial estimations had lain in reverse, the peak value would be reached at a far earlier date, while the developments would have been far more gradual. These results are particularly important because this sector is, as it were, the power station of the whole model (See 2.1.3 and 2.1.5). Since CI ultimately

* This influence we call the Agricultural Correction Factor (AC), because it determines what part of the capital investments remains for non-agricultural production. For insiders: $AC = (1 - CIAF)/(1 - CIAFN)$.

** See further Appendix E.

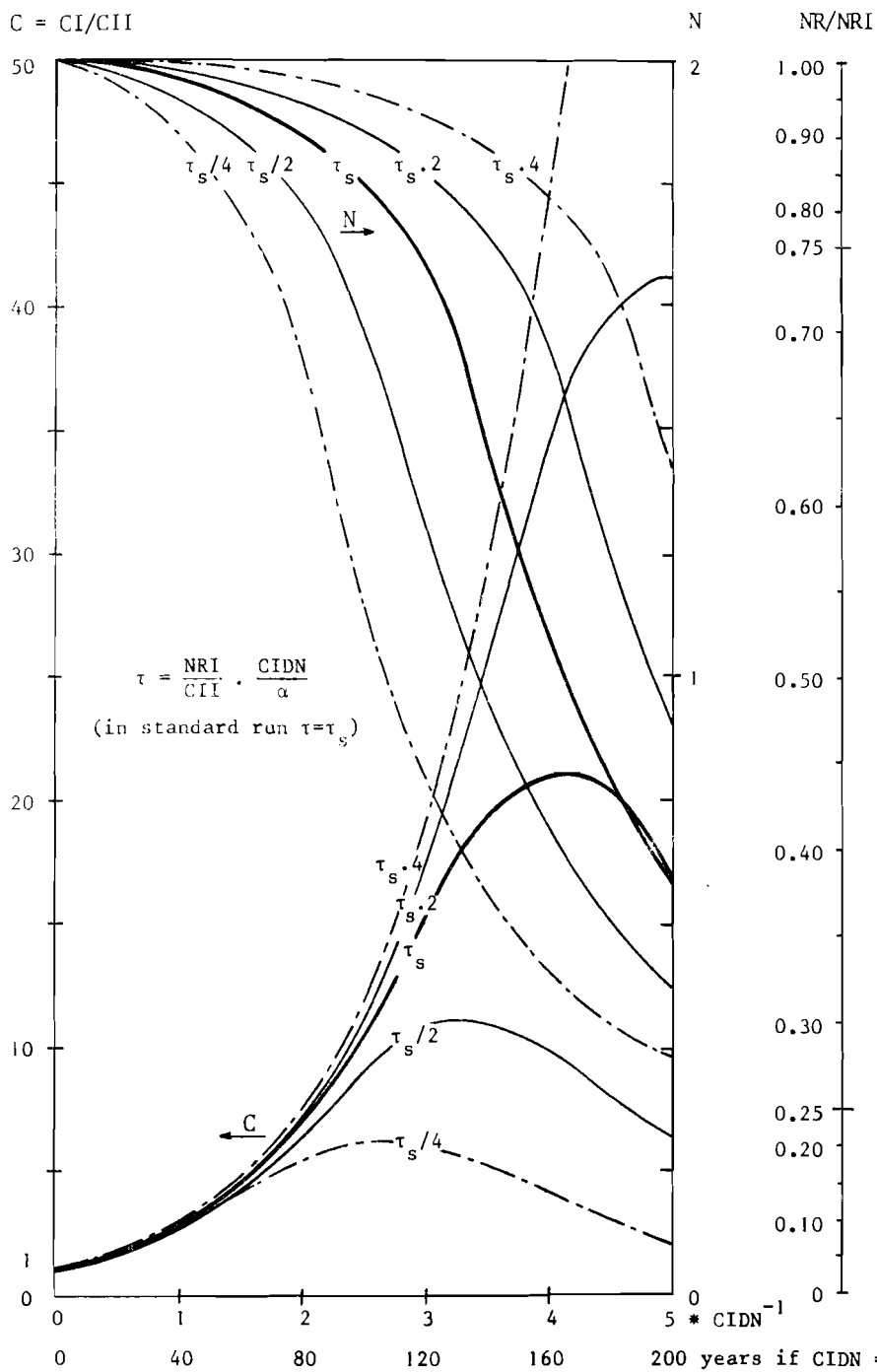

Figure 1

Characteristic solutions NR and CI sector (see further Appendix E).

approaches zero, population, pollution, and other quantities in the model are ultimately bound to approach relatively small values, if not zero, as well!

When considering the statements above, it should be borne in mind that a strong growth of the production capital may bring about reactions in the pollution sector and the population sector that may invalidate the correctness of the assumptions put forward above. As an illustration, Figure 2 shows the result of a calculation with the complete model, starting from a doubled level of natural resources in 1900. In this calculation the enormous pollution affects the production of food to such an extent as to require greatly increased investments in agriculture; hence AC is no longer constant and Figure 1 does not apply. However, whether pollution really runs out of hand to such extremely high values or not depends critically on certain details of the model of the pollution sector.

2.1.2 Pollution Sector

It was found possible to represent the model, without introducing any additional assumptions or simplifications, in a way which shows at once what modes of behaviour the pollution sector may have and how these are defined by the model's assumptions. In particular, it has become clear that the relationships introduced by Forrester act in such a way that, at low investments per head of the population, the system recovers its balance fairly rapidly at a fairly low level of pollution (lower than ten times the level in 1970), but that, when the production per head exceeds a certain level, the system must, as it were, flip over to extremely high degrees of pollution. Here applies what applies to the natural resources and capital investment sector, viz. that the behaviour of the pollution sector lies, so to say, anchored in the model and can be made very clear, and further that it is extremely sensitive to the assumptions on which the model is based. The behaviour is particularly sensitive to the relationship assumed to exist between the degree of pollution attained and the natural power of regeneration*. In the case of the relationship assumed by Forrester any measure that causes the capital investments to outgrow the population by more than a certain amount, cannot but lead to an enormous pollution peak; in this connection a rule of thumb is: as soon as the capital investment divided by its value in 1970 exceeds two plus half the population density (with respect to 1970), then pollution becomes uncontrollable (U11).

2.1.3 Population sector

The most surprising result of our investigation undoubtedly is that a natural instability of the size of the population in Forrester's model is out of the question, in other words: in it the population does not in itself have the inclination, so notorious and much discussed, to grow more or less exponentially.

To avoid misunderstandings it is desirable to discuss the concepts *positive feedback* and *negative feedback*, used so often to elucidate the behaviour of world models. Briefly (and therefore not *quite* rigorously) formulated one can say: every path, every chain of influences, along which a state variable promotes (influences *positively*) its own speed of growing adds a *positive* feedback, and every path along which the variable's own growing speed is restrained (influenced *negatively*) contributes a *negative*

* As has been observed before; see, for example, reference 4 given in VI.

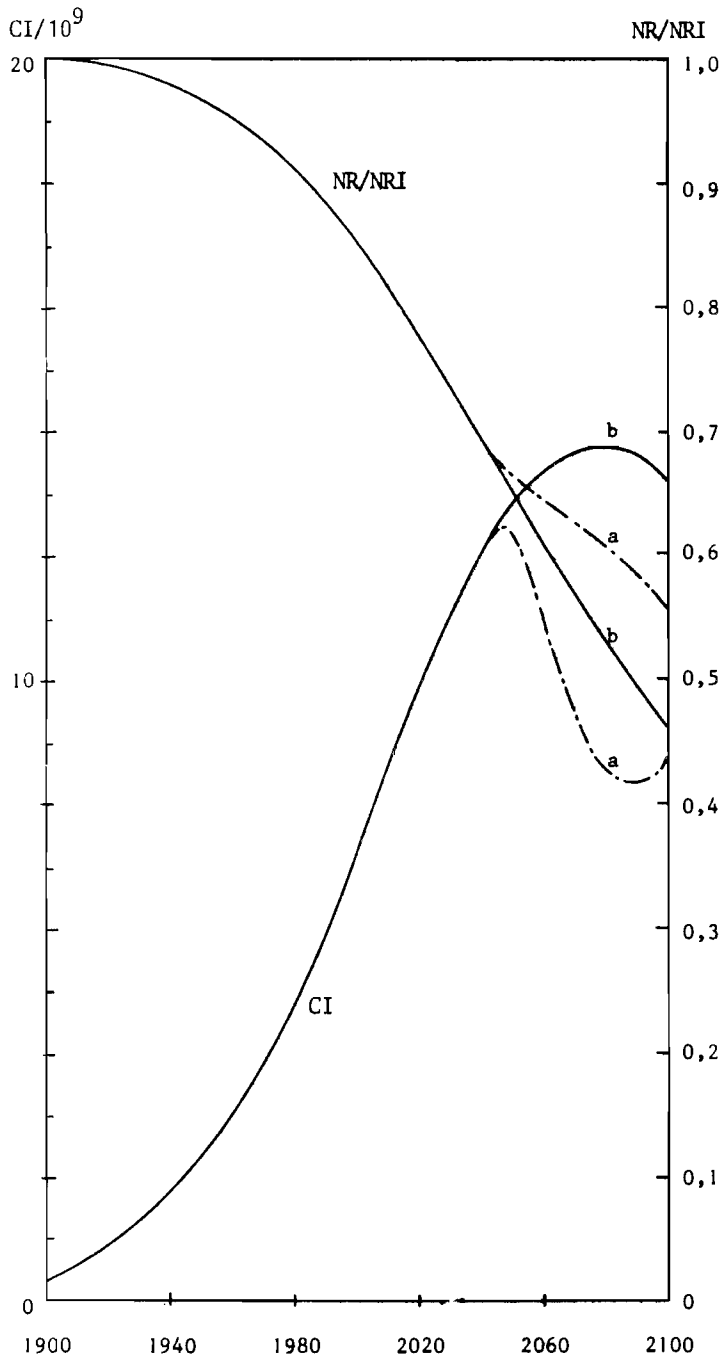

Figure 2

Results if initial value of natural resources (NRI) is twice Forrester's:
 a. original pollution model; b. pollution limited to ten times its value
 in 1970 (see also Figure E-3 in Appendix E).

feedback. Consequently, the larger a state variable the more it promotes its own growth in the case of positive feedback, and the more it restrains in the case of negative feedback*.

If the positive feedbacks dominate the negative, the notorious and much-discussed exponential growth may occur. Thus the growth of the capital investments from 1900 to some considerable time after 1970 can be explained from the fact that the investments surpass the discards for a long time. And thus the similar growth of the population in the World of Forrester is likewise explained in many publications**. But is this correct? Does it not turn the rule that domination of the positive feedbacks may create exponential growth, into the proposition that from the exponential growth of a state variable it must be concluded that the positive feedbacks are dominant?

Further investigation has revealed that the negative feedbacks are stronger than the positive; more than that: the population appears to follow the production of goods and services with a lag. That it seems to grow more or less exponentially at first is, therefore, not an inherent property of the manner in which the population influences its own growth, but is induced by the more or less exponential growth of the capital investments. To prove this, Figure 3 shows the result of a simulation in which the capital investment (CI) has been held constant as from 1970; it is seen that the population then no longer shows any inclination to continue growing, but stabilizes in a comparatively short time. Moreover, pollution remains at a low level. From this it can be clearly seen how CI acts so to say as the power station of Forrester's World. It is the growth of capital that causes here the growth of population and pollution; if this capital growth is stopped, population and pollution come to a standstill. The proposition of the Club of Rome that no result may be expected from a single measure in only one sector does not apply to Forrester's World***. For completeness, it may be added that stabilization of the population is chiefly brought about by the death rate increasing rapidly as the given production has to be apportioned among more people.

2.1.4 Agricultural Sector

Little attention has been given to this sector so far because it hardly varies in the standard run.

2.1.5 The System as a Whole

Valuable insight into the main structure of the system as a whole has further been gained by deriving a fully linearized model (LINC model, see VI, p. 12) starting from the situation in 1970. This has not been done for the purpose of carrying out calculations with it - although this simple model represents, as demonstrated by Figure 4, the standard behaviour to within the next century reasonably well - but because this type of model lends itself so excellently for drawing conclusions with respect to main points and details of structure and behaviour. On the basis of this simple model a number of working hypotheses have, therefore, been set up, which have been tested by calculations with the original model.

This study confirmed that only the capital investment has positive feedback, i.e. that from 1900 to a considerable time after 1970 it grows more or less exponentially, and that the population, as also all other state variables have a net negative feedback, in other words, they have no inherent inclination

* This can be formulated so simply, because the state variables can never be negative and because their equilibrium value is small if not zero.

** Forrester himself has chosen his formulations with respect to this subject far more carefully than most commentators.

*** In this respect the model of Meadows et al. seems to react differently. For the rest it seems sensible to assume, for the time being, that the proposition referred to does apply to the real world.

SCALE VALUES : P: 10^{10} , CI: 10^{10} , POL: $36 \cdot 10^9$, NR: 10^{12}

P Population
 CI Capital Investment
 POL POLLution
 NR Natural Resources

----- Standard run
 ——— Behaviour for CI constant as of 1970

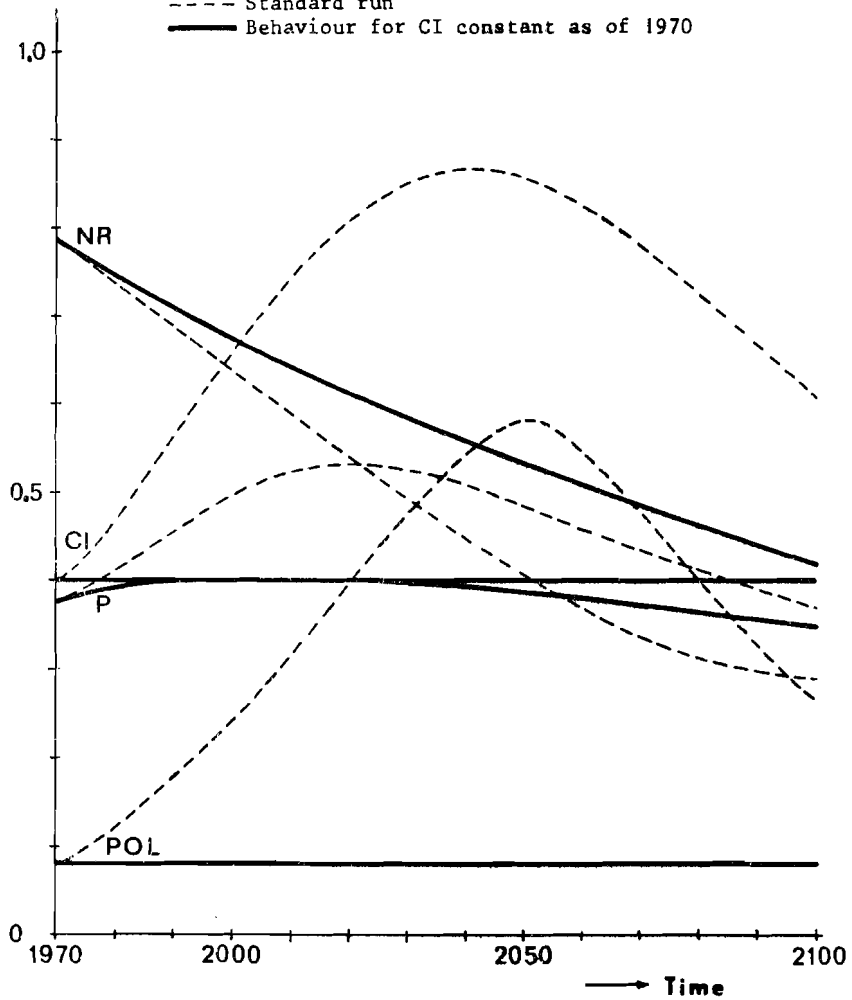

Behaviour of World Model if Capital Investment CI is frozen as of 1970

SCALE VALUES : P: 10^{10} , CI: 10^{10} , POL: $36 \cdot 10^9$, NR: 10^{12} .

P Population
 CI Capital Investment
 POL POLLution
 NR Natural Resources

----- Standard run
 ——— Results of LINC-model

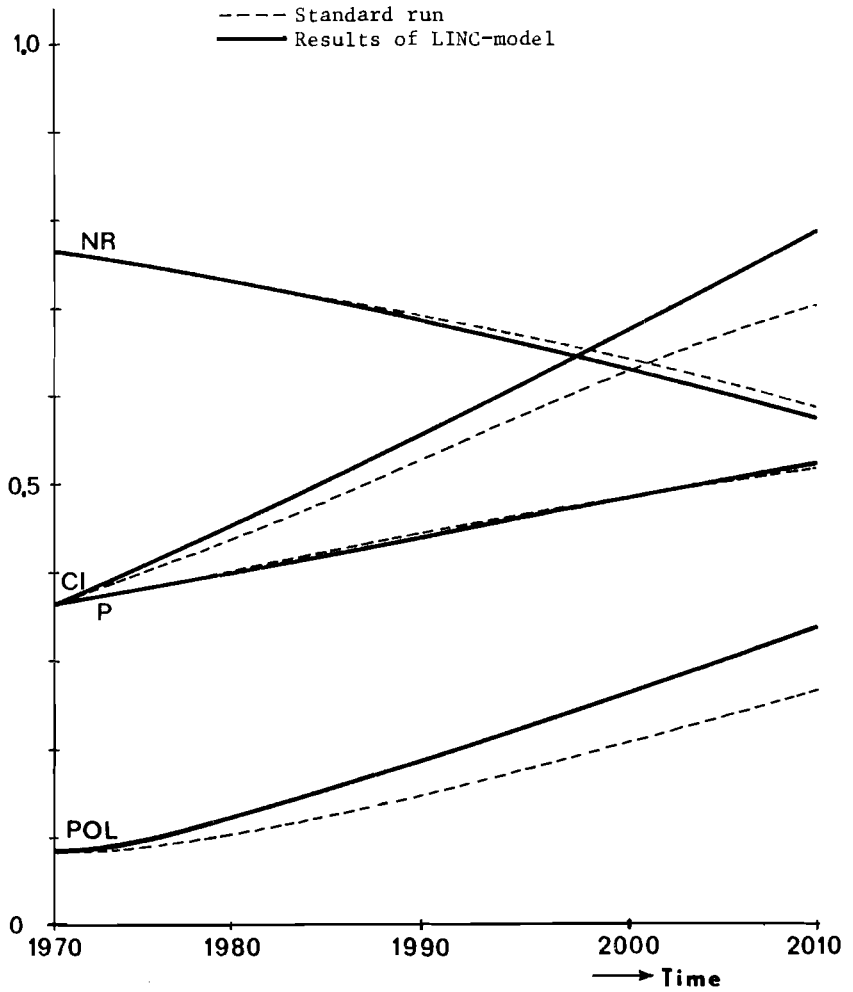

Figure 4

to exponential growth (*U9*)*. The more or less exponential growth of population and pollution from 1900 to after 1970 is, indeed, not brought about by an inclination to growth within these sectors themselves, but because they are, so to speak, "driven" by the more or less exponentially growing production.

This study, too, leads to the conclusion that the natural resources and capital sector form an almost autonomous sub-system; further, that the population sector is almost exclusively dependent on capital investment, whereas the pollution sector on the one hand and the agricultural sector on the other are influenced almost exclusively by investment and population.

Thus it appears that in Forrester's model there is a certain hierarchy which is clearly recognizable in the block diagram of Figure 5. For completeness, a few arrows have been drawn in dotted lines to indicate influences that may be almost ignored in the rest of this century but which in the next century have yet some influence on the model's standard behaviour.

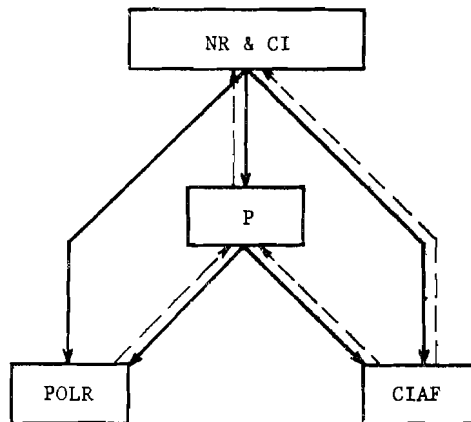

Figure 5

It is evident that the picture given in Figure 5 is of considerable importance, for the purpose of better understanding the model as well as for determining the best approach to further study. Forrester's model, originally presented as a tangle of influences - see Figure 6 - has now been reduced to a system of sectors, neatly ordered, each of which is fairly easy to understand, while its interactions with other sectors - if existent at all - are better discernable.

* See Appendix D.

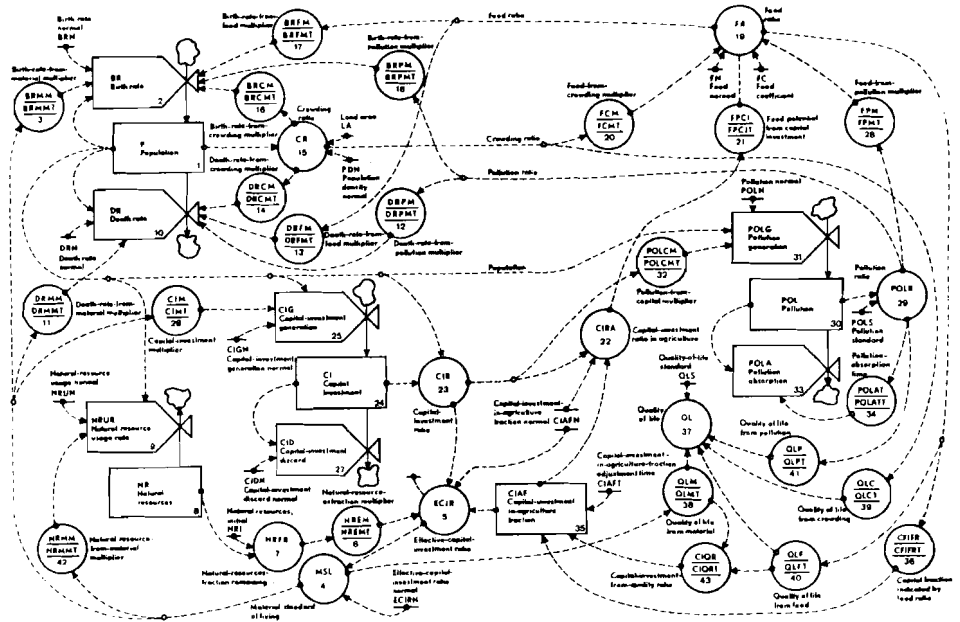

Figure 6

2.1.6 Final Remark

The studies described above, which were often restricted to the behaviour in situations not deviating too much from the standard situation, would properly be supplemented by an investigation into the circumstances under which certain details become main points, or, conversely, main points stop being main points; in other words, an investigation into the behaviour of the model under abnormal circumstances. Such an investigation has been dispensed with in the case of World2 because the World3 model has in the meantime become available.



2.2 Effect of Optimizing Control

The Subgroup Dynamic Optimizing has restricted itself in this period of reporting to World2 with a view to first obtaining sufficient insight into the possibilities and difficulties of optimizing with this model.

2.2.1 Models and Criteria

Two models have been developed to approximate the original model, one in which all coupling functions have been linearised (*I55*) and one with non-linear analytical coupling functions and an algebraic equation for the pollution (*I28* and *I53*), this in connection with the different nature of the methods tried. In these models *possibilities of correction* have been incorporated for influencing:

- pollution generation,
- usage of natural resources,
- birth rate
- capital investment generation.

At the same time estimated costs of these influences have been taken account of. That part of the total flow of goods and services which is not spent on the above influences and which does not benefit the agricultural sector either, is called "*consumption*" for short and is taken into account in a consumption standard of living (CMSL). This CMSL, together with the degree of pollution POLR and the crowding CR, forms part of the *QUALITY OF LIFE QL* as defined by Forrester. As a criterion, i.e. as a quantity which has to be maximized, the preliminary choice has fallen on QL multiplied by the total number of people P (one might say: the total amount of wellbeing in the World) averaged over a definite period starting in 1970. In most calculations the period referred to extended to 2100, but in some a shorter period was considered. In general, the average of QL.P was increased by the number of people, the remaining quantity of natural resources, and the degree of pollution in 2100, each provided with a weight factor (Further see *I28* and *I55*). The correcting variables are limited, on the one hand because none of the individual spendings can be negative, on the other because the flow of goods and services left for consumption cannot be negative either. Moreover, a lower and an upper limit had to be set to capital investment generation (see foot-note to the next section).

In the calculations that were performed in the Twente University of Technology experiments were carried out with limitations to certain state variables (*I46* and *I52*).

2.2.2 Methods and Results

For dynamic optimization various methods can be employed, and as each has its characteristic advantages and drawbacks, it is a problem by itself to find the method most suitable for our goal. One of the most obvious methods is the Pontryagin Maximum Principle, and with it the first attempts were made (*I3*, *I7* and *I25*), without success however, because neither the shooting method nor Marquardt's method produced adequate convergence in solving the two-point boundary problem. The first successful results were obtained by an iterative method developed by Lekkerkerker and Oerlemans, which, per cycle, approaches quadratically the solution of the Hamilton-Jacobi equation (8), while constraints on the correcting vector are permissible.

In interpreting the results described in *I88* the utmost caution should be used, in view of the simplifications in the model, the nature of the criterion, and the arbitrariness with which provisional correcting functions and coefficients have been established. They showed that the additional

spendings to fight pollution remained nil up to 1995, and then rose to approx. 8% of the total world production in 2080. The capital investment generation was kept at its maximum permissible value to approx. 1985, and then brought abruptly to the somewhat lower minimum permissible value. Further, at first approx. 5% of the total world production was spent on birth control, but this percentage fell rapidly to remain constant from approx. 1990 to 2060; then it approached zero. The results referred to above made the impression that optimization tried to give the capital investment a push in favour of the CMSL, and at the same time tried to put a stop to the growth of the population as soon as possible. It is noteworthy that afterwards the population remained quite constant (about 4000 to 5000 million) and that the standard of living as defined by Forrester was considerably higher than in the uncontrolled situation. Further it is remarkable that till after 2050 a large proportion of the production (approx. one fifth) was spent on a more economical use of the natural resources. All in all, this means that from 1970 during many decades a fairly large proportion of the world production was assigned to means of limiting the consumption of natural resources and the birth rate and to means of production (the assignment to the agricultural sector was fixed), so that at first only approx. half of it remained for the rest of the purposes, for brevity's sake but perhaps somewhat misleadingly, called here *consumption*. Now it is the Consumption MSL that exercised in these calculations the influence on birth and death rates assumed by Forrester, so that the rapid stabilization of the population referred to above was also brought about by the drop in the Consumption MSL. It is still a subject of study whether the influence of birth and death rates may not be better accounted for in some other way.

We suppose that it will be abundantly obvious to every reader that all findings referred to above are extremely tentative and that numerous verifications have yet to be carried out. Even afterwards the greatest possible caution should be used when interpreting results. It is, however, also possible that, as in the case of *LIMITS TO GROWTH*, eventually some conclusions turn out to be so evident that verifying their correctness is possible even without a model and without optimizing theory, which is perhaps the best result ever obtainable with model studies.

In the meantime the Twente University of Technology has obtained results with a variant of Dynamic Programming according to Bellman developed by Larson and Korsak (9). This is an iterative method in which only one state variable is optimized per cycle, which saves memory space. Another advantage is the ease with which various coupling functions and constraints, also of the state variables can be considered (I46, I52). In view of the calculation time required only optimizing calculations over the period of 1970 to 2020 have been carried out so far.

At the Delft University of Technology preparations are being made for optimizing with the aid of the hybrid computer.

At Eindhoven, gradient methods are being developed. Using a comparatively small program, results are obtained which agree well with those according to the program of Oerlemans et al., but convergence proceeds somewhat slowly yet (chiefly owing to the bang-bang behaviour of the investment generation referred to above) (I85).

 * This correcting variable occurs linearly in the Hamiltonian, which gives rise to a bang-bang solution; two additional switching moments appeared to happen, returning the investment generation to its upper limit from 2060 to 2075 but this is probably not relevant.

2.2.3 Plans

Now that the exploration period has passed by, first of all attempts are being made to reduce the various activities to the same denominator: same model, same criterion, same correcting variables and functions, same constraints, etc., but without restricting the number of methods for dynamic optimization. Particular attention is given to the mathematical aspects of those methods. This not only refers to improvement of the methods currently used, but also to development of new methods. Further, cooperation in one group of specialists who have experience with several methods, and the parallel application of these methods to one and the same problem is found to be exceedingly instructive.

Simultaneously with the foregoing an extensive investigation will be made into the way in which and the measure of which the results depend on the many assumptions, functions, and coefficients that have been introduced, viz.:

- the weighting factors which are attached to the final values of population, natural resources and pollution in 2100,
- the weighting factors occurring in the correction functions,
- the constraints,
- the coefficients in the definition of QL (Quality of Life), and eventually probably also:
- the influence of other criteria and other models.

Two important problems to which continual attention is being devoted are the identification and definition of *correcting variables* (both as regards their effect, and their cost and possible other ancillary effects), and the formulation of various alternative *criteria* on the basis of which possible developments may be evaluated.

2.3 Methods and techniques

The following is to supplement what has been said about methods and techniques above.

For use on a terminal (time-sharing system) Algol programs have been developed which on the one hand considerably shorten the computing time and on the other open the possibility, after completion of the calculation, of having the curves drawn differently as long as the diagrams are not as desired. A calculation with *World2* of 1000 time steps now takes about 150-200 seconds of the computer, but as this has to serve more clients, the minimum waiting time for each calculation is about ten minutes. This program is described in detail in *U6*; an improved version is reported in *U7*.

The responses to the inquiry by circular letter (*I32*) concerning the calculating procedure *DYNAMO* and the errors in the 1970 values of numerous variables in Forrester's standard run (see also VI, p. 10), as also a few responses to a couple of questions that occurred to us when perusing Forrester's book (*I24*) have been summarized in an Informal Note (*I30*), by which it is hoped a certain amount of confusion and uncertainty has been disposed of and some interesting marginal notes to Forrester's book have been committed to paper.

 * This is a Philips P9200 system, consisting essentially of two small Honeywell process-control computers, which in view of their short word length (16 bits) are programmed in multiple word length which, of course, takes more time than on a full-fledged computer.

2.4 Evaluation and Information

An appreciable proportion of the evaluation of Forrester's model sketched in Section 2.1 has not been reported on in writing yet; therefore a separate publication devoted to this subject is being prepared, while several publications on individual subjects are being considered. Meanwhile, many of the findings have been incorporated in the lectures held on the subject in a great variety of places (See Appendix B). In this connection the Day of Information concerning The World of Forrester held on June 23, 1972, as part of the Measurement and Control Seminar of the E.U.T. deserves especial mention. Over 200 visitors attended. The morning was passed by presenting the model in the manner of Forrester, and the afternoon by further analysing the various sectors. In response to many requests this Information will be given once more, viz. on January 5th, 1973. After that, our intention is to direct attention exclusively to newer world models, such as World3, as soon as they have been published officially.



3. THE MODEL OF MEADOWS (WORLD3)

3.1 Comparison of World3 with World2

Two provisional versions of World3 are at present known to us; they differ from each other in a number of respects (I74) and show marked deviations from the model of which *LIMITS TO GROWTH* (pp. 102-103) shows the flow diagram (I40). The final report on World3 will probably be published early in 1973. As far as can be established at present, the most outstanding differences from and points of similarity to Forrester's World2 are the following.

3.1.1 State Variables

The fraction of the capital invested in agriculture (CIAF) no longer occurs as a state variable; instead, four new agricultural state variables have been introduced which are connected with the available land and with the fertility of the land. In the capital sector the service capital has been introduced as a new state variable in addition to the industrial capital. The natural resources sector has not been changed essentially. In one of the versions of World3 the population has been split into age groups (approximately in conformity with the sketch in *Limits to Growth*, while in the other version no distinction is made to age. Finally fifteen state variables have been incorporated in the form of lags in certain interrelations (see below). This has caused the total number of state variables to increase from 5 in World2 to 9+15 in the April version of World3*.

3.1.2 Nonrenewable Natural Resources and Capital Sector

The nonrenewable natural resources sector has not been essentially changed, but part of the industrial capital has been assigned to it for exploration and exploitation. From the rest of the industrial capital an *Industrial Output IO*, i.e. a flow of industrial products, is derived and allocated to various purposes (agriculture, consumption, services, and means of production). Further, a tentative model for the number of available jobs and workers has been introduced.

3.1.3 Agricultural Sector

The model for this sector is different in set-up and far more complicated than that of Forrester; it also shows striking differences from the model in *Limits to Growth*. It contains four state variables: potentially arable land, arable land, urban and industrial land, and land fertility, while the effect of capital investments and the reaction to the food production per head act on the sector via lags.

3.1.4 Pollution Sector

The model for persistent pollution is approximately the same as that of Forrester, although a *lag* has been introduced which causes the production of pollution not to affect the degree of pollution until after a number of years. In addition, a short-term pollution has been introduced which affects the agricultural production as a direct result of the industrial production.

* In the July version this number is, of course, different again.

3.1.5 Population Sector

Birth rate and death rate are established in totally different ways, as compared to Forrester's model, and life expectancy and fertility play an important part. Some influences from the capital sector act via lags.

3.1.6 Final Remark

Although Meadow's model is more complicated than Forrester's, it shows many striking points of similarity as to structure and behaviour, as will appear from the next section.

3.2 Insight into the model and understanding of its behaviour

The more complicated character of World3 makes it still more important to see the model as a structure of sectors, and to understand the behaviour of the sectors individually and the effect of their inter-relations. To achieve this, the model has been approached in several ways simultaneously, the studies having first concentrated on the behaviour during the standard run. At a later stage it will be investigated to what extent special developments are possible under special conditions.

3.2.1 Behaviour of the Quantities

The standard behaviour of all quantities in the period of 1900-2100 is represented in graphical form *I69*. The figures teach us, among other things, that the changes in the labour sector causes the industrial output to vary by only approx. 0.05 per cent, that the influence of persistent pollution on the life expectancy lies in the same order of magnitude, that the short-term pollution does not affect the land yield perceptibility, and that the investment for increasing the land fertility is an almost fixed deductible expense of the total agricultural investments (*I48*). This causes a number of relations to become, in first approximation, insignificant which simplifies the picture considerably.

3.2.2 Main Relations between Sectors

A further analysis of the standard behaviour and of the part the assumed relations (table functions) play in it has led to, among other things, the following conclusions (Further see the sections following):

- The consumption of nonrenewable resources is determined almost exclusively by the industrial output; the size of the world population has only a slight influence.
- The fraction of the industrial output invested in the service sector depends largely on the quotient of the outputs of these two sectors; the size of the world population has little influence on this, too.
- The generation of persistent pollution is mainly determined by the industrial output and the allocations to agriculture; the number of people producing pollution and the area of arable land contribute in a much smaller degree.

From these and other results of the study in question (*I65*) the preliminary conclusion may be drawn that under normal conditions

* What follows now is primarily based on the April version of World3 (5); where numerical values are mentioned these need not apply to the July version (6).

Meadows' model can be represented by the diagram-in-outline shown in Figure 7.

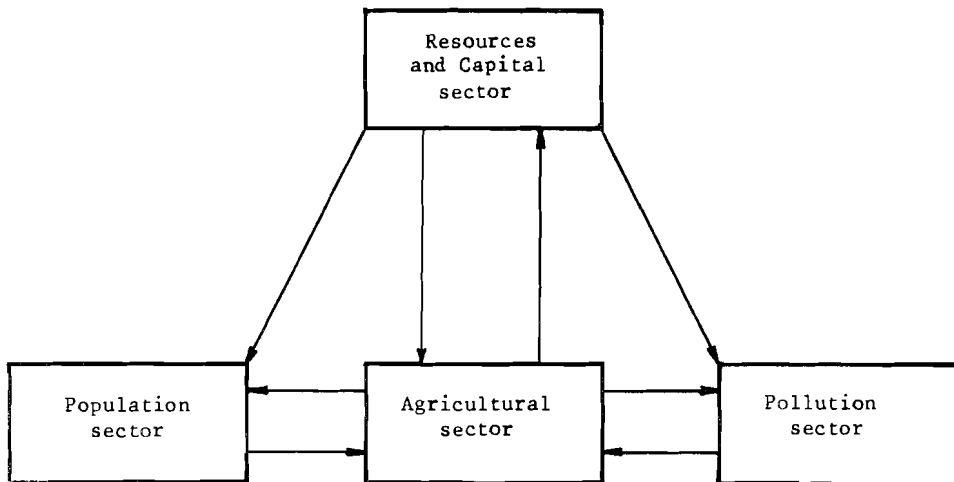

3.2.3 Effect of Delays*

The model contains a number of lags which can be described by a third-order difference equation (10). It appears that the standard behaviour hardly changes when these lags are replaced by first-order transfers (160). From a mathematical point of view, this means that the number of state variables can be reduced from 24 to 16, which is of great importance to several studies.

3.2.4 Population Sector

The industrial output per head acts on the desired size of families along two parallel paths. The two influences compensate each other so that during

* In terms of the jargon used by control engineers and most systems scientists, what are called *delays* by the M.I.T. group are not time-delays at all, but exclusively lags described by first- or third-order difference equations.

the standard run the desired size of families is always between 2.94 and 3.28, i.e. that it deviates less than 5% from the average value. This influence can therefore be replaced by a constant without the behaviour being affected appreciably. Since, as stated above, the degree of pollution does not exercise much influence either, the population sector appears to be affected virtually only by the production of food and services per head.

Another interesting point is the behaviour of the total fertility. If the values of this variable are not too high, it is determined by the sum of two terms:

- the desired total fertility multiplied by the birth control effectiveness, and
- the maximum biological fertility multiplied by (1 - birth control effectiveness).

Up to 2050 the latter contribution is between 0.94 and 1.17; so it does not change much. If we substitute a constant value for this contribution, the standard behaviour in the period mentioned is, therefore, not influenced appreciably. Further, the model sets a biological upper limit to the total fertility, which is reached in 2070 (I57).

3.3 Correcting variables

World3 lends itself better to adding correcting variables ("instruments of economic policy" and the like) than its predecessor. As explained in the previous report, we consider the identification and introduction of such variables as an important but difficult task. Relevant possibilities include:

- more economical exploitation of nonrenewable resources,
- reduction of the consumption of nonrenewable resources by recycling, lengthening of the lifetime of the products, and the restriction of consumption,
- more effective food production, especially through restriction of the losses, before and during as well as after harvesting,
- restriction of industrial pollution production,
- restraining the growth of the population by reducing the desired completed family size and promoting birth control.

The activity in this field is still in an exploratory stage (I73, I76).

3.4 Effect of Stabilizing Control

The effect of adding stabilizing controls has been investigated at D.S.M. in the manner in which this has been done earlier for World2. Comparison of the results reveals the following (I62, I78):

- Although, owing to the more complex dynamics, the stabilizing feedback loops might sooner become critical, there is no tendency to instability.
- The suppression of pollution owing to moderation of investments seems to be as effective as in World2, despite the fact that a lag occurs between industrial output and pollution caused by it.
- The quantity of nonrenewable resources is easier to "stabilize" in World3 than in World2.
- As regards the growth of the population, the standard behaviour of World3 contrasts rather unfavourably (peak value about twice as high!) with that of World2. Therefore, the population in World3 is more difficult to stabilize. Reasonable results will only be obtained if action is taken within the population sector itself.

For safety's sake it must be emphatically pointed out that the results of these control studies require very careful interpretation, not only because the proper correcting variables have perhaps not been used yet, but especially because the real world is probably far more poorly controllable than World3.

3.5 Methods and techniques

Supplementing what has been said in the foregoing, e.g. in Section 2.3, on methods and techniques, it can be added that both versions of World3 have now been implemented on the P9200 time-sharing system of the E.U.T. For the purpose of carrying out bulk calculations, the July version (6) has also been programmed for the main computer EL X8.

In addition, a hybrid simulation is being carried out in which an analog computer and a small digital computer are coupled together (see also VI, p. 16). The great advantage of this combination is that the calculation time is negligible, and that one can see almost at once how a change in the model affects the behaviour of 1900 to 2100 (or any other point of time), which provides much more rapidly a much better insight into the system.

3.6 Evaluation and Information

As appears from the above, World3 is being investigated in different ways simultaneously; a fairly large proportion of the findings has already been provisionally laid down in I-notes (see list at the end of this report). As regards the Information Days, etc., we have intentionally restricted those to the model of Forrester, because we did not think it proper to disclose on a large scale our findings concerning the model of Meadows before his publishing it himself in book-form. Therefore, it is in fact in the present report that we go into his model for the first time, in the hope that his book will have been published by the time this report reaches you.



GLOBALE



DYNAMICA

A.

MEMBERS OF THE GROUP

Scientific management : Professor P.M.E.M. Van der Grinten, and
Professor O. Rademaker.

External coordination : Professor O. Rademaker, E.U.T., Post Box 513,
Eindhoven, Netherlands, Phone 040-472885.

Internal coordination : Mr. J.G.M. Cuypers, E.U.T., Post Box 513,
Eindhoven, Phone 040-472881.

Associates:

Professor J.F. Benders (E.U.T./Mathematics)
Mr. C.G.J. Buursen (E.U.T./Measuring and Control)
Dr. H.A.G. Chermin (Dutch State Mines/D.S.M.)
Mr. H.D. Coster (R.U. Groningen)
Mr. J.G.M. Cuypers (E.U.T./Measuring and Control)
Mr. G. Dekker (E.U.T./Measuring and Control)
Professor L. Dekker (Delft University of Technology/Mathematics)
Mr. J.W. Dercksen (E.U.T./Measuring and Control/Z.W.O.)
Mr. J. van Drie (E.U.T./Measuring and Control)
Mr. M. van Eyndhoven(D.U.T./Mathematics)
Dr. M.L.J. Hautus (E.U.T./Mathematics)
Mr. P. van der Hijden (E.U.T./Measuring and Control)
Dr. J.L. de Jong (E.U.T./Mathematics)
Mr. P.J. de Jong (Dutch State Mines/D.S.M.)
Mr. A.C.P. de Jongh (E.U.T.)
Mr. E.J.H. Kerckhoffs (D.U.T./Mathematics)
Mr. A.G.H. Kessels (E.U.T./Measuring and Control)
Professor H. Kwakernaak (Twente University of Technology/Mathematics)
Mr. M.J.B.M. Monen (E.U.T./Measuring and Control)
Mr. Th.W. Oerlemans (Royal Dutch/Shell Laboratories Amsterdam)
Mr. M.J.M. Strik (E.U.T./Measuring and Control)
Mr. R.C.W. Strijbos (T.U.T./Mathematics)
Mr. G. Sijberden (E.U.T./Measuring and Control)
Mr. M. Tellings (Royal Dutch/Shell Laboratories Amsterdam)
Mr. W.A.H. Thissen (E.U.T./Measuring and Control)
Mr. J.H. Voskamp (E.U.T./Measuring and Control)
Mr. Th. Zwietering (Dutch State Mines/D.S.M.)

Underlining denotes full-time associates.

* Netherlands Organisation for the advancement of pure research (Z.W.O.).



· GLOBALE



DYNAMICA

B. PRINCIPAL LECTURES, CONGRESSES, etc.

- 1972-03-09 P.M.E.M. van der Grinten,
Wereldregelingen gebaseerd op wereldmodellen,
(World control based on world models),
Symposium "The World as a system", Delft University of Technology.
- 1972-04-11 P.J. de Jong,
Wereldmodellen,
(World models),
Seminar " Environment", Neth.Inst. of Preventive Medicine,
Driebergen.
- 1972-04-13 P.J. de Jong,
Forumdiscussion: Wereldmodellen (World models),
Utrecht Student Corporation.
- 1972-04-14 P.M.E.M. van der Grinten,
De wereld van Forrester, Meadows en de Club van Rome,
(The world of Forrester, Meadows and the Club of Rome),
Annual Meeting "Christelijke Jonge Werkgevers", Utrecht
- 1972-04-15 P.M.E.M. van der Grinten,
De wereld als zandloper,
(The world as a sand-glass),
Symposium "Limits to Growth", Delft University of Technology.
- 1972-04-25 P.M.E.M. van der Grinten,
World dynamics considered as a control problem,
University of Leuven.
- 1972-05-07 O. Rademaker,
Verkenningen in de wereld van Forrester,
(Reconnoitring Forrester's world),
S100*, Lunteren.
- 1972-05-16 P.M.E.M. van der Grinten,
World dynamics considered as a control problem,
University of Brussels.
- 1972-05-18 P.M.E.M. van der Grinten,
World dynamics considered as a control problem,
University of Berlin.
- 1972-05-25 P.M.E.M. van der Grinten,
Wereldregelingen gebaseerd op wereldmodellen,
(World control based on world models),
Annual Meeting Royal Flemish Ingenieurs Institute, Antwerp.
-

* S100: Stichting Interacademiaale Opleiding Organisatiekunde (Foundation Interuniversity Education in Organisation).

- 1972-05-27 P.J. de Jong,
Wereldmodellen,
(World models),
Ned. Quaker Genootschap, Putten.
- 1972-06-02 P.M.E.M. van der Grinten,
Een kritische beschouwing over wereldmodellen,
(A critical evaluation of world models),
Annual Meeting "Genootschap van Automatisering" (Automation
Society),
Rotterdam.
- 1972-06-23 J.G.M. Cuypers, A.C.P. de Jongh, O.Rademaker,
De wereld van Forrester,
(Forrester's world model),
Colloquium Meten en Regelen, Eindhoven University of Technology.
- 1972-07-30 J.G.M. Cuypers,
to -08-11 Attended the NATO "System Dynamics" course,
Hanover.
- 1972-08-18 P.M.E.M. van der Grinten,
Kan het ondernemingsbeleid anticiperen op maatschappelijke
ontwikkelingen?
(Can private enterprise anticipate changes in society?),
Cebelon symposium "Verantwoordelijkheid van commissarissen
voor het ondernemingsbeleid" (Responsibility of directors
for corporate policy), Noordwijk.
- 1972-09-05 O.Rademaker,
Het model van de Club van Rome,
(The model of the Club of Rome),
Studium Generale, Twente University of Technology.
- 1972-09-20 P.M.E.M. van der Grinten,
Is groei een absolute voorwaarde voor de continuïteit van de
onderneming?
(Is growth absolutely necessary for corporate continuity?),
NIVE, Hengelo.
- 1972-10-24,31 O. Rademaker,
and -11-07 Globale Dynamica,
(Global Dynamics),
Lectures to sophomores, Eindhoven University of Technology.
- 1972-10-26 P.J. de Jong,
De regelbaarheid van het wereldmodel,
(The controllability of the world model),
NIRIA, Vaksectie Regel- en Informatietechniek (Section Control
and Information Engineering), Utrecht.
- 1972-11-18 P.M.E.M. van der Grinten,
Beschouwingen over wereldmodellen,
(Reflections on World models),
Dutch Week, University of Ghent.

- 1972-11-28 P.M.E.M. van der Grinten,
Het Rapport van de Club van Rome; uitzichten één jaar na
publicatie,
(Limits to Growth; prospects after one year),
Theological School, Kampen.
- 1972-12-08 O. Rademaker,
Over activiteiten en resultaten van de werkgroep
"Globale Dynamica",
(Activities and results of the project group "Global Dynamics"),
Colloquium van Bedrijfskunde (Industrial Engineering),
Eindhoven University of Technology.
- 1972-12-14 O. Rademaker, Th.W. Oerlemans, J.G.M. Cuypers,
Regeltechnici in Forresterland,
(Control Engineers in Forresterland),
KIVI, Department of Control Engineering, Utrecht.
- 1972-12-15 P.M.E.M. van der Grinten,
De wereldmodellen van de Club van Rome; mogelijke bijdrage
van sociologen,
(The world models of the Club of Rome; possible contributions
by sociologists),
Annual Meeting "Nederlandse Sociologische & Antropologische
Vereniging".





Referencics

1. J.W. Forrester,
World Dynamics.
Wright-Allen Press Inc., Cambridge, Massachusetts, 1971.
2. D.L. Meadows c.s.,
Rapport van de Club van Rome (AULA 500).
Het Spectrum N.V., Utrecht, 1972, (Dutch version of Limits of Growth).
3. Club van Rome Nederland, Bulletin no. 3 (1972-06-01),
Club van Rome Nederland, Bulletin no. 4 (1972-10-01).
Club van Rome Nederland, Lange Voorhout 16, Den Haag.
4. S.H.A. Begemann,
Amerika en "The Limits to Growth".
Washington Nieuws, (1972-09-29)no. 72-14.
5. W.W. Behrens, D.L. Meadows,
The Dynamics of Growth in a Finite World (Preliminary Draft).
M.I.T., (1972-04-07).
6. W.W. Behrens, D.L. Meadows,
The Dynamics of Growth in a Finite World (Second Preliminary Draft).
M.I.T., (1972-07-20).
7. A.J.M. Timmermans,
Enkele toepassingen van het Maksimum Principe van Pontryagin.
Afstudeerverslag, T.H. Eindhoven, (1972-05-22).
8. P.J.A. Lekkerkerker, Th.W. Oerlemans,
Calculation Method for Dynamic Optimization, Using Quadratic Approximations
to the Minimum Surface.
Automatica, 7, (1971), pp. 713-726.
9. A.J. Korsak, R.E. Larson,
Convergence proofs for a dynamic-programming successive-approximations
technique.
Automatica, 6, (1970), pp. 245-260.
10. A.L. Pugh,
Dynamo II, User's Manual,
The M.I.T. Press, 1970.



Additional literature

- P71-08* J.W. Forrester,
Counterintuitive Behaviour of Social Systems.
Technological Forecasting and Social Change, (1971), 3, pp. 1-22.
- P71-09 M.I.T.-medewerkers,
Voorstudies van "The Dynamics of Growth in a Finite World".
M.I.T., (1971).
- P71-10 J.W. Forrester,
Counterintuitive Behaviour of Social Systems.
Simulation, (1971), febr., pp. 61-76.
- P72-07 De Wereld als Systeem, (The World as a system),
Symposium of the Mathematical Student's Club, T.H. Delft,
(1972-03-08 and 09).
- P72-09 Commentaren op het Rapport van de Club van Rome, (Comments on
Limits to Growth),
Stichting Bio-Wetenschappen en Maatschappij, (Foundation for
Bio-sciences and Society), Utrecht, (1972).
- P72-10 Th.W. Oerlemans, M.M.J. Tellings, H. de Vries,
World Dynamics: Social Feedback may give Hope for the Future.
Nature, 238, (1972), aug., pp. 251-255.
- P72-12 Th.W. Oerlemans, M.M.J. Tellings, H. de Vries,
Werelddynamica: Maatschappelijke terugkoppeling geeft hoop voor
de toekomst, (Dutch version of preceding reference).
Chemisch Weekblad, (1972-06-09), pp. 10-13.



* Identification number in the filing system of the Eindhoven University
of Technology Measurement and Control Group.



Informal notes*

- 140 (72-04-16)Rademaker
Notes on the draft of the Technical Report on World3 dated April 7, 1972 by Meadows and Behrens.
- 141 (72-04-17)Sijberden
Graphs of the functions of World3 dated April 7, 1972.
- (142)** (72-04-19)Timmermans
The optimisation equations.
- (143) (72-04-24)Thissen
Analog schemes of World3.
- E 144 (72-04-23)Rademaker
Some notes on the preliminary draft of the Technical Report dated April 7, 1972.
- 145 (72-04-28)Ferguson
Some notes on the population sector of Forrester's model.
- (146) (72-05-20)Olsder
First results of optimising the world model.
- 147 (72-05-30)Thissen
World3: comments and criticism.
- 148 (72-06-05)Cuypers
Simplifications of World3 - First round.
- (149) (72-07-03)Cuypers
Simplifications of model World2 (published in U8).
- (150) (72-07-28)Rademaker
Forrester program (issued as U6).
- (151) (72-07-30)Cuypers
NC-b model (included in U8).
- 152 (72-06-19)Olsder
Tentative exercises in optimising the world model.

* Numbers preceded by an E indicate notes written in English.





** A number in brackets denotes that the note has in the meantime been replaced by a newer version, or that it has been withdrawn by the author, or that it is of such a nature as to be irrelevant for an outsider without the addition of an extensive explanation.

- I53 (72-07-03)Cuypers
Minutes of the meeting of the subgroup Dynamic Optimisation on June 26, 1972.
- I54 (72-07-01)Thissen
An alphabetically ordered list of abbreviations used in World3.
- E I55 Oerlemans
Dynamic Optimization of World2.
- I56 (72-07-03)De Jongh
Some model studies based on the NC-b model.
- I57 (72-07-05)Cuypers
Some simplifications of World3 - Second round.
- I58 (72-07-05)Thissen
Some economic demographic notes regarding World3.
- I59 (72-07-11)Monen
The behaviour of all variables in the standard-run of World3.
- I60 (72-07-11)Cuypers
The effect of replacing delay3's and dlinf3's by smooths' in World3.
- I61 (72-07-27)Olsder
A question mark regarding the model being used at present (for optimisation studies).
- I62 (72-08-03)P.J. De Jong
A comparison of the behaviour of World3 and World2 under control.
- I63 (72-08-15)Sijberden
Schemes of model World3 dated April 7, 1972.
- I64 (72-08-16)Olsder
Some new optimisation results.
- I65 (72-08-21)Cuypers
The structure of the model World3 dated April 7, 1972.
- I66 (72-08-22)De Jongh
Supplementary model studies using the NC-b model.
- (I67) (72-08-28)Cuypers
Proposal for planning the project Global Dynamics in Group NC.
- I68 (72-08-28)Oerlemans, Tellings, Kessels
Dynamic optimisation of World2.
- I69 (72-09-07)Oerlemans
The capital coefficient in the World2 model.
- I70 (72-08-28)Zwietering
Scheme of World3.

- I71 (72-09-11)Cuypers
Minutes of meeting on Optimisation on August 29, 1972.
- E I72 (72-09-09)Thissen
Some remarks on the new version of the Technical Report
(Meadows c.s.) dated July 20, 1972.
- I73 (72-09-14)Thissen
Possible correcting variables in World3; a first analysis.
- I74 (72-09-19)v.d. Hijden
World3. Differences between the April 7 and the July 20, 1972,
versions.
- E (I75) (72-09-19)Rademaker
Software for World Dynamics calculations (issued as U6).
- I76 (72-09-25)Cuypers/Thissen
Correcting variables in World3 reconsidered.
- I77 (72-09-26)v.d. Hijden
Supplement to I54.
- I78 (72-10-03)De Jong (D.S.M.)
Corrections and supplements to I62.
- I79 (72-10-02)Strijbos
Supplement to I64.
- I80 (72-09-29)Rademaker
Some numerical aspects of World2. Summary of the reactions to
I24 and I32.
- I81 (72-10-12)Voskamp
Some results of optimising World2 using a gradient method.
- I82 (72-10-16)Dercksen
Minutes of meeting on optimisation on October 10, 1972.
- I83 (72-11-13)Strijbos
Some points for the discussion in the meeting on the optimisation
of World2.
- I84 (72-11-12)Tellings
Optimisation of World2.
- I85 (72-11-20)Dercksen
Optimisation of World2 using the steepest descent method.
- I86 (72-11-20)Dercksen
Minutes of the meeting of the subgroup Dynamic Optimisation,
November 11, 1972.



Papers, non-periodical reports and other publications

- U5 (72-05-10)Cuypers, Rademaker
Differences between world models: a world of differences?
Report on a controversy between refs. 4-6 and ref. 7.
-  U6 (72-08-28)Rademaker
Software for world dynamics calculations.
-  U7 (72-11-07)Rademaker
An improved version of fast and flexible programme for world
dynamics calculations.
-  U8 (72-08-01)Cuypers
World Dynamics: Two simplified versions of Forrester's model.
-  U9 (72-11-01)Cuypers
An analysis of Forrester's world model.
- U10 (72-12-25)Cuypers, Rademaker
Ontdekkingsreizen in de Wereld van Forrester (A reconnaissance of
Forrester's World model).
- U11 (72-12-31)Rademaker
De vervuiling in het wereldmodel van Forrester (The pollution in
Forrester's World model).

Periodical Reports

-  V1 (72-04-23)Rademaker
Project Group Global Dynamics - Progress Report No. 1.



GLOBALE



DYNAMICA

E. FURTHER EXPLANATION OF FIGURE 1

Quantities and Scales

Forrester assumes that the effectivity of the capital investment (CI) decreases as the supply of natural resources (NR) becomes smaller and takes account of this by multiplying CI by a factor NREM, which depends on NR divided by the initial supply NRI as follows*:

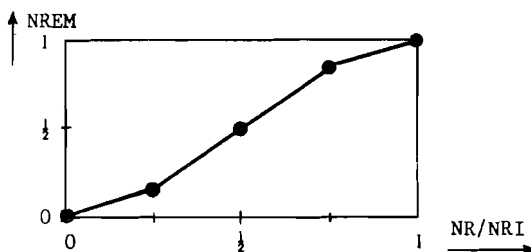

Figure E-1

Using this graph, NREM can, conversely, be taken as a measure of NR, and this possibility has been used in constructing Figure 1 by defining the quantity N as follows:

$$N = \frac{CIGN}{CIDN} \cdot NREM, \quad (E-1)$$

where CIGN represents the coefficient for the annual investments and CIDN those for the discards. Hence, the following graph applies to N:

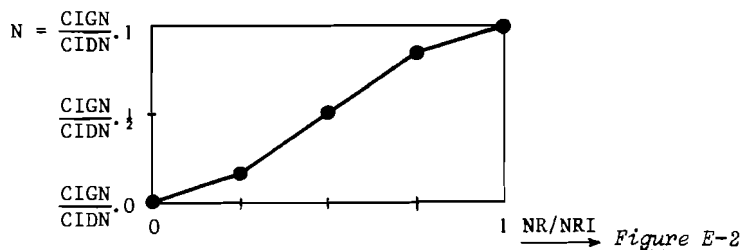

Figure E-2

In the standard run $CIGN/CIDN = 2$, and the corresponding scale for NR/NRI has been drawn additionally in Figure 1 at the right-hand side. This scale is subdivided linearly from 0 to $1/4$ and from $3/4$ to 1, and, with a different scale value, from $1/4$ to $3/4$.

Quantity C in Figure 1 is the capital investment CI divided by its initial value CII (in 1900:400 million units, according to Forrester):

$$C = CI/CII. \quad (E-2)$$

* Further see Chapter 3 of Forrester's book (1).

Introduction of the above N and C as measures of the natural resources and the capital investments, respectively, enables the equations, under certain simplifying conditions (see below), to be so transformed that only one single parameter (τ) remains, provided the time scale is chosen judiciously.

Therefore, along the abscissa the writing-off period $1/CIDN$ (in Forrester's case 40 years) was chosen as unity. In the standard calculations the time scale is from 1900 to 2100, but that is not essential, for whether the date is high or low plays in itself no part at all; what only counts is the time that has elapsed since "the start".

The principal parameter τ of the curves is given by:

$$\tau = \frac{NRI}{CII} \cdot \frac{CIDN}{\alpha} \quad , \quad (E-3)$$

where

$$\alpha = d(NREM)/d(NR/NRI) \quad , \quad (E-4)$$

i.e. the slope of the graph of Figure E-1.

The heavy solid curves correspond with the standard run $\tau = \tau_0$, the other ones with situations in which $NRI \cdot CIDN / CII$ is greater or smaller by a factor 2 or 4.

Conditions

As stated in the main text, Figure 1 applies only under certain conditions. The most important is that the Agricultural Correction Factor AC must be constant and equal to 1; further, the material standard of living MSL should not become much greater or smaller than 1. In the standard run, from 1900 to 1970 AC is somewhat greater than 1, while MSL just lies between 1/4 and 3/4 for some time, which favours a somewhat more rapid growth of C and a somewhat more rapid fall of N than shown in Figure 1. If, when calculating this figure one started from the conditions in 1970, the correspondence would be better, but since we are only interested in the principal aspects of the behaviour of this sector, this was not done. It is more important to point out that the figure does not apply in situations in which the pollution 'runs away' to high values, and this for two reasons: (1) the model calculations then show such a wholesale number of deaths that the standard of living runs high (it is, indeed, defined by the investments per head), and (2) according to the model, the high degree of pollution impairs the production of food to such an extent as to recruit great additional capital investments in the agricultural sector; in other words, AC then falls drastically. This creates the process as indicated by the dot-and-dash lines in Figure 2; the accompanying response of population and pollution is represented in Figure E-3. The solid lines show what happens, according to the model, if one does not allow the degree of pollution to rise higher than 10 times, 5 times, and once the level in 1970, respectively, or if the degree of pollution is kept constantly at zero. In Figure 2 the results then diverge too little to produce different curves, but Figure E-3 makes clear that the population is, indeed, sensitive to the limit to which the degree of pollution rises. If no limit is set, then the degree of pollution 'runs away', as it were, to very high values and the wholesale decrease in population occurs (dot-and-dash lines) which causes the material standard of living to rise

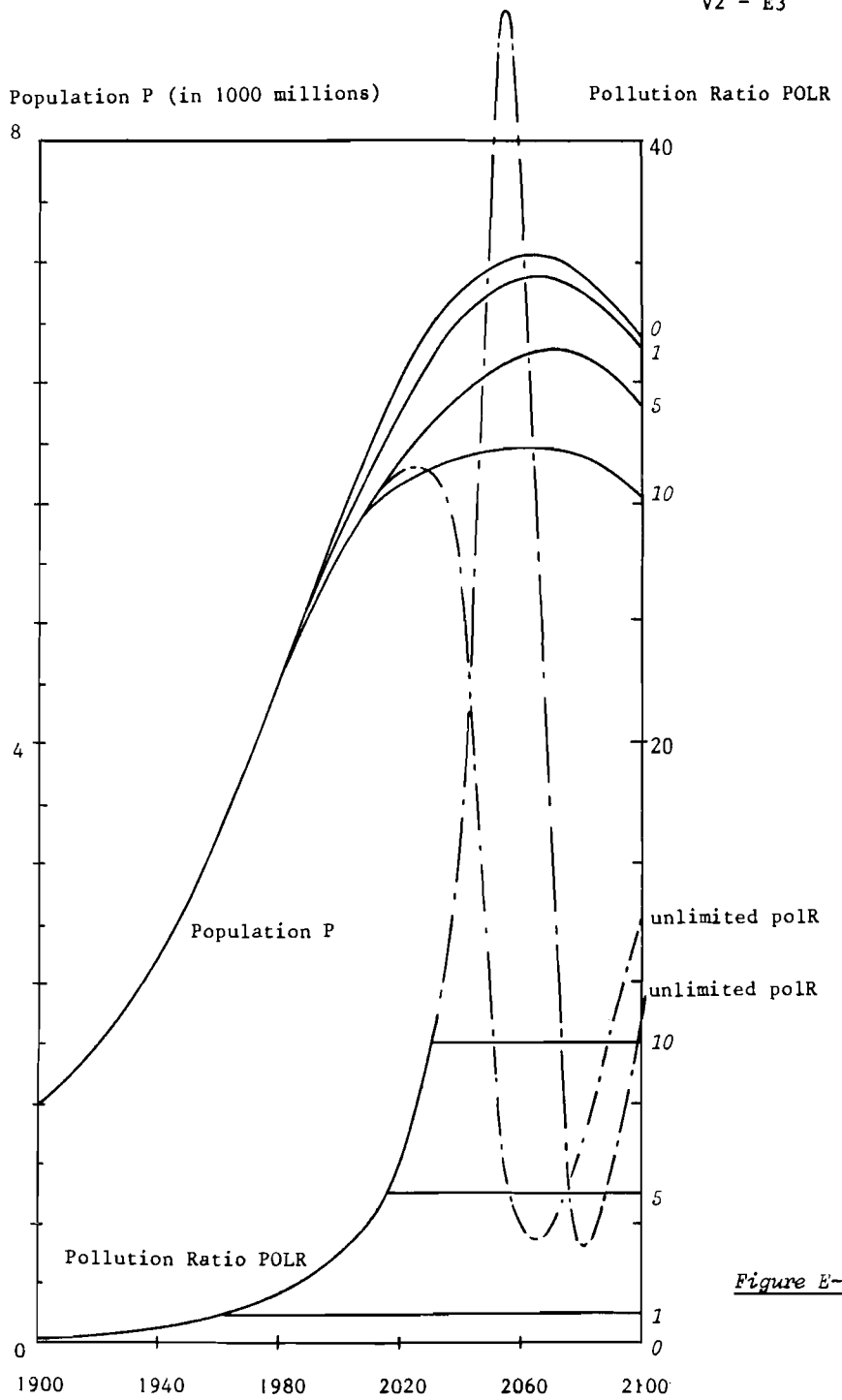

Figure E-3

Supplement to Figure 2 (*italics specify the upper limit of POLR*).

high (up to over six times that of 1970!!). However, we are dealing here with a situation about which science is groping utterly in the dark, while the 'running away' or not of the pollution is in most respects extremely dependent on the assumptions made (U11).



MODELLING WORK OF THE SYSTEMS ANALYSIS RESEARCH UNIT IN THE DEPARTMENT OF
THE ENVIRONMENT, UNITED KINGDOM

Philosophy

The modeller should, as far as possible, observe the behaviour of the system in a detached, objective way. His attitude should be that of a physicist endeavouring to explain the behaviour of an assembly of units, like a gas, in terms of the properties and interactions of the elements of the assembly - in this case the molecules. Similarly, the ecologist may explain the observed changes in an ecological system by modelling the properties and interactions of the species of plants and animals comprising the system. Economic models are constructed similarly.

This implies that, for global or regional modelling, it is necessary, in the description of the elements, to model the decision makers, just as closely as the physical world in which they exist. The concept of control is reserved until there is sufficient understanding of the system to realise, at what points and in what way, the trajectory of the system can be influenced.

Thus, the model should have high explanatory power: should be able to reproduce time series and to perform towards disturbances in entirely credible ways before it can be a basis for contemplating control action.

Elements of the model

Just as the behaviour of an ecological system can be traced back to the individual plants and animals: so the behaviour of human society can be traced back to the roles which people play in that society.

The role of the individual as consumer has been described very well by economists in terms of maximising utility. If we assume that for each good there is a corresponding utility and that the functional relationship between utility and

the quantity of the good is monotonic, then maximum utility is obtained when the consumer apportions his expenditure so as to make the marginal utilities equal. By observation of the expenditure patterns of consumers over a very wide range of incomes, we are able to deduce the form of the utility functions which describe the behaviour of individuals considered in aggregate. To use this description, we have to assume that as a tranche of people in one income band moves into a higher income band, the new pattern of expenditure will be appropriate to the higher income, i.e. what the rich do today the poor will do tomorrow when they have become richer. We have found that tolerably close fitting functions for the categories of food, shelter (including durables), travel, services and investment can be deduced from the expenditure patterns in the whole range of countries of the world.

The role of the investor whether as an individual, an institution. or the state is described by the apportioning of investment according to the profitability of the opportunity. More profitable ventures receive higher investment than low yielding ones.

The role of the manager in an enterprise is to make the most efficient use of the labour, raw materials and capital at his disposal. This is to be interpreted as efficient in the monetary sense and operating within the constraints set by the markets in labour and raw materials from which he buys. He must also operate within the regulations imposed to maintain safety, restricted emissions, etc.

The role of the legislator is to impose such regulations as are necessary to maintain safety, restricted emissions, etc. and ultimately he does this in response to the demands of the people en masse. i.e. reflecting the utilities they perceive from safety, clean air and water, etc.

The model

With certain additional relationships specifying the accounting aspects, the elements described above can be assembled to operate in time and generate time

series for observable variables, given initial conditions. Sectors whose outputs consist of food, shelter, travel and services buy their inputs from the further sectors of energy, metals, etc, hire their labour at the current rate and sell their products at the prices which consumers are prepared to pay.

To operate such a model it is necessary to specify the rate at which population is increasing, the way in which income is distributed and the change of sector inputs over time arising from resource exhaustion and technological advance. Over the last few decades, in the developed countries, there has been little change in income distribution, little effective resource exhaustion and technological advance has been fairly steady. The model described here fits the time series data in a credible manner, rather in the same way as the Cobb Douglas function with time driven technological advance fits the time series of labour, capital and output for individual countries. Indeed, the assumptions about the behaviour of role players in the industrial system which underlie the derivation of the Cobb Douglas function closely parallel the assumptions for this model.

A variety of tests have been performed on the model, to check stability and response to disturbance. These have been satisfactory except for response to a necessary substitution. There have been many substitutions take place in the past, e.g. coal for wood without the large fluctuation which we discovered in the model behaviour. The discrepancy lies in the method used to model investment behaviour. If we use investment based on past profitability then delays in the response of the price/market mechanism result in down-swings of output during the period of substitution.

Anticipation

It is clear that an anticipatory element is present in the investment criteria. Investors are influenced by their expectation of what the future holds. In order to model this effect, we operate a rehearsal of the future every few time steps; about once a year. The rehearsal consists of running the model forwards and

calculating the discounted return to investment in each of the sectors, including sectors which are in nascent form at the time the rehearsal starts. As a result of the rehearsal, investment is made according to the net present value of future return, and the main model run continues with that investment pattern until the next rehearsal.

This procedure has a profound effect on behaviour of the model during a period of substitution. For high discount rates, the down-swing of output occurs, but for low discount rates, there is virtually no down-swing at all. We argue that not only is behaviour of the model including anticipation realistic, but that our knowledge of the criteria used by decision makers responsible for investment suggests that they attempt rehearsals in an informal manner.

In order to use the model for projection purposes it is necessary to postulate the existence of sectors in "seed form" so that when the growth of the seed is possible because it is economically viable, then this can occur in the model. A range of such seed sectors can be specified for possible fruition during the next fifty years, e.g. desalination, solar farms, large scale recycling, etc.

The problems of pollution would appear to be outside the scope of the model described, but this is not so if it is accepted that there exists always a strong feedback mechanism, which operates when there is realisation of the dangers of pollution. The dislike of pollution is manifested in the form of regulations, standards, etc which entail the installation of pollution abatement equipment by the industries concerned, or in extreme cases the decline of the industry if the costs of abatement are too high. Costs of pollution abatement are therefore included in the accounting calculations for each sector, and the viability of present and future sectors then depends on these costs in addition to the costs of input materials, labour and depreciation of capital.

Technological advance

For any single product it is observable that the efficiency with which it has

been produced (measured by the quantities of labour, materials and energy which are required for one unit of output) tends to improve more slowly as time advances; appearing to approach a plateau asymptotically. The reasons for this are twofold. There are the laws of thermodynamics which limit the efficiency of processes like photosynthesis and the operation of heat engines. Secondly, the properties of materials do not allow of the development of perfect heat insulators, frictionless movement, etc.

The whole range of industrial and agricultural output can be measured by the quantity of structure or order (in a thermodynamic sense) which is created by the channelling of energy. The quantity $\sum -p \log p$ as the number of bits of information contained in an assembly with probability p of occurrence, can be calculated for each type of output and limits set on the efficiency with which this order can be created. In many cases there are two processes occurring concurrently. The natural structure which is present in the form of concentration of metalliferous ores, almost pure water, etc. is being depleted, but the efficiencies with which industrial activity is performed have been increasing. Both aspects of the production process must be represented in specifying the sectors.

The description in terms of quantity of order allows of a quantitative measure to be applied to the outputs of future sectors without the requirement to define the explicit character of the housing, travel, durables, etc which will be produced. The element of uncertainty which remains, is the rate at which approach is made to the limits set by thermodynamics and the properties of materials.

Exogeneous variables

Although there have been proposals for the construction of a causative population model with determinants of fertility in-built, the studies in this field appear insufficiently advanced to generate confidence in them. Fertility rates are therefore treated as exogeneous variables, and scenarios generated for alternative

possible rates.

The anticipation level, as reflected in the discount rate, although it may be estimated in a particular context is clearly influenced by the culture and attitudes prevailing. The publication of modelling results which indicate the effect of choosing particular discount rates can itself influence the effective discounting employed. Scenarios for differing discount rates are therefore required.

The variation of the quality of life is strongly affected by income distribution, within each country, but even more importantly between countries. There would not appear to be means of predicting the extent of altruism. but different scenarios corresponding to different levels of aid to the less developed countries can be generated.

Finally, the specifications for new sectors must be partly speculative, especially when the projections are pushed very far into the future and therefore scenario variation with respect to variation of these specifications is necessary.

Control

The possible futures appearing in these different scenarios may contain aspects regarded as undesirable. Many decision makers, i.e. many role players are involved in a given change of trajectory. Choosing a lower fertility rate is a matter of immense numbers of people deciding the movement into one future variation rather than another. It has been pointed out that the use of a particular discount rate has a strong effect on the stable performance of the system and the attitude of decision makers in this respect can be affected by believing that an undesirable future would result from too low a level of anticipation. The most radical effect on the future would be produced by a change in the products which consumers desire, i.e. by a change in the utility functions.

.....

A SYSTEM THEORETIC CONSIDERATION
OF THE WORLD MODEL.

YASUHIKO TAKAHARA

Tokyo Institute of Technology

Tokyo, Japan

1974

1. Introduction

In this paper we shall give a system theoretic consideration to the world model proposed by Mesarovic and Pestel group.¹⁾

In particular, we shall try to formulate key concepts underlying the model. This paper reports preliminary considerations and technical results will be presented in succeeding papers.

2. Formulation of the World Model

Fig. 1 shows a basic structure of the world model.²⁾ The model is characteristic of its hierarchical structure. The hierarchy consists of three fundamental strata, individual or norm strata, organizational or group strata and natural or causal strata. The individual strata is for individual persons on the world. The essential role of this strata in the world model is to specify a norm for decision making of world problems. This strata is, hence, called a norm strata and is characterized by its norm. Each individual person on the world is interested in many faces of world problems, e.g., food shortage, air pollution and others. These problems are represented by the causal strata. Let Y be the set of outcomes or conditions of the causal strata. Let X be the set of states of nature surrounding the causal strata. Then, the norm of the individual strata can be expressed by the following two families of mappings $\{G_i^{IN}\}$ and $\{T_i^{IN}\}$

$$\begin{aligned} G_i^{IN} : X \times Y &\longrightarrow V \\ T_i^{IN} : X &\longrightarrow V \end{aligned}$$

where $G_i^{IN}(x, y)$ is i -th individual's evaluation of the outcome y under the condition x of the nature and $T_i^{IN}(x)$ the tolerance limit for the present condition. V is an ordered set of values whose ordering will be denoted by \leq . Then, the i -th individual is satisfied with present condition y of the causal strata if the following relation holds.

$$(\forall x)(x \in X \longrightarrow G_i^{IN}(x, y) \geq T_i^{IN}(x))$$

The organizational strata represents policy-making and administrative functions of the world and its ultimate purpose is to control the causal strata so that every individual is satisfied with the outcome of it.

Since individuals are usually incompatible in their evaluations of

states one another, in the organizational strata goals and tolerance limits of the norm strata should be integrated into an aggregated goal G^A and tolerance limit T^A , i.e.,

$$G^A: X \times Y \longrightarrow V$$

$$T^A: X \longrightarrow V$$

It is not easy to find a reasonable aggregation of goals of individuals.

This problem will be considered later. G^A gives just an evaluation criterion of the state but does not specify controlling variables.

The organizational strata, then, have to form a goal and a model of the causal strata, which specify a manipulating input for the causal system.

Let the newly formed goal, referred to as an implementation goal G^{IMP} ,

and the model of the causal system be as follows :

$$G^{IMP}: M \times X \times Y \longrightarrow V$$

$$P : M \times X \longrightarrow V$$

where M is the set of manipulating inputs.

In the real world the causal strata is intrinsically regionalized. For instance, the population problems of the south east Asia are quite different from those of Latin America. Each local government is, hence, enforced to solve its problems in a regionalized way as well as in a global way. This is exactly a multilevel hierarchical structure.³⁾ In order to make the representation of the model simple we assume that the multilevel system is a two level system.

The basic structure of a two level system is shown in Fig. 2. Suppose the causal strata consists of n regions and let the submodel (subprocess) representing the i-th region be as follows.

$$P_i : M_i \times X_i \times U_i \longrightarrow Y_i \quad (i = 1, \dots, n) \quad (1)$$

where $M \subseteq M_1 \times \dots \times M_n$

$$Y = Y_1 \times \dots \times Y_n$$

$$X = X_1 \times \dots \times X_n$$

U_i represents the set of interaction inputs from the other regions.

Let the representation of the interaction be as follows :

$$K_i : X \times Y \longrightarrow U_i \quad (i = 1, \dots, n)$$

Each local organization which controls P_i is specified by its goal G_i and tolerance limit T_i , i.e.,

$$G_i : M_i \times X_i \times U_i \times Y_i \times C_i \longrightarrow V_i$$

$$T_i : X_i \longrightarrow V_i$$

C_i represents the set of coordinations from the upper level system.

The family of (P_i, G_i, T_i) ($i = 1, \dots, n$) constitutes the lower level system of the two level system. The upper level system is the coordinator

of the lower level system and is formally expressed by (G_o, P_o, T_o) , that is,

$$\begin{aligned} G_o &: C \times X \times F \longrightarrow V \\ P_o &: C \times X \longrightarrow F \\ T_o &: X \longrightarrow V \end{aligned}$$

where F is the set of feedback informations from the lower level and $C = C_1 \times \dots \times C_n$. The implementation goal G^{MP} is the overall goal for the two level system. The two level system is constructed to implement it. Although the final object of the coordination of the upper level system is to achieve the overall goal (implementation goal), its goal does not necessarily represent the overall goal directly. The immediate purpose of the upper level is to harmonize the lower level systems. It is not necessary that the upper level can achieve the overall goal though harmonizing conflicts among the lower level subsystems. This is a problem of goal harmony discussed later. In this multilevel structure communications among lower level decision makers do not exist in explicit forms. This does not mean that communications are not allowed. Rather in this model communications are embedded into the coordination scheme. In the weakest form of coordination it may be a channel for transmission of informations among the lower level decision makers while in the strongest the coordinator is a real decision maker who gathers information of the state of lower level and makes a decision of the coordination variable to harmonize the lower level.

When we construct a complex large scale system, the construction is usually done in a hierarchical way⁴⁾. This hierarchy will be referred to as a model building hierarchy. Fig. 3 shows that concept of hierarchy.

In Fig.3 X_i represents environmental conditions for model building, for instance, model specification, available data and others. Y_i represents a model. S_i is a model building procedure. W_i and C_i represents interactions among model building procedures. In Fig. 3 the lowest procedure S_1 is assumed to produce the most detailed and concrete model while the highest procedure S_n does the most abstract one. As the level goes up, a produced model becomes less detailed and more abstract. A model by S_i is constructed based on a less abstract model by S_{i-1} . The result of S_{i-1} is transmitted to S_i by w_i while the requirement from S_i to S_{i-1} by c_{i-1} . The model building hierarchy is, then, expressed as follows :

$$\begin{aligned}
 S_n &: X_n \times W_n \longrightarrow Y_n \\
 S_1 &: X_1 \times C_1 \longrightarrow Y_1 \\
 S_i &: X_i \times W_i \times C_i \longrightarrow Y_i \quad (2 \leq i \leq n-1) \\
 h_i &: Y_i \longrightarrow W_{i+1} \quad (1 \leq i \leq n-1) \\
 k_i &: Y_i \longrightarrow C_{i-1} \quad (2 \leq i \leq n)
 \end{aligned}$$

Due to their roles in the hierarchy h_i and k_i will be referred to as abstraction mapping and request mapping, respectively. Let

$$\begin{aligned}
 X &= X_1 \times \dots \times X_n \\
 Y &= Y_1 \times \dots \times Y_n
 \end{aligned}$$

Then the model building hierarchical system is defined by the following mapping S :

$$S : X \times \{h\} \times \{k\} \longrightarrow Y$$

where $h = (h_n, \dots, h_{n-1})$

$$k = (k_n, \dots, k_2)$$

such that the following consistency relations hold.

$$S_n(x_n, w_n) = y_n; S_1(x_1, c_1) = y_1;$$

$$S_i(x_i, w_i, c_i) = y_i \quad (2 \leq i \leq n-1)$$

$$h_i(y_i) = w_{i+1} \quad (1 \leq i \leq n-1)$$

$$k_i(y_i) = c_{i-1} \quad (2 \leq i \leq n)$$

The world model proposed by Mesarovic and Pestel can be characterized by the above two types of hierarchy, that is, hierarchical model and hierarchical model building. Based on the above formulation key concepts and problems for the world model will be presented in the next section.

3. Basic Concepts of the World Model

In order to discuss basic concepts and problems of the world model we need concepts of similarity of models and extended topology. They are briefly presented in Appendix.

Since the world is a complex system, study of it produces many problems. In this paper, since we cannot cover every problem of it due to apparent reasons, we shall discuss the following concepts which seem the most fundamental for the model; interaction for the causal strata, goal harmony for the hierarchical structure, structural stability for the overall model, vertical decoupling and modeling stability for the hierarchical modeling.

3.1 Interaction

Usually a large scale system is used as a synonym of a complex system. However, a large scale system is not necessarily a complex system. This is clear if we consider a large scale linear programming problem. However large its size may be, a linear programming problem is conceptually quite simple.

Intuitively a system is complex when it is forced to be recognized as consisting of interacted subsystems. Thus we ^{can} say that complexity is characterized by interactions. The causal system of the world model is usually a huge system and difficult to be handled effectively. However, if its difficulty were solely due to its largeness, its difficulty might be solved by only technical improvement in data gathering and handling. But in reality its difficulties come from its complexity as well as its largeness. The difficulty due to complexity cannot be

overcome without understanding basic properties of interaction.

Since an interaction is usually a given value, it is considered a primary concept but as the following example shows, it is a secondary one and its expression depends on modeling of a complex system. Fig.4 illustrates a simple interacted system. This system consists of two subsystems whose input and output are m_1 and m_2 and y_1 and y_2 , respectively. In Model A of Fig. 4 these subsystems are represented by

$$\left. \begin{aligned} y_1 &= 10 m_1 + y_2 \\ y_2 &= 20 m_2 + 2 y_1 \end{aligned} \right\} (2)$$

In this model it is natural to specify the interaction inputs as $u_1 = y_2$ and $u_2 = y_1$. If we solve the above system equations (2) with respect to y_1 and y_2 , we have

$$\left. \begin{aligned} y_1 &= -10 m_1 - 20 m_2 \\ y_2 &= -20 m_2 - 20 m_1 \end{aligned} \right\} (3)$$

It is clear that these newly obtained equations (3) also represent the original interacted system. Model B in Fig. 4 illustrates the representation by Eq. (3) where the interactions are $u_1 = m_2$ and $u_2 = m_1$.

The above simple example shows that an interaction cannot be uniquely determined even if its existence is doubtless. Furthermore, the representation of a model of an interacted system is shown to change drastically depending on selection of the interaction. The second fact cannot be overlooked because in practice it is common to estimate a rough behavior of a subsystem by neglecting its interaction input. If we do so for the above example, the input and output relation of S_1 in Model A is given by

$$y_i = 10 m_i$$

while that in Model B is given by

$$y_i = -10 m_i$$

On estimating the behavior of S_i , Model A will, then, produce a result completely different from that Model B does.

We know that an interaction is vital to a complex system and also have known that it is a secondary concept and that its expression depends on modeling of the complex system just as the representation of a state space depends on modeling of a dynamical system. Then, an important problem is to clarify how an interaction concept can be derived from a suitably chosen primary concept. As a primary concept the following definition of a complex system can be used.

$$\begin{aligned} \text{Let } M & \subset M_1 \times \dots \times M_m \\ X & \subset X_1 \times \dots \times X_m \\ Y & \subset Y_1 \times \dots \times Y_m \end{aligned}$$

Def. 1 : Complex System

Let $S_{\tilde{n}} \subset (M_{\tilde{n}} \times X_{\tilde{n}}) \times Y_{\tilde{n}}$ ($\tilde{n} = 1, \dots, m$). A system $S \subset (M \times X) \times Y$ is called a complex system if and only if the following holds

$$S \subset S_1 \times \dots \times S_m$$

The above definition is not accurate in the sense that $(M \times X) \times Y$ cannot be a subset of $S_1 \times \dots \times S_m$. However, since S can be embedded into $S_1 \times \dots \times S_m$ in the obvious way, we use the definition of complex

system in the above form. In Def. 1 S_{λ} is apparently a subsystem of S. A definition of mutual dependency of subsystems can be introduced as follows.

Def. 2 : Mutual Dependency

Subprocesses are mutually dependent if and only if S is a proper subset of $S_1 \times \dots \times S_m$.

The mutual dependency implies the existence of interactions among subsystems and really we can show that if subsystems are mutually dependent, then there exist an interaction variable u_{λ} and the complex system can be represented by Eq. (1). These technical facts will be reported in the succeeding paper.

3.2 Goal harmony

The world model is essentially a goal seeking system and hence its behavior is specified by its goals. As Fig. 1 shows the world model consists of various kinds of goals. Goals of the model are classified as individual goals G_{λ}^{IN} , aggregation goals G^A , implementation goal G^{IMP} and goals of the multilevel system. These classified goals are not independent and related by transformation, i.e., goal transformations.

Let the goal transformations be as follows.

$$\begin{aligned} \Psi^A &: \prod_{\lambda} \{G_{\lambda}^{IN}\} \longrightarrow \{G^A\} \\ \Psi^{IMP} &: \{G^A\} \longrightarrow \{G^{IMP}\} \\ H &: \{G^{IMP}\} \longrightarrow \{(G_0, G_1, \dots, G_m)\} \end{aligned}$$

where $\{G_{\sim}^{IN}\}$, $\{G^A\}$, $\{G^{IMP}\}$ and $\{G_0, \dots, G_m\}$ are the sets of goals of G_{\sim}^{IN} , G^A , G^{IMP} and (G_0, \dots, G_m) , respectively. The goal transformations cannot be arbitrary and should satisfy some properties if they are accepted as reasonable by the society. The goal harmony is one of such properties. In order to define the goal harmony we shall introduce several ordering relations. Let $\leq(G_{\sim}^{IN}) \subset Y \times Y$ be

$$y \leq(G_{\sim}^{IN}) y' \leftrightarrow (\forall x)(G_{\sim}^{IN}(x, y) \leq G_{\sim}^{IN}(x, y'))$$

that is, the situation y' of the causal strata is preferred to the situation y by the \sim -the individual if and only if in any environmental conditions y' yields bigger value of G_{\sim}^{IN} than y does. It is easy to see that $\leq(G_{\sim}^{IN})$ is a partial ordering relation. The family of the ordering relations $\{\leq(G_{\sim}^{IN})\}$ determines a partial ordering $\leq(G^M)$ on Y as follows.

Let $\leq(G^M) \subset Y \times Y$ be

$$y \leq(G^M) y' \leftrightarrow (\forall \sim)(y \leq(G_{\sim}^{IN}) y')$$

The relation $\leq(G^M)$ may be called preference of the society. Similarly aggregated goal G^A defines a partial ordering relation $\leq(G^A)$ on Y as follows.

$$y \leq(G^A) y' \leftrightarrow (\forall x)(G^A(x, y) \leq G^A(x, y'))$$

A goal harmony with respect to Ψ^A is, then, defined by $\leq(G^M)$ and $\leq(G^A)$ as follows.

$$y \leq(G^M) y' \longrightarrow y \leq(\Psi^A(G^M)) y' \quad (4)$$

That is, if y' is preferred to y by the society, then y' should be also preferred to y by the aggregated goal $\Psi^A(G^M)$, or the goal harmony requires that the goal transformation should transform $\prod_{\sim} \{G_{\sim}^{IN}\}$ so that the relation

(4) holds. A goal harmony can be defined in various ways. For instance

$$y \leq (\Psi^A(G^{IM})) y' \longrightarrow y \leq (G^{IN}) y'$$

is another form of a goal harmony of Ψ^A . A goal harmony with respect to Ψ^{IMP} can be formulated as follows. Let $\leq(G^{IMP}) \subset M \times M$ and $\leq(G^AP) \subset M \times M$ be such that

$$\forall m \leq(G^{IMP}) m' \iff (\forall x) (G^{IMP}(m, x, P(m, x)) \leq G^{IMP}(m', x, P(m', x)))$$

and

$$\forall m \leq(G^AP) m' \iff (\forall x) (G^A(x, P(m, x)) \leq G^A(x, P(m', x)))$$

Then, a goal harmony of Ψ^{IMP} is given by the following relation

$$m \leq(G^{IMP}) m' \longrightarrow m \leq(G^AP) m'$$

Finally, let $\leq(G_0) \subset C \times C$ be such that

$$\gamma \leq(G_0) \gamma' \iff (\forall x) (G_0(\gamma, x, P_0(\gamma, x)) \leq G_0(\gamma', x, P_0(\gamma', x)))$$

Let $\hat{m}_i(\gamma) \in M_i$ be a decision made by the i -th subsystem of the lower level goal seeking system when a coordination $\gamma \in C$ is given. Let

$\hat{m}(\gamma) = (\hat{m}_1(\gamma), \dots, \hat{m}_n(\gamma))$. Then, a goal harmony of H is given by as follows.

$$\gamma \leq(G_0) \gamma' \longrightarrow \hat{m}(\gamma) \leq(G^{IMP}) \hat{m}(\gamma') \quad (5)$$

The goal harmony given by (4) has been studied in the social welfare function theory where Ψ^A corresponds to a social welfare function⁵⁾.

Some conditions has been known when Ψ^A satisfies the goal harmony.

The goal harmony of Ψ^{IMP} has not been studied so much in a formal framework. The modified form of this has been treated by social sciences such as economics, political science and/or sociology. One of the typical result of this goal harmony may be the theory of price mechanism. If P is an ideal market, we know fairly well how to construct G^{IMP} from G^A . The goal harmony of H is a main subject of multilevel systems theory³⁾.

It is not easy to construct G from G^{IMP} such that (5) is satisfied and so in many practical constructions of multilevel systems a modified form of (5) is used³⁾.

3.3 Structural stability

Stability has been a central topic of systems theory and most of the researches are concerned with dynamical stability. Dynamical stability is certainly important for a large scale complex systems, but when we apply a theory of dynamical stability to a system, we must have a fairly accurate model of it. This is usually hard to be expected for a large scale complex system. This enforces us to try to find a method to treat a system stability in a qualitative way. The structural stability we shall present below is a static and qualitative concept of stability. This type of stability has not been studied so much so far⁶⁾. However, it has to be studied with increasing attention.

Suppose the structure of the world model is represented by a triplet (ψ^A, ψ^{IMP}, H) . In the real world ψ^A , ψ^{IMP} and H may be considered to correspond to a political structure, an administrative structure and a bureaucratic structure, respectively. In general the form of (ψ^A, ψ^{IMP}, H) is dependent on the environmental conditions. Let the dependency be denoted by R_1 , that is,

$$R_1 : X \longrightarrow \{(\psi^A, \psi^{IMP}, H)\}$$

Certainly, it is very difficult to determine a concrete form of R_1 and moreover, R_1 may be a relation rather than a mapping. Since the purpose of this paper is to present basic concepts of the world model

rather than any deep results, we proceed our argument assuming that R_1 is a given function. Let R_2 be a mapping from the set of structures into a set of forms of model (Refer to Appendix) i.e.,

$$R_2 : \{(\Psi^A, \Psi^{IMP}, H)\} \longrightarrow \{\text{form of model } \alpha\}$$

Then, the structural stability of the world model is defined as follows.

Def. 3 : Structural stability

The world model is stable at the form f if and only if

$$(\forall N(f))(\exists N(x))(R_2 R_1(N(x)) \subset N(f))$$

where $R_2 R_1(x)=f$ and $N(f)$ and $N(x)$ are neighborhoods of f and x , respectively (Refer to Appendix).

Roughly speaking, the model is of structural stability if the form of the model does not change as far as the change of environment is not so large.

A Lyapunov type stability has been considered in the framework of general systems theory and some solid results have been obtained for it⁷⁾. The structural stability may be more difficult than the Lyapunov type stability but is worthy of making a hard research effort.

3.4 Vertical decoupling

When we build a model of a complex large scale system, the model building procedure itself is a complicated system and hence can be a research subject of complex systems theory.

As mentioned in Section 2, in the present project the world model is built in a hierarchical way. There are two concepts of significance

for the hierarchical model building. One concept is vertical decoupling and another modeling stability. These concepts are related each other. We first introduce vertical decoupling.

Def. 4 Vertical decoupling

The model building procedure is of vertical decoupling at $(\hat{\omega}_{i+1}, \hat{c}_{i-1})$ ($i=1, \dots, n$) if and only if

$$(\forall x_i)(\exists h_i)(\exists k_i)(h_i(y_i) = \hat{\omega}_{i+1} \ \& \ k_i(y_i) = \hat{c}_{i-1})$$

If the model building procedure is vertically decoupled, then for any environmental change we can keep the interlevel interaction variable ω_i and c_i constant by adjusting the interfacing mappings h_i and k_i . If it is not difficult to adjust h_i and k_i , then the vertical decoupling is a quite desirable property. Modeling stability is introduced as follows.

Def. 5 : Modeling stability

The hierarchical model building is stable at $\hat{x} = (\hat{x}_1, \dots, \hat{x}_n)$ if and only if

$$(\forall N(\hat{x}_i))(\forall x_i \in N(\hat{x}_i))(\exists h_i)(\exists k_i)(h_i(y_i) = h_i(\hat{y}_i) \ \& \ k_i(y_i) = k_i(\hat{y}_i))$$

This concept is related to the ability of adjustment of the system. If the system is of stability in the above sense, then as far as an environmental change is not so large, the system can adjust the interfacing mapping so that the interlevel interaction variables remain constant. Consequently in the case of stability a change of one level does not influence the other levels. There is an obvious relation between

the vertical decoupling and the modeling stability. That is

Proposition 1

If a model building hierarchy is of vertical decoupling, then it is of modeling stability.

4. Conclusion

In this paper we made a system theoretic consideration for the world model proposed by Mesarovic and Pestel group.

We formulated several problems of the model. They should be clarified to some extent before we understand the structure of the model.

Technical results of these problems will be reported in the succeeding paper.

REFERENCES

1. Mesarović, M.D. and Pestel, E., *"Regionalized and Adaptive Model of the Global World System"*, Systems Research Center, Case Western Reserve Univ., Cleveland, Ohio, 1973.
2. Hughes, B.B., *"Current Status of the Mesarović-Pestel World Model Project"*, Systems Research Center, Case Western Reserve Univ., Cleveland, Ohio, 1973.
3. Mesarović, M.D., Macko, D. and Takahara, Y., *Theory of Multilevel, Hierarchical Systems*, Academic Press, 1970.
4. Mesarović, M.D., "On Vertical Decomposition and Modeling of Large Scale Systems", in *Decomposition of Large-Scale Problems* edited by D.M.Himmelblau, North-Holland, 1973.
5. Arrow, K.J., *Social Choice and Individual Values*, Wiley, 1963.
6. Thom, R., *Stabilité Structurelle et Morphogénèse*, Benjamin, 1972.
7. Mesarović, M.D. and Takahara, Y., *Foundations for the Mathematical Theory of General Systems*, Academic Press, 1974.

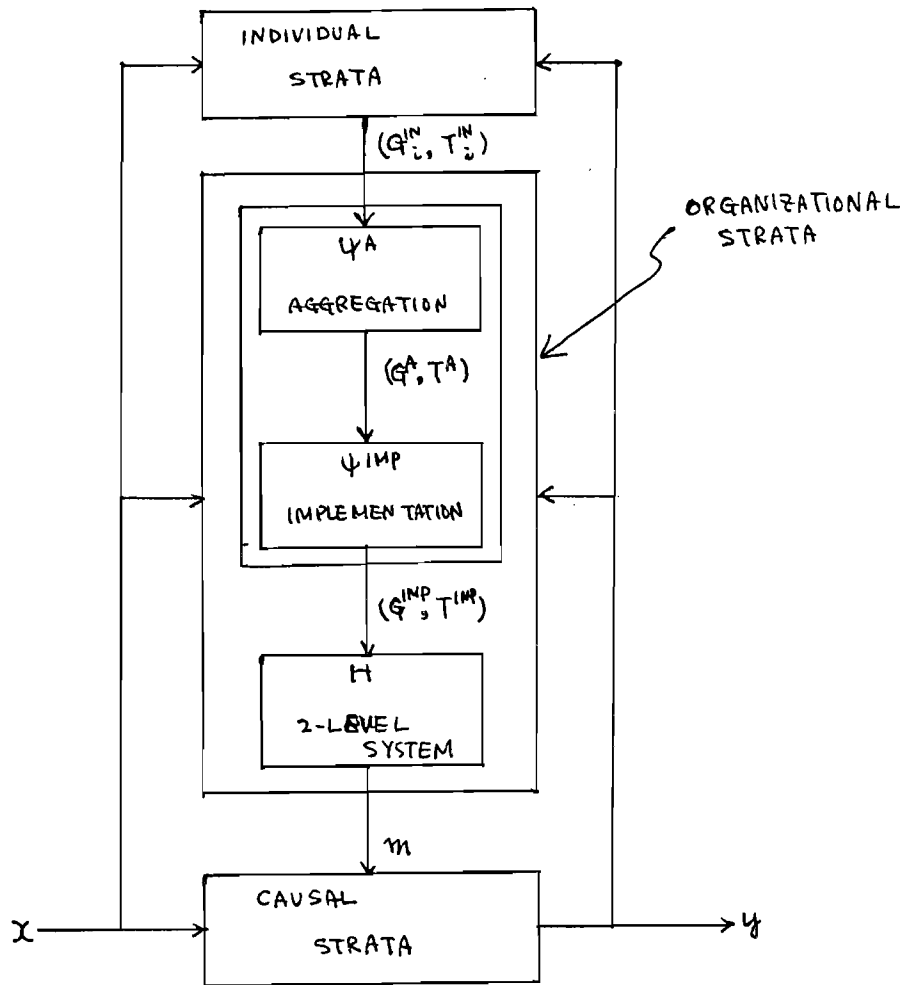

FIG. 1

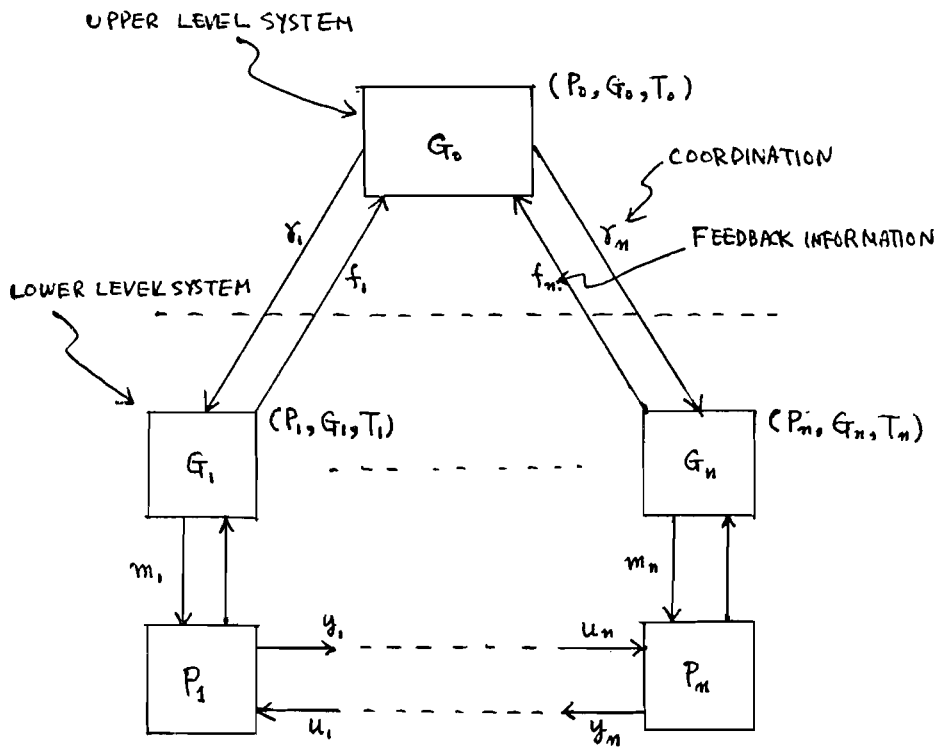

FIG. 2

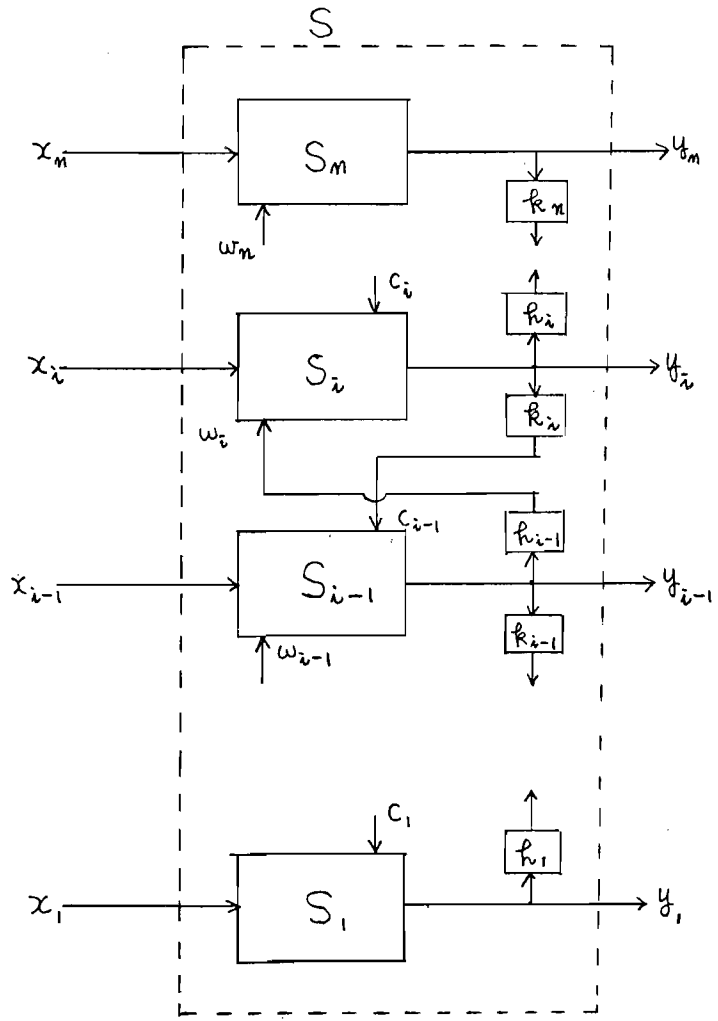

FIG. 3

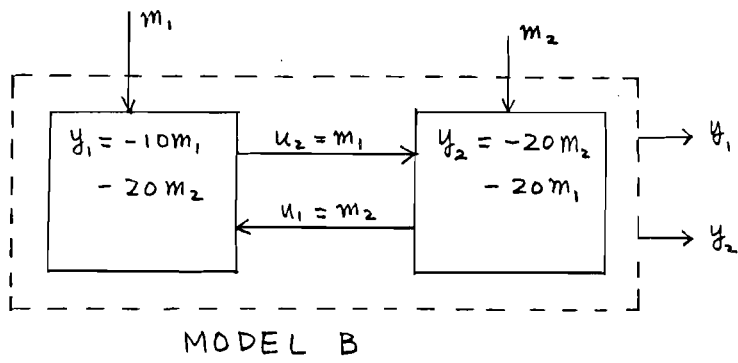
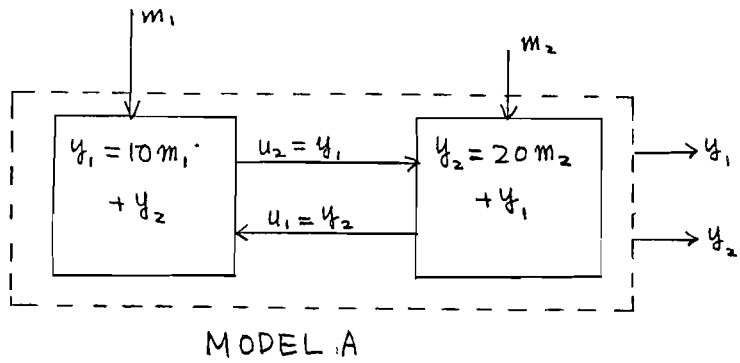

FIG. 4

Appendix

I Form of Models

When we define a structural stability of the world model, we use the concept of a form of models. Let M_d be a set of models in consideration.

Let

$$E \subset M_d \times M_d$$

be a similarity relation. A similarity relation is an equivalence relation. Let Y be the quotient set of M_d with respect to E , that is

$$Y = M_d / E$$

Then, the equivalence class $[m] \in Y$ ($m \in M_d$) is referred to as the form of the model m and Y the set of forms. The similarity relation E is the most essential for the above definition. In order to illustrate the concept let us consider the following example. Let Model 1 and Model 2 be represented by the following equations.

$$\text{Model 1: } f_1(\alpha_1, \dots, \alpha_m) = 0$$

$$\text{Model 2: } f_2(\alpha_1, \dots, \alpha_m) = 0$$

where $\alpha_i \in \mathbb{R}$ is a parameter. Then, a similarity relation can be defined as follows.

$$f_1 \text{ is similar to } f_2 \iff [n = m \text{ and } (\exists h: \mathbb{R} \rightarrow \mathbb{R})(\exists k_2: \mathbb{R} \rightarrow \mathbb{R})$$

(h and k_2 are one-to-one correspondences and

$$h f_1(\alpha_1, \dots, \alpha_n) = f_2(k_2 \alpha_1, \dots, k_2 \alpha_n)$$

holds for any $(\alpha_1, \dots, \alpha_n)$)]

II Extended topology

The concept of neighbourhoods is also used for the definition of stability. That concept is topological. In general we cannot expect

the standard notion of topology holds for the world model and hence we have to use a generalized topology. The following is a generalized concept of neighbourhoods.

Let X and A_{λ} be arbitrary sets. Let

$$H_{\lambda} : X \longrightarrow A_{\lambda}$$

be a mapping called classification mapping where $\lambda \in I$.

Let $\bar{H} = \{H_{\lambda} \mid \lambda \in I\}$. For each $\lambda \in I$ let

$$E_{\lambda} \subset X \times X$$

be such that

$$(x, x') \in E_{\lambda} \iff H_{\lambda}(x) = H_{\lambda}(x')$$

Let $[X]_{\lambda} = \{x' \mid (x, x') \in E_{\lambda}\}$

Then, $\{[X]_{\lambda} \mid \lambda \in I\}$ can be used as a generalized neighbourhood system of

$x \in X$ ⁷⁾. If the set of human beings on the world is taken as X , H_{λ} may be race, ideology and others.

Roberto VACCA - Italy

A certain optimism was detectable in Prof. Pestel's statement to the effect that decision makers at large seem to be more aware than others (in particular more than scientists) of the existence and urgency of impending crises and dangers to associated life and to the planet in general.

I do not share that optimism and I ask: what is the sense of having an interactor originate policy and strategy proposals and solutions, unless the interactor is actually a decision maker and there may be a certain confidence that he may be active in implementing the most hopeful proposals and solutions? In fact the mere singling out of hopeful proposals and solutions may be argued to represent nothing more than another form of the "greenhouse approach," unless at least the probability of implementation is also determined.

Decision makers, both in government and in very large industrial organizations, have not appeared to be too sensitive to their responsibilities toward the issues raised by the many predicaments mankind is at present faced by. On the other hand decision makers are to some extent sensitive to the eventual pressure of public opinion. Would it not be appropriate to include in a global model an analysis on: the existence, the effectiveness and the evolution of public opinion (and eventually of voting opinion) on the complicated problems of large systems? This should also lead to an analysis of cultural trends and traditions, which may certainly be relevant to decide future developments (not only eating habits and life styles) see page 10 of the Mesarovic-Pestel Report for Salzburg, CRITICAL CHOICES FOR MANKIND: LIMITS TO INDEPENDENCE) but also: population levels and improvement of human performance on a large scale). It may be argued, in fact, that one of the more urgent action items is a massive cultural upgrading of the cultural and educational levels of large masses of population in order to achieve: a more informed and more efficient public opinion (in particular capable of exerting an action on decision makers), and a higher probability of abler and authoritative decision makers and active interactors coming into existence.

