

IIASA COLLABORATIVE PROCEEDINGS SERIES

---

CP-82-S10

**THE KINKI INTEGRATED  
REGIONAL DEVELOPMENT  
PROGRAM**

## IIASA COLLABORATIVE PROCEEDINGS SERIES

- CP-81-S1      LARGE-SCALE LINEAR PROGRAMMING  
Proceedings of an IIASA Workshop  
G.B. Dantzig, M.A.H. Dempster, and M.J. Kallio, *Editors*
- CP-81-S2      THE SHINKANSEN PROGRAM: TRANSPORTATION, RAILWAY,  
ENVIRONMENTAL, REGIONAL, AND NATIONAL DEVELOPMENT  
ISSUES  
A. Straszak, *Editor*
- CP-82-S1      HUMAN SETTLEMENT SYSTEMS: SPATIAL PATTERNS  
AND TRENDS  
Selected Papers from an IIASA Conference  
T. Kawashima and P. Korcelli, *Editors*
- CP-82-S2      RISK: A SEMINAR SERIES  
H. Kunreuther, *Editor*
- CP-82-S3      THE OPERATION OF MULTIPLE RESERVOIR SYSTEMS  
Proceedings of an International Workshop, Jodłowy Dwor, Poland  
Z. Kaczmarek and J. Kindler, *Editors*
- CP-82-S4      NONPOINT NITRATE POLLUTION OF MUNICIPAL WATER  
SUPPLY SOURCES: ISSUES OF ANALYSIS AND CONTROL  
Proceedings of an IIASA Task Force Meeting  
K.-H. Zwirnmann, *Editor*
- CP-82-S5      MODELING AGRICULTURAL-ENVIRONMENTAL PROCESSES IN  
CROP PRODUCTION  
Proceedings of an IIASA Task Force Meeting  
G. Golubev and I. Shvytov, *Editors*
- CP-82-S6      LIQUEFIED ENERGY GASES FACILITY SITING:  
INTERNATIONAL COMPARISONS  
H. Kunreuther, J. Linnerooth, and R. Starnes, *Editors*
- CP-82-S7      ENVIRONMENTAL ASPECTS IN GLOBAL MODELING  
Proceedings of the 7th IIASA Symposium on Global Modeling  
G. Bruckmann, *Editor*
- CP-82-S8      PROGRESS IN NONDIFFERENTIABLE OPTIMIZATION  
E.A. Nurminski, *Editor*
- CP-82-S9      INNOVATION POLICY AND COMPANY STRATEGY  
H. Maier and J. Robinson, *Editors*
- CP-82-S10     THE KINKI INTEGRATED REGIONAL DEVELOPMENT PROGRAM  
Y. Sawaragi and A. Straszak, *Editors*

# **THE KINKI INTEGRATED REGIONAL DEVELOPMENT PROGRAM**

Y. Sawaragi and A. Straszak  
Editors

INTERNATIONAL INSTITUTE FOR APPLIED SYSTEMS ANALYSIS  
Laxenburg, Austria  
1982

## NOTE

The International Institute for Applied Systems Analysis is a nongovernmental, multidisciplinary, international research institution whose goal is to bring together scientists from around the world to work on problems of common interest.

IIASA pursues this goal, not only by pursuing a research program at the Institute in collaboration with many other institutions, but also by holding a wide variety of scientific and technical meetings. Often the interest in these meetings extends beyond the concerns of the participants, and proceedings are issued. Carefully edited and reviewed proceedings occasionally appear in the International Series on Applied Systems Analysis (published by John Wiley and Sons Limited, Chichester, England); edited proceedings appear in the IIASA Proceedings Series (published by Pergamon Press Limited, Oxford, England) and elsewhere.

When relatively quick publication is desired, unedited and only lightly reviewed proceedings reproduced from manuscripts provided by the authors of the papers appear in this IIASA Collaborative Proceedings Series. Volumes in this series are available from the Institute at moderate cost.

International Standard Book Number 3-7045-0053-4

---

Volumes in the *IIASA Collaborative Proceedings Series* contain papers offered at IIASA professional meetings, and are designed to be issued promptly, with a minimum of editing and review.

The views or opinions expressed in this volume do not necessarily represent those of the Institute or the National Member Organizations that support it.

---

Copyright © 1982 International Institute for Applied Systems Analysis  
A-2361 Laxenburg, Austria

All rights reserved. No part of this publication may be reproduced or transmitted in any form or by any means, electronic or mechanical, including photocopy, recording, or any information storage and retrieval system, without permission in writing from the publisher.



## PREFACE

The International Institute for Applied Systems Analysis has examined a series of large-scale development programs from an international and interdisciplinary point of view. This work began in 1975 and encompassed four such programs: The Tennessee Valley Authority in the United States (Knop 1976 and 1979), the Bratsk-Ilimsk Territorial Production Complex in the Soviet Union (Knop 1977 and Knop and Straszak 1978), The Shinkansen Program in Japan (Straszak and Tuch 1980 and Straszak 1981), and the Kinki Integrated Regional Development Program in Japan. This volume deals with the last of these studies.

The work on the Kinki IRDP began in 1973 with a scientific group from the regional universities led by Professor Y. Sawaragi of Kyoto University; this group cooperated with the Tokyo Scientific Center of IBM Japan. Then in 1976 the Japanese analysis team joined the IIASA group working on large-scale development programs in a cooperative effort.

This book covers not only the contributions made at the Kinki IRDP Workshop held at IIASA in June 1978 but also the results of additional work done at IIASA, in Japan, and elsewhere. The first part of the book reviews the Kinki IRDP problématique: the region's situation and relations to other regions, its administrative division, its economic and demographic structure, its main congestions and other problems, the issues and problems it faces, and so on.

The second part presents some findings of IIASA's 1977 study of the Kinki region.

The third part is devoted to some general aspects of regional planning and programming. First, it considers the general regional planning process and its relation to the Kinki IRDP; next, it discusses some IIASA views as to the role of models in IRD programs; then, it presents the framework developed for organizing regional programs and evaluating policy formulation.

The fourth part deals with models for integrated regional development programs. It summarizes the experiences of IBM Japan in developing and using computer systems for regional planning, presents a method for recognizing basic regional issues and their structure, and describes a model for ultra-long-term integrated development for the Kinki region.

The fifth part is devoted to models for particular problem areas: terminal site location, environmental impact, impacts on the living environment (including cultural assets), water supply and treatment, and water resources management.

The sixth part presents methods for solving regional problems: multi-objective mathematical programming applied to social planning, the nested Lagrangian multiplier method applied to environmental system planning, and an approach toward group decision.

The seventh part sets forth some concluding remarks.

The support of the Japan IIASA Committee, Kyoto and Osaka Universities, IBM Japan, and IIASA made the preparation of this study possible, and we tender special thanks to all of them.

Y. SAWARAGI  
A. STRASZAK



## CONTENTS

<b>I. INTRODUCTION</b>	1
An Overview of the Kinki Region Problématique <i>Y. Sawaragi and Y. Suzuki</i>	2
<b>II. THE FIELD STUDY</b>	11
Planning, Modeling, and Environmental Decision Making – A Case Study of the Kinki Region in Japan <i>S. Ikeda, J.W. Owsinski, and D. V. Winterfeldt</i>	12
<b>III. REGIONAL PLANNING AND PROGRAMMING AND THE ROLE OF MODELS</b>	31
The Concept, Process, and Method of Regional Planning and the Kinki Regional Development Program <i>K. Yoshikawa</i>	32
The Role of Models in Integrated Regional Development Programs <i>M.M. Albegov, J.W. Owsinski, and A. Straszak</i>	60
A Framework for Evaluating Regional Program Organization and Policy Formulation <i>R. Ostrowski and A. Straszak</i>	80
<b>IV. MODELS FOR INTEGRATED REGIONAL DEVELOPMENT PROGRAMS</b>	107
IBM Experiences in Urban and Regional System Development <i>T. Shiina, T. Ainai, T. Tohyama, and T. Matsuzaki</i>	108
Identifying a Regional Problem Structure by DEMATEL: A Trial <i>H. Miyazaki, Y. Eguchi, Y. Nishikawa, A. Udo, T. Matsuzaki, and T. Ainai</i>	144
The Kinki Model Directed to Ultra-Long-Term Integrated Regional Development Planning <i>Y. Suzuki, H. Ishitani, and K. Shoji</i>	160
Summary of the Discussion ( <i>J. Kacprzyk</i> )	194
<b>V. MODELS FOR PROBLEM AREAS</b>	197
Current Research Directions in Problems of Terminal Site Location <i>Y. Nagao and I. Wakai</i>	198

A Simulation Model for Regional Environmental Impact Analysis – A Case Study for the Kinki Region <i>Y. Suzuki, K. Ito, and T. Ono</i>	221
An Analysis of Inhabitant's Evaluations of Living Environments Stressing Interests in Local Cultural Assets <i>Y. Nishikawa, H. Itakura, T. Yamauchi, and H. Yoshida</i>	241
A Planning Model for Managing Water Supply and Treatment Linked with an Integrated Regional Development Model <i>Y. Suzuki, T. Ono, N. Adachi, K. Shoji, K. Ito, S. Tsujio, P.S. Pak,     and H. Kamitani</i>	267
A Linear Programming Model for Water Resources Management Applied to the Yodo River Basin <i>K. Yoshioka, N. Adachi, and H. Tokumaru</i>	297
Summary of the Discussion ( <i>J. Kacprzyk</i> )	312
<b>VI. METHODS</b>	<b>315</b>
A Multiobjective Mathematical Programming Method Applied to Social Planning Problems <i>Y. Nishikawa, N. Sannomiya, A. Udo, and T. Takehara</i>	316
Evaluation in Environmental System Planning: The Nested Lagrangian Multiplier Method <i>F. Seo and M. Sakawa</i>	352
An Assessment of the Residential Environment in Kyoto City: A Trial Toward Group Decision <i>H. Nakayama, K. Inoue, and Y. Sawaragi</i>	381
Summary of the Discussion ( <i>J. Kacprzyk</i> )	402
<b>VII. CONCLUDING REMARKS</b>	<b>405</b>
Appendix: Other papers given at the Workshop	408

Part I

INTRODUCTION

## AN OVERVIEW OF THE KINKI REGION PROBLÉMATIQUE

Y. Sawaragi

*Department of Applied Mathematics and Physics,  
Kyoto University, Kyoto, Japan*

Y. Suzuki

*Department of Electrical Engineering, Osaka  
University, Osaka, Japan*

### 1. THE KINKI REGION

Since there is no local government for the Kinki region—indeed, its territory is only vaguely defined—we can say only that its area is between about 27,000 and 37,000 square kilometers. As shown in Figure 1, it is situated at almost the middle of the Japanese island and has eight prefectures: Osaka, Hyogo, Kyoto, Shiga, Wakayama, Nara, Fukui, and Mie. However, a narrower view would exclude the Fukui and Mie prefectures. From the view of economic relations, there is a close interrelation among the seven prefectures (exclusive of the Mie prefecture); evidence of this is shown in Figure 2. In fact, the division of the Ministry of International Trade and Industry (MITI) in Osaka serves these seven prefectures.

#### 1.1. Geography

The area of the eight prefectures together is 37,200 km<sup>2</sup> and the population was 21,200 thousand in 1975, the shares of the Japan total being 9.9 and 19.0 percent, respectively. Almost 68.3 percent of the Kinki region is mountainous; the inhabitable land area is 11,100 km<sup>2</sup>. The region contains Lake Biwa, Japan's largest lake, with a surface area of 680 km<sup>2</sup> and a capacity as a water reservoir of  $275 \times 10^9$  m<sup>3</sup>. "Biwa" is the name of an old Japanese musical instrument like a lute, and this name is given to the lake because of its shape. The water flowing from the lake first becomes the Uni River and this becomes the main Yodo River after joining with the Kizu and the Katsura Rivers. The main Yodo River flows through the Osaka Plain and finally into the Seto Inland Sea.

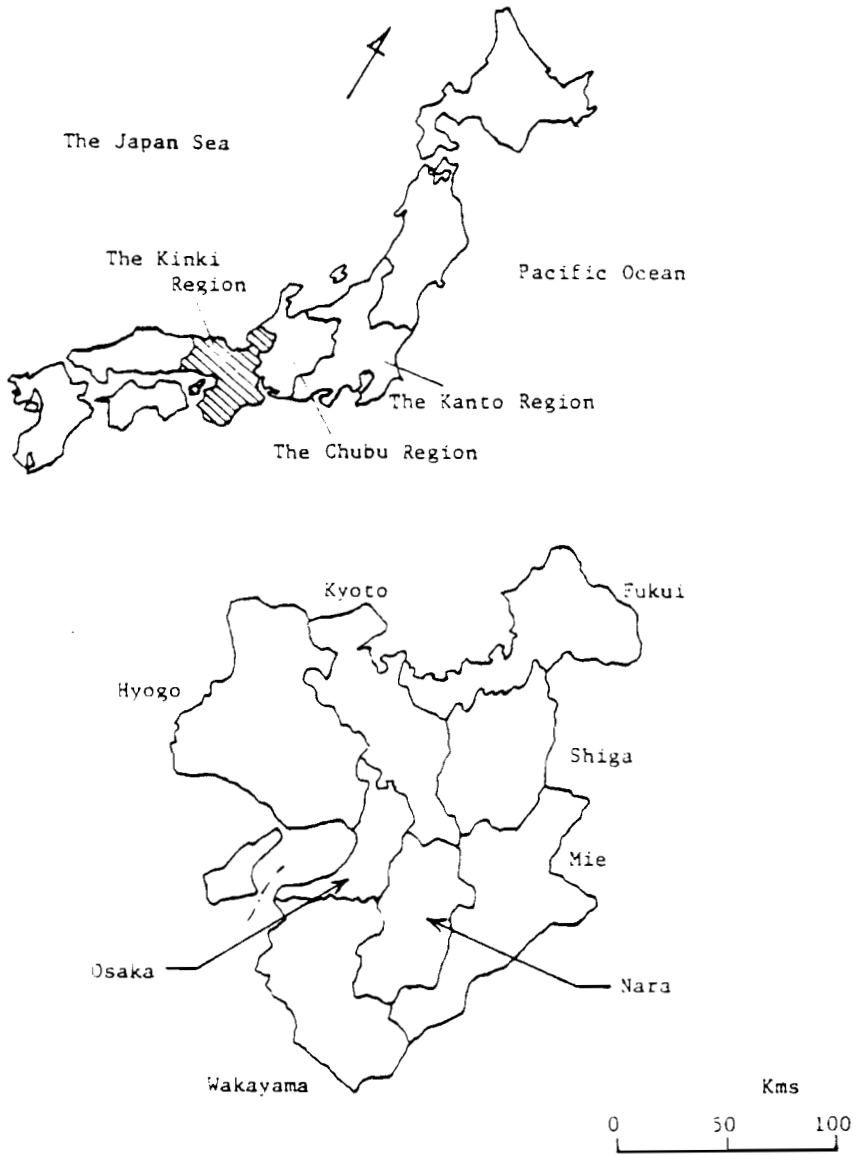
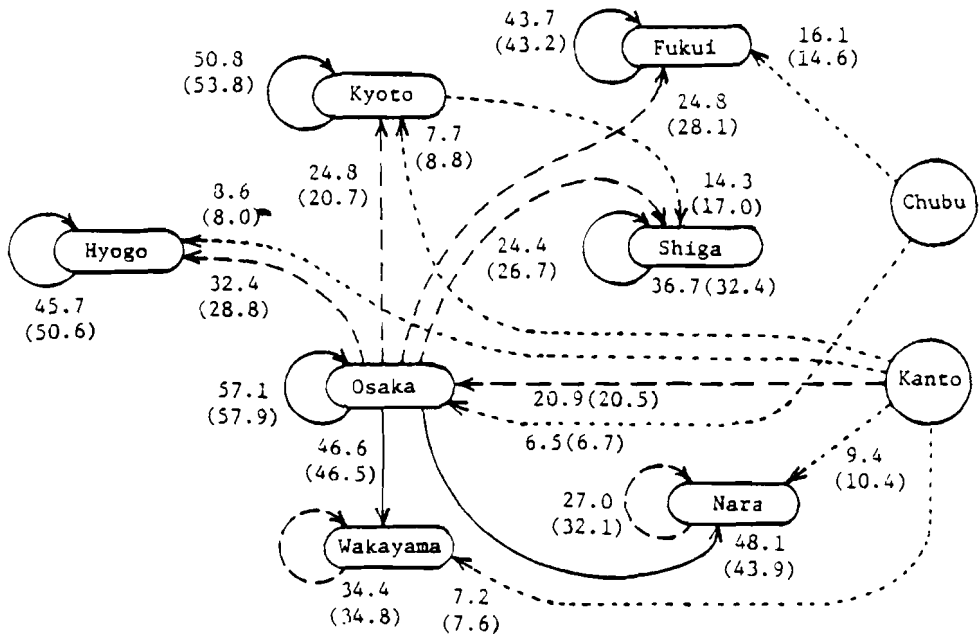

Figure 1. Map of the Kinki region.



upper : Purchase ratio in 1972 (Total=100%)

(lower) : Purchase ratio in 1968 (Total=100%)

→ The first vendor

- - → The second vendor

· · · · → The third vendor

Source: MITI, Japanese Commerce

Figure 2. Wholesale transactions among seven prefectures of the Kinki region.

The Osaka Plain has an area of 1,600 km<sup>2</sup> and provides the nucleus of the socioeconomic activities in the Kinki region. The northern, eastern, and southern fronts of the Osaka Plain are surrounded by mountains and only the western front is open to the sea. The southern part of the Kinki region is the Kii Peninsula, which is occupied by high, steep, mountains; however, the Kino and the Kumano Rivers offer plentiful water. The upper half of the Kinki region is a mix of mountains and basins. The northern border faces the Japan Sea and has a lot of snow in the winter season; it is an underdeveloped area in the Kinki region and has a sparse population.



## 1.2. History

The Kinki region developed early in Japan's history. About 13 hundred years ago a cultural exchange was made with Mainland China by voyages through the Seto Inland Sea. As the chronology of Table 1 shows, the national capitals were in the Kinki region for almost 1,000 years, from the Asuka era to the Azuchi and Monoyama era. The capital moved to the east at the beginning of the Yedo era. At the time of the Meiji (Emperor's) Revolution, the name of the capital was changed from Yedo to Tokyo.

## 1.3. Industrial Activities and Heritage

Table 2 shows the ratio of major indicators for the Kinki region to those of Japan. Roughly speaking, the Kinki region shares around 20 percent of the various socioeconomic activities in Japan. As Table 3 shows, more than half of the important cultural assets in Japan are in the Kinki region, since it was the earliest to be developed. An important feature of the Kinki region is that both population and industry are highly concentrated in the Osaka Bay area. The center is Osaka City, Japan's second largest; it is the capital of Osaka prefecture. The industries located on Osaka Bay are predominantly heavy ones, including the iron, steel, and petrochemical industries. All of these features are the origin of the present problématique for Osaka and, in a broad sense, for the Kinki region.

## 2. THE PROBLÉMATIQUE

The problématique is well represented by this phrase: "the sinking of Osaka in comparison with Tokyo."

The changes in Osaka's economic status are shown in Table 4. One sees that the wholesale amounts of exports, imports, bill exchanges, and security exchanges, have decreased markedly in the 20 years from 1955 to 1975. All of these have close relations to the economic nucleus management function.

Table 5 compares various nucleus management functions between the Osaka district (Osaka, Hyogo, Kyoto) and the Tokyo district (Tokyo, Kanagawa, Chiba, Saitama). It is clear that the Osaka district has as a whole been losing these functions to Tokyo.

Although there are several reasons why Osaka is losing to Tokyo, the following two are considered to be the main ones.

(i). Tokyo is the national center and, as a result, almost all of the national functions are concentrated in Tokyo. All of the ministries' and national agencies' offices are located in the center of the town of Tokyo. When private enterprises want to get permission or approval they have to go to these offices, so it is convenient to locate their headquarters in Tokyo, even if production activities are far away. Important information essential to nucleus management functions is also located in Tokyo; for example, almost all of the research institutes are located in the Tokyo district, as shown in Table 6.

Table 1. A brief chronology of Japanese history.

Century	Capital or Political Center	Form of Society	Political Form	
7		Ancient society	Ruled by influential clans	
	Asuka		Governed by Emperors	
8	Nara			
	9			Kyoto
10				
			11	
12	Kamakura		Ruled by military class	
13				
14			Kyoto	Emperor's sovereignty restored
15	Ruled by Military class			
16				
17	Azuchi and Moroyama	Shogunate society	Meiji restoration	
18	Yedo (Tokyo)			
19	Tokyo	Modern society	Constitutional Government	
20				

Table 2. The ratio of the main indicators of the Kinki region (eight prefectures) to those of Japan.

Item	%
Area	10.0
Population (1970)	18.8
Population increase in 1965-1970	25.4
Arable land area (1972)	3.4
Agricultural production (1971)	10.0
Number of firms (1970)	19.5
Number of manufacturing employees (1970)	18.4
Value of manufacturing shipments (1970)	24.9
Wholesale and retail sales (1970)	25.1
Exports and imports (1970)	23.6
National tax collected (1970)	23.8
Local tax collected (1970)	21.8
Local and discounts of banks	23.6
Distributable national income	21.0

Sources: (i) Office of the Prime Minister, 1970 Population Census of Japan  
(ii) Ministry of Agriculture and Forestry, Census of Agriculture and Forestry  
(iii) MITI, Census of Manufacturers  
(iv) MITI, Census of Commerce  
(v) The Bank of Japan, Yearbook of Economic Statistics

Table 3. Important cultural assets and national treasures.

	<u>Arts and crafts</u>		<u>Buildings</u>	
	National treasures	Important cultural assets	National treasures	Important cultural assets
Japan	818	8867	207	1873
Kinki	439	4365	154	939
%	53.7	49.2	74.4	50.1

Source: Agency of Cultural Affairs, Yearbook of Agency for Cultural Affairs.

Table 4. Osaka's percentage shares of Japanese economic activity from 1955 to 1975.

	1950	1960	1965	1970	1975
Industrial shipment	13.7	13.3	11.9	11.4	10.3
Wholesale amount	25.8	27.6	22.1	20.8	20.9
Export	52.6	46.1	37.6	30.7	24.9
Import	33.1	28.0	21.1	16.5	13.5
Retail sales amount	7.4	8.4	9.1	8.8	8.5
Outstanding deposits	14.6	15.1	15.9	15.2	13.8
Outstanding bank loans	18.1	19.0	18.3	16.7	15.9
Bill exchange	22.7	20.7	20.2	19.9	18.5
Security exchange	21.9	28.8	24.6	20.6	13.6
Distribution income	7.6	8.6	10.0	10.8	10.1

Source: Planning Office of Osaka Prefectural Government.

Table 5. A comparison of nucleus management functions in the Tokyo and Osaka regions (the total of 60 Japanese cities = 100%).

	Tokyo, Chiba, Saitama Kanagawa			Osaka, Kyoto, Hyogo		
	1965	1970	1975	1965	1970	1975
Comprehensive nucleus management function	44.60	45.95	45.82	17.44	16.46	16.78
Economic nucleus management function	45.04	48.00	47.26	24.34	21.17	22.29
Administrative nucleus management function	45.52	47.43	48.28	8.70	9.07	8.64
Social and cultural nucleus management function	42.27	42.40	41.95	19.31	19.11	19.43

Source: National Land Agency, Man and National Land in the 21st Century.

Table 6. The numbers of research institutes in Tokyo, Osaka, and Kanagawa.

	Tokyo	Osaka	Kanagawa
State	43	1	8
Public corporation	12	--	2
University	16	5	--
Local government	12	10	13
Public incorporation	18	2	3
Think-tank	17	1	2
Private enterprise	100	47	66
<b>Total</b>	<b>218</b>	<b>66</b>	<b>94</b>

Source: Science and Technology Agency, Experimental and Research Institute Directory.

(ii). The second reason is the obsolescence of Osaka's industries. Table 7 shows the differences between the industrial structures of the five leading Japanese prefectures. Osaka and Hyogo prefectures have heavy-industry structures that make heavy demands on resources such as energy, water, and land. They are now facing difficult problems: resource shortages on both local and global scales, environmental pollution, and competition from similar industries in developing countries.

Table 7. The industrial structures of Japan's five leading prefectures in 1975.

Prefecture	Urban needs Type (A) %	High resource consumption Type (B) %	Highly processed Type (C) %	Total %
Osaka	21.6	41.3	37.1	100.0
Tokyo	38.0	19.5	42.5	100.0
Aichi	16.8	35.1	48.1	100.0
Hyogo	24.9	44.8	30.3	100.0
Kanagawa	14.0	35.7	50.3	100.0

Type (A): foodstuff, clothes, furniture, publication and printing, tanned leather etc.

Type (B): textile, woods, pulp and paper, chemical, oil, rubber, ceramics, steel, non-ferrous metals

Type (C): metals, machinery, electrical instruments, precision instruments, transportation instruments

Source: MITI, Census of Manufacturers.

During the era of high economic growth, urbanization also made rapid progress. The situation in Osaka prefecture is shown in Table 8. Rapid urbanization usually caused a shortage of social overhead capital, as was unavoidable in Osaka.

Table 8. The increase of densely inhabited districts (DIDs) in Osaka prefecture.

	1960	1965	1970	1975
Population (thousands)	5505	6657	7620	8279
Population of DIDs (thousands)	4479	5581	6863	7682
Percent	81.4	83.8	90.1	92.8
Area (km <sup>2</sup> )	1831	1840	1854	1858
Area of DIDs (km <sup>2</sup> )	333	405	594	725
Percent	18.2	22.0	32.0	39.0

Source: Office of the Prime Minister, 1975 Population Census of Japan.

### 3. THE REHABILITATION OF OSAKA

Facing this problématique as a principal part of the Kinki region, Osaka is now struggling to seek solutions. The catch phrase is "the rehabilitation of Osaka." In a broad sense, the word Osaka is often replaced by "Kinki" or "Kansai." The definition of "Kansai" is rather vague, but it is usually used as a synonym of "Kinki." In contrast to "Kansai," the region including the Tokyo metropolitan area is called "Kanto."

Since the fact that Osaka or Kansai is losing to Tokyo or Kanto is rooted deep in the present socioeconomic and political structure, it will be difficult to restrain or reverse the current trend. In order to do this, it will be necessary to coordinate and integrate such versatile countermeasures as these:

- building a new town gathering various institutes for higher education and research together
- building an international economic and cultural exchange center, including the Kansai New International Airport
- urban redevelopment in Osaka City, including the establishment of the Nakanoshima Public Entertainments
- composite development of Lake Biwa
- a clean air plan
- a general rearrangement of all other social and economic overhead capital

All of these will contribute to restoring the administrative nucleus functions, to introducing knowledge-intensive industries, and to strengthening the regional solidarity.

Part II

THE FIELD STUDY

PLANNING, MODELING, AND ENVIRONMENTAL DECISION MAKING—  
A CASE STUDY OF THE KINKI REGION IN JAPAN

S. Ikeda, J.W. Owsinski, and D.V. Winterfeldt  
*International Institute for Applied Systems Analysis,  
Laxenburg, Austria*

1. INTRODUCTION

1.1. Purpose of the Study

This chapter summarizes the findings of a field study carried out within a series of case analyses of socioeconomic conditions, planning systems and methods, and program organizations for regional development. Three examples of regional development have been analyzed: the Tennessee Valley Authority in the USA [1], the Bratsk-Ilimsk Territorial Production Complex in the USSR [2], and the North Sea petroleum development [3]. The aims of the case analyses were twofold:

- to gather experience in methods and procedures used within the development, and
- to test and develop systems analytic and synthetic techniques that can be applied to the analysis and design of development undertakings.

The research on the Kinki region problems and the methods for their solution was conducted in close cooperation with the Kinki Integrated Regional Development Program modeling carried out by several Japanese scientific groups from universities and institutes in the Kinki region.

This chapter will first give a summary of the logic, contents, and organizational form of an actual planning and management system of appropriate scope. Within this description special emphasis is placed on elaborating the so-called Comprehensive Development Plan and on financial relations. Beside



general socioeconomic planning and management, two distinct subsystems will be looked at: one object-based (the environmental management system), and the other functional (the model system, as a subset of formalized planning techniques).

Problems were reported on the basis of perceptions communicated to us by representatives of regional bodies. They belong to two distinct categories:

- the problems existing in the regional socioeconomic system, and
- the problems existing within the planning and management system in coping with the problems of the first category.

The study team particularly looked at the second-category problems from the point of view of integration, both organizational and methodological integration of various questions, points of view, and interest, and also integration of models into the planning and management processes.

#### 1.2. The Approach to the Analysis

The planning and management system, its organization, functioning, and outcomes were viewed through the set of actors (institutions, groups, or individuals having a say in a given problem area) or their groupings, where actors can be distinguished on the basis of their *values* and *instruments* that can be operated.

The main assessment and evaluation criterion taken in this study is the intrasystemic *consistency*. This criterion requires that for a spectrum of values explicitly stipulated within the system they actually should be pursued through the performance of this system. Such an approach necessitates, first of all, a check on consistency of goals that result from actors' values, then a check on policies that are meant to achieve specific goals, and finally a check on inter-policy consistency. Such an analysis is meant to show how certain goals may fail to be achieved and where the policy gaps exist or where the policies may counteract.

An important additional criterion is therefore the *integration* factor (see Figure 1). Disintegration (pursuance of particular interests or lack of provision for joint consideration of options and policies) may lead to inconsistency in goals and in policies, and even to intrainstitutional gaps in the individual policy-goal line. Integration as a capacity of a system to jointly consider (explicitly or implicitly through certain bargaining mechanisms) various values, and the policies pertaining to them, and to make them appear in final outcomes (products or impacts of the development) will be looked at.

During the field study a number of interviews were conducted and efforts were made to cover all the actor groupings and functions within the policy and decision process, such as

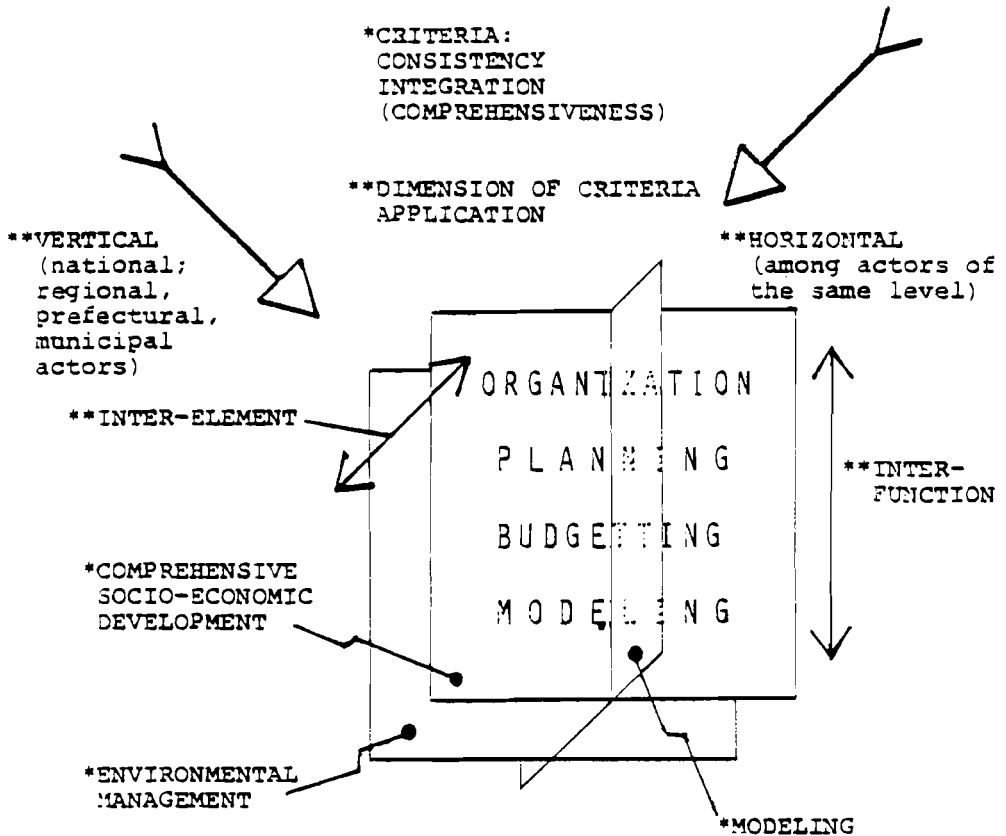

Figure 1. Study objective and observation framework.

## a. Central organizations

- National Land Agency
- Kinki Bureau of Ministry of Construction

## b. Regional organizations

- Osaka, Hyogo, Kyoto, and Shiga prefectural governments: Planning and Coordination, Life and Environment, Public Health Divisions, and Monitoring Centers
- Kyoto City Office

## c. Experts

- Kyoto and Osaka Universities, Institute for Environmental Research on Kinki International Airport.

## 2. REGIONAL COMPREHENSIVE DEVELOPMENT PLANS IN THE 1970s

Since the oil crisis in 1974, Japan, typical of most industrial countries, has been forced to cope with the challenge of a shift from a country with a high growth rate to one with a low growth rate and from a quantitative increase in income to a qualitative enrichment of life—in the face of both a shortage of natural resources and the burden of heavy environmental pollution. Equally true is the fact that each individual prefecture has a lower growth rate and is therefore compelled to cope with the following major problems:

- How to allocate total revenue in a welfare system and improve the environment while at the same time promoting a change in industry from a heavy, chemical base to an information-oriented base—in a community with diversified values.
- How to establish financial measures as well as a self-planning capacity from a prefectural rather than a national viewpoint.
- How to coordinate and integrate its own regional development plans into large-scale national projects.
- How to respond quickly to local-community and residents' movements and to aid their participation in the planning process.

These issues seem to necessitate a long-term Prefectural Comprehensive Development Program (PCDP) to coordinate individual projects at both intra- and interprefectural levels. According to a recent survey carried out by the Ministry of Home Affairs [4], almost all the prefectures in Japan have completed or are preparing PCDPs.

## 2.1. Actors' Values and Policy Instruments

Table 1 summarizes the potential actors and values involved in the PCDP planning process. Looking at the interfaces of core actors between prefectural and central governments, we find two

Table 1. Actors, values, and instruments associated with regional CDPs in the Kinki region.

Actors	Values	Instruments
<u>Central Government</u>		
o Kinki Redevelopment Agency (National Land Agency)	o Integration to National Goals	o Zoning and siting guideline
o Ministries of Construction International Trade and Industry Transportation Agriculture and Forestry	o Rectifying imbalance within Kinki area and between regions  o Stable growth	o Special financial measure o Major physical projects (roads, railway, dams, in- dustrial base, etc.) o Public investment (budget allocation)
<u>Local Government</u>		
o Prefecture	o Well-balanced stable socio- economic structure	o Zoning and siting guideline o Local taxation
o Big cities	o Strengthening of regional autonomy	o Introduction of specific financial aid
o Municipalities	o Quality of living environment	o Integration into national project
<u>Industry and Business</u>		
o Big business	o Growth, profit	o Investment
o Local business	o Stability	o Special measure (tax cut, etc.)
<u>Communities (residents)</u>		
o Citizens Association	o Civil minimum for infrastructure	o Petition, lobbying
o Anti-pollution residents groups	o Environmental right for living	o Complaints, court cases

kinds of interactions: one is through the national CDP and the other is through the ministerial long-term plans for public facilities such as roads, ports, and sewerage (see Figure 2).

As to regional finance, there are two main income sources for local government budgets. One is local taxation, which flows directly into their revenue, and the other is the central government, which supplies through various channels such as local allocation tax and subsidy. The local allocation tax is one of the major means of adjustment for the redistribution of revenue collected by the central government to help decrease regional imbalances.

Prefectures have about 40 percent autonomy in terms of budgeting discretion. However, since expenditure is mainly on personal allowance (approximately 33 percent of total expenditure including education, police, and health services staff) and general administration, the investment allocated to the construction of socioeconomic and environmental infrastructure cannot operate in an efficient way without obtaining subsidies from the central government.

The central government has three typical policy instruments in terms of financial control:

- a general governmental subsidy for a particular project according to the framework of the *public investment allocation program*
- sanction or guidance for a locally issued bond according to the framework of the *financial investment and loan program*
- a local allocation tax according to the framework of the *special account scheme*.

## 2.2. The Contents of PCDPs

Turning now to the contents of PCDPs, Table 2 presents a summary of Osaka, Hyogo, Kyoto, and Shiga prefectural CDPs including the main area (issue), goals (values), and instruments (policy) [5]. Although there are many different types of statements to express their goals and instruments, we find some common features:

- conversion from a development-oriented policy to a welfare and environmental preservation one
- emphasis on the formation of a local community based on local culture and characteristics
- innovation in industrial structure towards a pollution-free and knowledge-intensive type
- public hearings and participation in the planning process of CDPs.

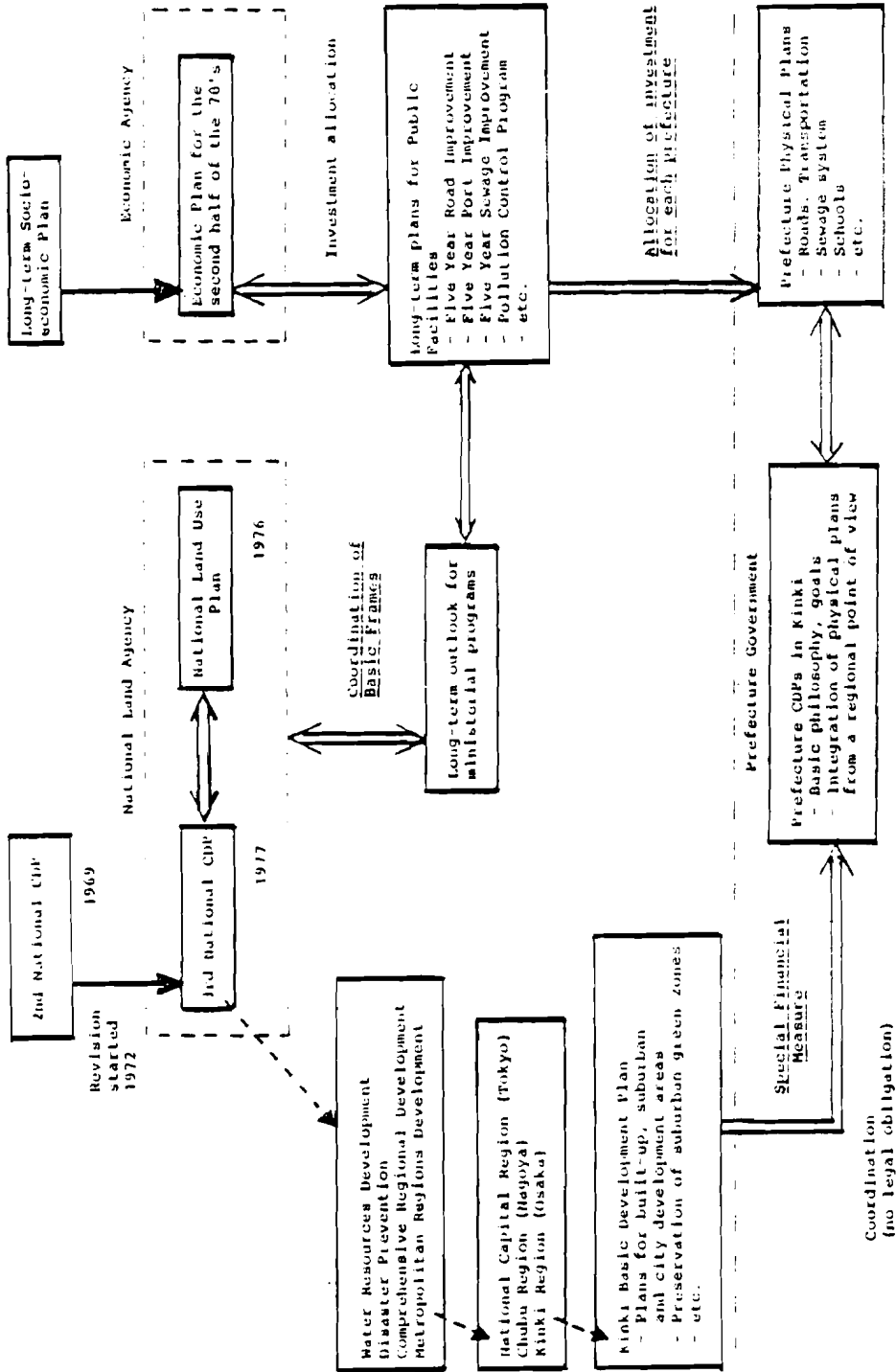

Figure 2. Interactions of national and prefectural CDPs and policy instruments.

Table 2 PROBLEMS, GOALS (VALUES), INSTRUMENTS AND MAJOR PROBLEMS OF PCDP

PREFECTURE	AREA OF CONCERN	GOALS	INSTRUMENTS	MAJOR PROJECTS	PLANNING INSTITUTION	TIMING Planning Period
OSAKA	<ul style="list-style-type: none"> <li>Human &amp; welfare society</li> <li>Environment &amp; overcrowding</li> <li>Reformation of industry-oriented society</li> <li>Increase of local self-government capacity</li> </ul>	<ul style="list-style-type: none"> <li>Formation of welfare system based on human community networks</li> <li>Creation of healthy, safe &amp; pollution-free environment</li> <li>Development of culture &amp; information functions on the basis of traditional culture &amp; history</li> <li>The formation of an attractive megalopolis zone as a center to western Japan</li> </ul>	<ul style="list-style-type: none"> <li>Local self-taxation system to intensify regional finance</li> <li>Tightening of land use guideline</li> <li>Environmental management system - total emission control -</li> <li>Comprehensive assessment procedure for development plans</li> </ul>	<ul style="list-style-type: none"> <li>SIG Plan (env. management program)</li> <li>Sewage consolidation program</li> <li>New International airport</li> </ul>	<ul style="list-style-type: none"> <li>Governor</li> <li>Advisory Council for GDP</li> <li>Public hearing by residents' monitors</li> </ul>	<ul style="list-style-type: none"> <li>1972-77</li> <li>1978-90</li> </ul>
HYOGO	<ul style="list-style-type: none"> <li>Human &amp; rural society</li> <li>Social &amp; living infrastructure - depopulation &amp; overcrowding -</li> <li>Environment &amp; pollution</li> <li>Innovation of industrial structure &amp; creation of new regional values</li> </ul>	<ul style="list-style-type: none"> <li>Cultivation of people's attitudes about nature &amp; the quality of life</li> <li>Local welfare system as civil minimum</li> <li>Conservation of natural environment &amp; creation of a new amenity</li> <li>Well-balanced industrial structure from a regional viewpoint</li> </ul>	<ul style="list-style-type: none"> <li>Educational &amp; cultural facility network</li> <li>Setting stationed living zone based on social indicators</li> <li>Environmental management system - total emission control -</li> <li>Regional standards for industrial structure &amp; policy issues</li> </ul>	<ul style="list-style-type: none"> <li>New town construction plan for relocating housing &amp; industry</li> <li>Total emission control plan (SO<sub>2</sub>, NO<sub>x</sub> &amp; O<sub>3</sub>)</li> <li>Consolidation of new trunk transportation system</li> </ul>	<ul style="list-style-type: none"> <li>Governor</li> <li>Advisory Council for GDP</li> <li>Public assembly</li> </ul>	<ul style="list-style-type: none"> <li>1973-75</li> <li>1976-85</li> </ul>
KYOTO	<ul style="list-style-type: none"> <li>Difference in income between southern &amp; northern parts</li> <li>Degradation of living environment</li> <li>Traditional culture &amp; nature</li> <li>Industrial structure &amp; local industry</li> </ul>	<ul style="list-style-type: none"> <li>Increase of social overhead capital in order to provide a better environment for living in</li> <li>Improvement of transportation system</li> <li>Preservation of natural &amp; historical landscape coupled with an increase in tourist requirements</li> <li>Comprehensive industrial &amp; development directed at machinery &amp; local industry</li> </ul>	<ul style="list-style-type: none"> <li>Health care, welfare &amp; sewage systems</li> <li>Environmental management program</li> <li>Rationalization of land use</li> <li>Construction of industrial parks for local industries</li> </ul>	<ul style="list-style-type: none"> <li>Consolidation plan of sewage treatment systems for the southern part Kyoto</li> <li>Construction plan for Osadano industrial park, located in depopulated area</li> </ul>	<ul style="list-style-type: none"> <li>Governor</li> <li>Advisory Council for GDP</li> </ul>	<ul style="list-style-type: none"> <li>1969-70</li> <li>1971-85</li> </ul>
SHIGA	<ul style="list-style-type: none"> <li>Industrialization &amp; population increase</li> <li>Culture &amp; education</li> <li>Joint community on Lake Biwa basin</li> <li>Recovery of agriculture</li> </ul>	<ul style="list-style-type: none"> <li>Stable growth of industry &amp; population which provides employment</li> <li>Creation of human &amp; local community</li> <li>Preservation of nature &amp; water in Lake Biwa</li> <li>Development of kindal region as a water &amp; agriculture base</li> </ul>	<ul style="list-style-type: none"> <li>Selective introduction of non-pollution type industry</li> <li>Funding from other related prefectures &amp; government</li> <li>Non-automobile type of tourism &amp; recreation zone</li> <li>Environmental management system - total amount of control for water quality -</li> </ul>	<ul style="list-style-type: none"> <li>Lake Biwa Comprehensive Development Plan</li> </ul>	<ul style="list-style-type: none"> <li>Governor</li> <li>Advisory Council for GDP</li> <li>Public assembly</li> </ul>	<ul style="list-style-type: none"> <li>1976-77</li> <li>1978-85</li> </ul>

### 3. ENVIRONMENTAL MANAGEMENT

#### 3.1. Major Environmental Problems

The improvement of the environment is a central issue in the PCDPs, as shown in the previous section. As far as the air-pollution problem is concerned, SO<sub>2</sub> pollution has been successfully controlled, a well-known national achievement in Japan [6]. In particular, Osaka, beginning with a poor SO<sub>2</sub> record, has now reached the national average. Most prefectures in the Kinki region seem to be most concerned about the photochemical smog problem. Thus, while SO<sub>2</sub> pollution is controlled, NO<sub>x</sub> and photochemical smog are now considered to be the main air pollution problems in the Kinki prefectures, as well as in the whole nation.

The three main problems arising in water pollution are: first, the pollution of Lake Biwa; second, that of the Yodo River basin through municipal and industrial wastes; and finally, that of Osaka Bay. The reason for the pollution of the Yodo River basin as well as Lake Biwa and Osaka Bay is mainly a lack of sewerage systems. In 1976 only 36.4 percent of municipal and industrial wastes were collected through sewerage systems. Particularly drastic is the picture in the Shiga prefecture, where up to now only four percent of the wastes are treated in sewerage systems.

Among the remaining environmental problems, most prefectures mentioned noise as a major source of complaints.

All these are classified into three different types of problems:

- *local problems* particular to a prefecture or a city (e.g., Kyoto City cultural preservation)
- *regional problems* that involve several prefectures
- *national problems*.

The latter two types of problems require integrated approaches. Two types of integration approaches may become necessary: *vertical integration* between national, prefectural, and city governments in the national problems that require close cooperation between the Environment Agency, other ministries, and the local authorities; and *horizontal integration* between prefectures in the region for those problems that are shared by the regional prefectures.

#### 3.2. Organization (Actors) in Environment Management

The Environmental Agency is responsible for overall promotion of environmental administration in Japan. The Central Council for Environmental Pollution Control is the main research and advisory body to the Environment Agency. Also attached to the Environment Agency in its research capacity is the National Institute for Environmental Studies. Almost all Japanese prefectures now have pollution-control sections built into their



organizations. They typically belong to the Division of Environment and Public Health. The prefectural governor also has advisory councils for pollution-related matters, as well as standing pollution control conferences. A similar structure can also be found on the city administration level.

Three layers of organizational structure are coordinated in several ways: by a division of the functions and by joint committees, councils, and conferences.

Various approval schemes and meetings between the different layers of environmental decision-making support a vertical integration. Prefectural representatives, for example, take part in the decision-making process for quality standards, and Environment Agency representatives have to approve special pollution-control programs in prefectures. Horizontal integration, however, appears less effective, although there exist several committees and conferences for special regional pollution problems, e.g., the Water Quality Council in the Kinki region.

### 3.3. Environmental Planning

Each prefecture has elaborated medium-term (ten-year) environmental plans as a part of the CDP. Table 3 summarizes the main features of these plans. There are some differences in the perceptions of the problems in the four prefectures. In Osaka, noise is stressed much more than in other prefectures. In the Kyoto prefecture, Yodo River pollution is mentioned as the most severe problem. In Hyogo, coastal pollution is stressed, while in Shiga the pollution of Lake Biwa and the lack of sewerage systems is pointed out.

The instruments and tools conceived in the prefectural plans for achieving these targets differ little. Most notable is, perhaps, that Osaka and Hyogo prefectures are developing new instruments for public participation.

There are certain shifts from concentration emission control to total-amount emission control. These changes have been motivated to avoid dilution strategies by which industries could achieve emission concentration standards, but still emit the same total amount of pollutants. The Osaka and Hyogo prefectural environmental pollution centers have advances with  $\text{NO}_x$  total-amount emission control and are currently working on a model for allocation to different sources.

Budgeting mechanisms are the most powerful tools for the design and realization of environmental plans. Fundamentally the finding was the same as for CDPs: budgeting is, in general, centralized and project-oriented.

### 3.4. Environmental Modeling and Monitoring

The Kinki environmental managers are developing models for environmental management. Although most other research activities are done on a national level (e.g., research on health effects, ecological research), models of pollution dispersion,

Table 3. Contents of prefectural environmental control plans.

	1973-1985 Osaka Big Plan	1975-1981 Kyoto Environmental Plan	Hyoto Environmental Plan	Shiga Lake Biwa Plan
Main Problems	o NO <sub>x</sub> , O <sub>3</sub> (Oxidant)	o NO <sub>x</sub>	o NO <sub>x</sub>	o N + Ph In Lake Biwa → Eutrophication
Area of Concern	o Noise (Airport)	o CO	o Photochemical Smog	o Sewage System (3.8% only in 1977)
	o Osaka Bay	o Yodo River Basin	o Coastal Pollution	o Conservation of green
	o Yodo	o Cultural Preservation	o Redtide (Plankton bloom)	
Goals, Objectives, Targets	o Achieve National Standards by 1981	o Achieve National Standards by 1981	o Achieve National Standards by 1981	o Cover 90% Sewage until 1990
	o 90% Sewage until 1981 100%, 1985	o Improve Sewage System	o National Standards until 1981	o National Standards until 1981
	o N, Ph, Phenol Standards (Osaka) until 1981		o 1 ppm Quality Standard for N + Ph until 1981	o Site and Number of Parks
	o 72% Reduction of BOD until 1981			
Instruments, Tools	o TEC for SO <sub>2</sub>	o Land Use Plans (8 zones)	o Shift Towards TEC (NO <sub>x</sub> )	o Sewage System
	o Fuel Changes	o Mesh Analysis	o Different Air Pol- lution Standards in 9 Districts + BOD	o Control Pollution Increase
	o Monitoring Air (45 Stations)	o Restrict Outside Visi- tors (Automobile)	o Extensive Monitor- ing (IARS)	o TEC for N + Ph
	o Control Traffic Frequency	o TEC for SO <sub>2</sub> (Different from National)	o Public Participa- tion Schemes	o Public Mode Against Chemical Use (Ph)
	o Public Participation (BIG)	o Pollution Area Desig- nation		o Land Use Planning
	o Environmental Impact Assessment (EIS)			
Example Projects	o Sewage Construction Project "Green"	o 10-year Water Quality Project	o TEC Models	o Lake Biwa Comprehen- sive Development Project (with Osaka and Hyogo)
	o New Blue Sky Project for NO <sub>x</sub>	o 7-year Air Quality Project	o District Plans	
		o Mesh Project Monitoring		

transfer, and allocation of emission amounts to sources is done by the local environmental pollution-control centers. Monitoring is also a city or prefectural task.

Two observations, however, can be made on the horizontal integration of such models. First, interpollution transfer is still poorly modeled. Osaka, for example, considers pollution inputs from other prefectures only through fixed parameters. Thus, there is not much horizontal integration of such models. The second observation is that in the most urgent area of pollution transfer modeling, the Yodo River basin case, there are as yet, only a few attempts [7].

#### 4. PROBLEMS IN APPLYING FORMALIZED PLANNING TECHNIQUES AND MODELS TO KINKI INTEGRATED REGIONAL DEVELOPMENT

##### 4.1. Problems to be Solved and Model Development and Use

Table 4 presents the problems of regional character as perceived by agencies and ministries within the central government. They are stated in a very general form and can only become region-specific when applied to different regional conditions, i.e., when the actual instruments' use has to be elicited. It should be emphasized that the regional policies of the national government were to a large degree of an interventionist nature.

Some of the basic problems that the main central governmental actors face when choosing regional policies is that they do not find, as yet, modeling application counterparts. Furthermore, use of some of the potentially usable models developed within the institutional planning and management system has been to a large extent abandoned. An important phenomenon that could also be pointed out is that the regional-level models have not been developed within the institutional system, although they are in general largely represented. (It should also be stressed that all the first modeling efforts done within the institutional authority system happened to be in the Kinki region, far ahead of the other regions in Japan.)

An overall view of the modeling activities allows for an easy estimation of the coverage problem areas. Tables 5 and 6 give the classification of the problems and models which prefectural and municipal bodies face in the policy making. It is evident from these tables that, while there is a fairly good coverage for common and potentially specific problems, some of the general problems are in fact national ones, and it could be expected that the appropriate models will be made within the central planning bodies. On the basis of Tables 5 and 6 a summary overview of model applications pertaining to various stages in decision-procedure working can be made as given in Table 7.

Table 4. Central government's perception of regional problems.

Actors	Problems	Measures	
Region-oriented actors	Overcrowding versus depopulation	<ul style="list-style-type: none"> <li>o Basic development plans</li> <li>o Zoning</li> <li>o Relocation</li> <li>o New centers</li> </ul>	
	Welfare- and infrastructure-oriented actors	<ul style="list-style-type: none"> <li>Dearth of housing</li> <li>Commuter hardships</li> <li>Pollution</li> </ul>	o Fiscal measures (for prefectures)
		Urban sprawl	o Object-oriented plans
Scarcity of Resources:		o Projects (general purpose)	
Land		o Projects (welfare)	
Water		o Allocation concepts	
Labor force	o Budget allocation (activities and regions)		
Energy and materials	External economies and diseconomies	o Infrastructural projects	
Economic and industrial policy actors	Limitations to market mechanisms	o Regulations (environmental and energy consumption standards)	
	Restructuring	o Taxation policies, subsidies, etc. o factory location, legislations	

Table 5. General problems.

	1	2	3	4
Problems	Autonomy Against Financial Dependence	Improvements in Social, Infrastructural, and Ecological Environments	Relocation and Restructuring of Activities	Equalization Income
Measures to Cope With	(Fostering of Internal Growth and Improvement, Creation of Attraction and Gravity Center) (Financial soundness argumentation)	Welfare Systems, Infrastructural, Equalizing Investments Preservation and Activation in the Societal System Conservation and Monitoring of the Environment	New Centers and Industrial Parks Consolidation Projects	Redistribution of Income Spread of Growth, Fostering and Preservation of Local Centers
<b>MODELING</b>				
Within Kinji Prefectures	(Osaka Prefecture Econometric Financial Model)	Social Indicator Studies (Osaka, Hyogo) (SD Models in Shiga, Osaka, and Hyogo) (CARPS + PIAS—Hyogo— as Screening Device)	CARPS + PIAS—Hyogo	(Econometric Models?)
Within Kinji IRDMP		Cultural and Environmental Assests Evaluation Techniques Equalization of Social Utilities Simulation of Environmental Impacts Evaluation Methods for Environmental Purposes	IRDPM* (for General Specialization Studies) OASIS	(Equalization of Societal Utilities: in Fact Not Directly Income-Oriented)
Other Potential Comments	(Multilevel Structuration Models) (Interregional Optional Growth Promotion and Centering Models) (Financial Planning and Management Applications)	(Societal Values Structuration Models) (Cross-Impact Analysis)	(Technological and Demand Projections, Price, and Cost Studies, Specialization and Optimization Models)	(Spatial Differentiation and Specialization Models)

\*Integrated Regional Development Programming Model.

Table 6. Common problems.

	5	6	7	8
Problems	(Creation of Regional Functional Systems)	Water Supply	Air Pollution	Urbanization and Land Use
Measures to Cope With	(Enhancement of Consolidation, and Higher Functions' Attractiveness)	Lake Biwa Plan, Accompanying Infra-structural Projects	Standards Local monitoring and Control Systems	New Towns Consolidation Land Use Controls
<b>MODELING</b>				
Within Kinki Prefectures	(Osaka Prefecture Econometric Model) (PIAS + CARPS)	Lake Biwa and River Yodo Models (Quality or Quantity)	Air Pollution Dispersion Models (Kyoto, Osaka, Hyogo) Monitoring Applications	(Standard Land Use Physical Planning Traditional Techniques)
Within Kinki IRDMP	IRDPM OASIS	A Number of Models from LP Ones to Conflict, Multiattribute and Interactive Optimization	(Works of the IBM Japan Group)	Two Land Use Models
Other Potential Comments	(Interregional Specialization and Attractiveness Models)	(The Area Fairly Well Covered)	(Pollution Share Models)	(Agglomeration Economies and Diseconomies, Urbanization Dynamics Models)

Table 7. Reconstruction of an approach; sequence of modeling and analysis.

Problem structuration	Long-term structural perspective	Long- to medium-term forecasting and planning	Medium- to short-term policies assessment	Project impact assessment	Evaluation
DEHATEL	System Dynamics		General econometric models	PIAS + CARPS (forecasting, utilities, interactiveness)	Social indicator studies
			Specific sectoral models		

## 5. CONCLUSIONS

The findings of this study are: there is a lack of comprehensiveness in the objectives and alternatives considered by the actors involved in the actual regional policy-making. The main need for the Kinki regional development system at the moment is an effort to ensure more consistency and integration vertically and horizontally as to policy planning, budgeting, and modeling issues.

From the planning point of view we observed a difference between central and local governments, such as continuous socioeconomic growth for the nation as a whole against well balanced socioeconomic structure within each territory. Particularly in the environmental management system, while vertical integration and policy consistency seem to exist with a clear separation of function, a multiple interrelation of organizations, and a strong central budget control, horizontal integration lags behind in the Kinki region as a whole.

There is a relatively high degree of comprehensiveness with regard to internal regional problems and consecutive stages of decision-making procedure within the prefectures. There is more to be done in the modeling, however, in making provision in the models developed in the individual prefectures for appropriate flow to and from other prefectures, together with consideration of their reactions, policies, etc. Such horizontal integration will enable the prefectures to see whether the problems they are coping with can be aggregated or whether they have to be treated in a feasible-solution-search framework as a conflict resolution.

Needless to say, however, these observations should be considered along with an awareness that the Kinki prefectures have been playing a leading role in incorporating systems-analytic tools into their policy formation and management as well as in strengthening their autonomous capacity to make it possible to bridge the gaps and inconsistencies.

## REFERENCES

- [1] H. Knop (ed.), *The Tennessee Valley Authority Experience*, CP-76-2, Laxenburg, Austria: International Institute for Applied Systems Analysis, 1976.
- [2] H. Knop and A. Straszak (eds.), *The Bratsk-Ilimsk Territorial Production Complex: A Field Study Report*, RR-78-2, Laxenburg, Austria: International Institute for Applied Systems Analysis, 1978.
- [3] D. Fischer, et al., *The North Sea Oil Development and Environment Responses*, unpublished manuscript.
- [4] Ministry of Home Affairs, Japan, *A Survey of Prefectural Long-Term Plans*, Tokyo, 1977.



- [5] Interviews at Planning Division of Osaka, Kyoto, Hyogo, and Shiga Prefectural Governments, October, 1977.
- [6] Environment Agency, Quality of Environment in Japan, 1976.
- [7] H. Knop (ed.), A Computer Assisted Approach to Regional Development, CP-76-10, Laxenburg, Austria: International Institute for Applied Systems Analysis, 1976.



Part III

REGIONAL PLANNING AND PROGRAMMING  
AND THE ROLE OF MODELS

THE CONCEPT, PROCESS, AND METHOD OF REGIONAL PLANNING  
AND THE KINKI REGIONAL DEVELOPMENT PROGRAM

K. Yoshikawa  
*Department of Civil Engineering, Kyoto University,  
Kyoto, Japan*

1. REGIONAL PLANNING—CONCEPT AND PROCESS

Regional planning is comprehensive planning made for a region where a number of problems involved in development and conservation need solutions. Regional planning forms a frame in which planning for towns and countrysides in the region can be performed. Such planning requires the analyses of identified problems—social, economic, or physical—and the integration of the results.

National planning is planning performed at national level with the management of nationwide activities being accounted for on a comprehensive basis.

Urban and rural plans concern problems at local level affecting the activities of local people.

These two planning activities are at the ends of the planning spectrum, with regional planning coming between them. This means that regional planning functions are at an intermediate level and must coordinate the two polar plans, the national plan at the top level, and urban and rural plans at the bottom level. National planning provides regional planning with a frame of reference to the development scale and the location policy. Urban and rural planning, in turn, set out regional planning information on what is required and expected at local level. Regional planning serves as a mediator to coordinate the requirements coming from top and the bottom. Regional planning gives an explicit picture of what has been fixed at national level and makes a clear-cut judgment on what cannot be determined at the local level.

Regional planning deals with an area that is expected to maintain its socioeconomic integrity in the target period. When the region to be treated is identified as such, the scope of regional planning concerns a set of multifaceted factors characterizing the region. Then it works out a picture of what the region would be in the target year, thereby indicating how the region should be managed.

The scope of regional planning specifically includes such development and conservation problems as (i) setting up of a regional frame, (ii) land use, (iii) traffic and transportation, (iv) terminals, (v) flood control and water supply, (vi) energy, (vii) urban development and redevelopment such as the renewal of urban centers, the development of urban subcenters and new towns, the provision of land for industrial estates, etc., (viii) sewage treatment, waste disposal and pollution control, (ix) preservation and conservation of open space, landscape and wildlife, and, in a broader sense, (x) management of social problems, such as those occurring in daily life, social welfare problems, etc.

The basic ideas underlying regional planning and the basic guidelines prescribed by it are the following:

- Integration should be made to work out how the problem is to be handled on an area-wide basis.
- Allocation should be made to bring about the target growth of industry and population and appropriate exploitation of resources.
- Consistency should be achieved to match both the socioeconomic planning and the physical planning, both of which are brought together in regional planning.
- Efforts should be made to coordinate development with preservation and conservation.
- Jurisdiction should be identified to implement the planning.

## 2. A PROPOSED METHOD AND PROCESS FOR REGIONAL PLANNING

Figure 1 sketches my proposed method and process for regional planning.

The process is initiated by identifying how the region should be managed in the target period. Next comes the process of specifying the goals and producing alternatives to attain these goals. The alternatives are evaluated in the next step to single out the preferred alternative based on criteria established beforehand.

Recent work in this field has made considerable progress in evolving systematic and scientific methods for producing structured information for regional planning. Econometric and system-dynamics models have contributed to the identifying of the nature and structure of regional economy, industry, and population. Multivariate analyses, including multidimensional quantification methods and factor analysis, have provided access to such qualitative attributes as sociocultural factors,

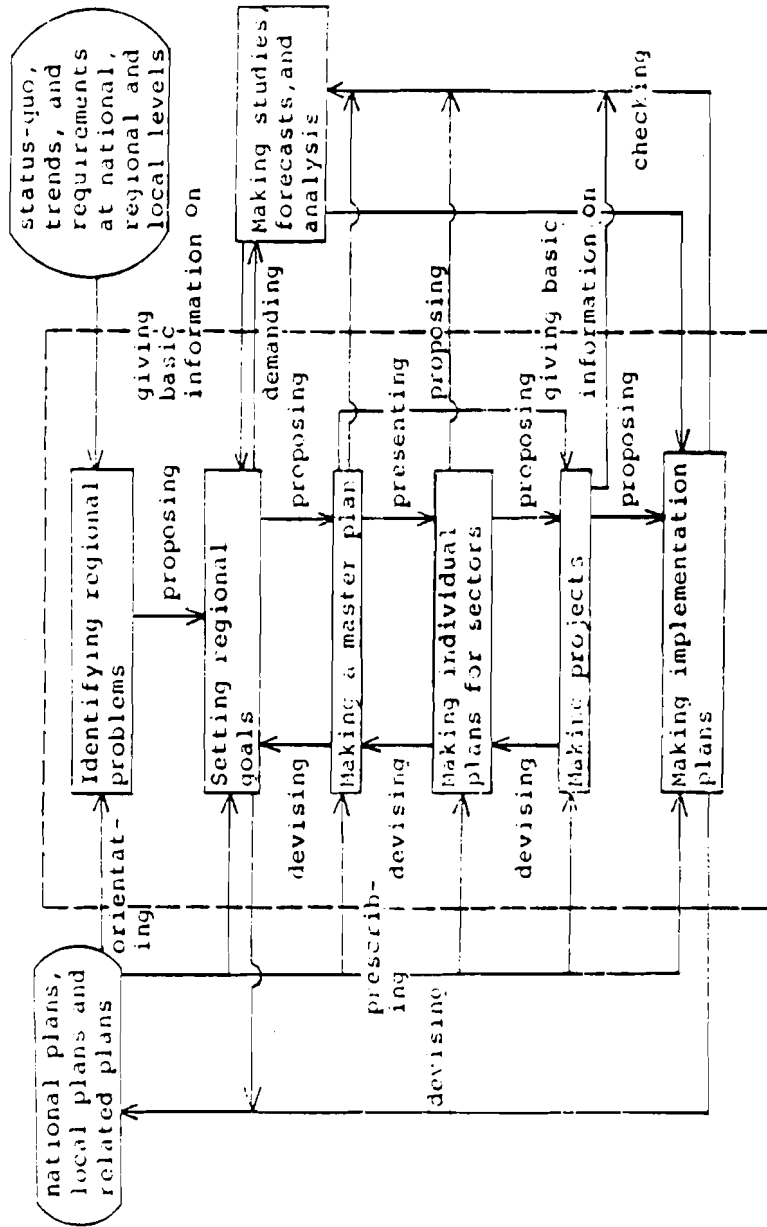

Figure 1. The proposed regional planning process.

living environment, etc. We believe that these approaches from different angles, if operated on an integrated basis, provide a set of necessary, if not complete, information available on which to base a systematic and scientific method in regional planning.

Along these lines, efforts have been and are being made theoretically to identify a region by size, configuration, and land-use pattern. Devices of this kind may use the Lowry Model, mathematical allocation models, etc.

In the field of transportation, studies are being conducted by planners and researchers to establish an integrated system for managing transportation systems. One typical example is the current work by the Kinki Bureau of the Ministry of Construction performed with a view to establishing such a system by working with the real-world data on origin-destination surveys, generation, distribution and allocation of traffic, economic activities, land use and so forth, and further by building up appropriate models to be incorporated into a demand-forecasting system.

In the sphere of water resources, there have been an increasing number of studies that concern the management and planning of this resource. An interesting example that deserves attention is a series exploiting mathematical programming: non-linear programming, goal programming, SWT (Surrogate Worth Trade-off Method), etc. The advent of highly efficient electronic computers, together with the remarkable progress in hydrology and river engineering, has triggered a great advance in computer-based control systems for flood regulation and river management.

Another line of advance has been seen in the systems analysis of roads, railways, parks, water supply, sewage, solid waste disposal, etc., which are considered as the most relevant physical components of cities.

Also, an approach is being made to analysing both the growth of the community and the role of and need for social infrastructure.

The sophisticated environmental assessment technology that has recently been developed is expected to play an important role (i) in gauging the impact of a specific development on the environment such as pollution of air and water, noise, vibration, land-sinking, and (ii) in working out how the disruptions to the environment can be brought under control in the most effective manner.

### 3. THE KINKI DISTRICT DEVELOPMENT PROGRAM (KDP)—HISTORY AND NATURE

With the above discussion in mind, we now turn our attention to the plans that have been issued or are now under study for the Kinki district.

### 3.1. The National Development Program (NDP) and the Kinki Development Program (KDP)

The National Development Program (NDP) was issued in October 1962. Its goals were:

- to implement long-term developments for the nation
- to lead to growth of the national economy, to increased industrial activity in the existing industrial area, and to the development of industry in the underdeveloped areas
- to attain a balance of development between developed and underdeveloped regions.

The Kinki District Development Program (KDP) was issued in August 1967 to form a part of the NDP. Exclusively concerned with the Kinki district, it aimed at bringing the NDP down to the Kinki district level. Its major goals were:

- to propose the way for the Kinki district to attain the scale and structure of its economy in the target period 1965-1980 as demanded by the expected economic growth
- to redevelop densely populated (high-density) areas to avoid the disruption to the urban environment which often accompanies rapid population growth
- to develop sparsely populated (low-density) areas to fill in the gap in community services between high-density and low-density areas
- to coordinate both the development of industry and that of social welfare services, thus leading the Kinki district to a well managed growth.

Its major policies were:

- to establish (i) a suburban development zone, (ii) an urban development zone, and (iii) an environment preservation zone, all designed to be located within a radius of 50 km from the center of the Kyoto-Osaka-Kobe Metropolitan Area (the Keihanshin Area) in the Kinki district
- to achieve a well managed growth and equity of the entire Kinki district through the implementation of such projects as the development and reinforcement of (i) a transportation system, (ii) a river system, (iii) housing, (iv) a distribution system (e.g., distribution terminal), and (v) others.

### 3.2. The Second National Development Program (NDP II) and the Second Kinki Development Program (KDP II)

Despite of the fact that the targets for the NDP were (i) to avoid disruption of the living environment in some extremely rapidly growing areas and (ii) to improve community services for low-density areas, and despite the projects having been implemented along these lines during the target period, the late 1960s experienced a record economic growth, which brought on



both the unmanageable growth of central cities and the accelerated fall of population in low-density areas. At the same time, this economic miracle, together with the remarkable advances in technology during the period, has given rise to a mounting need for communication and transportation.

In this situation, a start was made on updating the NDP to overcome the unwelcome changes triggered by the preceding enormous growth of economy—pollution, noise, sprawl, disrupted amenities of the living environment, and poor operation of social investment, which lagged behind the economic growth. This revision was called the Second National Development Program (NDP II); its target period was 1971-1985. NDP II is characterized by large-scale regional projects and area-wide community developments.

In concert with this revised NDP, revision of XDP was made on the following points.

*Individual Land-use Prospects for Different Areas.*

In the central cities, the aims were:

- to regulate the influx of industry into the area
- to improve the systems of transportation and communication in order to put a sophisticated management of central city services into operation
- to achieve more intensive and efficient business functions in the CBD by replacing the old offices and shops by multistory buildings.

In the suburban area the aims were:

- to locate processing and distribution industries
- to house an increasing number of people getting out of the central cities to live in the surrounding countryside and commuting to jobs in the urban centers.

*Location Policy for Industry*

In order to handle increasing goods movements resulting from more people coming into the metropolitan area and from expanding economic activity, the following policies were proposed:

- to isolate distribution activities from personal transportation ones
- to locate distribution facilities at the key linkages of different modes of transportation networks, such as ports, roads, railways, etc.

*Rehabilitation of Urban Centers*

In order to avoid the disruption to the city services in dense areas, the following policies were proposed:

- to decentralize manufacturing and warehouse industries to low-density areas

- to establish zones and districts to fit in with the nature and capacity of the city
- to allocate effectively the CBD functions to the urban centers and subcenters to attain an increased efficiency of business activities
- to improve the living environment, particularly in the industry-residence mixed area.

#### *Redevelopment Projects*

Redevelopment projects were implemented to provide cities with parks, open spaces, arterial roads, urban highways, rapid transit systems, sewage systems, etc., thereby stimulating development incentives of private sectors through tax or financing policies.

#### 3.3. The Third National Development Program (NDP III) and the Third Kinki Development Program (KDP III)

As opposed to the NDP II targets of improving nationwide communication and transportation systems and of triggering nationwide repercussions of large-scale regional projects, the early 1970s experienced an increase in the population in high-density areas and a decrease in the population in low-density areas. Another crucial change that demanded the immediate revision of NDP II was triggered by the petroleum crisis in 1973, which promoted a resource-reserve reevaluation, and which drove Japan to a drastic recession from the high-rate economic growth she had enjoyed over a decade.

In the face of these unexpected changes, the second revision, called NDP III, is now under development. The major modifications will be made on:

- reevaluation of natural residential units formed by river basin boundaries
- dispersion of cultural and social facilities such as hospitals, schools, town halls, etc., to rural regions.

The notion underlying the revision work might be called the settle-the-inhabitants idea. The NDP III's main concerns will be with

- specifying localities rooted in historical, social, and cultural backgrounds
- giving due consideration to people's value system and living environment
- improving and rehabilitating the overall environment for people to live in comfort.

Major policies of NDP III would include plans:

- to preserve natural setting
- to improve and rationalize the living environment and basic resources such as housing, food resources, energy resources and so forth

- to redevelop high-density urban centers and surrounding areas (i) by identifying the capacity in size and function of specific cities and (ii) by reallocating the functions of central cities to low-density areas
- to develop local cities and villages (i) by establishing fixed settlement zones in which inhabitants are expected to live for many years and (ii) by reinforcing and providing a financial basis for local governments
- to make adequate utilization of land (i) by increasing the number and quality of educational, cultural, and medical facilities in low-density local areas, and (ii) by dispersing manufacturing industries to the same areas
- to develop communication and transportation systems.

This revised program, when completed in the near future, will be broken down to the in-depth revision work at each district level and as such, KDP II will be revised in the frame provided by the NDP III. (This revised KDP II would be called KDP III.)

#### 4. REGIONAL FRAME FOR THE KINKI DISTRICT

##### 4.1. Population

The population of the Kinki district is estimated at 18.83 million in 1975 with a growth rate of eight percent over the preceding five years (see Table 1). The population trend in Japan shows that there has been an increasing growth rate of population during the period 1960-1975, whereas the Tokyo Metropolitan district and the Kinki district have experienced a gradual slowing of the growth rate since 1965. The projected population of the Kinki district for 1990 is 22.79 million, provided that it grows by 21 percent over the target period 1975-1990.\*

Table 1. Trend of population (in millions).

District \ Fiscal year	1960	1965	1970	1975
Kinki district	14.030	15.780 (12.5)	17.400 (10.3)	18.830 ( 8.2)
Tokyo metropolitan district	17.360	21.010 (17.6)	24.110 (14.7)	27.040 (12.1)
Nation	94.300	99.210 ( 5.2)	104.670 ( 5.5)	111.930 ( 6.9)

Figures in parentheses represent growth rate (%)

Source: National Census.

The daytime population of the Kinki district in 1975 is 18.84 million with eight percent growth over the period 1970-1975 (see Table 2). Scrutiny of its trend pattern gives the same observation as that for the dormitory population. It is projected that the daytime population will reach 22.82 million by 1990 at the growth rate of 21 percent for the period 1975-1990. The projection also tells us that there will be a consistent immigration of outside population into the Keihanshin Metropolitan Area.\*

Table 2. Trend of daytime population of the Kinki district (in millions).

Fiscal year	1960	1965	1970	1975
Daytime population	14.05	15.79 (12.4)	17.41 (10.3)	18.84 (8.2)

Figures in parentheses represent growth rate (%).

Source: National Census.

#### 4.2. Employment

The number of persons employed in the Kinki district is estimated at 8.57 million in 1975, meaning that the primary industry accounts for 0.51 million (six percent of the total number), the secondary industry 3.34 million (39 percent) and the tertiary industry 4.72 million (55 percent). The national average shows 14 percent, 34 percent, and 52 percent, respectively.

It follows from this that the Kinki district is characterized by relatively high shares in the number of persons engaged in the secondary and tertiary industries, and a relatively low share in the primary industry. The past trend shows a drastic decrease in the number of persons engaged in the primary industry, no fluctuation in the number of those in the secondary industry, and a constant increase in the number in the tertiary industry.

The number of persons employed in the Kinki district is projected to be 10.62 million by 1990 at a growth rate of 23 percent over the period 1975-1990, meaning that there will be 0.34 million of those in primary industry, 4.05 million of those in secondary industry and 6.28 million of those in tertiary industry.\* This implies that in the Kinki district there will be a constant fall in the number of persons engaged in primary industry and a constant growth of those in tertiary industry. As for secondary industry, it will decrease in the Keihanshin Metropolitan Area, whereas it will grow in the rest of the Kinki district.

### 4.3. Economic Indicators

#### *Agricultural Production*

The amount of agricultural production in money terms is 323.5 billion yen, covering 6.8 percent of the total amounts for the nation (see Table 3). Projection shows that the amount will approach 505 billion by 1990.\*

#### *Industrial Shipments*

The amount of industrial shipments in money terms was estimated at 17,900 billion yen in 1974 with 21 percent share in the total amount for the nation, meaning that the amount for the Kinki district is 80 percent of that for the Tokyo Metropolitan district (see Table 4).

The projected amount of industrial shipments of the Kinki district in the 1990s is 39,000 billion yen with a growth rate of 116 percent over the period 1974-1990.\*

#### *Sales in the Wholesale and Retail Trades*

Sales in the wholesale and retail trades accounted for 33,700 billion yen in 1974, covering 24 percent of the total amount for the nation. This amount for the Kinki district is about 70 percent of that for the Tokyo Metropolitan district (see Table 5).

Projection shows that the amount will reach 83,000 billion yen, growing at a rate of 145 percent over the period 1974-1990.\*

## 5. PROPOSAL AND PROSPECT FOR THE KINKI DISTRICT

The Kinki district along with the Tokyo Metropolitan district has evolved for years as a center of national economy and culture. However, during the past decade, we have seen there many unwelcome changes, which an excessive concentration of population, industries, offices, and stores have brought on, thus putting central cities almost out of order. Furthermore there have been no effective measures taken so far to develop suburban areas.

We have a picture of the future Kinki district as ever growing, as the center of western Japan and as playing a greater role as a base terminal for distribution. This suggests a growing need for the development and reinforcement of the transportation system.

---

\*For details see the 1976 Study Report presented by the Working Committee of the Study on the Comprehensive Transport System for the Keihanshin Metropolitan Area. The estimated figures for 1990 were worked out by the Committee.

Table 3. Trend of agricultural production (x 10<sup>9</sup> yen).

District	Fiscal year	1960	1972	1974
Kinki district		351.6	334.6	323.5
		1.00* 7.7**	0.94 7.1	0.91 6.8
Tokyo metropolitan district		447.8	452.2	426.3
		1.00 9.6	0.96 9.0	0.95 8.9
Nation		4648.5	4726.2	4757.2
		1.00 100	1.02 100	1.02 100

\*growth rate \*\*share (percent)

Source: Statistics of Agricultural Income.

Table 4. Trend of industrial shipment (x 10<sup>9</sup> yen).

District	Fiscal year	1971	1973	1974
Kinki district		14,270	19,410	17,890
		1.00* 22**	1.36 22	1.25 21
Tokyo metropolitan district		18,800	22,690	22,180
		1.00 29	1.21 25	1.18 26
Nation		64,900	89,440	83,820
		1.00 100	1.38 100	1.29 100

\*growth rate \*\*share (percent)

Source: Statistics of Industry

Table 5. Trend of sales (x 10<sup>9</sup> yen).

District	Fiscal year	1970	1972	1974
Kinki district		26,920	28,740	33,700
		1.00* 24**	1.07 23	1.17 24
Tokyo metropolitan district		41,090	44,210	49,690
		1.00 37	1.08 36	1.12 35
Nation		112,480	123,650	141,770
		1.00 100	1.10 100	1.15 100

\*growth rate \*\*share (percent)

Source: Statistics of Commerce.

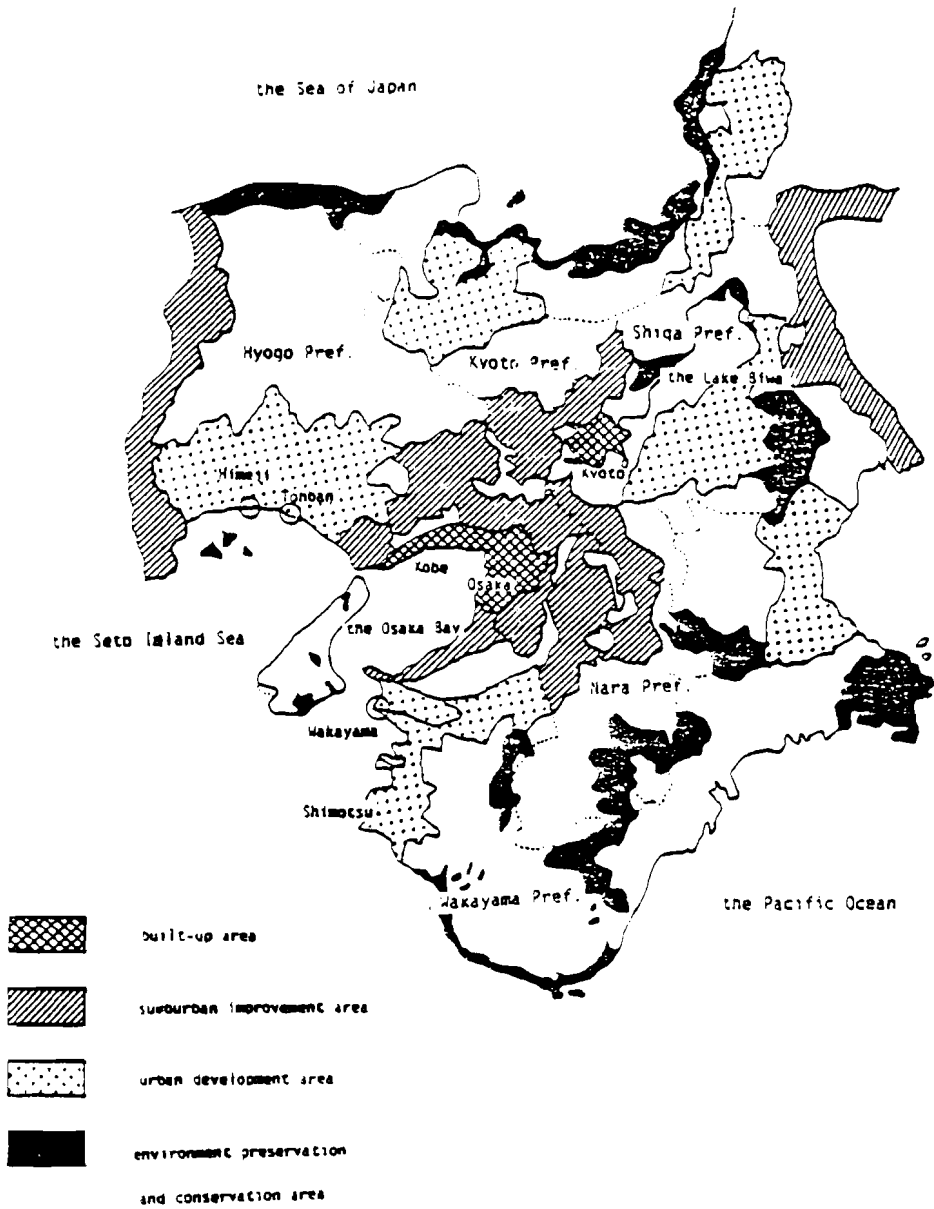

Figure 2. Land use pattern of the Kinki district.

There will also be an increasing amount of investment required for the construction and consolidation of international airports and ports. The need for improved communication facilities such as a variety of information service centers, results also from the increasing demand for a wider choice of high-quality information on a broader area basis and within a much shorter time.

The built-up areas of central cities are demanding renewal of urban centers and subcenters, development and reinforcement of transportation systems, improvement of living environments, provision of houses, parks and open spaces by moving the factories, and so forth.

It is felt that the suburban areas close to central cities need regional growth and expansion to be more effectively managed through more sophisticated land-use planning. Along with the development and reinforcement of the transportation system, projects should be implemented such as the preservation of green areas, vistas, cultural assets and so on, location of distribution terminals, the development of new residential areas called "new towns," and the development of academic cities.

In turn, there will be a growing need for the improvement and consolidation of local cities in the Kinki district. It is recommended that the locality be specified for each local area and be well planned—identifying the way to develop both the agriculture and the industry in the local area.

Decentralization of population and industry is a prerequisite to their dispersion from high-density built-up areas to low-density local areas by putting into operation several incentive measures such as tax or financing policies.

In the sphere of water resources, there will be a number of river-basin-oriented water-supply development projects to be implemented such as the Yodo River Basin Development Project (including the development of Lake Biwa), the Kino River Basin Development Project, and others. Thereby, close attention will be directed to bringing the water-supply projects in line with the scope, policies, and regional units on which flood-control planning is based.

It is proposed that Kyoto, Nara, and other places with distinguished vistas offer places for recreation, mountain vistas, waterfronts and shorelines, farmlands, traditional and cultural assets and so on. The conservation of attractive wooded slopes of the Rokko and the Ikoma mountain ranges is firmly recommended.

## 6. TRANSPORTATION PLANNING FOR THE KINKI DISTRICT

### 6.1. Highway Network Planning

In the preparation of network proposals, the statement of desired objectives is an essential step. These objectives describe the function that the arterial highways in the Kinki district should fulfill. The objectives established as such become the criteria against which network proposals are evaluated.



The next step in the planning process is the phase of testing to determine how well the proposed network matches the future traffic demand. This phase is called the traffic assignment process.

Figure 3 shows diagrammatically a proposed basic planning process for an arterial highway network. This process was proposed by the Working Committee of the Study on the Comprehensive Transport System for the Keihanshin Metropolitan Area, which was established in 1975 and which consists of members from the Ministry of Construction, the Land Use Agency, the Prefectural Governments of Shiga, Kyoto, Osaka, Hyogo, Nara, and Wakayama, the Municipal Governments of Kyoto, Osaka, and Kobe, the Japan Public Corporation for Highways, and the Hanshin Public Corporation for Highways. The study is now under way.

Notably, unlike the single-core pattern of the Tokyo Metropolitan district, which takes Tokyo as its core, the Keihanshin Metropolitan Area in the Kinki district is characterized by its three-core pattern, formed by Kyoto, Osaka, and Kobe. Taking this characteristic of the Keihanshin Metropolitan Area into consideration, the functions of arterial roads are broken down into three categories as shown in Figure 4. This figure provides a basis for reviewing functions of arterial roads, thus obtaining the functional axes as shown in Figure 5. Figure 6 shows the identified functional axes in terms of actual traffic volume for 1974.

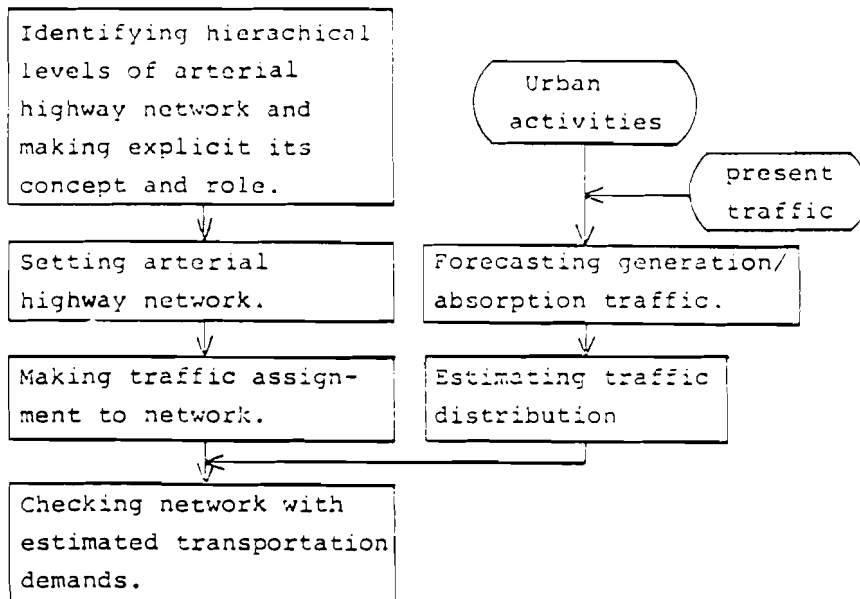

Figure 3. Proposed checking process for arterial highway network.

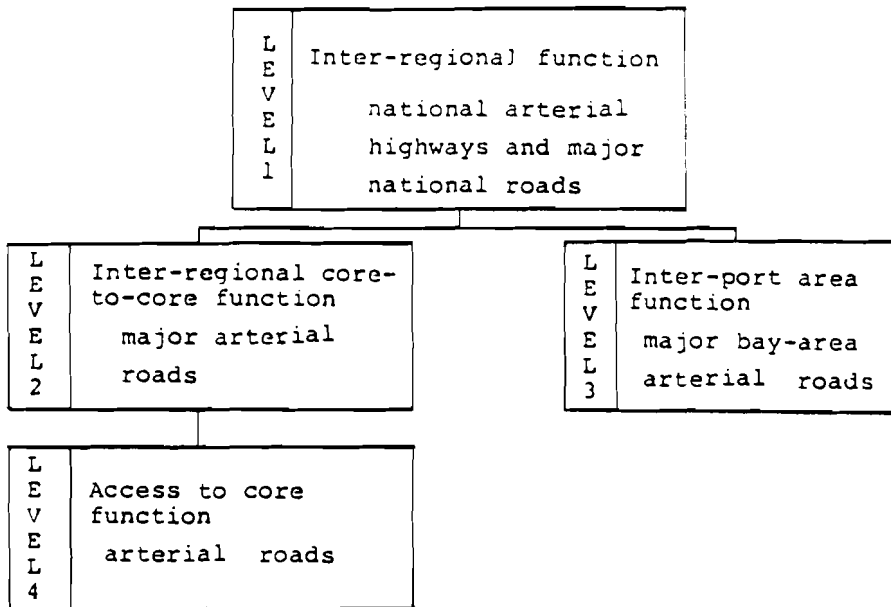

Figure 4. Hierarchical levels of the arterial highway network in the Keihanshin Metropolitan Area.

## 6.2. Railway Network Planning

The Keihanshin Metropolitan Area has experienced a rapid increase in traffic involved in commuting to jobs, attending schools and business activities. Despite the number of policies proposed and implemented in the past, it seems that the development and improvement of facilities have lagged behind the level that the demand has reached.

It is proposed that the policies for the development and reinforcement of rapid railway systems should include:

- reinforcement of the existing railway facilities to operate at full capacity
- construction of a new railway system only in those regions where increasing demands for railway transportation are projected to generate outside of the coverage area of the existing railway system
- setting the target load factor for one rush hour in the most crowded section as 150 percent
- design of a through-center transit system which requires the passenger to make no more than one transfer on average in getting to his destination

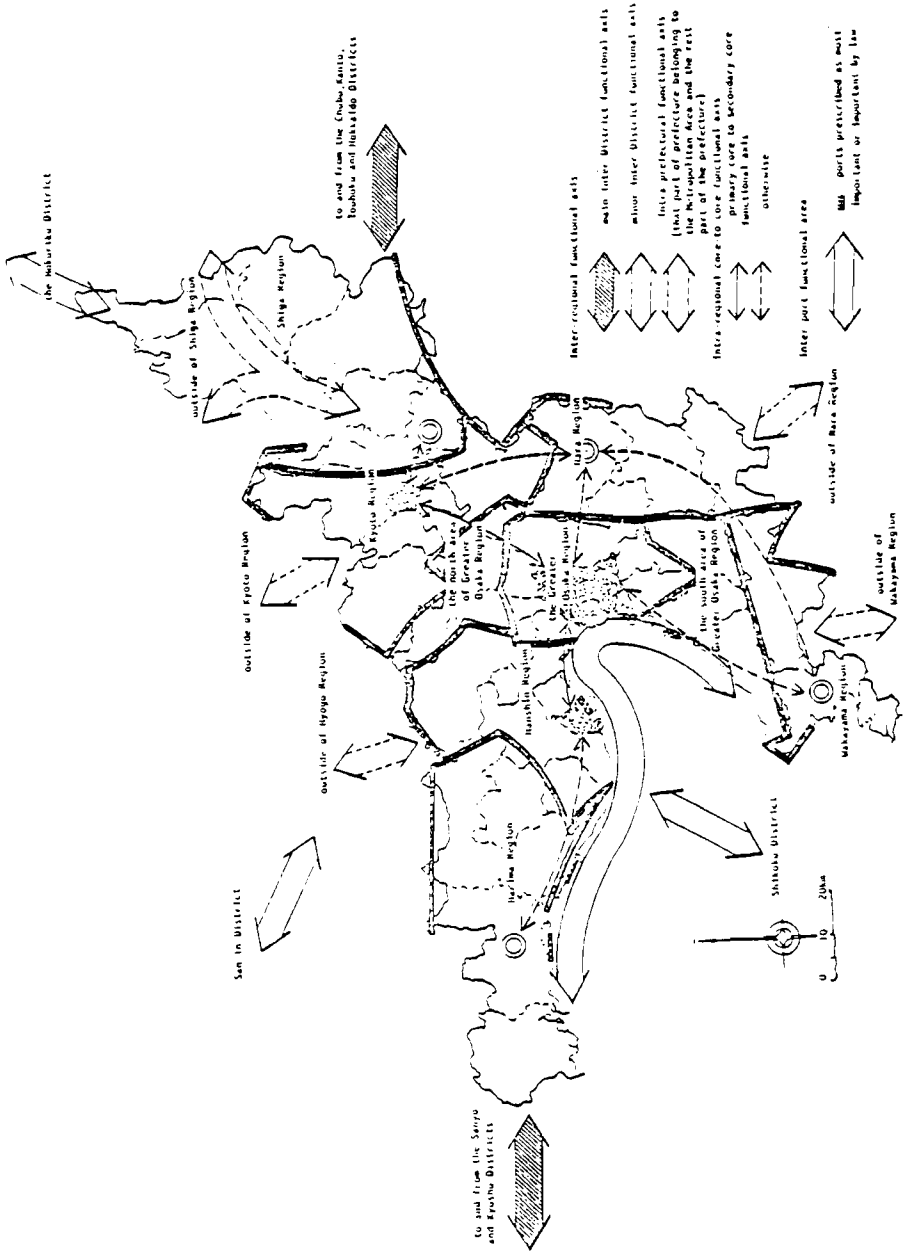

Figure 5. Functional axes of the arterial highway of the Keihanshin Metropolitan Area.

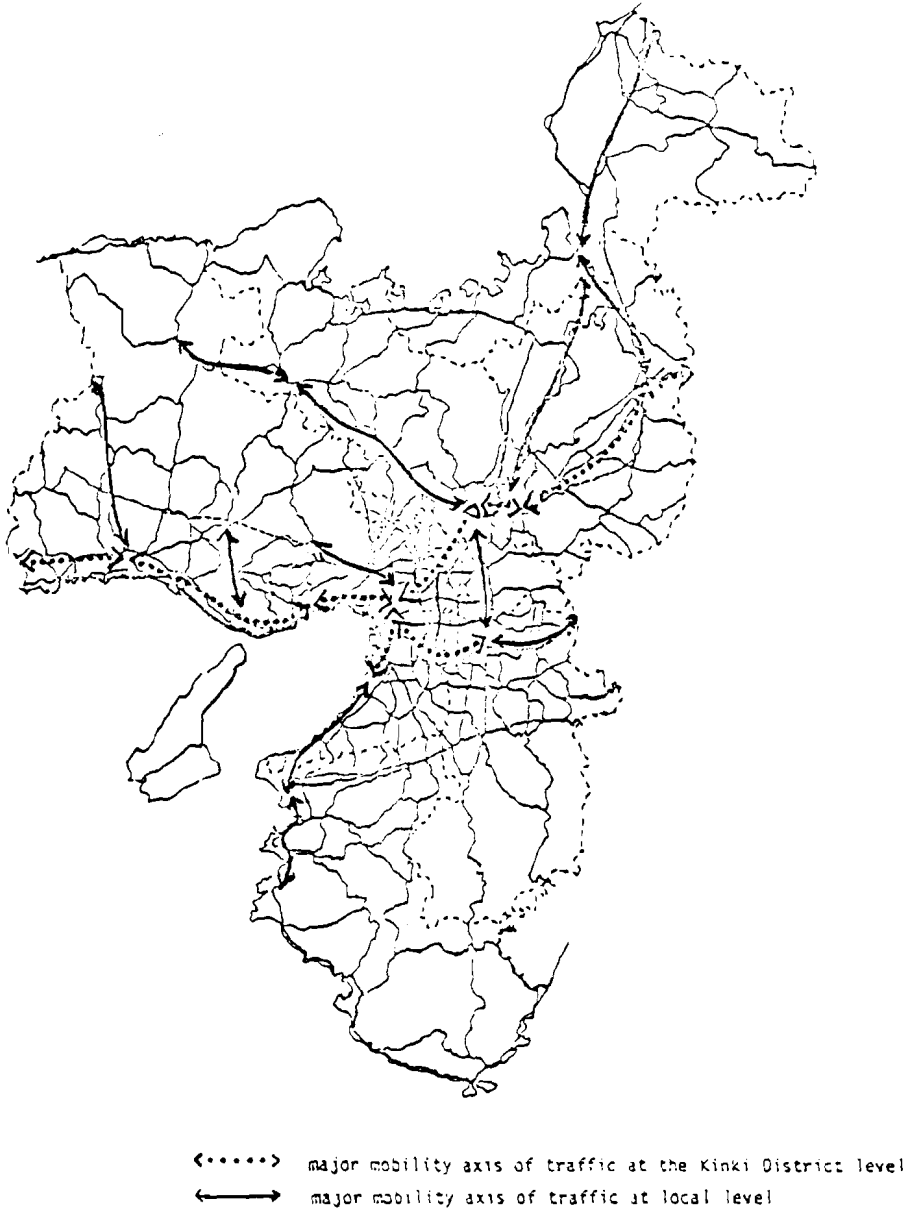

Figure 6. Mobility axes of traffic at present.

Source: Analysis Report on Arterial Highway Network of the Kinki district by the Kinki Regional Construction Bureau of the Ministry of Construction.

- checking of the form and routes of the proposed system with regional development plans, and ensuring that it conforms with both related regional plans and river management plans by considering the acquisition of land lots, the method of construction and so forth
- avoidance of the concentration of a proposed system on specific routes and terminals
- provision of a system for linking suburban areas with central cities, thus giving an impetus to the decentralization of urban functions and to the development of suburban areas
- introduction of new transportation systems, if they are necessary and appropriate in terms of local interests.

"The Transportation Demand Forecasts" conducted by the Ministry of Transport shows that in Kyoto, Osaka, and Kobe there will be over 50 percent growth in transportation demand by 1985. On this basis, the reinforcement projects for the existing railway system and the construction of a railway system are now under way.

### 6.3. The Study of the Comprehensive Transport System for the Keihanshin Metropolitan Area and Personal Trip Surveys and Urban Goods Movements Surveys

The balanced coordination of both railway planning and highway planning are conceived as prerequisites to the design of future urban transportation systems. For this purpose, methodological procedures should be developed to break down urban traffic into personal trips and goods movements, thus identifying the modal split of transportation of people and of goods based on the data obtained in personal trip surveys and goods movements surveys, and furthermore deciding on the shares of the former type of traffic by private transportation means (vehicles) and by mass transit system including the bus system, lightweight rapid transit system (LRT), heavyweight rapid transit system (HRT), etc.

There is a good deal of information available on personal trips—a very large inventory of data obtained in the surveys conducted for the Kinki district over the period 1970-1975. The survey results, obtained through the processing and analysis of vast amounts of basic data, offer us an extremely valuable guideline for establishing an integrated transportation system.

In contrast, we have an extremely limited amount of information on goods movements because of the fact that the survey work would require a formidable amount of data to be collected, processed, and analyzed and a vast number of man hours to be put in, and also because no explicit concept has ever been established for making use of such data for the above purposes.

It seems noteworthy to refer to the challenge against this unexplored problem that has been made by the Working Committee of the Study on the Comprehensive Transport System for the Keihanshin Metropolitan Area since 1975 when the preceding personal trip surveys were completed.

There have been several significant results obtained from this study so far, which point to the need for development of an arterial transportation system, and for improved efficiency of transportation.

## 7. TERMINAL PLANNING

### 7.1. Port Planning

There will be no change in the role of Osaka Bay as a distribution base point. There will be a growing need for the points located along the Bay to be used as commercial ports.

The shorelines ranging from Port of Kobe to Port of Hannan will be developed as a greater port on an area-wide basis. Consideration should be given to the preservation of attractive waterfronts in the Seto Inland Sea National Park Area and in the area ranging from the southern part of the Awaji Island to the Tomogashima Channel, thus maintaining the recreation potential.

In the face of an increasing amount of goods to be handled in the port area, the location of distribution facilities will be settled behind the wharves to achieve efficiency and integration of distribution system there. City-oriented industries including processing and distribution industries will be encouraged to choose their location in and behind the port area through the provision of developed land for these industries. Container and ferry terminals will be constructed to meet growing demands for container and ferry transportation.

It is recommended that the implementation of relief measures against excessive densities of neighboring areas and accompanying disruptions to the affected area such as pollution, noise, nauseous smells, etc., should be integrated in the port planning. The proposed measures include (i) the provision of land for urban renewal, (ii) the construction of facilities for industrial, commercial, and domestic disposals, and (iii) others.

These are the major policies that form the basis for devising a development plan of wharves as shown in Figure 7.

It should be noted here that the identification of the size and form that the development of wharves should take is made on the basis of both the projected amount of goods and the estimated dynamic performance of vessels and cargoes, observed through the operation of simulation models.

Since most of the shorelines along Osaka Bay have already been built up, some projects are now going on to develop wharves in the off-shore area, just as the Port Island and Rokko Island of Kobe, and South and North Osaka Ports were constructed.

On these wharves there are and will be located modern container facilities and distribution terminals together with recreational facilities and open spaces such as "community squares" and "international squares."



Figure 7. Development projects of Osaka Bay Area.

Source: Report on the Proposed Development of Ports along Osaka Bay presented by the Ministry of Transport.

## 7.2. The Kansai\* International Airport Development Prospect

Recently there has been a growing need for the development of a new international airport for the Kinki district. Major motivations are:

- The Kinki district is second only to the Tokyo Metropolitan district in the amount of population and industry concentrating on it.
- Internationalization requires the district to have a good entrance for international communication in the spheres of economy and culture.
- The increasingly good living standard of Japanese people as reflected in the growing level of national income and the greater amount of information and transportation needed, demands an increased quantity and quality of communication at international level. This also implies the growth of demand for another international airport in the Kinki district. (The existing international airport called the Osaka International Airport is located about 12 km north from the center of Osaka.)

Motivated by these incentives, a start was made about a decade ago to work out proposals for developing a new international airport somewhere in the Kinki district.

After many turns and twists and as the product of a bulk of basic studies on the selection of its location site, the following four places were proposed in 1975: (i) off the coast of Senshu, (ii) off the coast of Kobe, (iii) off the coast of Harima, and (iv) on Awaji Island (see Figure 8).

Then, further efforts were made to single out a location site. Considerations included:

- Could the navigation system guarantee airplanes making safe landings and take-offs?
- Would the access to the airport be convenient for users?
- Would it be technologically and economically possible to build the airport and would there be enough room to expand it when and where necessary?
- What impact would it have on the environment and particularly what about noise?
- What kind of interactions would it have with other plans and in what interfaces of planning would it occur?

At the present stage, the Senshu alternative, having been identified as the most eligible site, is going to undergo in-depth checkings, with the environmental assessment to be preceded by a series of basic field surveys on wind and maritime conditions in the vicinity of the proposed location site. The towers for observing and collecting data on such conditions are

---

\*The word "Kansai" is used as a synonym for "Kinki."



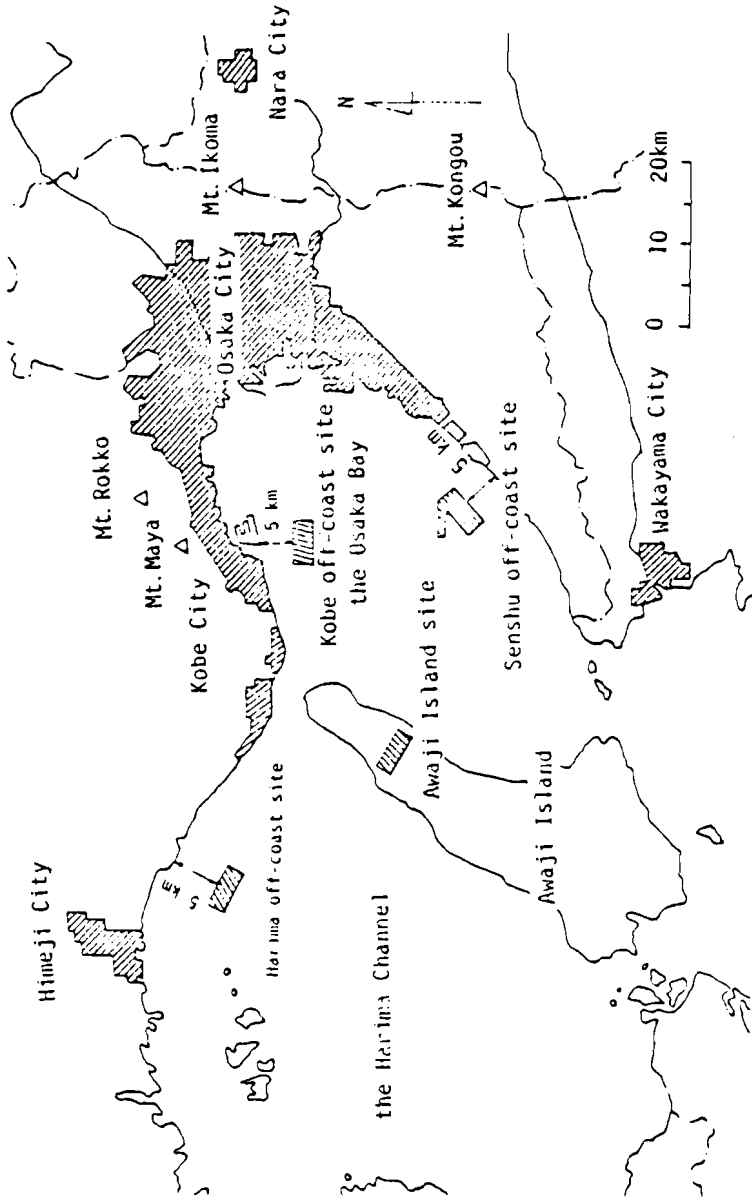

Figure 8. Four proposal location sites for the Kansai International Airport.  
Source: Report on the Proposed Scales and Locations for the Kansai International Airport  
presented by the Aviation Bureau of the Ministry of Transport.

now under construction by the Ministry of Transport. Concurrently, studies by the Ministry of Transport to provide basic information for devising a regional development plan of the neighboring area are taking place.

## 8. WATER PROBLEMS IN THE KINKI DISTRICT

### 8.1. Flood-Control Planning

Ensuring that peoples' lives and belongings are secure against natural disasters is a prerequisite for the stable establishment of a basis for living and production. Flood control is a protection service of this kind offered by some public agencies such as the Ministry of Construction, each prefectural government, etc.

The Yodo River Basin, the biggest in the Kinki district, covers 7.305 km<sup>2</sup>, being a part of the Shiga, Kyoto, Nara, and Osaka prefectures. It has three major tributaries converging on the main Yodo River, that is, (i) the Katsura River covering 14 percent of the area of the Yodo River Basin, (ii) the Uji River covering 48 percent of the same to include Lake Biwa as its origin, and (iii) the Kizu River covering 20 percent.

In December 1954, the Development Program for the Yodo River Basin was issued. The outlined policies are the following:

- The return period of flood was set as 100 years for the trunk, and 80 years for the tributaries.
- There have been several flood-control reservoirs such as the Takayama Dam on the Kizu River, the Amagase Dam on the Uji River and so forth.
- The Seta River (the upstream section of the Uji River) was dredged to such a depth as required by the proposed relocation of the original weir called the Nango Arai Zeki. The new weir was designed to discharge 600 m<sup>3</sup>/sec of water at the gate when the water level of the Lake Biwa rises to nearly zero meters.
- Improvement and reinforcement were made of hydrological and climatic data collecting systems to include observation stations and telemetering, thus resulting in an inventory of copious hydrological data available for the Yodo River Basin, to enable it to be equipped with a reinforced flood-control forecasting system.

This system constituted the backbone of the Integrated Control System for the Yodo River Basin, which was completed in 1969.

The Development Project for the Yodo River Basin, issued in 1971, is based on the following guidelines:

- The peak flow of flood, at which the high-water level is set, is determined to be 17,000 m<sup>3</sup>/sec at a data collection point located in Hirakata City assuming that the average two-day rainfall is 302 mm. The return period of flood is set as 200 years for the trunk, and at 150 years for the three tributaries.

- Another important part of the plan is the proposed prospect of the Lake Biwa Development setting forth the proposed measures for controlling pollution, keeping the natural setting intact, improving drainage of water and so forth.

### 8.2. Water-Supply Planning

There has been a growing demand for water especially in the high density area—triggered by the rapid growth of industrialization and urbanization which have taken place since the 1960s.

Despite the fact that the provision of water has always lagged behind the unexpected growth of water demand. This had motivated the undertaking of the Second Survey of Area-wide Water Supply and Use System by the Ministry of Construction which presented the survey report in August 1973.

According to the projection, total demand for water in the 1985s Kinki district is 12.89 billion m<sup>3</sup> per year, with about 3.48 m<sup>3</sup> of water demand being added to that of 1970. The amount of water demand that will be covered by streamflows is estimated at 10.76 billion m<sup>3</sup> per year for 1985, with about 4.41 billion m<sup>3</sup> of increment over 15 years.

Figure 9 illustrates the water supply demand picture of the Kinki district for 1985, indicating that there will be about 1.2 billion m<sup>3</sup> water shortage per year. The stop-gap measures proposed are:

- Reduction in the amount of water demand through reasonable restrictions on domestic and industrial uses.
- Renovation of waste waters through the tertiary treatment process, thus accelerating the recycling of water resources.
- Implementation of the area-wide development of water resources.
- Promotion of the dispersion of population and industry to local areas, thus reallocating the demand sources to the low density areas.

### 8.3. Landscape Planning

With deleterious changes increasingly spreading over high density areas such as disruptions to the natural setting and ecological system, the need for the preservation of natural settings is growing year by year. This is reflected in the increasing understanding that the river system should be considered as a natural system which should be kept as intact as possible and which could provide people with a place for recreation. Several policies in this line have already been worked out and put into operation such as (i) the management of the recreation potential of the river system which is designed to be open to the public, (ii) the regulation of the amount of waste water effluents discharged into the receiving water from industries, (iii) the construction of sewage treatment systems, and (iv) others.

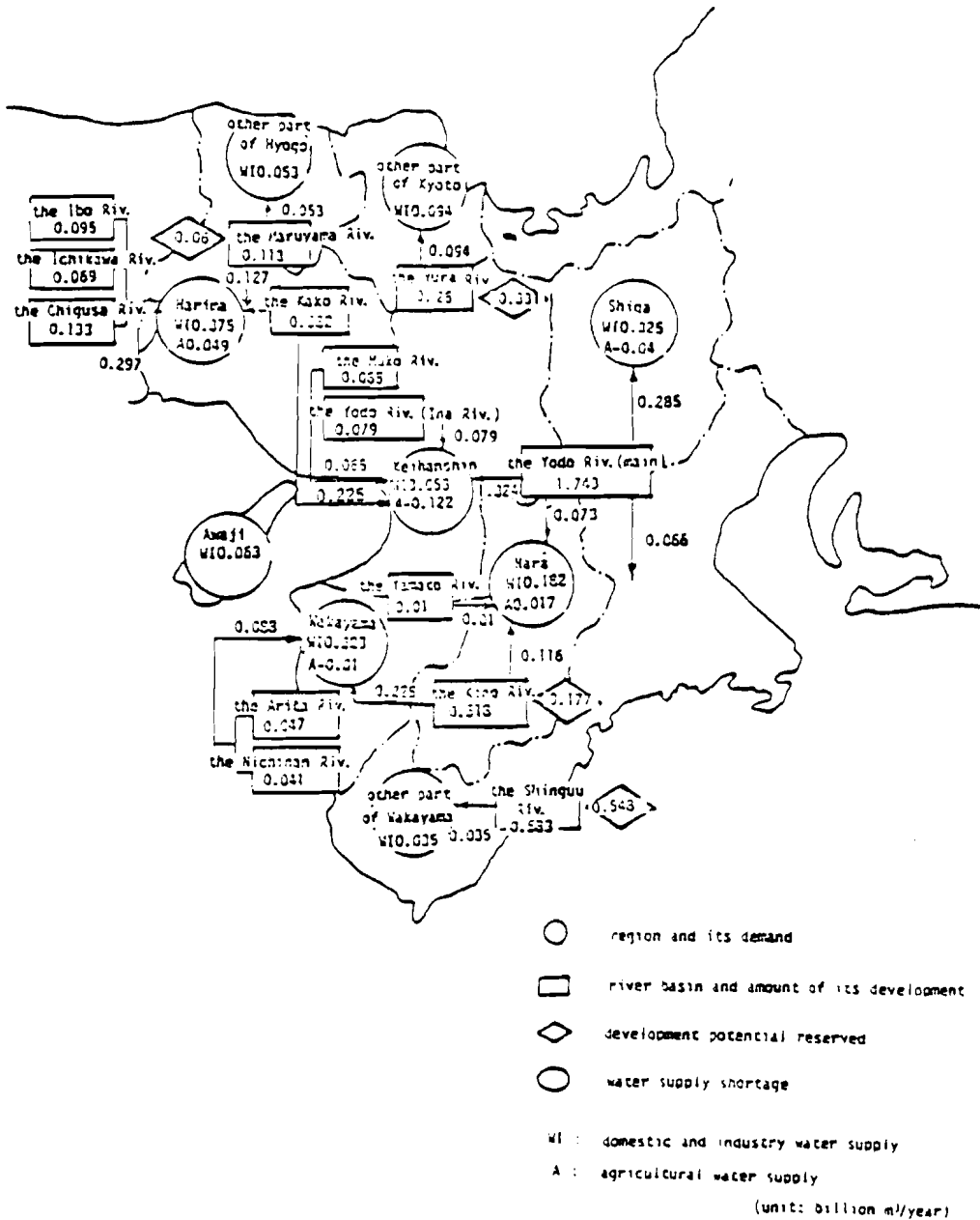

Figure 9. Water supply-demand prospect for the Kinki district.

Source: The Second Survey of the Area-wide Water Supply-Use System conducted by the River Management Bureau of the Ministry of Construction.

## 9. URBAN REDEVELOPMENT AND NEW TOWNS

### 9.1. New Town Projects

One typical question that faces our cities is how to house growing numbers of residents in the city area as the urbanization goes on. There have been many measures invoked to find solutions. One good example is the development of new residential areas called new towns in order to accommodate as many as 100 to 300 thousand inhabitants.

The development projects for new towns going on in Japan seem to be different in nature from those seen in Western countries. That is, most of our new towns are built as satellite towns attached to the central city to which people travel to work by day and from which they return home by night.

We have a well known example in the Senri New Town, which has developed on the western side of Senri Hill located about 15 km northward from the center of Osaka City. This development project was started in 1961 by the prefectural government of Osaka and there appeared a modern new town (satellite town) in the developed land of 1,160 hectares and with a population of 150 thousand.

This project was followed by the Senboku New Town Project which is now under way at the hands of the same government. There are also a couple of projects going on in Kobe City such as the Seishin (the West Kobe) New Town Project and so forth.

### 9.2. Industrial Zone Development

There are several development projects of industrial zones now going on across the Kinki district. The expected goals of the projects are:

- to relocate existing industries from the high density area into the low density area
- to disperse to the low density area industries that would otherwise converge to the high density area
- to promote the development of local cities by implementing the development of industrial zones as a basic incentive.

Many projects of this kind are now under way in the Kinki district. An example is the Industrial Zone Development Project for Osandano in Fukuchiyama City, Kyoto prefecture. It is undertaken by the prefectural government of Kyoto and expected to make a great contribution to the development of Fukuchiyama City, a typical local city in the Kyoto prefecture.

### 9.3. Industrial Terminal Projects

The existing distribution system of Osaka City is characterized by the concentrated locations of distribution functions in its inner regions such as truck terminals, railway cargo

terminals, warehouses of the central wholesale market, wholesale merchants, and retailers, etc.

With a growing amount of in and through traffic flowing in the city, the efficiency of the system has lowered year by year, thus resulting in the unprofitability of the distribution industry. The proposed measures to overcome this difficulty include the following projects:

In Osaka prefecture

- Distribution terminals were constructed in East and North Osaka.
- A joint terminal was located in the South Osaka Port.
- Industrial zones for wholesale and distribution are being planned for South Osaka.

In Hyogo prefecture

- Distribution terminals are proposed for the Port Island, the IV Construction Section Area in Kobe Harbor, the Harima region, and the Hanshin region.

#### 9.4. Environment Management

In the post-war period Japan has enjoyed an economic miracle brought on by a very high level of productivity attained in this narrow land. The political support of the economy was provided by national economic plans such as the Double-Income Program.

The economic miracle is neither complete nor perfect, though it has undoubtedly made a great deal of contribution to the improvement of living standards. Rapid expansion has caused all manner of imbalances—impaired natural setting, polluted air and water, noises, vibrations, lost sunshine, etc.

This situation has implied a growing demand on the part of residents for improved amenities in the living environment, and for a more healthy, more cultural, and more enjoyable community to grow in concert with the natural setting. To meet the demand, there has been an increasing emphasis placed on the environmental assessment of the project to be implemented.

Many preventive measures are also being taken into consideration such as (i) separation of industrial activities from residential areas by locating green buffer zones between them, by building buffer walls to reduce noise level, checking production or construction systems to reduce vibration, (ii) location of pollution control centers, (iii) improvement and reinforcement of forecasting systems for air and water pollutions, and (iv) others.

## ACKNOWLEDGMENTS

This report is a product of the joint work by the following people who exchanged ideas and views at the informal seminars on regional development of the Kinki district.

S.B. Sunao, Chief Planner, the Chuo Fukken Consultants Co. Ltd.; T. Sasada, Associate Professor of Environmental Design, Department of Environmental Engineering, Osaka University; M. Haruna, Associate Professor of Regional Planning and Systems Analysis, Department of Civil Engineering, Kyoto University; S. Yamaguchi, Senior Lecturer of Environmental Design, Department of Architecture, Kyoto Institute of Technology; N. Okada, Associate Professor of Regional Planning and Systems Analysis, Department of Civil Engineering, Tottori University; K. Yamamoto, Research and Teaching Associate, Regional Planning and Systems Analysis, Department of Civil Engineering, Kyoto University. The author is indebted to Professor Y. Sawaragi from Kyoto University, who kindly opened the way for the presentation of this report to the IRDP IIASA Symposium held on October 17-18, 1977, in Kyoto. Acknowledgment is made for data services provided by the Ministry of Construction, Ministry of Transport, and the Executive Office attached to the Working Committee of the Study on the Comprehensive Transport System for the Keihanshin Metropolitan Area.

## THE ROLE OF MODELS IN INTEGRATED REGIONAL DEVELOPMENT PROGRAMS

M.M. Albegov, J.W. Owsinski, and A. Straszak  
*International Institute for Applied Systems Analysis*

This short paper presents opinions and ideas as to the application and role of models in large-scale regional development integrative undertakings arising from previous experience at IIASA during 1974-1978.

### 1. ORIGIN AND CONDITIONS OF MODEL USE

Let us start with a statement on the role of models, formulated in a straightforward manner:

Computerized mathematical models serve to help in the making of decisions through rapid handling of data and prespecified relations so that a quick review of alternative decisions, or a definition of the optimal ones (which otherwise could not be found), is made possible.

Having this, one can look at the context in which the needs for applying specific models emerges.

First, there is always some *problem* within the socioeconomic system that is the object of consideration. The problem may have the character of a threat or of an opportunity [1]. Essentially, the problem cannot be considered unless perceived by or confronted with some (decision-making) body affected by it. For, in general, problems arise when (sufficiently big) changes occur within the socioeconomic *object system*, or within the *values* according to which it is being shaped, or both [2]. In order for a problem to appear, it must transgress the capacities of the existing managing system to automatically adapt.



Thus, the problem is projected into the *organizational and institutional system* over the socioeconomic object system to direct and manage it. Not only is it projected into the managing system because that is where the solutions should be elaborated, but also because that is where the problems arise especially as far as values and reaction capacities are concerned.

Hence, if problems that have arisen are complex enough, and/or their straightforward handling through the actual managing system might be cumbersome, at some point in the solution process the need arises for application of computer-based models. In view of the above considerations it is clear that such models should not only adequately reflect the reality of the socioeconomic object system, but necessarily they should also correspond—in their contents and structure—to the institutional system. Any model, or model system, however sophisticated, if void of institutional relevance, is deemed to be inapplicable.

The question, which to some extent is addressed here, consists therefore in formulating and assessing conditions for various ways in which institutional contents and roles of models can be devised, ranging from a normative internalization of interactivity and interinstitutional relations in a model (system), so that an optimal reshaping of both is obtained, to a substitution of potential integrative organization by an appropriate composition of a model system interinstitutionally accessible.

## 2. THE CASE OF LARGE-SCALE PROGRAMS

The above postulates take on their full meaning when confronted with a large-scale problem, which necessitates introduction of a program. More specifically, it is understood that a program needs to be devised if changes in the object system and/or values defining the problem structure are sufficiently big to make it impossible for the existing managing system to handle the problem appropriately. A program does not have to require major structural changes of the managing system. The minimum necessary alterations may just consist of some shifts in functions of existing elements or establishment of a coordinating body. In principle, insofar as the arising of a problem can be seen as a perturbation to a smooth movement along a predetermined general trajectory, such program-bound changes should be considered temporary and after the problem has been successfully solved to dissolve into the preexisting structure. This, however, is not very often the case. Programs tend to self-continue.

For purposes of our considerations it is important to emphasize that the case of a program does not only involve a growth in "volume" of the appropriate *problématique*, but, primarily, a qualitative change in interinstitutional relations (see Figure 1). Thus, in this case, a problem of representing adequately in models and of shaping the model system so as to allow some intelligibility for, and communication with, all the "actors" affected and/or affecting the outcome of the program is of utmost importance. This, of course, is first of all concerned with the value side of the problem.

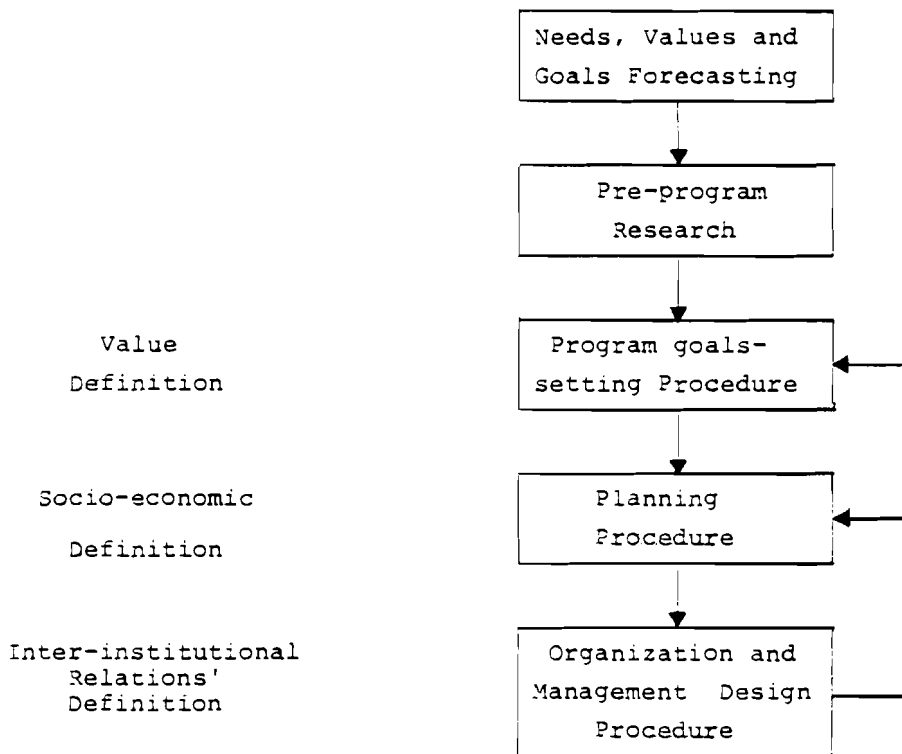

Figure 1. Formation procedure for development program.

Source: [3].

For any such large-scale program case there might be two distinct, differing approaches to modeling, but quite as well, in connection with it, to general managerial design (see Figure 2).

The first approach, more strict and rigorously formal, is at the same time more *normative*. It starts from a clear definition of an ultimate dominating goal, whether exogenously given or determined internally. This goal is then decomposed into tasks, taking into account interests and scopes of responsibility of individual elements with regard to the ultimate goal. (In conditions of planned economies this usually means a breakdown into sectoral economies, inasmuch as they contribute to the program.) With resource limitations set, the problem finally boils down to an allocation/assignment procedure according to the efficiency of contributions. This allocation may be based upon lower-level optimization, aiming at maximization of some kind of element's own benefit, preserving consistency with the ultimate program's goal (for example, minimum of costs attained at one level of optimization coupled with maximum of benefits sought after at the other level). (See Figure 3 for the planning process procedure.)

Another way of approaching the problems related to large-scale programs consists in admitting the *multi-purpose* nature of such large undertakings with regard to the variety of institutions and groups participating, and the complexity of their interrelations. Assuming certain general formulation of the program's goal(s) the approach treats in a more loose manner its quantifiable achievement via the use of quantifiable instrument and element performance. The models here are not seen as normative planning devices, defining details of trajectory to be followed, but rationalizing, aiding tools for individual participants, helping in mutual understanding and coordination, and thus promoting integration in the achievement of the general goal.

Certainly, these two approaches do correspond to differing socioeconomic conditions and have differing modeling implications.

The first approach can far better be applied in a situation where fuller control is exerted over the operations of elements (e.g., planned economies), where institutional relations are well defined in their contents, priorities and hierarchies, with uniquely defined responsibility and power scopes within the managing system. On the other hand, such an approach is more easily implementable for programs that are being fostered in less dense and complex socioeconomic settings (e.g., frontier development), allowing an omission or an easy endogenization and quantification of costs and difficulties related to changes introduced (interactivity, interinstitutional). Such is the case, for instance, with the newly established industrial complexes in the Siberian part of the Soviet Union.

Consequently, the second approach fits better the ill-structured power and capacity situations (for example, with the problem area of the program encompassing several institutional scopes of responsibility). In fact, inasmuch as the large-scale

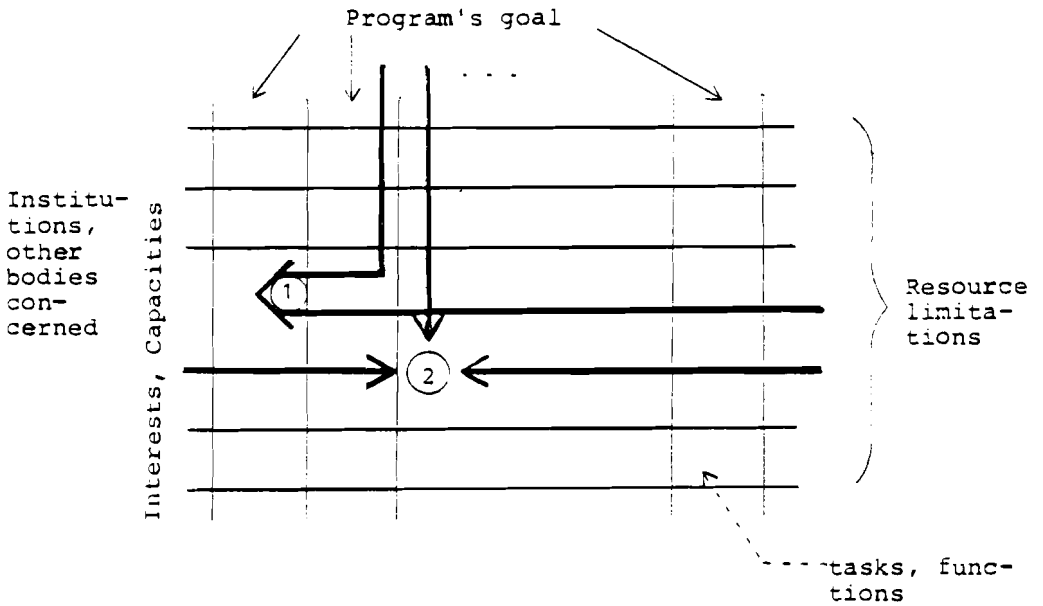
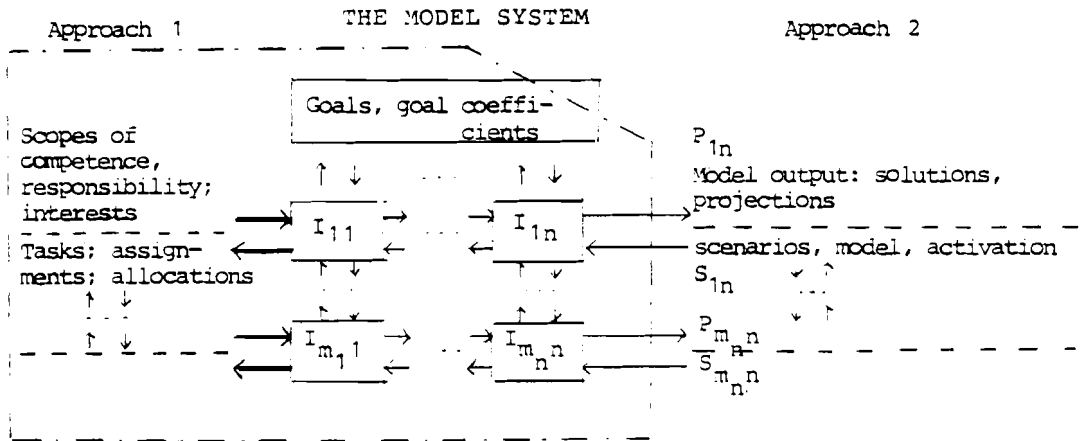

Figure 2a. Rationales for the two approaches.



Boundary of the model system

$I_{ij}$ : portions (possibly overlapping) of the model system corresponding to (institutional) participants of the process (j) on the i-th level.

Figure 2b. Modeling consequences of the two approaches.

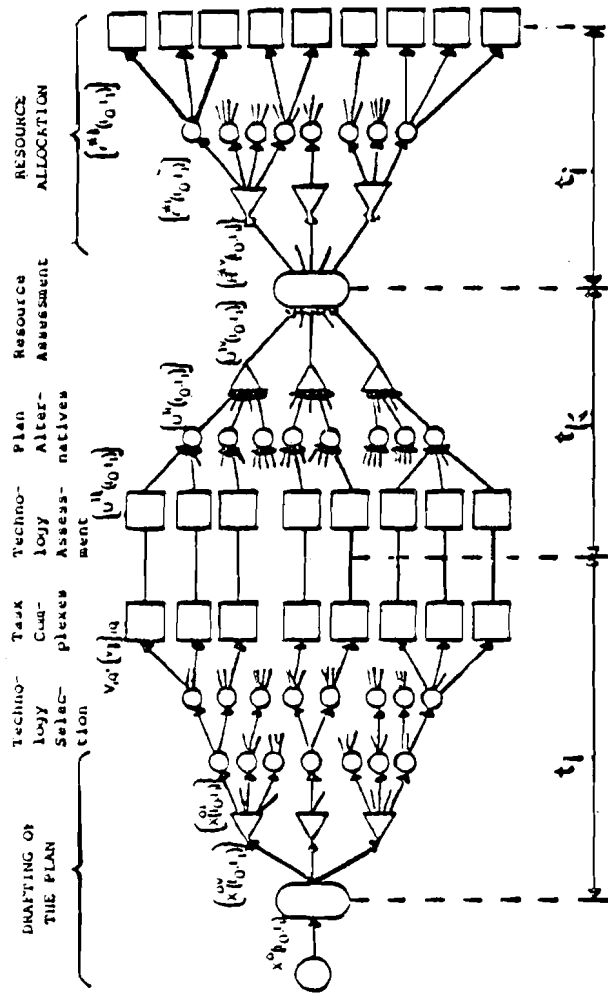

Figure 3. Procedure for the planning process.

Source: [3].

programs do by their very nature involve overlapping of interests of many institutional subsystems, this qualification, albeit in varying degree, applies to all of them, calling for inclusion of the second approach elements. Furthermore, this approach should rather be taken when dealing with well developed socioeconomic systems of high-density interactions, multiple values and polyvalent use of resources.

Implications for modeling resulting from the two approaches and the types of situations attributable to them comprise not only (or even not very much) their methodological contents, so much as their more general features: way of problem formulation, structure of model system, role played in the planning process (see Figure 2b for an ideograph).

In the case of the first approach a more formalized treatment of the problem is presupposed. Ultimately, the whole of the task performed by the corresponding model or model system can be regarded as the *program's plan optimization*. If decomposed and hierarchically organized, strict consistency of goal functions must be ensured. There would be an *a priori* coordination, or coordination procedure for solutions and parameters exchanged among the subtasks-submodels. If so, the results must be regarded as binding and to have explicitly normative character. They are the "optimal" overall program plans and plans of program elements (individual activities). As such they should be followed in the same degree by *all* the program contributors. Relaxation of this requirement is hard to handle and may involve essentially a diversion from optimality.

Models developed within the second approach may not ultimately constitute an optimizing system. Their normativeness will go just as far as the specific conditions allow, and may even have a mere simulative, descriptive character. These models would form a *carrier for mutual understanding and integration* through apprehension and rationalization of positions *vis à vis* the potentially common goal [4]. They will, in other words, not serve directly as development-plan-defining instruments but will rather help in alleviating development difficulties. To allow the carrying out of such functions the models must reflect with high accuracy both the socioeconomic and the institutional situation of the user, and their set must form a manifold of sufficient dimensions (there must be certain model redundancy created by the introduction of maximal available variety of relevant models) from which specific application conditions could be reconstructed [5, 6].

### 3. INTEGRATED REGIONAL DEVELOPMENT PROGRAMS

Regional development programs, especially those aiming at integrative socioeconomic growth, may be seen to constitute a very special case of the large-scale programs. It is, however, more proper to regard them as forming a special, separate type of program. This is so primarily because these programs touch upon all the kinds of human needs and actions, their fulfillment and organization.

In adapting any sort of approach to purposes of integrated regional development (IRD) programs and in devising the role for models within the interinstitutional managing system this special character of the IRD programs has to be taken into account. Admitting that, as pointed out in the final remarks of the previous section, application conditions are to a large extent set by the specific features of the particular case, some general arguments can be voiced for the IRD programs' model applicability and role.

### 3.1. Structures and Application Conditions: The First Approach

Referring to the first type of approach characterized in the preceding section we shall illustrate it with the approach that was presented in [7] and then, for a more specific case, [8]. This structure (see Figure 4) is proposed as a sort of a starting point in elaboration of a more detailed, comprehensive model system. As can be easily seen, working of the structure starts with (exogenous) marginal costs and prices related first of all to resources and products defined at the level of national economy. These, coupled with regional conditions of development of various activities (sectors) and with a given limited national investment capital, yield optimum directions of region *specialization* (level I). Once specialization is defined, intraregional location problems can be solved for all basic activities (level II). Determination of growth and location parameters have to be closely related to demographic and consumption-and-expenditure considerations (level III). Finally, the shape and structure of the settlement and service system and the environmental conditions can be established (level IV).

The whole structure is assumed to be iteratively working and converging towards some ultimate overall solution. Thus, the structure is to conform with the left-hand side of Figure 2b. For the time being many functions, especially of feedback and coordination character, have to be performed "outside" the structure, with no computerized back-up. In principle, however, all these could be formalized and computationally implemented. From the structure itself, and from the above comments as well as from the blow-up of a module composed of four submodels, shown in Figure 5, the envisaged way of applying results of the models comprised in the structure can easily be seen.

The rationale behind this structure is based upon assumptions of:

- national significance of regional program
- high degree of openness of the region
- reliance on national provision for material and financial resources
- high capacity of planning intervention
- necessity of formulation of clear-cut policies for use in a well structured managing system
- established relations in scale and agglomeration economies.

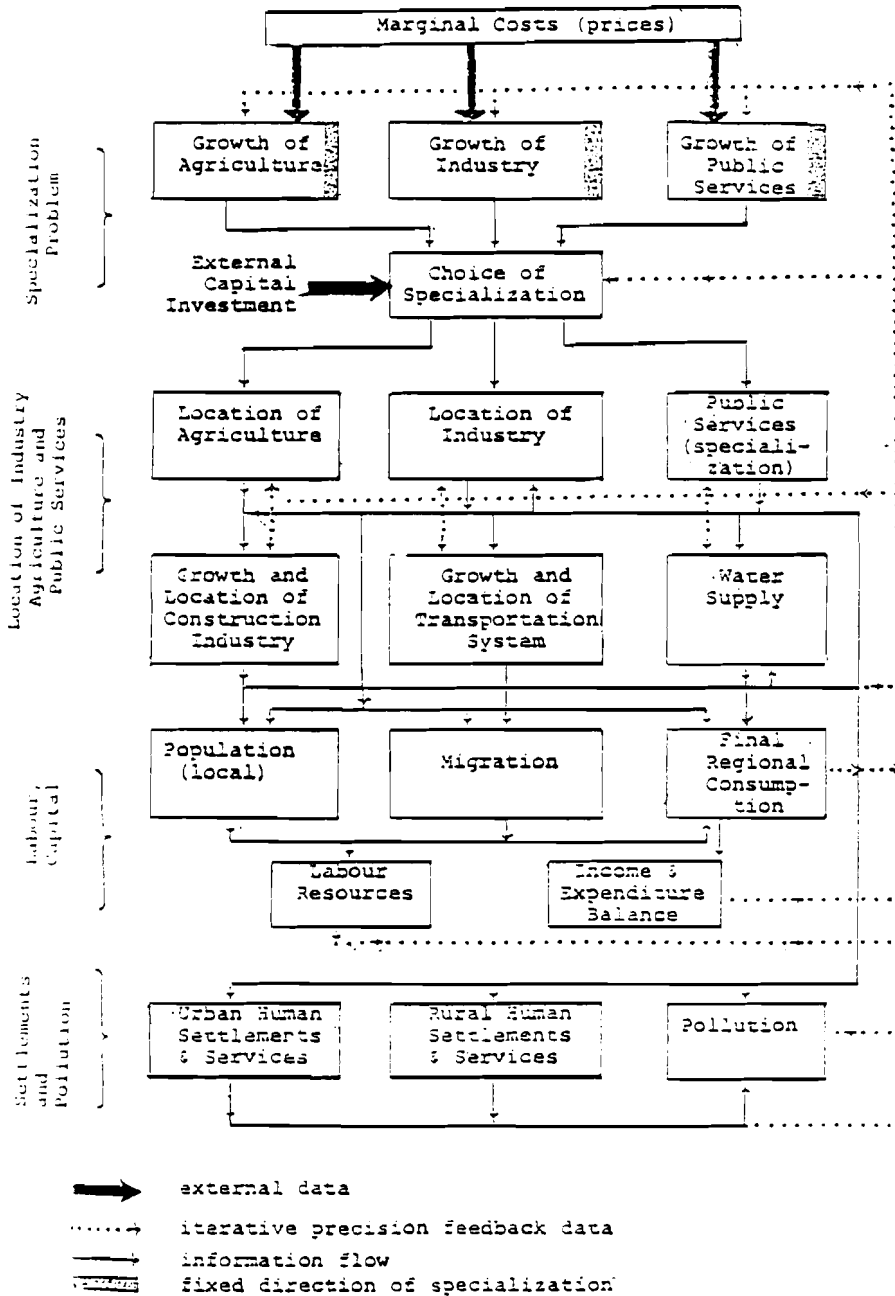

Figure 4. Structure of the regional model subsystem.



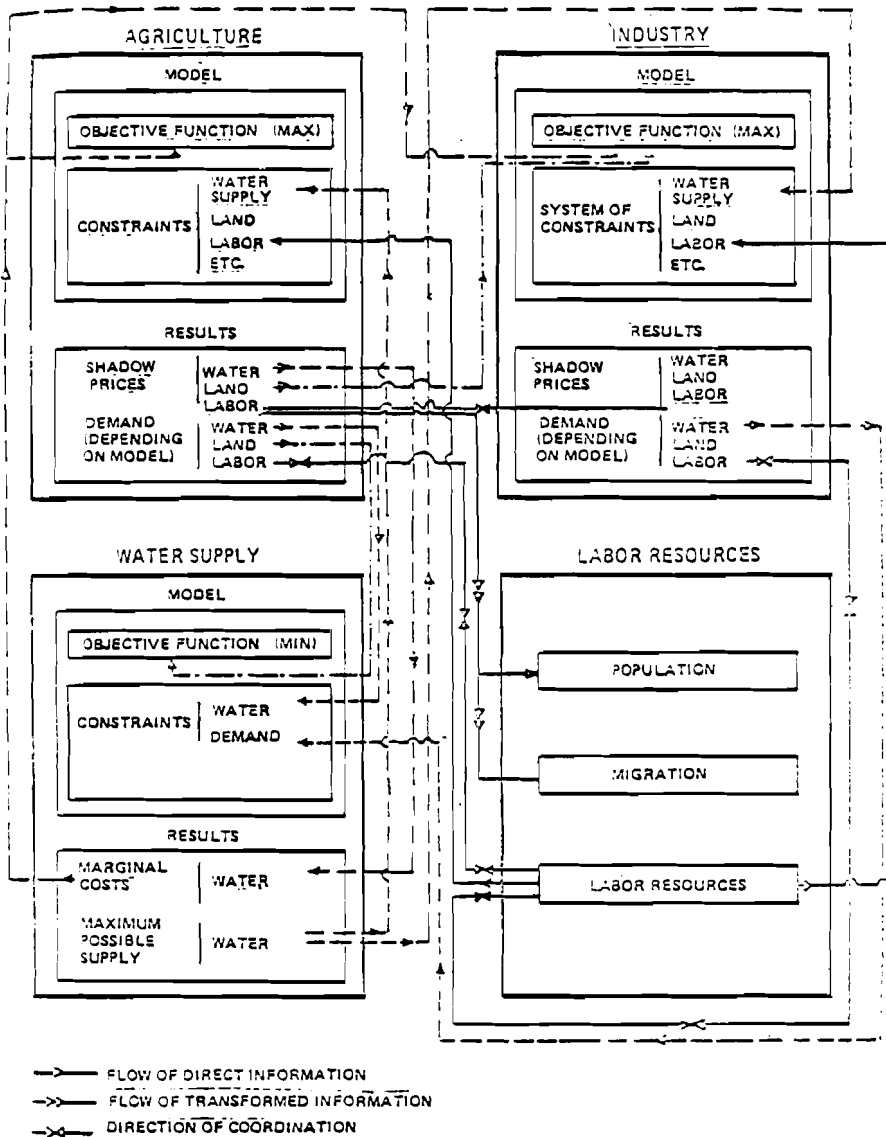

Figure 5. A portion of the regional model subsystem: a four-model module for agricultural regional development.

Source: [3].

When one speaks of large-scale IRD programs (for instance, those that concern nationally or internationally important regions in their overall development) then it is obvious that the first and presumably also the second and the third of the assumptions listed do hold, and that therefore the model system's features resulting from these conditions have to be introduced. On the other hand, however, the other three assumptions need not be satisfied in many cases, not only in market economies (where instruments of intervention are missing for the most part), but also in planned economies (where sectoral planning and management have prevailed and still require an important effort in coordination on the territorial or regional basis), especially if the program's geographical territory and economic reach is not well delineated or overlaps with existing administrative and capacity delimitations over a highly developed region. In such instances, one is dealing with an intricately interwoven mesh of responsibilities and interests, not only in the object system itself, but also in its managing counterpart. Construction of clear-cut normative models may be quite severely inhibited by difficulties in, for example, cost estimation. Furthermore, for a bigger, composite and highly developed region, assumptions two and three may hold to a lesser degree, necessitating endogenization of appropriate variables.

Thus, while it seems unavoidable to proceed in the direction of consistent, normative modeling structures (see also [9]), which would yield results indicating optimal directions of growth and their conditioning (sensitivity, robustness, etc.), for many practical cases deployment of such ready-made structures will encounter important difficulties. A good example for a situation where such an approach can be fully applied is provided by the Bulgarian Silistra case study, now underway within the IRD activities at IIASA [10, 11], and, somewhat less evidently, by the Polish Upper Notec case study [12, 13]. Where a limit for explicit application can be set is a matter of debate; it is however, beyond any doubt that with improved modeling and software techniques, the application scope of the first approach is expanding, although confined to those rigorously formalizable optimization problems.

### 3.2. Structures and Application Conditions: The Second Approach

Thus, actual conditions do not always correspond to those best fitted to the first approach. Besides the case of changing conditions there may also be some more general arguments to be raised in favor of the second type of approach. First, it is often said that there is a lack of well defined regional economic growth theory that would effectively link major components (demography, resource and capital structure, etc.) to indicate conditions and potential directions of development. In fact, the first approach presented omits this—apparent—difficulty by attacking the problem via a balancing/accounting framework, the relative efficiency of various activities in various locations with regard to resources assumed to be known. Such an assumption is of course a far-reaching one, and its satisfaction is increasingly hindered by the exploding scope of systems involved.

Progressing concentration, shift from multilocal to multinational economies (supranational corporations, international specialization and cooperation), from the domination of interregional to international trade relations, all these phenomena necessitate consideration of a system external to the regional one with quite a high degree of accuracy, and consideration of a broader set of values. Thus, the system, which seemed to be fairly closed and constant, and value-wise homogeneous may turn out to be highly sensitive both to internal controls and to external conditions.

Another argument in favor of the less-rigid intermodel linkage methodologies based upon the recognition of the existence of a number of well developed models sufficiently adequately reflecting portions of socioeconomic reality, which however, may not as yet be integrable with others (for example, with regard to illustration of Figure 5, those related to denumeric approach Willekens and Rogers 1977).

### 3.3. Some Economic and Institutional Issues

Hence, of the assumptions previously listed many are essentially dependent upon a specific situation. This especially applies to interinstitutional issues. In many cases the regional system affected by the program is by no means uniquely defined, and even if so, it may not correspond to any administrative unit vested with some definite powers. A task for itself therefore emerges of determining the program's area, both in economic and in geographical spaces, and/or of determining the appropriate managerial changes. In the first approach this would take on a normative form of "optimal solutions," if in reality such solutions were feasible (which for the most part they are not). In the other approach mentioned, the interinstitutional or interparticipant dimension is the crucial point. Not because an attempt is to be made at explicit solution but because it is considered that the major complexity-generating aspect of the problem which may render it formally intractable, may at the same time be the real solution forum. Hence, such questions as program area definition, coordination etc., are responded to implicitly by providing tools of rationalization for participants of the process, who, using models, may finally communicate and create conditions for agreement over specific issues (even if this agreement might not be classified "optimal" from an *a priori* standpoint). Furthermore, this approach would not yield specification of desired changes in the structure of the managing system, but would, through creation of a multifaceted model system, constitute itself a "substitute" for socially expensive administrative restructurations. In order to anyhow effectively constitute such a quasi substitute, i.e., to perform rationalizing, informative and communicative functions, this approach has to include redundancy and be adequately software- and hardware-backed. The orgware will, hopefully, follow. This is of special importance since coordination wholly at the local level, seldom aimed at, is practically unattainable.

It is generally postulated that the growth trajectory generated should be in some sense "harmonious." The first approach does satisfy this requirement via maximum (consistent with optimal) deployment of local resources and activities and via breakdown of goals into subgoals and tasks in conformity with predetermined norms and standard relations on social and environmental aspects of development. This assures that the dominative growth is least usable and most efficient. When multiplicity of values and unreliability of efficiency parameters is admitted, this dominative growth may by its very nature be considered inconsistent with the one called harmonious. Whether consistency assumptions can in specific cases be made should be always carefully investigated.

Thus, a "loose" concept of the role of models also has its feasibility rationale. This rationale is illustrated in Figure 6, according to redundant model system creation ideas presented in [6]. The system would be an information carrier for developmental integration. It will serve each participant to elucidate goals, alternatives to his own behavior, the potential position of others, and the cooperation gains. Figure 7 presents those processes that should be internalized in the model system for it to be capable of performing the above functions. This set of functions could, for example, be carried out with the help of a set of models classified in Figure 8 (classification put together for the two cases of regional development undertakings studied at IIASA—the Tennessee Valley Authority, USA, and the Bratsk-Ilimsk Territorial Production Complex, USSR, with their differing approaches to modeling and model use as correlated with the socioeconomic conditions and management precepts).

#### 4. APPLICATION TO THE KINKI REGION

Having, albeit somewhat shortly, presented distinctive features of the two possible approaches to modeling and thereby also the concepts of roles to be played by models in integrated regional development planning, let us give insight into conditions which, for a given regional development program case, define applicability of the two approaches/concepts.

When one looks at the spectrum of modeling represented within the project team led by Professor Y. Swaragi, one can easily see that elements of both approaches' concepts are comprised there.

The largest single model undertaken, referred to as IRDPM, has an obviously normative character and is based upon programming precepts. It has a hierarchical structure (long-term national growth, allocation and regional development) and is ultimately decomposable into submodels oriented to individual activities (energy, land use, environment, etc.). Thus, it follows the first line of thought presented here and, considering its importance within the modeling project, has certainly nonnegligible influence upon the way of thinking dominating the project. In general, however, in view of the variety of paradigms and methodologies, and of ways in which problems are conceived, it

Participants: institutions, groups, ...

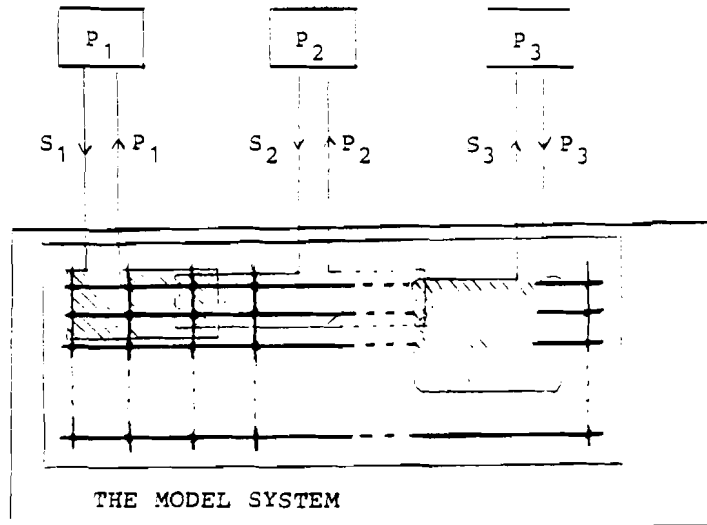

$S_i \downarrow$  : scenarios                       $\uparrow P_i$  : projections, optimal solutions

/// \\\: model system areas activated by requests

Attention: no consistency needs to be assumed of  $P_i(S_j)$ ,  
 $i \neq j$ , with  $P_i(S_i)$ .

Figure 6. Illustration for functioning of the second approach.

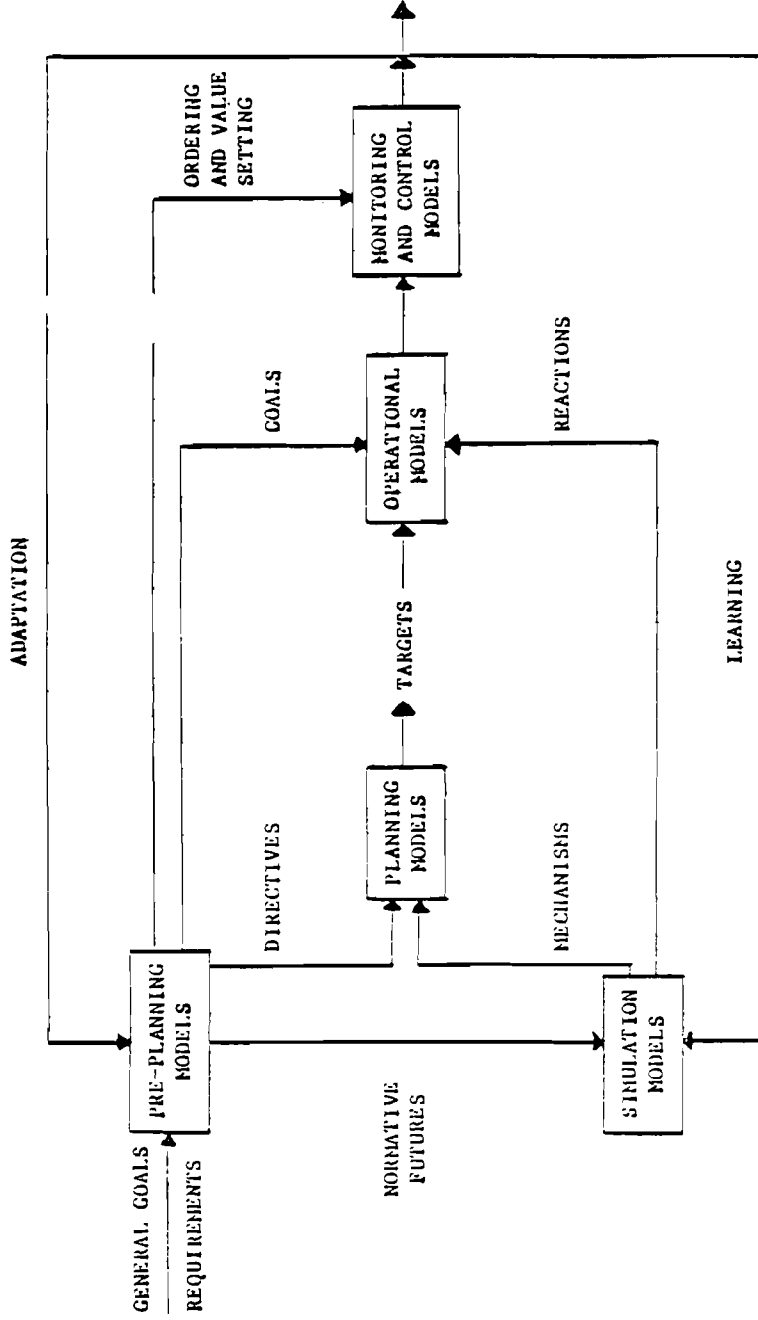

Figure 7. Model types and use in a functional setting.

Source: [5].

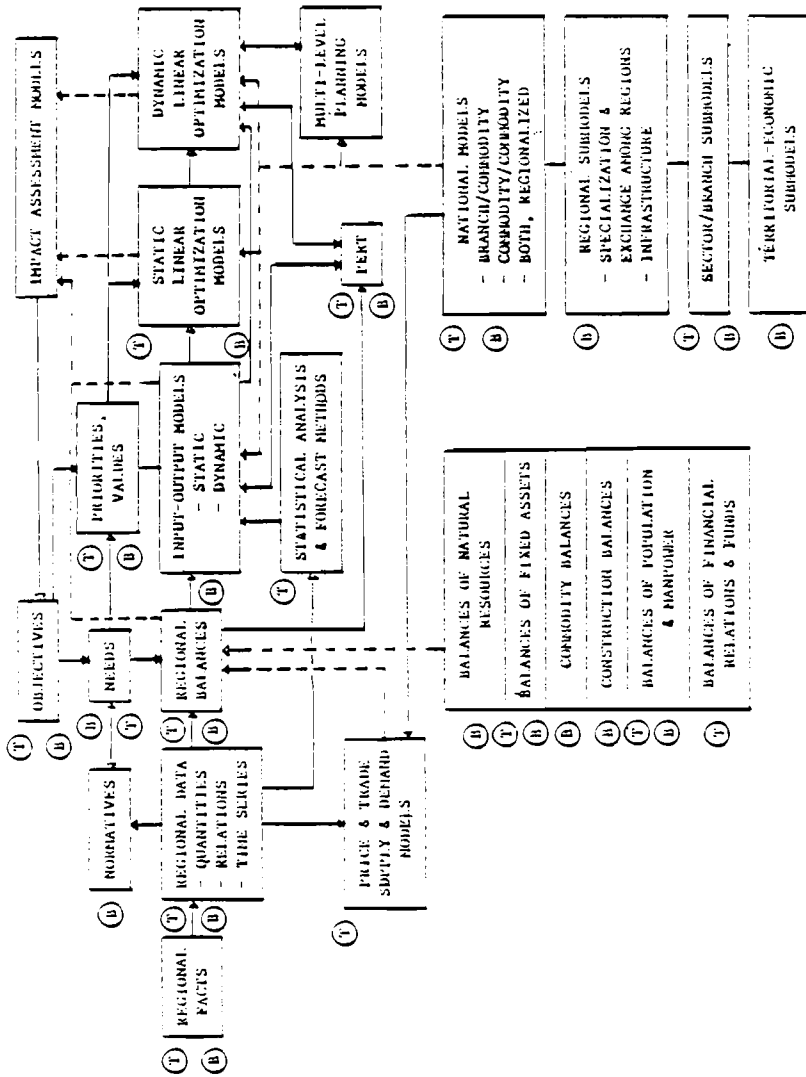

Figure 8. Possible sets of models and data available in the Tennessee Valley Authority System (T) and the Bratsk-Ilimsk Territorial Production Complex System (B).

Source: [3].

can be inferred that the overall picture this Kinki modeling project presents is nearer to the second approach/concept presented. In the rest of this section we shall briefly overview potential justification for (or counter-indications to) adoption of this line of modeling in the case of the Kinki problématique and institutional situation.

Let us come back again to the six assumptions previously listed as being important for the determination of an approach adequate to a given situation:

- The first assumption, seemingly *a fortiori* satisfied, should be in this particular case, if admitted at all, complemented with a provision for prevalence of Kanto and latent economies of its hinterlands, so that Kinki might end up as a tertiary activity and "special care" area rather than a growth pole.
- The second assumption applies in the case of Kinki to (mainly international) specialization, since all possible regional-type activities are largely closed within this area; specialization is subject to forced rapid shifts, not (or to a lesser degree) by the internal Japanese economic situation, so much as by changes in the international trade conditions.
- The prefectural governments within the Kinki region do, in some cases heavily, rely on national financing and supply; major projects, like Kansai International Airport, will have to be mainly nationally funded; it is, however, by no means obvious that this is a *sine qua non* condition for integrated Kinki development in a situation of a well established economy and multiple local interests and drives.
- The fourth assumption is inapplicable to Japan as a whole, and to Kinki in particular; the national plans have until now been treated not in any way normative, but indicative, i.e., coupled with government expenditures and indirect influencing of business; the same holds for prefectures, with, additionally, less resources in the hands of prefectural governments and more likely less cooperation with nonlocal businesses; on the top of that Kinki is a fuzzily defined amalgamate of several prefectures, with no administrative power but rather traditional statistical, and long-term planning significance.
- As mentioned above there cannot be any well structured managing system for Kinki, unless important changes are made in the administrative mechanism of Japan; there are some coordinating bodies devoted to narrowly specified sectoral questions and also regional (Kinki) bureaus of some ministries (MOC, MOT, MITI), but these are not vested with policy functions nor with broader management prerogatives; this is very closely related to the fact that the goal structure is hard to identify, although it can be in general said that the objectives pertain to harmonious and just development and utilization of environmental resources, such as water, land, and air, but to human resources as well.



- The very nature of the problématique, as stated, related to environmental resources in a very densely populated and highly productive area makes the scale and agglomeration of economies a crucial, and at the same time, very intricate question in itself.

For a more detailed analysis of some of the above issues see S. Ikeda, J.W. Owsinski, and D.V. Winterfeldt, *Planning, Modeling, and Environmental Decision-Making—Case Study of the Kinki Region in Japan* (this volume).

These considerations point out that there may be some rationale of assignment to models in Kinki the roles that are proposed by the second approach, even if some aspects of the situation (for example, the optimal resource utilization problem) indicate usefulness of the more strict formulation (for an example of the potential model structure incorporating elements of both approaches applicable to the Kinki problématique, see Figure 9. The structure is composed of levels corresponding to geographic and administrative reach, problem-oriented models, and decision-making function-oriented models.) This, again, although desirable from many points of view, resuscitates the problem of values and the interinstitutional value communication.

Considerations comprised here constitute an extension for understanding the role of models, as specified in a straightforward manner at the beginning of the paper. They turn out to be more than computational devices—sort of magnified slide-rules—and their encroachment into policy and operational decision making spheres is quite important.

Thus, two distinct types of roles can be played by models devised for use in integrated regional development. Certainly, any model can simultaneously play both of these roles. In most cases, however, the question of choice arises, related to features of the situation and modeling capacities. It is important therefore to adequately assess the ultimate benefit the participants of the development process can get from presence and use of the models.

#### REFERENCES

- [1] Owsinski, J.W., and D.V. Winterfeldt (1976) Models and Decision-Making in Integrated Regional Development. In, IIASA Conference '76 Vol. 2:135-150. Laxenburg, Austria: International Institute for Applied Systems Analysis.
- [2] Albegov, M.M., and J.W.Owsinski (1979) The Shinkansen and the regional issues In, Shinkansen Case Study Report, edited by A. Straszak. CP-79- . Laxenburg, Austria: International Institute for Applied Systems Analysis.
- [3] Straszak, A. (1978) A Multi-factor approach to large-scale development Programs. In, Systems Analysis Applications to Complex Programs, edited by K. Cichocki and A. Straszak. IFAC-Pergamon Press.

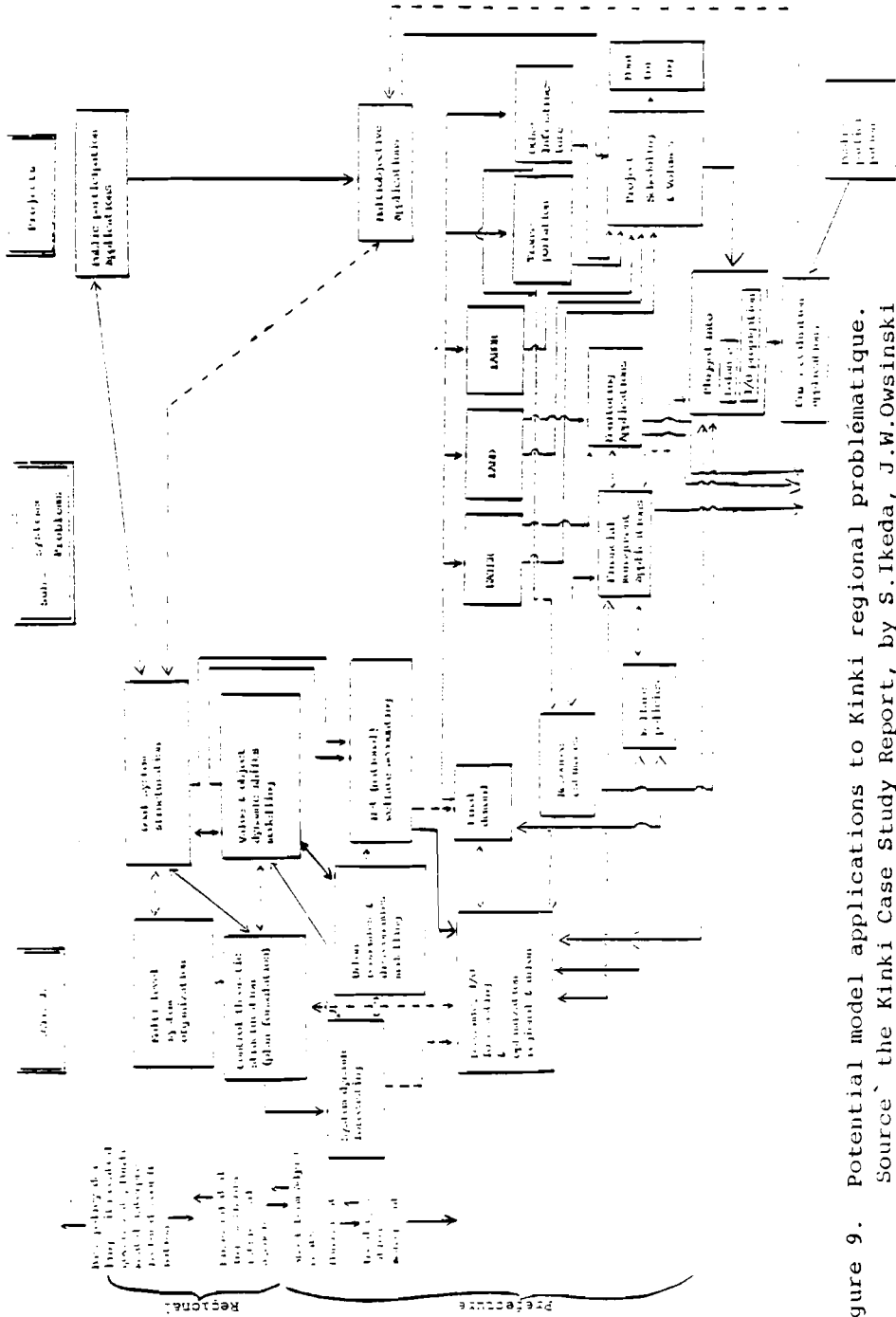

Figure 9. Potential model applications to Kinki regional problematique. Source: the Kinki Case Study Report, by S. Ikeda, J.W.Owsinski and D.V.Winterfeld (this volume).

- [4] Owsinski, J.W. (1978) Assessment of inter-institutional use of models in a large scale development problem. In, Systems Analysis Applications to Complex Programs, edited by K. Cichocki and A. Straszak. IFAC-Pergamon Press.
- [5] Straszak, A., and J.W. Owsinski (1978) A regional planning model system: organization—structure and dynamics. In, Models for Regional Planning and Policy-Making. Proceedings of the joint IBM/IIASA conference, edited by A. Straszak and B.V. Wagle. IBM UK Scientific Center 0097.
- [6] Straszak, A., and J.W. Owsinski (1977) Systems analysis approach to integrative organization, planning, and management for the development of the region. In, Proceedings of the 3rd Italian-Polish Conference on Applications of Systems Theory to Economy, Management, and Technology, edited by J. Gutenbaum. Warsaw: SRI-PAS.
- [7] Albegov, M.M. (1977) Possible Approach to the Sequence of IRD Problem Analysis. Paper presented at the Task Force Meeting on Integrated Regional Development, April 19-21, 1977. Laxenburg, Austria: International Institute for Applied Systems Analysis.
- [8] Albegov, M.M. (1978) Generalized Regional Agriculture Model (GRAM). Laxenburg, Austria: International Institute for Applied Systems Analysis.
- [9] Kulikowski, R., and P. Korcelli (1976) On Modeling and Planning of Optimum Long-Range Regional Development. WP-76-4. Laxenburg, Austria: International Institute for Applied Systems Analysis.
- [10] Albegov, M.M., and V. Chernyatiu (1978) Water supply in regional model systems. In, Notec Regional Development. Proceedings of Task Force Meeting II, edited by M.M. Albegov and R. Kulikowski. Warsaw: SRI-PAS.
- [11] Gouevsky, I., D. Maidment, and W. Sikorski (1977) An Agricultural LP Model for the Silistra Region in Bulgaria. Laxenburg, Austria: International Institute for Applied Systems Analysis.
- [12] Albegov, M., and R. Kulikowski (eds.) (1978) Notec Regional Development. Proceedings of Task Force Meeting I. RM-78-40. Laxenburg, Austria: International Institute for Applied Systems Analysis.
- [13] Albegov, M., and R. Kulikowski (eds.) (1978) Notec Regional Development. Proceedings of Task Force Meeting II. Warsaw: SRI-PAS.
- [14] Willekens, F., and A. Rogers (1977) Normative Modeling in Demo-Economics. RR-77-23. Laxenburg, Austria: International Institute for Applied Systems Analysis.

A FRAMEWORK FOR EVALUATING REGIONAL PROGRAM  
ORGANIZATION AND POLICY FORMULATION

R. Ostrowski  
*Systems Research Institute, Warsaw, Poland*

A. Straszak  
*International Institute for Applied Systems  
Analysis, Laxenburg, Austria*

1. INTRODUCTION

Interest in regional development has grown very rapidly in recent years—both among "hard," "soft," and "org" sciences, as well as among decision makers, policy analysts, and planners throughout the world. Seeking solutions to problems in this area one must take into account technological, political, economic, social, and environmental factors. Regional science and spatial economics, which have had powerful influence on the theoretical, methodological, and analytical approaches to regional development issues for many years, seem to be too narrow for finding the comprehensive and integrative solutions of regional problems. More multidisciplinary research is therefore necessary. Because of international interest in this subject, the IIASA Management and Technology Area launched a series of studies of worldwide large-scale development programs: the Tennessee Valley Authority (TVA) study in the United States [1], the Bratsk-Ilimsk Territorial Production Complex (BITPC) in the Soviet Union [2], the Shinkansen Program in Japan. The first two are large-scale regional development programs based on the utilization of water and energy to attract industry; the third case was one of large-scale interregional development programs based on the utilization of a new technology to distribute industry through the entire country.

Not all the regions utilize their resources in an optimal or even satisfactory way, so that some programs are needed to better utilize human, natural, and technological resources in the regional setting (see [2] or [3, 4]). A region, regardless of its size, is a complex socioeconomic system. Understanding the

socioeconomic processes on the regional level brings about a better understanding of national and international problems.

Many leading regional scientists and systems analysts, such as Professors Aganbegyan (see [5]) and Isard (see [6]), have called for the application of systems analysis for solving regional problems.

How can the systems analysis be used for the regional development? From the management point of view, there are at least three directions:

- What is to be decided? What are the goals, strategies and decisions?
- Who decides? What organizations are involved?
- How are the decisions rationalized? To what extent can the calculations and models be used for decision-making?

All regions may be characterized by complex situations, inter-organizational problems, complex interrelations, etc. IIASA was interested in how decisions should be rationalized, how one can use calculations, models, etc., for better decision making in these situations. However, the program organization and policy formulation for regional development should also be a high-priority subject of systems analysis.

The Kinki Integrated Regional Development Project launched four years ago in Japan and carried out by a team of scientists from Kyoto and Osaka Universities led by Professor Y. Sawaragi [7], could be considered as a preprogram stage of the future Program of Integrated Development of the Kinki region, and the methodology developed and the findings of IIASA case studies have a high applicability potential for this case. This is particularly true, because the IIASA's large-scale development programs case studies initiated integrated regional development (IRD) as a new concept.

## 2. REGION AS AN OBJECT OF SYSTEMS ANALYSIS

The increasing importance of regional problem analysis results from developments in production means (growth of volume and speed of performance), transportation and communication, increases in the geographic density of economic activities, and from the specialization of these activities, as well as new perceptions of the development of constraints, limits and impacts. That is, it results from changes in the socioeconomic system's configuration and functioning in its physical structural aspect. In Figure 1 a framework analyzing the regional problems is shown.

The formal coupling of both socioeconomic and geographical aspects may occur in many formal and heuristic ways (see [8, 9] or [10]). The coupling, however, must occur between defined entities. That is, the socioeconomic entities (sectors) and geographical units (regions) have to be defined. Ideally, one would have an ultimate atomization of both spaces (quasicontinuity) and on the basis of such maximal disaggregation define

THE SOCIO-ECONOMIC SYSTEM

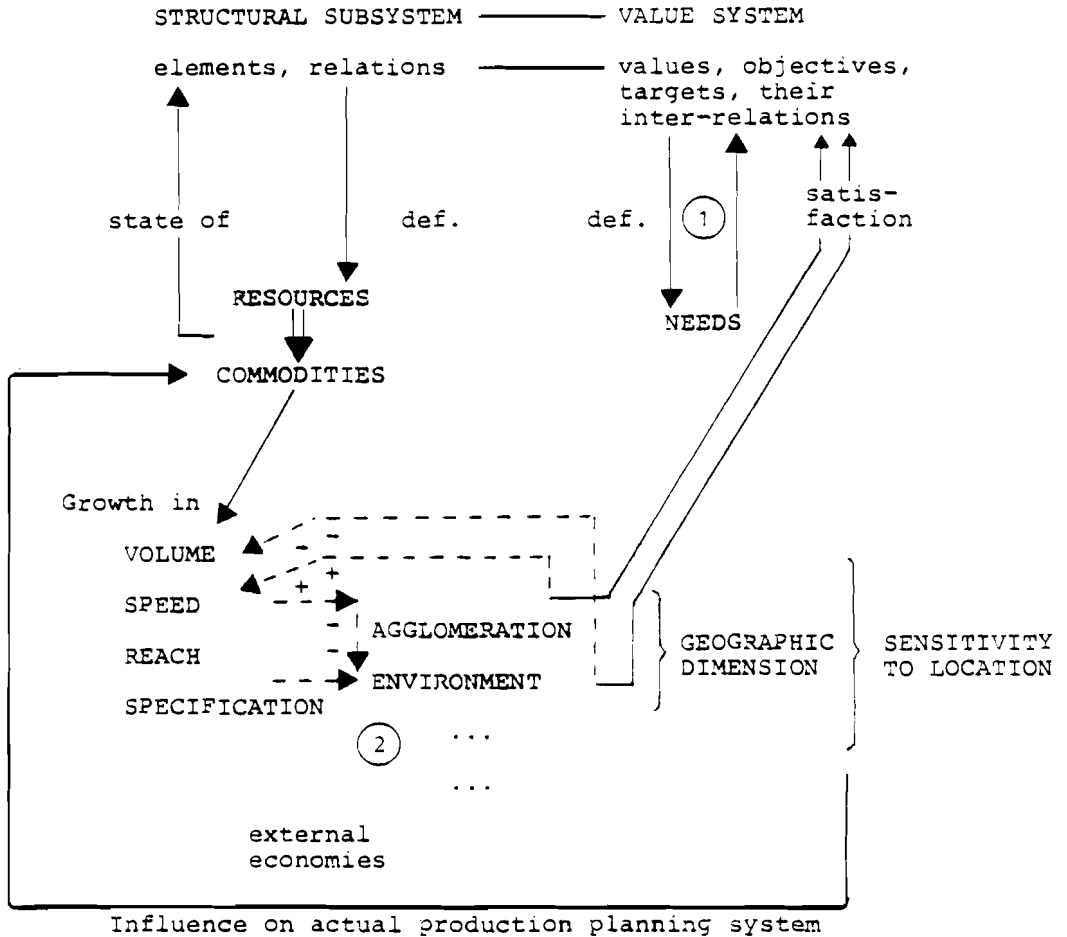

- (1) The needs defined as basic economic ones may tend to be better satisfied than other less tangible needs.
- (2) Minus reflects the stage of progressing deterioration; it may turn to plus if enough production effort is oriented to environmental enhancement.

Figure 1. Framework for analyzing regional problems.

Source: [8].

entities that are optimal for certain systemic purposes in a given situation. Since the implementation of such an ideal case is not possible, the procedure occurring within the administrative and planning structure takes on an iterative form. The problem arises of terminating the procedure before the situation (structure and purposes) can change. Such a procedure would usually start from an existing breakdown, both sectorial (ministries, departments) and in regional (local governments, their powers) dimensions. This initial setting is essential for further considerations for three reasons:

- It defines the actual power interplay through which current policies are implemented.
- It defines data used for development planning.
- There is a very high cost incurred for altering the structure.

Different relations between various hierarchies, especially with regard to the initial political-administrative ones, may be illustrated by the fact that a region can end up as a definite administrative unit, vested with the appropriate power, or as an abstract entity used for planning/programming purposes. In assessing the situation, a number of hierarchies have to be taken into account through which the regions may be defined.

The region emerges as an element of the national system comprising definite subsectorial entities. Sectorial elements of the region as a system are at the same time the elements of a sectorial system [9, 11]. This duality imposes the first task within the coordination problem. The second task is concerned with interregional relations. Both tasks are nontrivial, and may have internal and/or imposed objectives. To illustrate possible causes that may make the regional problems emerge let us cite [12]:

- (A) Differences in the development level.
- (B) Difference in the natural endowment (including environmental limits).

These refer to the state of the object system. The way in which regional differences will be handled depends on the perspective from which they are perceived. These are as follows:

- (a) National investment allocation perspective (national objective as a criterion of optimality, efficiency—sectorial criterion—maximization).
- (b) Distribution of wealth and growth perspective (balanced growth or equity objectives).\*
- (c) Local development perspective (local objectives within the framework of national ones).

---

\*This distinction does not mean perpetuation of the "Equity versus Efficiency" controversy (see, e.g., [12]). The "E versus E" problem may be easily solved if it is seen as being related to the difference in time horizons; equity is expressed in rational, people-oriented terms, or nonlinearity (limits) of efficiency is considered.

Mechanisms exist for monitoring (A) and (B) for continuous regulation coordinating (a), (b), or (c). In such routine proceedings neither the regionalization nor the coordination problems are solved [9]. If, however, creeping divergences from routine situations (including investment constraints) or sudden exogenous disturbances make it impossible for established mechanisms to react properly, then either important structural changes have to be introduced into the solutions or entirely new solutions have to be found. The lower levels, not being able to cope with the problem, project it into the higher ones, or the higher ones, recognizing the scope of the problem, find it necessary to induce changes in their relations with lower level elements or interrelations on the lower level. The whole structure gets involved. One can imagine that new (updated) solutions are being worked out continuously and implemented only when losses incurred by sticking to the old mechanism surpass the implementation cost. Such a solution process would have the form of an iterative procedure working in a loop between the element definition and coordination. Appropriate element definition, based upon actual administrative structures and socioeconomic/geographic characteristics, will show the way of future evolution for the administrative structure and will facilitate the task of coordination. (This is the way that certain limitations inherent to uniquely sectorial economies, may be overcome, see also [13, 14, 15]. In the coordination some relations between the elements may be established that would influence the element definitions.

The outlined solution procedure involves a multilevel, multi-hierarchical system structure so that the structure may undergo essential changes. In relation to both element definition and coordination two processes are vital for the solution determination: aggregation and decomposition. They reflect the approach to solution finding in the sense of establishment of relations between the elements (bottom to top and top to bottom, respectively). At the same time, they may constitute the mechanisms of problem definition.

We can see a problem liable to renewal or to activation of a solution process emerging whenever changes in features of the system (A,B) or its potential (investment capacity), or, on the other hand, in its objectives (a,b,c) occur. This is where our main interest lies. The solution procedure that we are discussing is meant in a structural sense, i.e., it leads ultimately to modifications in the organization of an algorithm of the actual managerial solution definition. It operates on the policy making, and planning structure (algorithm) level [16], and not only on the actual object system's questions. Usually, the changes mentioned are treated as localized ones so as to prolong the time periods between a more sound restructuring of the system. This often leads to the temporary implementation of programs or projects as the modifications of existing, routine mechanisms are just propagated in the usual way.

As a result of the phenomena mentioned in the first section of this paper, changes in the region system make it necessary to look for new solutions, both in the structure of the socioeconomic object system, and in the structure of the on-going solution-seeking algorithm for an optimization approach, see [17]. The



determination and implementation of new solutions are complex processes because of a considerable inertia with regard to external manipulations (or they may even change opposing attitudes) and autonomous internal dynamics of regions. They are connected with and strengthen the long-term character of region (spatial) changes. This poses important questions as to the reliability of regional projections and plans compared with the sectorial ones. Furthermore, one must also consider the stability, resilience and robustness of the regional system, especially with regard to possible policies to be undertaken and also the socio-economic system with regard to possible regional developments. In the conditions of extreme complexity it often means that alternative scenarios, whose performances are then evaluated, are constructed rather than a direct "continuous" modeling of policy space which involves a greater search procedure [18].

The solution procedure should lead to the construction of a system that would satisfy certain requirements formulated as to its performance. Besides these specific requirements, expressed as objective functions, preference orderings, indifference curves or satisfaction limits [19], one can propose some general systemic criteria or properties. We shall cite two: *comprehensiveness* and *integration* as derived, for example, from [20]. The system, and in particular the installed solution algorithm, should comprise or account for all the essential elements and aspects. These should then be interlinked so that they are contained by the system and also form it, and are then necessary for a mere "inclusion" (comprehension) to the integration is parallel to the passage from qualitative considerations in the system's perception. Obviously, the object system is both comprehensive and integrating, if taken broadly enough, so that the problem lies mainly in its perception, analysis, and redesign: i.e., in the solution procedure.

### 3. DEVELOPMENT PROGRAM EVALUATION AND ASSESSMENT

The implementation of the development program due to its interinstitutional character and a strong interaction with the political, social, economic, as well as physical, environments comes under different pressures and disturbances which make program changes necessary. Therefore, it is useful and sometimes necessary to evaluate the program in order to assess how successful the program has been.

A periodic evaluation of development programs may play an important role in the improvement of effectiveness of the programs. The evaluation of the development programs should also be included more and more in the analytic framework.

The evaluation of programs could be considered as a feedback mechanism, which could include the identification of program goals, evaluation criteria and clientele groups or actors [21]. The concept of clientele groups or actors should be constructed broadly to include not only those who are ultimately affected by a particular program, but also those who create and develop it [20, 22].

The evaluation analysis requires a consideration of convergent and divergent interests, cooperative and competitive actions, values, and motives, categorization of actors, relationship or linkage among actors, information basis, adequacy of information basis, relevance and accessibility of actors, types of decisions and their consequences, and the issues or problems that emerge.

The sequence of this analytic framework is shown in Figure 2. The evaluation process should also include several comparisons:

- Comprison of program before versus after.
- Time trend projection of preprogram data versus actual program data.
- Comparisons with system's segments not served by the program.
- Comparisons of planned versus actual performance.

The evaluation of the development program could improve the effectiveness of a particular program but also be a good source of overall program management experience.

Important sources of knowledge on the development program experiences could be obtained through the issue response analysis (see Figure 3). The evaluation is therefore based mainly on an analysis of a societal process that leads to the definition three modes: debate, policy generation, and decision making. The development program, defined by the societal process going through the above three modes, finally shapes the eco-techno-economic system, which is the object of the program's performance.

Analysis of interrelations between issues, actors, and program phases gives us an opportunity to specify the main advantages and disadvantages of the program, the main advocates and opponents as well as the possible future of the program. The important part of the program analysis is that it is also surveying the application of models, computers and systems analysis for each subsystem as well as for the whole program.

The Kinki Integrated Regional Development should interact with the national economy system, prefectural systems, demographic system, regional economic activity systems, transportation system, water system, and environmental system as shown in Figure 4. To see the problems of Kinki IRDP in an appropriate perspective, the main issues and their changes are summarized in Table 1. The issue areas are: national, general, regional, transportation, environmental, and related to Kinki itself. For each area the issue changes over time, i.e., as appearing in the three consecutive comprehensive development plans (1961-1969, 1969-1977, 1977- ), are presented. One should remark that the issue changes depend strongly on the change of regionally-oriented national comprehensive development plans. The main outlines of the second comprehensive development plan is shown in Exhibits 1 and 2, and the main elements of the third comprehensive development plan is given in Exhibit 3. A more detailed outline of the third comprehensive development plan, partitioned into main goals and areas of interest as well as scope of competency of appropriate governments (national, prefectural, and local) is shown in Figure 5.

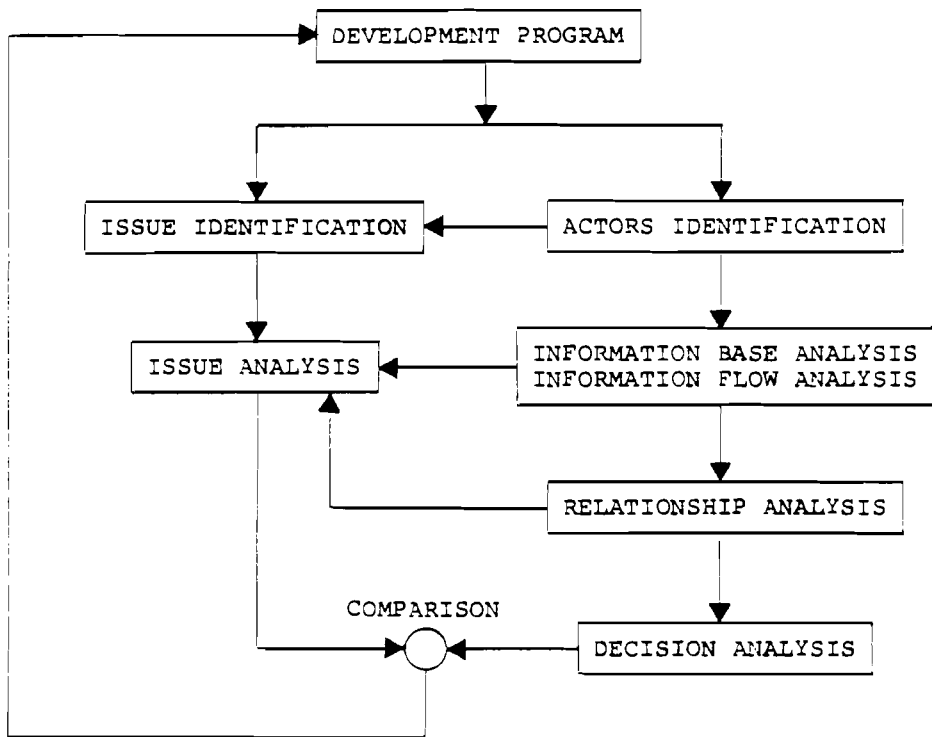

Figure 2. Analytic framework for evaluation process.

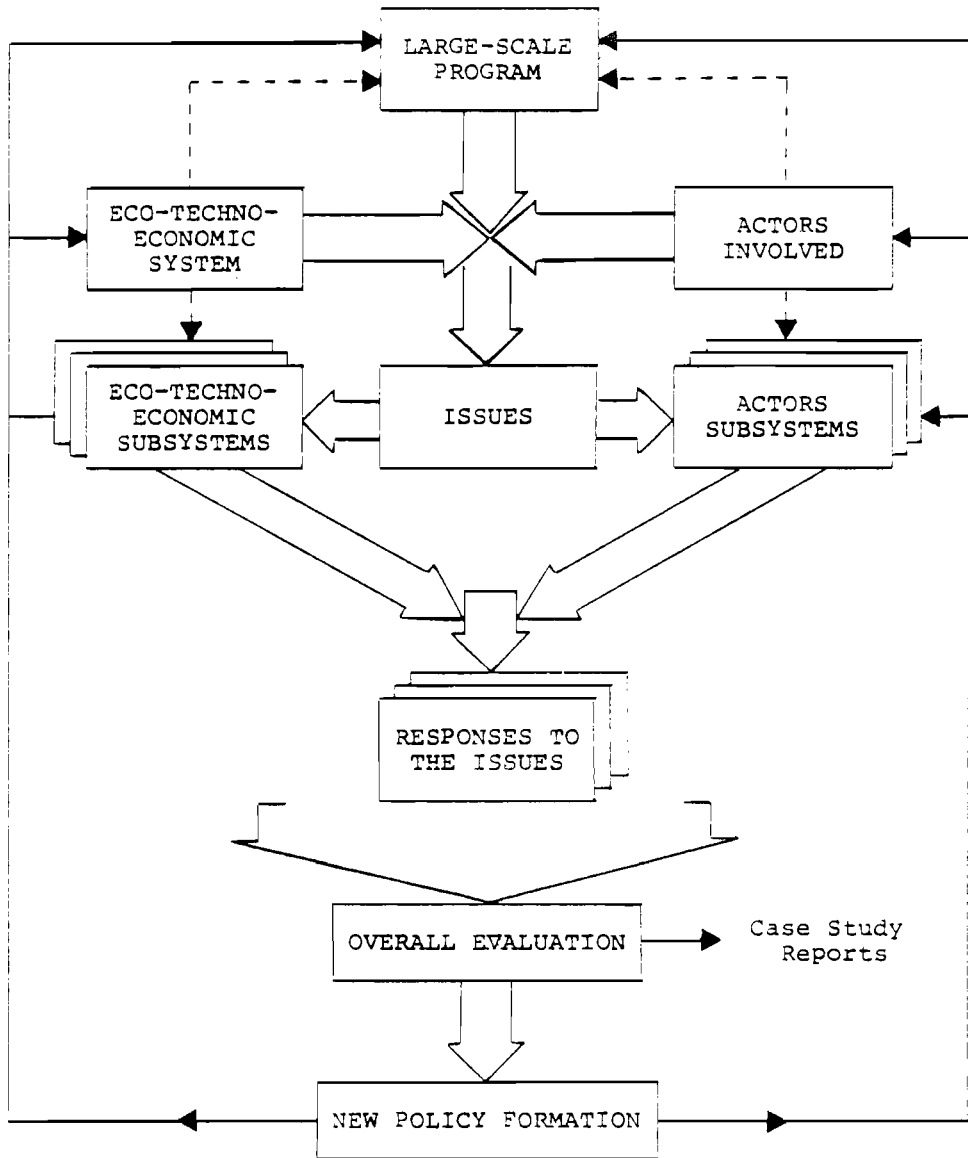

Figure 3. Framework of systems analysis of large-scale program.

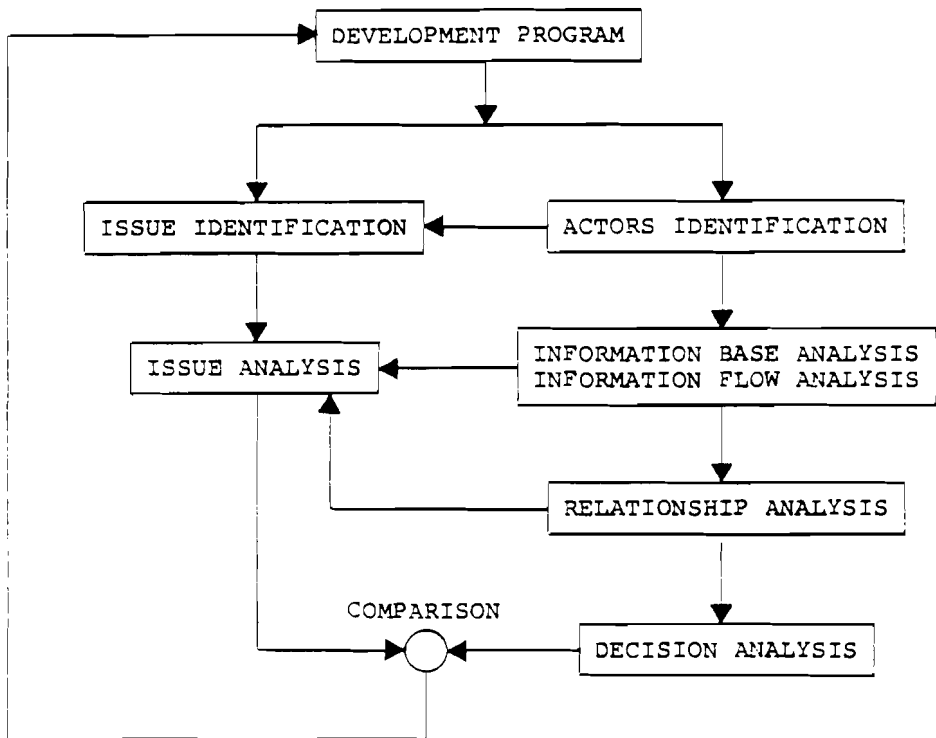

Figure 2. Analytic framework for evaluation process.

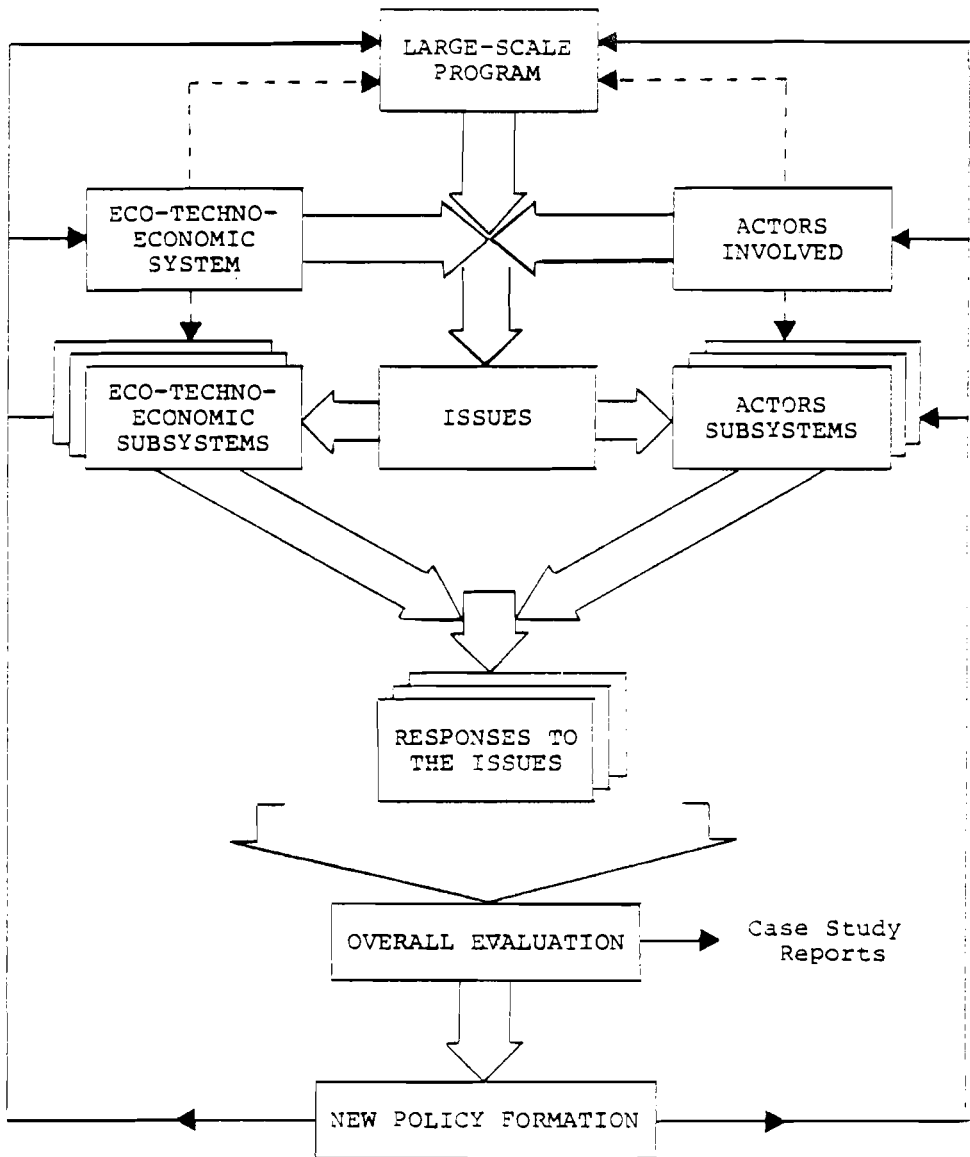

Figure 3. Framework of systems analysis of large-scale program.

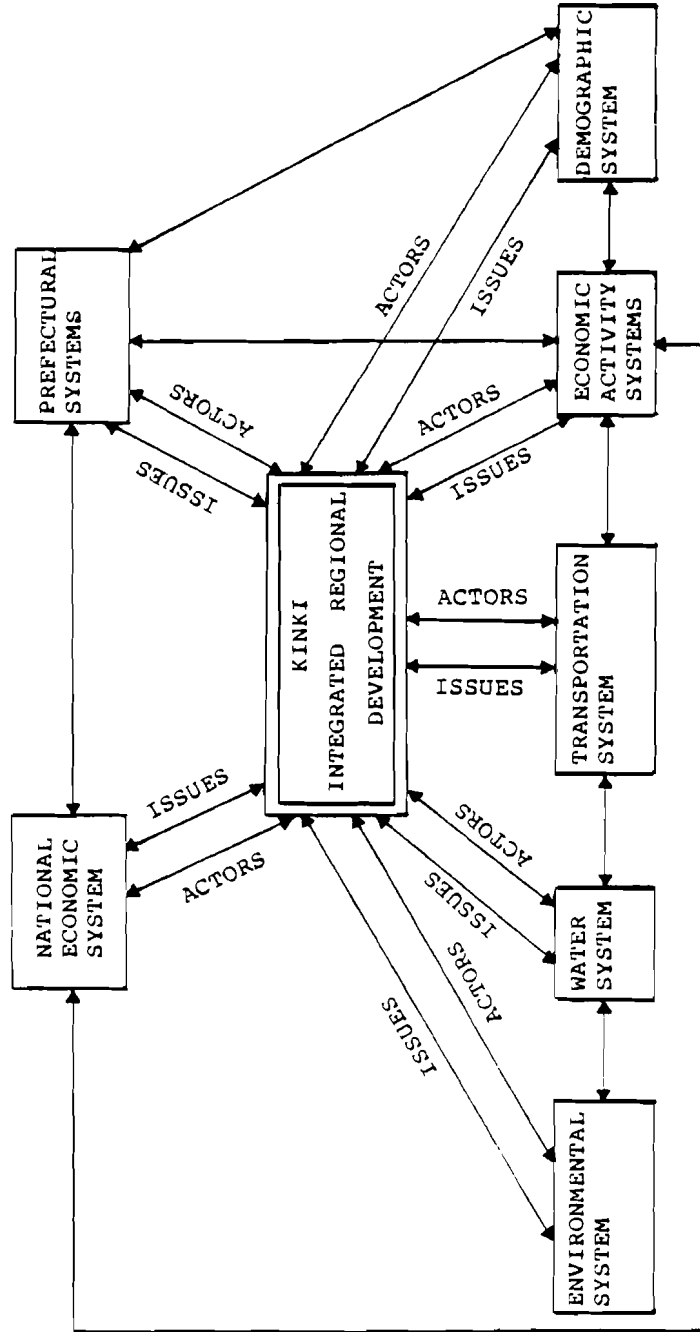

Figure 4. Kinki integrated regional development and its subsystem interactions.

Table 1. Issue changes over time.

Issue Area	Period	1st Comprehensive Development Plan 1961-1969	2nd Comprehensive Development Plan 1969-1977	3rd Comprehensive Development Plan 1977-
National	Nonexistent		Spreading of economies Restructuration/transi- tion in activities Investments	Broadening of values and response spectra
General Regional	Recognition of dispari- ties Income Redistribution Social Overhead Capital Redistribution Industry Concentration Control		Need for activation of peripheral regions Inter- and intraregional Accessibility	Self-promoted and sus- tained growth of regions Rational national/ regional relation structure
"Transportation	Integration of Transpor- tation System or Inde- pendent Growth Parallel Highway/ Shinkansen Development		Rapid Growth of Car Transportation and In- dustry. Congestion. Pollution Plans for "Shinkansenization" of Japan	Control and Rational- ization of "Transporta- tion System's Develop- ment Integrated Traffic Policy
Environmental	Appearance of the Environmental Problem Complaints		Organization of Control Measures Standard Setting (1972) Monitoring Procedures and Techniques	Broader View of Impacts and Procedures Impact Assessment Public Participation
Kinki↓ .....	Urban Congestion Scarcity of Resources		Water Resources Widening gap to Tokyo	Comprehensive Regional Activity-Infrastructure Environment Policies
Kinki↑			Internal Disparities Pollution	



THE SECOND COMPREHENSIVE DEVELOPMENT PLAN:

→ "LARGE SCALE DEVELOPMENT PROJECTS AS METHODOLOGY" →

→ "DEVELOPING AND IMPROVING A NATIONWIDE NETWORK" →

("VOLUNTARY AND EFFICIENT PROJECTS")

→ "BIG PROGRESS OF REGIONS",

"BALANCED UTILIZATION OF NATIONAL LAND",

"DEVELOPMENT AND IMPROVEMENT OF LIVING ZONE".

"DUE TO DELAY IN DEVELOPMENT AND IMPROVEMENT

OF NEW LIVING ZONE IT WAS NOT POSSIBLE TO

ACHIEVE THE OBJECTIVES OF THE PLAN"

THE SECOND COMPREHENSIVE DEVELOPMENT PLAN

SPREAD OF INNOVATION AND OF AGGLOMERATION ECONOMIES

THROUGH INTEGRATING EFFECTS OF

SPACE-DISTRIBUTED INFRASTRUCTURAL AND OTHER PROJECTS AND CONTROLS

92

(TRANSPORTATION, COMMUNICATION, WATER AND ENERGY

SYSTEMS, LOCATION AND URBANIZATION CONTROL)

ORIENTED AT SATISFACTION OF UNIVERSAL NEEDS

THROUGH PROVISION AND DISTRIBUTION OF ALL NECESSARY SOCIO-ECONOMIC FUNCTIONS

THE THIRD COMPREHENSIVE DEVELOPMENT PLAN:

"THE HUMAN HABITATION SCHEME

TEIJU - KOSO" →

→ "COMPREHENSIVE ENVIRONMENT FOR HUMAN LIVING":

"DECONCENTRATION OF POPULATION AND INDUSTRIES",

"BALANCED UTILIZATION OF NATIONAL LAND"

"STABILITY OF LIVING"

"PRIORITY SHOULD BE GIVEN TO LOCAL CITIES"

"REGIONS SHOULD MAKE THEIR OWN SELECTIONS

AND DECISIONS TO MAKE THE BEST USE OF REGIONAL CHARACTERISTICS"

BUT "THERE IS A LIMITATION IN MAKING A SUFFICIENT ADJUSTMENT

IN ADVANCE AT THE TIME OF MAKING OF THIS PLAN"

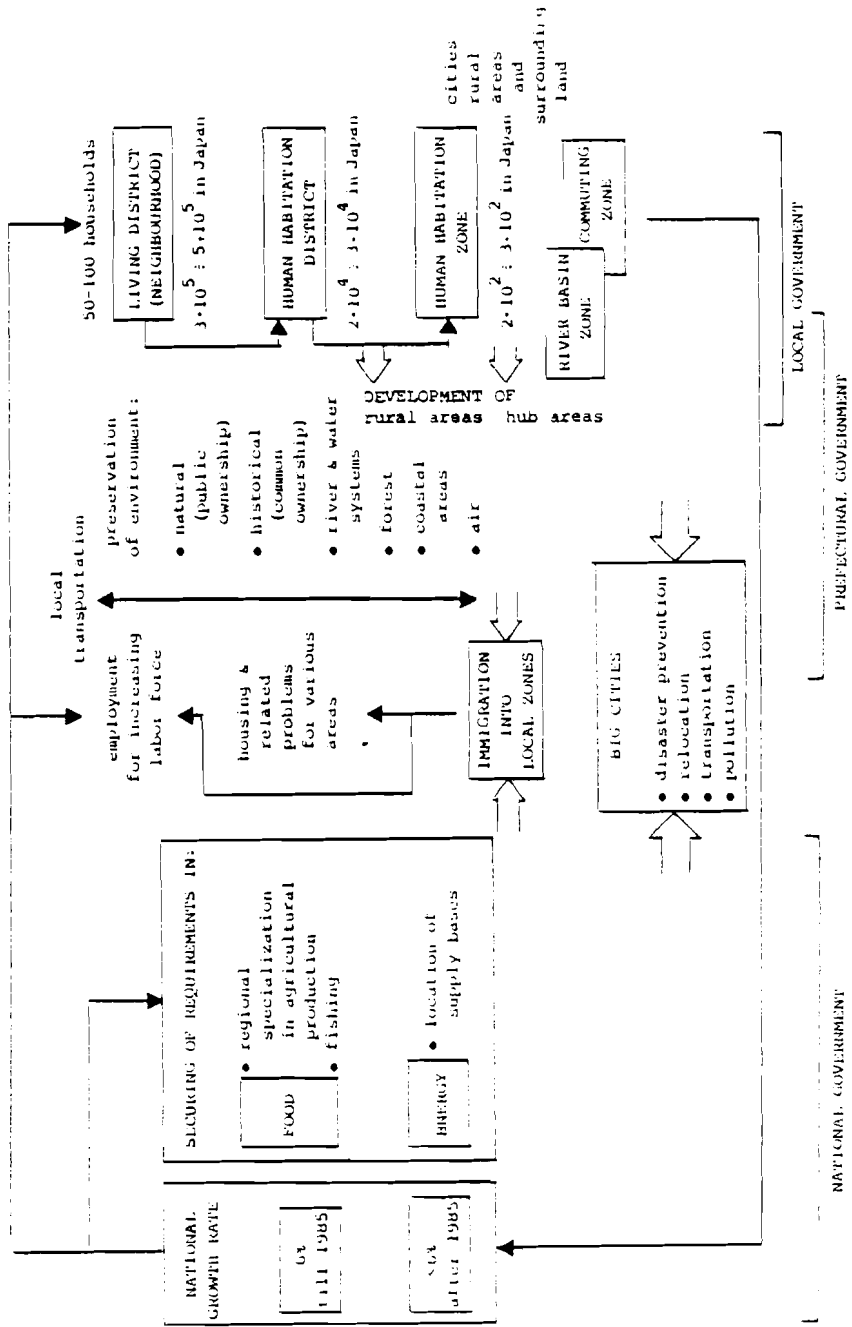

Figure 5. An outline for the 3rd Comprehensive Development Plan Rationale.

It may be interesting to compare the basic conceptual differences between the second and third comprehensive development plan. It is sketched in Figure 6. The changes of comprehensive plans as outlined above must necessarily cause changes of policies over time. This is shown in Table 2 for each issue area, i.e., national, general regional, transportation, environmental, and related to Kinki itself. As may be seen, these policies evolve from pure growth-oriented ones to more conscious human- and quality-of-life-oriented ones.

The Kinki Integrated Regional Development Program should help to solve the regional problem through the regional specialization [3] and creation and utilization of opportunities. It is, however, necessary to form and launch the program and choose for it some organization.

#### 4. AN ORGANIZATIONAL ANALYSIS OF REGIONAL DEVELOPMENT PROGRAMS

The organizational dimension of program management represents an important issue for its successful implementation. Despite this the scientific support for multiorganizational strategies has been very limited. The purpose of this section is the presentation of a conceptual framework for the analysis of the organizational strategies of development programs. This framework has been developed at IIASA in the context of research in case studies of Large-Scale Regional Programs. Both the methodological approach and its testing for different development programs is documented in [2, 23]. Further in the section some observations on application of this methodological approach for the Kinki IRD Program will be presented.

The conceptual framework is intended to provide a method for deriving the organizational implications of program objectives and assessing the capacity of existing or planned institutional resources in terms of those implications. It can be utilized either to generate alternative organizational strategies or to evaluate policy proposals in terms of their contribution to effective program management.

##### 4.1. The Framework

The selection of an appropriate organizational strategy should be a function of the nature of program objectives and activities, existing institutional relationships and the values governing the management and organization in the program setting. The conceptual framework provides policy makers, through their analysts, with the capability for assessing existing institutional resources and strategy alternatives according to a set of criteria which are derived from organizational principles.

##### 4.2. Management Challenges

Program substantiation places some demands on the management. These demands could be identified in terms of management challenges. For any program the full range of activities and support processes is very high and a subset of these must be selected for a useful analysis.

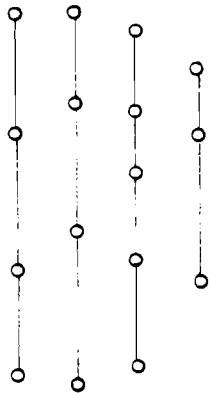

IIRD CDP:

NATIONAL SUBSYSTEMS AND POLICIES  
SPANNED OVER WHOLE TERRITORY  
AND OVER ALL UNIVERSAL FUNCTIONS

CONDITIONS OF CORRESPONDENCE?

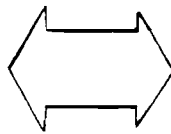

IIIRD CDP:

HABITAT-AND-ENVIRONMENT BASED  
DEVELOPMENT OF HIGHER AND BROADER  
FUNCTIONS AND ACTIVITIES

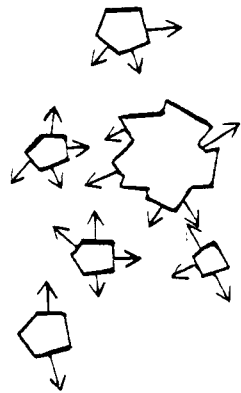

Figure 6.

Table 2. Policy changes over time.

Issue Area	Period	Policy Changes
National	1st Comprehensive Development Plan 1961-1969	Maximization of GNP
National	2nd Comprehensive Development Plan 1969-1977	Keeping up and Stabilizing the GNP Growth
National	3rd Comprehensive Development Plan 1977-	Adjustment to Moderate GNP Growth and External Fluctuations
General Regional	Control of Main Deteriorative Tendencies (through Planning, Zoning)	Spread of Development of Innovation into the Whole of the Country to form a Coherent System
Transportation	Independent Growth of Mode	Emphasis on Nationwide Transportation Network
Transportation	Introduction of Shinkansen	Introduction of Shinkansen Program
Transportation	Introduction of Highway Program	Readjustment of Transportation Programs both to National (Employment, Prices) and Local (Efficiency) Situation Changes
Environmental	Beginning of the Explicit Policy Formulations	Reformulation of Standards
Environmental	Research Establishment of Institutions	Impact Assessments? Inclusion in National Welfare Indices
Kinki	Recognition of Planning Needs as of a Metropolitan Area	Location of Kansai Airport
Kinki	Zones and Development Centers/Areas	Stress on Human Environment, Welfare and Infrastructure
Kinki	Comprehensive Development Plans	Coordinated Regional Policy?

The concern should be with those aspects that are a direct consequence of the creation of a program. The concept of management challenges facilitates the distinction of this program-related complexity. On the other hand, they involve and affect many different organizations in the program setting and the way these organizations interrelate. As an analytic device, the definition of management challenges serves to crystalize the major organizational policy issues.

#### 4.3. The System-Environment Interactions

Of the many organizations that might in some way or another be associated with the program we define our relevant organizational system as consisting of those organizations whose objectives are derived, at least in part, from the statement of program objectives. The most elementary part of the framework is the recognition that this system is in interaction with an environment—a systemic environment consisting of those factors external to it, a change in the complexity of which requires some response by the system. If the system is to survive in its environment, the interaction between system and environment must be balanced in one way or another. That is, the system must be able to respond in an appropriate way to each change in the state of the environmental factors. This is a statement of Ashby's Law of Requisite Variety [24].

Figure 7 illustrates the concept of system-environment interaction. The relevant system environment is defined by the system objectives. The particular objectives that a system is intended to achieve define the set of outside factors that must be taken into account. When new program objectives are defined, they tend to result in an increase in the complexity or number of states of the environment to which the system must relate. It is this increase in environmental complexity that poses the new challenges to the system. If the objectives are to be achieved, organizational responses are required that increase the ability of the system to meet the new complexity of the environment. A reformulation of Ashby's Law for this framework says that the complexity of the organizational response should be at least as high as the complexity of the challenges if there is an intention to control them.

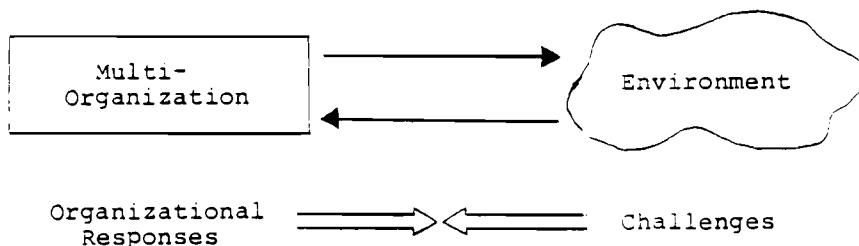

Figure 7. System-environment interaction.



#### 4.4. Structure of the System

The set of organizations, the multiorganization, which defines the system under consideration, has a structure, be it formal or informal. This structure is identified by studying the nature of the goals of different member organizations in the context of the development. In this manner the organizations are clustered into a system structured by levels, each embedded within each other.

In this case, where the program is one of regional development we can define a *national* or *general* system level which defines the boundaries or general objectives of the regional program. At this level are organizations whose focus considers trade-offs between regional development and other potentially competing activities. Once these trade-offs are worked out and goals defined, the goals are specific to the regional program, and which form the *regional* or *program system*.

This system level considers only trade-offs internal to the regional development objectives among various activities, thereby defining subgoals. In their turn to implement the subgoals, these are handed to a set of organizations concerned with specific activities, the *regional* or *program subsystem*.

We recognize this goal definition process as iterative and continuous between system levels.

The identification of these systemic levels is the first step in recognizing the pattern of organization in a particular setting. An implication of this systemic definition of organization is that the challenges we have identified earlier can be addressed by any one of the levels or by actions taken by any mix of organizations at the various levels.

#### 4.5 Functional Capacity

The management capacity of each one of these systemic levels can be expressed in terms of the functional roles played by each organization within it. The capacity of a system level is generated by the functions embodied in the organizations that comprise that systemic level. This functional capacity is specific to objectives and occurs at each systemic level. Five functions will be defined that are sufficient to describe all system behavior and that are necessary functions if the system is to achieve its objectives. These functions occur at each systemic level.

A *Policy Function* exercises discretion to choose between alternative strategies for objective achievement. Once selected, those form the objectives for subsystem. In this choice policy is supported by a process of generation and substance of alternatives— the *Intelligence Function*.

A *Control Function* "manages" the subsystems by providing resources and monitoring their performance against the objectives. Generally the activities of subsystems will be independent. A *Coordination Function* provides for direct information exchange

between subsystems so that they can take into account their effects upon each other. Finally there is a need for the selected activities to be implemented—an *Implementation Function*. At any system level this is provided directly by the subsystem embedded in that level. These five functions can, in turn, be recognized within the subsystems themselves. Together they define the "functional capacity" of each systemic level with respect to a particular objective. The functions and the concept of recursive levels provides the analytic framework with a capability for focus at any level of resolution, as illustrated in Figure 8.

To summarize the discussion of the framework, we may now consolidate these various elements into a more general picture of the analytic process. It is the increase of environmental complexity associated with program objectives that poses new challenges to the system. This new complexity may be met at any of the system levels under consideration.

If the program objectives are to be fully achieved it is postulated that the organizational capacity at each level should be sufficient to meet those demands. If matching does not occur, a lack of responsiveness of the system to its environment, leading to ineffectiveness, could be postulated. Such a case leads to a reconsideration of objectives which permits a different distribution of challenges among levels.

In this context, our inquiry could permit a detailed understanding of the overall response of a system. The policy output of an inquiry may be either a set of alternative strategies to facilitate the response, or an assessment of alternative organizational policies which may be under discussion.

#### 4.6. The Scheme of Organizational Analysis

The organizational analysis, based on the methodological approach presented above, is accomplished in a multistep process which involves the use of an abstraction of the program objectives and of institutional resources (Figure 9). The common language description of institutional resources and activities formalized and transformed into a systemic representation in order to address this issue. This transformation permits a reformation of issues and construction of a model of the program management system which can be analyzed and diagnosed. The systemic nature of the model orders the multiplicity of program activities and institutional relationships with a logic that permits operational consideration of such issues as interdependence, the distribution of discretion and authority, planning capability, communication links, and others.

The step from the analysis to the creation of organizational proposals requires a translation from the abstraction into the institutional alternatives, i.e., the forms that are appropriate for the program setting.

The analytic process must be coupled with a sound and intimate understanding of the values and traditions of the program setting in order to produce feasible organizational strategies which are of use to policy makers.

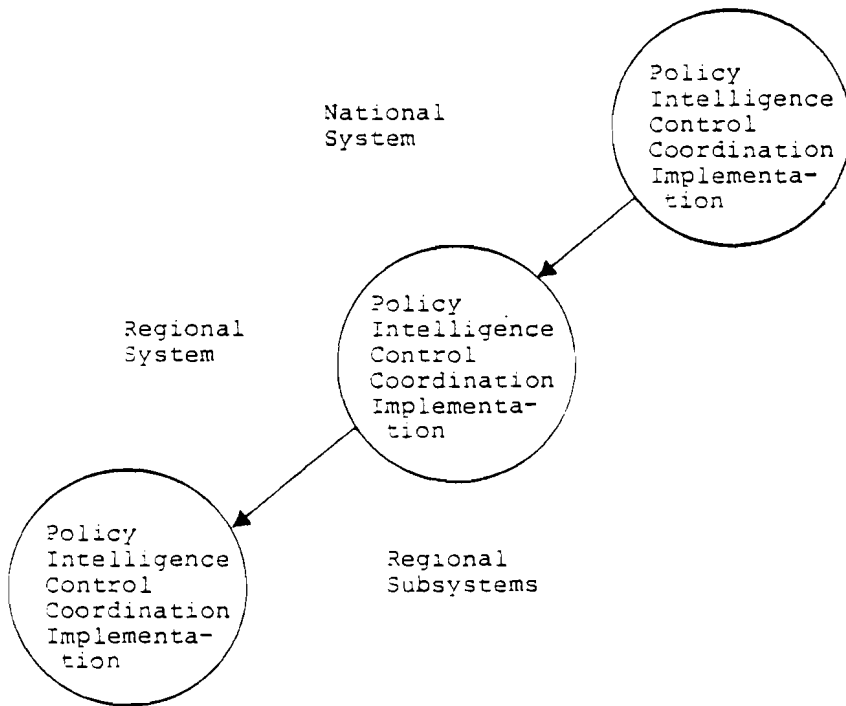

Figure 3. Functional capacity of a system.

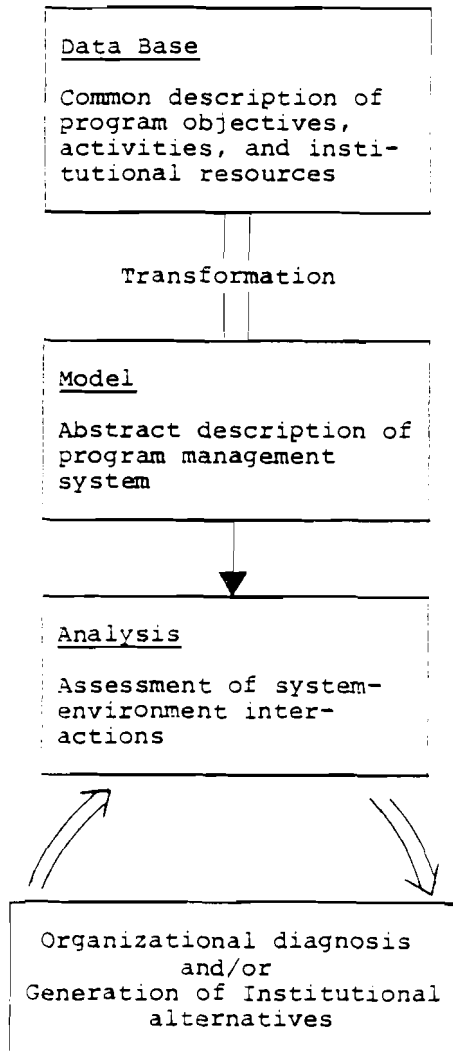

Figure 9. Analytic process.

#### 4.7. Some Observations for the Kinki IRD Program

The process of organizational analysis starts with data collection. Program objectives, the activities associated with them, and the institutions relevant to the management of those activities represent the data base for the analysis. The complete data base is the first requirement to be able to make the transformation, i.e., to describe the real world in terms of the model and to analyze organizational strategies within the language of the model.

In the case of the Kinki IRD Program the limited information of the reality is not sufficient to construct the full data base for the complete organizational analysis according to the framework prosecuted. Instead we will make some interim observations based on the data of papers in this volume. This very limited analysis we will restrict—from the view of the framework—to the consideration of policy function only.

During the sixties—as indicated in papers of Japanese authors—the main aim of Japan was to promote the economic development of the country. Simplifying, we can say that the main goals were:

- to raise the people's income level
- to increase the industrial production capacity.

These goals created some management challenges. We formulate them as specialization at the international level and industry location/allocation among prefectures. These challenges were mainly addressed by the national system. The functional capacity of that system level was enough to cope with them. The implementation function was delegated to what we call regional subsystems, be it along administrative or business lines. The regional system level was not recognized.

Now we add to those objectives a new one formulated as

- to create the comprehensive development of the region.

It incorporates interprefectural problems, such as resources development, environmental protection, and others coming from the necessity to improve the people's well-being within the region—also in terms of noneconomic aspects.

This new situation results in a rapid increase of the systemic environment complexity. New management challenges are posed that should be addressed at a regional systemic level. To cope with these challenges the policy capacity must exist at that level.

It could be exercised by organizations (institutions) wherever they are located. Let us consider whether in the existing institutional structure a policy capacity does exist that is able to cope with the demand created by these challenges.

First we will identify organizations that have policy discretion (for some of them exercising the policy function can be a part of their activities). Within the central government there are organizations that consider trade-offs between aspects of the Kinki region and aspects of other regions, e.g., development of other regions. These are the organizations supporting the region with long-term public investment programs as well as the financial investment and loans program. To that set also belong NLA, EPA, and—to some extent—the Ministries. Within the region there are the following organizations: local (prefectural) governments, joint committees, governors cooperations on inter-prefectural physical projects, and informal regional bodies and institutions, e.g., Kansai Information Center. Having identified these actors we should evaluate the policy capacity of the regional systemic level against the demand for the policy discretion. This level of discussion does not provide us with the ability either to decide this or to make any scientific evaluation. However, what we presented could be treated as a very simplified illustration of the analytic process. In particular it can be observed that in spite of the fact there is no regional authority it is likely that the management capacity of the regional systemic level either could exist or could be created within the existing institutional structure.

The methodology and frameworks based on the experience gained from IIASA case studies on large-scale regional development programs like TVA, Bratsk-Ilimsk and Shinkansen could be applied to other regional development programs, even less strictly formulated such as the Kinki IRDP. Some of the extreme conditions of these large programs help us to understand better the interorganizational behavior of regional development programs. The attempt made in this paper to apply frameworks for the evaluation of program organization and policy formulation for the Kinki IRDP proved to be suitable. This is even true in another extreme case, when the integrated regional programs are based only on research and modeling efforts and problématique generation almost without any organizational solution. This applicability should be understood in a way where proper questions could be generated and attention should be paid to the future formulation of the Kinki IRDP, if it proceeds to the next program formulation stage. Due to the frameworks we have developed we can see that the Kinki IRDP effort is still at the preprogram stage, which—due to our methodology—is extremely important as a prerequisite of any real IRD program. We hope that our results will be of use for Japanese researchers, as well as planners within the Kinki region, not as a recommendation, but as a way of focusing problem perception.

#### REFERENCES

- [1] Knop, H. (ed.) (1977) Report of the TVA Study Report, IIASA Research Report. Laxenburg, Austria: International Institute for Applied Systems Analysis.
- [2] Knop, H., and A. Strazak (eds.) (1978) The Bratsk-Ilimsk Territorial Production Complex: A Field Study Report. RR-78-2. Laxenburg, Austria: International Institute for Applied Systems Analysis.

- [3] Albegov, M.M. (1977) An approach to the sequence of IRD problem analysis, in Strategy of Future Regional Economic Growth—Proceedings of a Task Force Meeting on Regional Development, April 19-21, 1977, edited by M.M. Albegov. Laxenburg, Austria: International Institute for Applied Systems Analysis.
- [4] Albegov, M.M. (1977) Modeling for interregional and intraregional allocation of development, in Models for Regional Planning and Policy-Making, Proceedings of the Joint IBM/IIASA Conference, Vienna, September 1977, edited by A. Straszak and B.V. Wagle.
- [5] Aganbegyan, A.G., and K.K. Valtukh (1975) Application of National Economic Models in Planning. Moscow: Ekonomika (in Russian).
- [6] Isard, W. (1977) An outline of a dynamical systems approach to IRD, in Strategy of Future Regional Economic Growth—Proceedings of a Task Force Meeting on Regional Development, edited by M. Albegov. Laxenburg, Austria: International Institute for Applied Systems Analysis.
- [7] Knop, H. (ed.) (1976) A Computer Assisted Approach to Regional Development: Report of Research Activities on the Kinki Region in Japan. CP-76-10. Laxenburg, Austria: International Institute for Applied Systems Analysis.
- [8] Straszak, A., and J.W. Owsinski (1977) A regional planning model system: organization—structure and dynamics, in Models for Regional Planning and Policy-Making, Proceedings of the Joint IBM/IIASA Conference, Vienna, September 1977, edited by A. Straszak and B.V. Wagle.
- [9] Straszak, A., and J.W. Owsinski (1977) Models for Regional Development Problems: TVA and Bratsk-Ilimsk Territorial Production Complex. CP-77-3. Laxenburg, Austria: International Institute for Applied Systems Analysis.
- [10] Mennis, L.B.M., J. Tinbergen, and J. Waardenburg (1976) Elements of Space in Development Planning. Amsterdam: North Holland.
- [11] Strazak, A., and J.W. Owsinski (1976) Systems Analysis Approach to Intergrative Organization, Planning, and Management for the Development of the Region. Paper presented at the Polish-Italian Symposium in Bialowieza.
- [12] Artle, R. (1977) IRD: efficiency versus equity with some suggestions for descriptive Research, in Strategy of Future Regional Economic Growth—Proceedings of a Task Force Meeting on Regional Development, edited by M. Albegov. Laxenburg: Austria: International Institute for Applied Systems Analysis.
- [13] Martin, Ch.C. (1976) Project Management. New York: Amacom.

- [14] Novikow, E.D., and I.M. Samochin (1976) Complex National Economy Programs. Moscow: Nauka (in Russian).
- [15] Pospelov, G.S., and W. Irikov (1977) Program and Goal Oriented Planning and Management. Moscow: Soviet Radio (in Russian).
- [16] Preston, A.J., and E. Sieper (1977) Policy objectives and instrument requirements for a dynamic theory of policy, in Applications of Control Theory of Policy, edited by J.D. Pitchford and S.J. Turnovsky. Amsterdam: North Holland.
- [17] Straszak, A. (1977) Problem of multimodeling in large-organization, in New Trends in Mathematical Modeling, edited by A. Straszak and J.W. Owsinski. Wroclaw: Ossolineum.
- [18] Straszak, A., and J.W. Owsinski (1978) Control Theoretic Approach to Socioeconomic Systems: Role and Applicability. Proceedings of the VII World IFAC Congress, Helsinki, June 1978. Oxford: Pergamon Press.
- [19] Dror, Y. (1976) Applied social science and systems analysis, in The Use and Abuse of Social Science, edited by I.L. Horowitz. New Brunswick: Transaction Books.
- [20] Fischer, D.W., and R.F. Keith (1977) Assessing the Development Decision-Making Process. The American Journal of Economics and Sociology, 36:January.
- [21] Hatry, H.P., et al. (1973) Practical Program Evaluation for State and Local Government Officials. Washington, D.C.: The Urban Institute.
- [22] Owsinski, J.W. (1978) Interinstitutional use of models in a large-scale development program, in Systems Analysis Applications to Complex Programs, edited by K. Cichocki and A. Straszak. Oxford: Pergamon Press.
- [23] Davies, C., et al. (1977) Multi-Organizational Strategies, An Analytic Framework and Case Illustrations. RM-77-4. Laxenburg, Austria: International Institute for Applied Systems Analysis.
- [24] Ashby, W. (1956) Introduction to Cybernetics. London: Chapman and Hall.



Part IV

MODELS FOR INTEGRATED REGIONAL DEVELOPMENT PROGRAMS

## IBM EXPERIENCES IN URBAN AND REGIONAL SYSTEM DEVELOPMENT

T. Shiina, *President*  
T. Ainai, *Tokyo Scientific Center*  
T. Tohyama, *Academic and Scientific Programs*  
T. Matsuzaki, *Tokyo Scientific Center*  
*IBM Japan, Tokyo, Japan*

### ABSTRACT

Since 1972, the Tokyo Scientific Center, IBM Japan, Ltd., has devoted considerable effort to the areas of environmental problems and urban/regional development programs. The systems we have developed, such as the Interactive Simulation System for Air Pollution, Hyogo Dynamics, the Computer Assisted Regional Planning System, etc., have exhibited our research philosophy, and have affected regulations, procedures, and the administration of environmental and regional management systems in Japan. As a natural extension of our research experiences and what we had learned from activities with central and/or local governments we developed the Kinki Integrated Regional Development Program with some university professors in 1977.

This report is a brief summary of our past research experiences in environmental, urban, and regional development systems from early 1972 to date; its discussion deals mainly with the philosophies of our research concepts as realized in computer-assisted systems.

### 1. INTRODUCTION

The objective of the Scientific Center is to conduct research on computer applications. One of the typical research areas is the exploring of how the computer can be applied to solving problems in an environment that is becoming increasingly complex.

The chronological history of major research projects and programs related to environmental, urban, and regional areas took place at the Tokyo Scientific Center, IBM Japan, as shown in Figure 1.

(as of 10/8)

	1972	1973	1974	1975	1976	1977	1978
I. ISSAP (Air Pollution Control) Transfer	Development						
II. Hyogo Dynamics (Long Range Plan) Implementation Transfer		( Demonstration/Education ) Development	Regional Symposia (Plan Completed)	Eg Osaka Pref., Miyagi Pref.			
III. PIAS/CARPS (Regional Management) Concept Transfer				Joint Study Enhancement			
IV. KIRIKI IRBP (IRP)				(National Environment Agency)		Partnership Program	

Figure 1. Research projects history of environmental/urban/regional development program.

In 1960, the Prime Minister H. Ikeda launched a policy for a "high growth rate economy" in Japan. From then, up to the so-called "oil shock" in 1973, Japan has enjoyed economic growth and a rapid expansion of industrial production capacity.

At the beginning of 1972, when the environmental problem, especially the air pollution problem, began to be recognized as a nationwide problem, one research group was initiated at the Tokyo Scientific Center to challenge the environmental problem as a new computer application area. They decided to develop computer technology useful for environmental conservation and have concentrated their efforts on developing computer techniques related to that area.

On the other hand, the Hyogo prefecture, suffering from regional problems, was looking for a tool that could be used for making planning operations more scientific and accurate. Hyogo is one of local governments that have concerns in revising and improving long-range comprehensive plans, and that have initiated activities in making new plans with new concepts, from around 1973, corresponding to the plan at the national level. Thus, we got together and began to conduct research jointly so that our research can be applied in actuality and the results can be utilized by the policy planners and their co-workers.

The first phase of our research activities was the implementation of the Interactive Simulation System for Air Pollution (ISSAP) [1, 2, 3, 4] based on the Gaussian Plume model in which effectiveness was verified by using actual data gathered in Himeji City, Hyogo prefecture. Next was the building of a system dynamics model, called Hyogo Dynamics [3, 5], for establishing a long-range comprehensive plan.

In 1975, based on these activities, an experimental system called "CARPS," the Computer Assisted Regional Development Planning System [3, 6, 7, 8] was developed by us together with Hyogo prefecture. Since then, the system dynamics approach, adopted in the Hyogo Dynamics for seeking a comprehensive planning, has been guided to Osaka prefecture [9], Miyagi prefecture [10], and so on. Experience obtained through our research activities has been highly appreciated by the National Environment Agency preparing a new bill for an environment impact assessment.

As a natural consequence of experiences gained through several years in system research and development activities with local governments, an important issue has become clear; that is, the necessity of relaxing the administrative constraints and boundaries even on a hypothetical basis to cope with problems that may lay across more than one prefecture/city simultaneously. At the same time, we have felt that there are few really effective methodologies existing and working in the city and little regional planning to integrate separated and independent analytical approaches—with some exceptions, such as system dynamics, systems of social indicators, narrative scenarios with technical manuals, and so on.

Under these circumstances, the Kinki IRDP project [11] is being initiated. One of the major concerns is to generate a workable idea of integration and coordination.

## 2. INTERACTIVE SIMULATION SYSTEM FOR AIR POLLUTION

The shifts in energy demand and environmental pollution in Japan from the fiscal year 1955 to the fiscal year 1972, when our group's activities started, are shown in Figure 2. While the real GNP in the fiscal 1972 was 5.1 times bigger than that of 1955, the level of SO<sub>x</sub> and NO<sub>x</sub> increased more rapidly than that. The growth of the economy has improved living standards and the conveniences of daily life, but it has also caused undesirable effects from the standpoint of environmental conservation. Environmental pollution has been recognized as a nationwide problem, threatening the living and health environment of most Japanese people. As a result, new air quality standards went into effect in May 1973.

Under this situation, we decided to build an air pollution simulation model and to implement an Interactive Simulation System for Air Pollution using this model in cooperation with the Hyogo prefectural government. Himeji City (see Figure 3) was selected in order to verify the model so that emission data could be obtained in compliance with the agreement with Hyogo prefecture and Himeji City for experimental research use. Based on the Gaussian Plume model, though we have modified it on the basis of a well established statistical method, the eight-hour average concentration of SO<sub>x</sub> in the daytime was calculated in an episode condition.

The Interactive Simulation System for Air Pollution (ISSAP) was designed to identify the efficiency and feasibility of using a computer-aided system for the solution of an air pollution problem. This system also provided an evaluation tool for simulating air pollution when performing urban planning and environmental control planning. Graphical representation of simulated results was given on the IBM 2250 graphic display unit as shown in Figure 3. Any parameter of the model, such as stack data, meteorological data and simulation area data, can be easily retrieved and modified interactively through the screen in the course of simulation.

A series of demonstrations to the executive officers of local governments, private industries, and academic societies had initiated positive discussion of the power of the systems approach we had taken. And the Gaussian Plume model was incorporated in the total control method by the Environment Agency of Japan [12].

## 3. HYOGO DYNAMICS

The aim of the studies on the Interactive Simulation System for Air Pollution was to solve problems for a short period and for a small region.

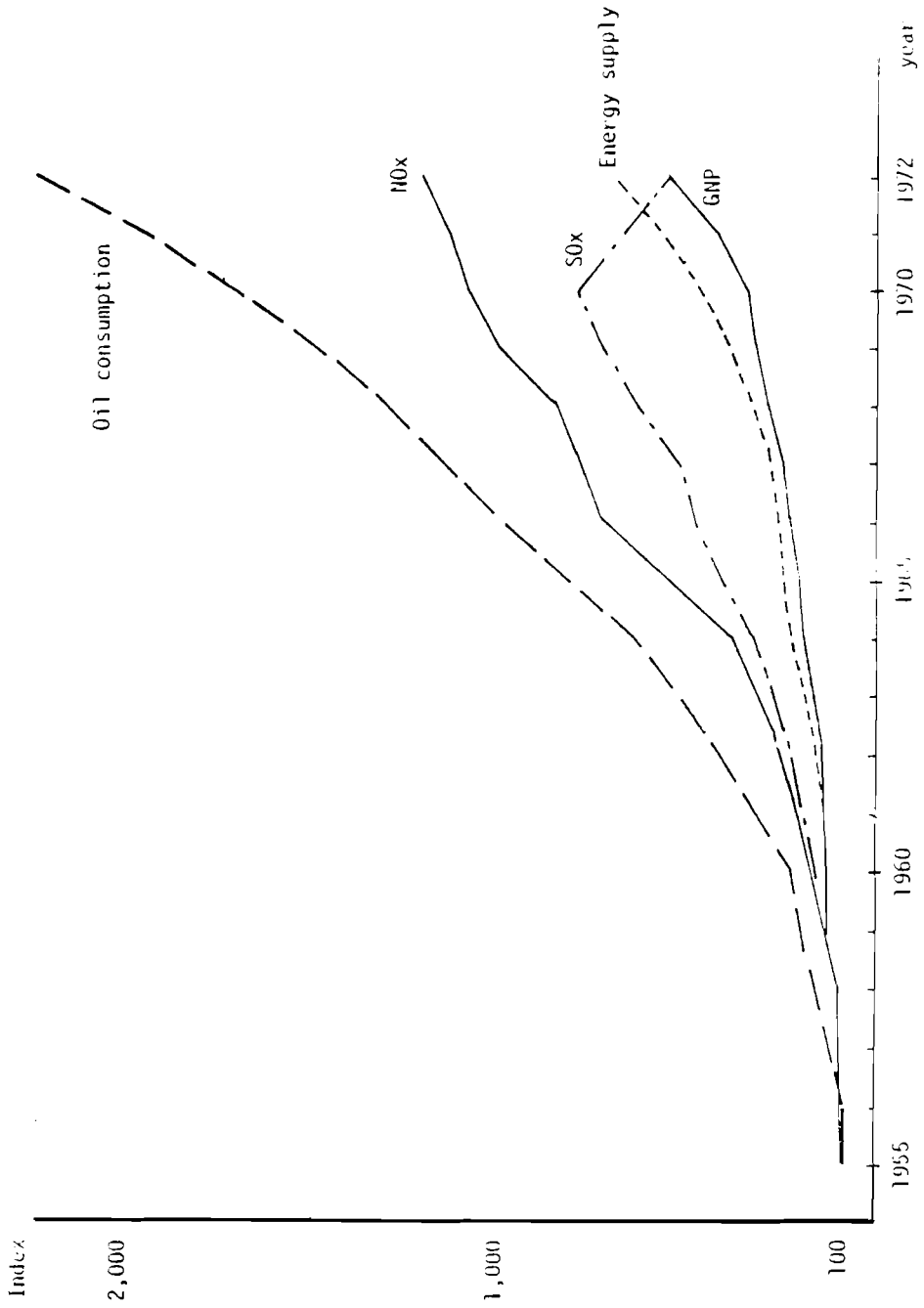

Figure 2. Energy demand and environmental pollution.

Source: White Papers of Japan, 1974-1975.

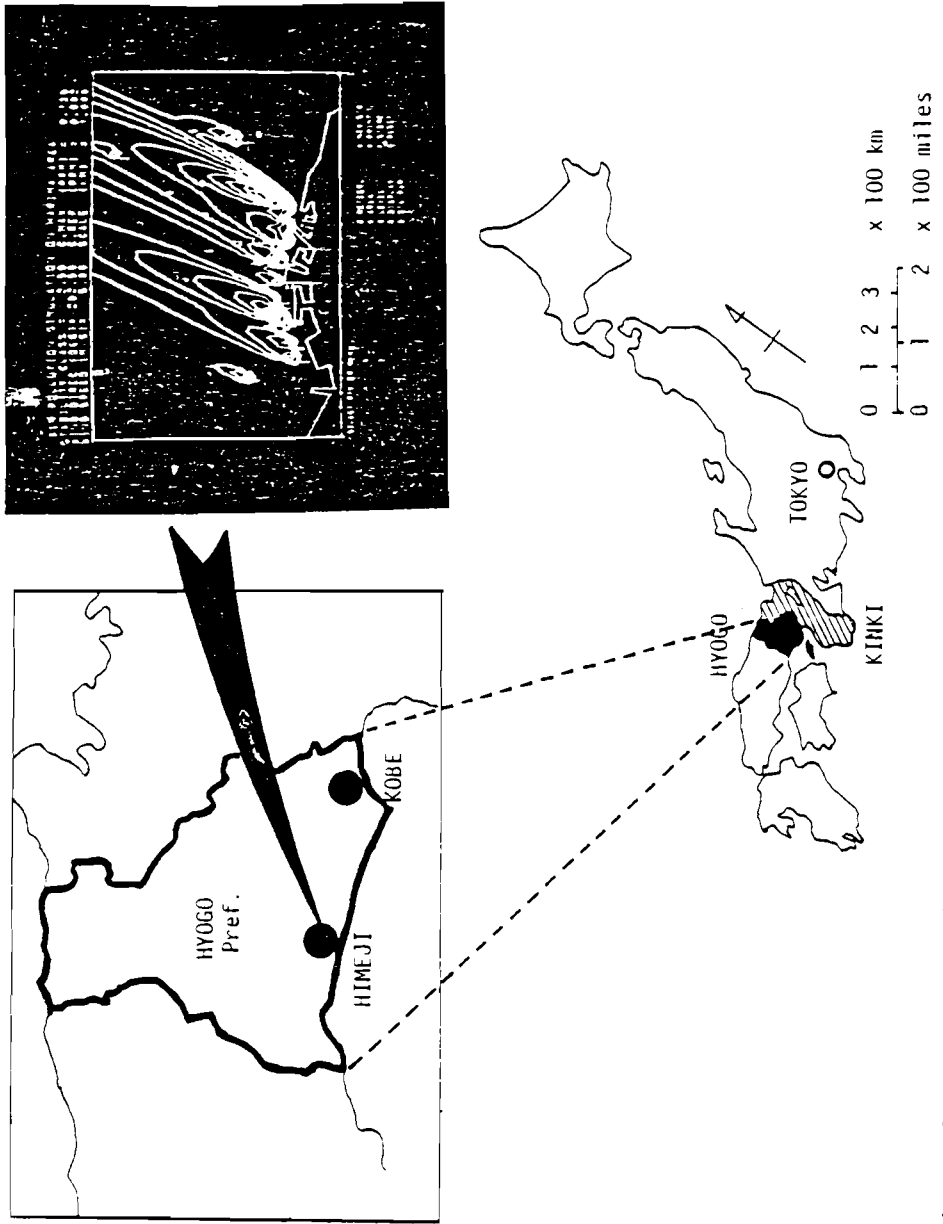

Figure 3. The ISSAP in Himeji, Hyogo prefecture.

In Himeji City, during the period from 1965 to 1970, population shifts indicated a greater trend toward urbanization due to industrialization in the coastal area. On the other hand, there are about 200 stationary emission sources. They belong to plants such as steel mills, refineries, power plants, and others located along the coastline like many other industrialized cities in Japan. As a result, a large part of the city including the urban areas and northern suburban areas came to be affected by pollutants owing, especially, to winds coming from the Seto Inland Sea. This tells us that the environmental issue is not only related to environmental planning and/or environment impact assessment but also to regional development planning and comprehensive planning. Thus, we have reached the conclusion that the long-term and wide-range approach is essential in order to solve the problem in a thorough way.

Meanwhile, the Hyogo prefectural government was about to revise their earlier comprehensive plan since it had turned out to be insufficient and not systematic. The government had formed a project group called the Hyogo Dynamics Project Team [12], and the cooperative activity with us started in May 1973. So, from this standpoint, our study started from the bottom level, namely, from air pollution simulation, in the planning hierarchy as shown in Figure 4.

The cooperative activity was aimed at investigating the solving of problems of environmental disruption, land use, traffic congestion, and industrial activities not only by individual but also by comprehensive approaches. From the viewpoint of the hierarchical structure of planning, the aim can be interpreted as a search for a tool in establishing a comprehensive plan. Through this activity, a system dynamics approach was selected and a simulation model called Hyogo Dynamics was built.

The Hyogo Dynamics Model is primarily a vehicle to assist the Hyogo prefecture in making the New Comprehensive Plan. The model has two separate purposes. One is to give warning against various social, regional problems that would arise if the existing policies are followed: "what if nothing is changed in the present policies for growth?" The other is to promote people's understanding of trade-off relationships among such problems as environment, traffic, quality of life, etc.

The Hyogo Dynamics is made up of four scenarios: population sector, industry sector, environmental pollution sector, and resource sector. Each sector is broken down into many factors. The model gives a simulation of the whole prefecture and the coastal area for up to 50 years. The conditions of 1970 are entered as initial values. Through the model, it is forecasted that the population of the coastal region will reach a peak at around 1990 to 1995 [13]. This means that the activities in the coastal region will reach a limit in the future. Air pollution and water shortage in this region will apparently become very serious.



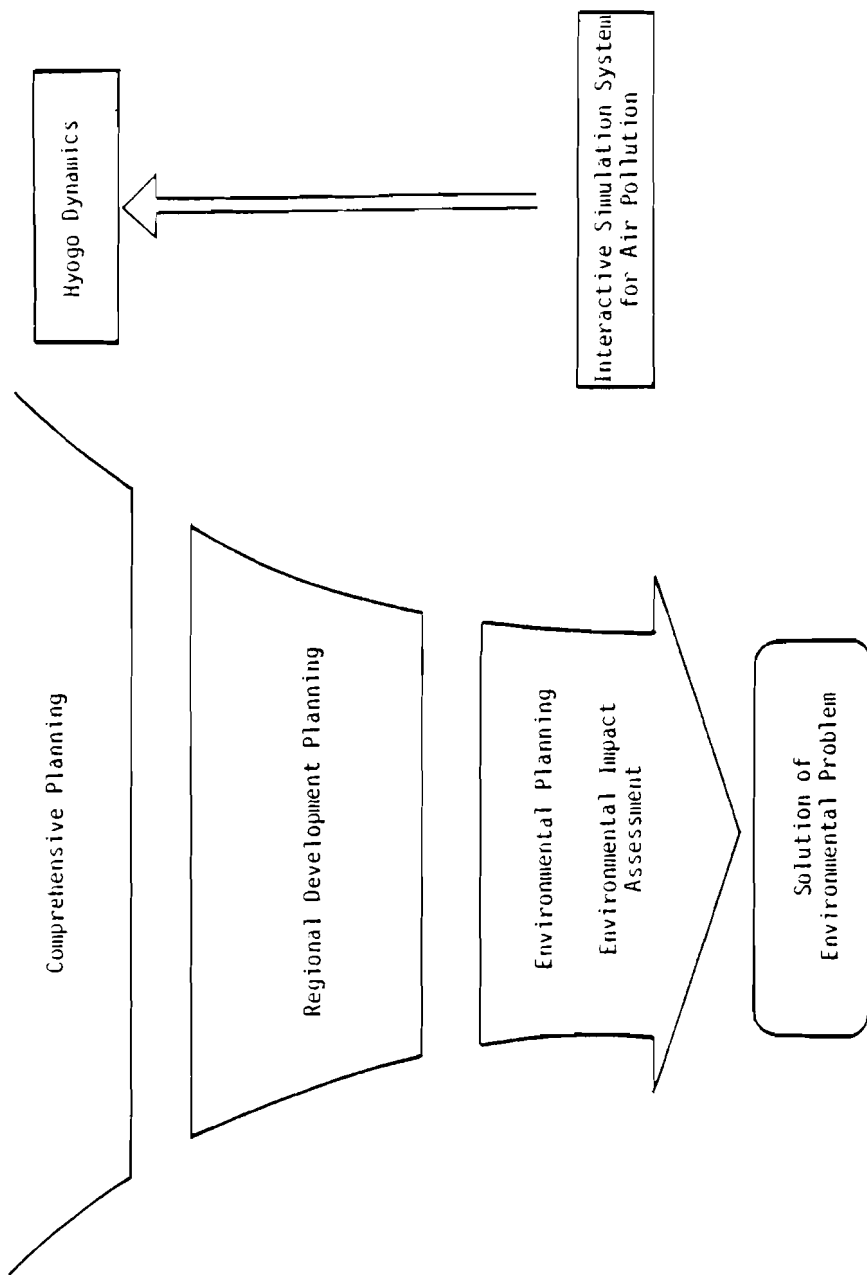

Figure 4. Evolution of model development in the planning process.

The outcomes from a series of computer simulations were presented to the inhabitants by holding regional symposia, which took place in different subregions of the Hyogo prefecture, to obtain people's agreement to and acceptance of trade-offs. The opinions raised through these processes were reflected in the draft of the New Comprehensive Plan. The governor of the Hyogo prefecture decided to adopt the New Comprehensive Plan in March 1979 [14]; this would not have been made possible without the help of the Hyogo Dynamics which we have developed and the support of the prefectural inhabitants.

#### 4. COMPUTER ASSISTED REGIONAL DEVELOPMENT PLANNING SYSTEM

From our experience of developing computer systems for environmental problems described so far, we can say that the role of the computer is not only to gather data and predict the pollution levels but also to assist the policy planners in methods of bridging the gap between the goal described in the comprehensive plan and the real problems to be solved in a region.

The planning process is said to consist of comprehensive plan as a vision of comprehensive regional development, as a vision of regional development projects, the fundamental scheme of the projects, the basic plan of the project, and the project implementation plan as shown in Figure 5. From the viewpoint of the planning process, the comprehensive regional development plan is merely a vision of the entire regional development. A proposed plan of a specific project is supposed to be evaluated by a comparison among all the alternatives at each of these stages. The process of picking out an alternative is extremely important because of conflicts among the proposed project plans.

As a matter of fact [14], the New Comprehensive Plan established by the Hyogo prefectural government expresses the necessity of developing a computer system to manage regional development projects in order to make the comprehensive plan more operational. In other words, it is necessary to develop a system that links the comprehensive plan and a regional development plan. Thus, the joint research on the CARPS was started in early 1975.

There are two objectives of the joint research. One is, from the viewpoint of the planning process, to establish a management system or a management procedure that can be used by a concerned planner who makes and evaluates a detailed plan based on the comprehensive plan. The other is to establish the concepts and to develop an experimental system to realize this management system from the standpoint of computer technology.

The CARPS is an Interactive Computer System which handles regional statistic data and simulation models and outputs generated information on a display unit enhancing the communication between the computer system and the policy planner (Figures 6 and 7). The planning work is usually performed in a very "unformatted" or "nonprocedural" way. In order to make it possible for a computer to assist planners in such a manner, the CARPS provides two unique functions: one is the Interactive Table Data Operation and the other the Interactive Model Operation [7, 8].

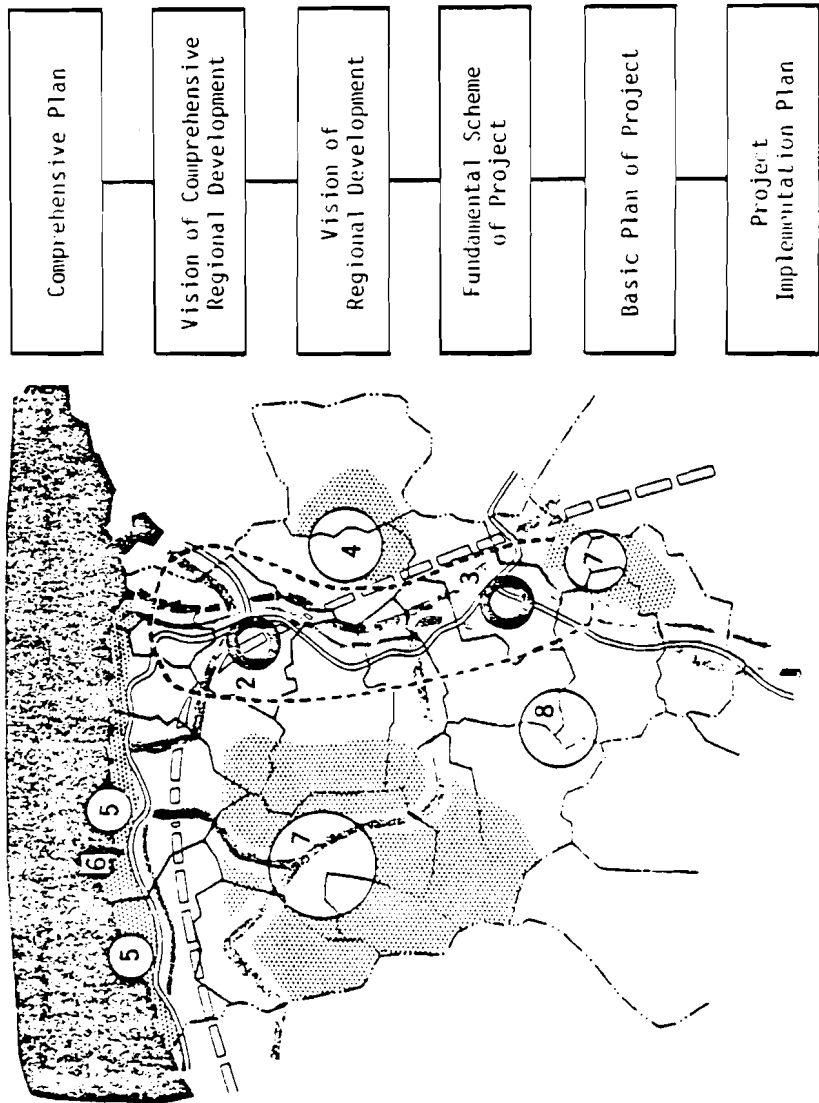

Figure 5. Planning process hierarchy.

Source: [13].

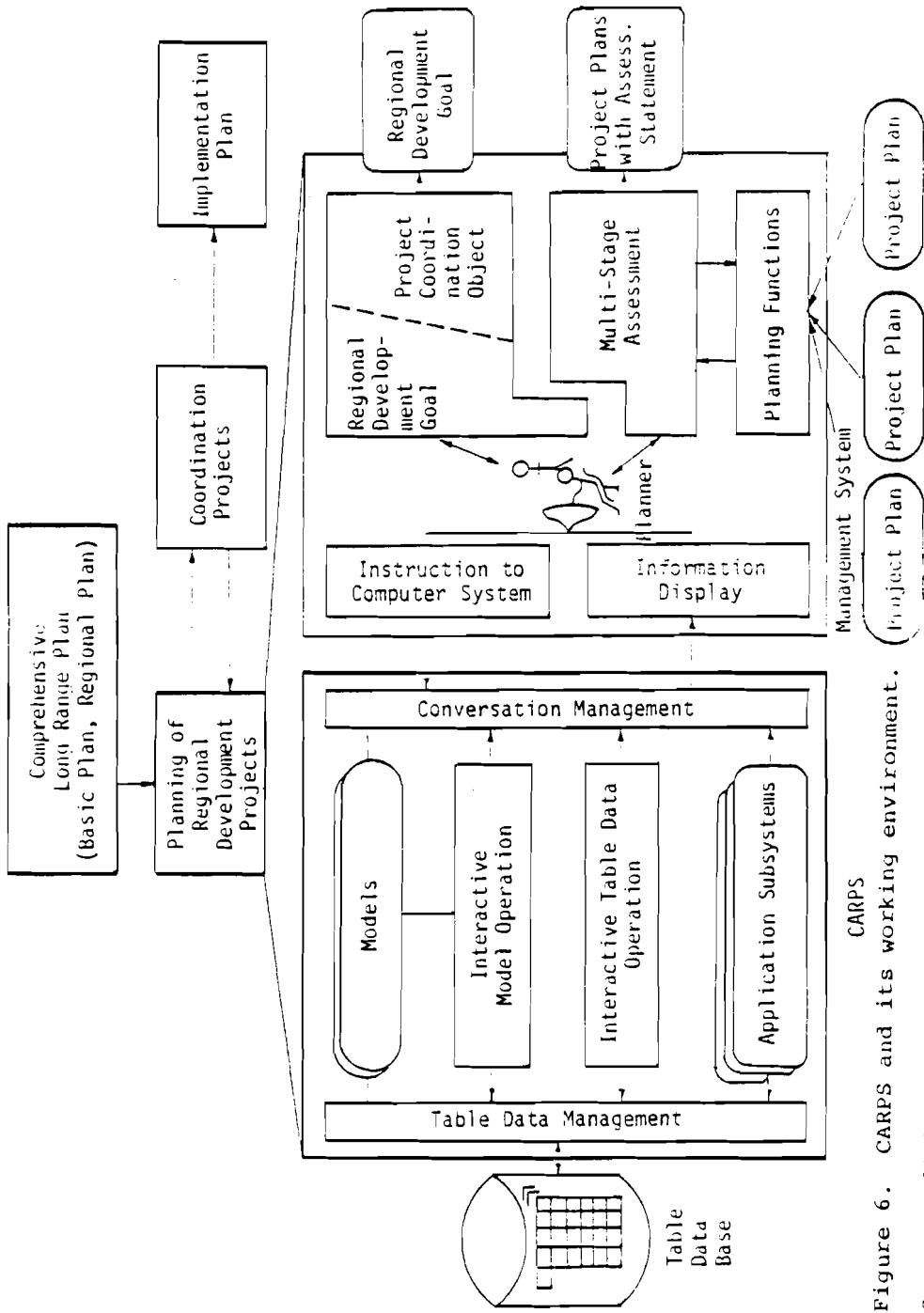

Figure 6. CARPS and its working environment.

Source: [15].

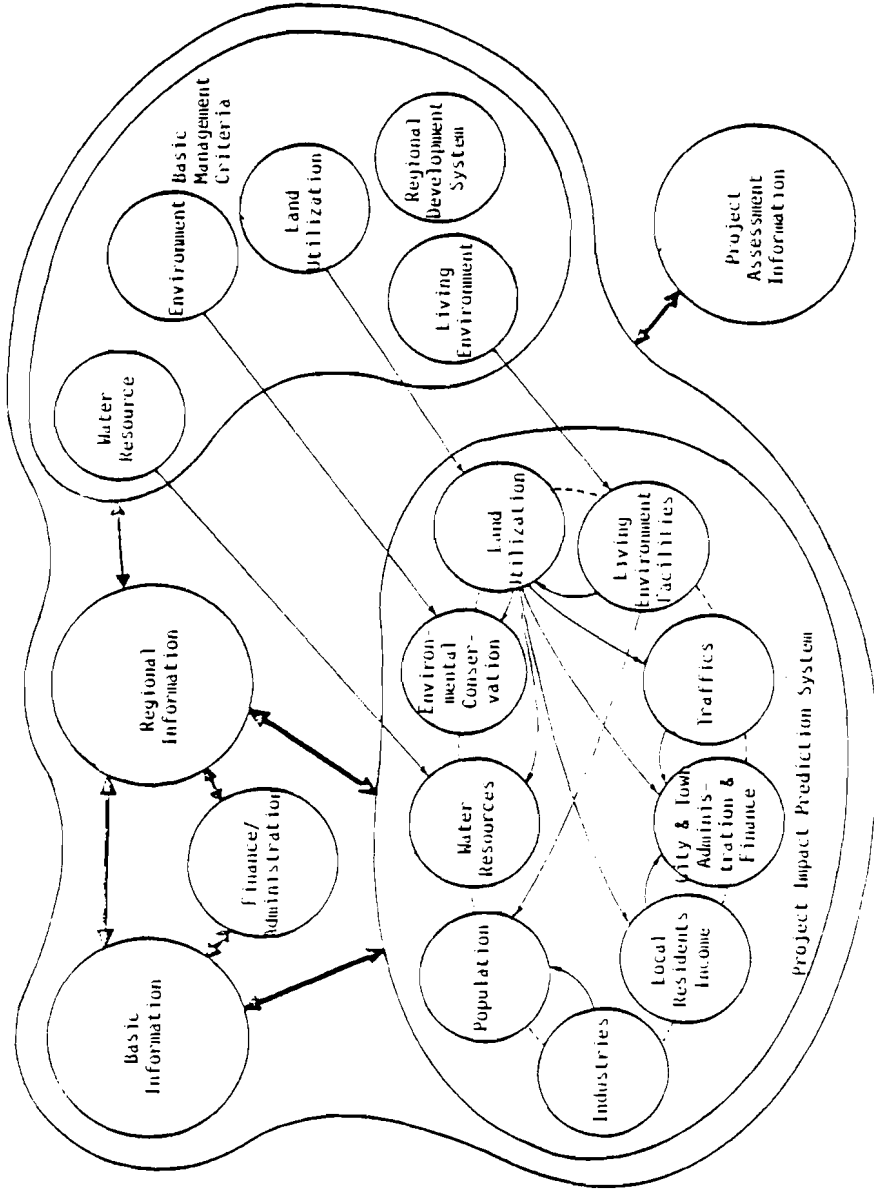

Figure 7. PIAS input and output relations for CARPS.

The Interactive Table Data Operation handles a table format data base of various types of data including regional statistic data and time series data. The data can be retrieved and modified through a display terminal. These table data can also be used as an input to simulation models or application subsystems. The Model Operation facility incorporates any predefined model and links it to other models in an interactive way. For example, the GNP model can be executed independently and it can also be combined with other models under the control of the Interactive Model Operation.

The CARPS thus aims at giving assistance in making multi-stage assessment (see Figure 8) of regional development projects from three aspects: from the higher level plans such as the long-range comprehensive plan, from the restrictive standards such as the legal restrictions, and from impacts of the project such as environmental impacts. On the other hand, procedures that are already set for planning can be built in the CARPS as application subsystems depending on specific requirements.

## 5. TOWARDS THE KINKI IRDP

As mentioned earlier, the fast-growing economy in Japan has brought about various social strains. In urbanized and industrialized regions, over-population, traffic and housing congestion, environmental deterioration caused by pollution and water and energy shortages have come to be recognized as serious problems. In the meantime, in suburban and rural areas, the resulting rapid urbanization and industrialization have caused destruction of the natural environment and traffic congestion. All these hazards were clearly revealed after the so-called oil shock of 1973 and the disposition of the issues has been left to the central and/or local governments who ought to resolve them to some extent.

At the same time, the Kinki region, which comprises seven prefectures (Osaka, Kyoto, Kyogo, Shiga, Nara, Wakayama, and the southern part of Fukui), have begun to experience the same kind of social problems, such as uneven population distribution, imbalances in production and income levels within the region, relative decay of agricultural activity, environmental deterioration in highly industrialized zones, water shortages, and traffic and housing congestion as shown in Figure 9.

The Kinki region is located about 500 km west to Tokyo. It contains the Kyoto-Osaka-Kobe industrial complex, the second largest industrial complex, which depends mainly on the nation's largest lake, Biwa, as a source of water. In addition, Kinki is the country's most important historic region. The cities of Kyoto and Nara, world-famous old capitals, are located in the center of Kinki. These cities and their surrounding areas are working hard to preserve the many historic sites and cultural assets, traditional arts, festivals, and customs that are so much a part of the peoples heritage and daily lives. The Kinki region is thus considered as a fundamental unit for defining and solving the problématique, having a common societal, cultural, and historical background.

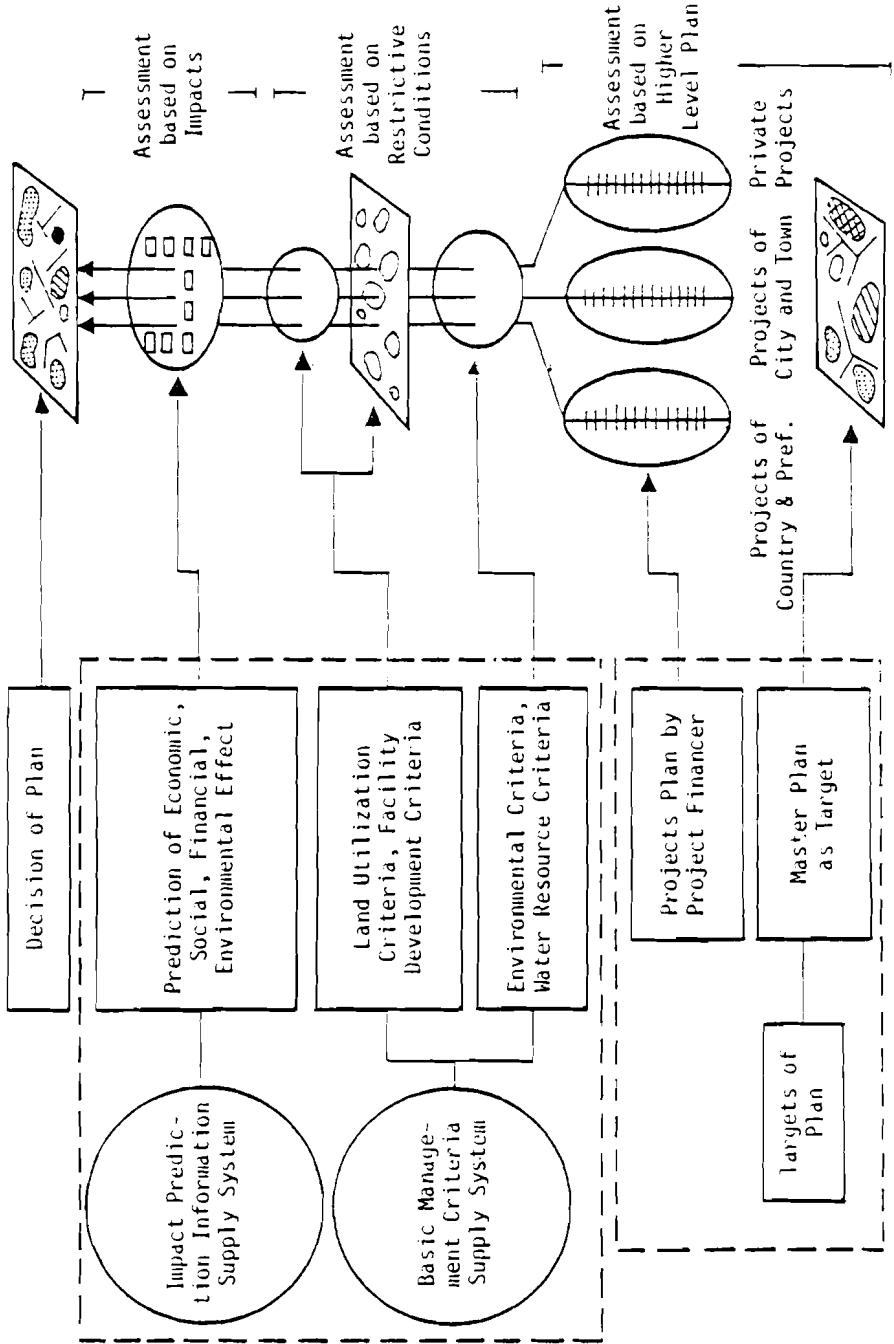

Figure 8. Multistage assessment of regional development projects.

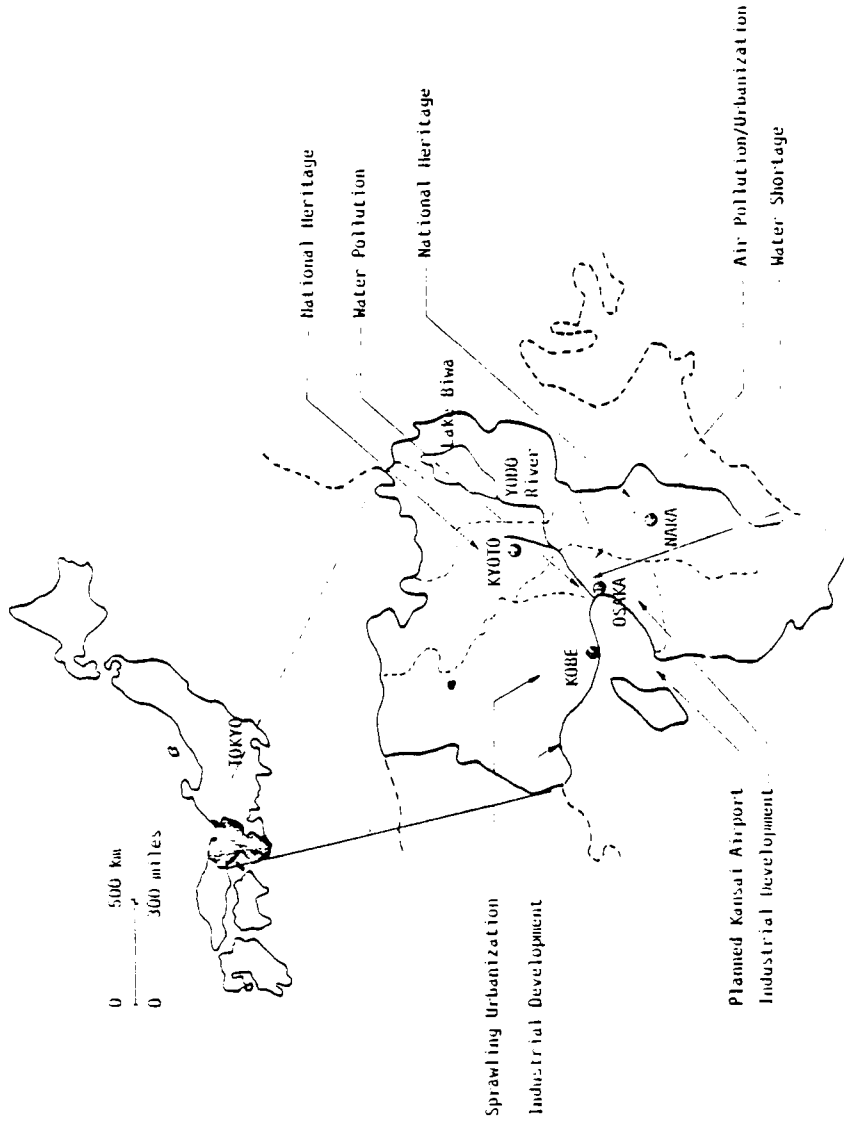

Figure 9. Kinki region and typical concerns.



Faced with these social problems brought about by a high rate of growth and the fact that Japan must rely on imported materials (e.g., oil), the nation has begun to reconsider and modify its attitudes and examine future socioeconomic development and land use planning. As a consequence, as the philosophical guideline for a long-range comprehensive regional development plan, the cabinet approved SANZENSŌ ("The Third Comprehensive Development Plan of the Nation" in English) on 4 November, 1977 [16]. In it several new and advanced concepts are explored and proposed and it is recommended that the regional development plans for the coming 10 to 20 years should be based on it.

Some of the major concepts are as follows:

- Decentralization of functions of the metropolis.
- Implementation of the human settlement strategies among local communities.
- Management and allocation of human activities in an optimal way throughout the nation.
- Establishment of social and physical security.
- Promotion of industrial activities in a fashion coordinated with natural, living, and a cultural environment.

It is also said that the national land use information should be collected for appropriate planning purposes.

On the other hand, we have recognized certain inevitable characteristics when conducting research on urban/regional development programs through our various research experiences. Some of them are:

(i). One specific region cannot be isolated or handled as a closed system since the problem in that particular region often interacts heavily with problems outside the region besides the problems within the region, as shown in Figures 10, 11, and 12.

(ii). Because of the interdisciplinary nature of the regional development problem caused by socioeconomic effects and by the behavior of the inhabitants, we strongly feel the necessity of exploring diverse methodologies to see if they can be applied (see Figure 13).

(iii). Furthermore, there are still some problems left in the area of impact assessment. Impacts vary with influencing elements and duration of effects. For example, if an industrial park is introduced to a region, though expecting better regional environment formation, the function of impact assessment will forecast multidimensional impacts caused by implementing the project by setting up the network connecting seemingly isolated problems.

One answer at present to the above problems is that the research has to be conducted to support the planners to some extent in their decision-making processes using computer systems. That is, the role of the computer in solving these kind of problems was to gather data and predict the impact level. But it should

Cause \ Effect	Industrial Development	Urbanization (Population)	Resources	Environment
Industrial Development	++	++	-- Scarce Resources	-- Pollution
Urbanization (Population)	++	+ Population Growth	- Scarce Resources	-- Pollution
Resources	-- Decentralization	- Tight Regulation of Land Use	Alternative Resources	- Maximum Use of Resources
Environment	-- Environment Assessment	-- Environment Assessment	--	-- Multiple Effects

++ Strong Positive Effect  
 + Positive Effect  
 - Negative Effect  
 -- Strong Negative Effect

Figure 10. Problem structure-matrix.

Effect Cause	HYOGO	OSAKA	KYOTO	SHIGA	WAKAYAMA	NARA	FUKUI
HYOGO		Ind. Act Labour Transportation	Water	Water			Elec. Pwr
OSAKA	Ind. Act Urbaniza- tion Transportation		Ind. Act Urbaniza- tion Environ- ment	Ind. Act Urbaniza- tion	Ind. Act Urbaniza- tion	Ind. Act Urbaniza- tion	Ind. Act Elec. Pwr
KYOTO		Environ- ment		Urbaniza- tion			Elec. Pwr
SHIGA	Water	Water	Water				
WAKAYAMA		Ind. Act Transportation					
NARA			Urbaniza- tion Transportation				
FUKUI	Elec. Pwr	Elec. Pwr	Elec. Pwr	Elec. Pwr	Elec. Pwr	Elec. Pwr	Elec. Pwr

Figure 11. An example of the interregional problématique in Kinki.

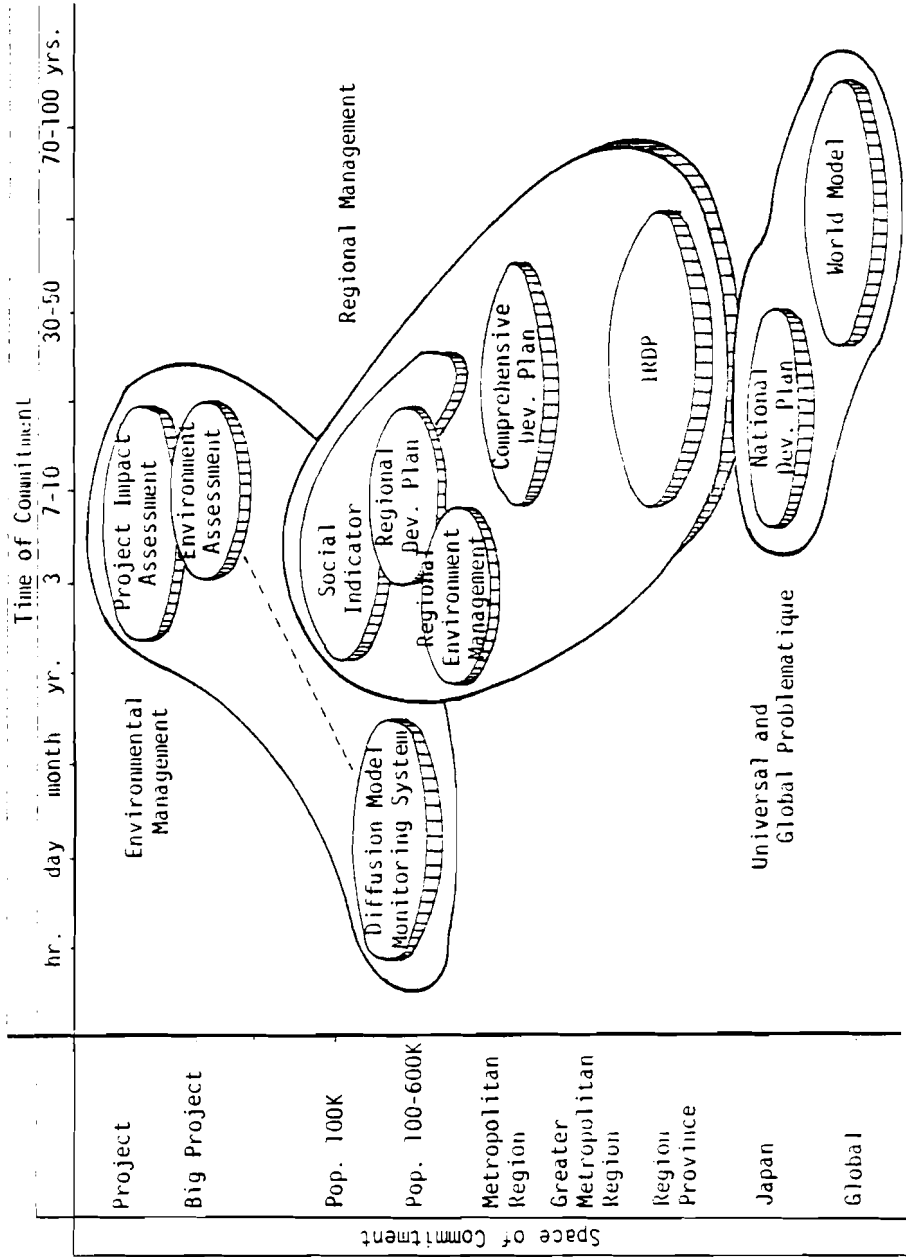

Figure 12. Regional program and its time-space commitment.

Subsystem	Data/Parameter Acquisition	Functional Processes	Methodologies/ Models	Output Information
Problem Definition and Structure Identification	*Brain storming	*Organization/re-organization *Structuring *Grouping	*K-J method	*Interlinked factors
	*Insight	*Quantization	*Dejoni method	*Forecast
	*Brain storming *Discussion			*General consensus
	*Insight *Brain storming	*Binary comparison	*ISM	*Hierarchical structure of factors
	*Insight *Brain storming	*Matrix analysis by quantization/gradation	*DEMATEL	*Interrelated structure with hierarchy
	*Survey	*Statistical analysis	*MDS	*Multidimensional clustering
Impact/Effect Prediction or Forecasting/ Prediction	*Statistics	*Modeling with parameters	*Least squares fitting	*Parameters identified *Prediction
	*Statistics *Insight *Function Table	*Models with parameters/assumptions	*Solution of ordinary differential equations *COMP III *DYNAMO III	*Prediction
	*Statistics *Insight into system structure	*Sequential updating of new information	*Least squares fitting	*Prediction/estimation/interpolation
	*Statistics		*Least squares fitting	

Figure 13. Characteristics of subsystems in Integrated Regional Development Program.

Subsystem	Data/Parameter Acquisition	Functional Processes	Methodologies/ Models	Output Information
Evaluation/ Assessment	*Multi-attribute function table	*Table handling	*Multi-attribute utility function method	*Utility vs. attribute
	*Evaluation matrix	*Quantization/grading	*Matrix analysis	*Weighted summation
	*Value systems on experiences	*Organization/re-organization	*Ad-hoc method	
Optimization/ Allocation	*Objectives *Constraints	*Iterative process of goal seeking	*Mathematical programming *MPSX/370	*Optimum solution
	*Regional constraint *Initial status of allocation	*Iterative process of allocation *Allocation of primary-secondary, and tertiary industry over the region	*Lowry type method	*Allocation by industry
	*Behavioristic analysis of people by age group, career, etc.	*Behavioural pattern analysis	*Simulation by behavioural pattern	*Movement pattern of people
Conflict Resolution	*Data gathered by enquete	*Statistical analysis	*Factor analysis, etc.	*Social indicator by region
	*Opinion	*Discussion	*Ad-hoc method	*Consensus
	*Opinion	*Discussion	*Citizen's participation	*Regional
			*Gaming simulation	

Figure 13. Continued.

assist the policy planners in making a complex regional plan that is supposed to be beneficial to the people of the concerned region beyond the primitive role. That is, computer systems are expected to play an effective role as decision support systems (DSS) in urban and regional planning. We are trying to establish such a system that can predict project impacts concerning various elements such as population, employment, production, income, finance, and living environment.

## 6. KINKI IRDP (INTEGRATED REGIONAL DEVELOPMENT PROGRAM)

### 6.1. Goals, Objectives, and Scope [11, 17]

The goal of the Kinki IRDP Project is to apply systems analysis methodologies in the development of a comprehensive regional plan that can form a sound and prosperous base for the future development of the Kinki region, from the information supply point of view. The regional development plan must encompass various subregional characteristics and goals and enhance the quality of life of the region.

### 6.2. Anticipated Results [11]

The anticipated results in the Kinki IRDP project may be summarized as follows.

(i). Structural identification and analysis of the regional problématique by the use of advanced systems methodologies, and suggestions for relevant regional policies to deal with it.

(ii). Generation of views on the future regional situation, normative or seminormative.

(iii). Suggestions for new concepts of regional planning and management, and suggestions for regional development guidelines, socioeconometric and cultural objectives, and constraints with respect to the environment and available resources.

(iv). Functional design and feasibility test of systems methodologies and the computer support system, including the construction of an experimental data base and demonstration packages.

(v). Communication between central and local administrative authorities and the industrial and commercial sectors.

(vi). Technology transfer to and from other institutions, e.g., IIASA (International Institute for Applied Systems Analysis).

The research activities are currently conducted under the IBM partnership program contract between JAACE (the Japan Association of Automatic Control Engineers) and IBM Japan for two years starting 1 January, 1977. The nature of the research objective, scope, and anticipated results are expected to be highly beneficial in terms of:

(i). Issues in the Kinki region could be common issues anywhere in Japan and anywhere else in the world as well.

(ii). There could be extensive application of established and new methodologies, or a combination of both, into the socio-economic environment, more specifically, to the IRD Program.

The functional role of each partner based on his previous experiences is shown in Figure 14.

### 6.3. Systems Methodologies [11, 17]

Another aspect of the objective is that it should make full use of a variety of advanced methodologies existing for systems approaches to a complex problématique and should check their conceptual and methodological feasibilities in the IRDP application. These methodologies include

- system structure identification and analysis
- forecasting
- modeling
- evaluation and optimization/decision-making
- computer assisted techniques.

As to the last item, efficient utilization of computer-assisted techniques is important for the project. These are:

(i). Interactive computing. In order to incorporate experiences, value systems and planning know-how into the integral model, an interactive approach is essential. Model management, operational functions, and data-handling management is to be integrated in a computer system.

(ii). Display technology. In order to accelerate communications among planners, model developers and other involved parties, display terminals are used extensively.

The matrix of the problem areas in the IRD Program and system methodologies is indicated in Figure 15. Computer-assisted techniques are considered to be cross-sectional.

### 6.4. Interim Results of the Kinki IRDP

To date, most research activities have been devoted to the development of individual methodologies and how they could be applied to the real problématique if at all.

#### *Structural Identification and Analysis of Regional Problématique*

Extended version of Figures 11 and 12 were developed among interested researchers to expose various aspects of the problématique commonly seen in the urban/regional development program.

The structural relations, by DEMATEL, among cross-regional attributes are shown in Figure 16 and interregional analysis is also reported as joint discussions with local government officers [18]. The interpretation suggests that:



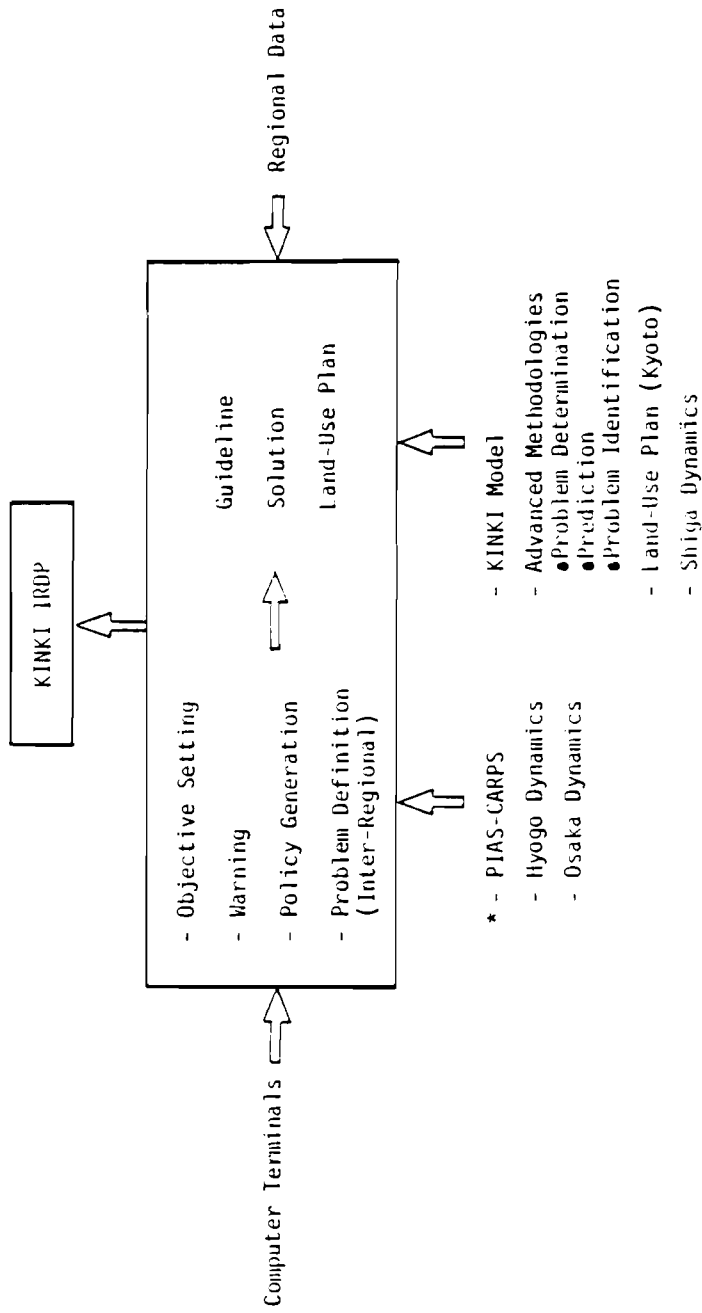

Figure 14. Function and experiences in Kinki IRDP.

Source: [11].

Methodologies		Problem Area		Subregional Problems							Regional Management Policy						
		Macro Regional Problems		Land Use							Env. Plan		Welfare Plan			Others	
		Goal Formulation	Status Monitoring	Industrial Activity	Urbanization	Transportation	Resources (Water)	Environment	Energy	Impact Assessment	Total Emts. Control	Env. Monitoring	Social Welfare	Personal Welfare	Total Welfare	Long Range Plan	Citizen's Participation
Problem Definition	Delphi Method	X		X	X	X	X	X	X						X	X	X
	K-J Method	X														X	X
	Ad-hoc Method	X								X						X	X
Structure Identification	ISM	X	X	X	X	X	X	X	X			X	X	X	X	X	X
	DEMATEL	X	X	X	X	X	X	X	X			X	X	X	X	X	X
	Multi-Dimensional Scaling											X	X	X	X	X	X
Impact/Effect Prediction	Kalman Filtering								X								
	Econometrics			X	X										X		
	System Dynamics	X		X	X	X	X	X	X	X		X	X	X	X	X	
	Multivariate Analysis			X	X	X	X	X									
	Physical Model							X		X	X						
	Nonphysical Model							X		X	X						
Evaluation Assessment	Multi-attribute Utility Function	X		X	X	X	X	X	X								X
	Check List	X		X	X	X	X	X	X	X							
	Ad-hoc Method	X		X	X	X	X	X	X	X							
Optimization Allocation	Mathematical Programming			X	X	X	X	X	X	X							
	Lowry Type Model			X	X	X	X	X	X								
	Simulation			X	X	X	X	X	X								
Conflict Resolution	Social Indicator	X		X				X									
	Ad-hoc Method			X													

(Source: What is the KINKI IRDP, IBM Japan, 1977)

Figure 15. Problem area and methodologies.

Source: [11].

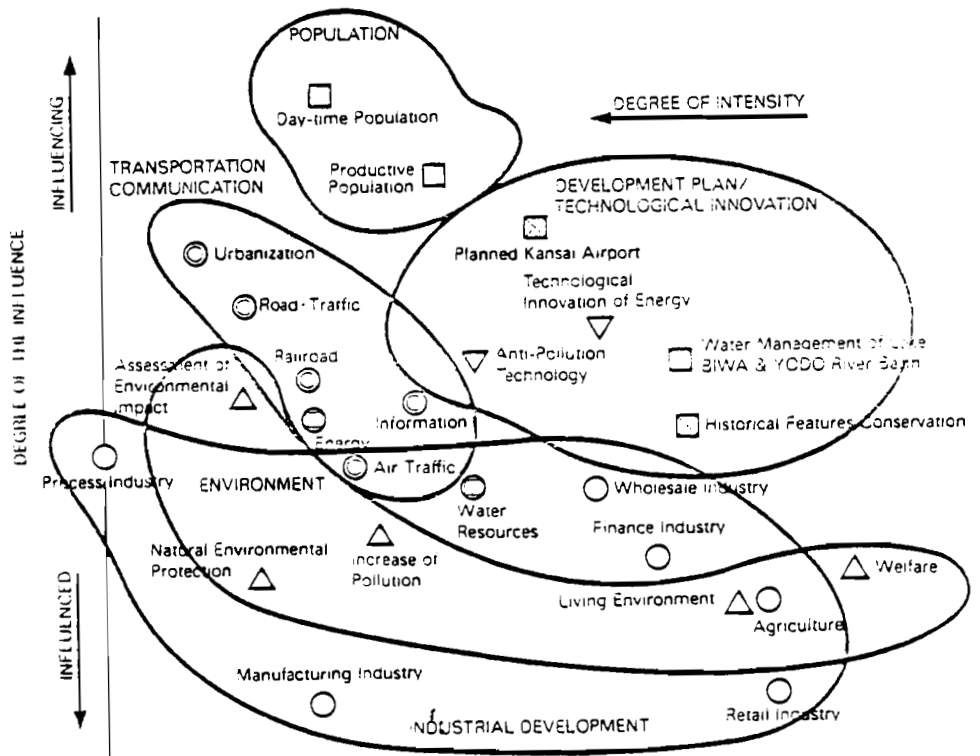

Figure 16. Relationships among regional problems.

Source: [11].

(i). The IRDP model must be based on the regional economic framework, as we have empirically experienced, even if the impact of a project such as a new airport construction is to be assessed.

(ii). There seems to exist some kind of hierarchy among the regions. From this we suggest a network of interregional models as shown in Figure 17.

#### *Generation of Views on Future Regional Situations*

Before we get into the interregional model, a national level model and/or a whole region model is developed following the interpretation of the interregional structure during the structure identification process.

The whole-regional (country level) model [19, 20] and the subregional model [15] (prefecture level) are built based on the multiobjective linear-programming method as a research extension of the method applied to regional land-use planning [21].

A normative view of the country-level situation is now easily seen from the IBM 3270 terminal [22]. The model has undergone a restructuring based on the Kinki IRDPM [23] to give full interactive facility for good parameter setting.

#### *New Concepts of Regional Planning and Management*

Full interactive capability is put into the country level normative-planning model as an extension model of Kinki IRDPM [23]. The research objective is to give the planner a new dimension so that he can use the terminal to see the result of normative-planning simulation and change the parameter dynamically, as is done in the real policy-making environment.

The concept is an extension of the linear-programming version of surrogate worth trade-off being developed as a whole region model and a subregional model. Some soft constraints can be changed upon planner's request [19, 24, 25].

To resolve conflicts such as between the treatment cost and the degree of pollution, we usually try to find a solution that minimizes both. But we seldom have the full information required for the utility function that determines the preference attitude of the decision. For this kind of problem, ICOM (Interactive Coordinatewise Optimization Method) has been developed to seek for a regional conflict solution along the Yodo river basin [26, 27].

Another approach to the multiobjective problem is to obtain a multiattribute utility function starting from a preference hierarchy. This is also being applied to the Yodo river [28].

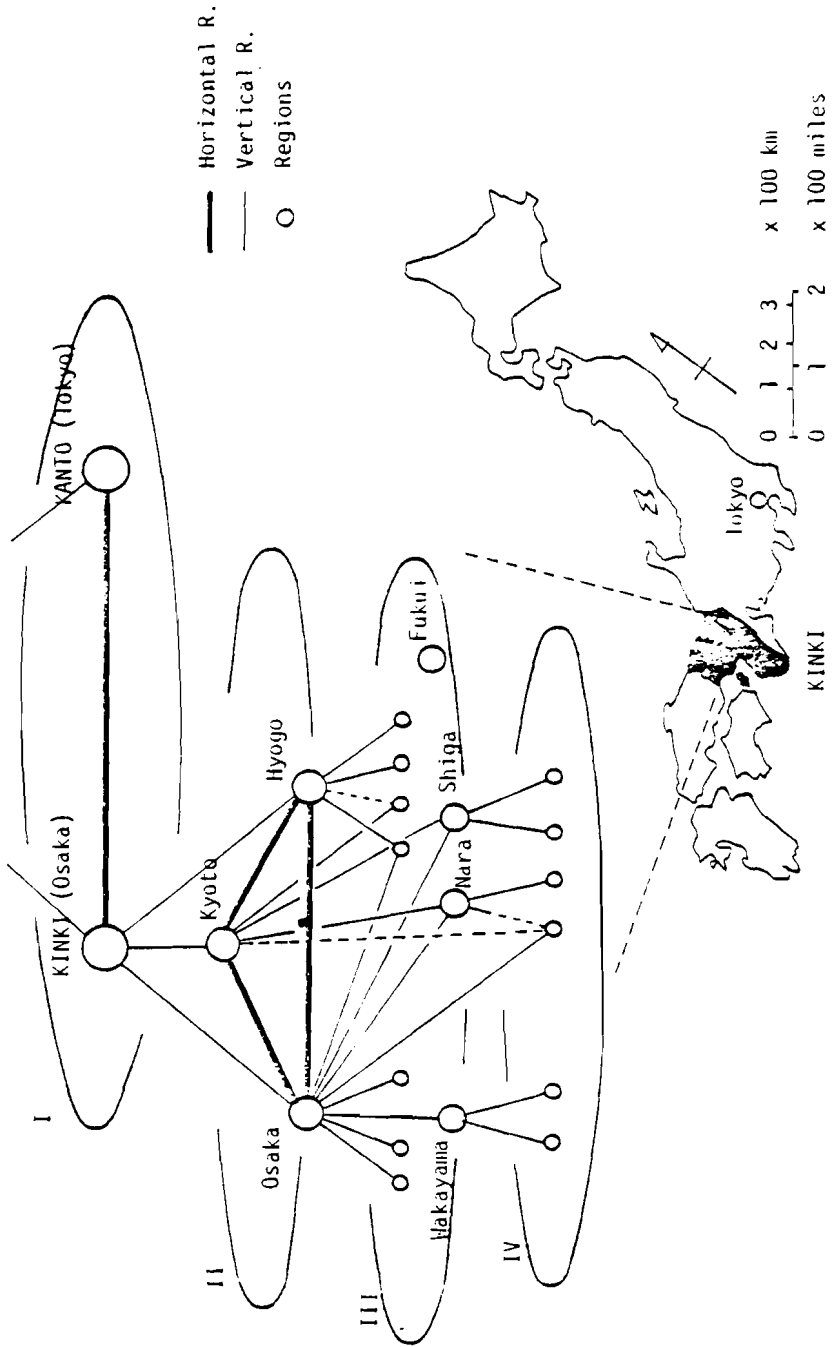

Figure 17. Network and its hierarchy of interregions.

*Functional Design and Feasibility Test of Systems Methodologies*

A new type of multiobjective optimization called ICOM is put into the IBM CALL/370 systems to encourage full interactive capability.

An experimental regional data base is built on IBM CALL/370 to handle seven prefectures in Kinki. Data are taken from various statistical books.

*Communication between Central and Local Administrative Authorities*

One of the most vital aspects of the socioeconomic system and the regional development program is the communication between researchers and decision-makers: central and local administrative authorities.

A positive effect could also be expected if a proper feedback is ensured for the two groups. To do this we have had workshops and/or invited lectures as tabulated in Figure 18.

## 7. CONCLUDING REMARKS

Figure 19 through to Figure 21 represent a conceptual picture of the Kinki IRDP research directions to drive individual researchers.

In the last half of the Kinki IRDP, the research activities are matrixed in four research groups by the research laboratory of each individual scholar. These four groups are:

- new Kansai airport assessment
- social indication and population dynamics
- resources (water and energy system)
- comprehensive plan.

We expect the Kinki IRDP research activities to be beneficial to academic societies and that research results should be fed back to the societies for the benefit of both regional inhabitants and societies.

## ACKNOWLEDGMENT

The authors wish to express their gratitude to Professor Nishikawa, who is acting as a project leader of the partnership in the Kinki IRDP, for his extensive effort in the cooperative research; also to Professor Sawaragi, Chairman of the Kinki IRDP and head of the research group on multiobjective systems, Japan Association of Automatic Control Engineers for his coordination of interdisciplinary research activities.

The authors would like to express their gratitude to all members of the Kinki IRDP project and the staff of Academic and Scientific Programs and Tokyo Scientific Center for their enthusiastic efforts to make the project happen.

National Land Agency

- Planning procedure of urban development
- Short-range plan of Kinki urban development
- Items to be evaluated for a long-range plan

Hyogo Prefectural Government

- Experiences obtained through the use of PIAS/CARPS

National Statistics Bureau, Prime Minister's Office

- Statistics of social indicators, Japanese version of SSDS, United Nations

Osaka Prefectural Government

- Roll of local government in IRDP

Tsukuba University

- Assessment methodologies of large scale development in regional planning
  
- Social indicators and its application

Figure 18. Communications with central/local authorities.

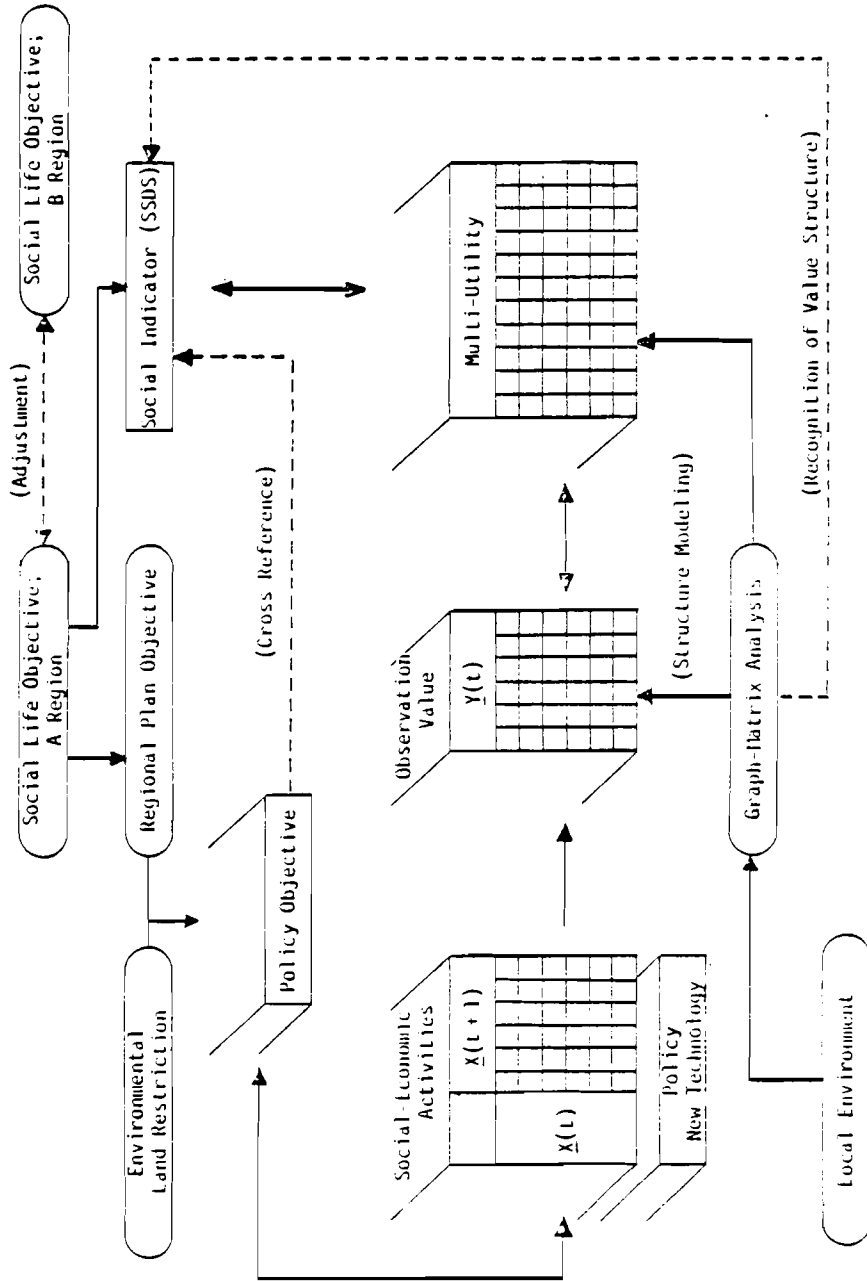

Figure 19. Interregional decision support model.

Source: [11].



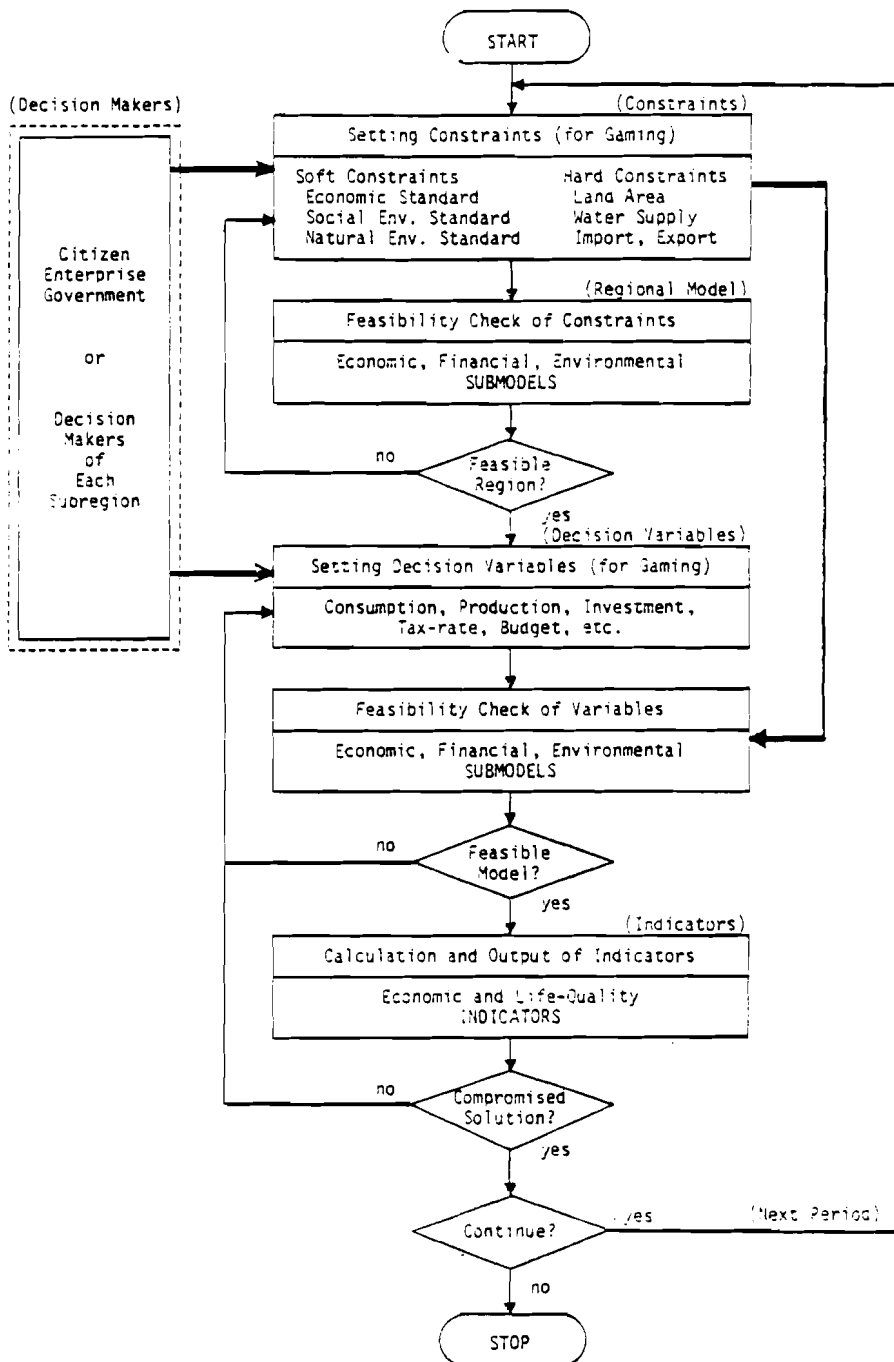

Figure 20. Flow-in decision simulation.

Source: [17].

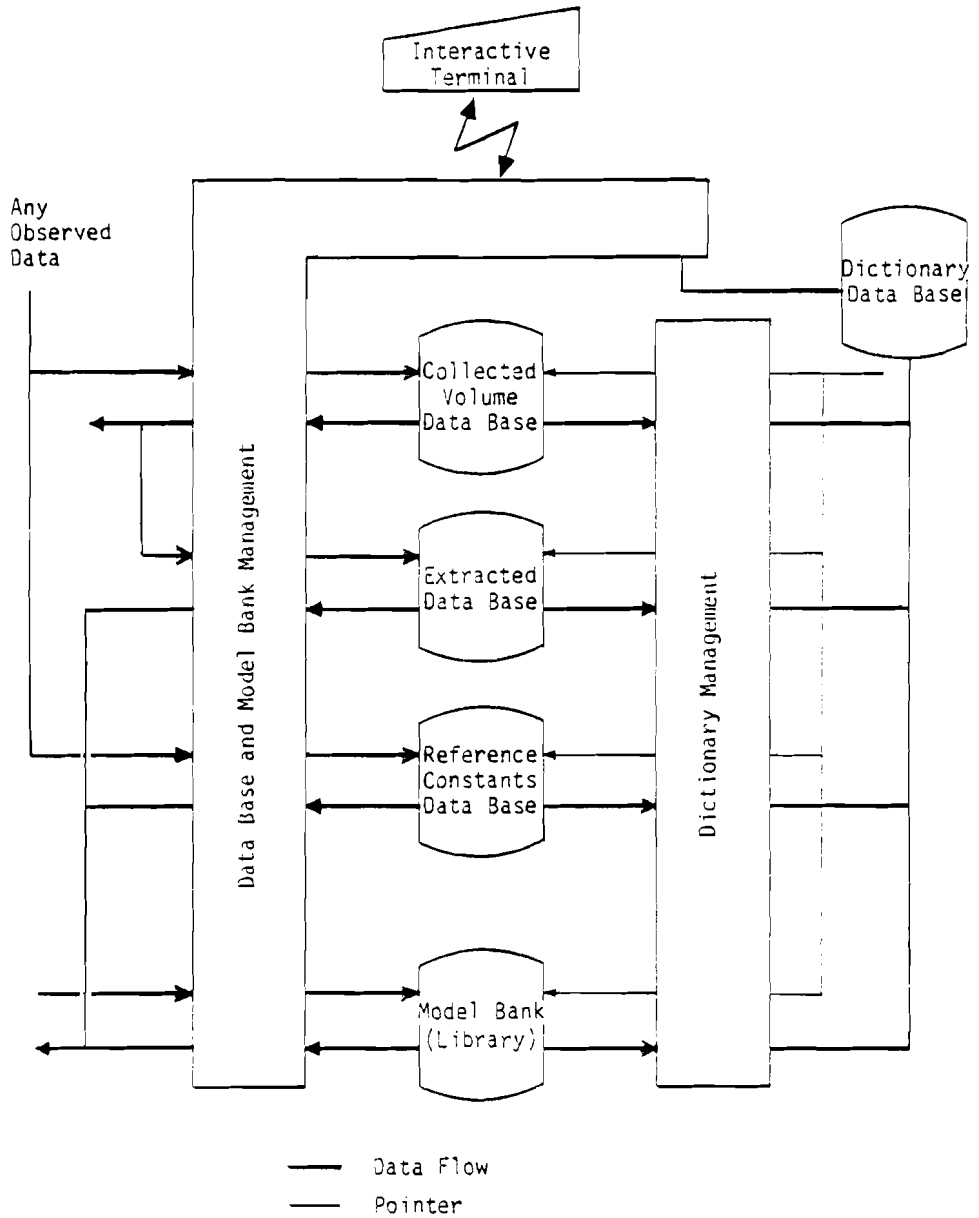

Figure 21. The IRDP data management concept.

Source: [17].

## REFERENCES

- [1] Air Pollution Prediction System Special Project Team, Hyogo Prefecture, et al. (1974). Research Report on Air Pollution Prediction. N:GE18-1806. Japan: IBM Japan, Tokyo Scientific Center (in Japanese).
- [2] Matsuzaki, T., M. Ohkohchi, M. Udo, and S. Ogasawara (1974) A System Approach to Prediction and Control of Air Pollution for the Local Government of Japan. N:GE18-1903. Japan: IBM Japan, Tokyo Scientific Center.
- [3] Matsuzaki, T. (1976) A computer systems approach to a regional development program for the local government of Japan. Pages 51-90 in Report of Research Activities on the Kinki Region of Japan. CP-76-10. Laxenburg, Austria: International Institute for Applied Systems Analysis.
- [4] Ohkohchi, M. (1973) ISSAP: Interactive Simulation System of Air Pollution. N:G318-0025. Japan: IBM Japan, Tokyo Scientific Center (in Japanese).
- [5] Matsuzaki, T., M. Ohkohchi, and M. Udo (1974) Hyogo Dynamics. GE18-1808. Japan: IBM Japan, Tokyo Scientific Center.
- [6] Matsuzaki, T., M. Ohkohchi, M. Udo, S. Ogasawara, et al. (1976) Computer Assisted Long Range Comprehensive Planning System. GE1811904. Japan, IBM Japan, Tokyo Scientific Center.
- [7] Ohkohchi, M., and M. Udo (1976) Computer Assisted Regional Development Planning System. GE18-1837. Japan: IBM Japan, Tokyo Scientific Center.
- [8] Ohkohchi, M., and M. Udo (1977) CARPS: Computer Assisted Regional Planning System. IFAC Symposium on Environmental Systems Planning, Design, and Control, Kyoto.
- [9] Planning Department, Osaka Prefectural Government (1976) Report on Ultra Long Range Forecasting of Osaka Prefecture-Osaka Dynamics Model (in Japanese).
- [10] Matsuzaki, T., and S. Toyohara (1978) A Challenge to a Long Range Planning System Models. IBM Review (to appear) Japan: IBM Japan (in Japanese).
- [11] What is the Kinki IRDP (1977). Japan: IBM Japan.
- [12] Environment Agency (1975) Total Emission Control Manual for Air Pollution Abatement.
- [13] Hyogo Prefecture. Atarashii Chiiki-Zukuri no Tameni (For the Development of New Regional Community and Society) (in Japanese).

- [14] Hyogo Prefecture (1975) 21 Seiki e no Seikatsu-Bunka-Shakai Keikaku (Long Range Comprehensive Planning Towards the 21 Century) (in Japanese).
- [15] Yukawa, H. (1977) A Regional Economic Model Under Inter-Prefecture Connection. Dissertation for B.Sc. Degree. Kyoto University (in Japanese).
- [16] The Third Comprehensive Development Plan of the Nation (1977). Japan: Government Printing Office (in Japanese).
- [17] Nishikawa, Y., A. Udo, T. Takehara, T. Matsuzaki, and T. Aina (1977) On Kinki IRD partnership program. Pages 1-38 in The Proceedings of the First Kinki IRDP Workshop. GE18-1865. Japan: IBM Japan, Tokyo Scientific Center.
- [18] Miyazaki, H., Y. Eguchi, Y. Nishikawa, A. Udo, T. Matsuzaki, and T. Aina (1977) A trial of identifying regional problem structure by DEMATEL. Pages 39-60 in The Proceedings of the First Kinki IRDP Workshop. GE18-1865. Japan: IBM Japan, Tokyo Scientific Center. Also in this volume.
- [19] Nishikawa, Y., N. Sannomiya, A. Udo, and T. Takehara (1978) A Multiobjective Mathematical Programming Methodology and its Application to Social Planning Models. Workshop on Kinki IRDP, June 1978, International Institute for Applied Systems Analysis, Laxenburg, Austria. Also in this volume.
- [20] Seo, F., and M. Sakawa (1977) An evaluation method for environmental systems analysis: utility approach. Pages 301-344 in The Proceedings of the First Kinki IRDP Workshop. GE18-1865. Japan: IBM Japan, Tokyo Scientific Center.
- [21] Nishikawa, Y., N. Sannomiya, N. Maeda, and T. Kitamura (1977) Multiobjective linear programming model as applied to regional land use planning. Pages 131-138 in The Proceedings of the First Kinki IRDP Workshop. GE18-1865. Japan: IBM Japan, Tokyo Scientific Center.
- [22] Ito, K., T. Aina, K. Shoji, and Y. Suzuki (1977) A man-machine interactive approach to an integrated regional development planning problem. Pages 231-256 in The Proceedings of the First Kinki IRDP Workshop. GE18-1865. Japan: IBM Japan, Tokyo Scientific Center.
- [23] Suzuki, Y., H. Ishitani, and K. Shoji (1977) The Kinki model directed to ultra long term integrated regional development planning. Pages 61-108 in The Proceedings of the First Kinki IRDP Workshop. GE18-1865. Japan: IBM Japan, Tokyo Scientific Center.
- [24] Takehara, T. (1977) Macro Social System Model as a Planning Support. Dissertation for M.Sc. Degree. Kyoto University (in Japanese).

- [25] Udo, M., T. Matsuzaki, M. Ohkohchi, M. Takabatake, H. Miyazaki, Y. Eguchi, and S. Kawasaki (1976) The Role of the Computer Assisted Regional Development Planning System for Environmental Planning. Paper presented at 1st International Symposium on Industrial Waste and Environment, 14-19 November 1976, Caracas, Venezuela.
- [26] Nakayama, H., K. Inoue, and Y. Sawaragi (1978) An Assessment of the Residential Environment in Kyoto City; A Trial Toward Group Decision. Workshop on Kinki IRDP, June 1978, International Institute for Applied Systems Analysis, Laxenburg, Austria. Also in this volume.
- [27] Sawaragi, Y., S. Ikeda, H. Nakayama, T. Tamino, and C. Okumura (1977) An interactive optimization method for a water resource problem with multiple objectives. Pages 223-230 in The Proceedings of the First Kinki IRDP Workshop. GE18-1865. Japan: IBM Japan, Tokyo Scientific Center.
- [28] Seo, F., K. Nakagami, and H. Horiyama (1977) Multiattribute utility analysis for water resources program in the Yodo river basin. Pages 257-288 in The Proceedings of the First Kinki IRDP Workshop. GE18-1865. Japan: IBM Japan, Tokyo Scientific Center.

IDENTIFYING A REGIONAL PROBLEM STRUCTURE BY DEMATEL:  
A TRIAL

H. Miyazaki and Y. Eguchi  
*Planning Department, Hyogo Prefecture, Kobe, Japan*

Y. Nishikawa and A. Udo  
*Department of Electrical Engineering, Kyoto University,  
Kyoto, Japan*

T. Matsuzaki and T. Ainai  
*Tokyo Scientific Center, IBM Japan, Tokyo, Japan*

ABSTRACT

The method of DEMATEL (Decision Making Trial and Evaluation Laboratory) was applied to identifying an integrated regional development problem structure, with Hyogo prefecture in Kinki, Japan, as the sample region. The prefecture is divided into six subregions according to their characters, and the aim of the trial was to identify the structure of the intraprefectural problématique, as well as that existing in connection with six regions outside the Hyogo prefecture.

1. INTRODUCTION

This report is concerned with the procedure and the results of an experimental trial of application of the DEMATEL technique [1], for the identification of integrated regional problem structure in Hyogo prefecture, Kinki, Japan.

The experiment was initiated to explore new dimensions of methodologies in the course of our Kinki IRDP (Integrated Regional Development Program) and was motivated as follows.

- The problem interdependency and complexity existing in the Kinki region are shown in Table 1.
- Most of the basic problems lie beyond administrative boundaries (prefectural boundaries) and are interdependent with each other, in various patterns.
- The nature of every problem implies the need for interdisciplinary investigation.

Table 1. Interdependencies of the Kinki intrarregional problématique.

	Hyogo	Osaka	Kyoto	Shiga	Wakayama	Nara	Fukui
Hyogo		Industrial Activity Labor Transportation	Water	Water			Electricity
Osaka	Industrial Activity Urbanization Transportation		Industrial Activity Urbanization Environment	Industrial Activity Urbanization	Industrial Activity Urbanization	Industrial Activity	Industrial Activity Electricity
Kyoto		Environment		Urbanization			Electricity
Shiga	Water	Water	Water				
Wakayama		Industrial Activity Transportation					
Nara					Urbanization Transportation		
Fukui							Electricity Electricity

Source: [2].

The purpose of the present work is:

- to investigate the applicability and effectiveness, and, at the same time, drawbacks of the DEMATEL technique in the IRDP study
- to use DEMATEL as a tool for promoting IRDP study from an administrative or project management aspect.

The first question, the effectiveness of the method, is to be investigated from various viewpoints such as:

- whether it is useful for quick and easy generation of insight into the region
- whether it is effective for visual grasp of structure of the regional problématique
- whether it is feasible for simplification and breakdown of the regional problématique for further IRDP studies such as the building of a quantitative model
- whether it is acceptable for the people outside the systems approach group, such as the people in local government.

The second question on usefulness as a project management tool is raised in connection with the following considerations:

- it is important to get some common view of the present problématique and a decision on the future goal by the associated researchers
- it is then necessary to obtain a consensus on how to proceed with the project, referring to the hierarchical picture obtained above.

The study has been conducted by a group consisting of four systems analysts and some staff of the Planning Department of Hyogo prefecture. Hyogo prefecture has been chosen as the sample region because, first, the staff have been much interested and are experienced in systems approaches to regional problems, and second, Hyogo prefecture is a kind of epitome of the Kinki region or even of the whole of Japan in societal characters, e.g., Hyogo prefecture has very dense and industrialized parts as well as very sparse and less-developed parts in the prefecture.

## 2. A PROFILE OF HYOGO PREFECTURE

Hyogo prefecture is located just west of the geographical center of the mainland (called "Honshu") Japan and belongs to the Kinki region. From the north and south it is bounded by coastlines of the Japan Sea and the Seto Inland Sea, respectively. The east extends to and is bounded by the Osaka and Kyoto prefectures, and the west by the Chugoku region (see Figure 1).

Some statistical details are listed in Table 2. Hyogo is the 12th in area in Japan (the 1st in the Kinki region), the 6th in population (the 2nd in Kinki) and in the field of industrial activities it is the top or the second in iron and steel, transport equipment and in food products. The growing problématique



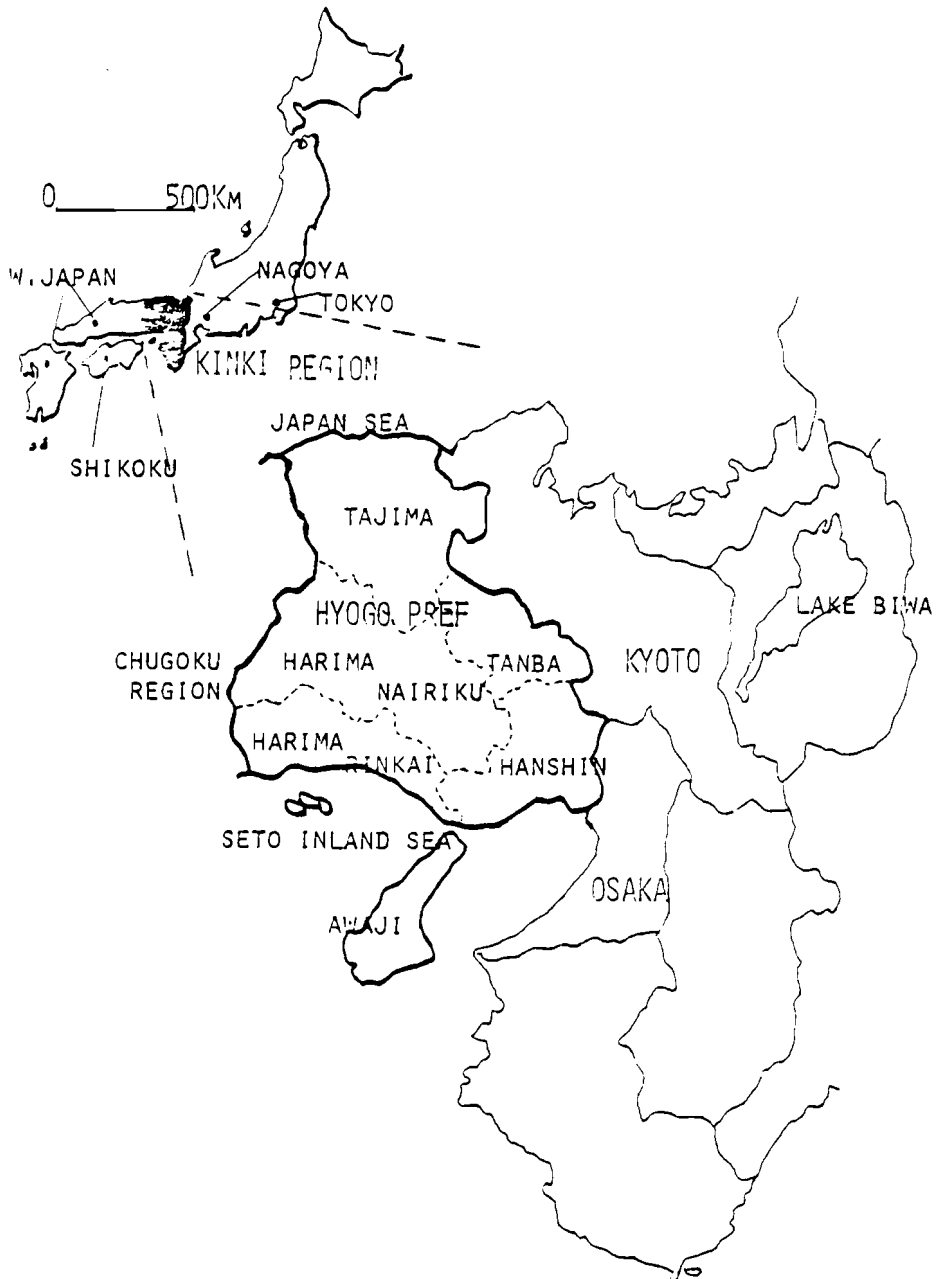

Figure 1. Hyogo prefecture and Kinki region.

Table 2. Profile of Hyogo prefecture.

AREA (10 January 1976)	8,365.16 km <sup>2</sup>
AREA OF CITIES	2,580.30 km <sup>2</sup>
POPULATION (8 January 1976)	5,024,862
POPULATION OF CITIES	4,222,698
FARMHOUSE HOLDS (2 January 1975)	167,892
CATCHES OF FISHERIES	121,492 t
TRADE	
Number of Stores	111,968
Persons Employed	448,440
Annual Sales	789.31 x 10 <sup>9</sup>
MANUFACTURING	
Number of Establishments	30,636
Persons Employed	570,972
Value of Shipments	¥ 750,031 x 10 <sup>9</sup>

Source [5].

has rapidly appeared because of rapid urbanization along the south coastline due to pulling population out of the rural districts as shown in Figures 2 and 3. The urbanization and industrialization to the extent of its physical and/or environmental limits calls for an advanced IRDP approach to cope with comprehensive programs associated with the physical environmental problématique in order to give regional inhabitants a brighter future.

On the other hand, Hyogo prefecture has had an intensive attitude towards a systems approach ("Kyogo Dynamics"[3]) for long-range comprehensive planning and "PIAS/CARPS"[4] for a regional development planning system as a means for social coordination. However, the prefecture is still looking for a new practical methodology and/or approach that can be applied at the prefecture-level planning.

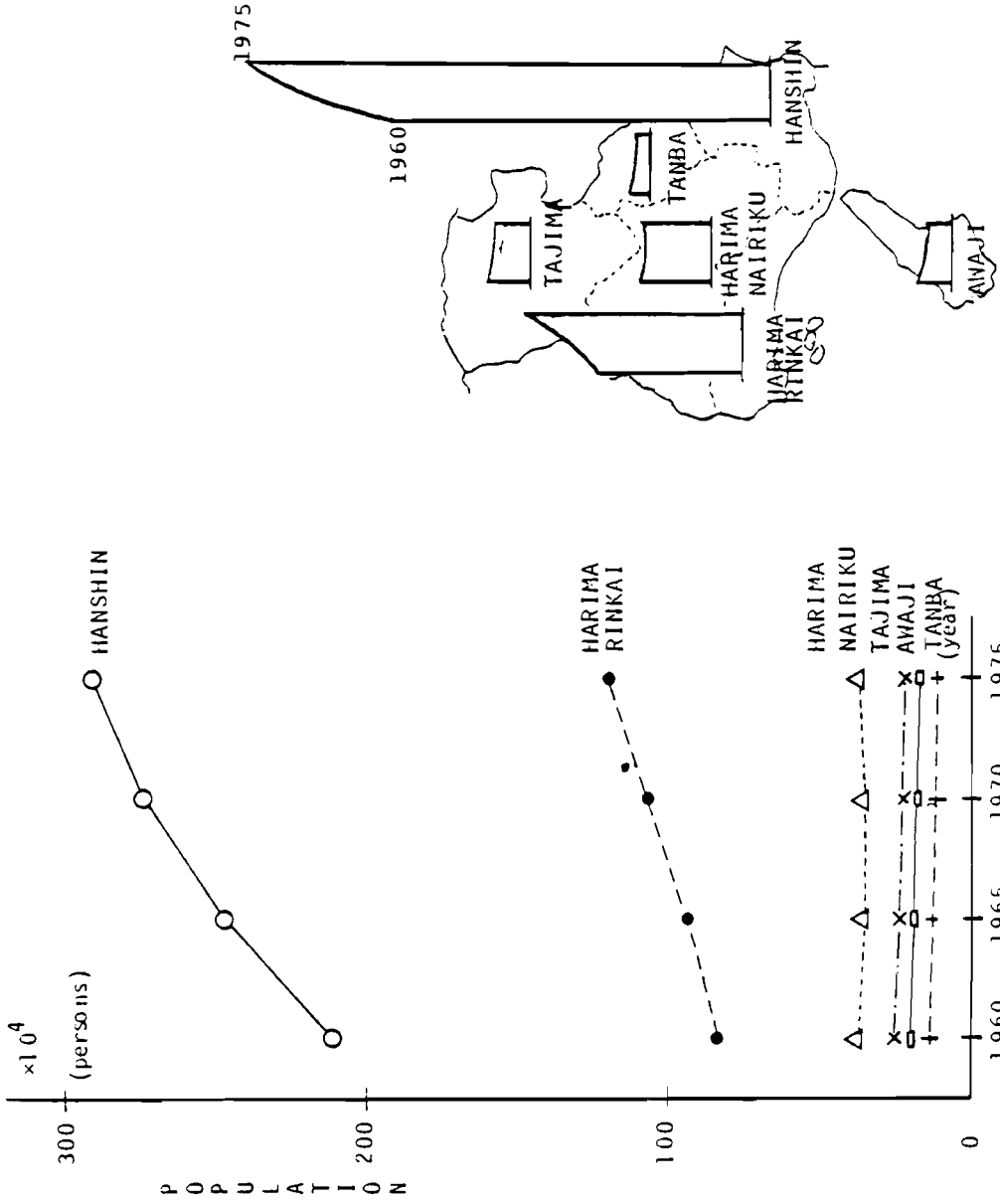

Figure 2. Population within Hyogo prefecture.

Figure 3. Biased Population distribution.

### 3. SELECTION OF APPLICATION AND PURPOSE OF STUDY

The Hyogo prefecture staff, having practical experience in regional planning, expect DEMATEL to be employed as a methodology for practical planning if it is proven to work successfully. But why this kind of expectation has been raised should first be explained.

Since the experience of the so-called oil shock in 1973, many plans have had to be reviewed and be modified in the Hyogo prefecture, as in many other prefectures and in Japanese central government, over the entire planning horizon. And the capacity of the natural environment, subjected to increasing pollution emitted by industrial activity and urban life, together with the shortage of natural resources, especially that of energy resources, has become a dominant factor that is considered to constrain economic growth as described by the GNP.

Therefore, various symptoms such as environmental pollution, destruction of the natural ecological system and natural beauty, lack of livelihood and capital stock, and unbalanced allocation of population and economic activities, attract the attention of planning staff as well as regional inhabitants. Further, a disturbing picture is also forecasted by the results of simulation runs with Hyogo Dynamics. These phenomena inevitably cause people to reconsider the mechanism of the planning process itself.

Specifically in Hyogo prefecture, the following seems to happen [6] and it is considered that it cannot be resolved independently:

- continuing increase of various pollutants resulting in complete destruction of living environment
- water shortage in the urban areas
- decrease of food supply capability
- severe traffic congestion
- uneven and excessive concentration of urbanization
- shift to aged society.

A planning alternative obtained through careful investigation of the problem is an attempt at the decentralization of urbanization and/or industrialization as follows

(i). Each block, that is each region in Hyogo prefecture should be developed in such a manner that a preferable and consistent balance among land-use policy, regional environmental plans, water and energy usage, etc., can be kept.

(ii). Utility obtained in each block should be well balanced with others throughout the prefecture.

The strategy search of this kind, as a step towards an integrated regional development plan, would be likely to call for two different approaches simultaneously, that is:

(i). A top down planning procedure that decides, qualitatively and quantitatively, the roles of individual blocks in meeting the overall prefectural goal.

(ii). A bottom up planning procedure that starts with regional inhabitant's or local-community-level goals and then coordinates them toward the prefectural goal.

But the real headache of the decision-maker and the planning staff is how to identify the relationships across the blocks and also across the various sorts of attributes such as industrialization, urbanization, pollution, etc., without full support of real data and well established theories. It is because the collection of data and establishment of theories are very time-consuming, while in most practical situations there is not time enough to work on them before the plans are developed. This explains why graph-matrix techniques like DEMATEL are needed and where expectations for those techniques have come from.

Summarizing the above discussion, the principal aims of application of DEMATEL (or other similar techniques) are:

- a clear structural identification of comprehensive inter-/intraregional problématique
- a step toward a quantitative modeling such as an economic model or a system dynamics model
- room for nonprofessional people to participate in the quantitation of qualitative description
- goal structure setting with appraisal criteria.

#### 4. PROCESS OF DEMATEL APPLICATION

##### 4.1. Creation of Matrix Elements

In order to see the internal structure of Hyogo prefecture, the prefecture is divided into six subregions, that is, Hanshin, Harima Rinkai, Harima Nairiku, Tajima, Tanba, and Awaji according to their regional character. Their geometrical configurations are indicated in Figure 1. The aim is to clarify their relative socioeconomic positions on the scale of the entire prefecture, and on that of the whole of Japan as well. Outside Hyogo, six regions of relative importance are considered. They are Osaka prefecture, Kyoto prefecture, Nagoya district, Tokyo district, Western Japan (i.e., Chugoku and Kyushu), and Shikoku Island.

In each region or subregion, the following nine attributes are picked out for consideration: population, industrialization, trade (domestic), agriculture, urbanization, capacity of water supply and/or demand, ability of electric power for supply and demand, demand for transportation, and environmental pollution. These attributes are considered to be useful for better characterization of individual regions.

We should have added other attributes closely related to a specific project or a particular interest such as water management of Lake Biwa and its river basin, the planned new Kansai airport, etc., but we disregard them because of the treatable size of matrix and the desire to avoid confusion in the interpretation of the results by diversity of attributes.

#### 4.2. Generation of the Direct Matrix

Our approach is not exactly the same as the original DEMATEL developed by the BATTELLE group [1] or others [7]. The reason behind this is simple. We have not had time enough to prepare a well-organized questionnaire. Instead, we listed all regions and attributes on the same spot and filled in each matrix entry the discussing the degree of dependencies of each attribute on others.

By proceeding in this way, a value score given in each matrix comes to a representation of averaged results from participants, that is, it could be almost equivalent to the statistical mean of individual evaluations. On the other hand, however, it is time consuming and, moreover, the participants are not able to cope with the completion of all entries.

The value score of the entries was planned to range from -3 to +3. The negative score has rarely been used although participants thought it would be helpful to distinguish relations as follows: an increase (positive score) in environmental pollution will reduce (negative score) the population of subject region although industrial activities will attract (positive score) the people into the region which in turn will worsen (positive score) the environmental pollution.

After some trials of the filling out procedure, we have come to an agreement not to use the negative score. Instead, by making clear the positive or negative meaning of each attribute itself explicitly, we have been able to avoid confusion of sign at every step of filling out and/or interpreting the matrix entries. However, we have to put slight restrictions on the interpretation of the entire matrix since the sign varies according to the time concerned. Hence we have set a time axis; whether the matrix shows the past of the inter-/intraregion, or a future expectation or expected trends, etc., and the present picture is shown in the trial.

#### 4.3. Computation

The completed matrix of 54 x 54 (Table 3) for inside Hyogo and 108 x 108 for inside and outside Hyogo have been computed by the DEMATEL program developed by A. Udo from the RJE service of IBM Japan.

### 5. INTERPRETATION OF RESULTS

In this section, we summarize some interpretations of the results of our DEMATEL study. The DEMATEL study itself is just the first trial on this problématique, hence the results and interpretations are not to be considered as the final ones.

Table 3. Hyogo intraprefecture DEMATEL direct matrix.

		HANSHIN	HARIMA RINKAI	HARIMA NAIRIKU	TAJIMA	TANBA	AWAJI
		123456789	123456789	123456789	123456789	123456789	123456789
HANSHIN	1	023133333	200022220	100022010	100000010	100000010	100200010
	2	202223333	220100322	110110000	012200000	000000000	000000022
	3	220122232	210000120	020001010	000000000	000000000	001000020
	4	000020001	000000000	000000000	000000000	000000000	000000000
	5	303302223	100121221	200112000	000000000	000000000	000000000
	6	000000000	000100002	000102000	000000000	000002000	000000000
	7	000000000	000000312	000000000	000000000	000000000	000000000
	8	100000103	111010122	000000011	000000000	000000000	000000010
	9	221312120	220221002	220020001	010000000	020000000	000000002
HARIMA RINKAI	1	100000000	023133333	212012011	000000010		100200010
	2	120000021	202223333	120002022	010000000		000000022
	3	000000010	220122232	000000010	000000000		001000020
	4	000000000	000020001	001000000	000000000		000000000
	5	000000010	303302223	000000000	000000000	0	000000000
	6	000000000	000000000	000003000	000000000		000000000
	7	000000200	000000000	010010001	000000100		000000000
	8	000000010	100000103	000000021	000000000		000000010
	9	000000001	221312120	100000001	000000000		000000002
HARIMA NAIRIKU	1	102000010	001010110	021100000			
	2	011000011	010000100	101011221			
	3	000000000	000000000	000000010			
	4	000000000	000000000	000000000			
	5	000000000	000000000	000001111	0	0	0
	6	000000000	110001000	000000000			
	7	000000000	000000100	000000000			
	8	000000020	000000010	000000001			
	9	000000001	000000001	000000000			
TAJIMA	1	100000000	100000000		001100000		
	2	000000000	010000000		000000111		
	3	000000000	000000000		000000000		
	4	000000000	000000000		000000000		
	5	000000000	000000000	0	000000111	0	0
	6	000000000	000000000		000000000		
	7	000000000	000000000		000000000		
	8	000000010	000000010		000000001		
	9	000000000	000000000		000000000		
TANBA	1	100000000	100000000			000110000	
	2	000000000	000000000			000000111	
	3	000000000	000000000			000000000	
	4	000000000	000000000			000000000	
	5	000000000	000000000	0	0	000000111	0
	6	000000000	000000000			000000000	
	7	000000000	000000000			000000000	
	8	000000000	000000000			000000001	
	9	000000000	000000000			000000000	
AWAJI	1	100000000	100000000				001000000
	2	000000010	000000010				000011111
	3	000000000	000000000				000000000
	4	000000010	000000000				000001011
	5	000000000	000000000	0	0	0	000001001
	6	000000000	000000000				000000000
	7	000000000	000000000				000000000
	8	000000010	000000010				000000001
	9	000000000	000000000				000000000

1. Population      2. Industrialization      3. Trade(domestic)  
 4. Agriculture      5. Urbanization      6. Capacity of Water Supply and/  
 or Demand      7. Ability of Electric Power Supply and Demand  
 8. Demand for Transportation      9. Environmental Pollution

### 5.1. Hyogo intraprefecture problématique (see Figure 4)

(i). In all subregions, the industrial activity is the leading element, that is, the element that has a dominant influence over the other elements and is strongly interconnected with the other elements. In other words, the so-called industry-oriented development pattern is common to all the subregions. That is to say, the industrial activity attracts the population into the region, which in turn causes the urbanization and increase in the trade accompanied by increase in the water and electric power demands. It also stimulates the demand for transportation and demolishes the agricultural activity, and further leads to the deterioration of the environment. This is the typical process of regional change conceived by the people.

(ii). The six subregions can be divided into two groups: the industrialized and urbanized groups of Hanshin and Harima Rinkai, and the rural and less economically developed group of Tajima, Tanba, Hanshin Nairiku, and Awaji. Interactions or interdependencies between these two groups seem not to be strong, and the scores given to the latter group are generally low. This could mean that, in our minds, societal problématiques in highly developed areas are still much more strongly conceived relative to those in less-developed areas, even though nowadays we stress the importance of developing rural areas in connection with urbanized areas.

(iii). In the urbanized areas of Hanshin and Harima Rinkai, the environmental pollution loads are becoming a limiting constraint for additional extension of the industrial activity. However, among the rural areas such as Tajima, Tanba, and Harima Nairiku it seems that space is still available for further industrial development.

(iv). The elements of agricultural activity, water resources, and electric power resources are relatively isolated. The agricultural activity seems, by its very nature in Hyogo, rather independent of the other activities. Isolation of the water and power resources could be interpreted as suggesting a well-balanced utilization of those resources at present, and possibly in the near future, in Hyogo as a whole.

### 5.2. Interrelations Between Hyogo and Outside Regions (see Figure 5)

(i). According to our results, only the well developed subregions, that is, Hanshin and Harima Rinkai would be thought of when discussing the interrelations with outside regions. The results suggest the adoption of a hierarchical structure as depicted in Figure 6 for further development of IRDP.

(ii). Hyogo is interconnected most strongly to Osaka, and then Tokyo, Kyoto, Nagoya, and so on. This is quite suggestive for defining some kind of gravity distances based on the geometrical distance, social size of the regions, volume of the interregional flow and so forth.



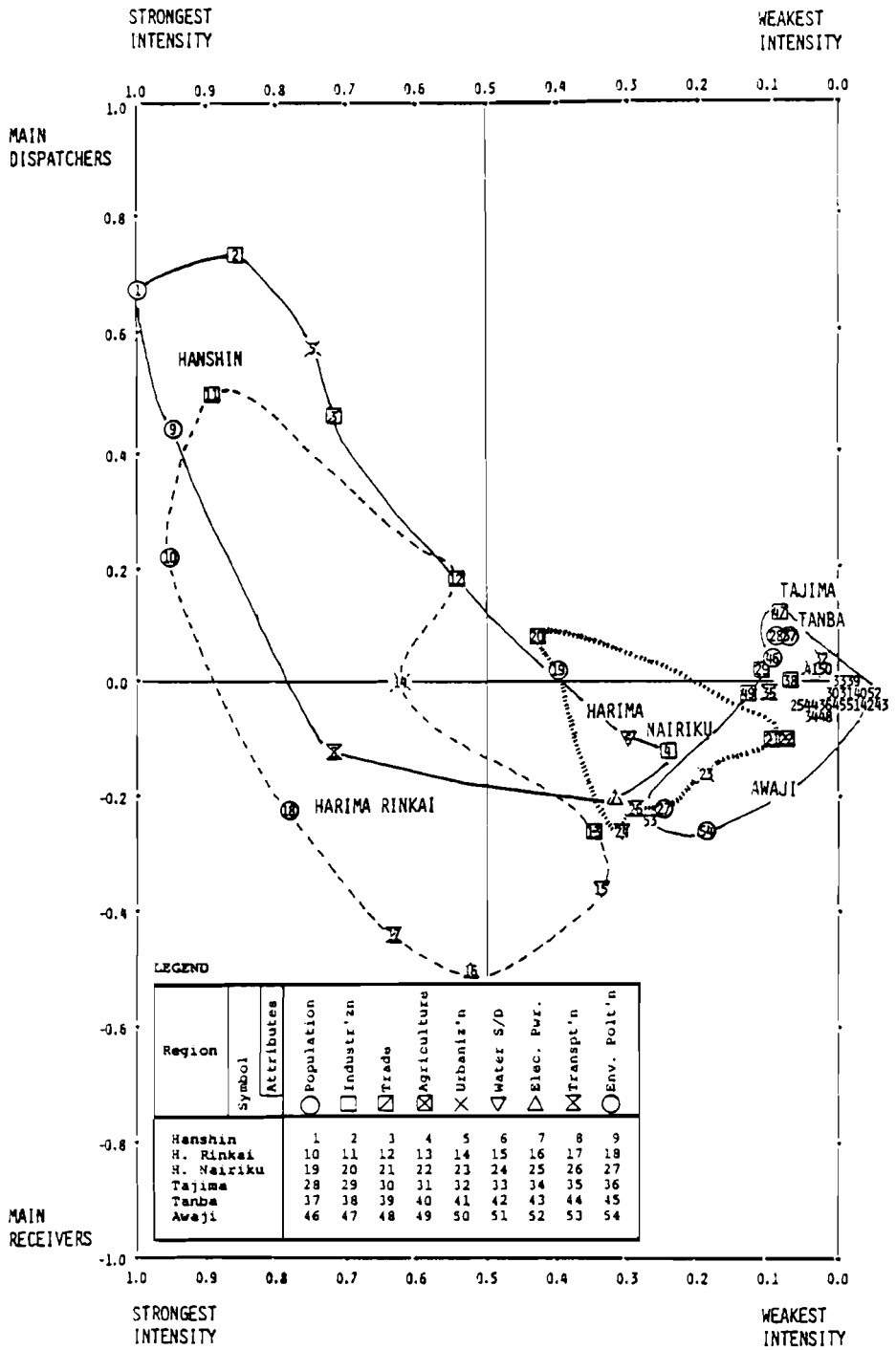

Figure 4. Hyogo intraprefecture problématique.

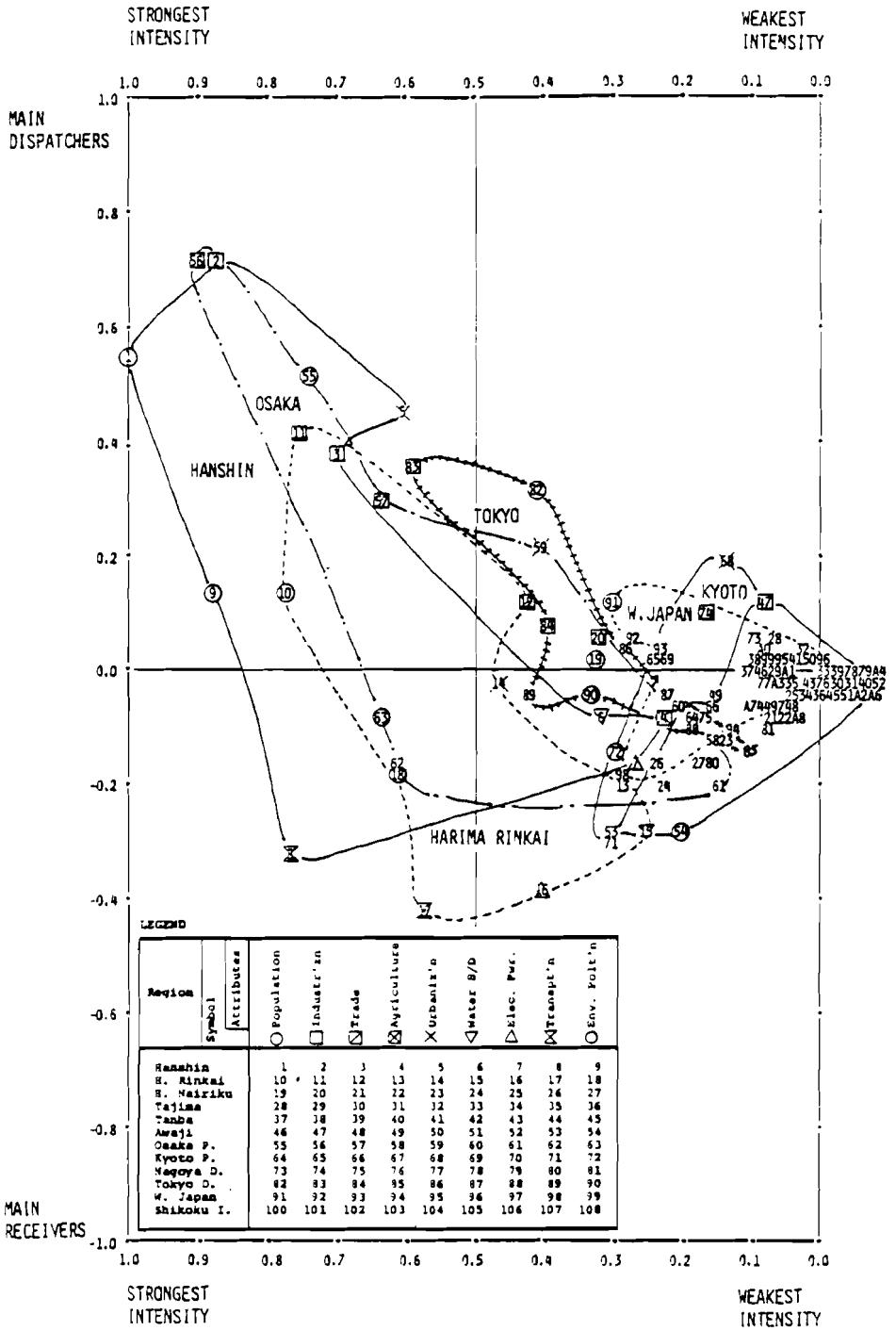

Figure 5. Hyogo intra-/interprefecture problématique.

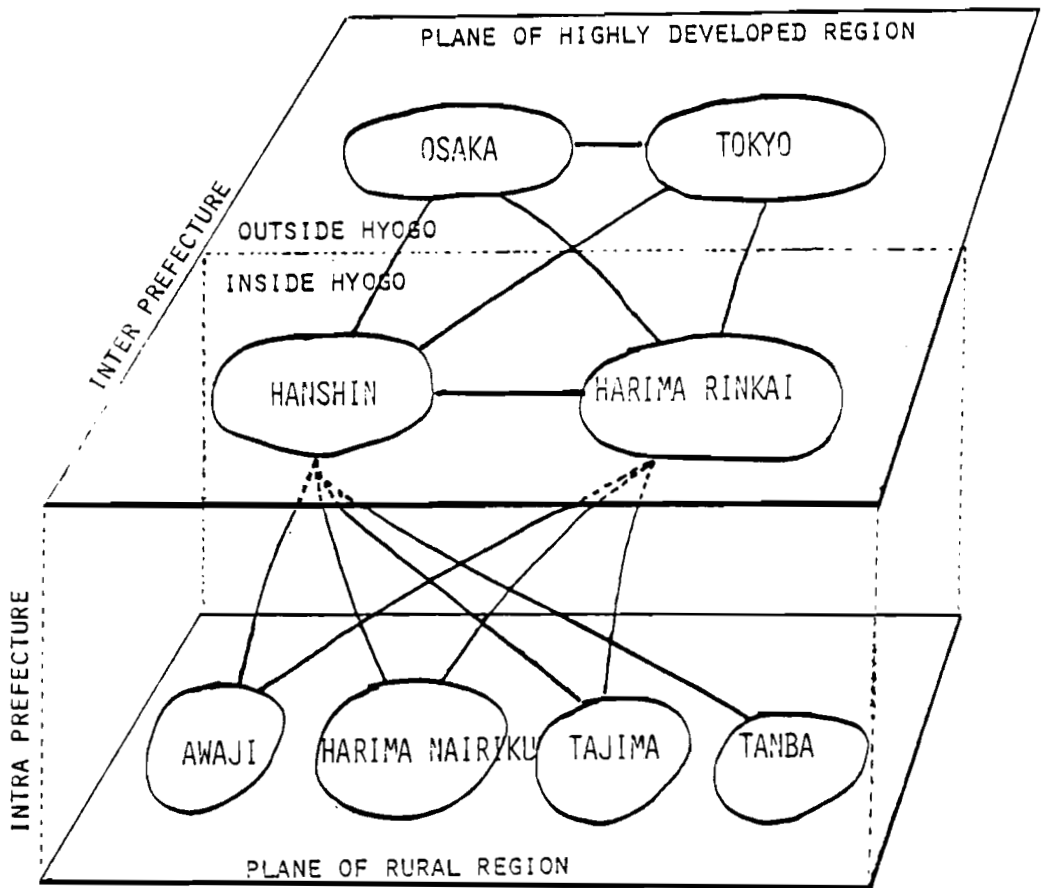

Figure 6. Suggested hierarchy of the IRDP.

## 6. REMARKS ON THE DEMATEL APPROACH TO IRDP

The concluding remarks at this stage of our DEMATEL approach to the regional problématique are as follows.

- (i). A hierarchical classification of regions based on industrial capacity or economic power would be helpful to give a basis for IRDP research, even if the principal goal of the research is to seek for a way of attaining regional amenities. It will give a sound insight for considering the structure of a regional model of any kind.
- (ii). In future planning of the region, not only the overall efficiency of the region but also subregional features and goals should be taken into account. In other words, decentralized functions for planning and decision-making should be more stressed. Although we have not completely succeeded in our present experiment to abstract notable local features at subregion level, a DEMATEL or similar approach will be fruitful from the viewpoint of local government or local inhabitants for attaining the aim mentioned above. In our future study by DEMATEL, some attributes directly related to social welfare and quality of life will be considered more explicitly.
- (iii). The DEMATEL approach is rather simple to work with in comparison with approaches based on accumulated real data. Although it has drawbacks in the sense of lack of complete objectiveness, it allows direct participation of various kinds of people in its working process. Through the DEMATEL process, we are able to reach an averaged picture of how to treat the problems of mutual concern, e.g., comprehensive planning problem, environmental assessment problem, or resources allocation problem.
- (iv). For public participation in a DEMATEL process, it might be helpful to prepare some kind of prescored matrix. Then the work will proceed iteratively by modifying the matrix according to people's view. Further an analysis of the sensitivity of the result to the scores will be meaningful, to help with the final decision on the scores.
- (v). Dealing with a large matrix is troublesome both for human beings (participants) and computers. Hence some technique, such as decomposition and coordination, is needed.

We have experimented with some other DEMATEL approaches to the problématiques in the whole Kinki region, Osaka prefecture, and Kyoto City. In each experiment the matrix elements have been selected from slightly different viewpoints, e.g., in the Osaka case the elements are cited as the key words in the documents for comprehensive prefectural planning, and in the Kyoto case they are the points of significant difficulty in urban management. The results and their comparisons will be reported in a separate paper.

## REFERENCES

- [1] Battele: DEMATEL Reports (1973).
- [2] Sawaragi, Y., et al. (1976) A Structural Identification and Estimation Method in a Complex Hierarchical System—Application of ISM and GMDH. N:GE18-1852. Tokyo: IBM Japan, Tokyo Scientific Center (in Japanese).
- [3] Matsuzaki, T., et al. (1974) Hyogo Dynamics—An Assisting Model for Long Range Comprehensive Planning. GE18-1808. Japan: IBM Japan, Tokyo Scientific Center.
- [4] Hyogo Prefectural Government Planning Department, Tokyo Scientific Center Environment Control Research Group: Regional Development Planning System (1976). N:GE18-1840. Japan: IBM Japan, Tokyo Scientific Center.
- [5] Statistics Department (1977) Hyogo Kensei Yoran (Statistical Profile of Hyogo Prefecture). Japan: Hyogo Prefecture, Statistics Department (in Japanese).
- 6 Hyogo Prefecture (1975) 21 Seiki e no Seikatsu-Bunka-Shakai Keikaku (Long Range Comprehensive Planning Towards the 21st Century). Japan: Hyogo Prefecture (in Japanese).
- 7 Murakoshi, T. (1977) Theories and Practice of Structure Identification for the Social Systems, Text for Systems Structure Modeling. Japan: SICE (in Japanese).

## THE KINKI MODEL DIRECTED TO ULTRA-LONG-TERM INTEGRATED REGIONAL DEVELOPMENT PLANNING

Y. Suzuki and K. Shoji  
*Department of Electrical Engineering, Osaka University,  
Osaka, Japan*

H. Ishitani  
*Institute of Space and Aeronautics, University of Tokyo,  
Tokyo, Japan*

### 1. INTRODUCTION

The project aims at building a model that can seek the ultra-long-term comprehensive development plan for the Kinki area. The model is expected to be utilized as a tool for regional socioeconomic policy planning. The fundamental aim of the regional development is to bring about better living conditions for the people. More abstractly, it is to improve people's well-being.

#### 1.1. Spatial Allocation of Industries and Population

It was believed until recently that better living conditions can be attained through an increase of income or consumption level. Therefore, the traditional regional developments were directed towards regional economic development, and the models constructed to devise development plans were almost always regional economic models. It is recognized now that economic growth does not always bring about better living conditions, and that concurrently brings about unwanted results such as congestion, depopulation, and environmental pollution. The congestion and the pollution result from excessive concentration of industries and population in specified areas, and the depopulation results from the reaction to this. Equitable and balanced utilization of the national land could eradicate these problems. In this sense, future regional development plans should have some spatial viewpoint on how to allocate the industries and the population to national land areas considering the scarcity of land and water and the limitation of environmental assimilating

capacity. The project directly deals with the allocation problem for industries and population in prefectures composing the Kinki area.

#### 1.2. Comprehensive Development of Social Capital

The regional allocation of industries and population should be accompanied by the development of necessary social capital. Generally speaking, it takes several years to develop the social capital. It is not rare to exceed ten years including the initial stages of planning. The traditional econometric method for regional planning models essentially makes an extrapolation of historical trends; their time span is usually taken around five to ten years. This project aims to attack the ultra-long-term comprehensive regional development, where the systematic development of necessary social capital is one of the central issues. This issue is outside the realm that is tractable by traditional methods. The model developed in this project not only intended to describe the historical socioeconomic trends faithfully, and then to extrapolate them; it is also constructed to be utilized as a tool, to help forward thinking on the long-term regional development problems with wide and flexible ideas. The regional development programs are raised from normative standpoints where desirable regional developments are sought in response to the expected future changes of various factors that are closely related to the development.

#### 1.3. Programming Model

The model is as a whole a programming model which seeks an optimum allocation of industries and population, although several economic descriptions such as the production functions and input-output tables are built in. The labor force, possible raw material import, usable land, maximum water supply and so forth are considered explicitly as the exogenous variables related to the regional development. Correlating with the fundamental aim of improving people's living conditions, several social indicators such as the income level and the satisfaction levels of various social capitals are calculated endogenously.

#### 1.4. Relation to National Development

In the regional planning models constructed so far the variables related to the outside of the specified region such as development plans for other regions, interregional migrations, and trades are usually given exogenously. Essentially the development of the specific region should be planned considering the correlation with other regions. The reasons why they cannot be treated independently come from the limits of man power, usable computer memory capacity, and computational time. In this project the development of the Kinki area is investigated with correlation to other regions dividing the Kinki area by prefectures and the outside of the Kinki by proper blocks. The limits of computer memory capacity and computational time are overcome by constructing the model hierarchically.

### 1.5. Support to Policy Planning

In this report some results of analysis by using the model are shown. However, as becomes clear through the precise description, the model contains a number of parameters that can be altered by model users according to their will. Hereafter we call these parameters "scenario parameters." The model structure is also very flexible. The user's image of the regional development can be described more clearly and easily through this model. Taking advantage of the majority of these characteristics, the model will become a powerful tool which supports the policy planning. The policy mentioned here has more abstract meaning than the usual one; a typical example is the comprehensive development of social capital. The policy of strategic levels such as the construction plan of a certain highway and its annual investment plan are not the objects of this model. For the analysis of this kind of policy, the traditional econometric approach will be much more efficient.

## 2. MODEL STRUCTURE AND PREMISES

### 2.1. Objectives of the Model

An abstract goal of improving people's standard of living can be translated into some more concrete objectives.

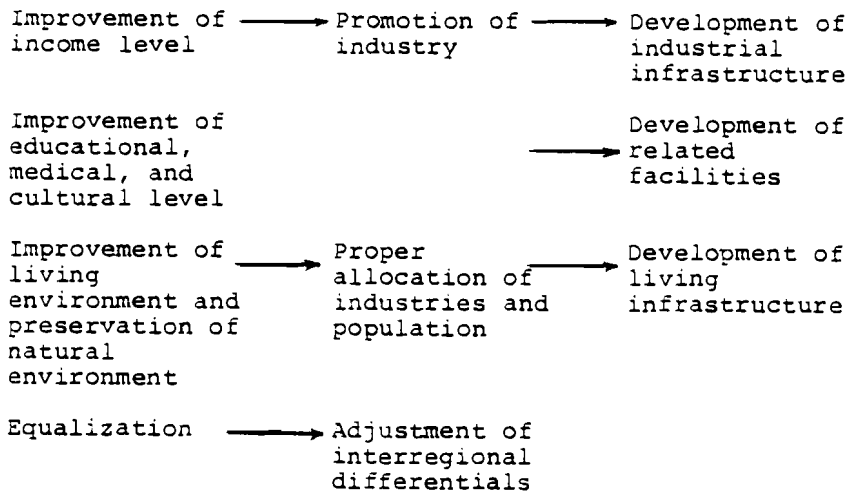

The arrows express logical chains between the objectives and the means to attain them. The terms in the middle will be called the indirect means to attain the objectives and the right-hand terms will be called the direct means; if we use more concrete terms, they are the investments for development. The causal chains are opposite to the above. For example, the development of industrial infrastructure stimulates the promotion of industries and this contributes to the improvement of income level. This model mainly deals with the problems related to indirect



means. The direct means for controlling the indirect ones and various influencing factors are treated as parameters in the model. Various social indicators closely related to objectives are also calculated from the model.

The user of the model can give the appropriate values of parameters in a certain development scenario and make a simulation run. Through this process he can analyze how much the development scenario contributes to the attainment of the objectives. The factors that are not expressed explicitly can also be included into the model implicitly in the form of a scenario. Executing these kinds of scenario analyses repeatedly will show which parameter is the most influential for the model behavior or which scenario is the most desirable for the development.

## 2.2. Fundamental Structure

Our model has the following characteristics.

Planning period	About 30 years
Age structure of population	Five age groups
Labor force participation rate	Five age groups
Industrial division	Agriculture, forestry and fisheries, chemical, basic metal, light manufacturing, metal and machinery, energy, transportation and communication, commerce, finance service and public service, construction, energy raw materials, structural raw materials
Social capital	
Economic overhead capital	Agriculture, forestry and fisheries, transportation and communication, land conservation
Social overhead capital	Dwelling, sewerage, water supply and environmental sanitation, parks and social sports facilities, social welfare facilities, education, medical care
Structure of private consumption	Food, beverages and tobacco, clothes and personal effects, fuel and light, rent and charge for water supply, furniture and other household equipment, household operation and maintenance, medical care and health expenses, transportation and communication, recreation and entertainment, education and miscellaneous services

Regional division	
Kinki area	Osaka, Hyogo, Kyoto, Nara, Wakayama, Shiga, Fukui
Outside of the Kinki area	Higashi Nippon, Kanto, Chubu, Chugoku, Shikoku, Kyushu
Transportation demand between regions	Indirectly considered
Physical constraints	
Land	
Water	
Environmental assimilation capacity	Indirectly considered
Constraint on resources	Import of energy raw material
Substitution between capital and labor	Indirectly considered
Technological progress	Indirectly considered

The social indicators calculated from the model are as follows [1].

Health	
Social condition for protection of health	Hospital beds per capita
Education	
Improvement and enhancement of primary and secondary education	Floor space of school buildings per pupil
Improvement and enhancement of higher education	Floor space of school buildings per student
Welfare	
Enjoyment of living and health of the aged	Accommodation rate of homes for the aged and aged welfare centers

Improvement of day nurseries and welfare facilities for physically and mentally handicapped children	Accommodation rate of children's welfare facilities
Athletics, culture and social education	
Condition for the healthy and cultural use of leisure	Sports facilities per capita, cultural and education facilities per capita
Living environment	
Living condition	Space of houses, water supply system, sewerage systems, rubbish and human waste disposal
Increase of parks in cities	City park area per capita
Decrease of damage from harmful and disagreeable substances	SO <sub>x</sub> , NO <sub>x</sub> , BOD
Income	
Income level	Income per capita

### 2.2.1. Hierarchical Model

It may easily be seen from the above description that if all these factors and interrelations are built into the model it becomes huge. Hence it is quite difficult to get an overall perspective of the model behavior. Also it is hard to bring freely various ideas into the model because of the mental ability and the cost. In order to overcome these difficulties we construct a hierarchical model composed of three submodels as shown in Figure 1.

The upper stratum model is directed to the socioeconomic development of the whole of Japan. The major concern of the middle stratum model is the spatial allocation of industries and population at the target year. The lower stratum model traces the annual development from the initial year to the target year. Through this process, the dynamic feasibility of a specified regional development plan can be tested. The user does not always need to use all these three submodels. If he has his own image of the future Japan, he can utilize it directly as a control total of the middle stratum model. Similarly the lower stratum model can be run independently.

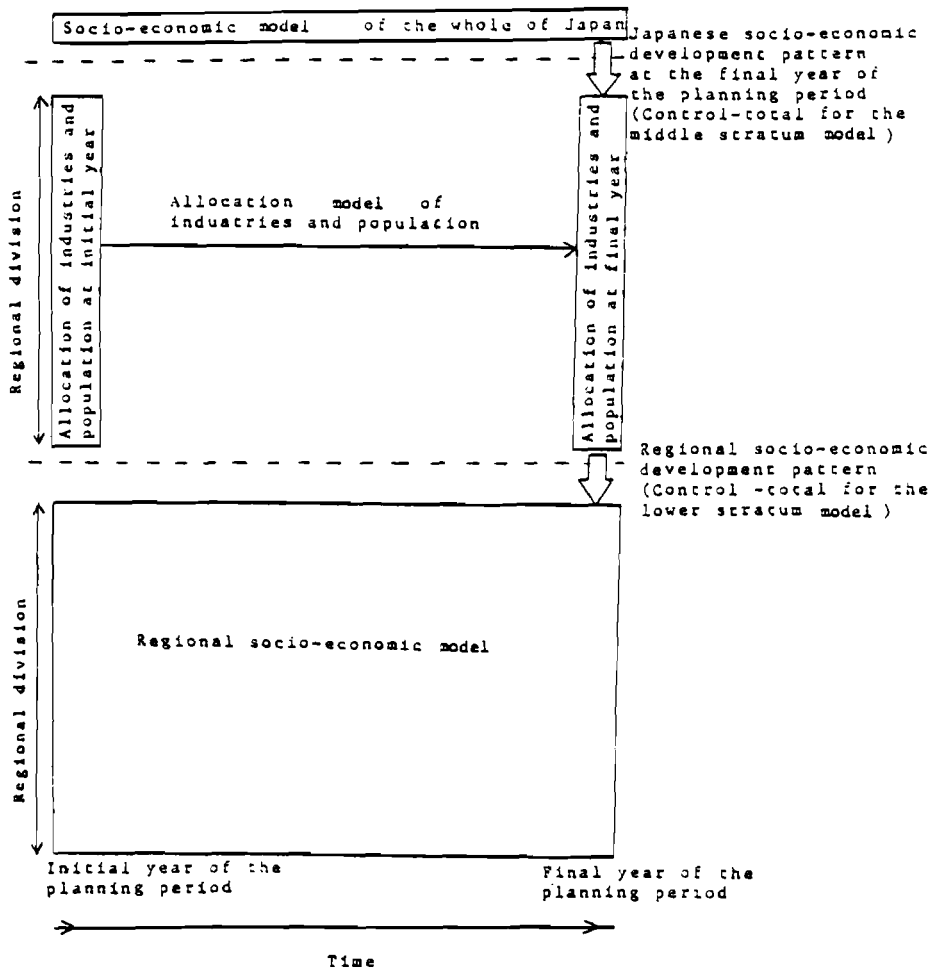

Figure 1. Structure of hierarchical model.

### 2.2.2. Premises for the Model Construction

We assume the following in order to introduce the constraints into the model.

(i). The constraints of the national socioeconomic development are the labor force and the raw material supply—that is approximately equal to import.

(ii). The physical constraints such as land, water, and environmental capacity are not serious until theregional division is made.

### 2.3. Upper Stratum Model

The structure is explained by using a flowchart shown in Figure 2. In the model the capital and labor are allocated so that the supply and demand can balance and the production can be maximized. The characteristics are listed as follows:

#### Population

Total population in five age groups

#### Industry

Production by sector (see Table 1)

Employees by sector

Production capacity by sector:

1st, 10th, and 11th sectors: exogenous value

2nd - 7th and 9th sectors: Cobb-Douglas production function

8th sector: production required to meet demand

Interindustry relations

input-output tables

#### Consumption and Investment (see Table 2)

##### Consumption

Private consumption, 10 items

Government consumption

##### Investment

Enterprise capital investment

Economic overhead capital investment, 3 items

Social overhead capital investment, 7 items

##### Inventory

#### Resources

Import of energy raw material

#### Parameters

##### Population

Birth rate by five age groups

Death rate by five age groups

Labor force participation rate by five age groups

##### Industry

Parameters of production function

Input coefficient matrix

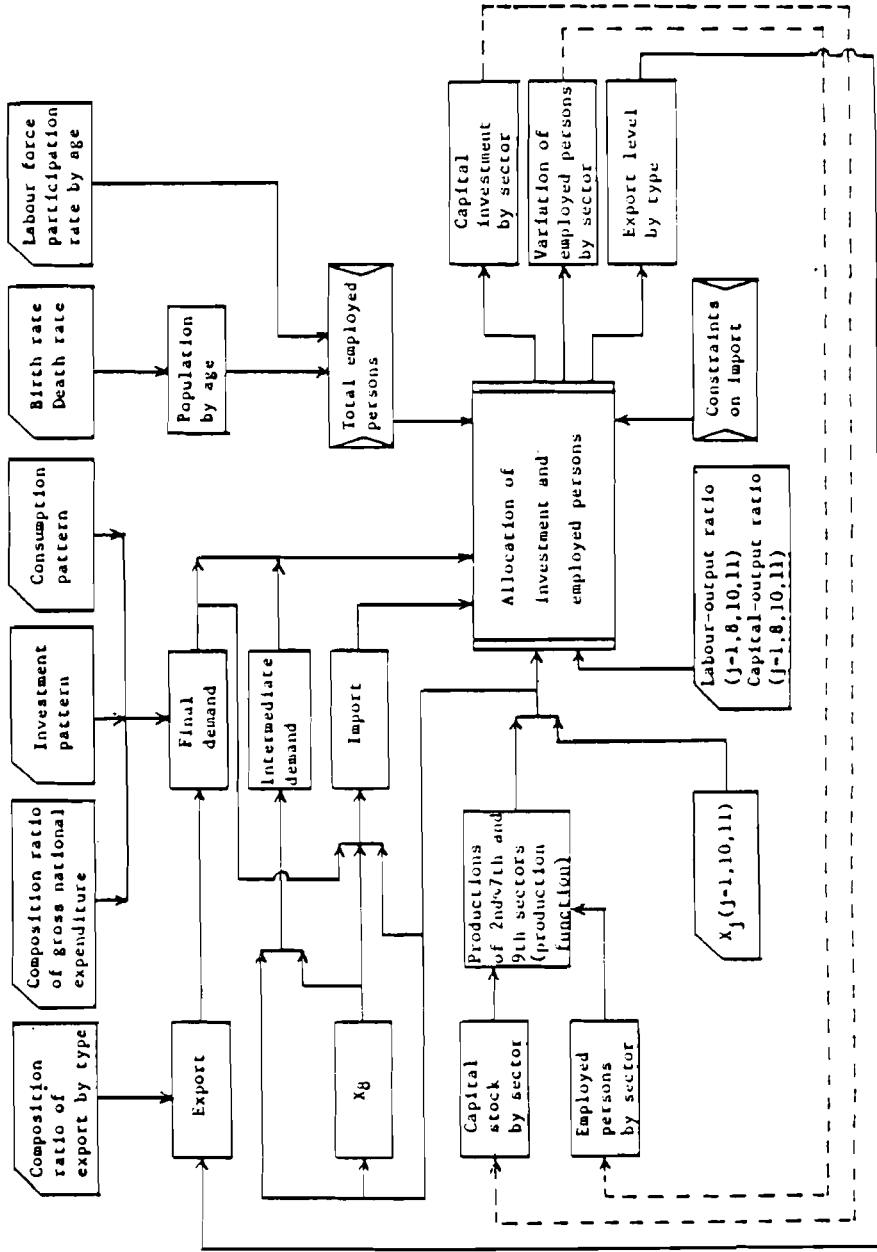

$x_j$  : Production of  $j$ th sector

Figure 2. Upper stratum model—socioeconomic model of the whole of Japan.

Table 1. Industrial classification

Middle Model (9 sectors)	Upper and Lower Model (11 sectors)	1970 Input-Output Tables (60 sectors)*
1. Agriculture Forestry and Fisheries	1. Agriculture Forestry and Fisheries	1,2,3,4. Agriculture 5. Forestry 6. Fisheries
2. Heavy and chemical	2. Chemical	24. Pulp, Paper 28,29,30. Chemicals 31,32. Petroleum and Coal Products 33. Nonmetallic Mineral Products
	3. Basic Metal	34,35. Iron and Steel 36. Nonferrous Metal Products
3. Light Manufacturing	4. Light Manufacturing	12,13,14,15,16,17. Food and Beverages 18,19,20,21. Textile and Clothing Products 22. Lumber and Wood Products 23. Furniture 25. Printing and Publishing 26. Leather and Leather Products 27. Rubber Products 41. Precision Machinery 42. Miscellaneous Manufacturing
4. Metal and Machinery	5. Metal and Machinery	37. Fabricated Metal Products 38. Ordinary Machinery 39. Electrical Machinery 40. Transport Machinery
5. Energy	6. Energy	45,46,47. Electricity, Gas, and Water
6. Transportation	7. Transporta- tion and communication	51. Transportation ----- 52. Communication
7. Commerce, Service, Communication	8. Commerce, Finance Services and Public Services	48. Commerce 49. Finance and Insurance 50,60. Real Estate 53. Services 54. Public Service 55. Others 56. Research Institutes
8. Construction	9. Construction	43. Construction 44. Engineering Work
9. Mining	10. Energy Raw Material	7. Coal and Lignite 10. Crude Petroleum and Natural Gas
	11. Structural Raw Material	8,9. Iron Ore and Nonferrous Metal Ore 11. Other Mining and Quarrying

\*Office supplies (66), Packing Materials (67), and Activities not adequately described (57), are allocated in proportion to each sector.

Table 2. The structure of gross national expenditure.

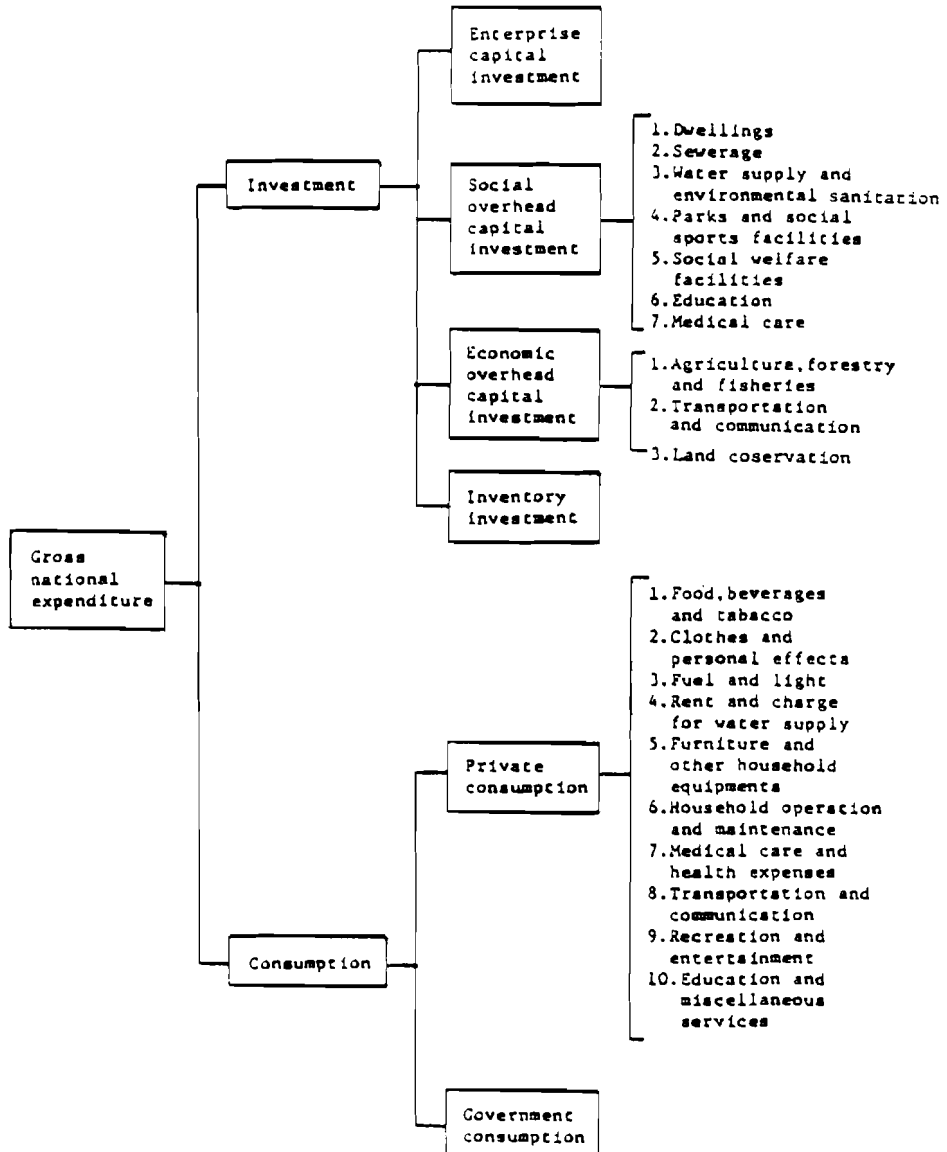



## Consumption, Investment, Export and Import

Private consumption rate  
 Private consumption pattern (item)  
 Private consumption conversion matrix (item → goods)  
 Government consumption rate  
 Government consumption conversion vector (goods)  
 Enterprise capital investment rate (goods)  
 Inventory investment rate  
 Inventory investment conversion vector  
 Economic overhead capital investment pattern (item)  
 Social overhead capital investment pattern (item)  
 Economic overhead capital investment conversion matrix  
 (item → goods)  
 Social overhead capital investment conversion matrix  
 (item → goods)  
 Composition ratio of export by type

## Dynamics

If the composition ratio of gross national expenditure, the consumption pattern and investment pattern are given, then the final demands by goods are determined. The proportions of goods production are now obtained by using the input-output coefficient matrix. The labor force and enterprise investment of 2nd-7th and 9th sectors are allocated so that the demands can be satisfied and the next year production be maximized.

If the import of energy or structural raw material is restricted, the supply of energy or structural raw material sector is depressed. The production of other sectors is also depressed through the input-output coefficient matrix.

From this model the following indicators are obtained.

- (1) Enterprise capital investment by sector
- (2) Economic overhead capital investment (item)  
Social overhead capital investment (item)
- (3) Cumulative social overhead capital investment during 30 years (item)  
Cumulative economic overhead capital investment during 30 years (item)
- (4) Private and government consumption
- (5) Value added by sector
- (6) Employed persons by sector
- (7) Inventory by sector
- (8) Export and import by sector
- (9) Employment rate

All of these can be used as the control totals of the middle stratum model.

#### 2.4. Middle Stratum Model

Figure 3 shows the model structure. The industrial production, the population, and the social capitals of the target year that are obtained by using the upper stratum model are allocated to each region. Allocation is made so that both the interregional transportation and the income difference can be minimized under the regional constraints.

The characteristics are shown below. The agricultural production which occupies the major part of the first sector is allocated to each region, prior to the allocation of other industries, because it is expected that a nationwide protective policy for agriculture will be adopted in order to improve self-sufficiency. The allocation of the mining production is also assumed to be unchanged.

##### Region

Seven prefectures of Kinki  
Six blocks outside Kinki (see Table 3)

##### Industry

Regional product by sector (nine sectors)  
Regional employees by sector  
Value added ratio by sector

##### Population

Regional population

##### Consumption and Investment

Consumption  
Private consumption, 10 items  
Government consumption  
Investment  
Enterprise capital investment  
Economic overhead capital investment, 3 items  
Social overhead capital investment, 7 items  
Inventory

##### Constraints

###### Water

###### Land

###### Environment

SO<sub>x</sub>, NO<sub>x</sub> and BOD are taken as the representatives of pollutants. Permissible emissions by regions are given to each pollutant referring to the geographical features

###### Constraints on the allocation of Population

This is adopted to forbid excessive changes from the present allocation pattern

###### Constraints on the allocation of Industries

Three industrial sectors (heavy and chemical, light manufacturing, metal and machinery) and energy sector are constrained. Transportation sector is also constrained so that a large gap cannot arise for the regional demand

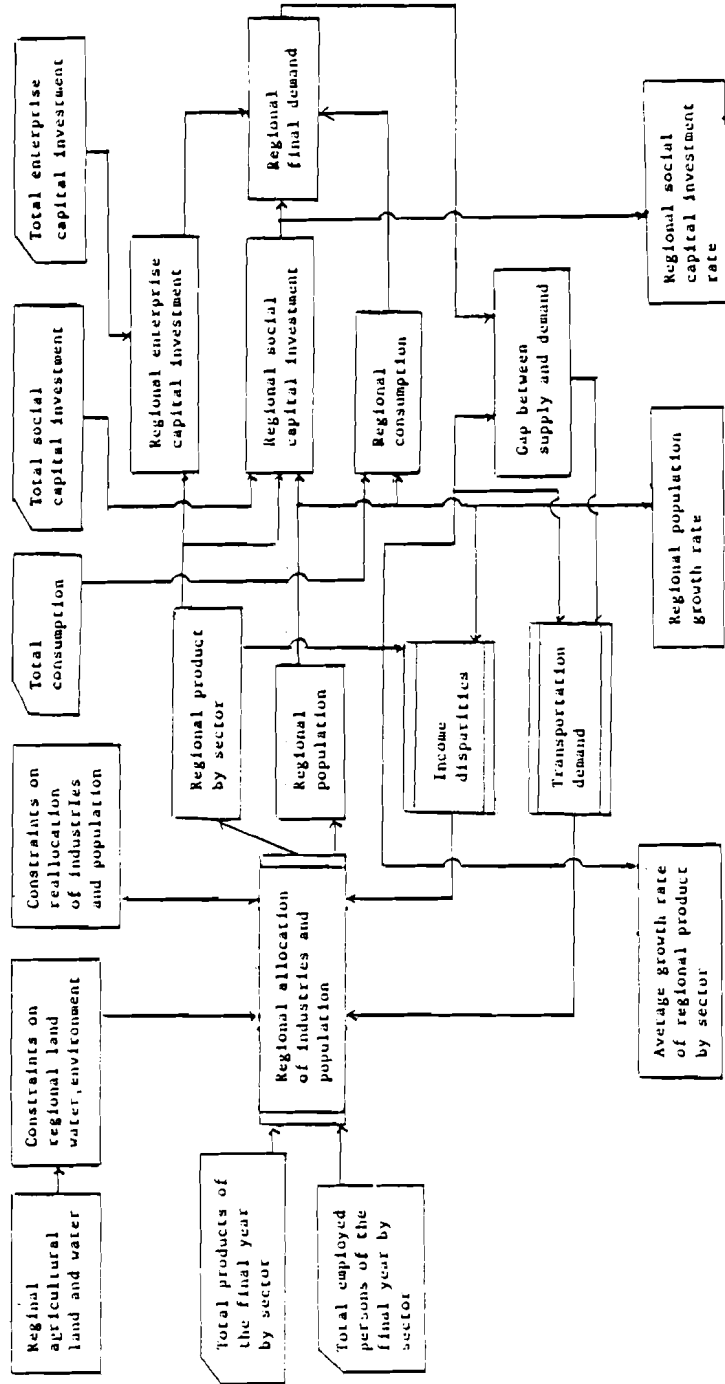
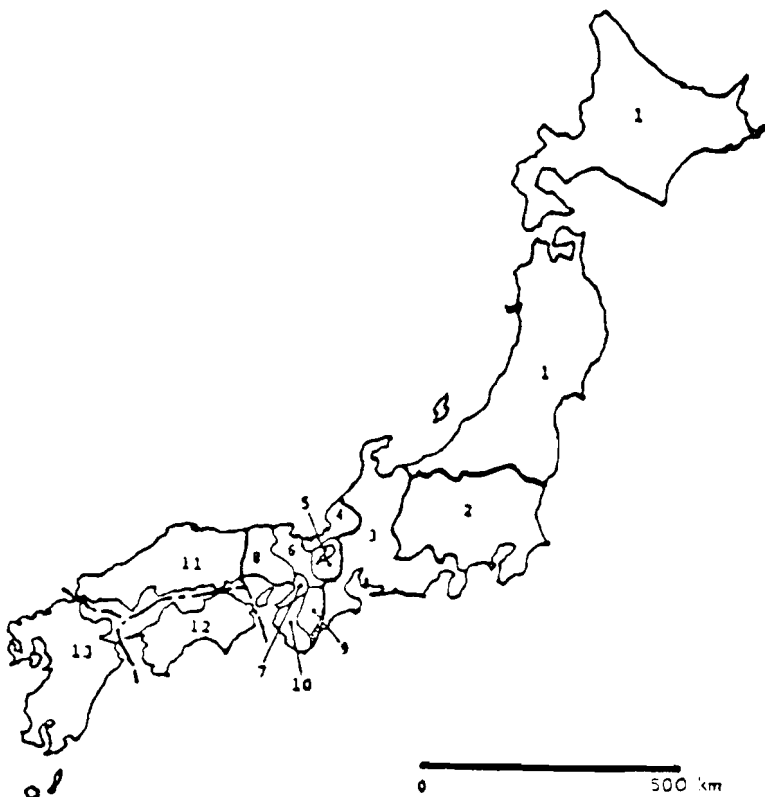

Figure 3. Middle stratum model--allocation model of industries and population.

Table 3. Regional division.

Region	Prefecture
1. Higashi Nippon	Hokkaido, Aomori, Iwate, Miyagi, Akita, Yamagata, Fukushima, Niigata
2. Kanto	Ibaragi, Tochigi, Gunma, Saitama, Chiba, Tokyo, Kanagawa, Yamanashi, Nagano
3. Chubu	Gifu, Aichi, Mie, Shizuoka, Toyama, Ishikawa
4. Fukui	Fukui
5. Shiga	Shiga
6. Kyoto	Kyoto
7. Osaka	Osaka
8. Hyogo	Hyogo
9. Nara	Nara
10. Wakayama	Wakayama
11. Chugoku	Tottori, Shimane, Okayama, Hiroshima, Yamaguchi
12. Shikoku	Tokushima, Kagawa, Ehime, Kouchi
13. Kyushu	Fukuoka, Saga, Nagasaki, Kumamoto, Oita, Miyazaki, Kagoshima



## Parameters

Those given by the upper stratum model

Value added by sector

Employed persons by sector

Employment rate

Enterprise capital investment by sector

Economic overhead capital investment and cumulative investment (item)

Social overhead capital investment and cumulative investment (item)

Private and government consumption

Inventory by sector

Export and import by sector

## Industry

Input coefficient matrix

## Consumption and Investment

Private consumption conversion matrix

Government consumption conversion matrix

Enterprise capital investment conversion matrix

Economic overhead capital investment conversion matrix

Social overhead capital investment conversion matrix

## Constraints

Regional upper bound for the water supply

Regional agricultural water

Water usage per capita

Water usage per unit product (excluding agriculture)

Regional inhabitable land area

Regional agricultural land area

Land usage per capita

Land usage per unit product (excluding agriculture)

Land usage per unit economic overhead capital stock of transportation

Permissible emissions of  $SO_x$ ,  $NO_x$ , and BOD by region

$SO_x$ ,  $NO_x$ , and BOD emissions per unit product

BOD emissions per capita

## Transportation

Distance between regions

Transportation cost per unit product

## Parameters related to the objective function

The weight of transportation demand

The weight of income differential

## Determination of Regional Allocation

## Production and Population

National products and employed persons by sector of the target year are given as control parameters. Regional allocations of the 1st and the 9th sectors are predetermined as mentioned before. Allocations of the 2nd to 5th sectors are determined so that both the interregional transportation and income differential can be minimized under the regional constraints. The 8th sector (construction) is allocated to satisfy the regional construction demands. The 6th sector (transportation) is allocated so that no excessive gap can arise between demand and supply. The employed persons of each sector mentioned above are determined

in proportion to the product of each sector. The employed persons of the 7th sector (service) are determined in proportion to the total number of employed persons in the region excluding services. The service production is proportion to them. Regional total population is the total of employed persons multiplied by the reciprocal of employment rate.

#### Social Capital Stock

National capital stocks by item of the target year are obtained by adding the cumulative investments over the planning period to the initial stocks and subtracting the depreciations. The capital stock for agriculture, forestry, and fisheries is allocated so that the stock per production is uniform. As for the transportation capital, it is allocated in proportion to the total production composed of the 1st to the 4th and the 9th sectors. The land conservation capital is allocated in proportion to the regional land area. The social overhead capital is allocated so that the stock per capita is uniform.

### 2.5. Lower Stratum Model

Figure 4 shows the model structure. The targets of the regional development determined by using the middle stratum model are translated to the annual growth rate to attain them. Those are introduced into the lower stratum model as guidelines. Annual investment and increase of population are allocated to each region so as to attain those growth rates as closely as possible. By using this model we can check year by year whether the specified path of the regional socioeconomic development is reasonable or not.

The characteristics of the model are listed below.

#### Region

- Seven prefectures of Kinki
- Six blocks outside Kinki

#### Industry

- Regional product by sector (12 sectors)
- Regional employed persons by sector
- Productive capacity Cobb-Douglas production function
- Interindustry relations
- Input-output table

#### Population

- Total population by age group
- Regional population

#### Consumption and Investment

##### Consumption

- Regional private consumption, 10 items
- Regional government consumption

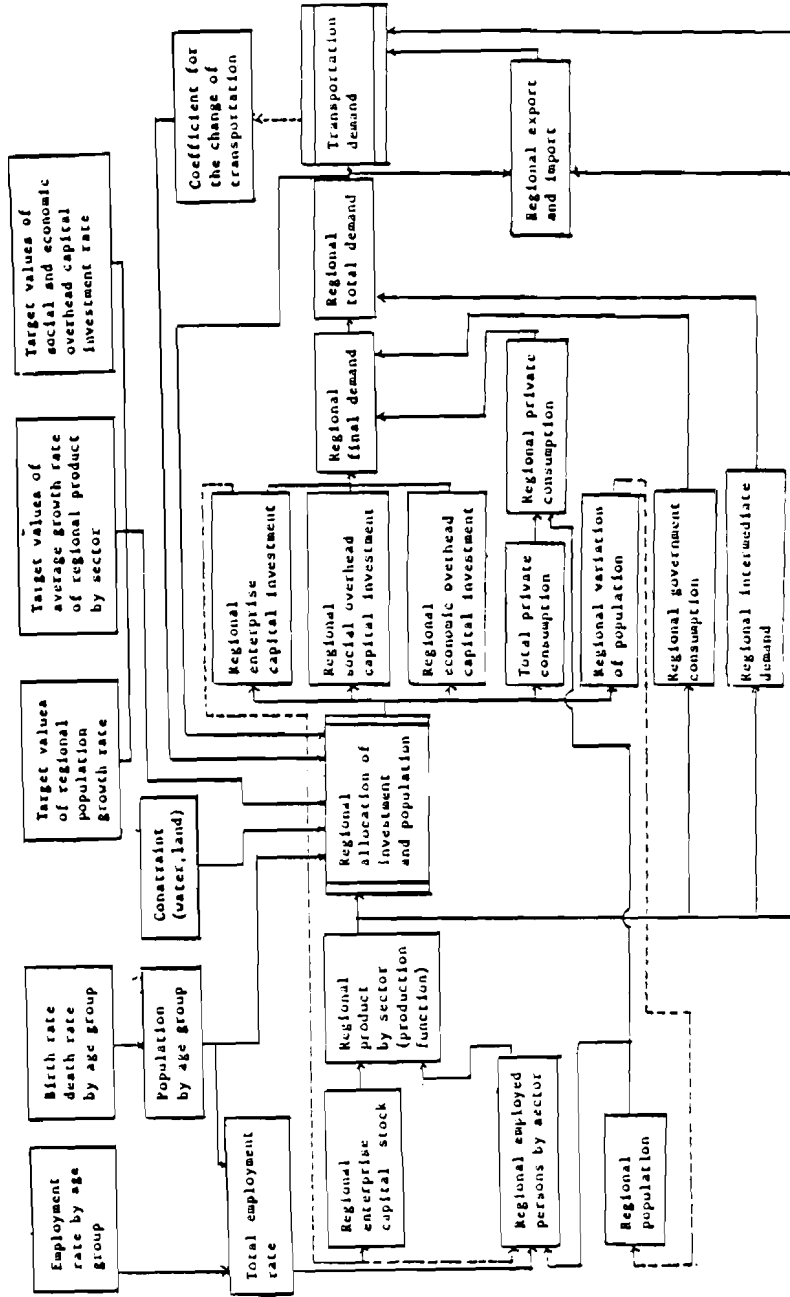

Figure 4. Lower stratum model regional socioeconomic model.

## Investment

- Regional enterprise capital investment
- Regional social overhead capital investment
- Regional economic overhead capital investment

## Constraint

- Land
- Water

## Parameters

Those given by the middle stratum model

- Target values of average growth rate of regional product by sector
- Target values of regional social overhead capital investment rate
- Target values of regional economic overhead capital investment rate
- Target values of average growth rate of regional population

## Population

- Birth rate and death rate by age group
- Labor force participation rate by age group

## Industry

- Parameters of production function by sector
- Input coefficient matrix
- Value added ratio by sector

## Consumption and Investment

- Private consumption pattern (item)
- Private consumption conversion matrix (item + goods)
- Government consumption conversion vector (goods)
- Enterprise capital investment conversion matrix (investment + goods)
- Social overhead capital investment conversion vector (goods)
- Economic overhead capital investment conversion vector (goods)
- Export and import pattern (goods)
- Standard value of private consumption rate
- Standard value of government consumption rate

## Constraints

- Water usage per unit product by sector
- Water usage per capita
- Regional upper bound for the water supply
- Land usage per capita
- Land usage per unit product by sector
- Regional inhabitable land

## Transportation

- Distance between regions
- Transportation cost per unit product (goods)

## Objective Function

- The weight of each objective function

## Dynamics

The production of a certain year is determined from the capital stock and the employed persons by using the Cobb-Douglas production function. The investment and the



increase of population are allocated to each region according to its industrial growth rate, social capital investment rate and population growth rate within the limits of usable land and water. The private consumption is determined according to the regional population and the government—according to the regional production. Regional capital stocks of the next year are determined by the above investments considering the depreciation. Regional employed persons of the next year are determined as a function of the population, labor force participation rate, investment, and capital-labor ratio. Regional final demands are determined by investments and consumptions. Total demand is a sum of the final demand and the intermediate demand, which can be obtained through the input coefficient matrix. Regional export and import and interregional transportation are determined by comparing the total demand and the production. It is possible to feed back the change of transportation demand and to include it in the objective function of the next year.

### 3. SCENARIO ANALYSIS

#### 3.1. Outline

The model user is able to investigate to what extent a certain scenario of regional development attains the objective by running the model, where the values of parameters are given in the scenario. Repeating this procedure, a desirable regional development scenario may be found. Investment rate, consumption rate, and various other parameters of the upper stratum model, upper and lower bound for population and production, agricultural water and land, upper bound for water supply, land and water usage per capita or per unit product, and  $SO_x$ ,  $NO_x$ , and BOD emission per unit product of the middle stratum model are the parameters that have important effects on the accomplishment of the objectives. Birth rate, death rate, labor force participation rate, production function and so forth will be determined by referring to the historical trends and the expected future change. Occasionally those will be determined by the judgment of the user himself. The interindustrial input coefficient matrix, value added ratio, and conversion matrix of investment and consumption are important parameters which reflect the industrial structure, but it is very difficult to estimate their future changes.

#### 3.2. Standard Scenario

We take the initial year of the model run to be the year 1970 and the planning period to be 30 years. As the standard scenario, we refer to the scenario of regional development, in which the model parameters are taken as follows.

### 3.2.1. *The Upper Stratum Model*

#### Population

##### Birth Rate and Death Rate

These are obtained by modifying the data in 1970 so that the total population can be equal to the value in 2000 (medium value) estimated by the Council on Population Problems.

##### Labor Force Participation Rate

This is obtained by considering the present Japanese situation and the data of the United States.

#### Proportion of Gross National Expenditure

This is given in Table 4 showing the past trend of the proportion of the gross national expenditure of both Japan and other countries of the world. Social overhead capital and economic overhead capital are taken to be at the level achieved in the final year as shown in Table 5.

#### Private Consumption Pattern

This is given in Table 6 showing the proportion of private consumption in both Japan and other countries of the world.

#### Composition of Export

The four types are considered as shown in Table 7. Type 1 is the actual figure for 1970. Type 2 is the case where the ratio of the 5th (metal and machinery) sector is high. And type 3 is the case where the ratio of the 4th (light manufacturing) sector is high and the ratio of the 5th sector is the same figure as in type 1. In both type 1 and type 2, the ratios of the 2nd and 3rd (basic metal) sectors are taken to be quite low. Type 4 is based on estimates by the Industrial Structure Council (ISC).

#### Productions of the 1st, 10th, and 11th Sectors

The production from 1970 to 2000 are given exogenously based on estimates by the ISC.

#### Capital-Output Ratios and Labor-Output Ratios of the 1st, 8th, 9th, and 11th sectors

The capital-output ratios and the labor-output ratios are based on ISC estimates.

### 3.2.2. *The Middle Stratum Model*

#### Upper and Lower Bounds of Population

We use the value close to the trend value and the value from the Long-Term Vision of the Industrial Structure (ISC) for the upper and lower bounds.

Table 4. The structure of gross national expenditure.

Item	Initial year (1970)	Final year (2000)				
		1*	2*	3*	4*	
Enterprise capital investment	0.2018	0.110	0.150	0.090	0.110	
Economic overhead capital investment	0.1090	0.160	0.130	0.145	0.160	
Social overhead capital investment	0.0497	0.050	0.050	0.045	0.050	
Inventory investment	0.0324	0.020	0.020	0.020	0.020	
Private consumption	0.5181	0.560	0.550	0.600	0.560	
Government consumption	0.0846	0.100	0.100	0.100	0.100	
Economic overhead capital investment**	1	0.0044	0.0050	0.0050	0.0045	0.0050
	2	0.0385	0.0380	0.0380	0.0342	0.0380
	3	0.0067	0.0070	0.0070	0.0063	0.0070
Social overhead capital investment**	1	0.0717	0.0800	0.0650	0.0725	0.0800
	2	0.0028	0.0150	0.0122	0.0136	0.0150
	3	0.0026	0.0050	0.0040	0.0045	0.0050
	4	0.0041	0.0080	0.0065	0.0073	0.0080
	5	0.0154	0.0299	0.0243	0.0271	0.0299
	6	0.0087	0.0110	0.0090	0.0110	0.0110
	7	0.0036	0.0110	0.0090	0.0110	0.0110

\*1 = Standard Scenario, 2 = Growth-oriented Scenario,  
3 = Consumption-oriented Scenario, 4 = Import restriction Scenario for the Energy Raw Material

\*\*See Table 2.

Table 5. Target of social capital improvement.

Indicators	Target	Reference
Space of houses	30 m <sup>2</sup>	Japan (1970) 18.5 m <sup>2</sup> America (1963) 37.9 m <sup>2</sup> W. Germany (1968) 29.3 m <sup>2</sup>
Sewerage systems	60%	Japan (1970) 14%
Rubbish and human waste disposal	90%	Japan (1970) 64%
City park area per capita	9 m <sup>2</sup>	Japan (1970) 2.2 m <sup>2</sup> Washington (1973) 40.8 m <sup>2</sup> Rome (1973) 11.4 m <sup>2</sup>
Accommodation rate of homes for aged and welfare centers	3%	Japan (1970) 1.0% Denmark (1963) 3.8%
Hospital beds per 10 thousand persons	1.5 times	Japan (1970) 103 beds Sweden (1970) 150 beds

Table 6. Private consumption pattern.

Item*	Scenario	
	1970	2000
1	0.350	0.250
2	0.082	0.082
3	0.028	0.040
4	0.133	0.160
5	0.062	0.062
6	0.028	0.024
7	0.085	0.100
8	0.049	0.070
9	0.085	0.100
10	0.098	0.108

\*See Table 2.

Table 7. Composition ratio of export by type.

Sector*	Type			
	1	2	3	4
1	0.011	0.00	0.00	0.00
2	0.091	0.06	0.06	0.08
3	0.129	0.01	0.01	0.12
4	0.183	0.13	0.35	0.13
5	0.383	0.60	0.38	0.47
6	0.000	0.00	0.00	0.00
7	0.143	0.14	0.14	0.14
8	0.000	0.00	0.00	0.00
9	0.060	0.06	0.06	0.06
10	0.000	0.00	0.00	0.00
11	0.000	0.00	0.00	0.00

\*See Table 1.

## Upper and Lower Bounds of Industry

### Heavy and Chemical

The lower bounds are taken to be 1 (the value for the present situation). The upper bounds for Shiga and Nara are taken to be only 2.4 times as much as the present situation (3 percent technological progress is considered) because these two prefectures are inland.

For other regions these are between 5 and 20 times.

### Light Manufacturing, Metal and Machinery

The lower bounds are taken to be 1 and 3 times as much as the present situation, respectively.

### Energy

The same as heavy and chemical sector.

### Transportation

The upper and lower bounds are taken to be  $\pm 20$  percent of the value added for transportation from 1970 inter-regional input-output tables.

## Land and Water

For agricultural land, we use the value in 1985, estimated by the National Land Agency, as the data of each prefecture in proportion to the value in the year 1972. It is assumed that Osaka maintains its present situation.

For agricultural water, we use the value in 1985, estimated by the Ministry of Construction. Therefore, land and water usage per unit product of the first sector is obtained by dividing total agricultural land and water by the value added taken from the upper stratum model.

Industrial land and water usage per unit product is taken to be  $1/24$  of the present value, assuming 3 percent technological progress. By this assumption, it is considered that about 2.4 times the product can be obtained by using the same amount of water and land.

Water usage per capita is taken to be 0.12 (100 million tons/thousand persons/year) and land usage per capita to be 0.08 (km<sup>2</sup>/thousand persons).

Land usage per unit social capital stock for transportation is taken to be 0.352 (km<sup>2</sup>/ten billion yen) by referring to the data of Osaka and the whole of Japan in 1970.

The upper bound of the regional water supply is taken to be 60 percent of the total amount of run-off from forests and fields. However, for Osaka the upper bound of the water supply is taken to be 50 percent of the annual flow of the Yodo River.

The upper bound for the regional usable land is taken to be the regional inhabitable land. But Osaka is now overcrowded, and the efficiency of land usage is twice as much as the average of the whole of Japan. Therefore, it is assumed that Osaka remains in this circumstance in the future.

Land and water usage per unit product and per capita are shown in Table 8.

Table 8. Land and water usage per product or per capita in the final year (middle stratum model).

(a) Product		
Sector*	Land (km <sup>2</sup> /¥10 billion/year)	Water (10 <sup>6</sup> t/10 billion/year)
1		
2	0.335	5.899
3	0.260	2.231
4	0.167	0.539
5	0.127	0.191
6	0.000	2.035
7	0.024	0.212
8	0.000	0.120
9	0.066	0.066

\*See Table 1.

(b) Living		
Land	0.08	(km <sup>2</sup> /1000 persons)
Water	0.12	(million t/1000 persons/year)

(c) Land usage per unit economic overhead capital stock of transportation

0.352 (km<sup>2</sup>/10 billion)

### Environment

It is assumed that the SO<sub>x</sub>, NO<sub>x</sub>, and BOD emissions per unit product will be 1/2.4 of the present value after the future technological progress and a further 1/10 following pollution abatement investment. Overall the figure is assumed to be 1/24. Coal usage is assumed to be half of the present value in the heavy and chemical sector and to be zero in other sectors. BOD emissions per capita are assumed to be decreased to 1/20 of the present value by the spread of sewerage service (consider third-order treatment). Each emission per capita and per unit product is shown in Table 9.

### Weight of Evaluation

We consider the self-sufficiency. The weight for transportation in the region is taken to be zero. The weights for the interregional transportation and the interregional income differential are taken to be equal, where we consider that protective policies will be made for agriculture in future, and so the first sector is excluded from the evaluation on the interregional income differential.

Table 9. Pollutant emissions per unit product or per capita (middle stratum model)

(a) Industry			
Sector	SO <sub>x</sub> (t/¥10 billion)	NO <sub>x</sub> (t/¥10 billion)	BOD (t/¥10 billion)
1			
2	97.07	26.89	61.42
3	17.94	5.08	78.33
4	7.06	2.00	0.27
5	332.00	94.12	0.00
6	19.05	5.40	0.00
7	5.25	1.487	0.00
8	2.22	0.629	0.00
9	10.62	3.01	0.00

(b) Living	
BOD emissions per 1000 persons	0.60 (t/1000 persons/year)

### 3.3. Other Scenarios

Three different scenarios are considered as shown in Tables 4 and 7.

- Growth-oriented scenario
- Consumption-oriented scenario
- Import restriction scenario for the energy raw material sector. The energy raw material is assumed to have an upper bound which is about twice as much as the present value, considering the global energy situation.

### 3.4. Example of the Output of the Hierarchical Model

As the volume of model output is quite huge, only some of it is shown here. In Table 10 various variables in the final year of the upper stratum model are summarized. In the case of the standard scenario, the GNP reaches almost 4,000 trillion yen in the year 2000. However, in the import restricted case, the GNP is reduced almost to half. The highest GNP is attained in the growth-oriented scenario, but the social overhead capital stock is slightly smaller than the standard scenario. Growth processes of various variables in the standard scenario are shown in Figure 5.

In Table 11, population, GRP, and GNP per capita by region in the standard scenario are shown, as obtained from the middle stratum model. Regional disparity of GRP per capita is considerably eradicated. In Figure 6 dwellings and sewerage of the year 2000 compared with 1970 are shown. Referring to Table 5, dwelling is much more improved than the target, and sewerage is also arranged almost to the target level.

Table 10. Output of the upper stratum model.

(a) Production by sector in the final year (10 billion yen).

Sector	Scenario		2000			
	1970		1	2	3	4
1	732.5		1273.5	1273.5	1273.5	1273.5
2	1503.5		8152.4	10113.0	7266.4	4401.2
3	1333.7		7212.1	9227.5	6170.4	3913.5
4	2610.2		13134.0	16.4	11989.0	7349.8
5	2811.4		16657.0	22972.0	14009.0	8514.3
6	268.6		1742.1	2193.9	1588.8	954.1
7	758.6		4680.5	5912.7	4240.1	2565.0
8	4351.5		26319.0	33278.0	24140.0	14583.0
9	1684.1		8448.7	9691.6	6816.7	4724.4
10	17.5		55.2	55.2	55.2	55.2
11	80.1		252.4	252.4	252.4	252.4
Total	7283.4		40023.0	50559.0	35809.0	22328.0
Annual average growth rate			5.9	6.7	5.5	3.8

(b) Percentage of total.

Sector	Scenario		2000			
	1970		1	2	3	4
1	4.5		1.5	1.2	1.6	2.6
2	9.3		9.3	9.1	9.3	9.1
3	8.3		8.2	8.3	7.9	8.1
4	16.2		14.9	14.8	15.4	15.1
5	17.4		18.9	20.6	18.0	17.5
6	1.7		2.0	2.0	2.0	2.0
7	4.7		5.3	5.3	5.5	5.3
8	26.9		29.9	29.8	31.0	30.0
9	10.4		9.6	8.7	8.8	9.7
10	0.1		0.1	0.1	0.1	0.1
11	0.5		0.3	0.2	0.3	0.5
Total	100.0		100.0	100.0	100.0	100.0



Table 10. Output of the upper stratum model (continued).

(c) Employed persons (thousand persons).

Sector	Scenario		2000			
	1970		1	2	3	4
1	9882.7		4597.1	3145.4	4597.1	4597.1
2	1662.6		1519.3	1519.3	1519.3	2921.8
3	884.8		808.5	808.5	808.5	808.5
4	6019.9		5500.9	5548.6	5676.5	5500.9
5	4892.8		4892.8	4892.8	4892.8	5078.7
6	281.5		638.9	724.5	688.5	635.5
7	3152.6		8842.4	10469.0	8305.5	7516.8
8	20395.9		30033.0	29314.0	30446.0	30071.0
9	3854.0		5001.2	5411.7	4900.2	4704.0
10	113.8		48.0	48.0	48.0	48.0
11	98.1		41.4	41.4	41.4	41.4
Total	51238.0		61924.0	61924.0	61924.0	61924.0

(d) Enterprise capital stock (10 billion yen)

Sector	Scenario		2000			
	1970		1	2	3	4
1	1066.5		6021.0	5565.4	6419.1	6713.6
2	582.8		3389.2	4316.0	2983.5	1394.1
3	602.8		3504.7	4599.9	2955.8	2737.9
4	1088.9		16944.0	25371.0	13914.0	12074.0
5	875.0		7264.8	11065.0	5816.2	4978.6
6	754.4		2353.1	3703.1	2144.6	1998.6
7	491.2		1872.6	7670.3	1696.4	1670.5
8	309.1		11222.0	13984.0	6495.1	7463.4
9	1413.0		17318.0	21897.0	15884.0	15206.0
10	13.2		1212.6	1212.6	1212.6	1212.6
11	60.6		556.1	556.1	556.1	556.1
Total	7257.5		71640.8	99940.4	60077.4	56005.4

Table 10. Output of the upper stratum model (continued).

## (e) Social overhead capital stock (10 billion yen)

Sector	Scenario		2000			
	1970		1	2	3	4
1	3959.4		51195.0	50486.0	44644.0	39896.0
2	159.2		6849.4	6776.2	5855.9	5004.3
3	249.4		2771.6	2737.9	2406.3	2119.0
4	91.4		4231.4	4117.6	3644.1	3180.9
5	171.1		15677.0	15476.0	13483.0	11751.0
6	930.2		7077.9	6986.7	6200.2	5549.5
7	298.4		5493.0	5430.8	4729.9	4098.9
Total	5859.1		93295.3	92071.2	80963.4	71599.6

## (f) Economic overhead capital stock (10 billion yen)

Sector	Scenario		2000			
	1970		1	2	3	4
1	409.2		3233.5	3689.1	2835.4	2540.9
2	1976.2		24874.0	28452.0	21737.0	19473.0
3	369.0		4501.4	5151.8	3932.0	3516.9
Total	2754.4		32608.9	37292.9	28504.4	25530.8

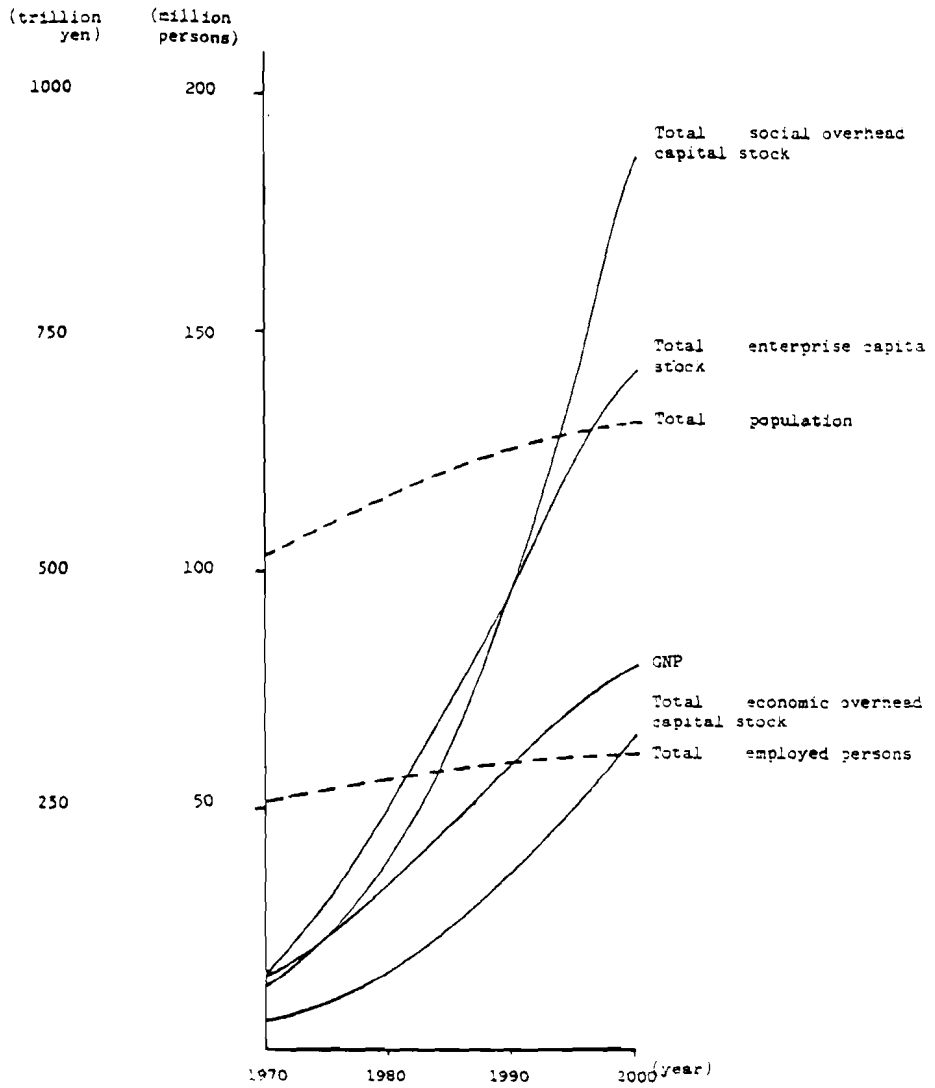

Figure 5. Output of upper stratum model.

Table 11. Output of the middle stratum model—standard scenario

Region*	Population (10 <sup>3</sup> persons)		GRP (10 billion yen)	
	1970	2000	1970	2000
1	16576	23704	869.1	5973.2
2	32215	36242	2619.1	12011.2
3	13810	19618	1057.3	6033.4
4	744	975	44.4	294.4
5	890	1282	58.4	363.2
6	2250	3240	158.1	963.6
7	7620	8839	713.4	2034.8
8	4668	5415	333.0	1799.9
9	930	1339	46.0	372.0
10	1043	1429	67.7	459.9
11	6997	6997	487.1	2047.7
12	3904	4380	229.8	1283.3
13	12072	18470	599.9	5386.2
Total	103719	131994	7283.3	40023.0

\*See Table 3.

GRP per capita\*\* (10 billion yen/1000 persons)

Region	1970	2000
1	0.044	0.234
2	0.078	0.330
3	0.072	0.304
4	0.054	0.295
5	0.060	0.277
6	0.069	0.296
7	0.093	0.343
8	0.069	0.332
9	0.045	0.275
10	0.057	0.318
11	0.064	0.285
12	0.051	0.285
13	0.044	0.283
Total	0.066	0.297

\*\*Omit the 1st sector.

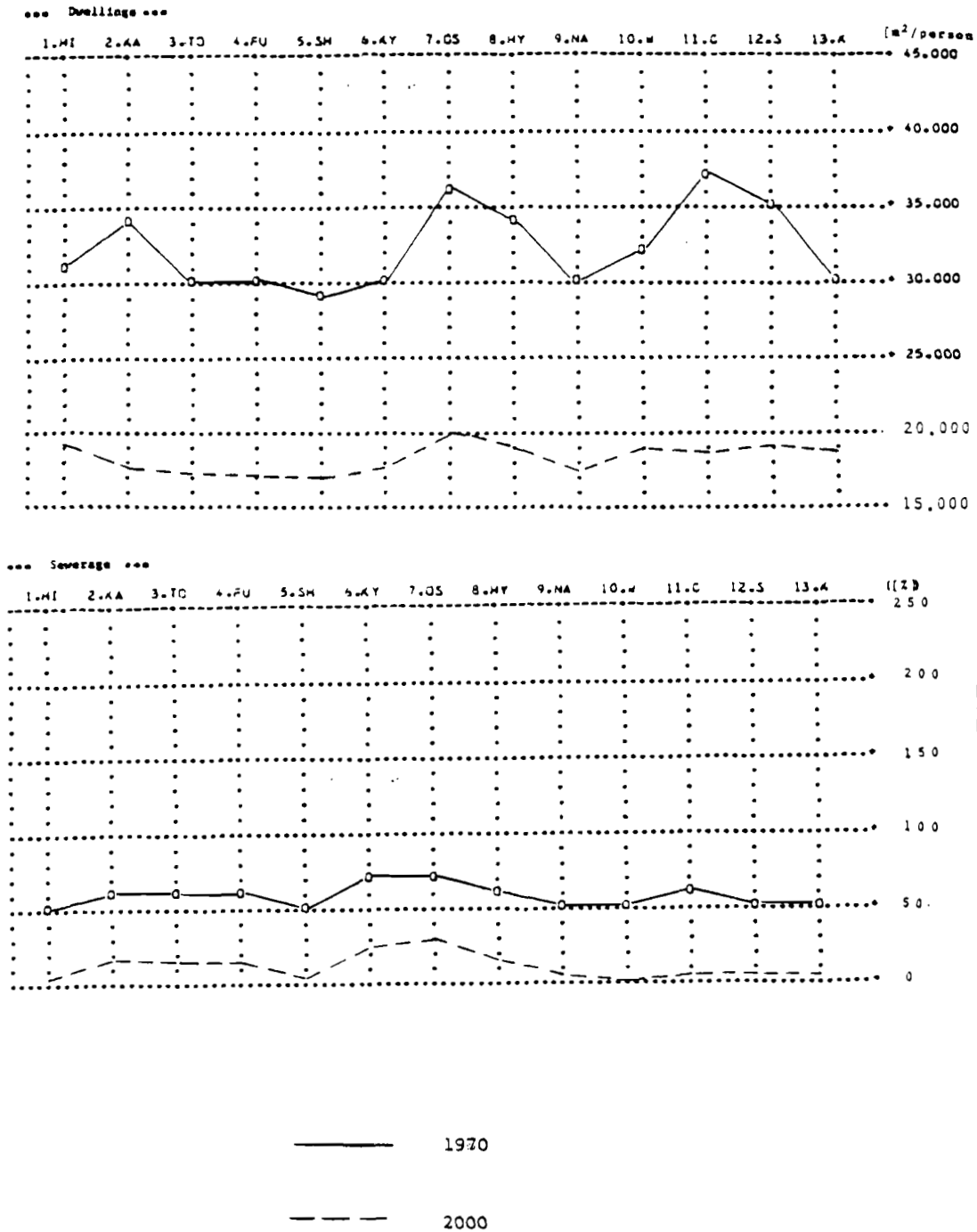

Figure 6. Output of the middle stratum model—standard scenario.

In Figure 7, some annual sectoral productions of the Osaka prefecture are shown, as obtained from the lower stratum model. The growth of the metal and machinery industry is remarkable; it is due to the present industrial structure of Osaka.

#### 4. CONCLUSION

We construct an integrated regional development planning model so as to assist the policy planning for ultra-long-term regional development. The object area is Kinki but this model will be applicable to other regions. We choose a hierarchical structure for the model in order to overcome the computational difficulties (both time and memory capacity) and to increase the model operational ability. Ideas of the planner are easily put into the model because of its flexible structure. Judging from our experiences and results which follow several scenarios, our intention to integrate and assess the most of the planner's ideas by using a computer model seems to be realized.

#### REFERENCE

- [1] The Council of National Living (1975) Social Indicators of Japan. Tokyo: Ministry of Finance, Printing Bureau.

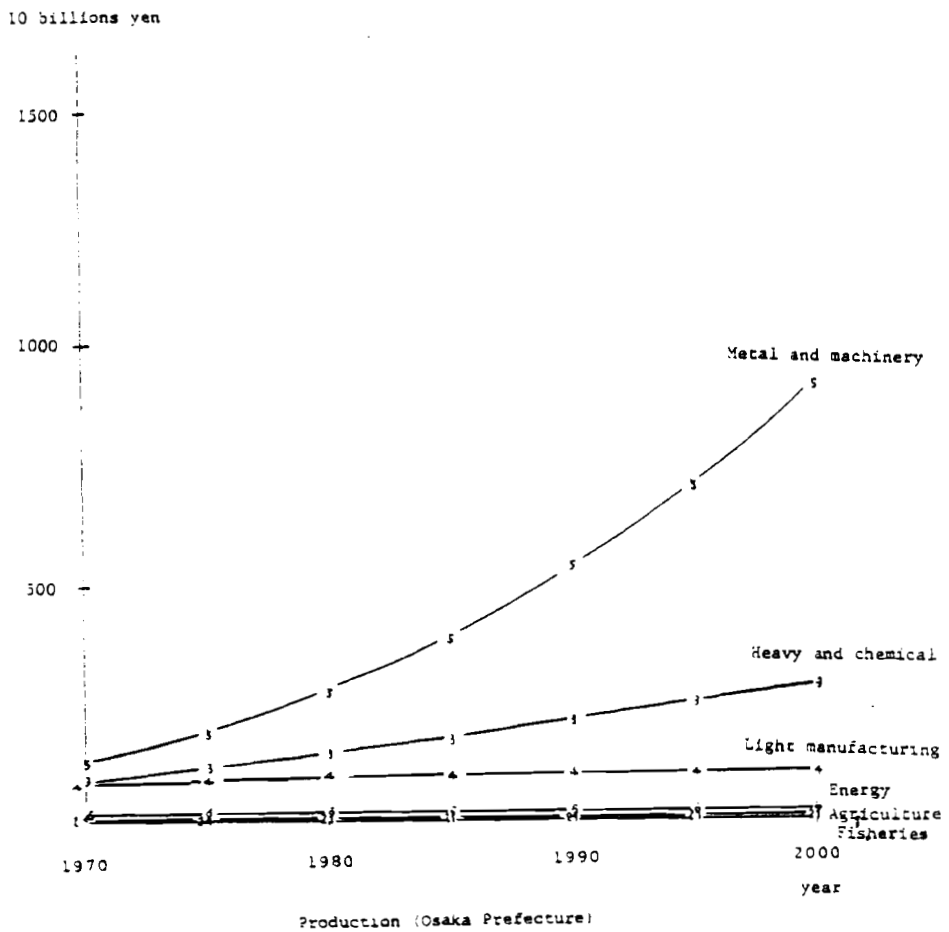

Figure 7. Output of the lower stratum model—standard scenario.

## SUMMARY OF THE DISCUSSION

J. Kacprzyk

On the case study presentation the discussion focussed on the number of pollutants to be taken into account for an adequate description of the actual regional situation with respect to environment quality. Some doubts were expressed about whether the three pollutants considered were sufficient, because in some countries the numbers are much higher. It was, however, stated that it is not the number of pollutants that plays the key role, but their impact and relevance for the region considered. Moreover, in a case study one always works on the data that administrative units (prefectures) have.

On the general issue of regional planning, programming, and models, the discussion concentrated first on the concept of Integrated Regional Development (IRD) and its relevance. Since regional problems are usually complicated, not clear-cut, multi-dimensional, multilayer, involve conflicts, etc., the IRD approach combining different types of problems promises to attain the best results. Moreover, for better efficiency, simulation (of extrapolation type) and normative (of optimization type) approaches should be coupled.

Owing to the inherent softness of regional problems, for a more adequate description of them some new, softer (i.e., less rigid) approaches are needed. Unfortunately, such approaches are not very numerous now, and, even when they exist, they are not used to a satisfactory extent.

The use of a computer was naturally considered to be a *sine qua non* for an attempt to solve any regional problem of nontrivial dimensionality.



The discussion then moved to the relations between the abstract problems chosen for solution and the real problems they represent. It was mentioned that one must always be aware of how far one can go with existing abstract models and that the choice of abstract models must be made with a serious consideration of existing techniques and their limitations.

In the course of constructing a system for devising a comprehensive plan for a region one must carefully consider for whom the plan is prepared. A great number of diverse users of such a plan, as is usually the case in practice, makes the problem more complicated. The question of who will implement the plan is important as well.

The necessity of recognizing the regional problem structure to be dealt with was acknowledged. The use for it of some advanced techniques, available in a computer package form, as, e.g., DEMATEL, promises to attain good results. One should, however, not only recognize the present structure, but also to some extent the future one.

While building a model for an ultra-long-term IRDP (say, 30 years), one must be very careful. For such a long period it is very difficult, or even impossible, to predict technological progress and structural changes. Such a long horizon will probably not create any trouble in the modeling regions in which the utilization of natural and energy resources plays a key role. This is, however, not the case in Kinki where, rather than energy and raw materials, people and industry are the driving forces. It seems that, owing to rapid, revolutionary changes in the Japanese economy, a shorter planning horizon would be more adequate. It was, however, stated that this problem will probably be alleviated because of the slower pace of economic development in Japan assumed for the future. The infrastructure problems should possibly involve longer horizons.

There was some doubts about whether the assumption that the population distribution depends on the industry distribution and some fiscal factors, without taking into account the attractiveness of places under consideration, is adequate enough. The sufficiency of assuming the transportation costs to be the only objective function at the second stratum was also questioned.

As to regional trade dependence and specialization, the secular decline in the degree of specialization in Japan was first mentioned. The transformation into the service society was given as the main reason. Some problems as to a regional rivalry in specialization were also mentioned, stressing that sparsely populated and distant regions would probably have a difficult time surviving.

The sensitivity of regions to export changes was the next question considered. As to the regional models to be built, it was seen as desirable to introduce some weak nonlinearity and to pay more attention to robustness.



Part V

MODELS FOR PROBLEM AREAS

CURRENT RESEARCH DIRECTIONS IN PROBLEMS OF  
TERMINAL SITE LOCATION

Y. Nagao and I. Wakai  
*Department of Transportation Engineering,  
Kyoto University, Kyoto, Japan*

ABSTRACT

This paper, like previous ones, intends to facilitate overall evaluation, expanding the cost-benefit theory by incorporating the problems of surrounding areas.

From the viewpoint of land use, we are able to apply linear programming to mixed land use, while 0-1 mixed-integer programming is applicable where mixed land use is not possible. We shall then be able to establish a standard of decentralized achievement by the application of duality problems to the model.

Although this paper cannot provide a direct and complete solution for actual problems, the method proposed may become a valuable information source for policy making.

1. INTRODUCTION

In locating large-scale airports, ports, harbors, and truck terminals, a single choice is made after consideration of several alternative sites. This choice is made after comparing sacrifices required for the relief of congestion, changes that will be demanded in the future, improvement of services for the user, improvement of traffic industry management, etc.

In such decisions, the terminal location planning has recently tended to recognize systematically that part of traffic network planning that connects the origin and destination of freight.

In many cases, natural, economic, and social conditions are listed in the evaluation of sites, and the cost benefit or cost effectiveness analysis is used as a basis for the final judgment. In some cases, these analyses are criticized, however, because in reality there exists a gap in the measuring of benefits and costs, determination of social discount rate, and weighing of importance among multiple objectives. In particular, these analyses are not satisfactory for dealing adequately with external or environmental effects on the surrounding area.

This study intends to extend the cost benefit theory to this problem and to interiorize the surrounding-area problems into the terminal location problem in order to evaluate them comprehensively.

## 2. INTERIORIZING OF SURROUNDING AREA PROBLEMS

The evaluation of a traffic network project containing a terminal site  $k$  is represented by

$$PNB(k) = PB(k) - PC(k)$$

or

$$R(k) = PB(k)/PC(k) \quad (1)$$

where  $PB$  and  $PC$  are "benefits" and "costs" in present values, respectively.  $PNB$  and  $R$  are net present value and cost-benefit ratio, respectively, which are expected to have a positive value and a value greater than 1, respectively. The alternative yielding the largest value is the most desirable.

The following equation classifies the offerer of a terminal by  $S$ , the terminal by  $k$ , the user by  $D$ , the inhabitants affected by positive benefits in the region by  $E_1$  and inhabitants affected by negative repercussions by  $E_2$ . Then  $PB(k)$  and  $PC(k)$  in (1) are rewritten as follows:

$$PB(k) = \sum_j PB_j(k) = PB_S(k) + PB_D(k) + PB_{E_1}(k) + PB_{E_2}(k)$$

or

$$PC(k) = \sum_j PC_j(k) = PC_S(k) + PC_D(k) + PC_{E_1}(k) + PC_{E_2}(k)$$

(2)

where  $j = S, D, E_1, E_2$ .

The offerer of the terminal has to have profitability and the user has to have an increment in consumer surplus (direct benefits). For the affected parties in the surrounding area, the indirect benefits that accrue from the terminal must outweigh the negative effects such as nuisance created by the increase of traffic. Hence, the evaluation equation needs the following constraint:

$$PB_j(k) \geq PC_j(k) \quad (3)$$

Generally, besides  $PC_{E_2}(k)$ , consideration is limited to noise, exhaust gas, vibration, water pollution, and changes in the landscape, all of which are separately evaluated as other aspects of the planning; in other words, these many factors are separately evaluated as an environmental effect assessment for a given project. In this case, the constraint establishes an environmental quality standard for each environmental item, and if the quality of a given item does not satisfy its environmental quality standard:

- the alternative is modified or rejected, or
- the sources of pollution are controlled.

However, when the project or the given items do not respond to these methods, or when the costs involved in applying them are prohibitively high, a third method is used:

- the environmentally affected parties take some action.

In this case, it is necessary and sufficient to consider three courses of action: (a) behavioral, (b) developmental, and (c) locational [1].

A behavioral action involves, for example, changes of living style caused by noise pollution, or the installation of noise-proof facilities in buildings; the quality of life, however, is not changed. A developmental action involves changes in the quality of life corresponding to changes in land use. A locational action involves not only changes in land use, but the removal of life's activities to another place.

To explain this in more detail, the objective region is divided appropriately into  $N$  square meshes. The following notation is defined in terms of a given one of these meshes, which will be called mesh  $i$ . In this case, the environment of one mesh is evaluated by  $H$  environmental evaluation items. The weighing or ordering of an environmental evaluation may differ according to the land use in a region.

- ${}_iL_h$  — present level of environmental evaluation item  $h$  in mesh  $i$ .
  - ${}_iB_k$  — standard of environmental evaluation item  $h$  for land use  $k$  (e.g., environmental quality standard).
  - ${}_iZ_h$  — degree of planning for environmental evaluation item  $h$  in mesh  $i$ .
- ( $i = 1, 2, \dots, N$      $h = 1, 2, \dots, H$      $k = 1, 2, \dots, K$ )

Hence, if  ${}_iL_h \geq {}_iB_k$  it is not necessary to make behavioral, developmental, or locational space changes.

$$(h^y_i =) h^L_i \geq h^B_k \quad (4)$$

If  $h^L_i < h^B_k$ , it is necessary to make behavioral, developmental, or locational space changes.

$$(h^y_i \geq) h^B_k > h^L_i \quad (5)$$

The environment in a region is evaluated according to the areas of human flow, living conditions, and conditions of work corresponding to land use. The environmental evaluation items consist of land features such as geography and geology, and those factors that are affected by other regions. For example, noise pollution, air pollution, water pollution, traffic accidents, and time or cost of commuting to school, work, or shopping, which fall under the categories of health, safety, convenience, and economy, are caused and influenced by factors in regions outside the one under consideration.

This is called the interaction effect between the district  $i$  under consideration and the affecting district  $j$ . One method of representing this is the following:

$$m^{\phi}_i = \sum_{j \neq i} \frac{m^{\psi}_{j \neq i}}{R^1_{ij}} \quad (6)$$

where

- $m^{\phi}_i$  — the interaction effect on environmental evaluation item  $m$  of district  $i$ .
- $R^1_{ij}$  — the distance resistance between districts  $i$  and  $j$  (e.g.,  $R$  is distance, 1 is constant).
- $m^{\psi}_{j \neq i}$  — the potential to influence the interaction effect in district  $i$  of environmental evaluation item arising in district  $j$  (e.g., noise, exhaust gas etc.).

$m^{\phi}_i$  has the same character as  $h^L_i$  but they differ in that the former involves mutual influences among distances and the latter is specific for a given district.

If, at a given point, the conditions are expressible in equation (4) then these are not environmental problems, but if the situation falls under equation (5), some kind of action must be undertaken. When behavioral space-change by people to their environment becomes impossible or when a project is designed without regard to the district under consideration, then equation (5) is suggested. However, there are an infinite number of solutions that satisfy the conditions for equation (5). The following is one possibility.

Without considering the location at this point, if  $C_{i.1}$  is the behavioral cost in district  $i$ , and  $C_{i.2}$  is the developmental cost, then the cost functions are as follows:

$$C_{i \cdot 1} = \sum_{h=1}^H C_{ih} (h^L_i, h^B_k, h^Y_i) \quad (7)$$

$$C_{i \cdot 2} = \sum_{k=1}^K C_{ik} (k^X_i, k^S_i) \quad (8)$$

where

$k^X_i$  — the 0-1 variable representing the planned land use,  
 = 1 if land use  $k$  is applied in district  $i$   
 = 0 otherwise

$k^S_i$  — the 0-1 variable representing the present land use,  
 = 1 if land use  $k$  is applied in district  $i$   
 = 0 otherwise

In addition, there are the following constraints:

$$0 \leq \sum_{k=1}^K k^X_i \leq 1 \quad 0 \leq \sum_{k=1}^K k^S_i \leq 1 \quad (9)$$

In the cases where mixed land use is forbidden, equation (9) is constrained to allow only single land use.

If we rewrite equation (5) using a 0-1 variable, then it becomes:

$$h^Y_i \geq h^B_k \cdot k^X_i \quad (5')$$

Further, the factors constraining the demand and resources yield the following equation:

$$\sum_{i=1}^V k^D_i \cdot k^X_i \geq D_K \quad (K = 1, 2, \dots, K) \quad (10)$$

$$k^D_i \cdot k^X_i \leq k^A_i \quad (11)$$

where

$k^D_i$  — the degree of planning in district  $i$  for land use  $k$

$D_K$  — the total demand for land use  $k$  in the region

$k^A_i$  — the possible capacity for land use  $k$  in district  $i$

Now, if for simplification, we do not consider the interaction among districts, the economical action that satisfies the constraints mentioned above is expressed in terms of equations (4) and (5) as follows:



$$\begin{aligned}
I_1 &= \sum_{i=1}^N \sum_{k=1}^K C_{i \cdot 1} + \sum_{i=1}^N C_{i \cdot 2} \\
&= \sum_{i=1}^N \sum_{k=1}^K \sum_{h=1}^H C_{i h} (h^Y i, h^B k, h^L i) \\
&+ \sum_{i=1}^N \sum_{k=1}^K C_{i k} (k^X i, k^S i) \tag{12}
\end{aligned}$$

where  $I_1$  is the arrangement cost. We minimize the objective function (12).

### 3. MODEL FORMULATION

Let us restate the assumptions in our model formulation [2]:

- The total land use demand in the region is constant.
- The locational pattern of municipal facilities such as roads, railways, airports, stations, gas and electrical services, water supply etc., in the region is given (note that the municipal institutions such as schools and hospitals are classified as residential facilities).
- The capacity ratio is given as a figure related only to land use.
- The environmental items can be classified independently of one another, and their levels can be ordered.
- The environmental quality standards are given.
- The environmental quality standard of the objective area is satisfied by a combination of improvemental, developmental, and locational space changes.
- The effect on surrounding districts accompanying the changes in land use is negligible.
- The costs accompanying developmental or locational changes are not related to the distance.
- Cost is proportional to the occupied land area.

#### 3.1. Case of Single Land Use

The notations may be explained as follows:

- $k^Z_i$  — the present mix ratio of land use  $k$  in mesh  $i$   
( $0 \leq k^Z_i \leq 1$ )
- $A^k$  — the total floor space with land use  $k$  in all of the locational sites
- $A$  — the total area of the alternative site
- $k^A_i$  — the total floor space with land use  $k$  in the whole of mesh  $i$
- $A_i$  — the total usable space in mesh  $i$

- $k^{C_{i.1}}$  — the cost of improvements for land use  $k$  in mesh  $i$   
 $k^{C_{i.2}}$  — the developmental cost for land use  $k$  in mesh  $i$   
 (note  $k^C$  is the developmental cost for land use  $k$ ,  
 $k^{C_{i.2}} = k^C \cdot A_i$ )  
 $k^{C_3}$  — the locational cost for land use  $k$  in all of the  
 alternative locational sites  
 $k^{X_i}$  — a 0-1 variable  
 = 1 if land use  $k$  is effected in mesh  $i$   
 = 0 otherwise  
 $w^k$  — a continuous variable; the mix ratio of land use  
 in all of the alternative land use sites  
 $I$  — the total cost (note it includes only the arrangement  
 cost)

Further, the developmental cost is proportional to the area; this is represented in the conceptual scheme shown in Figure 1.

The cases of single land use are formulated as follows: we now have the following 0-1 mixed integer programming problem [3, 4, 5]

$$\begin{aligned}
 \text{Minimize } I = & \sum_{i=1}^N \sum_{k=1}^K k^{C_{i.1}} \cdot k^{X_i} + \sum_{i=1}^N \sum_{k=1}^K k^{C_{i.2}} (1 - k^{Z_i}) k^{X_i} \\
 & + \sum_{k=1}^K k^{C_3} w^k = \sum_{i=1}^N \sum_{k=1}^K [k^{C_{i.1}} + k^{C_{i.2}} (1 - k^{Z_i})] k^{X_i} \\
 & + \sum_{k=1}^K k^{C_3} w^k \quad (13)
 \end{aligned}$$

subject to

$$\sum_{i=1}^N k^{A_i} \cdot k^{X_i} + A^k w^k \leq D_k \quad (k = 1, 2, \dots, K) \quad (14)$$

$$0 \leq \sum_{k=1}^K k^{X_i} \leq 1 \quad (i = 1, 2, \dots, N) \quad (15)$$

$$0 \leq \sum_{k=1}^K w^k \leq 1 \quad (k = 1, 2, \dots, K) \quad (16)$$

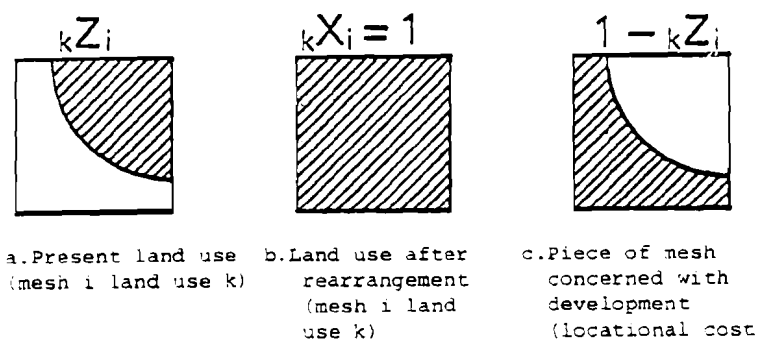

Figure 1. Conceptual scheme for calculating development (locational) cost for single land use.

### 3.2. Case of Mixed Land use

The notation is the same as in 3.1. In this case, however, the variable  ${}_kX_i$  is continuous, representing the mix ratio of land use  $k$  in mesh  $i$  ( $0 \leq {}_kX_i \leq 1$ ). Figure 2 shows the linear relationship between the developmental cost and the mix ratio expressed as a conceptual scheme.

Before the formulation, let us define the variable  ${}_kX_i$  as the variables  ${}_kX_i(1)$  and  ${}_kX_i(2)$ , and apply separable linear programming:

$${}_kX_i = {}_kX_i(1) + {}_kX_i(2) \quad (17)$$

$$0 \leq {}_kX_i(1) \leq {}_kZ_i \quad 0 \leq {}_kX_i(2) \leq 1 - {}_kZ_i \quad (18)$$

note: if  ${}_kX_i(1) < {}_kZ_i$ , then  ${}_kX_i(2) = 0$ .

Hence, the formulation is as follows: we now have the following linear programming problem [6, 7]:

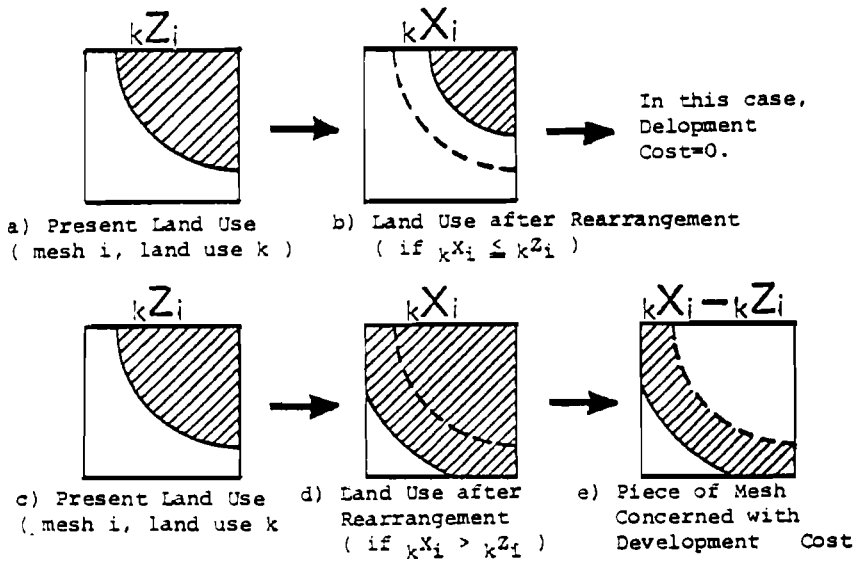

Figure 2. Conceptual scheme for calculating development cost for mixed land use.

$$\begin{aligned}
\text{Minimize } Z &= \sum_{i=1}^N \sum_{k=1}^K k^{C_{i \cdot 1}} (k^{X_{i(1)}} + k^{X_{i(2)}}) \\
&+ \sum_{i=1}^N \sum_{k=1}^K k^{C_{i \cdot 2}} k^{X_{i(2)}} + \sum_{k=1}^K k^{C_3} W^k \\
&= \sum_{i=1}^N \sum_{k=1}^K k^{C_{i \cdot 1}} k^{X_{i(1)}} + \sum_{i=1}^N \sum_{k=1}^K (k^{C_{i \cdot 1}} \\
&+ k^{C_{i \cdot 2}}) k^{X_{i(2)}} + \sum_{k=1}^K k^{C_3} W^k \tag{19}
\end{aligned}$$

subject to

$$\sum_{i=1}^N k^{A_{i(1)}} (k^{X_{i(1)}} + k^{X_{i(2)}}) + k^{A_2} W^k \geq D_k \tag{20}$$

( $k = 1, 2, \dots, K$ )

$$0 \leq \sum_{k=1}^K (k^{X_{i(1)}} + k^{X_{i(2)}}) \leq 1 \tag{21}$$

( $i = 1, 2, \dots, N$ )

$$0 \leq \sum_{k=1}^K W^k \leq 1 \tag{22}$$

$$0 \leq k^{X_{i(1)}} \leq k^{Z_{i(1)}} \tag{23}$$

$$0 \leq k^{X_{i(2)}} \leq 1 - k^{Z_{i(2)}} \tag{24}$$

#### 4. APPLICATIONS AND DISCUSSION

The objective area of this study is a district located to the east of Osaka International Airport. This district is located beneath the paths of landing aircraft and is affected by various problems such as air pollution, aircraft noise, and noise arising from factories and expressways. On the other hand, its location offers a convenient mass transportation to the central business district. For this reason, the district has developed as a typical urban sprawl since World War II and is characterized by densely crowded low-cost apartment houses. In general, therefore, it is a very poor living environment.

We applied the zoning measure of a 200 m x 200 m square to the objective region mentioned above in this study and in our calculations we used the data for the 400 m x 400 m square derived from the data for the 200 m x 200 m square [8, 9]. Then, as independent environmental evaluation items were introduced, not only the aircraft noise but also natural geographic conditions,

convenience of railways and roads, and traffic noise and air pollution conditions. These have been ranked in Table 1 so that they may be handled systematically. In addition, the environmental quality standard for each land use of the objective region in this study is shown in Table 2.

In setting these standards, we referred to the reports, laws, and regulations published or issued by the central and rural governments [10, 11]. Further, the values with respect to costs and total capacity ratio for each land use, shown in Tables 3 and 4, were derived from various reference materials [12, 13]. Based on the data mentioned above, the optimal solutions and costs for six cases are shown in Table 5.

In addition, the present state of land use in the objective region, the land use by the rearrangement method of case 2, and the land use by the rearrangement method of case 5 are shown in Figures 3-5 as examples. Further, the computation time for each case is shown in Table 6.

The conclusions drawn from the results obtained above may be summarized as follows:

(i). When there is an airport involved, the rearrangement cost is about 100 billion yen greater than cases not involving airports.

(ii). A rearrangement method that ignores the improvement method is more expensive than one that includes it. This is due to the high cost of developing the land in the surrounding area, which has been selected as an alternative locational site for the region under consideration.

(iii). Because the total costs have been minimized, the rearrangement pattern of land use in the region is decided arbitrarily. The use of each piece of land is determined without regard to its surroundings. This pattern does not necessarily coincide with patterns that have been hitherto created by government designated objective districts for surrounding and relocation compensation (these designations have been made independently for each land-use category).

(iv). The location pattern of land use for environmental rearrangement tends towards a centralization of each land use in the region. This represents more explicitly the model of single land use.

(v). The total cost of the mixed-land-use model is lower than that of the single-land-use model under the same conditions. Since, however, the mixed-land-use model creates land-use allocation patterns within each mesh, there are latent costs associated with this type of model. Thus, it is difficult to make precise comparisons between the total costs of single-land-use models and those of mixed-land-use models.

Table 1. Environmental evaluation items.

Rank	Natural Conditions		Traffic Conditions		Public Nuisance Conditions		
	Geography	Ground	Railway	Road	Aircraft Noise	Traffic Noise	Air Pollution
1	Mountainous district	Deep bearing stratum Upper soft	Over 1200 m	Only minor street	Over W-95	Bad for residence	Over 0.05 ppm
2	Hill Plateau	Shallower bearing stratum Upper soft	700-1200 m	Compartment street	W-90-95	Good for residence	Under 0.05 ppm
3	Basin Valley	Deep bearing stratum Upper bearing capacity	300-700 m	Along main street (both 100 m)	W-85-90		
4	Flat base	Shallower bearing stratum Upper bearing capacity	Within 300 m	Along arterial road (both 260 m)	W-80-85		
5	Marshy land	Deep bearing capacity Firm base		Near inter-change (within 1km)	Under W-80		

Remarks: "Deep" is defined by a depth of over 15 m and upper bearing stratum with about 50 N value.

Railway--distance from the nearest station.

W--Weighted equivalent continuous perceived noise level (WECPNL).

Traffic Noise--the zone within 100 m from an arterial road has over 60 dB(A).

Table 2. Environmental quality standards.

Environmental Evaluation Items	Residence	Commerce	Industry	Green Space
Geo graphy	2	2	4	1
Ground	3	3	2	1
Railway	2	3	1	1
Road	1	4	5	1
Aircraft Noise	4	3	2	2
Traffic Noise	2	1	1	1
Air Pollution	2	2	1	1

Note: The environmental index values indicate the minimum level that each land use must satisfy.

Table 3. Gross floor space ratio (present situation).

Land use	Residence	Commerce	Industry	Green Space (recreation, sports, etc.)
T- City	41%	95.1%	26.1%	100%



Table 4. Unit costs for improvement, development, and location changes.

(a) Development Cost					
Costs	Removal and Rearrangement of Land	10 <sup>4</sup> yen/m <sup>2</sup>			Environmental Cost/Mesh
		Transfer	Building	Land Purchase	
Land Use					10 <sup>8</sup> yen
Residence	0.8	0.8	8.0	0.0	153.6
Commerce	0.8	1.0	10.0	0.0	188.8
Industry	0.8	0.7	7.0	0.0	136.0
Green Space	0.15	0.0	0.3	0.0	7.2

(b) Locational Cost					
Costs	Removal and Rearrangement of Land	10 <sup>4</sup> yen/m <sup>2</sup>			Environmental Cost/Mesh
		Transfer	Building	Land Purchase	
Land Use					10 <sup>8</sup> yen
Residence	0.8	0.8	8.0	8.0	281.6
Commerce	0.8	1.0	10.0	8.0	316.8
Industry	0.8	0.7	7.0	8.0	264.0
Green Space	0.15	0.0	0.3	8.0	135.2

(c) Improvement Cost			
Environmental	Evaluation Items	10 <sup>4</sup> Yen/m <sup>2</sup>	10 <sup>8</sup> Yen/Mesh
Ground		0.8	12.8
Aircraft Noise		1.0	16.0
Traffic Noise		0.5	8.0

Note, it is impossible to make improvement change for the others.

Table 5. Optimal solutions.

				10 <sup>8</sup> yen
Case with Development and Locational Change Only	Mixed Land Use	With Airport	Case 1	6954
Case with Development Locational, and Improvement Change	Mixed Land Use	With Airport	Case 2	2228
			Case 3	2785
	Single Land Use	Without Airport	Case 4	1827
		With Airport	Case 5	3361
	Without Airport	Case 6	3356	

Table 6. Computation time.

Model Name	Case 1	Case 2	Case 3	Case 4	Case 5	Case 6
Number of Variables	588	588	588	608	136	316
Number of Constraints	662	662	662	667	71	83
Total CPU Time (ms)	58150	133796	138075	137729	11798	18700
Total CORE Time (ms)	457620	694485	718956	691442	87720	91233

Note: Cases 1-4 use linear programming.  
Cases 5-6 use approximate integer programming.

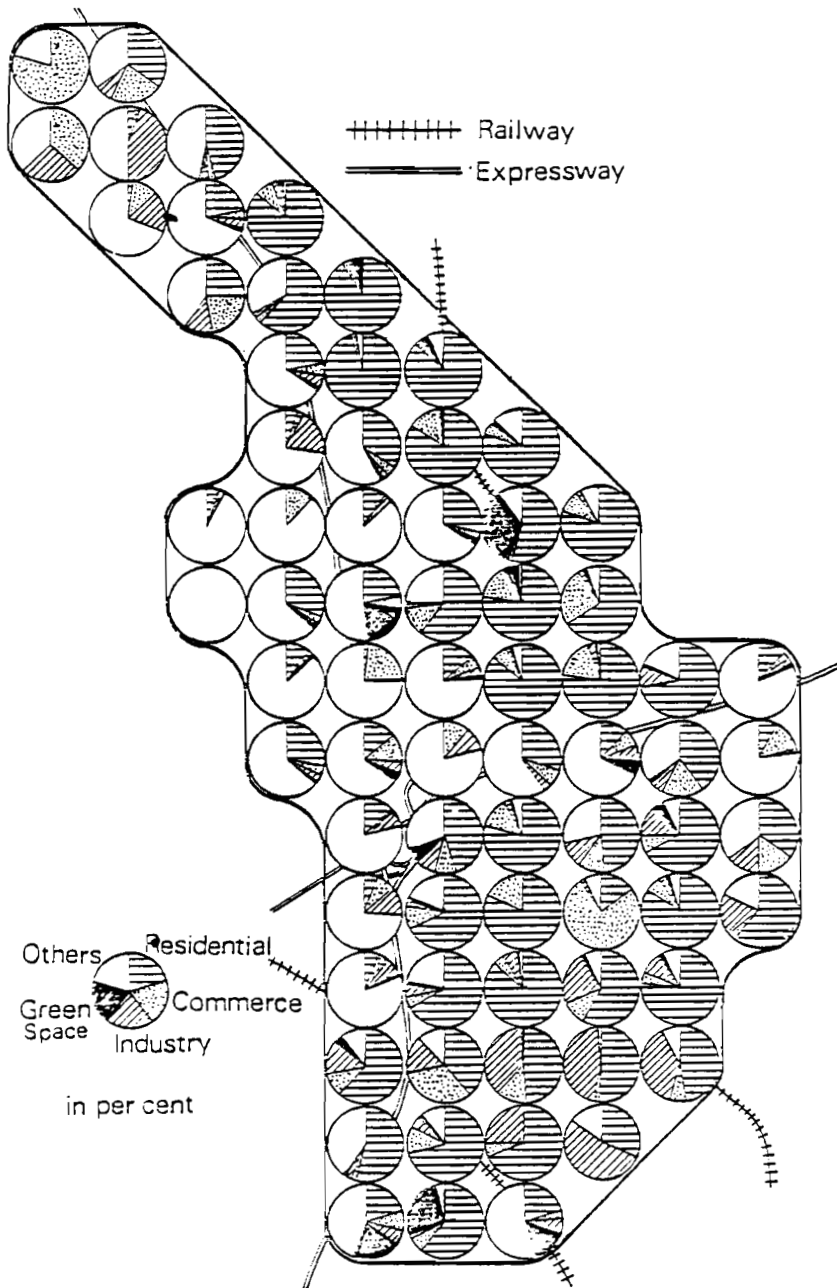

Figure 3. Present land use.

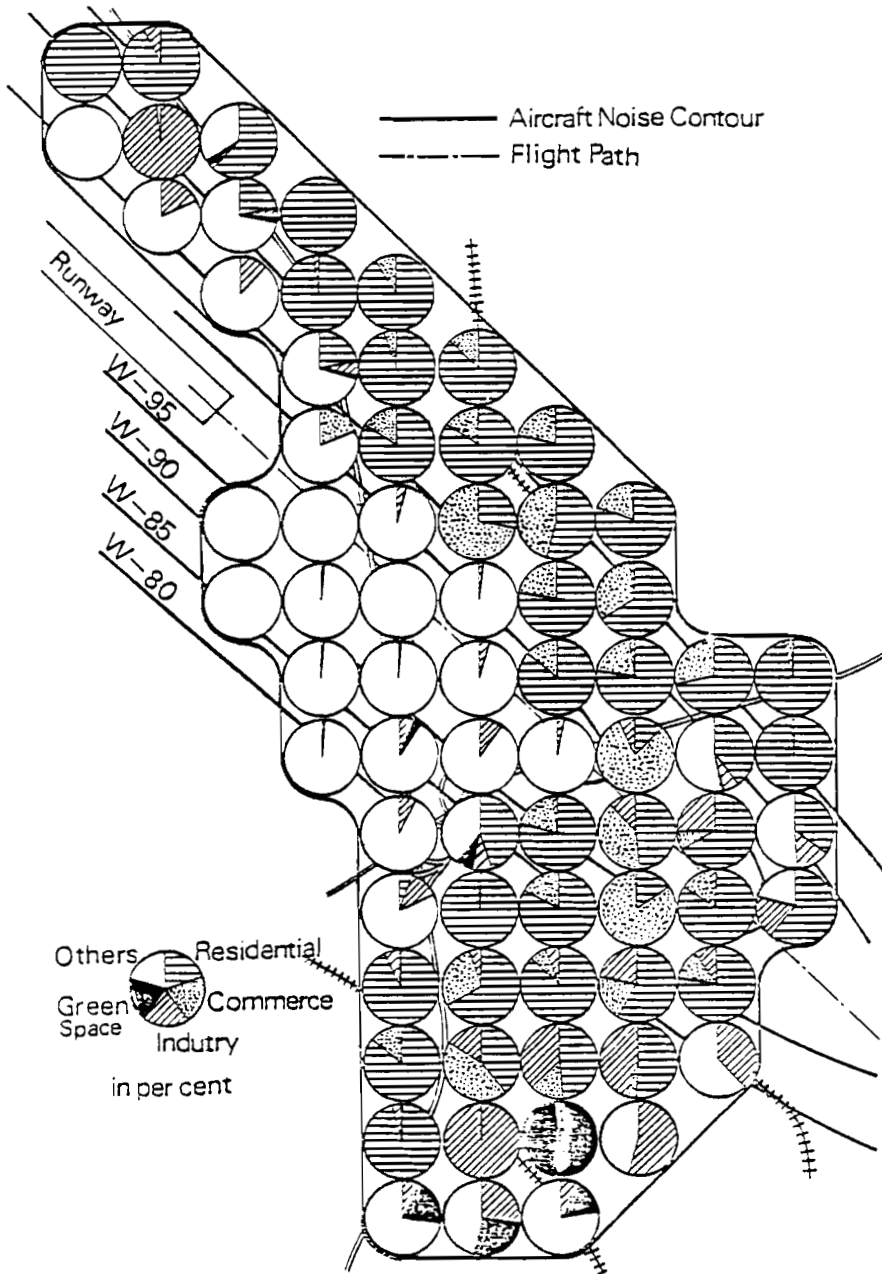

Figure 4. Optimal land use of case 2.

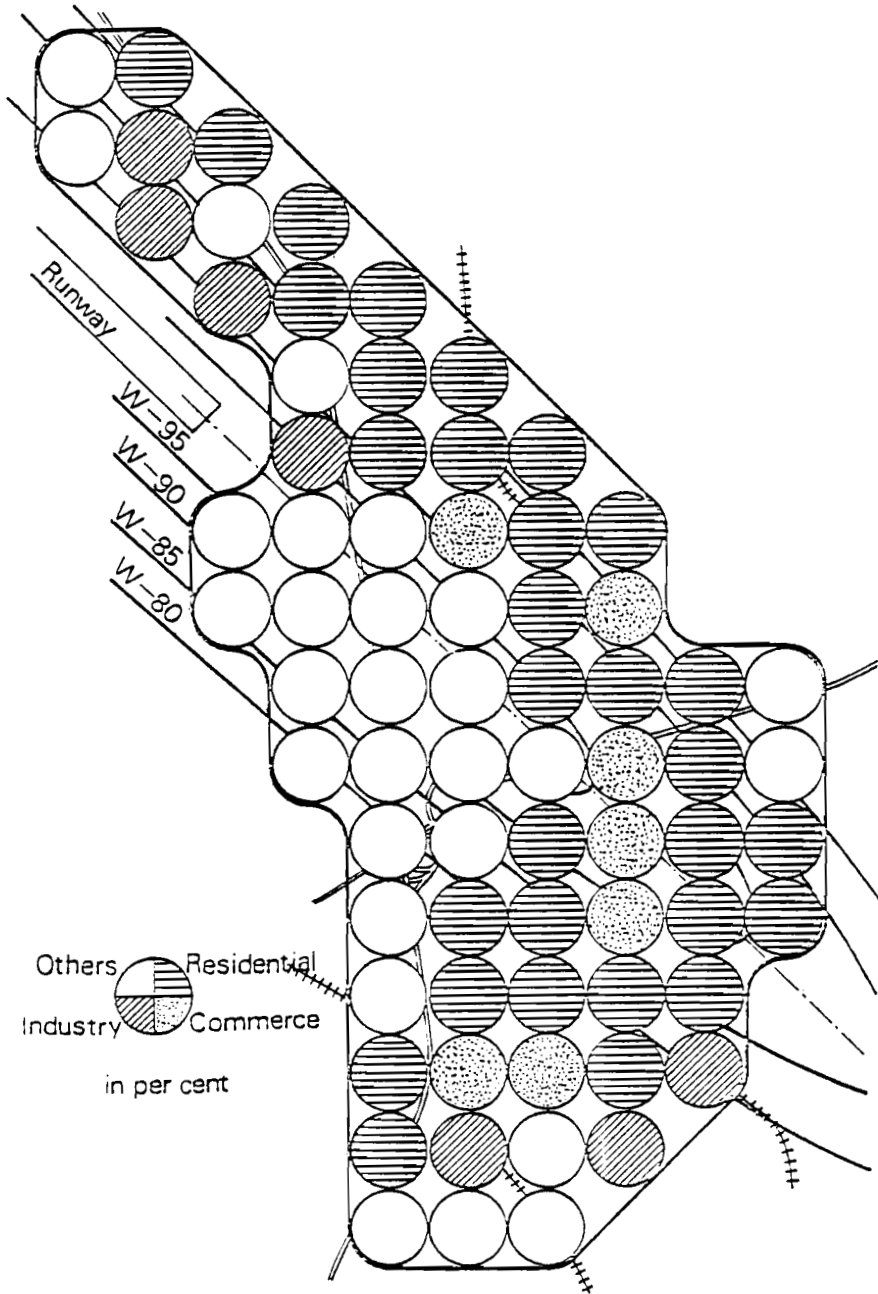

Figure 5. Optimal land use of case 5.

Thus, if we define a social cost from aircraft noise as the difference in the total cost with respect to a rearrangement for land use in objective regions with and without airports, then it is possible to roughly establish the social cost of aircraft noise, responsibility for which should be borne by those causing it. The environmental quality standards used in this study were already established. The method by which they were established is beyond the scope of the present paper and thus will not be dealt with here.

Finally, the value obtained in this manner does not always satisfy the conditions that equation (1) is positive, or equation (3) is greater than one. In particular, it is necessary to transfer benefits from the group comprising the user  $D$  and affecting party  $E$  to the group comprising  $S$  and  $E_2$ , so that the burden of costs is distributed fairly. We can obtain the standards for this decentralization by applying a dual problem to the model mentioned above [14, 15, 16].

As mentioned above, if the transportation and traffic volume at the terminal  $k$  is provided, we can forecast the levels of exhaust gas, vibration, and noise occurring there. We can also calculate the costs required for rearrangement of land use to satisfy the environmental quality standards or demand for pollution prevention corresponding to each land use.

In actual practice, however, authority for the terminal is often invested in local public bodies, which must pay close attention to the demands and desires of local residents. In addition those who use transport services may not always act in the best interests of national economy, since they operate under institutional restrictions such as the nationwide uniform transport fare system, for example, if a terminal is located on the outskirts of a large city. The external diseconomies thereby created may be great, but they are not borne by the transporter; in fact, the transporters will tend to be attracted to such areas by the sizable benefits that can be derived by them from such locations.

In contrast with this, terminal locations having relatively low pollution prevention costs are usually characterized by excessive transport costs, and so tend to be avoided.

Thus, in order to make the physical distribution actually follow a path that is favorable for the national economy, it is necessary to adapt and adjust cost burden, benefit transfer, subsidy, and surcharge systems.

Next, we consider the following three economic bodies as the ones that take action to maximize net benefits:

- central planning body (adjustment body)
- terminal authority body (body offering facilities)
- user or shipper (we assume he is cooperating with the transporter in order to satisfy transportation demand in the region. Herein we will not take up the problem of imputation of benefits among transporters).

The following six policies may be considered as possible adjustment methods of the central planning body.

(i). The terminal authority bodies levy charges of  $\alpha(1 - \alpha \geq \alpha \geq 0)$  times the benefit desired from the terminal use upon terminal users.

(ii). The terminal authorities bear  $\alpha$  times the cost of pollution prevention made necessary by transportation activity taking place at given terminals.

(iii). Subsidies are provided for optimal scale planning and optimal site location of terminals for the purpose of maximizing benefits.

(iv). Penalty charges or surcharges are levied on plans for locational sites that are not truly optimal.

(v). Traffic congestion charges are levied on those who use terminals operating at full capacity.

(vi). The fee of  $(1 - \alpha)$  times the pollution prevention costs necessitated by a given terminal is levied against the users of the terminal.

The above described decentralized achievement is represented in Figure 6. Hence we may think of  $\alpha$  as a policy variable to be determined by the central government. On the one hand, it would appear that the terminal authority bodies should be responsible for the maintenance of public facilities such as the terminals. But the terminal users (shippers) should be responsible for diseconomies arising from the terminal use.

In this view then, it would seem that  $\alpha = 0$ . However, as far as terminal authority bodies levy charges on users of their terminals, it would seem that they should also carry a share of the diseconomies arising so that  $\alpha > 0$ .

## 5. PROBLEMS OF ACTUAL APPLICATION

The cases in which planning methods have fairly evaluated the net costs and cost allocation, especially as they relate to the areas surrounding the terminals, have been few.

In 1967 it became necessary to take some action with regard to large-scale airports, and accordingly "the Act of Prevention of Negative Effects Upon Areas Surrounding Airports" was established. Following the launching of this act, certain airports were designated by government ordinance as ones whose surrounding areas must be rearranged. The government demanded that these airports set up a public corporation, "Organizations for Rearrangement of the Surrounding Area," in order to formulate the rearrangement plans, and to put these plans into practice.

Although these organizations are concerned only with airports, our study has been undertaken in order to propose a methodology for establishing this kind of terminal planning on a broader basis. However, although the environmentally affected areas have a public aspect in the form of roads, railways, ports,

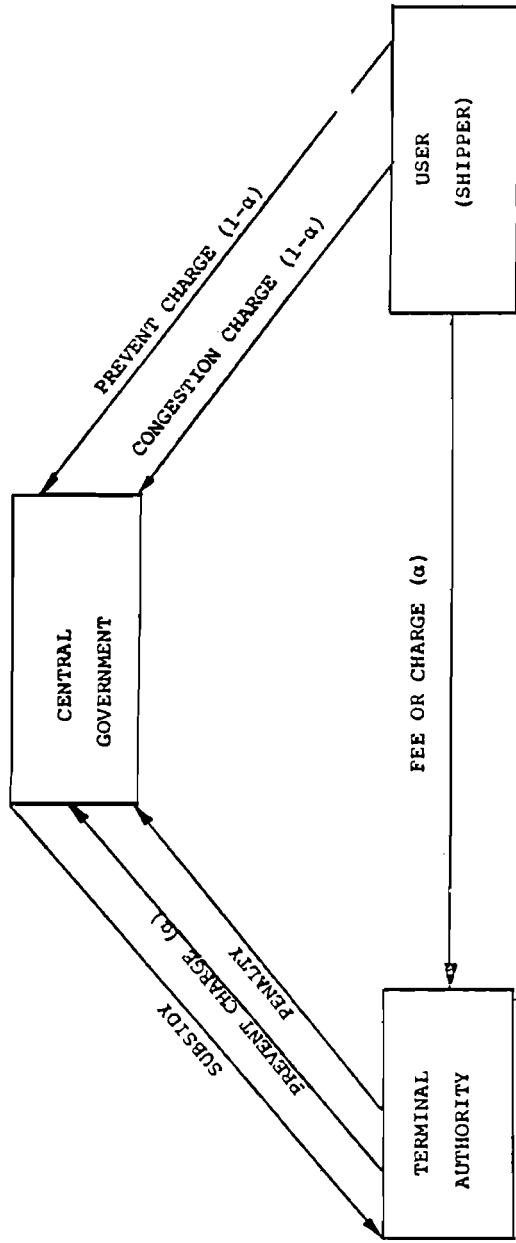

Figure 6. Decentralized system.



harbors, and airports, a substantial problem remains as to what degree the government can legally exercise control over the privately owned land. The results of calculation by the model are not intended to support the rationale, based upon a number of assumptions, that has been derived by the government. In addition, it should be pointed out that there is an aspect of uncertainty based on humanity in the readjustment of benefits and costs in these areas, and a variety of possible responses by the regional inhabitants. Adjustments would create dynamic changes in traffic demand by effecting decentralized achievement, thus creating problems for the surrounding areas. Nevertheless, while this study is not able to provide a direct solution for such problems, we believe that it could serve as a valuable information source to help solve such problems.

#### 6. FURTHER INVESTIGATIONS

As mentioned in section 5, it is necessary to establish a method for the compensation of losses and a defense against pollution caused by frequent take-offs and landings of aircraft at specified airports. We described one of these methods in section 2, but further investigations are required in order to make this method useful. These investigations must concentrate on:

- (i). The measurement of effects on the relevant human and social activities and the natural ecosystems in these areas, and the accumulation of data on direct and indirect benefit costs created by satisfying the traffic demand.
- (ii). Systematization of: (a) comprehensive planning methods contained in the problem of rearranging the surrounding areas, and (b) terminal location planning as a part of the functional efficiency of the flow<sup>of</sup> freight from origin to destination.
- (iii). Proposals of the methodology of decentralized achievement, the executive organizations, and the new institutions created to put this planning into practice.

Although this study will only provide a basis for these investigations, it is considered that it will be very useful whenever the functions of a terminal are increased or new terminals are located in areas of concentrated population and intensive land use such as in Japan.

#### REFERENCES

- [1] McLoughlin, J.B. (1969) Urban and Regional Planning: A System Approach. Praeger.
- [2] Nagao, N., I. Wakai, and K. Hayashi (1975) A development planning method on the surrounding area of the project with environmental impacts. Pages 61-70 in Proceedings of JSCE 243 (in Japanese).

- [3] Ibaraki, T., T. Ohashi, and H. Mine (1973) A Heuristic Algorithm for Mixed Integer Programming Problems. Kyoto: Kyoto University, Faculty of Engineering, Department of Applied Mathematics and Physics.
- [4] Land, A.H., and A.G. Doig (1960) An Automatic Method of Solving Discrete Programming Problems. *Econometrica* 28: 497-520.
- [5] Benders, J.F. (1962) Partitioning Procedures for Solving Mixed-Variables Programming Problems. *Numerische Mathematik*, 4:238-252.
- [6] Dantzig, G.B. (1963) *Linear Programming and Extensions*. Princeton: Princeton University Press.
- [7] McMillian, C., Jr. (1970) *Mathematical Programming*. Wiley.
- [8] Ministry of Construction (1973) Considerations on the Rearrangement of Regions Affected by Airport-Related Pollution (in Japanese).
- [9] Ministry of Construction (1973) Data Compilation (in Japanese).
- [10] The Central Commission on Countermeasures to Pollution, the Noise-Vibration Subcommittee of the Special Committee on Noise Pollution (1973) Report on the Environmental Quality Standards Concerned with Aircraft Noise Pollution (in Japanese).
- [11] Toyonaka City (1971) Problems Associated with Regional Planning in Toyonaka City, 20 (in Japanese).
- [12] Sakaguchi, T. (1970) The effects of topography, soil features, and ground on housing construction costs. Pages 353-356 in Lecture Series of the Soil Engineering Research Publication Group (in Japanese).
- [13] Toyonaka City (1969) Investigation into the Present State of Land Use (in Japanese).
- [14] Manns, A.S. (1964) Plan Location under Economy of Scale, Decentralization and Computation. *Management Science*, 11: 213-235.
- [15] Balas, E. (1970) Duality in discrete programming. Pages 179-198 in Proceedings of the Princeton Symposium on Mathematical Programming, edited by H.W. Kuhn. Princeton: Princeton University Press.
- [16] Nagao, Y., H. Morisugi, and T. Yamada (1976) Method of terminal location and decentralized decision-making under external diseconomy. Pages 93-102 in Proceedings of JSCE 225 (in Japanese).

A SIMULATION MODEL FOR REGIONAL ENVIRONMENTAL IMPACT  
ANALYSIS—A CASE STUDY FOR THE KINKI REGION

Y. Suzuki

*Department of Electrical Engineering, Osaka University,  
Osaka, Japan*

K. Ito

*Department of Mechanical Engineering, University of  
Osaka Prefecture, Osaka, Japan*

T. Ono

*Department of Mechanical Engineering, Osaka University,  
Osaka, Japan*

ABSTRACT

This paper concerns an environmental impact analysis model for decision making in regional planning and management. It is composed of three environmental impact submodels: an air pollution model (APM), a water pollution model (WPM), and a model for solid-waste disposal, especially including plastic waste (SWM). All the submodels are set up to be interconnected in a simple but effective way to analyze the essential features of environmental impacts in the region.

This model has been used to make an impact analysis for the Kinki region, one of the economically important regions in Japan. The results for this case indicate that it is feasible to apply it to assess future environmental impacts due to population increase, to changes in patterns of material consumption, and to industrial activities in the region.

1. INTRODUCTION

During the last two decades Japan has achieved rapid industrial development, but unfortunately it is also facing some serious environmental pollution problems in industrialized areas. It is important to investigate environmental management problems from a broad socioeconomic point of view. So far few research

efforts have investigated regional environmental quality by clarifying quantitatively the interrelations among production, consumption, and pollution.

The purpose of this research is to construct a regional environmental impact model to assess the future environmental impacts due to the population increase and changes in the pattern of material consumption and industrial activities in a region. Combining this model with an integrated regional development planning system [1] as shown in Figure 1, we can expect to find a better regional development strategy for the harmonious balance between socioeconomic activities and environment. The model is constructed so as to estimate each subregional environmental impact quantitatively, and a few environmental impact diagrams will be proposed to illustrate the comparison of environmental quality in subregions.

The Kinki region of middle Japan is selected as the objective area of a case study. It is one of the most economically important regions in Japan and contains lots of socioeconomically different subregions, i.e., metropolitan areas, highly concentrated industrial areas, old capital cities with traditional culture, farm areas, etc.

## 2. STRUCTURE OF THE MODEL FOR REGIONAL ENVIRONMENTAL IMPACT ANALYSIS

In this model, three kinds of pollution phenomena, water, air, and solid wastes, are considered in order to describe the regional environmental quality. The conceptual structure of the model is shown in Figure 2. The model is constructed to calculate the total emissions of pollutants in each subregion. The regional environmental impacts are also calculated taking into account the environmental capacity of each subregion. The definitions of terms in this figure are as follows

- $X$  — pollution sources
- $Z$  — amounts of pollutants generated by source (tons/year)
- $E$  — amounts of pollutants emitted (tons/year)
- $P$  — environmental impact indicators
- $\alpha_{ij}$  — primary generation factor of pollutant, where  $i$  is the type of pollutant and  $j$  is the source of pollutant
- $\beta_{ijk}$  — secondary generation factor of pollutant, where  $i$  denotes the type of original pollutant,  $j$  is the source of pollutant, and  $k$  denotes the type of secondary pollutant
- $\theta_j$  — coefficient of pollution control effect (percent)

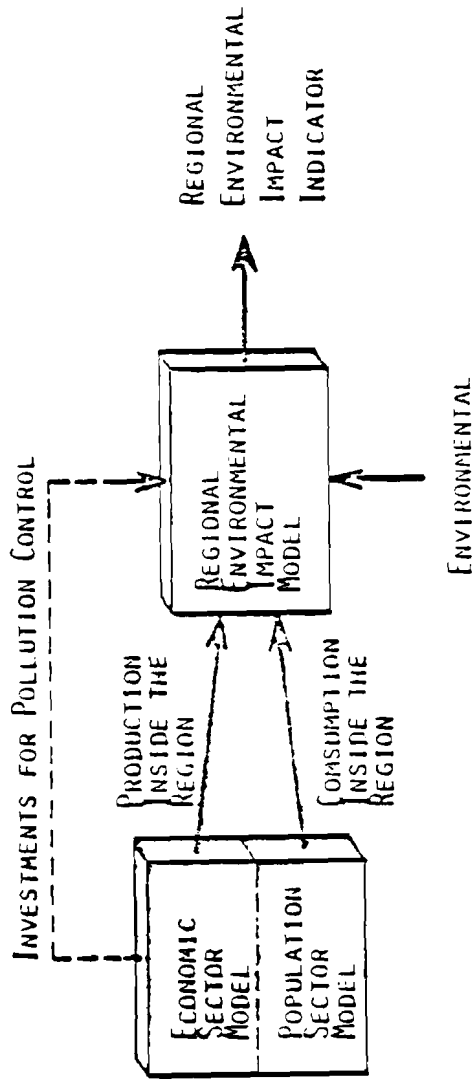

Figure 1. Conceptual framework of the integrated regional management system.

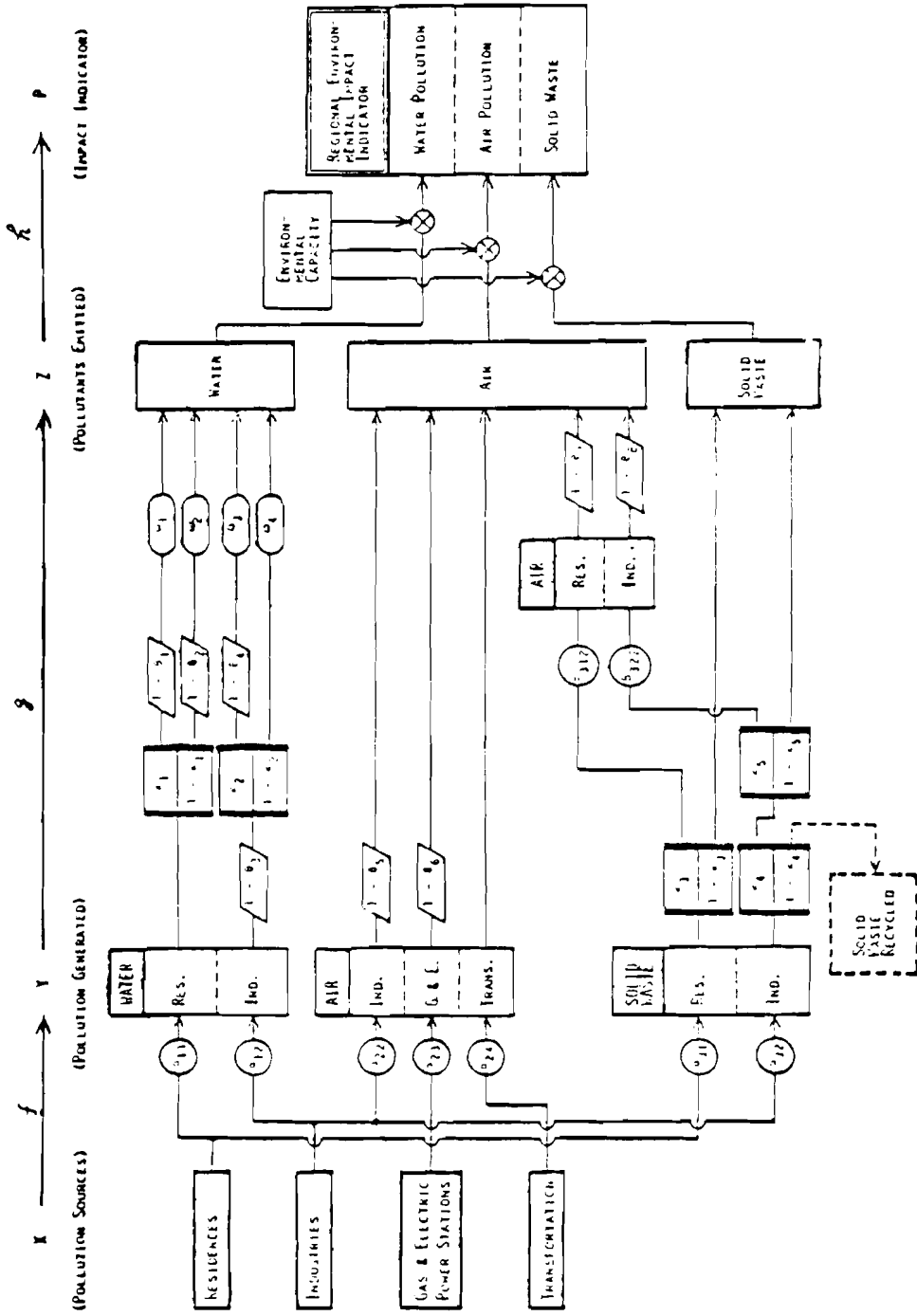

Figure 2. Conceptual structure of the regional environmental impact model.

$\alpha_j$  — treatment ratio of pollutant (percent)

$w_j$  — rate of run-off (percent)

There are three major relationships in the model among the major variables of  $X$ ,  $Y$ ,  $Z$ , and  $P$  as shown at the top of Figure 2.

(i). Raw pollution generation:  $Y = f(X) = \alpha X$ , or  

$$Y_i = \sum_j \alpha_{ij} X_j$$

(ii). Actual pollution emission after controls and treatment:  $Z = g(Y)$ , where  $g$  is a function of  $\beta$ ,  $\theta$ , and  $\omega$ .

(iii). Indication of impact:  $P = h(Z)$ .

Some examples of the relationships (i) and (ii) will be discussed below for each pollution phenomenon. The relationship (iii) will be discussed in the subsection of regional environmental impact indicators.

### 2.1. Water Pollution Model (WPM)

There are many items that indicate the level of water pollution such as pH, BOD, COD, TOC, SS, DO, and heavy metals. As our interest is not to investigate the very special and very localized water pollution phenomenon, it will be sufficient to investigate such items as BOD, COD, or DO. In this model only the BOD value is adopted to indicate the water quality of rivers but it is possible to add other items when it becomes necessary.

#### *Pollution Sources*

Two pollution sources are given as an example to explain the methodology for estimating the pollution load, that is:

- residential: number of inhabitants (persons)
- industrial: annual industrial production amounts, which is expressed by the value of shipments, for 20 industries in terms of Japanese yen (see the Appendix for a list of industrial categories).

#### *Pollutants Generated*

The coefficient  $\alpha_{ij}$  denotes the generation factor, where  $i$  is the type of pollutant and  $j$  is the source of pollutant. For example:

- $\alpha_{11}$  is the generation coefficient for water pollution from residents. It depends on the standard of living and lifestyle of residents and is expressed in units of pollutant generated per unit of source (e.g., the generation factor of BOD in Japan in 1970 is 44 g/person/day) [2]

$\lambda_{12}$  is the generation coefficient of water pollution from industry. It depends on the type of industry, the level of technology, etc., and is expressed in units of tons of pollutant per  $10^6$  yens of production.

#### *Pollutants Emitted*

To estimate the water pollutants emitted, the following factors must be taken into account:

- residential —  $\kappa_1$  (diffusion rate of public sewage)  
 $\theta_1$  (treatment ratio of sewage)  
 $\theta_2$  (night soil treatment ratio)  
 $\omega_1$  and  $\omega_2$  (rates of run-off)
- industrial —  $\theta_3$  (coefficient of waste water control effect within each industry)  
 $\kappa_2$  (diffusion rate of public sewage of industrial waste water)  
 $\theta_4$  (treatment ratio of sewage)  
 $\omega_3$  and  $\omega_4$  (rates of run-off)

#### 2.2. Air Pollution Model (APM)

The air pollutants considered in APM are particulates, sulphur oxides ( $SO_x$ ), nitrogen oxides ( $NO_x$ ), hydrocarbons (HC), and carbon monoxide (CO).

#### *Pollution Sources*

As sources of air pollution, the industrial, transportation, and gas and electric power generation sectors are taken into account in APM. The residential and commercial sectors are neglected because of the difference of the method of energy consumption of these sectors in Japan compared with other countries. However, it should be noted that the APM in Figure 2 includes secondary air pollution caused by incinerating solid wastes.

Pollution sources of industrial sectors are classified into 20 categories like WPM, and pollution sources of gas and electric power stations are categorized by the type of station and by the transportation sector. Let us consider motor vehicles classified into nine groups according to the possible combinations of items between the following two categories; that is, by type of vehicle (passenger car, truck, bus, and vehicle for special use), and by type of fuel (gasoline, LPG, diesel oil).



*Pollutants Generated and Emitted*

The following emission factors are adopted in APM to estimate pollution loads from industrial, and gas and power generation sectors:

- $\alpha_{22}$  is the generation coefficient of air pollutants from industry, which depends on the type of industry, and is expressed in units of tons of pollutant per  $10^6$  years of industrial production.
- $\alpha_{23}$  is the generation coefficient for gas and electric power stations, which depends on the type of station, on the type of fuel used there, etc., and is expressed in units of tons of pollutant per unit of fuel used.

In Figure 2,  $\theta_5$  and  $\theta_6$  indicate the coefficients of air pollution control effects.

Concerning the transportation sector, the generation factor of each pollutant  $\alpha_{23}$  (g/day/car) is estimated taking into account the average driving distance and speed and the average fuel consumption for each type of vehicle mentioned previously. No pollution control devices are considered here; that is, we assume that both the generation and emission amounts of pollutants are equal to each other ( $Z = Y$ ).

## 2.3. Solid Wastes Model (SWM)

*Pollution Sources*

There are many kinds of solid wastes and problems to be taken into account here. However, since the main purpose of this study is to investigate the regional environmental impacts related to regional human activities, it is not necessary to study this problem in greater detail. In this model, let us focus our attention particularly on the problem of plastic wastes, which are typical and important solid wastes. As pollution sources of SWM, the residential and industrial sectors are taken into account.

*Pollutants Generated and Emitted*

The generation factors of solid wastes for residential and industrial sectors,  $\alpha_{31}$  and  $\alpha_{32}$ , respectively, have already been investigated in many regions in Japan. The percentage of plastic waste included within the solid waste is well estimated, and it is possible to adopt those data in SWM. The factors involved in this SWM are:

- $\langle_3$  and  $\langle_5$  — treatment ratios by incineration
- $\langle_4$  — recycling ratio of plastic waste for industrial sector

$\beta_{312}$  and  $\beta_{322}$  — generation factors of secondary air pollution by incineration from residential and industrial sectors, respectively.

$\theta_6$  and  $\theta_7$  — coefficients of air pollution control effect.

#### 2.4. Impact Indicator Diagrams

It is very important to indicate regional environmental impacts  $P$  caused by particular pollution loads  $Z$  taking into account the regional environmental capacity [ $P = h(Z)$ ]. In this paper, some primary indicators are illustrated as impact indicator diagrams to give a rough image of the environmental situation in each subregion.

##### *Water Pollution*

As an indicator of environmental capacity, the combinations of both low and mean water discharges of rivers are meaningful. Since it is impossible to take into account many small rivers and channels flowing in the region, only first class rivers are considered here, to give a macroscopic idea of environmental capacity for water pollution. As regional environmental impact indicators of water pollution, two indicators  $P_4$  and  $P_5$  will be acceptable, i.e., emitted load of pollutant divided by low and mean water discharges of rivers flowing within a subregion, respectively.

##### *Air Pollution and Solid Wastes*

As an environmental capacity measure for both air pollution and solid wastes, the land use, broken into three categories (metropolitan, rural, and wilderness) of each subregion will be roughly applied. For air pollution it is of course necessary to take into account in the environmental capacity the meteorological conditions, but they will be omitted in this macroscopic regional environmental impact analysis. However, results obtained with the model will indicate the relative pollution level of each subregion, and using this result, we can select some relatively more polluted subregions in which more detailed investigations should be carried out.

Let us omit the influence of pollutants from surrounding areas, and also exclude from consideration the wilderness area (mountains, woods, and forests). As there exist great differences of pollution level between urban and rural districts in each subregion, we divide the inhabitable area of each subregion (HA) into two areas, that is: metropolitan area (MA) and rural area (RA), such that  $HA = MA + RA$ . As it seems to be difficult to define MA and RA exactly, the area of densely inhabited district (DID)\* is adopted for MA, and we consider  $(HA - DID)$  as RA.

---

\*The precise definition of DID is as follows [3]: A densely inhabited district (DID) is a group of contiguous enumeration districts with high population density (4,000 inhabitants or more per km<sup>2</sup>) delineated within the boundary of a city, town, or village, constituting an agglomeration of 5,000 inhabitants or more, as the enumeration districts were established.

Accordingly, let us introduce the following three regional environmental impact indicators:

Indicator  $P_1$  — (pollutants emitted in HA)/HA

Indicator  $P_2$  — (pollutants emitted in MA)/MA

Indicator  $P_3$  — (pollutants emitted in RA)/RA

Adopting these indicators, we can compare the environmental pollution levels of each pollutant for each subregion divided by urban and rural areas as shown in Figure 3.

### 3. CASE STUDY FOR THE KINKI REGION

This section is devoted to checking the feasibility of the model described in the previous section for regional environmental impact analysis. For this purpose, the Kinki region is tentatively selected as the case study region. It is located in the middle of Japan, and consists of seven subregions (Fukui, Shiga, Kyoto, Osaka, Hyogo, Nara, and Wakayama prefectures) as shown in Figure 4.

#### 3.1. Input Data and Parameters of the Model

Table 1 shows some necessary input data which explain socio-economic activities and land-use patterns in each subregion of the Kinki region in 1970.

Concerning the generation and emission coefficients of pollutants, and control coefficients, national average values are mainly adopted in this model [2, 4, 5, 6].

##### *Water Pollution Model*

The values of the above-mentioned coefficients used in WPM are:

$$\beta_1 = 90(\%) \quad \beta_2 = 58(\%) \quad \beta_4 = 90(\%)$$

$$\omega_1 = \omega_2 = \omega_3 = 10(\%) \quad \text{and} \quad \omega_4 = 40(\%)$$

The value of  $\beta_3$  is also assumed so as to reduce the BOD load from each industry uniformly under 120 ppm.

If there is a river that flows down from the surrounding subregions, then some portions of the pollution loads due to the upper reaches of the river should be taken into account as the pollution load of the downstream subregion. Figure 5 indicates the flow fractions of pollution load among seven subregions. As the distances of all the rivers flowing in the Kinki region are not long, the self-purification phenomenon within the river is not taken into account in WPM.

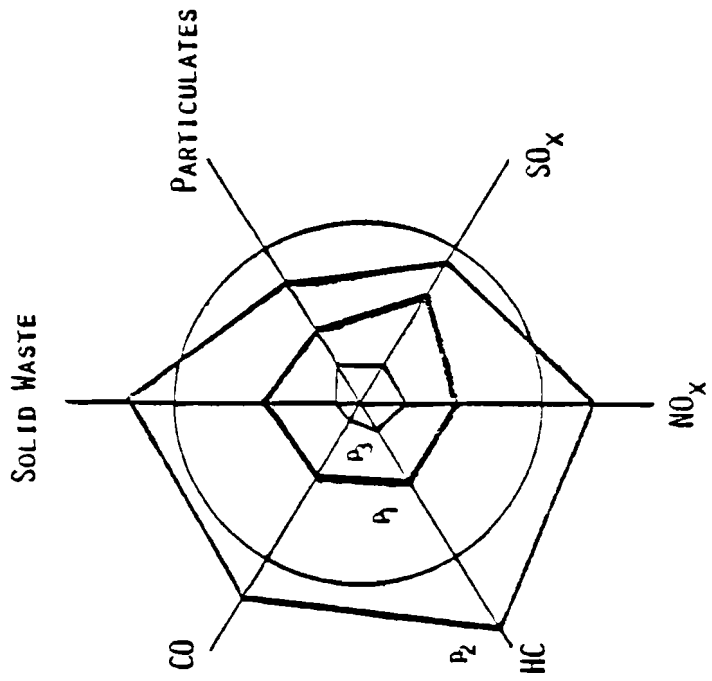

Figure 3. Impact indicator diagram of each subregion.

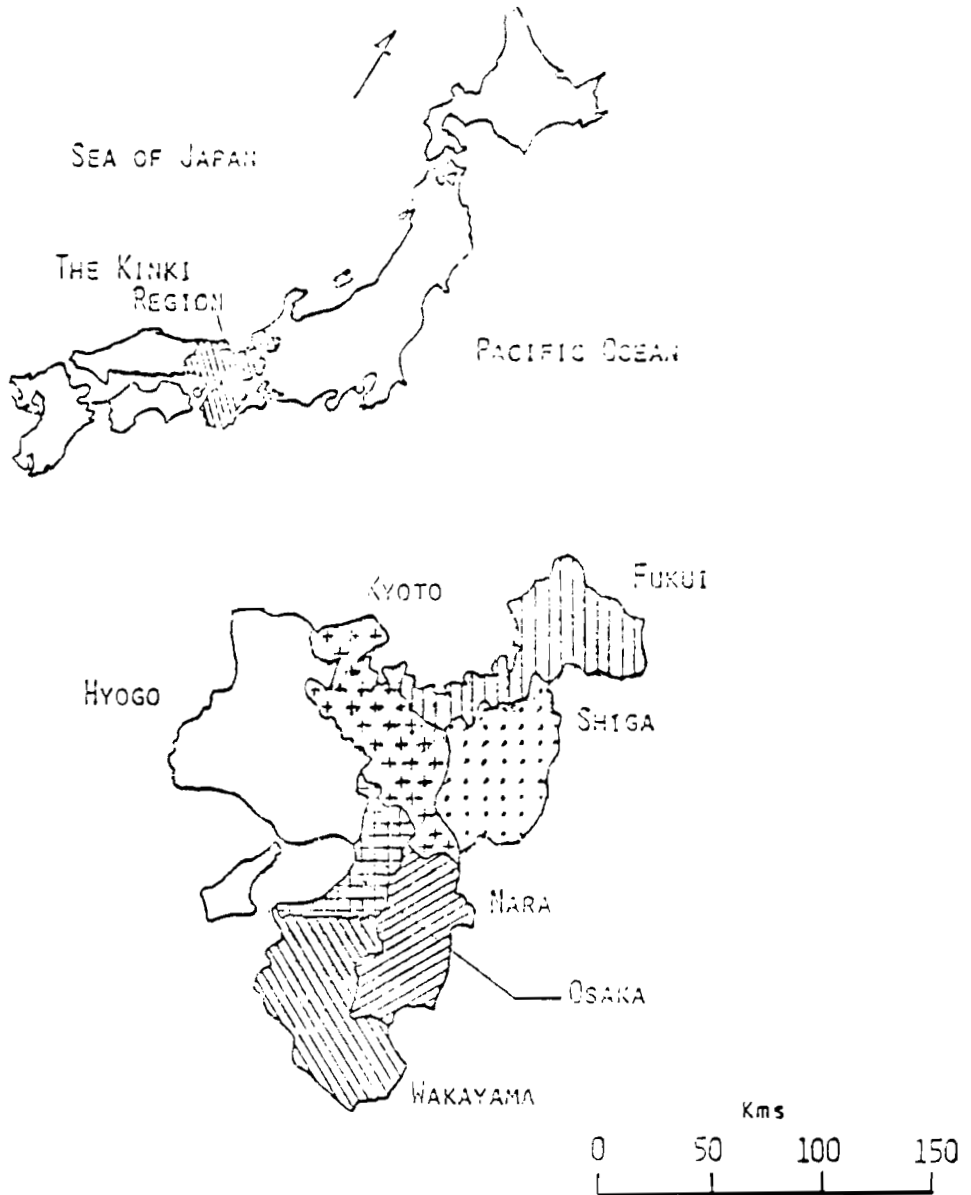

Figure 4. Map of the Kinki region.

Table 1. Comparison of the basic statistics by subregions in the Kinki region (1970).

	Fukui	Shiga	Kyoto	Osaka	Iyogo	Nara	Wakayama
Population (10 <sup>3</sup> persons)	744	890	2250	7620	4667	930	1043
DID Population (10 <sup>3</sup> persons)	269	192	1635	6863	3141	343	421
Value of Shipments in Manufacturing (10 <sup>10</sup> yens/year)	318	636	1240	7328	4202	402	892
Materials Processing	237	355	831	4312	2756	284	834
Assembly Industries	81	281	409	3016	1446	136	58
Heavy Oil and Coal for Gas and Elec. Utility Industries	0	0	0	2820	2941	0	747
Coal (10 <sup>3</sup> tons/yr)	0	0	0	4786	656	0	0
Motor Vehicles Owned (10 <sup>3</sup> cars)	153	169	403	1314	718	153	209
Diffusion Rate of Public Sewerage (%)	8.5	0.5	18.4	28.1	15.3	3.6	2.9
Area of the Inhabitable Districts (km <sup>2</sup> )	1063	1188	1118	1187	2393	777	1044
Area of the DID (km <sup>2</sup> )	35.4	27.2	150.5	594.3	314.5	51.0	55.4
Low Water Discharge (10 <sup>3</sup> tons/day)	155.5	69.1	122.2	123.2	44.4	10.2	68.5
Mean Water Discharge (10 <sup>3</sup> tons/day)	229.6	133.1	246.3	255.4	116.5	30.4	196.6

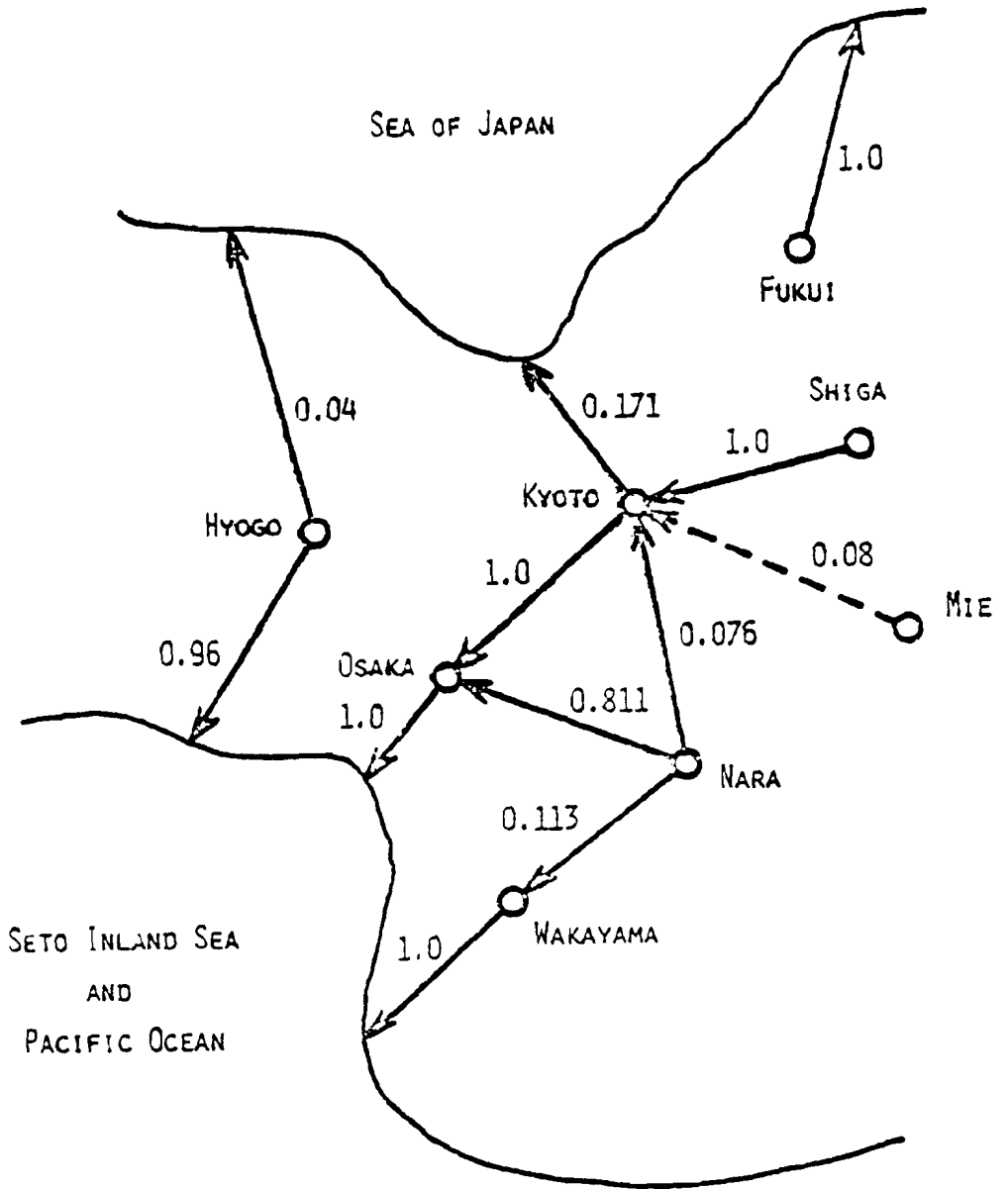

Figure 5. Flow graph indicating the subregional fraction of BOD load.

*Air Pollution Model*

Emission coefficients from industrial, and gas and electric power generation sectors are estimated from data in [7, 8, 9]. Pollution control effects are considered only for particulates, and the following values are assumed

$$\theta_5 = 90(\%) \text{ for industrial sector}$$

$$\theta_6 = 95(\%) \text{ for gas and electric power generation sector.}$$

The emission loads for the transportation sector are also estimated taking into account the statistical data of the numbers of vehicles, their fuel consumption in 1970 [7] and the emission data given in [8]. No pollution control is considered for this sector. As it was impossible to gather all the necessary data to calculate emissions of all the pollutants divided by urban and rural areas, it is assumed in this case study that pollution loads in these areas are proportional to the population ratio between these two areas. For example, the pollution load in MA is equal to (total pollution load within a subregion)  $\times$  (population in MA)/(total population within a subregion).

*Solid Wastes Model*

The generation coefficient of plastic waste for the residential sector is assumed to be 10 percent of the total domestic waste according to the real data for 1970 [9, 10], namely,  $\alpha_{31} = 92.1$  (g/person/day). Other coefficients for residential sectors in SWM are assumed based on real data gathered by Osaka and Hyogo prefectures in 1970 [9, 12], e.g., the incineration ratio  $\alpha_3 = 0.392$ .

Concerning the industrial sector in SWM, generation coefficients  $\alpha_{32}$ , the recycling ratio  $\alpha_4$  and the incineration ratio  $\alpha_5$  differ according to the type of industry, and data given in [11] are quoted. The total subregional pollution load is divided into metropolitan and rural areas under the same assumption as for air pollution.

## 3.2. Output of the Model

The loads of all the pollutants estimated by this model are tabulated in Table 2. Using the results of Table 2 and the data of regional environmental capacity in Table 1, the environmental impact indicators  $P_1$ - $P_5$  are calculated for each subregion. The corresponding indicator diagrams are illustrated in Figures 6 and 7. Figure 6 shows the subregional comparison of water pollution level of rivers by BOD value. Subregional comparisons with respect to air pollution and plastic waste are illustrated in Figure 7 using environmental impact indicators  $P_1$ - $P_3$ . All values of these indicators are normalized with respect to those of corresponding of Kyoto prefecture.



Table 2. Estimated amounts of pollutants emitted by subregions (1970).

	Fukui	Shiga	Kyoto	Osaka	Hyogo	Nara	Wakayama
BOD*	67.1	79.8	250.4	1023.2	437.6	47.9	109.4
HIC	12.6	13.4	30.6	153.9	70.5	19.9	33.7
CO	52.5	57.2	133.7	433.7	241.0	51.8	70.4
NO <sub>x</sub>	10.3	14.1	25.5	170.0	118.7	9.7	45.1
SO <sub>x</sub>	14.1	26.7	39.6	406.1	311.5	12.1	126.3
Particulates	2.0	2.1	4.2	53.5	14.6	2.0	3.1
Plastic Waste	20.1	24.3	60.1	212.3	127.5	24.3	27.9

\*Pollution loads from surrounding subregions are included.

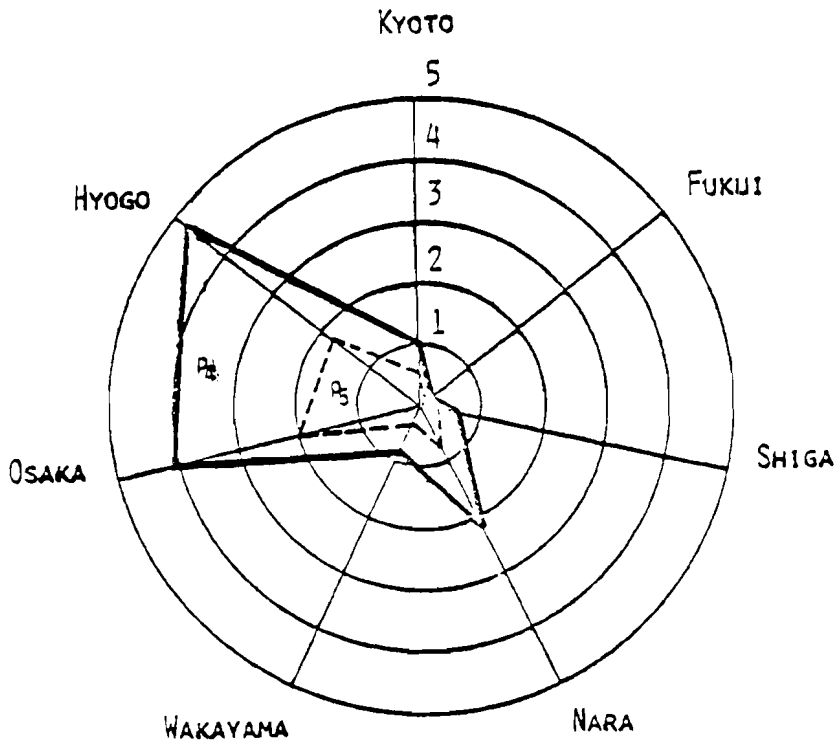

Figure 6. Regional environmental impact diagram of BOD.

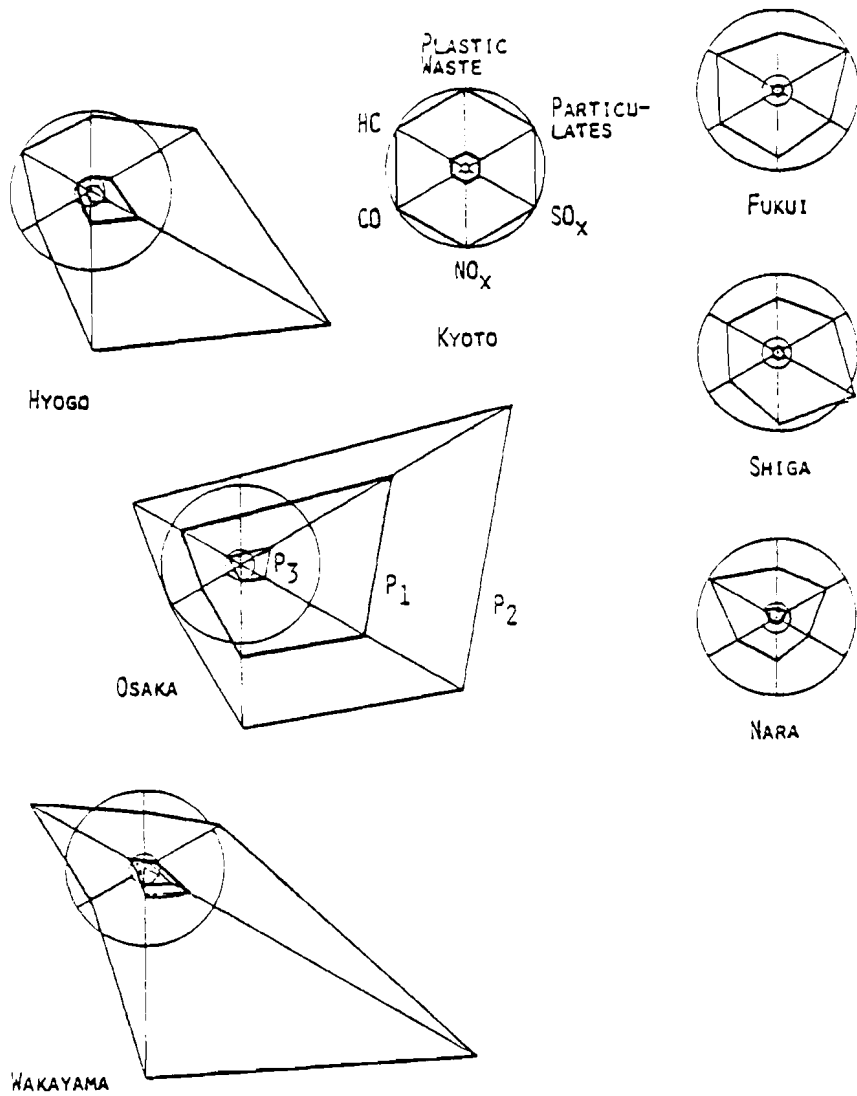

Figure 7. Regional environmental impact diagrams of air pollution and solid waste.

### 3.3. Results and Discussion

In this subsection, let us discuss the results of environmental impact analysis carried out for the Kinki region.

Concerning the result of water pollution shown in Figure 6, there exist great differences among pollution levels of the various subregions. Although the water pollution load expressed by the BOD value of Fukui prefecture is not the lowest in Table 2, its pollution level expressed by indicators  $P_4$  and  $P_5$  is the lowest one, as shown in Figure 6. This can be understood from the fact that the water resource in this prefecture is very rich as shown in Table 1. On the other hand, Nara shows a relatively high pollution level while its BOD load is the lowest in Table 2. This is due to the lowest water resource in this prefecture.

The difference in the seasonal change of water discharge patterns for rivers between the subregions cause the difference of values between indicators  $P_4$  and  $P_5$ . In other words, as the low-water discharges of rivers in Hyogo and Nara prefectures are relatively low compared with other subregions, their respective values of indicator  $P_4$  become high. As a result, it turns out that the comparisons of water pollution level by indicators  $P_4$  and  $P_5$  provide meaningful information being a first step towards water quality management.

Next, let us investigate the results obtained given in Figure 7 which illustrates the regional environmental quality comparison with respect to air pollutions and plastic wastes.

Generally speaking, subregional differences of these pollutants are not so great as compared with those of water pollution shown in Figure 6. The difference in the shape of the indicator diagram is mainly due to the differences in industrial structure of the subregions. As an example, the main industries in Wakayama prefecture are of the raw material processing type as shown in Table 1, and together with the narrowness of the DID area, this causes some values of indicator  $P_4$  to be very high. Concerning the indicators  $P_2$  (pollution level in metropolitan area) and  $P_3$  (pollution level in rural area), it is possible to divide the seven subregions into two groups; i.e., highly polluted areas (Osaka, Hyogo, Wakayama) and low polluted areas (Kyoto, Nara, Shiga, Fukui). All indicators of Osaka prefecture, the economic center of the Kinki region, show very high values, and the differences among values of three indicators  $P_1$ ,  $P_2$ , and  $P_3$  are not so great. This implies that almost all parts of this area are equally polluted, and it reflects well the fact that most parts of this subregion are metropolitan areas and highly industrialized areas. Furthermore, the pattern of Hyogo prefecture, for example, reflects well the regional difference of pollution levels in MA (industrial area of Pacific Ocean side) and RA (agricultural area of Japanese Sea side).

It is possible to conclude that the results illustrated by these regional environmental impact diagrams reflect well the image of the real environmental quality of each of the subregions in the Kinki region.

## 4. CONCLUSION

A regional environmental impact model including air and water pollutions and solid wastes has been constructed for investigating the relationships among production, consumption, and pollution through a positive case study for the Kinki region. The model is essentially of the pollutant emission register type whose inputs are various socioeconomic indicators such as population, industrial production, energy consumption, etc. The environmental quality comparisons among the subregions divided by urban and rural areas have been expressed as environmental impact indicators, and the obtained results reflect well the impact of the real environmental quality of each subregion. The model obtained will give us important primary information to assess future environmental impacts in the process of an integrated regional development decision making.

## APPENDIX

## Japanese Standard Industrial Classification

JSIC Code	Industrial Category
18 and 19	Food and similar products
20	Textile mill products
21	Clothing and related products
22	Lumber and wood products
23	Furniture and fixtures
24	Pulp, paper, and related products
25	Printing and publishing
26	Chemicals and allied products
27	Petroleum and coal products
28	Rubber products
29	Leather and leather goods
30	Stone, clay, and glass
31	Iron and steel
32	Nonferrous metals
33	Fabricated metal products
34	Machinery, except electrical
35	Electrical machinery
36	Transportation equipment
37	Instruments and related products
38	Miscellaneous manufactures

## ACKNOWLEDGMENTS

The authors would like to express their sincere gratitude to Professor Yoshikazu Sawaragi of Kyoto University for his encouragement, the organizer and principal investigator of the IIASA/Japan cooperative research on the integrated regional development system for the Kinki region and also the organizer of the Japanese Special Project for Environmental Pollution Control supported by the Ministry of Education of Japan. Special thanks should also be extended to Mr. Shozo Tsujio of the University of Osaka prefecture for his assistance in performing the case study.

## REFERENCES

- [1] Suzuki, Y. (1976) An Integrated Regional Planning Model—Case Study at the Kinki Area. Proceedings of a Seminar on Kinki Regional Management Study held at the International Institute for Applied Systems Analysis, Laxenburg, Austria, March 1976.
- [2] Sugiki, A. (1974) Water Pollution—Phenomenon and Control. Tokyo: Giho-do (in Japanese).
- [3] Bureau of Statistics (1973) Japan Statistical Yearbook 1972, 1973, edited by the Office of the Prime Minister. Tokyo: Mainichi Press.
- [4] Bureau of River (1973) Water Quality Yearbook of Japanese Rivers, 1972, edited by the Ministry of Construction of Japan. Tokyo: Sankai-do (in Japanese).
- [5] Sawaragi, Y. (ed.) (1973) Environmental Pollution Control. Report of the Special Research Program supported by the Ministry of Education of Japan. Japan: Kyoto.
- [6] Environmental Agency of Japan (ed.) (1974) Quality of the Environment in Japan, 1973. Tokyo: Ministry of Environment.
- [7] Ministry of International Trade and Industry of Japan (ed.) (1973) Demand Estimation of Petroleum in 1973. Report of the Coal and Mine Bureau, Tokyo (in Japanese).
- [8] Duprey, R.L. (1968) Compilation of Air Pollutant Emission Factors. Durham: U.S. Department of Health, Education, and Welfare, Public Health Service, Bureau of Disease Prevention and Environmental Control, National Center for Air Pollution Control.
- [9] Osaka Prefecture (ed.) (1973) Environmental Control Program for Osaka Prefecture—Big Plan. Report of the Project Team of the Pollution Control Program for Osaka Prefecture. Japan: Osaka (in Japanese).
- [10] Institute for Policy Sciences (ed.) (1973) Development of Effective Utilization System for Plastic Resources. Report of the Institute for Policy Sciences, Tokyo (in Japanese).
- [11] Pollution Protection Bureau (1973) Industrial Wastes, Report of a Fact-Finding Study on the Treatment and Disposal of Industrial Wastes. Tokyo: Ministry of International Trade and Industry of Japan (in Japanese).
- [12] Bureau of Environment (1971) Report on the Treatment and Disposal of Public Wastes, 1970. Kobe, Hyoto prefecture: Department of Public Health and Welfare (in Japanese).

AN ANALYSIS OF INHABITANTS' EVALUATIONS OF LIVING  
ENVIRONMENTS STRESSING INTERESTS IN LOCAL CULTURAL  
ASSETS

Y. Nishikawa, H. Itakura, and T. Yamauchi  
*Department of Electrical Engineering, Kyoto University,  
Kyoto, Japan*

H. Yoshida  
*Urban Planning Bureau, Kyoto City Government, Kyoto,  
Japan*

1. INTRODUCTION

Recently, the basic question that is being asked repeatedly all over Japan is "how can we improve the quality of human life?" In the course of economic growth, public desires and administrative policies have tended to give most attention to raising people's income level and increasing the industrial production capacity. Certainly Japan has attained her aims excellently in these aspects; while she is now facing various kinds of more serious problems such as: destruction of nature, contamination of environment, uneven concentration of population, continuation of inflation, etc. For that reason, Japan people are starting to pay considerable attention to the quality of life in aspects such as physical environment, health, social security, community life, education, culture, leisure, and so forth, as well as the economic aspect.

In order to meet these needs, a study on the measure of NNW (Net National Welfare) was conducted [1] by the NNW Measurement Committee, Economic Council of Japan, as the comprehensive performance index of life quality in place of GNP; and the United Nations [2], Japanese national government [3] (The Research Committee, The Council of National Living), and several Japanese local governments [4, 5, 6] have worked actively towards systematizing the so-called social indicators viewed from the life quality viewpoint. Some work is still going on in various governmental organizations.

This report is concerned with cultural indicators in an area. It is somewhat difficult to evaluate objectively the status of the cultural environment. The Council of National Living of Japan has suggested, in its system of social indicators, measuring the number of prefectures and municipalities where ordinances for protection of cultural assets have been enacted and the number of cultural assets designated by the national or local governments. Cultural assets found to be valuable from historic, artistic, and/or scientific viewpoints by the governments are, as a matter of course, to be counted in the indicator measurement. However, not only are these kinds of eminent cultural assets the cultural heritage, inherited from the previous generation and having laid the foundation for the life of contemporary Japanese people, but so is the cultural heritage as felt more intimately in everyday living, including traditional customs and manners.

From this point of view, in this report we shall define "local" cultural assets from our own point of view and try to investigate the possibility of clarifying the structure of inhabitants' evaluation of these assets. This work is done by using the results of polling conducted in some local cities that have traditional atmospheres and a relatively large number of local cultural assets [7].

It is noted that our work has not yet been completed in any sense, hence the present report is an interim one.

## 2. LOCAL CULTURAL ASSETS

In Japan the term "cultural asset" is used commonly for indicating any particularly important cultural heritage that is designated by the national government to be of historical, scientific, and/or artistic value. In comparison with these, we would like here to give the name of "local" cultural asset to those that have their roots in our "local" society. Most of these local cultural assets may be of little scientific or artistic value. However, the local cultural assets may have much more influence on Japanese spiritual life than those nationally designated important cultural assets. For instance, a small stone statue of Jizo, the Japanese children's guardian, standing by a roadside has been present from generation to generation and is closely related with the daily life of local inhabitants, regardless of its artistic value. The Jizo in such a case is certainly one of the "local" cultural assets.

As opposed to designated cultural assets, the local ones are of a very wide range, but have been recognized and appreciated by many local inhabitants. The important designated assets are of course local ones where they have local features.

The reconstruction of the nation and the succeeding high economic growth after World War II have changed our mode of life and local societies generally by "westernizing" them. As a result



of the industrial growth, the standard of living has been considerably raised. These westernizations or modernizations of Japan, however, have often tended to regard traditional cultural assets as encumbrances and even to reject them. Moreover, a great part of traditional manners and customs has passed out of the Japanese mind and has been discarded. The rejection of tradition in life will bring about a deterioration of spiritual life itself. In fact, our living environment has been becoming worse as a whole in the last decade, in particular in many urbanized areas. Particularly, the desolation of "cultural" environment is notable.

Big cities like Tokyo have had difficulties in preserving tradition while, supporting modernization in various degrees, some local cities still preserve many traditional manners and customs. Thus the problem of trade-off is brought up between the modernization and the preservation of tradition. In cities or towns there have been, and will be, several plans that examine how to preserve local traditional assets and to make the best use of them in the course of development.

### 3. A POLL ON INHABITANTS' EVALUATION OF LOCAL CULTURAL ASSETS

Nowadays, most cities have various difficulties and a number of people feel that their cities are becoming unfit to live in. However, the concrete contents of their feelings are somewhat vague. It is then necessary to bring light on how the inhabitants feel about their own city or community.

We would like to investigate how the inhabitants evaluate their traditional mode of life and how their evaluations are related to their living environment. The investigations are focused especially on how the local cultural assets play their roles in constituting regional attractiveness which is reflected by inhabitants' feeling of satisfaction.

With this aim, we have asked some inhabitants to respond to the questionnaire shown in Appendix A. The questionnaire is composed of three parts. The first part concerns the attributes of the inhabitant himself, his residence, and his family. The second, the principal part of the questionnaire, is on the evaluation of the living environment. This part includes thirty items concerning the physical environment mainly from the viewpoint of local cultural assets, traditional manners and customs, and human relations in the community. The third part concerns the kind of city in which the inhabitant would like to live and the reason. The first and the third parts are omitted in the appendix.

The pollings have been conducted in three cities: Takehara City, at the Seto Inland Sea in Hiroshima prefecture, Otsu City, the capital of Shiga prefecture, and Kanazawa City, the capital of Ishikawa prefecture. These cities are quite historic and preserve well many "local" cultural assets. One family has been chosen randomly out of about 25 to 35 families, i.e., 166, 1405,

and 1486 families in Takehara, Otsu, and Kanazawa Cities, respectively. One member of each family has filled in the questionnaire. We have succeeded in obtaining 159, 1036, and 1233 responses, respectively, from these sampled families.

#### 4. SOME TRIALS AT STRUCTURE ANALYSIS OF INHABITANTS' EVALUATION

Based on the data collected through the poll presented in the last section, we shall try to investigate some structures of inhabitants' evaluation of local cultural assets. Various kinds of effective techniques may be available for this. The simplest one is the use of frequency histograms. Figures 1 and 2 are the frequency histograms on each item of the inquiries IIA and IIB, respectively, in the questionnaire. From these data we can find the items felt "satisfactory" and the items felt "necessary" by many of the inhabitants in those cities. Tables 1 and 2 summarize these items.

The frequency histograms give us some information on inhabitants' evaluation of each individual item, but no information on the evaluation patterns existing among the items. As a means for revealing an inter-item evaluation structure, we shall represent the items as points in a certain space and observe the geometric relations among these points. For this purpose, we try to use the multidimensional scaling (MDS) technique. The MDS technique needs similarity or dissimilarity data. We calculate the rank correlation coefficient  $r_{ij}$  between the items  $i$  and  $j$  and adopt the quantities  $s_{ij} = 1 - r_{ij}$  as the dissimilarity data for the MDS. Appendices B and C outline the rank correlation coefficient and the MDS technique, respectively.

##### 4.1. Evaluation Structures for Satisfaction and Necessity

We shall see what evaluation structure exists among the items 1 through to 22. The inhabitants have evaluated their levels of both satisfaction (the inquiry IIA) and the necessity (IIB) for each item in the questionnaire. Constructed by the MDS technique of nonmetric type, Figures 3a and 3b show the configurations of 22 items on two-dimensional spaces; Figure 3a is from the satisfaction data and Figure 3b from the necessity data. The stress is a measure of the goodness-of-fit of the configuration to given dissimilarity data. The stresses are 0.042 for 3a and 0.029 for 3b, which are small enough. These configurations are obtained from all the data of the three cities.

Although the distance between the points of items does not have absolute meaning, we can give some interpretations of the inter-item relations. For example, the point 3 (temple precincts) is close to 4 (children's guardian) on Figure 3a, but not on Figure 3b. This may result from the difference between people's evaluations of the satisfaction and the necessity of these two items. That is, those who are satisfied with existing temple precincts are usually inclined to be satisfied with the children's guardian, and *vice versa*; while this is not observed for the necessity. Similar interpretations are possible of the other points of items.

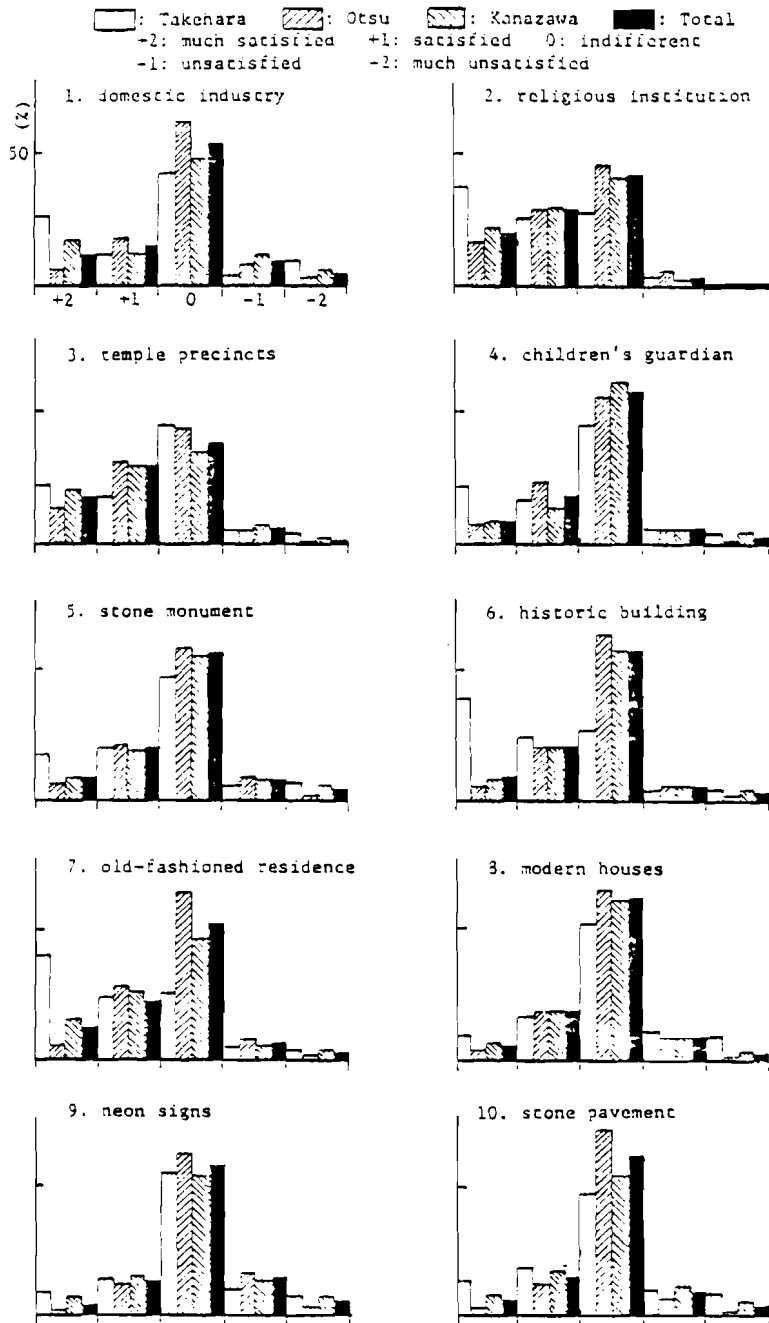

Figure 1. Frequency histograms of the items 1 to 30, inquiry IIA.

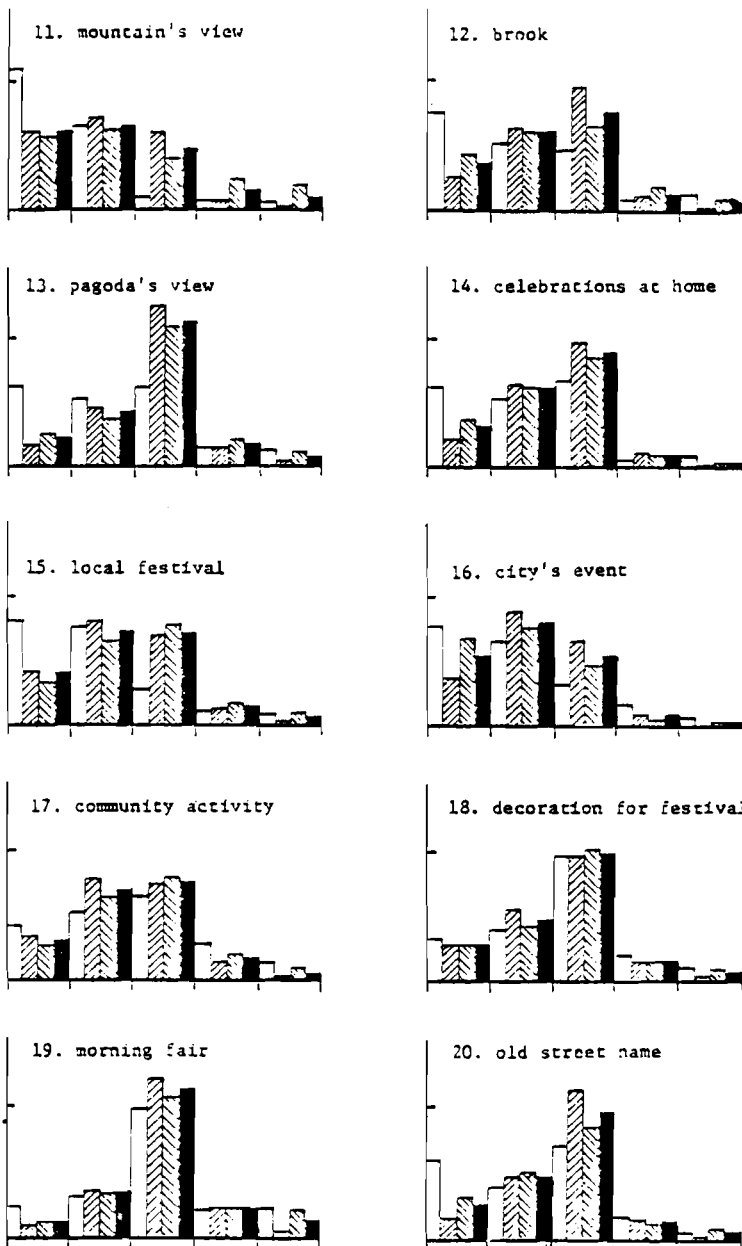

Figure 1 continued.

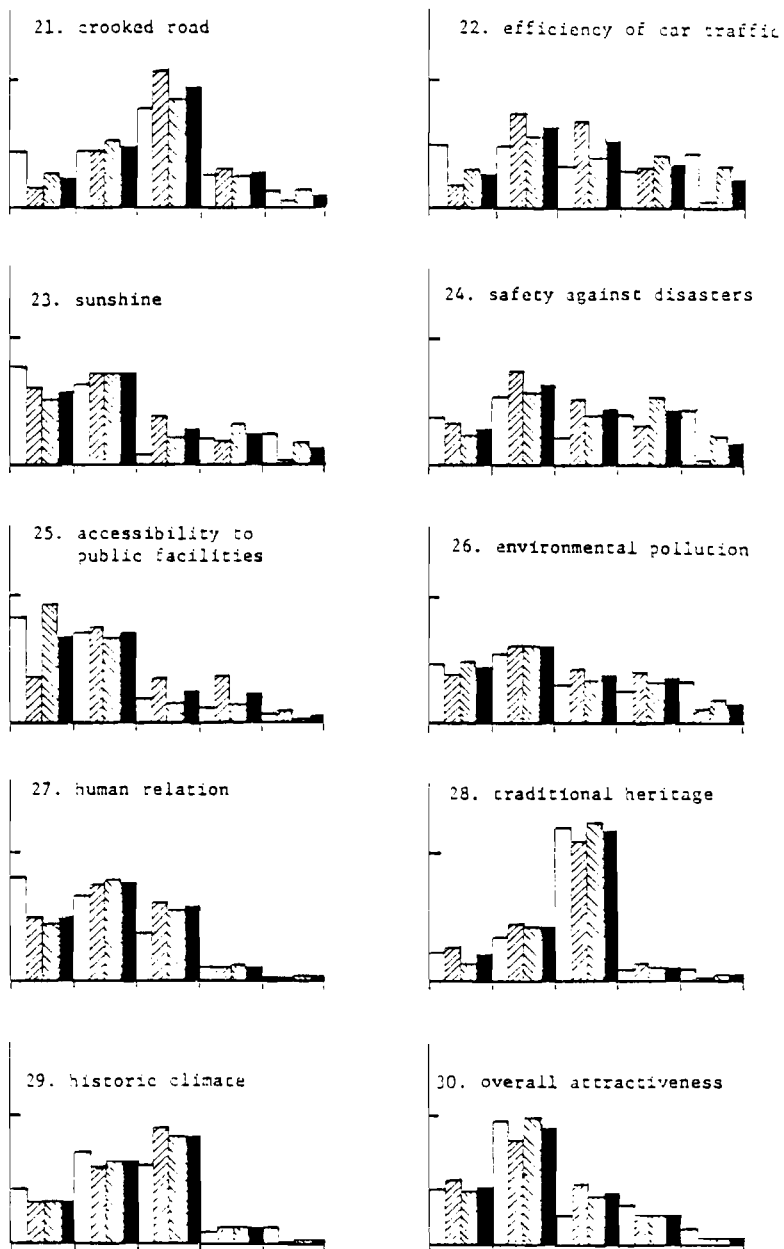

Figure 1 continued.

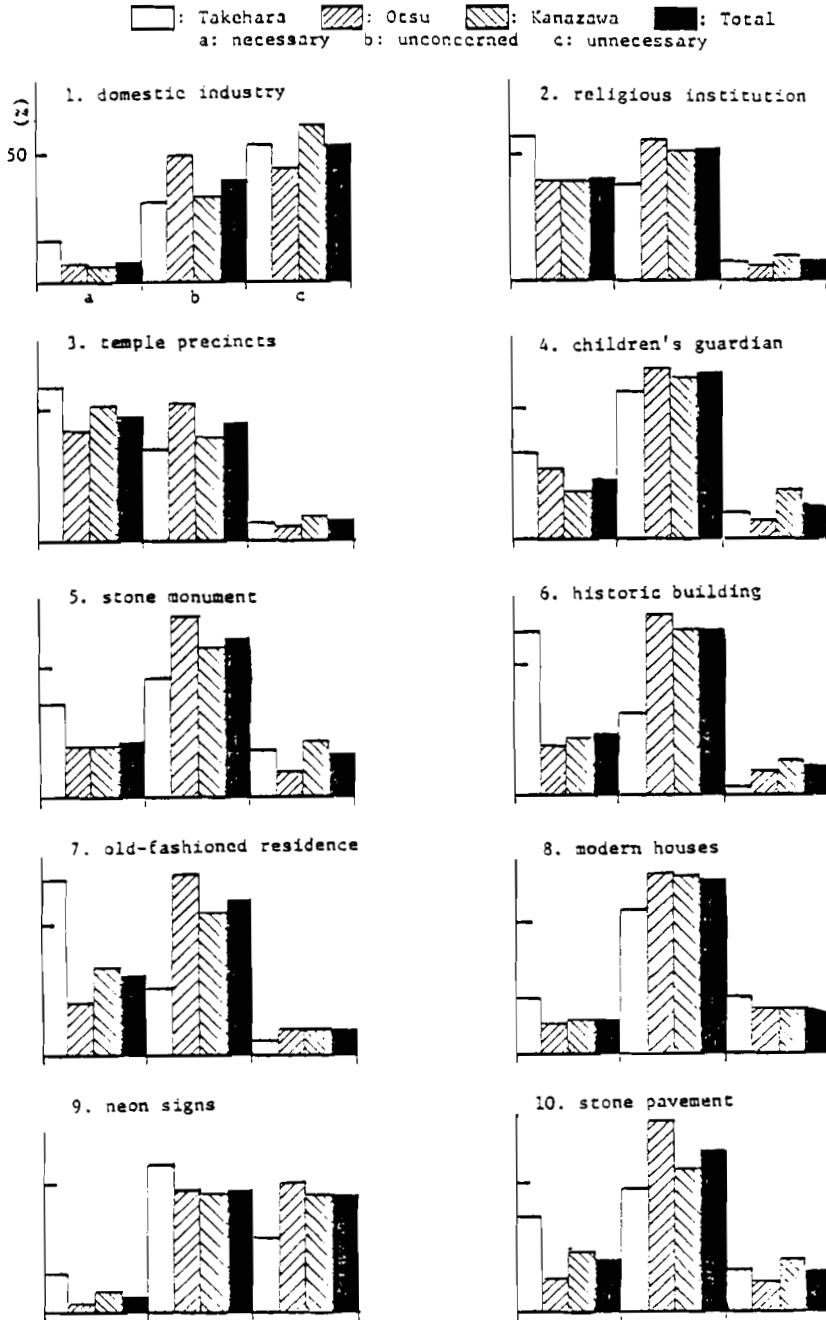

Figure 2. Frequency histograms of the items 1 to 22, inquiry IIB.

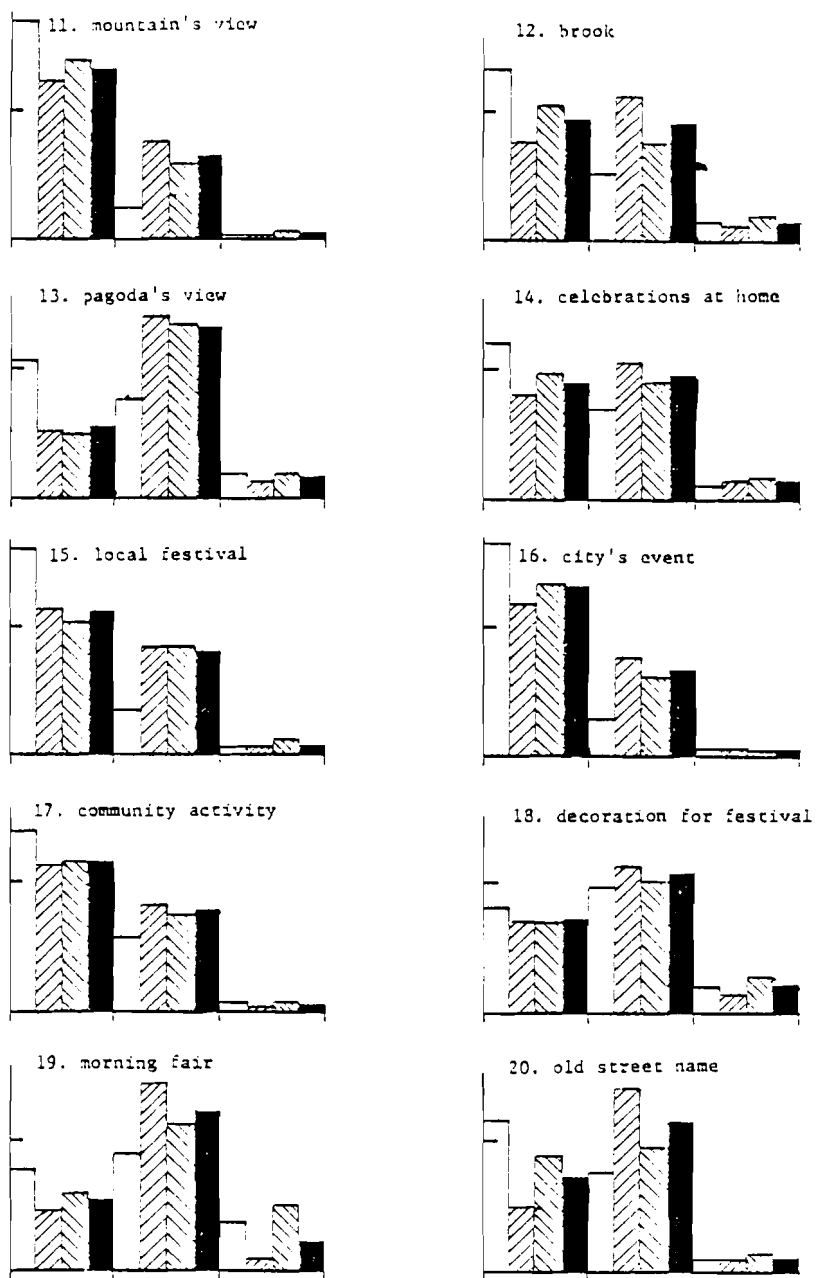

Figure 2 continued.

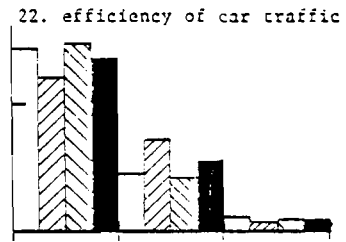
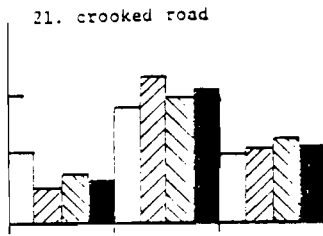

Figure 2 continued.



Table 1. Items that are felt satisfactory by the majority of people questioned.

---

25.	Accessibility to public facilities
16.	City event
30.	Overall attractiveness
23.	Sunshine and ventilation
11.	View of mountains or the sea
17.	Community activity
15.	Traditional festival in local community
26.	Environmental pollution
2.	Religious institution
3.	Precincts of temple or shrine

---

Table 2. Items that are felt necessary by the majority of people questioned.

---

22.	Efficiency of car traffic
11.	View of mountains or the sea
16.	City event
17.	Community activity
15.	Traditional festival in local community
3.	Precincts of temple or shrine
12.	Brook, channel, or canal
14.	Annual celebrations at home
2.	Religious institution

---

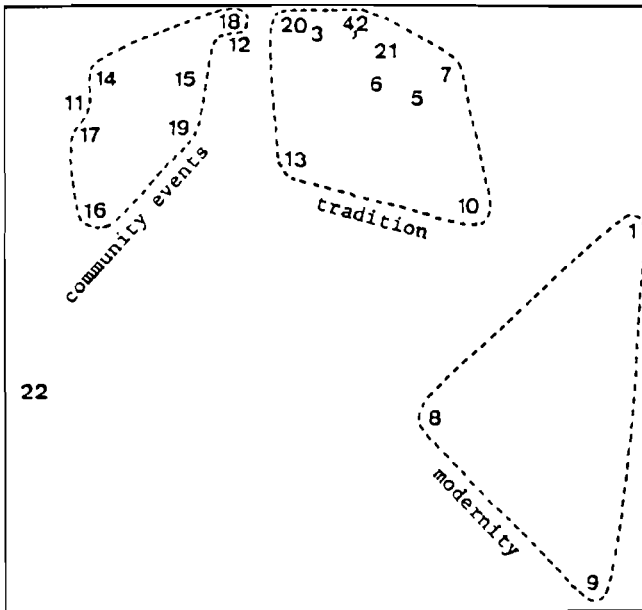

(a) from the data on satisfaction (inquiry IIA)

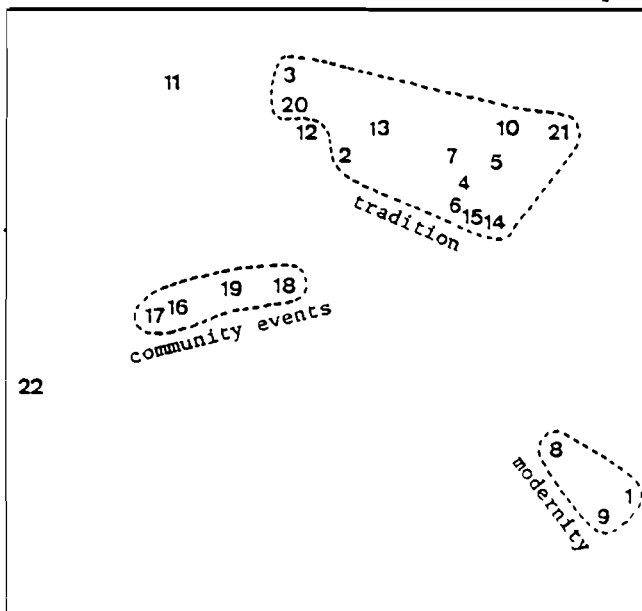

(b) from the data on necessity (inquiry IIB)

Figure 3. Configurations of the items 1 to 22, obtained by the MDS of nonmetric type (for overall samples).

Another feature of the configurations is that the points form several groups on the plane. Three large groups are recognized. The first group on Figure 3a is that composed of the points 2 to 7, 10, 13, 20, and 21. These items concern some typical Japanese traditions. The second is the group of points 14 through 19 which concern events in local Japanese community. The last one is composed of the points 1, 8, and 9, representing the nontraditional items, which are usually disliked by the inhabitants from the traditional or historical point of view. The point 22, a little apart from the other points, represents the item on the efficiency of traffic, which has a different character to the other items.

It may be natural and, at the same time, is very interesting that these groups on the figure match very well our intuitive insight into physical attributes of the items. Although Figure 3b shows quite similar groupings, points 14 and 15 are configurated differently. This difference may be interpreted such that the celebrations at home (point 14) and the local festival (point 15) are viewed as a part of the community events in the feeling of satisfaction while they are viewed as part of the traditional heritage in the feeling of necessity. We might be able to make a great variety of interpretations of Figure 3 in addition to those mentioned above, or we could let the figure speak for itself.

#### 4.2. Difference of Evaluation Structures Among Parts of Cities

In order to see some differences in the evaluation structures among cities or several parts of the cities, *the individual difference concept* in the MDS has been introduced in our analysis. Three cities have been divided into seven parts: Takehara City (A), the northern (B), the central (C), and the southern (D) parts of Otsu City, and the northern (E), the central (F), and the southern (G) parts of Kanazawa City. Each part is taken as *an individual* in the MDS of individual difference analysis. The dissimilarities among the items 24 through 30 are calculated for every part. These items, having a rather comprehensive character, have been studied only for the level of satisfaction (the inquiry IIA). Figures 4a and 4b are the configurations obtained. Figure 4a is the configuration of the seven items on a two-dimensional space, called the common object space. It represents the inter-item feature averaged over all parts of the cities. Figure 4b shows the configuration of seven parts on a two-dimensional space with only the first quadrant, called the subject space. It represents the weights associated with two axes of Figure 4a, that each part is to have. Combining Figure 4a with Figure 4b yields the configuration on the object space of each part. For example, part C has its own object-space configuration where, for each point, the coordinate values of axis I are about 0.4 times that on the common configuration of Figure 4a; part F has its configuration where both coordinate values are about 0.7 times those on Figure 4a.

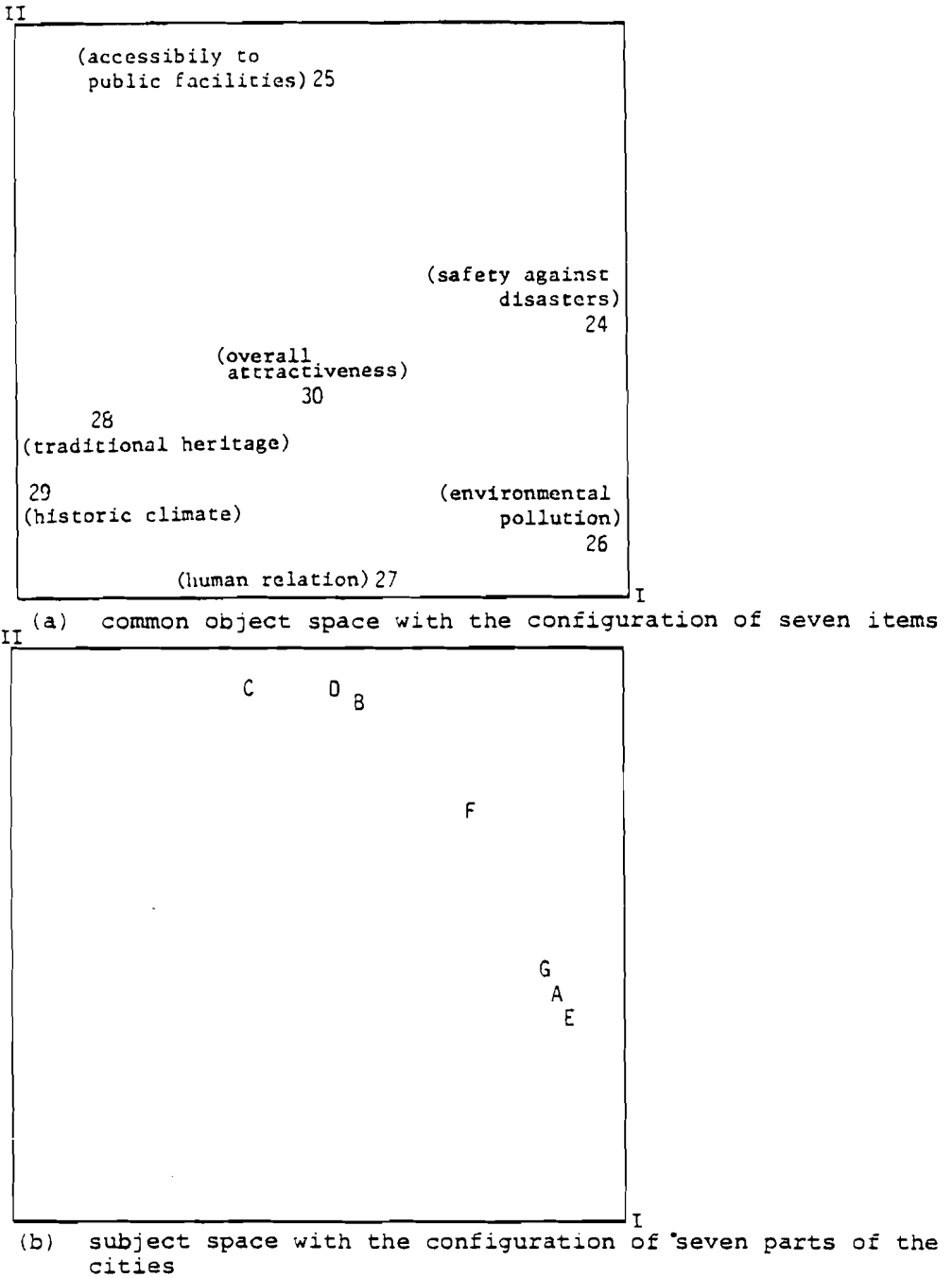

Figure 4. Configurations of the items 24 to 30, inquiry IIA, obtained by the MDS for individual difference analysis.

The points on Figure 4a are located around the point 30 (the overall attractiveness) at almost equal distance. It may be seen from this fact that people are concerned about human relations, traditional heritage, and historic surroundings as much as safety against disasters, accessibility to public facilities, and environmental pollution.

Figure 4b shows that A, E, and G of the cities attach much more importance to axis I than to axis II and, conversely, B, C, and D attach more importance to II than to I. This illustrates the difference in character of the cities. Takehara (A) and Kanazawa (E, F, and G) are rather isolated from big industrialized cities and keep a traditional locality relatively well; while Otsu, especially its central (C) and southern (D) parts, is affected severely by the neighboring big cities of Kyoto, Osaka, and Kobe in various senses. Combining Figure 4b with Figure 4a, the point 27 (human relations) gets closest to the point 30 in A, E, and G. It may be interpreted that in Takehara (A), the traditional small city, and the northern part (E) of Kanazawa, with many old dwellings, there are good local human relations. On the other hand, the people in the southern part (G) of Kanazawa, with many new houses, might lack more intimate human relations. In B, C, and D (Otsu City) point 25 (accessibility to public facilities) is farthest from 30. The public facilities are already felt sufficient and they may be of little concern in Otsu City.

#### 4.3. Evaluation Structure for Traditional Heritage and Historic Surroundings

Next, we shall try to apply another method of polling data analysis, called the method of quantification, to extract the evaluation structure for the traditional heritage and the historic surroundings. The method of quantification developed by C. Hayashi [8] comprises several varieties of classes. Almost all classes aim at direct data analysis of such ranks as appear in our present polling (Appendix A). The class used here is that modified by ourselves, which originates from "the first class" by Hayashi based on the concept of regression. A more detailed outline of the method is sketched in Appendix D.

Two results of the analysis for the three cities are summarized in Tables 3 and 4. The tables show the values of partial correlation coefficients. The partial correlation coefficient represents, roughly speaking, the strength of direct relation of each predictor variable to the criterion variable, with indirect relations through other predictor variables removed. In Table 3, the criterion variable in the method is the item 29 (historic surroundings) and the predictor variables are the items 2 to 7, 10 to 13, and 21; while in Table 4 the criterion variable is 28 (traditional heritage) and the predictor variables are 2 to 7, 10, 12 to 15, and 17 to 21. These items are chosen intentionally to reveal which minor items of local cultural assets are thought to compose the historic aspect or traditional heritage in each city.

Table 3. Partial correlation coefficients obtained by the modified first-class quantification method (with item 29 as the criterion variable).

Item	Takehara		Otsu		Kanazawa	
	Value	Order	Value	Order	Value	Order
2. Religious institution	0.160	4	0.129	2	0.031	9
3. Temple precincts	0.027	8	0.042	8	0.032	8
4. Children's guardian	0.0	10	0.027	11	0.0	11
5. Stone monument	0.0	10	0.035	9	0.039	7
6. Historic building	0.171	3	0.053	6	0.060	6
7. Old-fashioned residence	0.015	9	0.095	5	0.076	3
10. Stone pavement	0.049	7	0.035	10	0.030	10
11. Mountain view	0.093	5	0.114	4	0.160	1
12. Brook	0.211	1	0.051	7	0.062	5
13. Pagoda view	0.196	2	0.122	3	0.070	4
21. Crooked road	0.088	6	0.165	1	0.122	2

Table 4. Partial correlation coefficients obtained by the modified first-class quantification method (with item 28 as the criterion variable).

Item	Takehara		Otsu		Kanazawa	
	Value	Order	Value	Order	Value	Order
2. Religious institution	0.235	3	0.194	1	0.0	15
3. Temple precincts	0.0	13	0.030	10	0.078	4
4. Children's guardian	0.216	4	0.0	12	0.0	15
5. Stone monument	0.071	9	0.0	12	0.006	14
6. Historic building	0.0	13	0.065	7	0.046	9
7. Old-fashioned residence	0.047	10	0.173	3	0.042	10
10. Stone pavement	0.207	6	0.0	12	0.033	11
12. Brook	0.275	2	0.023	11	0.079	3
13. Pagoda view	0.026	11	0.065	8	0.022	13
14. Celebrations at home	0.331	1	0.066	6	0.077	5
15. City event	0.0	13	0.056	9	0.072	6
17. Community activity	0.214	5	0.160	4	0.031	12
18. Decoration for festival	0.167	7	0.0	12	0.049	8
19. Morning fair	0.0	13	0.182	2	0.059	7
20. Old street name	0.008	12	0.073	5	0.119	2
21. Crooked road	0.092	8	0.0	12	0.141	1

Table 3 tells us that the principal elements of the historic, traditional scenery are the brook, the pagoda view, the historic building, and the religious institution in Takehara City, for example. Something similar to this can be observed in other cities. The important element common to the three cities may be the pagoda view, as we could imagine. On the other hand, the children's guardian, the stone pavement, and the stone monument might not be very important.

From Table 4, the elements of traditional heritage influencing the inhabitants' own or community life are guessed to be the celebrations at home, the brook, and the religious institution in Takehara; to be the religious institution, the morning or the evening fair, and the old-fashioned residence in Otsu; and to be the crooked road, the old street name, and the brook in Kanazawa.

The second chapter of the preceding report [7], which has been presented to the commission of National Land Agency and contributed by H. Yoshida, one of the present authors, gives several other results of the analysis of these polling data, which are not necessarily complete or rigorous. The people's feelings of satisfaction about those appreciably elaborate items are certainly affected by the status of existing properties in their neighborhood. However, since the data on these properties have not been completed yet, the discussion is adjourned.

## 5. CONCLUDING REMARKS

This is the first step to knowing how citizens evaluate the traditional culture and historic heritage in their life. Our investigation has been conducted using polling results in three local cities. The cities under study have tried to preserve their traditional or historic atmosphere. It may be interesting or even necessary to conduct similar pollings in some bigger and more modern cities like Tokyo, Osaka, and Kyoto, for the sake of comparison from the traditional or historic point of view.

If we wish to discuss one of the most important problems of how the governmental budget is to weight preservation against development, we have to have a more suitable polling for it. Moreover, the questionnaire has too many items resembling each other and lacks items on wealth, health, efficiency, safety, etc. In fact, asking questions that are similar is confusing to people and does not always yield meaningful conclusions. We believe that the present report, along with the previous one [7], can be a good guide for constructing better questionnaires in the future.

Regardless of the drawbacks of the present polling, we have been able to observe that, for the cities under study, the people are undoubtedly concerned about the traditional customs and culture, historic things, and human relations as well as today's problems such as the pollution, efficiency, and safety. The people feel that temple precincts, various kinds of festivals and events, and the ability to see nature are necessary, at least in those cities in which they are numerous. Currently some pollings

are under way in several other cities, Hakodate in Hokkaido, Yonezawa in Tohoku, Waki in Shikoku, Kitsuki in Kyushu, etc. Several instructive results are expected to come out shortly, and they will be reported together with more definite methods and conclusions of structure analysis.

APPENDIX A: QUESTIONNAIRE ON ATTRACTIVENESS OF LIVING ENVIRONMENT

This questionnaire is to examine your living environment with the aim of getting basic ideas that will help policy making to make your town attractive. We are hoping that you will fill in this questionnaire frankly. You are one of the people living in Kanazawa, Otsu, or Takehara Cities, whom we have randomly chosen.

We will not utilize your answer<sup>s</sup> for any purpose other than our scientific research.

- Inquiry I. We would like to ask you about your own home and yourself. (The details are omitted here.)
- Inquiry II. We would like to ask you about the attractiveness of your living environment
- IIA. For the questions items 1 to 30 listed below, please answer whether they are satisfactory (or good) or not. Your answer for each item should be in one of the five ranks given below.
- +2: It makes your living environment very attractive, or you are satisfied with it very much.
- +1: It makes your living environment attractive, or you are satisfied with it.
- 0: It is not related to your living environment, or you are indifferent to it.
- 1: It makes your living environment less attractive, or you are unsatisfied with it.
- 2: It makes your living environment very unattractive, or you are unsatisfied with it very much.
- IIB. For the question items 1 to 22 below, please answer whether they are felt necessary or not in order to increase the attractiveness of your living environment. Your answer for each item should be ranked as
- a: necessary.
- b: immaterial.
- c: unnecessary.



## Items of Question

1. There is a factory of domestic industry.
2. There is a religious institution like a temple, a shrine, or a church.
3. There are precincts of a temple or a shrine, or a grove of a tutelary shrine.
4. There is a statue of Jizo (a children's guardine) or a travellers' guardian by a roadside.
5. There is a sacred or aged tree, a stone monument, or a torii (a shrine gate) by a roadside.
6. There is a historic building like an aged house of a prominent person.
7. There is an old-fashioned residence on a street.
8. There is a row of modern houses.
9. There are billboards or neon signs in a row of houses.
10. There are stone steps, a stone wall, or a stone pavement.
11. You can see some mountains or the sea from your home or neighborhood.
12. There is a brook, a channel, or a canal.
13. You can see a temple or a pagoda from your home.
14. Your family observe some annual celebrations like Sekkus (annual festivities in certain seasons) or a Tanabata (the Festivals of Star Vega in July).
15. Your community celebrates a traditional local festival.
16. Your city promotes an event with participation of many citizens, such as an athletic or cultural festival.
17. Your neighbors are working actively for a community activity, e.g., for a town association activity.
18. You decorate your house with a traditional drapery or with a chochin (a Japanese paper lantern) at festival times.
19. There is occasionally an early morning fair or an evening fair.
20. There is a street with a historic name.
21. There is a crooked road kept from old times.
22. You can easily go along a street by car or move your car in and out of a parking lot.
23. About a condition of sunshine and ventilation.
24. About safety against disasters like a fire, an earthquake, a flood, a typhoon, etc.
25. About accessibility to school, hospital, shops, etc.
26. About environmental deterioration due to an air pollution, noise, vibration, etc.
27. About human relations within your community.
28. About the influence of traditional heritage on your personal or your community life.
29. About historic, traditional scenery.
30. In summary, about the overall attractiveness of your living environment.

## APPENDIX B: RANK CORRELATION COEFFICIENTS

The most popularly used correlation coefficient is the product-moment one which is defined between quantitative variables. But a different concept or definition of correlation is necessary for dealing with variables in an ordinal scale such as the responses to the questionnaire II of Appendix A.

Suppose that there are  $n$  samples  $S_1, S_2, \dots, S_n$ , and they respond to some items of a question in ranked categories. Based upon their responses, we wish to define correlation coefficients among the items, in a certain sense of rank order. Let the item  $I_1$  have  $m_1$  categories,  $c_{11}, c_{12}, \dots, c_{1m_1}$ , which are ranked in this order. Each sample chooses only one of these categories, that is, the sample  $S_i$  chooses  $c_{1j_i}$ ,  $j_i$  being one of 1 to  $m_1$ . Similarly, the item  $I_2$  has  $m_2$  categories,  $c_{21}, c_{22}, \dots, c_{2m_2}$ , and the same  $S_i$  chooses  $c_{2j'_i}$ .

For the two samples  $S_k$  and  $S_l$  ( $k, l = 1, 2, \dots, n$ ), we define  $\delta_{kl}$  and  $\bar{\delta}_{kl}$  as follows:

$$\delta_{kl} = \begin{cases} 1, & \text{if } j_k < j_l \text{ and } j'_k < j'_l \text{ or if } j_k > j_l \text{ and } j'_k > j'_l \\ 0, & \text{otherwise} \end{cases}$$

$$\bar{\delta}_{kl} = \begin{cases} 1, & \text{if } j_k < j_l \text{ and } j'_k > j'_l \text{ or if } j_k > j_l \text{ and } j'_k < j'_l \\ 0, & \text{otherwise} \end{cases} \quad (\text{B1})$$

One of the following three possibilities must happen for a pair  $k, l$ :  $\delta_{kl} = 1$  and  $\bar{\delta}_{kl} = 0$ , or  $\delta_{kl} = 0$  and  $\bar{\delta}_{kl} = 1$ , or  $\delta_{kl} = \bar{\delta}_{kl} = 0$ . Roughly speaking,  $\delta_{kl} = 1$  when the orders of responses for  $I_1$  and  $I_2$  are in a like direction between  $S_k$  and  $S_l$  and  $\bar{\delta}_{kl} = 1$  when they are in the opposite directions.

The sums of  $\delta_{kl}$  and  $\bar{\delta}_{kl}$  are obtained over all combinations of the samples,  $nC_2 = n(n-1)/2$  combinations, as

$$d = \sum_{\substack{k, l=1 \\ k < l}}^n \delta_{kl}, \quad \bar{d} = \sum_{\substack{k, l=1 \\ k < l}}^n \bar{\delta}_{kl} \quad (\text{B2})$$

There are several types of rank correlation coefficients that can be expressed by using these quantities. Here we just give that of Goodman and Kruskal [9] used in Section 4. Their rank correlation coefficient between items  $I_1$  and  $I_2$  is defined by

$$r = \frac{d - \bar{d}}{d + \bar{d}} \quad (\text{B3})$$

## APPENDIX C: MULTIDIMENSIONAL SCALING TECHNIQUES

Powerful techniques under the term "multidimensional scaling (MDS)" have recently been used for the analysis of data of various types collected in the social and behavioral sciences. The purpose of the techniques is to find whatever structure may lie hidden in empirical data and to express this structure in the form of a geometrical model or picture much more accessible to the human eye. The objects under study are represented by points in a spatial model in such a way that the significant features of the data about the objects are revealed in the geometrical relations among the points.

A related technique is one that has long been used in the social sciences under the name of factor analysis. Factor analysis, supposing a linear model, is for a correlation matrix whose elements are product-moment correlations between the objects; while the MDS is for a data matrix whose elements represent similarity or dissimilarity between the objects.

MDS is loosely separated into two types, one based on a linear model and one on a nonlinear model. The former involves a similar procedure to the factor analysis and is reduced to an eigenvalue problem for a certain matrix made from the original data matrix.

This appendix outlines the technique of MDS for a nonlinear model. There are a variety of procedures for this kind of scaling. Every procedure requires one to define a criterion that indicates the total deviation of the given data from a set of points in the configuration to be obtained; and then intends to minimize it.

Let there be  $n$  objects,  $b_1, b_2, \dots, b_n$ , and let the dissimilarity,  $s_{ij}$ , be measured quantitatively between the objects  $b_i$  and  $b_j$ . Suppose that the data matrix  $S$  whose  $(i, j)$  element,  $S_{ij}$ , is symmetric. The technique developed by Cooper [10] introduces new variables  $\tilde{s}_{ij}$ :

$$\tilde{s}_{ij} = s_{ij} - L > 0 \quad (C1)$$

with an unknown constant  $L$ . This idea of the above equation is to transform data measured on an interval scale into quantities on a ratio scale. Then, the configuration  $X = (x_1, x_2, \dots, x_n)$ , with the coordinate vector  $x_j$  of the point  $b_j$ , is determined in the space of a certain dimension, such that the resulting inter-point distances  $d_{ij}$  minimize the criterion

$$J = \sum_{\substack{i, j=1 \\ i < j}}^n (\tilde{s}_{ij} - d_{ij})^2 \quad (C2)$$

Various kinds of definitions for the distance are possible; if the Euclidian one is of interest, we can write  $d_{ij}$  as

$$d_{ij}^2 = (x_i - x_j)'(x_i - x_j) \quad (C3)$$

using the transpose '. The minimization problem of the unknowns  $x_i$  and  $L$  subject to  $J$  can be solved numerically with the aid of, say, the usual steepest-descent method or the gradient method, to establish the desired configuration. This technique of MDS is of metric type, because quantitatively measured dissimilarity data are dealt with.

Another important technique associated with a nonlinear model is a nonmetric type of scaling. This intends to give us a configuration without taking account of any more than the merely ordinal relations among the data matrix elements. Then, it extracts quantitative, metric information from qualitative, nonmetric data. This takes the stand that the data so often come from human subjects who can readily and reliably give only ordinal measurements. There are a lot of algorithms for the nonmetric MDS also. The basic idea of the nonmetric MDS is to obtain the configuration  $X$  of the objects such that the distances  $d_{ij}$  in the configuration have a certain monotonic relation to the dissimilarity  $s_{ij}$  measured in ordinal scale, or if  $s_{ij}$  is followed by  $s_{kl}$  in the order of dissimilarity, then  $d_{ij} < d_{kl}$  and, if  $s_{ij}$  and  $s_{kl}$  are of the same order, then  $d_{ij} = d_{kl}$ . Although  $X$  can always be determined in an  $(n - 1)$ -dimensional space to satisfy this condition for all  $s_{ij}$ , we practically like  $X$  in a possibly lower-dimensional space, even without complete satisfaction of the condition. In order to measure how well the configuration matches the given data, Kruskal [11, 12] defined the quantity called stress

$$S = \left[ \frac{\sum_{i,j=1}^n (d_{ij} - \hat{d}_{ij})^2}{\sum_{i,j=1}^n d_{ij}^2} \right]^{1/2} \quad (C4)$$

where  $\hat{d}_{ij}$  are a sequence of predetermined values monotonically related to  $s_{ij}$ . Guttman's rank image principle [13] is well known to be a notable and powerful method to search for  $\hat{d}_{ij}$ . Although there are a lot of computation algorithms for the nonmetric MDS, most of them are basically along the same lines. Many books [14, 15, 16] and articles are available on them. Hence, we omit the details here.

As opposed to the technique based on a linear model, including the factor analysis, the one based on a nonlinear model is applicable to the problem with incomplete data, or data containing a missing value. It is also empirically said that the nonlinear model gives us a clearer interpretation of the data structure than the linear one. However, the technique for the nonlinear model is apt to cause some trouble in a local optimum solution due to multimodality of the criterion or trouble of computation time becoming large.

Another impressive class of the MDS techniques is directed toward the analysis of individual differences lying hidden in

empirical data. For this class we imagine that the data matrix,  $S_g = [s_{ij}^{(g)}]$  ( $g = 1, 2, \dots, N$ ) has been obtained for each of  $N$  individuals or groups and that the differences among them are desired to be revealed in some sense. The MDS for individual difference analysis is to suppose one space with a configuration  $X = (x_1, x_2, \dots, x_n)$  common to all the individuals, called the common object space and various weights held by each, associated with its configuration.

Let the individual  $g$ 's weight matrix be denoted by the  $m \times m$  diagonal one,  $W_g = \text{diag} (w_1^{(g)}, w_2^{(g)}, \dots, w_m^{(g)})$ , where  $w_r^{(g)}$  is the weight of positive value associated with the  $r$ th coordinate of the  $X$  space and  $m$  is the dimension of the space. Thus, the simplest way to obtain the configuration with consideration of individual differences is to maximize a criterion similar to equation (C2)

$$J = \sum_{g=1}^N \sum_{\substack{i, j=1 \\ i < j}}^n (s_{ij}^{(g)} - \Delta_{ij}^{(g)})^2$$

$$\Delta_{ij}^{(g)2} = (x_i - x_j)' W_g^2 (x_i - x_j) \quad (C5)$$

This is due to Horan and Bloxon [17]. There are many varieties of the MDS techniques for individual difference analysis, varying with the concept of individual difference, the definition of weight and the criterion to be minimized, etc. The nonmetric procedure has also been introduced. Further the procedure combined with factor analysis has been developed by the authors [18]. These are all omitted here.

#### APPENDIX D: QUANTIFICATION METHOD OF THE FIRST CLASS

A series of the methods of quantification has been developed by C. Hayashi [8] one of the famous Japanese statistics mathematicians, and it comprises several varieties of classes. Based on the fundamental concept of the usual regression analysis, discriminant analysis, or cluster analysis, almost all classes of the methods aim at the direct analysis of data placed quantitatively in some ranks, as in the polling in Appendix A. The method we have used in Chapter 4 is a modified one of the first class, which is based on the concept of regression analysis. The outline of the method is sketched in the following.

Suppose that  $n$  items are under study in a questionnaire and each of them consists of  $k_j$  categories,  $j = 1, 2, \dots, N$ . Each of  $N$  sampled people is to respond to one of the categories in each item. This response is expressed for convenience by the symbol:

$$\delta_i(j, k) = \begin{cases} 1, & \text{if the sample } i \text{ responds to the category } k \\ & \text{of the item } j \\ 0, & \text{otherwise} \end{cases} \quad (D1)$$

for  $k = 1, 2, \dots, k_j$ ;  $j = 1, 2, \dots, n$ ; and  $i = 1, 2, \dots, N$ . Moreover it is assumed in the first class of the method that each sample has a quantitatively measured value,  $Y_i$ , called the external criterion.

The first-class quantification is carried out by giving a quantitative value  $x_{jk}$ , called the category score, to category  $k$  of an item  $j$ , to maximize the correlation

$$\rho = \frac{1}{N} \sum_{i=1}^N (Y_i - \bar{Y})(y_i - \bar{y}) / \sigma_Y \sigma_y$$

$$y_i = \sum_{j=1}^n \alpha_{ij}$$

$$\alpha_{ij} = \sum_{k=1}^{k_j} \delta_i(j, k) x_{jk} \quad (D2)$$

or equivalently to minimize

$$J = \frac{1}{2} \sum_{i=1}^N (Y_i - y_i)^2 \quad (D3)$$

Here,  $\bar{Y}$ ,  $\bar{y}$ ,  $\sigma_Y$ , and  $\sigma_y$  are the means and the standard deviations of  $Y_i$  and  $y_i$ , respectively. The above idea is to determine the coefficients  $x_{jk}$  such that they yield the best regression of the criterion variable value  $Y_i$  by the response prediction variable  $\delta_i(j, k)$ .

We can obtain useful information from the result of the best regression obtained. One of the most important pieces of information is the partial correlation coefficient

$$r_{Yj}^* = - \frac{r^{n+1, j}}{(r^{n+1, n+1} r^{jj})^{1/2}} \quad (D4)$$

where  $r_{ij}$  is the  $(i, j)$  element of the inverse of the  $(n + 1) \times (n + 1)$  matrix  $R$ ; the  $(p, q)$  element of  $R$  is the correlation between  $\alpha_{ip}$  and  $\alpha_{iq}$ ,  $i$  running from 1 to  $N$  ( $\alpha_{ij}$  for  $j = 1, 2, \dots, n$  has been defined in equation (D2) and  $\alpha_{i, n+1}$  is  $Y_i$  itself). The value of  $r_{Yj}^*$  reflects the strength of the direct relation of the item  $j$  to the external criterion, with indirect relations through the items other than  $j$  removed.

The present authors have pointed out that the above basic procedure has a shortcoming for the data of the items with some "ordered" categories, ordered, say, from "very attractive" to "very unattractive," like our polling in Appendix A. For the analysis of such data, we have proposed that there should be some specious value order in  $x_{jk}$ , e.g.,  $x_{j1} \leq x_{j2} \leq \dots \leq x_{jk_j}$  for

every  $j = 1, 2, \dots, n$ , and have established the complete computation procedure and the computer program [19].

#### ACKNOWLEDGMENTS

The authors would like to acknowledge sincerely the kind consideration of the members of Architecture History Laboratory, Department of Architecture, Kyoto University, chaired by Professor Koji Nishikawa, who have made available the polling data to the authors.

#### REFERENCES

- [1] Economic Council of Japan (1974) Measuring Net National Welfare of Japan. Economic Council of Japan: NNW Measurement Committee.
- [2] United Nations (1975) Towards a System of Social and Demographic Statistics. United Nations Pub. Ser. F. No. 18. United Nations: Department of Economic and Social Affairs, Statistical Office.
- [3] The Council of National Living (1975) Social Indicators of Japan. Japan: The Council of National Living, Research Committee.
- [4] Hyogo Prefecture Government (1974) Report of Investigation on New Social Indicator System in Hyogo Prefecture. Hyogo, Japan: Planning Department (in Japanese).
- [5] Shimane Prefecture Government (1977) New Long-Range Plan of Shimane Prefecture (Revised Plan). Shimane, Japan: Planning Department (in Japanese).
- [6] Kyoto City Government (1969) The Life Environment at Urbanized Area of Kyoto. Kyoto City, Japan: Urban Development Bureau.
- [7] Association for Architecture Research (1976) Report of Investigation on Utilization of Local Cultural Assests for Regional Development. Fundamental Investigation on Regional Development Planning, No. 50-11-1 and 2. Japan: Commissioned by National Land Agency (in Japanese).
- [8] Hayashi, C. (1952) On the Prediction of Phenomena from Qualitative Data and the Quantification of Qualitative Data from the Mathematico-Statistical Point of View. Ann. Inst. Statistical Math., 3:69-98.
- [9] Goodman, L.A., and W.H. Kruskal (1954) Measures of Association for Cross Classifications. American Statistical Association Journal 49:732-764.
- [10] Cooper, L.G. (1972) A New Solution to the Additive Constant Problem in Metric Multidimensional Scaling. Psychometrika 37:311-322.

- [11] Kruskal, J.B. (1964) Multidimensional Scaling by Optimizing Goodness of Fit to a Nonmetric Hypothesis. *Psychometrika* 29:1-27.
- [12] Kruskal, J.B. (1964) Nonmetric Multidimensional Scaling: A Numerical Method. *Psychometrika* 29:115-129.
- [13] Guttman, L. (1968) A General Nonmetric Technique for Finding the Smallest Coordinate Space for a Configuration of Points. *Psychometrika* 33:469-505.
- [14] Shepard, R.N., A.K. Romney, and S.B. Nerlove (1972) *Multidimensional Scaling, Theory and Applications in the Behavioral Sciences, Volume I and II*. Seminar Press.
- [15] Green, P.E., and V.R. Rao (1972) *Applied Multidimensional Scaling, A Comparison of Approaches and Algorithms*. Holt, Rinehart and Winston.
- [16] Lingoes, J.C. (1973) *The Guttman-Lingoes Nonmetric Program Series*. Mathesis Press.
- [17] Horan, C.B. (1969) Multidimensional Scaling: Combining Observations When Individuals Have Different Perceptual Structures. *Psychometrika* 34:139-165.
- [18] Yamauchi, T. (1978) *Methods for Individual Difference Multidimensional Scaling and Their Applications*. Master Thesis guided by Y. Nishikawa and H. Itakura. Kyoto, Japan: Kyoto University (in Japanese).
- [19] Fukuda, K. (1978) *An Improvement of Quantification Method with an External Criterion and Its Application*. Graduation Thesis guided by Y. Nishikawa and H. Itakura. Kyoto, Japan: Kyoto University.



A PLANNING MODEL FOR MANAGING WATER SUPPLY AND TREATMENT  
LINKED WITH AN INTEGRATED REGIONAL DEVELOPMENT MODEL

Y. Suzuki, K. Shoji, P.S. Pak, and H. Kamitani  
*Department of Electrical Engineering, Osaka University,  
Suita, Osaka, Japan*

T. Ono and S. Tsujio  
*Department of Mechanical Engineering, University of Osaka  
Prefecture, Osaka, Japan.*

K. Ito  
*Department of Mechanical Engineering for Industrial  
Machinery, Osaka University, Osaka, Japan*

N. Adachi  
*Department of Applied Mathematics and Physics, Kyoto Uni-  
versity, Kyoto, Japan*

ABSTRACT

The primary objective of this study is to develop hierarchical models for the management of water supply and treatment of a river basin.

The major socioeconomic indicators that must be considered in a water management problem are obtained from an integrated regional development planning model (IRDPM), which has been built to seek the desirable long-term socioeconomic development pattern of the region.

Next, a water demand estimation model (WDEM) is built to calculate water demands for each socioeconomic sector taking into account the improvement of the quality of life and the technological progress. A model to estimate the amount of BOD exhausted (MEBE) is also built, by which the pollution load expressed by BOD is calculated for each subregion of the river basin.

Finally, a water management planning model (WMPM) is built by which the optimal public sewage treatment strategies are considered together with the water supply planning. In this model, considering a foreseeable shortage of the water resources, it is assumed that the water treatment by public tertiary treatment plants can be reused by industry. In WMPM, the problem is formulated as an optimization one with multiobjective functions, and

the set of Pareto optimal solutions are derived by adopting the parametric method in the linear programming technique.

Through a study for the Yodo river basin, it is ascertained that various important information to support decision making for long-range water management can be obtained from the hierarchical model built.

## 1. INTRODUCTION

Caused both by Japan's rapid industrial development and by the limited availability of water resource, the shortage of water resource and the deterioration of water quality are becoming very serious particularly in highly industrialized areas.

In the survey report on long-term water resource management perspectives prepared by the Ministry of Construction of Japan [1], it is cautioned that water demands might grow to be considerably in excess of water supply by the year 1985. For example, it is estimated that water demands for residential and industrial activities will increase in Japan from 27.0 (billion m<sup>3</sup>/year) in 1960 to 57.7 in 1985. This caution indicates to us the necessity of constructing new water resource utilization systems. In other words, it is necessary not only to construct new dams but also to build new water utilization systems; e.g., under investigation in several regions are systems for reusing water treated by public tertiary treatment plans for industrial usage [2].

With the purpose of preventing the deterioration of the water quality of rivers, the water treatment problem is another important issue in water management planning. At the present time, the coverage rate of public sewerage systems is still not high in Japan (the public sewage treatment ratio by population is 14 percent in 1970 [3]). The construction planning problem of sewerage systems is one of the important subjects to be considered in integrated regional development planning in Japan.

Being in the situation mentioned above, we are now under tremendous pressure to find ways of improving utilization and treatment of this important resource, based on more complete pictures of water management planning systems.

The primary objective of this study is to develop a planning system model for water supply and treatment management for a river basin. The region specifically studied is the Yodo river basin, which is one of the most important regions in Japan, because the Yodo supplies drinking water to about 10 million people and industrial water to one of the economic centers of Japan.

In the study of water management planning of a river basin, it is essentially necessary to estimate future water demands and pollution loads of a region by forecasting developments of socio-economic activities (residential, industrial, etc.). In most previous water management planning studies, these necessary socio-economic indicators have not been calculated directly by building regional development models.

The total planning model developed in this study is constructed of the following four submodels:

- an integrated regional development planning model (IRDPM) used to seek the desirable development pattern of a river basin
- a water demand estimation model (WDEM) to calculate future water demands for each socioeconomic sector
- a model to estimate the amount of BOD to be exhausted (MEBE), which is built to calculate pollution loads of rivers based on outputs of IRDPM
- a water management planning model (WMPM) for water supply and treatment of the river basin, by which optimal public sewage treatment strategies are investigated together with water supply planning.

These four submodels are combined hierarchically as shown in Figure 1. The results obtained from WMPM are to be used to check the feasibility of a specific integrated regional development plan from the viewpoint of water usage.

## 2. INTEGRATED REGIONAL DEVELOPMENT PLANNING MODEL

The integrated regional development planning model used here has been built to seek the desirable long-term socioeconomic development pattern in the Kinki region (which is composed of seven prefectures in the middle of Japan). The Yodo river basin is the central part of the Kinki region, and the Yodo and its main branches flow through four prefectures.

The major socioeconomic indicators necessary for consideration in a water management problem of this basin are basically obtained from IRDPM, but some rearrangements are necessary because of the discrepancy of regional division between IRDPM and WMPM. A detailed description of IRDPM is given in [4]. In this section, only a brief explanation of the model structure is given.

In IRDPM, various aspects are taken into account, not only economical ones but also ones concerning environmental pollution, and land and water resource availability. The principal factors included in IRDPM are as follows:

- age structures of population and labor force
- industries classified into 12 sectors
- social overhead capital
- consumption structure
- transportation among prefectures
- total amounts of land and water available ultimately, and environmental capacity at the prefecture level
- substitution between capital and labor
- technological progress.

As these factors are too large to be handled by a single model, a hierarchical approach is adopted here; i.e., the whole IRDPM is constructed by combining the following three submodels hierarchically.

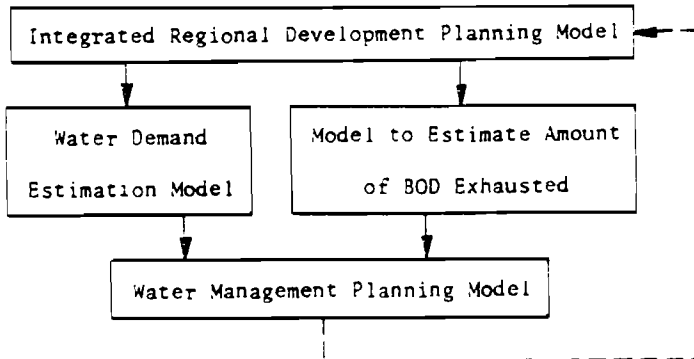

Figure 1. Hierarchical structure of total systems model for water management.

In the upper stratum submodel, seven prefectures of the Kinki region are aggregated together and the whole region is treated as one. Assuming the future consumption pattern, both capital and labor are allocated to each industry so as to maximize the gross regional product of the whole region by adopting a linear-programming technique.

In the middle stratum submodel, only two time points, i.e., the initial and the final years of the whole planning period, are considered, whereas the region is divided into prefectures. The linear-programming technique is also used to determine the optimal regional allocation of population, industry, and social capital in the final year under several premises which are given by the upper stratum submodel. Here, the amounts of land and water available ultimately are taken into account as constraints in the process to determine the optimal allocation pattern. This submodel is built with the purpose of reducing the operational difficulty of the whole model; i.e., it makes it easier to examine various alternatives of the regional development strategy under different premises.

The dynamic feasibility of some suitable development patterns obtained by this submodel is examined more precisely by the lower stratum submodel. The fundamental structure of this submodel is shown in Figure 2. The demand-supply relationships

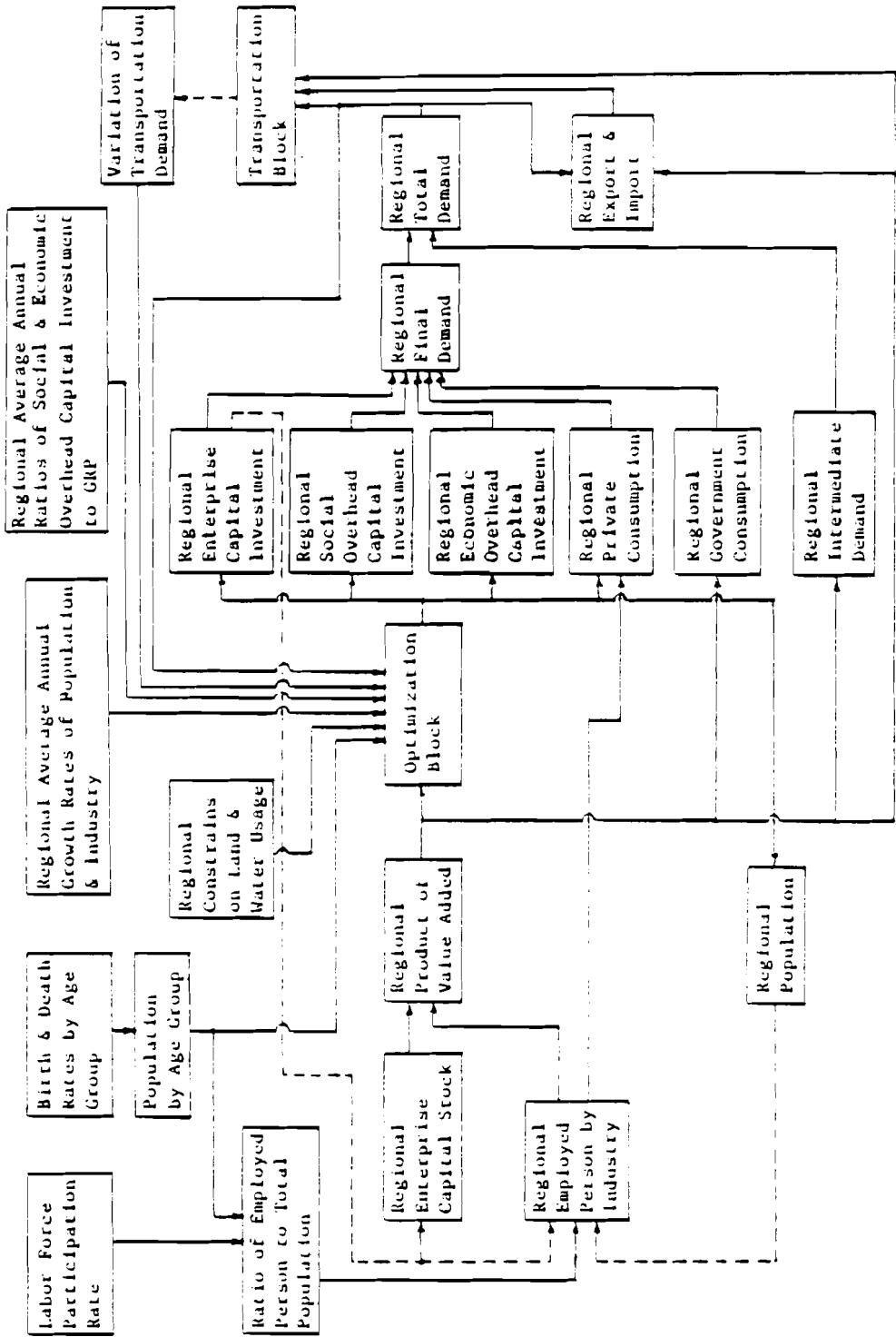

Figure 2. Structure of lower stratum submodel in IRDPM.

derived from the input-output table are considered annually and the optimal strategy of investment is determined by using a quadratic-programming technique.

### 3. MODEL TO ESTIMATE WATER DEMAND AND BOD EXHAUSTED

In the planning problem of water supply and treatment management for a river basin, the whole region is divided into  $M$  sub-regions. The total planning period is divided into  $N$  planning stages, and we let  $n$  denote the  $n$ th planning stage.

#### 3.1. Water Demand Estimation Model (WDEM)

In WDEM, water demands of each region are estimated categorized into the following socioeconomic sectors: residential, commercial, industrial, and agricultural. Other economic sectors such as forestry and mining are omitted because of their low water consumption or of their low activity in the region. A schematic description of WDEM is given in Figure 3.

##### -Residential + Commercial Sectors

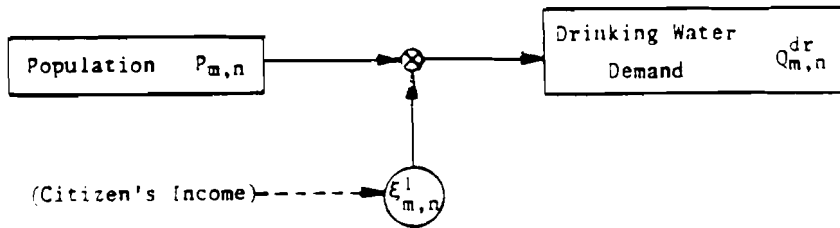

##### -Industrial Sector

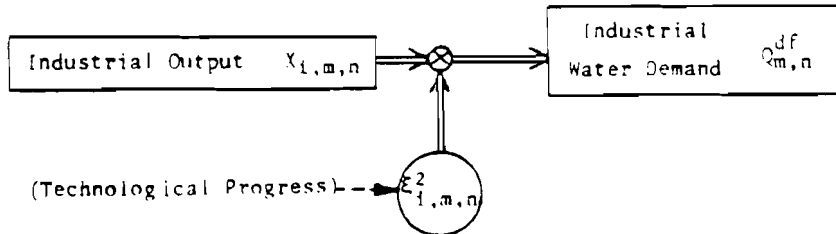

##### -Agricultural Sector

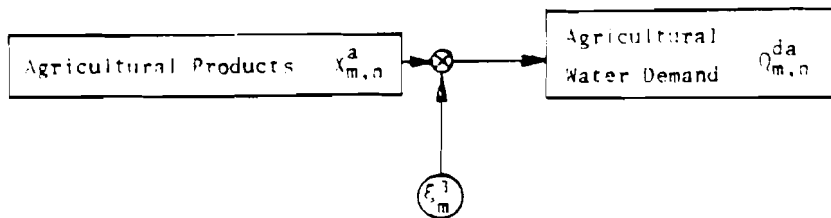

Figure 3. Schematic description of WDEM.

Water demands for the residential and commercial sectors are estimated together based on the number of inhabitants of the  $n$ th region, i.e.,  $P_{m,n}$  (persons). The future drinking water demand for these sectors, say  $Q_{m,n}^{dr}$  ( $m^3/day$ ), is calculated by multiplying  $P_{m,n}$  by the unit amount of water demand per capita, which is expressed by  $\xi_{m,n}^1$  ( $m^3/person/day$ ). It is assumed that  $\xi_{m,n}^1$  takes a different value in each region, and it will increase in the future because of the rise of citizen's income.

For the industrial sector, water demands for each region denoted  $Q_{m,n}^{df}$  ( $m^3/day$ ) are estimated based on industrial outputs categorized by 20 manufacturing industries,  $X_{i,m,n}$  (yen/year), calculated by IRDPM. The amount of water demand to produce unit industrial output, say  $\xi_{i,m,n}^2$  ( $m^3/(yen/year)/day$ ), takes a different value in each region, and it is assumed that it will decrease because of the technological progress such as the increase of the recycling ratio of water usage in the future.

Agricultural water demand  $Q_{m,n}^{da}$  ( $m^3/day$ ) is also estimated for each region based on the agricultural products  $x_{m,n}^a$  (yen/year), and the unit of water demand for this sector  $\xi_{m,n}^3$  ( $m^3/(yen/year)/day$ ) is assumed to be constant through the whole planning period.

### 3.2. Model to Estimate the Amount of BOD Exhausted (MEBE)

There are many items that indicate the level of water pollution such as biochemical oxygen demand (BOD), chemical oxygen demand (COD), total nitrogen (TN), suspended solids (SS), etc. To investigate a long-term water treatment planning problem in a wide area, BOD is used here as an indicator to express the level of water quality in rivers.

The structure of MEBE is shown in Figure 4. As pollution sources of BOD, the agricultural sector including the livestock industry is omitted because of its negligible pollution load exhausted to the region.

For the residential and commercial sectors, the amounts of BOD generated are calculated classified by night soil and other waste water. Let us denote the generation factors of BOD from night soil and other waste water as  $\rho^1$  and  $\rho_n^2$  (g/person/day), respectively. It is assumed that  $\rho^1$  is constant for both  $m$  and  $n$ , and  $\rho_n^2$  increases its value with  $n$  due to the improvement of the quality of life. The total amount of BOD generated, say,  $J_{m,n}^F$  (ton/day), is obtained from

$$J_{m,n}^F = \lambda_n J_{m,n} + (1 - \lambda_n) G_{m,n}^F = \rho^1 P_{m,n} + \rho_n^2 P_{m,n} \quad (1)$$

where  $\lambda_n$  is the ratio of BOD from night soil to the total one.

-Residential + Commercial Sectors

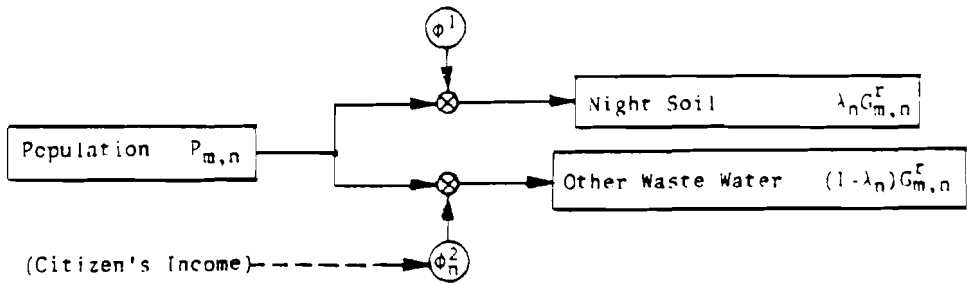

Industrial Sector

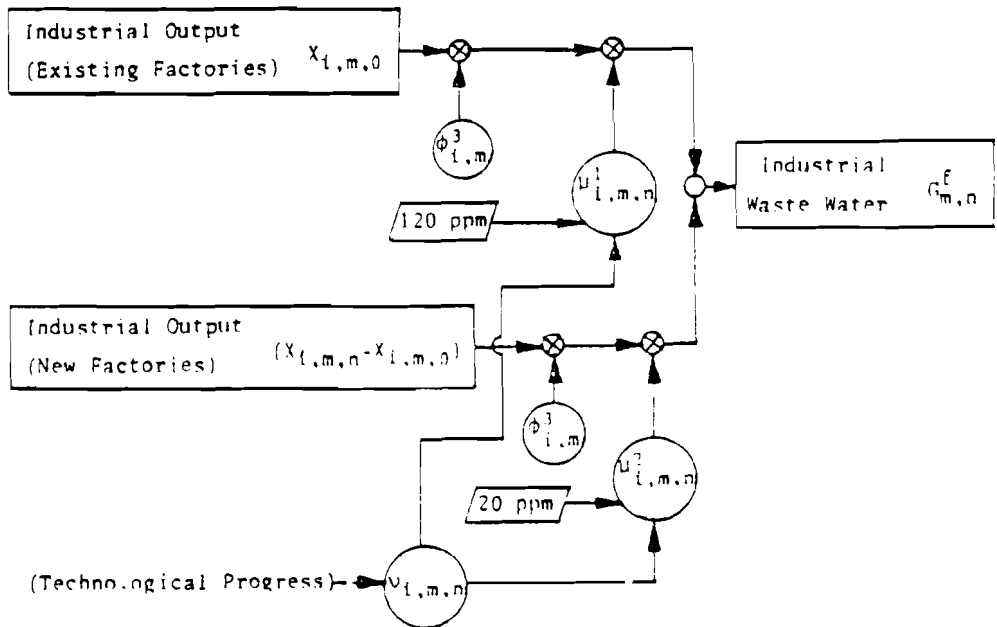

Figure 4. Structure of MEBE.



In Figure 4,  $\phi_{i,m}^3$  means the generation factor of BOD from manufacturing factories, and this value differs according to industrial category  $i$  and to region  $m$  and is in units of kg/(yen/year)/day. Factories have imposed on them the following effluent standards of BOD, concerning industrial waste water, by local authorities in the Yodo river basin: the concentration of BOD of waste water exhausted from factories should be under 120 (ppm) for already existing factors, and 20 (ppm) for newly installed ones. Let us denote the BOD concentration of generated waste water by  $v_{i,m,n}$  (ppm), which changes its value with  $n$  because of future technological progress, then the reduction rate of BOD, say,  $u_{i,m,n}^1$  and  $u_{i,m,n}^2$  can be determined by  $v_{i,m,n}$  and the effluent standards mentioned above. The total amount of BOD exhausted into the region from factors  $G_{m,n}^f$  (ton/day) is given by

$$G_{m,n}^f = \sum_i \left[ u_{i,m,n}^1 \phi_{i,m}^3 X_{i,m,0} + u_{i,m,n}^2 \phi_{i,m}^3 (X_{i,m,n} - X_{i,m,0}) \right] \quad (2)$$

#### 4. WATER MANAGEMENT PLANNING MODEL (WMPM)

##### 4.1. Structure of WMPM

In the previous section, the amount of water demand and pollution load are estimated. In WMPM, both the problem of supply to meet these water demands and the problem of treatment of pollution loads are considered simultaneously as a mathematical problem with multiple objective functions.

First, with the purpose of meeting increasing water demands, we must develop new water resources at each planning state. For the Yodo river basin, it is now becoming very difficult to construct new large-scale dams. In WMPM, considering the foreseeable shortage of water resources, it is assumed that much-treated water from public tertiary treatment plans can be reused for industry. When the variable  $\eta_{m,n}$  (the ratio of reused tertiary treated discharge to the total) increases, then the minimum amount of water expressed by  $Q_{m,n}^S$  ( $m^3/sec$ ) decreases and this must be newly developed in the region  $m$  at the planning stage  $n$ . One of the key subjects for making proper decisions for water supply management is the trade-off relationship between  $\eta_{m,n}$  and  $Q_{m,n}^S$ . At present, it is very hard to estimate costs necessary to construct treated water reuse systems and new dams in the Yodo river basin. In WMPM, the costs of developing these new water supply systems are not considered explicitly, but they are investigated implicitly in the model. In other words, the cost of building new reuse systems for treated water is embedded into  $\eta_{m,n}$ , which is considered as the principal policy parameter in WMPM. The cost to build new dams at each planning stage is also embedded into  $Q_{m,n}^S$ , which is considered to be one of the objective functions to be minimized.

Next, with the purpose of preventing the deterioration of water quality, the construction problem of public sewerage and treatment plants should be investigated in WMPM. For water treatment management, the variables to be determined are the following:

- (a) the coverage rate of public sewerage systems
- (b) the ratio of primary and secondary treated waste water to the total, denoted by  $\alpha_{m,n}$
- (c) the ratio of the tertiary treated waste water to the total, denoted by  $\beta_{m,n}$ .

It is assumed that waste water discharged into the public sewerage system is purified at least at primary and secondary treatment plants. Therefore, it is assumed that the ratio of (a) is equal to  $\alpha_{m,n}$  of (b). The optimal strategy for constructing treatment systems is solved so as to minimize the total cost of both construction and operation necessary for water treatment, which is denoted by  $J_1(n)$  (yen) for the  $n$ th planning stage and is considered to be the principal objective function in WMPM.

The increase of  $Q_{m,n}^S$  causes the rise of discharge of rivers, and it is reflected in the decrease of the BOD density of river water. Thus it is obvious that the cost function  $J_1(n)$  necessary to satisfy environmental constraints on rivers will decrease if we can increase  $Q_{m,n}^S$  by developing new water resources. Therefore, it becomes very important to examine the trade-off relationship between  $J_1(n)$  and  $Q_{m,n}^S$ .

As a result, the problem considered in WMPM is reduced to determining the optimal set of  $\alpha_{m,n}$  and  $\beta_{m,n}$ , which minimizes the objective functions of  $J_1(n)$  and  $Q_{m,n}^S$  simultaneously for an adequate value of  $\eta_{m,n}$  under various constraints.

In this model, the optimal solution is determined sequentially for each planning stage  $n$ . Since the optimization problem formulated in WMPM has multiple objective functions, the optimal set of strategies for the  $n$ th stage ( $\alpha_{m,n} = \alpha_{m,n}^*$ ,  $\beta_{m,n} = \beta_{m,n}^*$ ;  $m = 1-M$ ) is not determined uniquely, but a set of solutions is derived that satisfy Pareto optimality [5].

Based on the results, such as optimal solutions ( $\alpha_{m,n}^*$ ;  $\beta_{m,n}^*$ ) and the trade-off relationship between multiple objective functions for various  $\eta_{m,n}$ , the decision makers select the most appropriate strategy for water management from the set of Pareto optimal solutions.

After finding the best policy for the  $n$ th stage it becomes possible to investigate the optimal planning problem for the next stage. Repeating this procedure sequentially until the final stage  $n = N$  is reached, it becomes possible to study the long-term planning problem for water management of the river basin.

#### 4.2. Mathematical Description of WMPM

The detailed mathematical description of WMPM is as follows:

##### 4.2.1. Quantitative Relationship of Water Flow

The quantitative flow diagram of water including demand and supply relationships in each region is illustrated in Figure 5. The mathematical notation in this figure is as follows:

- $Q_{\pi,n}^d$  — total amount of water demand for the region  $\pi$  in the  $n$ th planning stage ( $m^3/\text{day}$ )
- $Q_{\pi,n-1}^{s,\text{sum}}$  — amount of water supplied for residential and industrial sectors from dams and underground water sources within the region  $\pi$  developed before the  $n$ th planning stage ( $m^3/\text{sec}$ ).
- $Q_{\pi,n}^u$  — intake amount of water from main river ( $m^3/\text{sec}$ )
- $Q_{\pi,n}^{u1}$  — mean discharge at the upper stream point ( $m^3/\text{sec}$ )
- $Q_{\pi,n}^0$  — lower limit of water discharge permissible downstream of the intake point ( $m^3/\text{sec}$ )
- $\delta$  — rate of loss in water usage process.

To meet the increasing water demand of each region, the relationship

$$Q_{\pi,n}^d \leq Q_{\pi,n}^u + Q_{\pi,n-1}^{s,\text{sum}} + Q_{\pi,n}^s + \gamma_{\pi,n} \beta_{\pi,n} (1 - \delta) Q_{\pi,n}^d \quad (\pi=1-M) \quad (3)$$

must be satisfied, in which the fourth term of the right side is equal to the amount of recycled water from tertiary treatment plans. Since it is possible to reuse tertiary treated water only for industry, the following constraint should be imposed:

$$\gamma_{\pi,n} \beta_{\pi,n} (1 - \delta) Q_{\pi,n}^d \leq \gamma_{\pi,n} Q_{\pi,n}^{df} \quad (4)$$

where  $\gamma_{\pi,n}$  is the maximum rate of tertiary treated water applicable to the industrial water demand. Furthermore, as there is a lower limit of water discharge permissible downstream of the intake point, the relationship

$$Q_{\pi,n}^0 \leq Q_{\pi,n}^{u1} - Q_{\pi,n}^u \quad (5)$$

must be satisfied for each  $\pi$ .

As illustrated in Figure 5, the agricultural water demand  $Q_{\pi,n}^{da}$  is not included in  $Q_{\pi,n}^d$  because of the difference of methods

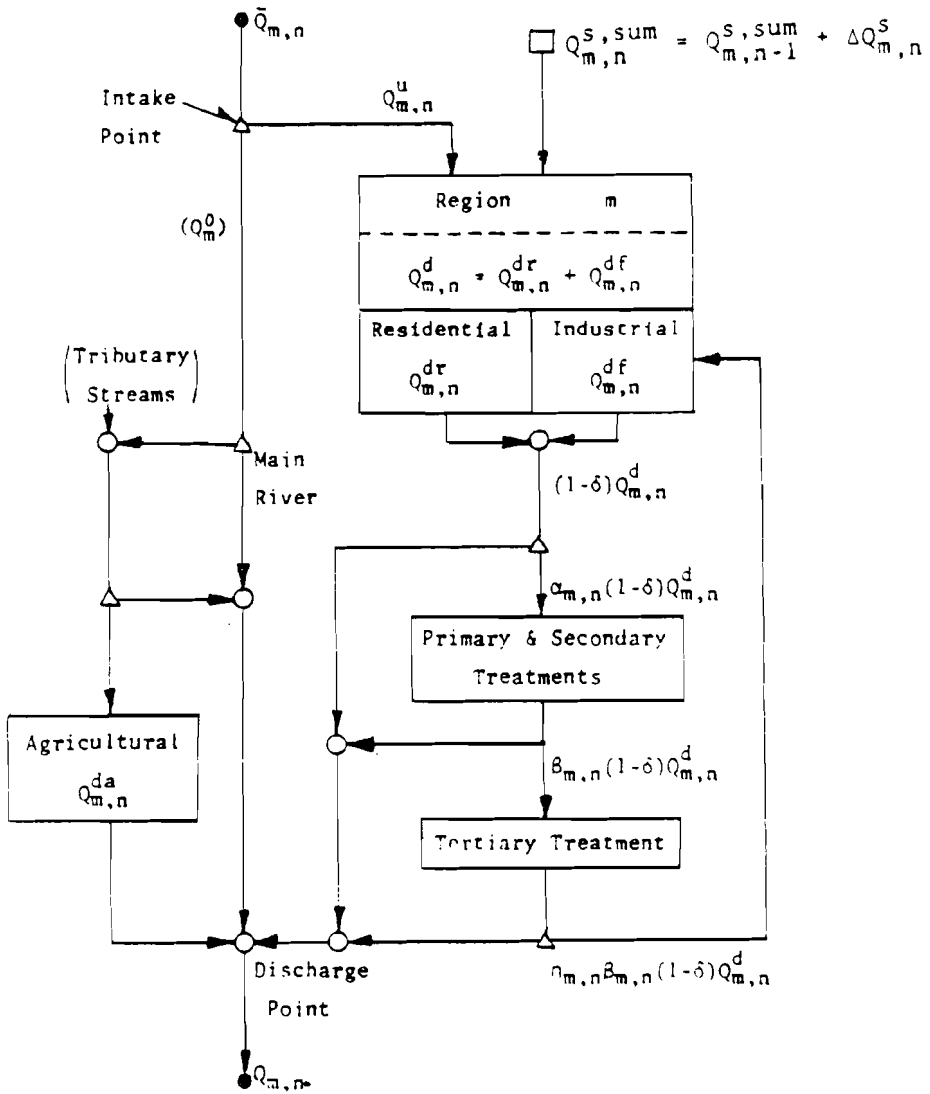

Figure 5. Quantitative flow diagram of water in each region.

of water supply from those for water for residential and industrial use. Based on the results from IRDPM, it is assumed here that  $q_{m,n}^{da} = q_m^{da} = \text{constant}$  for the Yodo river basin, and so this is not treated explicitly in WMPM.

Taking into account the increase of developed water resources, the mean discharge downstream increases as

$$Q_{m,n} = Q_{m,n-1} + (\bar{Q}_{m,n} - \bar{Q}_{m,n-1}) + Q_{m,n}^s - \delta(Q_{m,n}^d - Q_{m,n-1}^d) \quad (6)$$

#### 4.2.2. Quantitative Relationship of BOD

Next, let us consider the treatment problem of the pollution load of BOD exhausted in each region. In Figure 6, the quantitative-flow diagram of BOD pollution load and its treatment is shown, and the mathematical notation in this figure is as follows:

- $G_{m,n}$  — total amount of BOD exhausted within the region  $m$  for the  $n$ th planning stage (ton/day)
- $\delta$  — elimination rate of BOD at night soil treatment plant
- $R^r$  — rate of run-off for other waste water of residential sector caused by purification in tributary streams
- $R^f$  — rate of run-off for industrial waste water
- $\gamma_2$  — elimination rate of BOD primary and secondary treatments
- $\gamma_3$  — elimination rate of BOD primary, secondary, and tertiary treatments
- $\bar{E}_{m,n}$  — pollution load of BOD at the upper stream point (ton/day)
- $E_{m,n}$  — pollution load of BOD at the downstream point (ton/day)
- $T_m$  — reaching time between upper and downstream points (day)
- $\tau_m$  — reaching time between discharge and downstream points (day).

Let  $P_{m,n}$  (ton/day) denote the amount of BOD purified within the region  $m$  for the  $n$ th planning state, then the discharged amount of BOD to the main river expressed by  $\bar{E}_{m,n}$  (ton/day) is given by

$$\bar{E}_{m,n} = G_{m,n} - P_{m,n} \quad (7)$$

As illustrated in Figure 6,  $P_{m,n}$  can be calculated as follows:

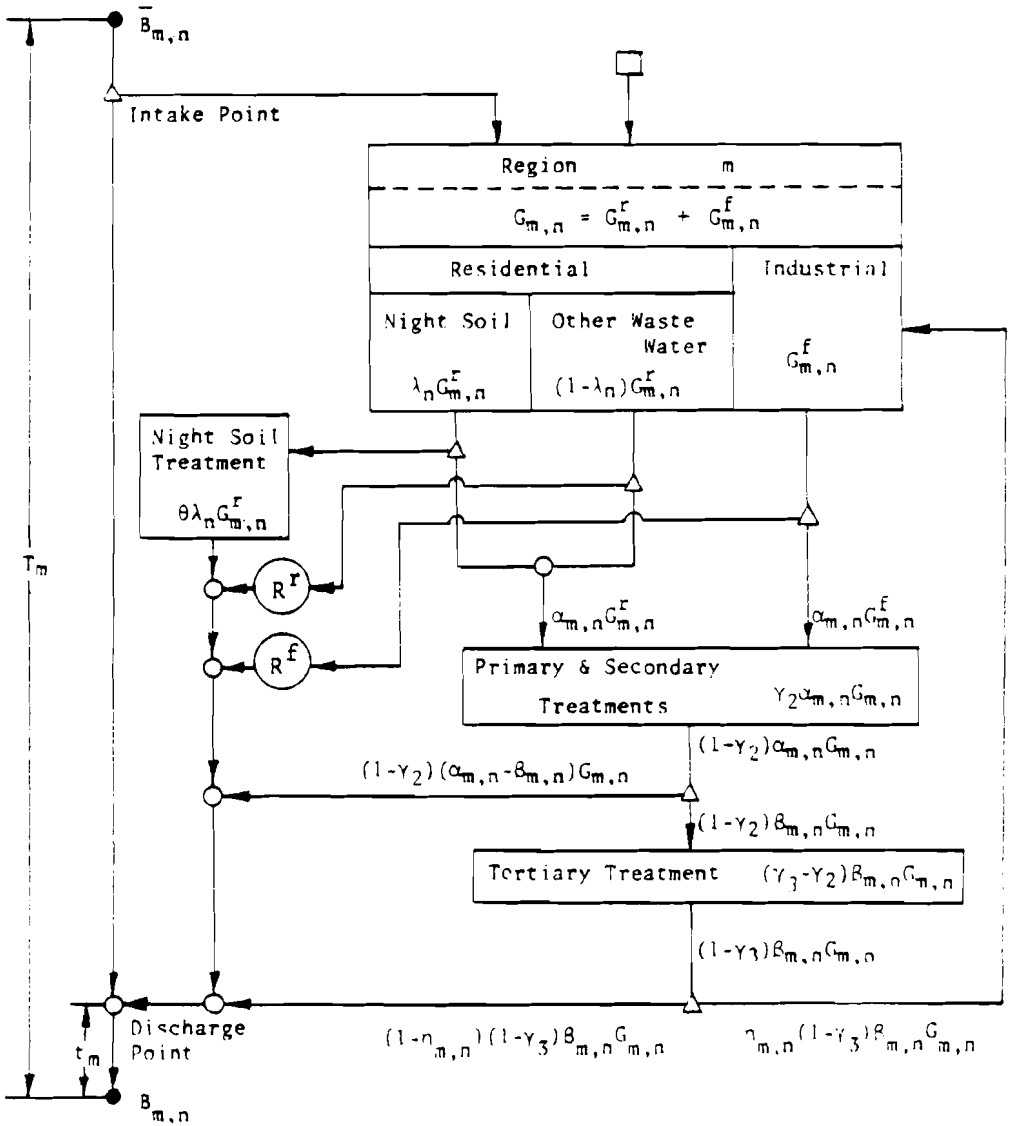

Figure 6. Quantitative flow diagram of pollution load of BOD and its treatment.

$$\begin{aligned}
P_{m,n} = & \gamma_2 \alpha_{m,n} \beta_{m,n} + (\gamma_3 - \gamma_2) \beta_{m,n} \\
& + (1 - \alpha_{m,n}) \left[ \beta \lambda_n G_{m,n}^F + (1 - R^F) (1 - \lambda_n) G_{m,n}^F \right. \\
& \left. + (1 - R^F) G_{m,n}^F \right] + \eta_{m,n} (1 - \gamma_3) \beta_{m,n} G_{m,n} \quad (8)
\end{aligned}$$

where the last term of the right side is the one not discharged into the main river by the reuse of wasted water. As it is almost impossible to construct public sewerage in areas of very low population density, the constraint

$$\alpha_{m,n-1} \leq \alpha_{m,n} \leq \alpha_m^0 = \text{constant} \quad (9)$$

should be imposed, in which  $\alpha_m^0$  expresses the maximum value of  $\alpha_{m,n}$  for the region  $m$  through the whole planning period. As it is physically impossible for  $\beta_{m,n}$  to exceed  $\alpha_{m,n}$  it holds that

$$\beta_{m,n-1} \leq \beta_{m,n} \leq \alpha_{m,n} \quad (10)$$

Expressing the self-purification phenomenon in the main river by the Streeter-Phelps equation [6], it follows that

$$\beta_{m,n} = \left[ \exp(-Kt_m) \bar{\beta}_{m,n} \right] (\bar{q}_{m,n} - q_{m,n}^u) / \bar{q}_{m,n} + \exp(-Kt_m) \beta_{m,n} \quad (11)$$

where  $K$  is the coefficient of self-purification in the main river. The environmental constraint of BOD density imposed by the local authorities of the Yodo river basin, expressed by  $q_{m,n}^0$  (ppm), is specified at the downstream point of each region. Then the water quality of BOD at this point, say  $q_{m,n}$  (ppm) must satisfy

$$q_{m,n} = \beta_{m,n} / \bar{q}_{m,n} \leq q_{m,n}^0 \quad (12)$$

If the upper stream point is not a place where several rivers meet, then

$$\bar{q}_{m,n} = \bar{q}_{m-1,n} \quad (13)$$

and

$$\bar{\beta}_{m,n} = \beta_{m-1,n} \quad (14)$$

It is possible to consider relationships similar to (13) and (14) for the case in which several rivers meet at the upper stream point.

4.2.3. Objective Function  $J_1(n)$ 

The principal objective function  $J_1(n)$  to be minimized is

$$\begin{aligned}
 J_1(n) = \sum_{m=1}^M & \left[ C_{1,n} S_m (\alpha_{m,n} - \alpha_{m,n-1}) \right. \\
 & + C_{2,n} (G_{m,n} \alpha_{m,n} - G_{m,n-1} \alpha_{m,n-1}) \\
 & + C_{3,n} (G_{m,n} \alpha_{m,n} + G_{m,n-1} \alpha_{m,n-1})/2 \\
 & + C_{4,n} (G_{m,n} \beta_{m,n} - G_{m,n-1} \beta_{m,n-1}) \\
 & \left. + C_{5,n} (G_{m,n} \beta_{m,n} + G_{m,n-1} \beta_{m,n-1})/2 \right] \quad (15)
 \end{aligned}$$

where

- $C_{1,n}$  — unit cost to construct public sewerage at the  $n$ th planning stage (yen/km<sup>2</sup>)
- $S_m$  — total area of urban districts of the region  $m$  (km<sup>2</sup>)
- $C_{2,n}$  — total cost to construct primary and secondary treatment plants [yen/(ton/day)]
- $C_{3,n}$  — unit cost to operate primary and secondary treatment plants through the  $n$ th planning period [yen/(ton/day)]
- $C_{4,n}$  — unit cost to construct tertiary treatment plant [yen/(ton/day)]
- $C_{5,n}$  — unit cost to operate tertiary treatment plant [yen/(ton/day)].

Furthermore,  $Q_{m,n}^S$  ( $m = 1-M$ ) are considered to be the other objective functions to be minimized in WMPM.

As a result, the planning problem formulated in WMPM is as follows: for a set of all initial and parameter values given *a priori* to the model, find the set of optimal solutions ( $\alpha_{m,n}^*$ ;  $\beta_{m,n}^*$ ) that minimizes both  $J_1(n)$  of equation (15) and  $Q_{m,n}^S$  ( $m = 1-M$ ) in equation (3) by changing the value of  $\alpha_{m,n}$  in equation (3) under the constraints (3)-(14).

## 4.3. Procedure to Derive Pareto Optimal Solutions

The following procedure is adopted here. Rewrite the relationship of equation (12) as

$$\beta_{m,n} \leq \alpha_{m,n}^0 \hat{\alpha}_{m,n} \quad (16)$$



Setting  $Q_{m,n}^S = Q_{m,n}^{S0}$  = constant in equation (3), consider the objective function of  $Q_{m,n}^S$  ( $m = 1-M$ ) as a parameter. Then find the optimal solution  $(\alpha_{m,n}^{*0}; \beta_{m,n}^{*0})$  that minimizes the single objective function  $J_1(n)$  of equation (15) under the constraints (3)-(11), (13), (14), and (16). The solution of this problem can easily be obtained by the linear-programming technique (LP).

Adopting the parametric algorithm in LP [7], the behavior of the optimal solution can be investigated as being due to the value of  $Q_{m,n}^S$  ( $m = 1-M$ ) in equation (3). Let us denote the column vector  $(Q_{1,n}^S, \dots, Q_{M,n}^S)$  by  $Q_n^S$ , and let us assume that  $Q_n^S$  varies from  $Q_n^{S0}$  to  $Q_n^{S0} + \omega \Delta Q_n^S$  on changing the parameter  $\omega$ , where  $\Delta Q_n^S$  is an  $M$ -dimensional constant vector chosen arbitrarily. Then optimal value of  $J_1(n)$  denoted by  $J_1^*(n)$  changes from  $J_1^{*0}(n)$  to

$$J_1^*(n) = J_1^{*0}(n) + \Delta J_1^*(n) = J_1^{*0}(n) + k\omega \quad (17)$$

It is known that  $k$  in equation (17) takes a constant value for

$$-\underline{\Delta\omega} \leq \omega \leq \overline{\Delta\omega} \quad (18)$$

where  $\underline{\Delta\omega}$  and  $\overline{\Delta\omega}$  are constant determined by both  $Q_n^{S0}$  and  $\Delta Q_n^S$ . The relationship of equation (17) defines the trade-off curve between  $J_1^*(n)$  and  $Q_{m,n}^S$  ( $m = 1-M$ ). If this relationship is calculated for the necessary range of  $Q_{m,n}^{S0}$  by changing the initial value of  $Q_{m,n}^S$  ( $m = 1-M$ ) adequately, then the set of solutions  $(\alpha_{m,n}^*; \beta_{m,n}^*)$  that satisfy the Pareto optimality can be obtained simultaneously for various values of  $Q_{m,n}$ .

## 5. NUMERICAL EXAMPLE FOR THE YODO RIVER BASIN

In this section let us briefly explain the main results of each model as obtained through a study for the Yodo river basin.

### 5.1. Main Results of IRDPM, WDEM, and MEBE

The total area of the Yodo river basin is divided into  $M = 7$  subregions as shown in Figure 7. The increase of population and the growth of total industrial output of each region estimated by IRDPM are respectively illustrated in Figures 8 and 9. Water demands are estimated by WDEM for each region from 1975 to 2000, and part of the results are listed in Table 1. In Table 2, the amounts of BOD exhausted into each region are shown for residential and industrial sectors as estimated by MEBE.

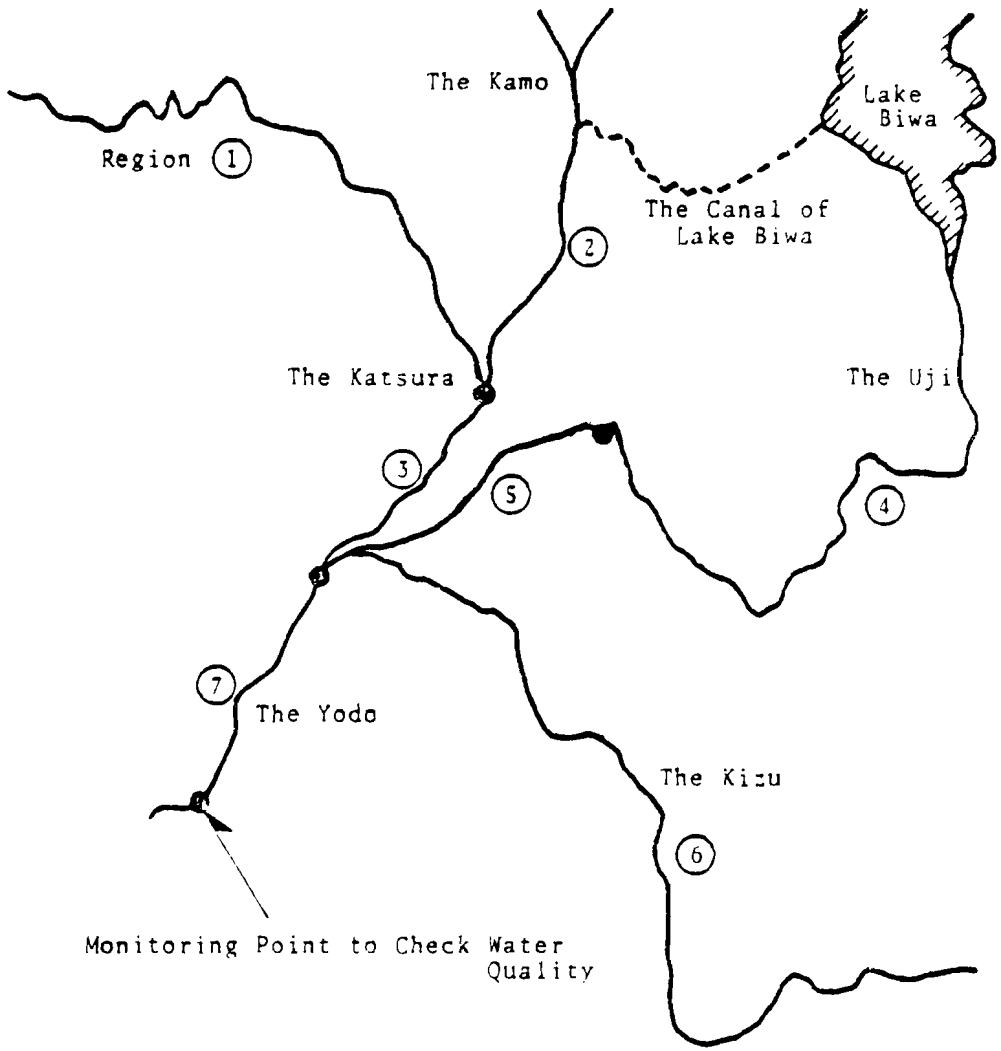

Figure 7. Regional division of the Yodo River basin.

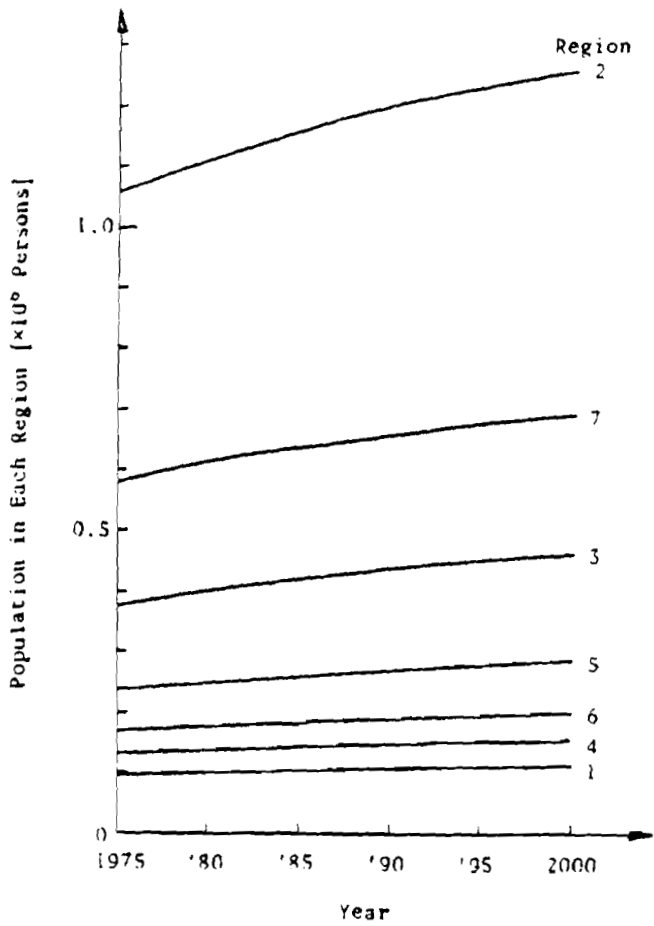

Figure 8. Population increase in each region estimated by IRDPM.

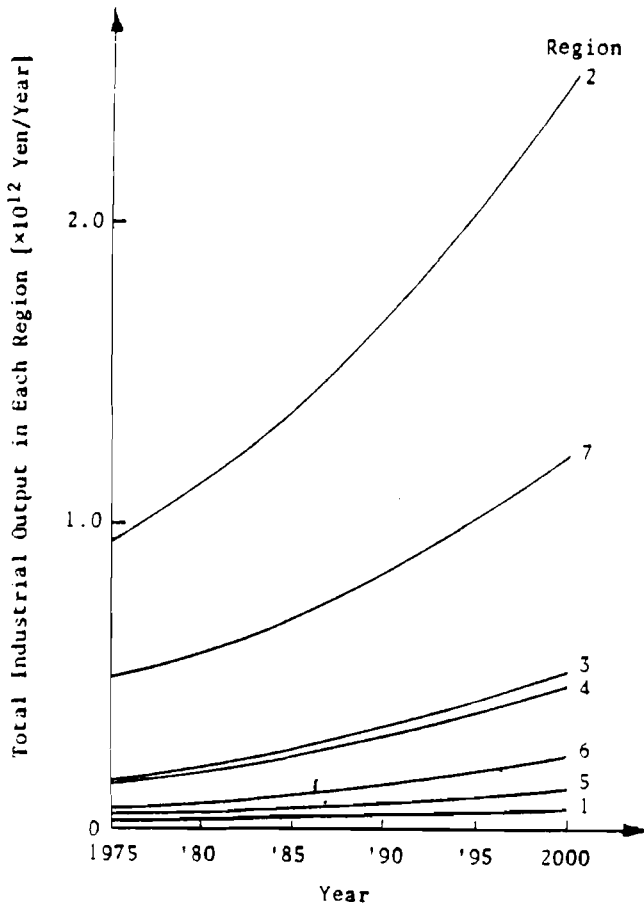

Figure 9. Increase of total industrial output in each region estimated by IRDPM.

Table 1. Water demands for residential and industrial sectors in 1975 and 2000 estimated by WDEM ( $\times 10^3$  m<sup>3</sup>/day).

Region	Residential		Industrial	
	1975	2000	1975	2000
1	21.0	39.2	9.4	18.4
2	395.6	904.3	490.9	745.7
3	110.1	260.5	66.1	134.0
4	32.0	91.9	125.4	234.1
5	87.8	204.3	15.7	29.7
6	54.9	137.9	34.1	53.5
7	187.5	418.9	115.9	122.0
Total	888.9	2057.0	857.5	1337.4

Table 2. Amount of BOD exhausted within each region in 1975 and 2000 estimated by MEBE (ton/day).

Region	Residential		Industrial	
	1975	2000	1975	2000
1	4.9	10.4	4.6	5.6
2	54.6	112.1	36.5	31.3
3	19.4	41.3	3.1	3.9
4	6.8	13.9	9.0	8.8
5	12.1	25.3	0.9	1.0
6	8.7	17.9	1.7	1.9
7	29.9	61.5	8.3	6.2
Total	136.4	282.4	64.1	58.7

## 5.2. Results of WMPM

In WMPM, decision making is every five years; i.e., the initial year of 1975 is denoted by  $n = 0$  and  $n = 1$  identifies the year 1980, and  $n = N = 5$  identifies 2000. In the Yodo river basin, both water demand and pollution load are extremely high in the region  $m = 2$  as compared with other regions, as shown in Tables 1 and 2. The region 2 includes the main part of Kyoto City, and the shortage of water resources is a particularly important social problem in this region. Previously, most of the water demand of this region has been met by the supply from Lake Biwa through a canal, as shown in Figure 7. However, it seems to be very difficult to increase the amount of water supply through this canal, and new water supply systems, such as one for reusing much-treated waste water in industry usages, should be adopted in the future in region 2. Because of the importance of water management in this region, both  $Q_{m,n}^S$  and  $\eta_{m,n}$  are investigated only for  $m = 2$  in the following.

### 5.2.1. Solutions for Short-Term Planning Problems

In Figure 10, the set of Pareto optimal solutions [i.e., the trade-off relationships among  $J_1^*(1)$ ,  $Q_{2,1}^S$  and  $\eta_{2,1}$ ] is illustrated for the first planning stage (or for the year of 1980). The set of solutions is composed of two surfaces ABCD and AEFGB, and the following are detailed descriptions of representative solutions that satisfy Pareto optimality.

#### *Solution A*

The increase of water demand in region 2 is covered by merely developing a reusing system for tertiary treated waste water, and no newly developed water supply from dams is necessary (i.e.,  $Q_{2,1}^S = 0$ ).

#### *Solution B*

The increase of water demand is covered only by developing new dams, and no reusing system for tertiary treated waste water is adopted (i.e.,  $\eta_{2,1} = 0$ ).

#### *Point C*

The values of  $Q_{2,1}$  and  $Q_{2,1}^S$  of point C are equal to those of solution B, and as the value of  $J_1^*(1)$  of solution B is small than the one of point C, the latter cannot be the one of the Pareto optimal solutions because of the definition of Pareto optimality. In other words, there exists no Pareto optimal solution on the line segment BC except solution B.

#### *Solutions CD (excluding point C)*

Pareto optimal solutions in which waste water is treated maximally in region 2.

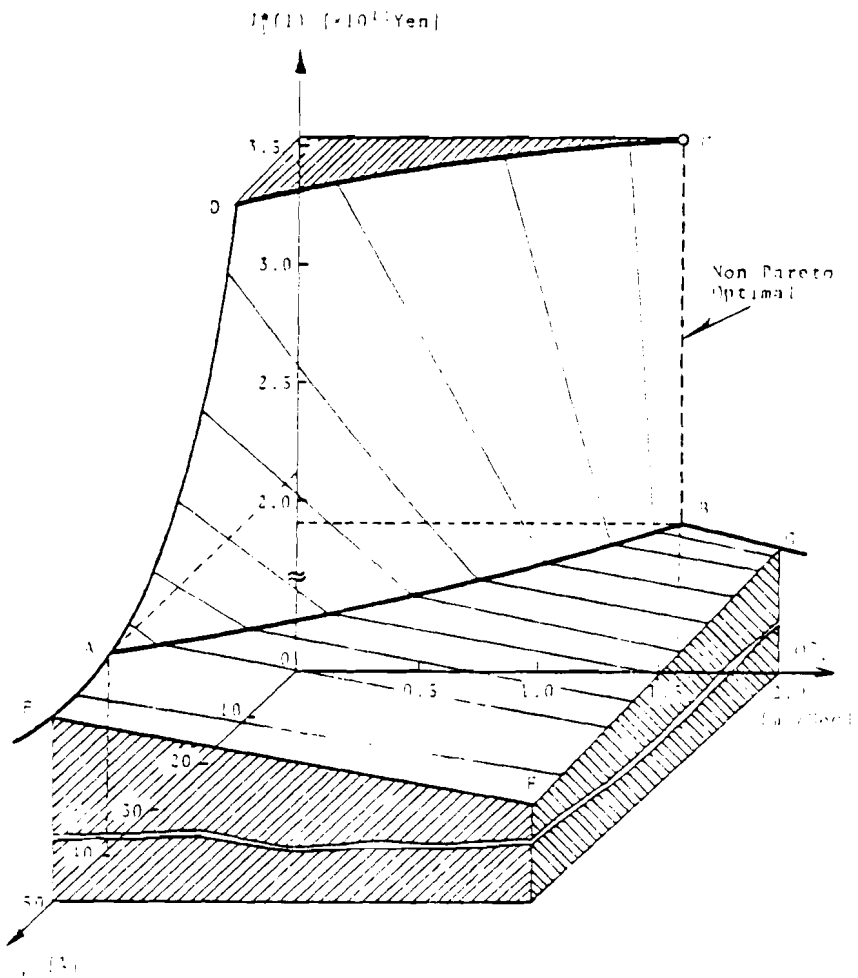

Figure 10. The set of Pareto optimal solutions for the first planning stage.

*Solutions DAE*

This curve expresses the trade-off relationship between the total cost of water treatment [ $J_1^*(1)$ ] and the ratio of re-used tertiary treated discharge to the total ( $\eta_{2,1}$ ) in which  $Q_{1,2}^S = 0$ .

*Solution BG*

This curve expresses the trade-off relationship between  $J_1^*(1)$  and  $Q_{m,n}^S$  in which  $\eta_{2,1} = 0$ .

The trade-off relationship expressed by the curve AB shows that  $Q_{2,1}^S$  decreases according to the increase of  $\eta_{2,1}$  while  $J_1^*(1)$  rises slightly. It implies that the increase of costs necessary for reusing systems of tertiary treated waste water reflects the decrease of costs for the development of new water resources, while the cost for water treatment rises a little. Next, the relationship ABCD shows the possibility of getting a feasible optimal solution by decreasing both  $Q_{2,1}^S$  and  $\eta_{2,1}$  simultaneously, though it causes a tremendous increase of the value  $J_1^*(1)$  because of the necessity of developing tertiary treatment plants. Finally, on the surface AEFGB, the increases of both  $Q_{2,1}^S$  and  $\eta_{2,1}$  reflect a small decrease of the value  $J_1^*(1)$ . It implies that newly developed water resources exceed the water demand, and the excess of supplied water results in a small improvement of water quality in the river.

Investigating these results of the trade-off relationships together with the set of optimal solutions  $(\alpha_{m,1}^*; \beta_{m,1}^*)$ , the decision makers can select the best strategy for water supply and treatment management for the first planning stage from the set of Pareto-optimal solutions.

*5.2.2. Solutions for the Long-Term Planning Problem*

After the best water management strategy is determined for  $n = 1$ , it becomes possible to seek the set of Pareto-optimal solutions for  $n = 2$ , and repeating this procedure sequentially until the final year of the planning period is reached, it becomes possible to investigate the long-term planning problem for water management systems.

In this paper, with the purpose of investigating the long-term planning problem, optimal strategies for typical scenarios are compared. Defining each scenario by assuming

$$\tilde{Q}_{2,n}^S = \sum_{i=1}^n Q_{2,i}^S$$

and taking  $\eta_{2,n}$  for  $n = 1-N$  as shown in Figure 11, the set of optimal solutions can be carried through the whole planning period. The following are detailed descriptions of the various policy scenarios:



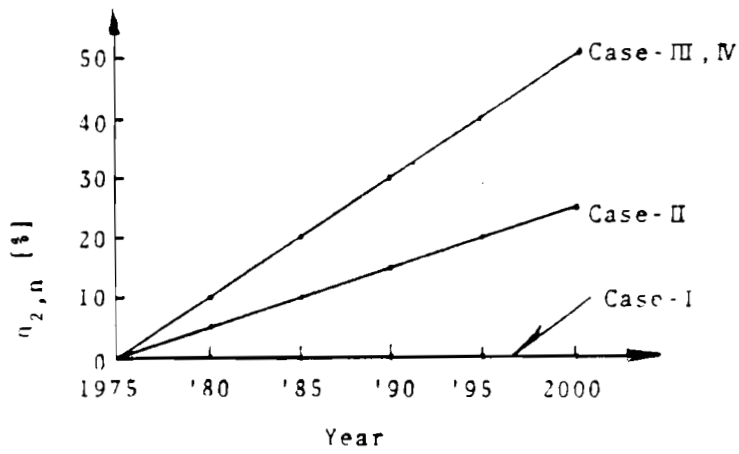

(a)

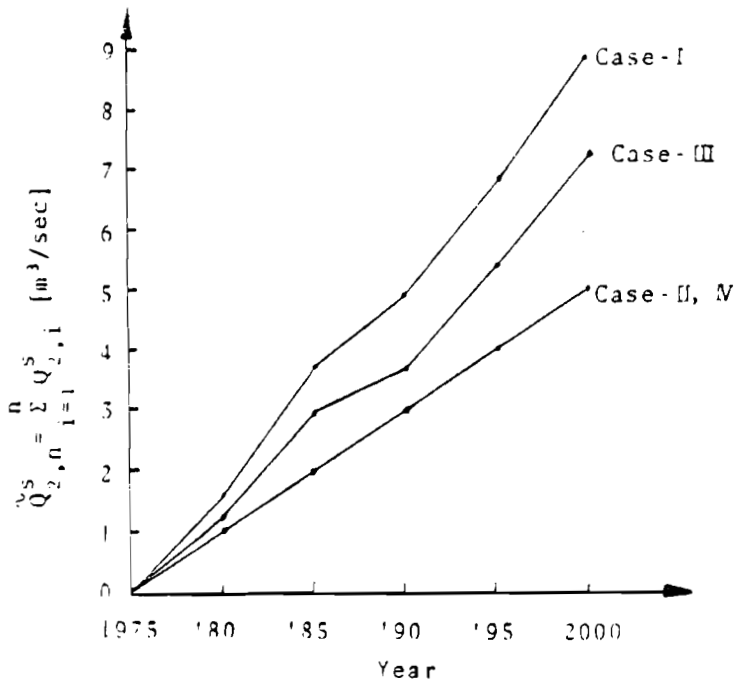

(b)

Figure 11. Definition of each scenario.

*Case I*

No reusing system of tertiary treated waste water is considered in region 2 (i.e.,  $\eta_{2,n} = 0$ ;  $n = 1-N$ ), and the minimum necessary water resource is supplied by developing new dams; that is, the Pareto-optimal solution B in Figure 10 is chosen through the whole planning period.

*Case II*

It is assumed that both  $\eta_{2,n}$  and  $\tilde{q}_{2,n}^S$  increase linearly with respect to the planning stage  $n$ .

*Case III*

It is assumed that  $\eta_{2,n}$  increases linearly with  $n$ , while  $\tilde{q}_{2,n}^S$  is determined by choosing one of the Pareto-optimal solutions within the line segment AB in Figure 10.

*Case IV*

It is assumed that both  $\eta_{2,n}$  and  $\tilde{q}_{2,n}^S$  increase linearly with  $n$  where the increasing rate of  $\eta_{2,n}$  is greater than the one of case II.

In Figure 12, comparisons of optimal values of  $\tilde{J}_1^*(n) = \sum_{i=1}^n J_1^*(i)$  for several scenarios defined in Figure 11 are illustrated. The results of Figure 12 show that the values of  $\tilde{J}_1^*(n)$  for cases I and III are relatively low compared with those for cases II and IV. It implies that if we can develop enough water resources in the future as cases I and III, the necessary cost for water treatment becomes low enough. If it is impossible to develop enough water resources in cases II and IV, then it becomes necessary to reuse to a considerable extent the tertiary treated waste water to meet the increasing water demand. As shown in Figure 12, no feasible solution is obtained for case II from 1985 caused by the low increase of  $\eta_{2,n}$  as compared with the case IV.

Figure 13 shows comparisons of optimal strategies for water treatment ( $\alpha_{m,n}^*$ ;  $\beta_{m,n}^*$ ;  $n = 1-N$ ) for cases I and IV. In Figure 14, the BOD density  $q_{m,n}^*$  together with the environmental constraint  $J_{m,n}^0$  is illustrated for these cases. The results of these figures show that it is best to construct a tertiary treatment plant rapidly in region 2 for case IV and that this will result in the improvement of water quality in this region.

## 6. CONCLUSIONS

In this study, four models linked hierarchically have been built to support decision making for the planning of water supply and treatment management of a river basin.

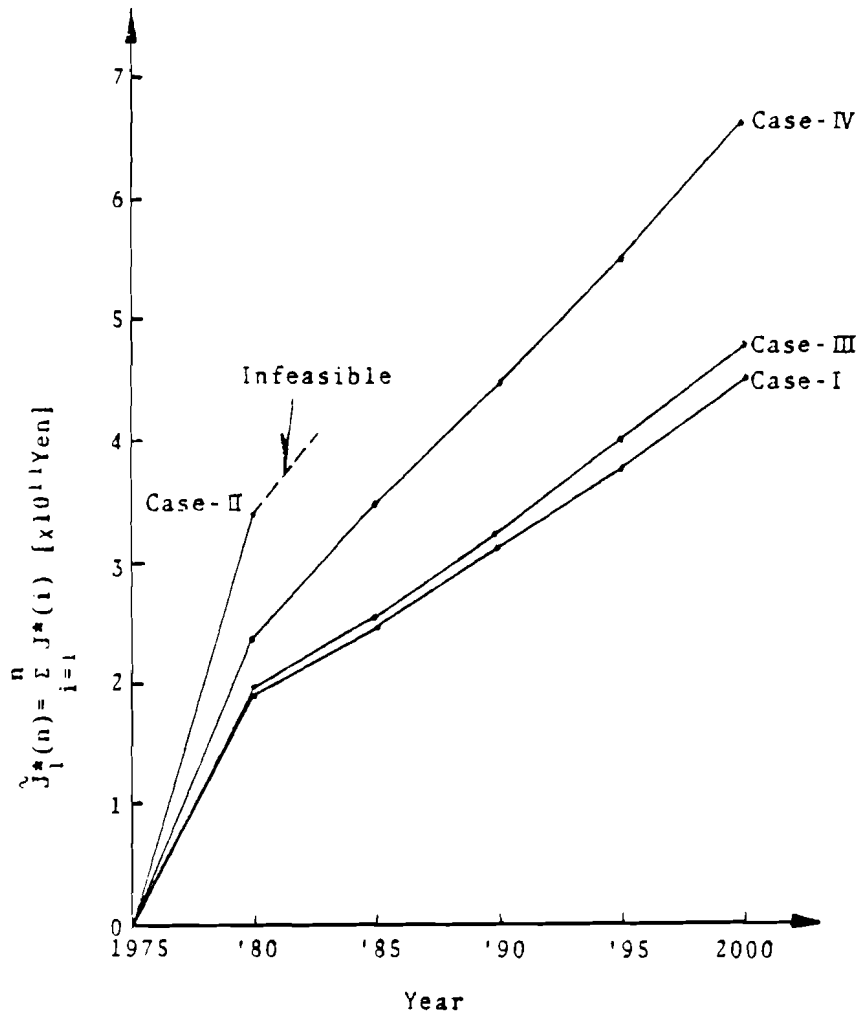

Figure 12. Comparison of  $\tilde{J}_1^*(n)$  calculated for several scenarios.

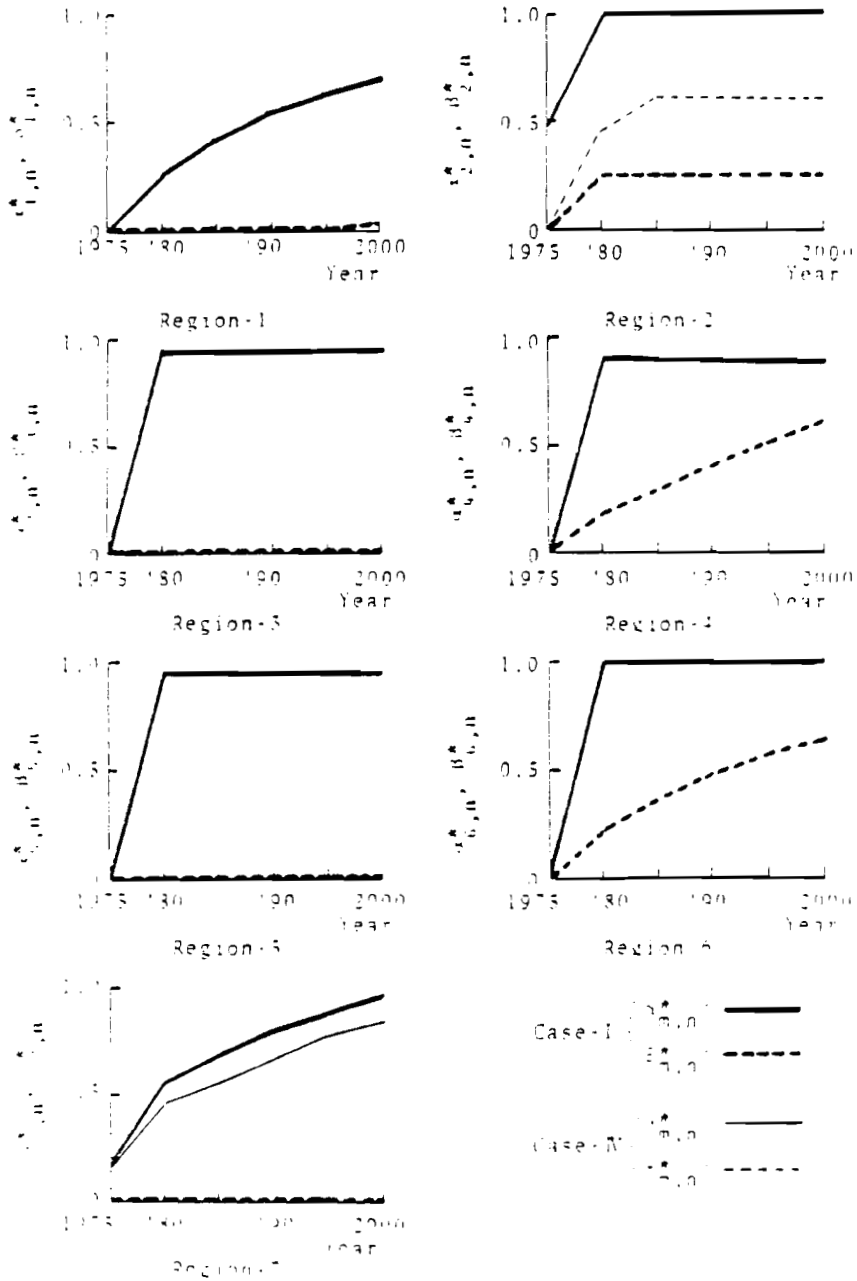

Figure 13. Comparisons of optimal strategies  $(\alpha_{m,n}^*; \beta_{m,n}^*)$  for cases I and IV.

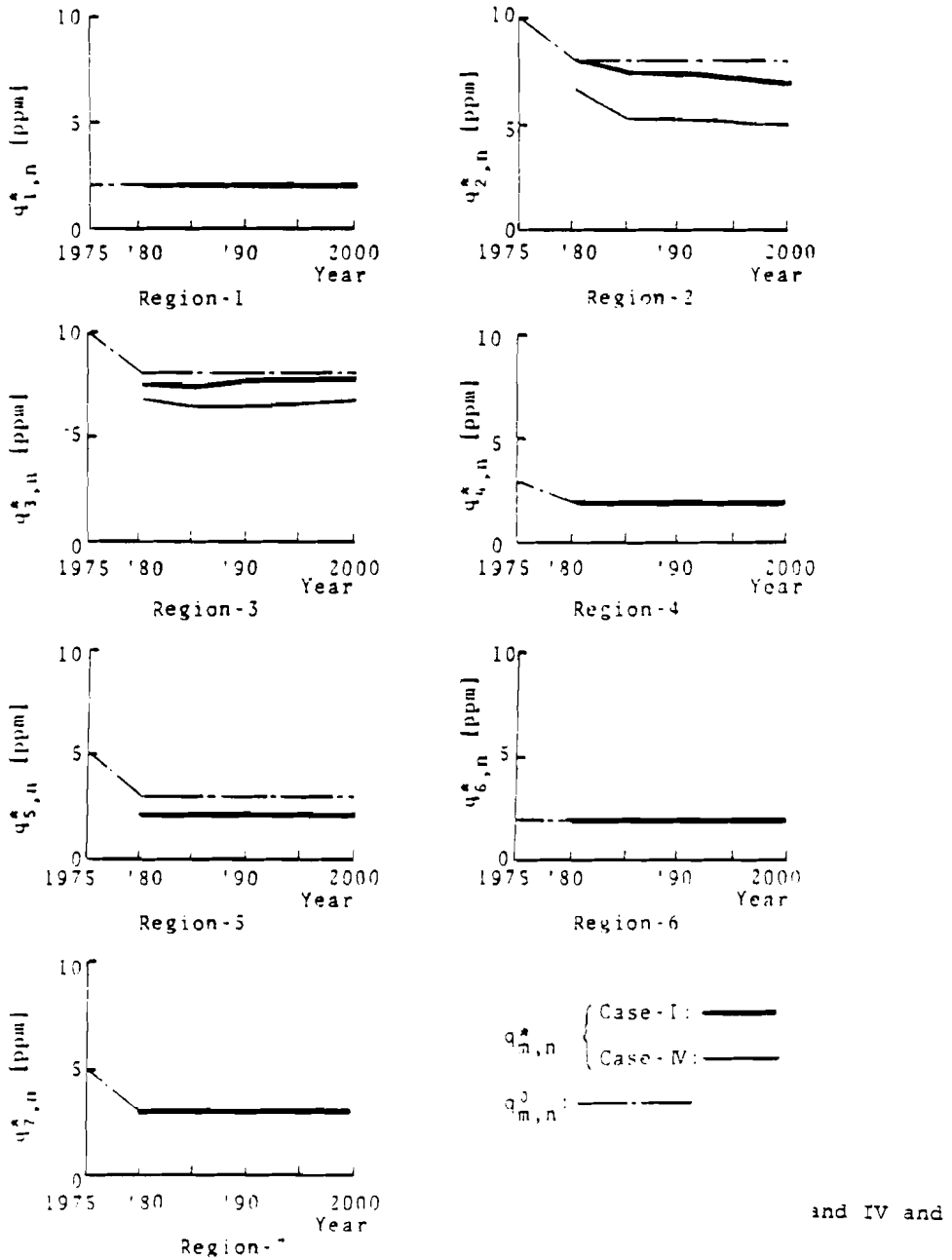

Figure 14. BOD density  $q_{m,n}^*$  calculated for cases I and IV and the environmental constraint  $q_{m,n}^0$ .

The major socioeconomic indicators to be considered in a water management problem are obtained from IRDPM, and the water demand and pollution load of BOD exhausted in each region are estimated by WDEM and MEBE, respectively.

Finally, a water management planning model (WMPM) is built by which the optimal public sewage treatment strategies are considered together with the water supply planning. In this model, considering the foreseeable shortage of the water resource, it is assumed that much-treated water from public tertiary treatment plants can be reused by present industry. In WMPM, the problem is formulated as one of optimization with multiobjective functions, and the set of Pareto-optimal solutions are derived by adopting the parametric method in linear programming.

Through the study for the Yodo river basin, it is ascertained that much worthwhile information to support decision making for long-range water management can be obtained from the hierarchical model built in this study.

#### REFERENCES

- [1] Ministry of Construction (1973) Survey Report on Long-Term Water Resource Management Perspectives (in Japanese).
- [2] Okada, N. (1976) Comprehensive Systems Analysis of Area-wide Multimodel Water Resources Utilization Systems. Doctoral Dissertation. Kyoto, Japan: Kyoto University, Department of Engineering.
- [3] Bureau of Statistics (1972) Japan Statistics Yearbook edited by the Office of the Prime Minister. Tokyo: Mainichi Press.
- [4] Suzuki, Y., H. Ishitani, and K. Shoji (1976) An integrated regional planning model of the Kinki area. In A Computer Assisted Approach to Regional Development. Report of research activities on the Kinki region of Japan, edited by H. Knop. CP-76-10. Laxenburg, Austria: International Institute for Applied Systems Analysis.
- [5] Zeleny, M. (1974) Linear Multiobjective Programming. Lecture Notes in Economics and Mathematical Systems. Springer-Verlag.
- [6] Sugiki, A. (1974) Water Pollution-Phenomenon and Control. Tokyo: Giho-do (in Japanese).
- [7] Orchard-Hays, W. (1968) Advanced Linear-Programming Computing Techniques. McGraw Hill.

## A LINEAR PROGRAMMING MODEL FOR WATER RESOURCES MANAGEMENT APPLIED TO THE YODO RIVER BASIN

K. Yoshioka and N. Adachi  
*Shimadzu Products Limited, Kyoto, Japan*

H. Tokumaru  
*Department of Applied Mathematics and Physics,  
Kyoto University, Kyoto, Japan*

### ABSTRACT

This paper presents a linear programming model for water resources management in a river basin. The basin and given planning horizon are divided into subregions and planning steps, respectively. The policy variables are the amount of water to be developed by constructing reservoirs, and the waste water that should be processed by primary, secondary, or tertiary treatment plants. These variables are determined so that they minimize the cost to construct and operate the facilities. The model was applied to the water resources problems in the Yodo river basin in Japan.

### 1. INTRODUCTION

We are concerned with water resources management problems in a highly developed industrial region. Water resources in a region are evaluated generally from two aspects, that is, from the quantity and quality of the resources. Therefore a general water resources management concerns two classes of problems. The first class includes problems related to water resources development planning and control of water quantity for various purposes and the second includes those of water quality management. Since the amount of water that is available as a resource is closely related to water quality of rivers and reservoirs, water quality management is an important part of comprehensive water resources management. However, water quality management and water resources development are usually discussed and carried out independently. The two problems may be treated separately if the interactions between them are negligible. However, the water resources

problems that we are confronted with in highly industrialized and densely populated regions are so serious that planning problems of water resources development will have no feasible solutions if the problems are not considered together with a water quality management program.

The general characteristics of the region of our concern are as follows.

- (i). Growth of population and development of economic activities in the region are supposed to continue in the future although the region is already highly industrialized and densely populated as a whole.
- (ii). The existing water resources systems could not satisfy the growing water demands resulting from the population growth and economic development. However, the possibility of constructing new dams or canals is restricted in the region. Therefore other water utilization systems should be developed.
- (iii). The existing system of waste water treatment must be expanded in order to meet increasing pollution loads. Moreover the primary and secondary treatment will be insufficient to prevent the deterioration of water quality of the rivers of the reservoirs. Therefore construction of plants for tertiary treatment of waste water should be taken into account in the future water quality management.

The objective of our study is to construct a system model in order to obtain comprehensive water resources management strategies in a river basin with the features stated above. The model is a linear one and the linear programming approach is adopted to decide possible strategies. The linear programming model (LP model) is used primarily because it is the most easily accessible one. More refined optimization techniques might be possible; such techniques, however, are significant only when solid systems models are available. But such large-scaled and complex systems as water resources ones include inevitably various kinds of uncertainties in systems structure, in input data and in parameter values. Although the LP model is very simplified it is compatible with our knowledge of the real systems and available data. And the model can provide us with valuable information for further detailed studies of the problems.

The general model is applied to the region of our concern, that is, to the Yodo river basin in Japan. In this report, first the problems and the assumptions on modeling are stated, then the mathematical formulation of the system is presented. The last part of the report is devoted to illustrations with some numerical examples.

## 2. THE PROBLEM

Let us suppose that the objective basin is divided into  $M$  subregions from the topographical point of view and that the given planning horizon is divided into  $N$  stages. In order to



to state the problem definitely some assumptions must be made. The basic assumptions are as follows:

- (i). The amount of water demands and that of pollution loads are estimated in each subregion during the planning horizon.
- (ii). New water resources must be developed in order to meet the increasing water demands. However, the amount of water which can be developed by the construction of new reservoirs is so restricted that highly treated water must be reused for industry.
- (iii). Not only the primary and the secondary treatment of waste water but also tertiary treatment is realizable technologically at every planning stage. And the tertiary treatment is distinguished from the secondary one by its higher removal rate of pollutants, which are represented by BOD.
- (iv). The industrial and municipal water that is used in a subregion is discharged into the same subregion through treatment plants or directly. The construction of canals that connect two subregions is not considered.
- (v). The daily and monthly perturbations of flow rates and water quality of rivers do not concern us. The averaged 275-day flow rate of a reach (the real flow rate is greater than this value at points during the 275 days) is assumed to be constant during the whole planning period. In other words we assume that the river flow is time-invariant with respect to the 275-day flow rate.

Under these fundamental assumptions the problem of water resources management can be stated as: determine the water quantity to be developed and the amount of BOD to be treated by primary and secondary treatment plants or tertiary ones at the  $i$ th planning stage in the  $j$ th subregion ( $i=1, \dots, N$ ;  $j=1, \dots, M$ ) so that they meet water demands and water quality constraints and that they minimize costs of constructing new facilities and operating them.

Flows of water in each subregion are shown in Figure 1.

### 3. MATHEMATICAL FORMULATIONS

#### 3.1. Notation

The subscripts  $i$  and  $j$  of the following constants or variables denote the  $i$ th planning stage or the  $j$ th subregion, respectively.

##### *Given Data*

$W_{ij}^D$  — municipal water demand ( $m^3$ /day) at the end of the  $i$ th stage and in the  $j$ th region

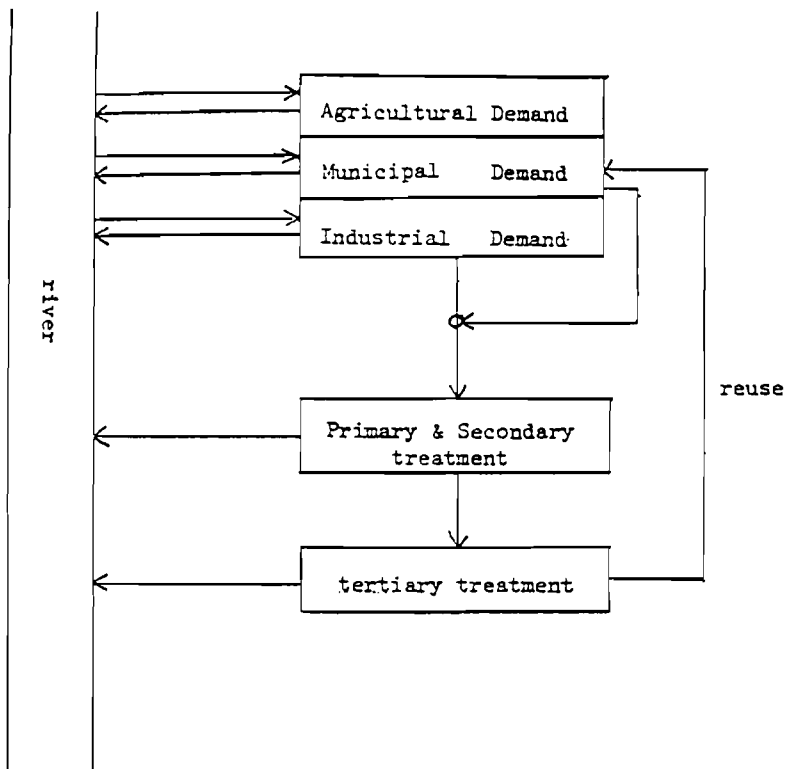

Figure 1. Flow diagram in a subregion.

- $W_{ij}^A$  — agricultural water demand ( $m^3/day$ )  
 $W_{ij}^I$  — industrial water demand ( $m^3/day$ )  
 $W_{ij}^{DA} = W_{ij}^D + W_{ij}^A$   
 $W_{ij}^{DI} = W_{ij}^D + W_{ij}^I$   
 $W_{ij}$  — total water demand ( $m^3/day$ ) ( $W_{ij}^D + W_{ij}^A + W_{ij}^I$ )  
 $B_{ij}$  — total amount of BOD in municipal and industrial waste water (ton/day)  
 $Q_{ij}$  — flow rate of river ( $m^3/sec$ )  
 $V_{ij}$  — volume of river water corresponding to  $Q_{ij}$  ( $m^3$ )  
 $W_{0j}^D, W_{0j}^A, W_{0j}^I, W_{0j}^{DA}, W_{0j}^{DI}$  and  $W_{0j}$  — the values of the corresponding water demand at the beginning of the project  
 $Q_{0j}$  — flow rate of  $j$ th reach which is the averaged value of those preceding years (cm/sec)  
 $X_{0j}$  — amount of surplus water at the initial year of the project ( $m^3/day$ )  
 $\bar{K}_j^I$  — upper bound of water quantity that can be developed ( $m^3/day$ )  
 $\bar{B}_{ij}$  — upper bound of admissible BOD concentration (ppm)  
 $R_{0j}$  — initial value of treatment ratio  
 $\bar{R}_j$  — upper bound of increment of treatment ratio

*Variables*

- $X_{ij}^1$  — amount of water that should be developed in the  $i$ th stage of the  $j$ th region ( $m^3/day$ )  
 $X_{ij}^2$  — amount of water that should be processed by secondary treatment plants ( $m^3/day$ )  
 $X_{ij}^3$  — amount of water that should be processed by tertiary treatment plants ( $m^3/day$ )  
 $B_{ij}^E$  — amount of BOD effluent to river (ton/day)  
 $R_{ij}$  — ratio of treated waste water to total

$Z_{ij}$  — BOD concentration of river water (ppm)

Constants

$\beta_2$  — removal ratio of BOD by primary and secondary waste water treatment

$\beta_3$  — removal ratio by tertiary treatment

$\alpha_j$  — coefficient of self-purification of pollutants.

We assume that the whole basin is divided into subregions so that only one tributary or one reach of the main river is in each subregion. For simplicity the tributary or the reach in the  $k$ th region is called the  $k$ th reach of the main river. When the  $k$ th reach is one of the upper reaches or the upper tributaries of the  $l$ th one then we write  $k \gg l$  (or  $k \gg l$  for  $k \gg l$  or  $k = l$ ).

### 3.2. Water Demand Constraints

The municipal and agricultural water demands in a subregion must be satisfied by the construction of dams in the upper regions. Therefore

$$\sum_{k \gg j} (W_{ik}^{DA} - W_{ok}^{DA}) \leq \sum_{l=1}^i \sum_{k \gg j} (X_{lk}^1 + X_{ok}^1) \quad (1)$$

( $i=1, \dots, N, j=1, \dots, M$ )

where the left-hand side represents the water demands in the  $j$ th and its upper region and the right-hand side represents the available water quantity in the same regions at the  $i$ th planning stage. Since we assume that the industrial water can be supplied by tertiary treatment plants, the following constraints must be satisfied with respect to the total water demand:

$$\sum_{k \gg j} (W_{jk} - W_{ok}) \leq \sum_{l=1}^i \sum_{k \gg j} (X_{lk}^1 + X_{lk}^3 + X_{ok}^1) \quad (2)$$

( $i=1, \dots, N, j=1, \dots, M$ )

### 3.3. Water Quality Constraints

From the mass balance relation of BOD in a reach we have

$$Z_{ij} V_{ij} \alpha_j + Z_{ij} Q_{ij} = \bar{\theta}_{ij}^E + \bar{\theta}_{ij}$$

( $i=1, \dots, N, j=1, \dots, M$ )

where  $\bar{\theta}_{ij}$  denotes the amount of BOD flowing into the  $j$ th reach from the upper reaches. The left-hand side represents BOD that

flows out of the  $j$ th reach and that eliminated because of the self-purification effect in the reach. From assumption (v) in section 2 we have that the flow rates  $Q_{ij}$  do not depend on  $i$ , hence

$$Z_{ij} \gamma_{ij} x_j + Z_{ij} Q_{0j} = \beta_{ij} + \bar{\beta}_{ij} \quad (3)$$

$(i=1, \dots, N, j=1, \dots, M)$

$\bar{\beta}_{ij}$  can be calculated from the preceding relations in (3) when the water quality of the origins of the tributaries are given. The amount of BOD effluent into the  $j$ th reach is expressed as follows:

$$\beta_{ij}^E = \beta_{ij} \left[ 1 - (1/W_{ij}^{DI}) (\beta_2 X_{ij}^2 + \beta_3 X_{ij}^3) \right] \quad (4)$$

The water quality calculated from equations (3) and (4) must satisfy the water quality standards

$$Z_{ij} \leq \bar{Z}_{ij} \quad (i=1, \dots, N, j=1, \dots, M) \quad (5)$$

The inequalities (5) are linear constraints with respect to  $X_{ij}^2$  and  $X_{ij}^3$ .

#### 3.4. Other Constraints

The water quantity that can be developed by the construction of reservoirs is bounded

$$0 \leq X_{ij}^1 \leq \bar{X}_{ij}^1 \quad (i=1, \dots, N, j=1, \dots, M) \quad (6)$$

All the other variables must be nonnegative, i.e.,

$$X_{ij}^2 \geq 0, \quad X_{ij}^3 \geq 0, \quad \beta_{ij}^E \geq 0, \quad Z_{ij} \geq 0 \quad (7)$$

$(i=1, \dots, N, j=1, \dots, M)$

The treatment ratio of waste water represents the covering rate of sewerage systems:

$$R_{ij} = (1/W_{ij}^{DI}) (X_{ij}^2 + X_{ij}^3) \quad (8)$$

The increment of this ratio in one planning stage is bounded because of budgetary constraints:

$$0 \leq R_{ij} - R_{i-1,j} \leq \bar{R}_{ij} \quad (i=1, \dots, N, j=1, \dots, M) \quad (9)$$

#### 3.5. Objective Functions

The objective function is the total sum of the cost to construct dams and waste treatment plants, the cost of expanding public sewerage systems, and the operating costs of treatment plants. Therefore

$$\begin{aligned}
 J = & \sum_{i=1}^N \sum_{j=1}^M \left[ C_{ij}^1 X_{ij}^1 + C_{ij}^2 (R_{ij} - R_{i-1,j}) \right. \\
 & + C_{ij}^3 (X_{ij}^2 - X_{i-1,j}^2) + C_{ij}^4 (X_{ij}^3 - X_{i-1,j}^3) \\
 & \left. + C_{ij}^5 X_{ij}^2 + C_{ij}^6 X_{ij}^3 \right] \quad (10)
 \end{aligned}$$

Since  $R_{ij} = (1/W_{ij}^{DI})(W_{ij}^2 + X_{ij}^3)$ , the function is linear in the variables  $X_{ij}^1$ ,  $X_{ij}^2$  and  $X_{ij}^3$ , that is

$$J = \sum_{i,j,k} A_{ij}^k X_{ij}^k \quad (i=1, \dots, N, j=1, \dots, M, k=1, 2, 3) \quad (11)$$

where  $A_{ij}^1$  is the cost of developing unit volume of fresh water by constructing dams,  $A_{ij}^2$  is the secondary treatment cost per unit volume of waste water, which includes the cost of constructing plants and expanding sewerage systems, and  $A_{ij}^3$  is the tertiary treatment cost including the cost of constructing plants and of expanding sewerage systems.

### 3.6. Summary

#### Water Demand Constraints

$$\begin{aligned}
 \sum_{\lambda=1}^i \sum_{k > j} X_{\lambda k}^1 & \geq \sum_{k > j} (\bar{w}_{ij}^{DA} - \bar{w}_{0k}^{DA}) - \sum_{\lambda=1}^i \sum_{k > j} X_{\lambda k}^2 \\
 \sum_{\lambda=1}^i \sum_{k > j} (X_{\lambda k}^1 + X_{\lambda k}^3) & \geq \sum_{k > j} (\bar{w}_{ij} - \bar{w}_{0k}) \\
 - \sum_{\lambda=1}^i \sum_{k > j} (X_{\lambda k}^2) & \quad (12)
 \end{aligned}$$

#### Water Quality Constraints

$$Z_{ij} (V_{ij} \alpha_j + \alpha_{0j}) = \beta_{ij} + \bar{\beta}_{ij} \quad (13)$$

$$0 \leq \beta_{ij} = \beta_{ij} \left[ 1 - (1/W_{ij}^{DI})(\beta_2 X_{ij}^2 + \beta_3 X_{ij}^3) \right] \quad (14)$$

$$0 \leq Z_{ij} \leq \bar{\beta}_{ij}$$

*Other Constraints*

$$0 \leq X_{ij}^1 \leq \bar{X}_{ij}^1 \quad (15)$$

$$X_{ij}^2 \geq 0 \quad (16)$$

$$X_{ij}^3 \geq 0 \quad (17)$$

$$R_{ij} = (1/W_{ij}^{DI}) (X_{ij}^2 + X_{ij}^3) \quad (18)$$

$$0 \leq R_{ij} - R_{i-1,j} \leq \bar{R}_{ij} \quad (19)$$

*Objective Function*

$$J = \sum_{i,j,k} A_{ij}^k X_{ij}^k \quad \begin{matrix} (i=1, \dots, V, j=1, \dots, M \\ k=1, 2, 3) \end{matrix} \quad (20)$$

## 4. APPLICATION TO THE YODO RIVER BASIN

Let us apply the general model described in the preceding sections to the Yodo river basin; one of the most highly urbanized regions of Japan.

## 4.1. Assumptions

(i). The whole region is divided into the following five subregions (Figure 2);

1. The lower reaches of the Katsura river and the Kamo river
2. The Uji river
3. The lower reaches of the Kizu river
4. The upper reaches of the Yodo river
5. The lower reaches of the Yodo river

(ii). The planning horizon is 20 years from 1973 to 1993. One planning stage is five years, so that the whole period is made up of four stages.

(iii). The development of water resources by dams is possible only in the upper reaches of reach 1, 2 and 3.  $X_j^1$  ( $j = 1, 2, 3$ ) denote the possible amounts of water that could be developed in the respective upper reaches.  $X_j^1$  ( $j = 4, 5$ ) are equal to zero.

(iv). The water quality of rivers that flow into reach 1, 2 and 3 is considered to be constant during the planning horizon.

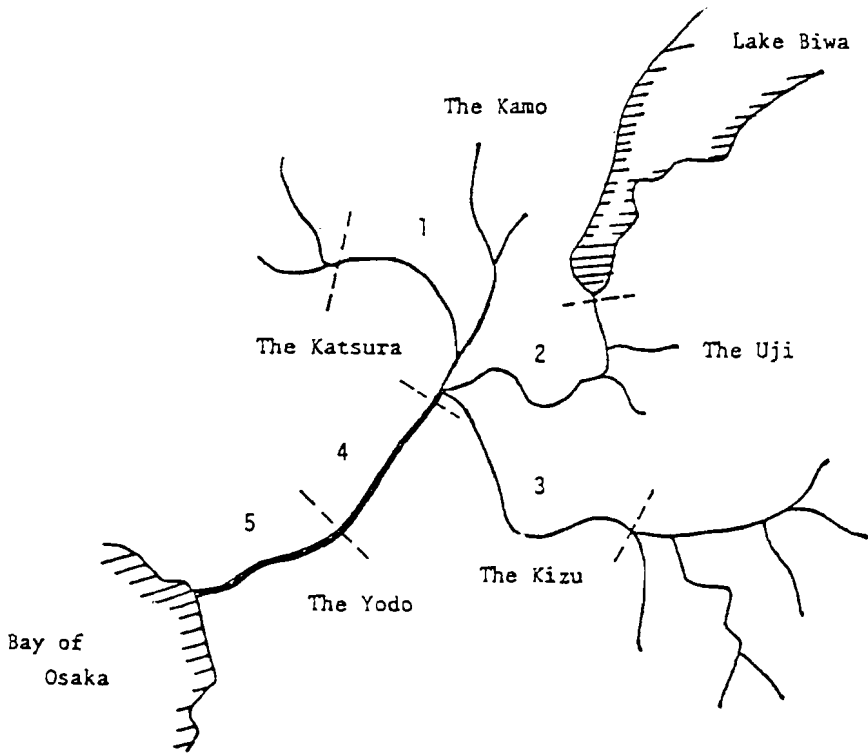

Figure 2. Division of the Yodo river basin.



## 4.2. Estimates of Water Demand

### 4.2.1. Municipal Water Demand

Municipal water demand in the  $j$ th region at the  $i$ th planning step is estimated as follows:

$$W_{ij}^D = (i a_j + b_j) P_{ij} \quad (i=1, \dots, 4, j=1, \dots, 5) \quad (21)$$

where  $P_{ij}$  is the population of the  $j$ th region at the last year of the  $i$ th stage, and  $a_j$  and  $b_j$  are constants which are identified by the trends of the preceding years (Figure 3). The population growth is evaluated from general trends in each subregion (Figure 4). The estimated demands are shown in Table 1.

### 4.2.2. Industrial Water Demand

The industrial water demand in each subregion is estimated from the trends in preceding years as shown in Table 2.

### 4.2.3. Agricultural Water Demand

The agricultural area in the basin is decreasing every year. This tendency is assumed to continue through the planning horizon. The estimated water demands are shown in Table 3 where the decrease of agricultural area is assumed to be 10 percent per five year period.

## 4.3. Estimates of Pollution Loads

The method of generation factors [1] is used in order to estimate BOD generated in a region. In other words, the amount of BOD is assumed to be proportional to the population and quantity of industrial products in the region. BOD discharged from agricultural or forest area is not taken into account since its perturbation can be considered to be small.

## 4.4. An Example of Numerical Results

The values of some important parameters used in the calculation are summarized in Table 4. The coefficients used for the objective function are given in Table 5. In this case the tertiary treatment of waste water is necessary in the last planning stage in the third region. The treatment ratios  $R_{ij}$  of each region are shown in Table 6.

## REFERENCE

- [1] Ikeda, S., et al. (1976) A simulation model of water quality in the Kinki region linked with an Integrated Regional Planning Model, in A Computer Assisted Approach to Regional Development, edited by H. Knop. CP-76-10. Laxenburg, Austria: International Institute for Applied Systems Analysis.

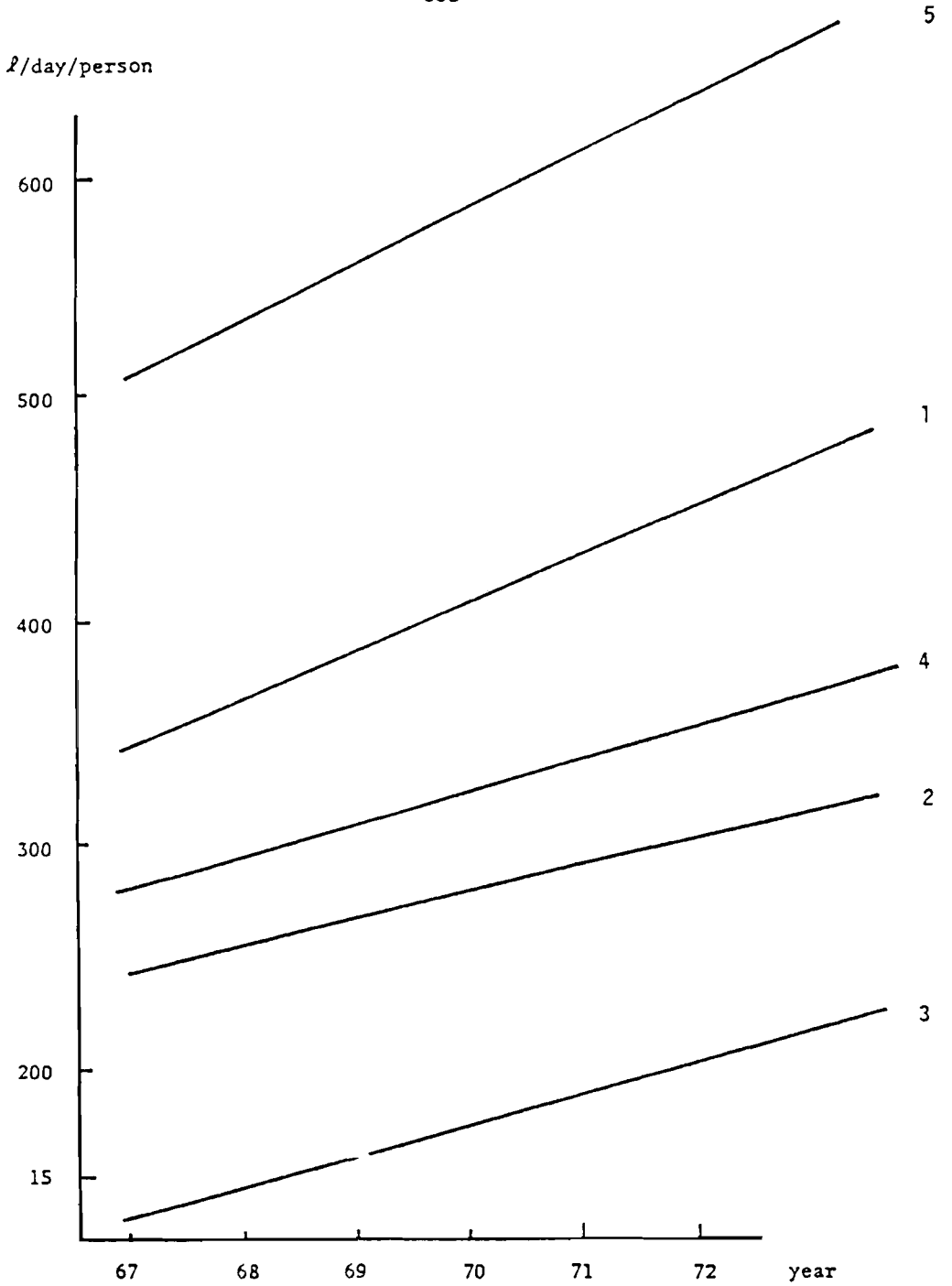

Figure 3. Increase of municipal water consumption in each region.

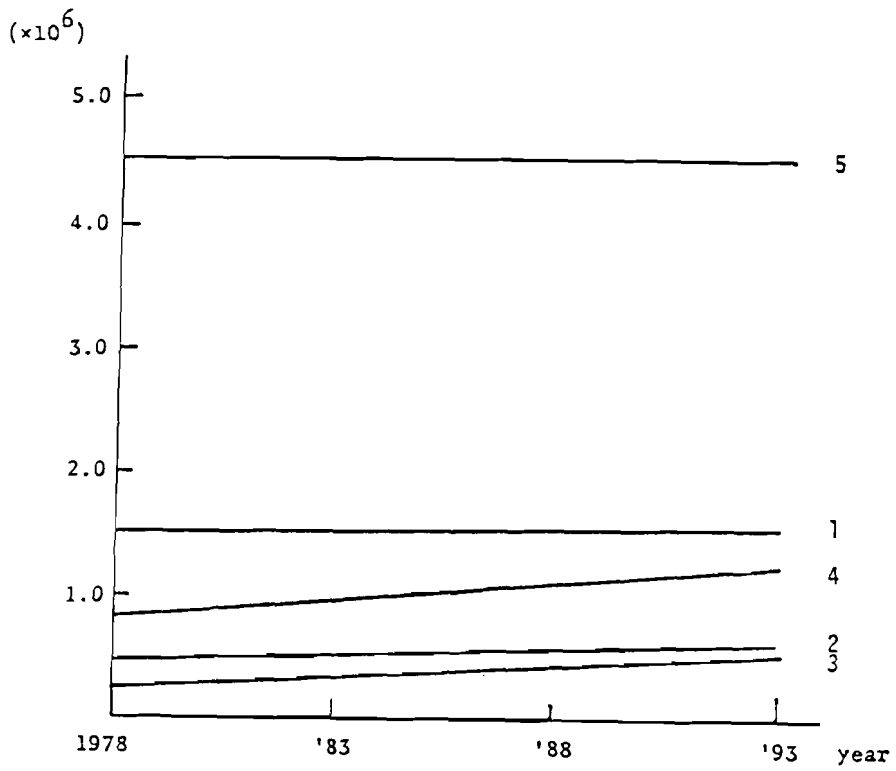

Figure 4. Population increase.

Table 1. Increase of municipal water demand ( $\times 10^3$  m<sup>3</sup>/day).

Region	1978	1983	1988	1993
1	822.0	996.0	1171.0	1347.0
2	145.0	240.0	300.0	361.0
3	71.0	116.0	172.0	240.0
4	338.0	469.0	621.0	762.0
5	348.6	403.0	4616.0	5200.0

Table 2. Increase of industrial water demand ( $\times 10^3$  m<sup>3</sup>/day).

Region	1978	1983	1988	1993
1	490.0	550.0	620.0	700.0
2	150.0	165.0	180.0	200.0
3	65.0	90.0	120.0	150.0
4	800.0	1100.0	1500.0	2000.0
5	7000.0	8000.0	9000.0	9500.0

Table 3. Agricultural water demand ( $\times 10^3$  m<sup>3</sup>/day).

Region	1978	1983	1988	1993
1	1103.3	993.0	893.7	804.3
2	257.7	231.9	208.7	187.9
3	479.9	431.9	388.7	349.8
4	1165.4	1048.9	944.0	849.6
5	126.4	113.8	102.4	92.2

Table 4. Values of parameters.

Region ( <i>j</i> )	1	2	3	4	5
$X_{0j}$ ( $\times 10^3$ )	100.0	100.0	200.0	500.0	0.0
$\bar{X}_j^1$ ( $\times 10^3$ )	500.0	4000.0	500.0	0.0	0.0
$\bar{Z}_{ij}$	8.0	3.0	2.0	3.0	8.0
$R_{0j}$	0.1	0.3	0.1	0.5	0.9

$$\alpha_{ij} = 0.5, \beta_2 = 0.85, \beta_3 = 0.95, R_j = 0.5.$$

Table 5. Coefficients of the objective function.

<i>i</i>	$A_{i1}^1$	$A_{i2}^1$	$A_{i3}^1$	$A_{ij}^1$	$A_{ij}^3$
1	2.5	2.4	2.6	1.3	7.0
2	2.3	2.2	2.4	1.2	6.6
3	2.0	1.9	2.1	1.1	6.2
4	1.9	1.8	2.0	1.0	6.0

Table 6. Treatment ratio ( $R_{ij}$ ) in each region (%).

Region	1978	1983	1988	1993
1	94.4	100.0	100.0	100.0
2	49.8	100.0	100.0	100.0
3	10.0	58.5	100.0	100.0
4	50.4	64.0	80.0	93.4
5	90.0	90.0	90.0	90.0

## SUMMARY OF THE DISCUSSION

J. Kacprzyk

The discussion on land use and infrastructural planning models focused on the relation between the transition of the Japanese society to a service society and the level of investments required. Some possible impacts of a lower investment requirement in a service society were mentioned. Moreover, there were some definitional questions raised as to the partitioning of economic activities into sectors.

As to models of social evaluation, the discussion concentrated on the social indicators reflecting the well being of people. In this setting, the problem of relations between the situation perception by inhabitants and by politicians or influence groups should be studied, since no satisfactory solution is attainable otherwise. Moreover, it was indicated that value assessment by people is probably a learning process.

Owing to the particular importance of water problems for the Kinki region and their integrating power, they drew special attention.

First, the problems of modeling and forecasting water demand are of particular interest. The prices for water influence to a large extent not only water demand but also some structural changes, because it may be sometimes economically more reasonable to apply a new water-saving technology than more water treatment. The efficiency of water use should be, however, more strictly defined.

The relations and mutual dependences between the water demand and governmental policies were the next topic of discussion. Moreover, the water demand problem was seen as strongly connected with the water quality problem. One of the important issues in water-demand modeling and forecasting should be taking into account existing uncertainties.

For an adequate and meaningful analysis of the problem considered, one should go down to the level of individual water-use activities, e.g., a single industrial plant, farm, or household. Such an approach is also reasonable because water demand is strongly coupled with the energy demand; in general, if water demand decreases, energy demand increases. The analysis of this trade-off at the regional level will probably be too complicated, so a lower individual user level is preferable.

The discussion also covered problems concerning the way of fitting detailed water-demand models into an integrated regional model and of how to use this detailed information in a global policy.

It was stressed that due attention should also be paid to water-supply and water-resources-management problems. Emerging conflict is one of the important issues arising in water utilization. For handling it, game theory provides an adequate tool. One should, however, pay attention to proper identification of coalition structures, cost allocation, stability of marginal costs for water, etc.

The discussion showed also that the use of utility functions for solving some water problems is commendable. The advantages of interactive approaches were also stressed.





Part VI

METHODS

A MULTIOBJECTIVE MATHEMATICAL PROGRAMMING METHOD  
APPLIED TO SOCIAL PLANNING PROBLEMS

Y. Nishikawa, N. Sannomiya, A. Udo, and T. Takehara  
*Department of Electrical Engineering, Kyoto University,  
Kyoto, Japan*

ABSTRACT

The first part of the paper discusses a general concept and the authors' fundamental attitude toward regional land-use planning and its methodological foundation.

The second part develops an interactive method for multi-objective decision making and optimization starting with a model of the linear programming type. The linear programming model includes only one objective to be minimized (or maximized) and several constraint inequalities. Among these constraints, some could be altered to some extent by the planner's intention, so they are called the soft constraints. Relaxing the soft constraints usually results in improving the objective value; then it generates a kind of trade-off. In our method we start with an objective model, instead of setting multiobjectives at the outset, and try to find a point of satisfactory compromise between attaining the objective and the requirement of satisfying the constraints. This avoids unnecessary conceptual and computational complexity. The algorithm for decision making uses the idea of surrogate worth trade-off.

The third part applies the method to two real examples. The first example is concerned with optimum land-use planning in a rural region of Japan. The second example develops a macro-regional model designed to simulate the effect of social policy making and public preference under some socioeconomic constraints.

## 1. INTRODUCTION

Basic tasks in applying a systems approach to a regional planning problem are, first, to clarify an actual structure of the region under consideration, second, to identify goals and objectives of the regional development, and third, to construct a mathematical model suitable for problem investigation.

A goal structure should reflect various aspects of the regional requirements including economical growth, industrialization, agricultural development, environmental enhancement, and so forth. Such a goal structure could finally be summarized and reflected by the physical status of land use within the region. In a whole view of regional planning, the planning of the above mentioned goal structure would be called "nonphysical planning," which implies in a wide sense the social and economical planning in the associated region. If we think about the actual situation of urban or rural regional planning in Japan, the development of new systems methodologies for the nonphysical planning is badly needed.

This paper tries to respond to such a need by proposing a method for multiobjective planning. An extension of the mathematical programming concept is investigated. Since, among various mathematical programmings, linear programming is most widely used, the present discussion gives it special regard.

The paper consists of three parts. The first part discusses a general concept and the authors' fundamental attitude toward regional land-use planning and its methodological foundation.

The second part develops an iterative procedure for a coupled model modification and preference search. Our procedure starts with a conventional linear programming model consisting of a single objective and several constraints. The constraints in the model can usually be classified into two groups, i.e., hard (not relaxable) constraints and soft (relaxable) constraints. A hard constraint is rigidly fixed by physical or other reasons, so that it cannot be altered by human intention. A soft constraint is set according to human intention; hence it can be strengthened or relaxed to some extent. The relaxation of soft constraints usually yields a better objective value, and consequently allows a kind of trade-off.

In the proposed method we start with a one-objective linear programming model instead of setting multiobjectives at the outset, and, in the succeeding procedure, try to find a preferred point of compromise between the attainment of the original objective and requirements of the soft constraints. This is advantageous in the sense that it can avoid unnecessary conceptual and computational complexity. The algorithm of the iterative search for the preferred point utilizes the idea of the surrogate worth trade-off method [1].

In order to demonstrate the practicability of our method, we have given in the third part, an example of application to

optimum land-use planning in a real rural region in Japan. This experimental use has been successful and has yielded significant suggestions for the rational agricultural planning of the region.

The method is also applied to a macroregional model which is developed to simulate the effect of administrative strategy and public preference under some socioeconomic constraints. Our method proves to be a flexible tool to support social decision making.

## 2. METHODOLOGICAL SIGNIFICANCE OF A MULTIOBJECTIVE APPROACH TO LAND-USE PLANNING

A meaningful systems methodology, which is sound in theory and in practice as well, would be generated only through attempts to apply it to a variety of real world problems. This statement is especially true in the systems approach to societal systems, because our society is much more complicated both in its structure and in its goal than almost any other system (such as an engineering production system or an industrial management system). As the regional land-use status summarizes and reflects all the social needs and activities of people concerned with the region, regional land-use planning is a typical societal planning problem. Human activity within the region is subject to certain limits of various natural resources existing in the region. It is needless to say that land is one of the most important natural resources, which is heavily characterized by its time history and limit in space. Under these limitations, the principal aim of regional planning is to create or recreate a favorable balance between human activity and the use of natural resources.

In mathematical terms, the limitation and balance rule of human existence could be described as follows:

$$Ax - b \leq 0$$

where  $x$  is a vector whose components show levels of various human activities, and  $b$  is a vector whose components indicate usable amounts of resources within the region. Elements of the matrix  $A$  represent demands for resources per unit of human activity.

If we pick out a particular kind of resource, say the one associated with the first row of  $A$ , we want to minimize its consumption under limitations of the other resources, the problem will be reformulated into

$$\min_x b_1 = a_1 x$$

subject to

$$\tilde{A}x - \tilde{b} \leq 0$$

where  $b_1$  denotes the first member of  $b$  and  $a_1$  denotes the first row of vector  $A$ . The inequality above describes the limitation and balance rule for resources other than the first one. The

above model is of a common linear program type with objective  $b_1$  and with the inequality forming the constraint [2]. It is to be noted that the value of the objective  $b_1$  is not prescribed but is subject to change, because it is determined by optimization subject to the constraint.

If we pick out more than one kind of resource for minimization, a model will be of the multiobjective linear program type. Most of real regional planning problems, if they fit the reality, would be formulated into this type of model. A difficulty arises in multiobjective programs: attaining a well balanced optimization among noncommensurable goals. Balanced optimization of the objectives can be attained, if we look back to  $Ax - b \leq 0$ , by a good choice of values of components of  $b$ , which might be altered by human intention. Furthermore, the components which make the constraints active need to be considered as is suggested by the equality symbol in  $\min_x b_1 = a_1 x$ .

This discussion gives us a conceptual base for the following mathematical development.

### 3. PROBLEM STATEMENT

Throughout the paper, we use the following notation: for vectors  $x$  and  $y$  in  $R^n$ .

$$x \geq y \iff x_i \geq y_i \quad \text{for } i = 1, 2, \dots, n$$

$$x \geq y \iff x \geq j \text{ and } x \neq y$$

A prime denotes transposition of a vector or a matrix. If  $a, b \in R$  and  $a < b$ , then

$$[a, b] \triangleq \{r \mid a \leq r \leq b\}$$

$$(a, b) \triangleq \{r \mid a < r < b\}$$

$$[a, b) \triangleq \{r \mid a \leq r < b\}$$

Consider the following linear programming problem:

$$(P1) \quad \min c'x$$

subject to

$$Ax - b \leq 0, \quad x \geq 0 \quad (1)$$

$$Bx - \beta \leq 0 \quad (2)$$

where  $x$  and  $c$  are  $n$  vectors,  $b$  an  $l$  vector, and  $\beta$  an  $M$  vector.  $A$  and  $B$  are  $l \times n$  and  $M \times n$  matrices, respectively.

The constraint in (1) is a hard constraint, that is, a constraint that cannot be changed by the planner's intention. We assume that the constraint set (1) has a feasible region. On the other hand, every constraint in (2) is a soft constraint, that is, a constraint that could be relaxed, to some extent, by the planner. The value of  $\beta$  in the soft constraint set is ideally wanted to be equal to  $\beta^*$ . But it is assumed that if  $\beta = \beta^*$  constraints (1) and (2) are inconsistent and the problem (P1) has no solution. Then the problem is how to choose a value of  $\beta$  making a satisfactory compromise between the attainment of the objective,  $\min c'x$ , and the requirement of the constraints.

#### 4. A PROCEDURE FOR FINDING A SET OF INCONSISTENT SOFT CONSTRAINTS

##### 4.1. Definition of a Bicriterion Minimization Problem

When the number of soft constraints is too large, i.e.,  $M \gg 1$ , it is generally a difficult task to find the inconsistent components of the constraint set (1) and (2). In order to overcome this difficulty, we define the following optimization problem with two objectives:

$$(P2) \quad \min_{x, \beta} \begin{bmatrix} z(x, \beta) \\ F(\beta) \end{bmatrix}$$

subject to (1) and (2) where

$$z(x, \beta) \triangleq c'x \quad (3)$$

$$F(\beta) \triangleq \frac{1}{M} \sum_{j=1}^M f_j(\beta_j) \quad (4)$$

$$f_j(\beta_j) \triangleq (|\beta_j - \beta_j^*| / |\beta_j^*|)^2 \quad \rho \geq 1 \quad (5)$$

The function  $F$  defined by (4) and (5) is the measure of total relaxation of  $\beta$ . This is of the same form as the regret function introduction by Yu et al. [3]. We utilize this function in order to pick out the components of  $\beta$  that must be relaxed to obtain consistency of the constraint set.

The function  $F$  with  $\rho = 1$  represents the simple average of the relaxation quantity of each component  $\beta_j$ . However, as the parameter  $\rho$  increases, much importance is attached to the individual constraint component which deviates significantly from  $\beta_j^*$ . In (5),  $f_j$  is normalized in such a way that each relaxation of  $\beta_j$  is equally weighted (if  $\beta_j^* = 0$ , an appropriate value replaces  $\beta_j^*$ ). When the relative importance among the soft constraints is known a priori,  $f_j$  will be multiplied by the weighting factor reflecting its importance.

## 4.2. Noninferior Solution of (P2)

We will now obtain the noninferior solution of the bicriterion problem (P2). From the problem statement, the value of the soft constraint must satisfy  $\beta \geq \beta^*$ . This is satisfied by the noninferior solution of (P2).

4.2.1. *Theorem 1:* The noninferior solution  $(\tilde{x}, \tilde{\beta})$  of (P2) satisfies  $\tilde{\beta} \geq \beta^*$

*Proof*

We prove by contradiction. First, if  $\tilde{\beta} \leq \beta^*$ , the constraints (1) and (2) with  $\beta = \tilde{\beta}$  are inconsistent; hence  $(\tilde{x}, \tilde{\beta})$  is not a solution of (P2). Second, we assume that  $\tilde{\beta}_i < \beta_i^*$  for some  $i$  and define

$$\bar{\beta} \triangleq (\bar{\beta}_1, \dots, \bar{\beta}_{i-1}, \beta_i^*, \bar{\beta}_{i+1}, \dots, \bar{\beta}_M) \quad (6)$$

Since the feasible region of  $x$  given by (1) and (2) with  $\beta = \bar{\beta}$  includes that with  $\beta = \tilde{\beta}$ , the following relation is obtained:

$$\begin{aligned} z(\tilde{x}, \tilde{\beta}) &\geq z(\bar{x}, \bar{\beta}) \\ F(\tilde{\beta}) &> F(\bar{\beta}) \end{aligned} \quad (7)$$

where  $\bar{x}$  is a solution of (P1) with  $\beta = \bar{\beta}$ . This shows that  $(\tilde{x}, \tilde{\beta})$  is inferior to  $(\bar{x}, \bar{\beta})$ ; therefore  $(\tilde{x}, \tilde{\beta})$  is not a noninferior solution of (P2).

Q.E.D.

The noninferior solution of (P2) is obtained by solving the problem:

$$\min_{x, \beta} [\theta F(\beta) + (1 - \theta) z(x, \beta)]$$

subject to (1) and (2) where  $\theta$  is a parameter ranging over the unit interval  $[0, 1]$ . The optimal solution of (P3) for a fixed value of  $\theta$  is denoted by  $[x(\theta), \beta(\theta)]$ . For simplicity, the following notation is introduced:

$$F(\theta) \triangleq F[\beta(\theta)]$$

$$F_j(\theta) \triangleq F_j[\beta_j(\theta)]$$

$$z(\theta) \triangleq z[x(\theta), \beta(\theta)]$$

The objective functions and the constraint set of (P2) are both convex. Accordingly, a direct application of Geoffrion's theorem [4] leads to the following theorem which gives the relationship between the noninferior solution of (P2) and the optimal solution of (P3).

## 4.2.2. Theorem 2: Geoffrion

- (i)  $F(\theta)$  is monotonically nonincreasing on  $[0, 1]$  and  $z(\theta)$  is monotonically nondecreasing on  $[0, 1]$ .
- (ii) Any solution  $[x(\theta), \beta(\theta)]$  of (P3) is noninferior when  $\theta \in (0, 1)$ .
- (iii) Denote the set of solutions of (P3) for  $\theta = 0$  by  $\{[x(0), \beta(0)]\}$  and define

$$x(0+) \triangleq \lim_{\theta \rightarrow 0+} x(\theta), \quad \beta(0+) \triangleq \lim_{\theta \rightarrow 0+} \beta(\theta) \quad (8)$$

Then  $[x(0+), \beta(0+)]$  is in  $\{[x(0), \beta(0)]\}$  and is noninferior.

- (iv) Denote the set of solutions of (P3) for  $\theta = 1$  by  $\{[x(1), \beta(1)]\}$  and define

$$x(1-) \triangleq \lim_{\theta \rightarrow 1-} x(\theta), \quad \beta(1-) \triangleq \lim_{\theta \rightarrow 1-} \beta(\theta) \quad (9)$$

Then  $[x(1-), \beta(1-)]$  is in  $\{[x(1), \beta(1)]\}$  and is noninferior.

It is observed from theorem 2(iv) that  $[x(1-), \beta(1-)]$  is the noninferior solution of (P2) when maximum consideration is given to the relaxation quantity of  $\beta$  relative to the value of  $z$ . By theorem 1, we have  $\beta(1-) > \beta^*$ . Consequently, a component  $j$  for which  $\beta_j(1-) > \beta_j^*$  [or equivalently  $r_j(1-) > 0$ ] has turned out to be the component of the constraint (2) that makes the problem (P1) infeasible. The value of  $\beta_j(1-)$  gives the lower bound of  $\beta_j$  for getting the feasibility.

Furthermore, by solving (P3) as  $\theta$  varies over  $(0, 1)$ , we can find conflicting components among the inconsistent constraints, that is, components such that no decrease can be obtained in the set values of the constraints without causing a simultaneous increase in at least one of the other set values. For this, we investigate the variation of  $\beta(\theta)$  as  $\theta \rightarrow 1-$ , and classify the components of the soft constraint as follows

$$\begin{aligned} \mathcal{J} &\triangleq \{j \mid r_j(\theta) > 0 \text{ for some } \theta \in (\hat{\theta}, 1), j \in (1, 2, \dots, M)\} \\ \mathcal{J}^+ &\triangleq \{j \mid r_j(\hat{\theta}) < r_j(1-), j \in \mathcal{J}\} \\ \mathcal{J}^- &\triangleq \{j \mid r_j(\hat{\theta}) \geq r_j(1-), j \in \mathcal{J}\} \end{aligned} \quad (10)$$

where  $\theta \in (0, 1)$  is a number chosen appropriately.

By theorem 1, the set  $\mathcal{J}$  is not empty. Further the set  $\mathcal{J}^-$  is not empty either. For, if  $\mathcal{J}^-$  is empty, then



$$F(\hat{\theta}) = \sum_{j \in J^+} f_j(\hat{\theta}) < \sum_{j \in J^+} f_j(1-) = F(1-) \quad (11)$$

which contradicts theorem 2(i). As for the set  $J^+$ , the following theorem is established.

4.2.3. *Theorem 3: If  $J^+$  is not empty, there exists at least a pair of conflicting components, i.e.,  $j_1 \in J^+$  and  $j_2 \in J^-$  such that  $\beta_{j_1}$  and  $\beta_{j_2}$  cannot decrease simultaneously.*

*Proof*

The point  $\beta(1-)$  lies on the boundary of the feasible region in the  $\beta$  space<sup>†</sup>. However, the point  $\hat{\beta}$  defined by

$$\hat{\beta}_j \triangleq \begin{cases} \beta_j(\hat{\theta}) & j \in J^+ \\ \beta_j(1-) & j \notin J^+ \end{cases} \quad (12)$$

does not belong to the feasible region. For, if it does, then

$$\sum_{j=1}^M f_j(\hat{\beta}_j) < \sum_{j=1}^M f_j[\beta(1-)] = F(1-) \quad (13)$$

which contradicts that  $F(1-)$  is the minimum value of  $F$  [as shown by theorem 2(iv)]. Consequently, as the parameter  $\theta$  varies from  $\hat{\theta}$  to 1, for at least one  $j_1 \in J^+$ , the value of  $f_{j_1}$  must become larger than  $f_{j_1}(\hat{\theta})$ . In this case, for at least one  $j_2 \in J^-$ , the value must become smaller than  $f_{j_2}(\hat{\theta})$  due to the fact that  $F(\hat{\theta})$  is monotonically nonincreasing [by theorem 2(i)]. Thus, during the transfer from  $\beta(\hat{\theta})$  to  $\beta(1-)$ , the component  $\beta_{j_1}$  is in conflict with the component  $\beta_{j_2}$ . From the convexity of the  $\beta$  space, this conflict between  $\beta_{j_1}$  and  $\beta_{j_2}$  holds on the boundary of the feasible region.

Q.E.D.

As a result of the foregoing investigation, we can summarize the strategy for deciding the set value of  $\beta$  as follows. First, the set value of  $\beta_j$  for  $j \in J$  should be given by  $\beta_j = \beta_j^*$ , because the set value of this component has less influence upon the solution of (P1) than that of the component  $j \in J$ . Second, if  $J^+$  is an empty set, the interaction among the set values of the soft constraints may be regarded as negligible. Then the set value of  $\beta_j$  for  $j \in J^-$  may be determined individually in due consideration of the trade-off between each  $\beta_j$  and the objective function  $z$ . Third, if  $J^+$  is not empty, there exists a conflicting relation

<sup>†</sup>Note that the decision variables in (P3) are both  $x$  and  $\beta$ . The  $\beta$  space considered here means the projection of the points of  $(x, \beta)$  on the  $\beta$  subspace.

among the set values of the soft constraints. Therefore, we must determine the preferred value of  $\beta_j$  for  $j \in J$  with regard to the trade-off among all the conflicting components  $\beta_j$  and the objective  $z$ .

#### 4.3. A Procedure for Solving (P3)

If  $p > 1$ , (P3) is a nonlinear problem. To solve the nonlinear problem (P3), we apply a multilevel optimization technique by decomposing the problem into two subproblems. One of the subproblems is a linear programming problem, and the other is an unconstrained minimization. The interaction between subproblems is coordinated at the second level by using a gradient method. The detailed description of the algorithm is omitted here [5].

If  $p = 1$ , (P3) is just the following linear programming problem:

$$(P4) \quad \min_{x, \alpha} [\theta w'x + (1 - \theta) c'z]$$

subject to

$$\left. \begin{aligned} \begin{pmatrix} A & 0 \\ B & -I \end{pmatrix} \begin{pmatrix} x \\ \alpha \end{pmatrix} &\leq \begin{pmatrix} b \\ \beta^* \end{pmatrix} \\ x \geq 0 & \quad \alpha \geq 0 \end{aligned} \right\} \quad (14)$$

where  $\alpha \triangleq \beta - \beta^*$  and  $w$  is the  $M$  vector with the components  $1/\beta_j^*$ .  $I$  is the  $M \times M$  identity matrix.

Phase I in the two-phase simplex procedure corresponds to solving (P4) with  $\theta = 1$ . In the present procedure, we solve (P4) with the parameter  $\theta$  varying over the unit interval.

## 5. A PROCEDURE FOR DETERMINING A PREFERRED SET VALUE OF THE SOFT CONSTRAINT

### 5.1. Definition of a Minimization Problem with $(m + 1)$ Objectives

Since (P2) is a bicriterion problem, the noninferior solutions of (P2) are obtained rather easily. However, the solution depends upon the choice of the parameter  $p$  and the weighting factor  $f_j$ , and the solution set is restricted in that sense. Therefore, it is neither reasonable nor attractive to select a preferred value of  $\beta$  from this solution set. The purpose of section 5 is to determine preferred values of the inconsistent soft constraints found in section 3.2.

Let  $m$  be the number of inconsistent soft constraints. The set values of the remaining  $(M - m)$  soft constraints are fixed appropriately [for example, set  $\beta_j^* = \beta_j(1-)$ ], and these constraints are appended to the constraint set (1). That is to say, in this section,  $b$  of (1) is changed into an  $(l + M - m)$  vector, and  $\beta$  of (2) into an  $m$  vector. As a matter of course,  $\beta > \beta^*$ .

In this section, we treat the relaxation quantities of  $m$  components of  $\beta$  as independent performance indexes instead of summing them up. Then we define the following minimization problem with  $(m + 1)$  objectives:

$$(P5) \quad \min_{x, \beta} \begin{bmatrix} z(x, \beta) \\ f(\beta) \end{bmatrix}$$

subject to (1) and (2) where  $f(\beta)$  is the  $m$  vector function with components given by (5).

We attempt to find a preferred solution of (P5) out of the noninferior set in accordance with an additional criterion induced by the planner.

### 5.2. Determination of Trade-off Rate

The preferred solution of (P5) is obtained in an interactive way which utilizes the idea of the surrogate worth trade-off method [1]. In order to derive information on the planner's preference, the trade-off rate needs to be calculated for every noninferior solution of (P5). For this purpose, the  $\varepsilon$  constraint approach is applied to the problem (P5). This is advantageous in the sense that a revised simplex method is applicable even to the problem with  $p > 1$ .

Then, by replacing  $m$  objectives except  $z(x, \beta)$  in (P5) with the inequality constraints, we consider the following problem:

$$(P6) \quad \min_{x, \beta} z(x, \beta) \quad (15)$$

subject to (1), (2), and  $f(\beta) \leq \varepsilon$  where  $\varepsilon$ , a parameter of dimension  $m$ , is so chosen that (P6) has a solution.

As is well known, the noninferior solutions of (P5) are given by the optimal solution of (P6) when the constraint (15) is active. The Lagrangian function of (P6) is

$$J = c'x + \lambda' [f(\beta) - \varepsilon] + \xi'(Ax - b) + \eta' (\exists x - \beta) \quad (16)$$

where  $\lambda$ ,  $\xi$ , and  $\eta$  are vectors of Lagrange multipliers associated with the corresponding constraints. Note that when  $\lambda_j > 0$ , the value of  $\lambda_j$  represents the trade-off ratio between  $z$  and  $f_j$ .

Since all the constraints and the objective of (P6) are convex and differentiable for  $\beta > \beta^*$ , the Kuhn-Tucker conditions are necessary and sufficient for the optimality of (P6) [2]. These conditions are as follows:

$$\begin{aligned}
\varepsilon &\geq 0, & c + A'\xi + B'\eta &\geq 0 \\
\lambda &\geq 0, & f^*(\beta) - \varepsilon &\leq 0 \\
\xi &\geq 0, & Ax - b &\leq 0 \\
\eta &\geq 0, & Bx - \beta &\leq 0 \\
x' (c + A'\xi + B'\eta) &= 0, & \lambda' [f^*(\beta) - \varepsilon] &= 0 \\
\xi' (Ax - b) &= 0, & \eta' (Bx - \beta) &= 0
\end{aligned} \tag{17}$$

$$(\partial f_j^* / \partial \beta_j) \lambda_j - \eta_j = 0 \quad j = 1, 2, \dots, m \tag{18}$$

From (17) we have

$$z(x, \beta) = c'x = \xi'b + \eta'\beta \tag{19}$$

It follows from (17) and (18) that the optimal solution of (P6) is a noninferior solution of (P5), if and only if  $\eta > 0$ . In fact, if  $\eta > 0$ ,  $\lambda > 0$  holds from (18), and then the constraint (15) becomes active. This means that there is no improvement in  $z(x, \beta)$  without causing further degradation of at least one of  $f_j^*(\beta_j)$ . Thus this solution is in the noninferior set. On the other hand, if some  $\eta_j = 0$ , the  $j$ th constraint of (2) becomes inactive except for the degenerate case. Then from (19), the objective  $z(x, \beta)$  does not depend upon the value of such  $\beta_j$ . Also from (18),  $\lambda_j = 0$  holds; thus the  $j$ th component of (15) is inactive under the nondegeneracy. Accordingly, this solution belongs to the inferior set. The degenerate solution is also considered as an inferior one.

Summarizing, the noninferior solutions of (P5) and their trade-off rates are calculated as follows: the activeness of (15) yields

$$\beta_j = \beta_j^* (1 + \frac{\partial f_j^*}{\partial \beta_j} \varepsilon_j^{-1}) \quad j = 1, 2, \dots, m \tag{20}$$

By substituting (20) into (2) and solving (P1), we obtain the noninferior solution of  $x$ . In addition, from (18) the trade-off rate is given by

$$\lambda_j = (\partial f_j^* / \partial \beta_j)^{-1} \eta_j \quad j = 1, 2, \dots, m \tag{21}$$

where  $\eta_j$  is obtained as the simplex multiplier in solving (P1) by a revised simplex method. The above calculation is continued by varying the value of  $\varepsilon$  parametrically within the domain where (P6) has a solution such that  $\eta \neq 0$ .

### 5.3. Search Procedure for Finding the Preferred Solution

In the surrogate worth trade-off method, an interactive search procedure is used to find the preferred solution with the planner being consulted at each step of the search in order to assess the surrogate worth at a given noninferior point  $(z, f)$ . The value of the surrogate worth function  $\bar{w}_j$  represents the planner's assessment of how much he prefers trading  $\lambda_j$  marginal units of  $z$  for one marginal unit of  $f_j$ .  $\bar{w}_j > 0$  means that he prefers making such a trade,  $\bar{w}_j < 0$  means that he prefers not to make such a trade, and  $\bar{w}_j = 0$  implies indifference.

If the indifference band where

$$\bar{w}_j(f_1^0, f_2^0, \dots, f_m^0) = 0 \quad \text{for all } j \quad (22)$$

is obtained, then  $f^0$  and the corresponding  $z^0$  give the preferred values of the objectives. Substitution of  $\varepsilon = f^0$  into (20) results in the preferred value of  $\beta^0$ . Besides, by substituting  $\beta = \beta^0$  into (2) solving (P1), we obtain the preferred solution  $x^0$ .

In practice, it is difficult to find at any one time a point at which (22) holds simultaneously for all  $j$ . Therefore, the following successive approach may be effective. First, vary  $f_1$  alone by fixing the values of the other objectives  $f_j^j, j = 2, 3, \dots, m$  to attain  $\bar{w}_1 = 0$  at  $f_1 = \hat{f}_1$ . Second, vary  $f_2$  alone by fixing the other  $f_j^j$ , to attain  $\bar{w}_2 = 0$  at  $f_2 = \hat{f}_2$ , and so forth. After obtaining  $\bar{w}_m = 0$ , return to the search for  $\bar{w}_1 = 0$ . Repeat the procedure until  $\bar{w}_j = 0$  is attained for all  $j$ .

In this procedure, the planner need only evaluate the value of one  $\bar{w}_j$  at each step of the search. Then the trade-off curve shown in the  $f_j^j$  plane can be utilized to find the point  $\hat{f}_j^j$  where  $\bar{w}_j = 0$ . However, the consistency of the planner's preference must be assumed during the successive evaluation process.

## 6. APPLICATION TO REGIONAL AGRICULTURE PLANNING

This section is concerned with an application of the proposed method to a regional agricultural planning problem. The decision making by the surrogate worth trade-off method requires a model of the mathematical programming type. A result derived from the model reflects not only the planner's preference but the validity of the mathematical modeling. Therefore, the mathematical formulation has to be checked repeatedly in the discussion on the results obtained. As space is limited, a procedure and some typical results in a case study are reported here to demonstrate the use of the method.

### 6.1. Model Description

The aim of regional agriculture planning is to decide an optimum policy for farming management and land use with the goal

of securing a sound agricultural income and a satisfactory amount of agricultural products in the region. The region considered consists of 340 farm-households and the farmland of 480 hectares, and is located within Tokoname City in Aichi prefecture, Japan.

The problem was originally formulated by Kitamura [6] as the following linear programming problem:

$$(P7) \quad \max_x z = c'x$$

subject to

$$b^1 \leq Ax \leq b^2, \quad x \geq 0 \quad (23)$$

$$\beta^1 x - \beta^1 \geq 0 \quad (24)$$

$$\beta^2 x - \beta^2 \leq 0 \quad (25)$$

where  $z$  represents the gross agricultural income of this region. In the formulation, the type of agricultural management is divided into seven groups and further divided into 22 classes according to their products or combinations of products. The decision variable  $x$  is a 22 dimensional vector each component of which stands for the number of farm-households in a class of the agricultural management. The details are indicated in Table 1. For simplicity, we remove the restriction that  $x$  be an integer vector.

The hard constraint, given by (23), includes conditions on the area usable for farming and the total number of farm-households. The soft constraint of (24) and (25) includes three types of conditions:

- a condition on the desired amount of each agricultural product
- a condition on the number of farm-households in each group of agricultural management
- a condition on the number of each type of livestock.

The first two conditions are given by (24) and the third one by (25). The items of the soft constraint, together with the ideal set values denoted by  $\beta^1*$  and  $\beta^2*$ , are listed in Table 2.

In (P7), the dimensions of the vectors are as follows:  $c \in R^{22}$ ,  $b^1, b^2 \in R^{11}$ ,  $\beta^1 \in R^{19}$  and  $\beta^2 \in R^3$ . Because of limited space, the detailed description of  $A, \beta^1, \beta^2, c, b^1$ , and  $b^2$  is omitted here (see [6, 7]).

## 6.2. Solution of (P4)

The problem (P7) has no feasible solution when  $\beta^1 = \beta^1*$  and  $\beta^2 = \beta^2*$ . The procedures given in sections 3 and 4 are applied to (P7) in order to determine the preferred values of  $\beta^1, \beta^2$ , and  $x$ .

Table 1. The preferred values of farm-households in classes of the agricultural management.

(i) Class of Agricultural Management	Preferred Solution		
	A <sub>4</sub>	B <sub>3</sub>	C <sub>4</sub>
1 Rice, full-time	0	0	0
2 Rice, part-time I	14	15	11
3 Rice, part-time II	0	0	0
4 Dairy, full-time	17	16	16
5 Dairy, part-time I	0	0	1
6 Poultry raising, full-time	0	0	0
7 Rice and poultry raising, full-time	33	33	34
8 Rice and poultry raising, part-time I	0	0	0
9 Rice and poultry raising, part-time II	6	6	5
10 Chrysanthemum, full-time	4	6	2
11 Carnation, full-time	0	0	0
12 Rice and chrysanthemum, full-time	0	0	0
13 Rice and chrysanthemum, part-time I	53	53	55
14 Rice and carnation, full-time	5	4	7
15 Rice and paddyfield vegetables, full-time	0	0	0
16 Rice and vegetables, full-time	0	0	0
17 Rice and vegetables, part-time I	26	25	26
18 Rice and vegetables, part-time II	85	86	84
19 Rice and oranges, full-time	0	0	0
20 Rice and oranges, part-time I	0	0	0
21 Rice and oranges, part-time II	91	90	93
22 Rice and pig raising, full-time	6	6	6

Note: Full-time farm-households refers to those all of whose members are exclusively engaged in their own agriculture. Part-time I refers to the households subordinating jobs other than agriculture. Part-time II refers to the households subordinating agriculture.

Table 2. The items of the soft constraint and variation of the solution to (P4),  $\beta^1$  and  $\beta^2$ , with the parameter  $\theta$ .

Item of Soft Constraint	Ideal Set Values		Set Values $\beta^1, \beta^2$				
	$\beta^1, \beta^2$ *	$\theta=0.30$	0.50	0.70	0.90	0.99	
<b>Agricultural Production</b>							
1. Rice	570 (t)	570	570	570	570	570	
2. Milk	1250 (t)	1250	1250	1250	1250	1250	
3. Hen eggs	2200 (t)	2200	2200	2200	2200	2200	
4. Chrysanthemums	200 (104 units)	200	200	200	200	200	
5. Chrysanthemums	120 (104 units)	107	107	0	0	0	
6. Carnations	370 (104 units)	0	0	334	334	334	
7. Watermelons	350 (t)	350	350	350	350	350	
8. Irish potatoes	300 (t)	300	300	300	300	300	
9. Cabbages	700 (t)	700	700	700	700	700	
10. Japanese radishes	700 (t)	141	141	176	176	176	
11. Oranges	740 (t)	740	740	740	740	740	
12. Pigs	245 (t)	245	245	245	245	245	
<b>Farm-households by Group of Agricultural Management</b>							
13. Rice	160	160	160	160	160	160	
14. Dairy	12	12	12	12	12	12	
15. Poultry raising	39	39	39	39	39	39	
16. Horticulture	32	32	32	32	32	32	
17. Vegetables	39	39	39	39	39	39	
18. Oranges	34	34	34	34	34	34	
19. Pig raising	8	6	6	6	6	6	
<b>Number of Livestock</b>							
20. Milk cows	253 (Head)	478	478	478	478	478	
21. Hens	178 (103)	178	178	178	178	178	
22. Pigs, female	144 (Head)	151	151	151	151	151	
Gross Agricultural Income	(million yen per year)	362	362	353	353	353	



In our case study we put  $\varphi = 1$  in (5), and solve (P4). Table 2 shows a variation of the set values  $\beta^1$  and  $\beta^2$  with the parameter  $\vartheta$  ranging between 0.3 and 1. By referring to Table 2 we know, from (10) of this problem, that

$$J^+ = \{5\}, \quad J^- = \{6, 10, 19, 20, 22\}, \quad J = J^+ \cup J^-$$

where the numbers indicate the soft constraints as in Table 2.

That is to say, the set values of  $\beta_j$  with  $j \in J$  are too excessive to make the constraints feasible, so that they must somehow be relaxed. In particular, note that the amount of chrysanthemum production ( $j = 5$  in Table 2) is in conflict with that of the production of carnations ( $j = 6$ ) or radishes ( $j = 10$ ).

### 6.3. Examples of Search for the Preferred Solution

As an example,  $\beta_5$  and  $\beta_6$  are chosen as trade-off parameters out of  $\beta_j$ ; while the remaining  $\beta_j$  are fixed as

$$\begin{aligned} \beta_{10} &= 150, & \beta_{19} &= 6, & \beta_{20} &= 500, & \beta_{22} &= 160 \\ \beta_j &= \beta_j^* & & & & & & \text{for other } j \end{aligned}$$

For convenience, let us renumber  $\beta_5$  and  $\beta_6$  as  $\beta_1$  and  $\beta_2$ , respectively. Accordingly, hereafter  $\beta_1$  implies the desired amount of production of chrysanthemums and  $\beta_2$  that of carnations. We then define the problem (P5) as having three objectives, i.e., the relaxation quantities  $f_1(\beta_1)$  and  $f_2(\beta_2)$  together with the original objective  $z$ .

Figure 1 illustrates an example of the application of the interactive procedure of section 4.3. The first quadrant of this figure shows trade-off curves between  $\beta_1$  and  $z$  for various values of  $\beta_2$ . The third quadrant shows those between  $\beta_2$  and  $z$  for various values of  $\beta_1$ . The process of decision made by the first planner is shown on the  $\beta_1\beta_2$  plane in the fourth quadrant. Inquiring from him starts from two different initial points, and ends at the points  $A_4$  and  $B_3$ , respectively. Note that the planner seems to be interested in the points of discontinuity of the trade-off ratios. Hence, it may be conjectured that his indifference band exists along the line connecting two points  $A_4$  and  $B_3$ .

Figure 2 shows the decision process made by the second planner. This planner seems to have a dominant preference to high value of  $\beta_2$ . Therefore, his preferred solution will be the same point irrespective of initial points.

The preferred values of  $z$  thus obtained are indicated in Table 1.

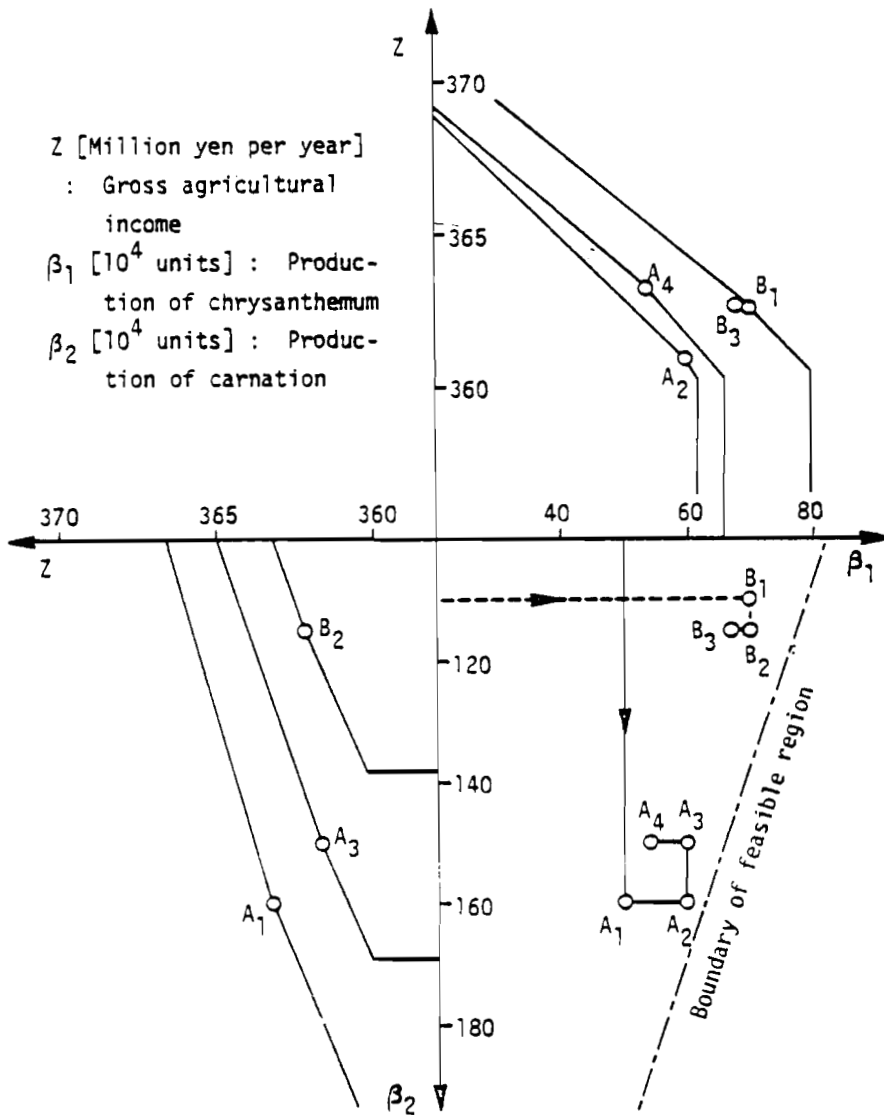

Figure 1. Decision process made by the first planner.

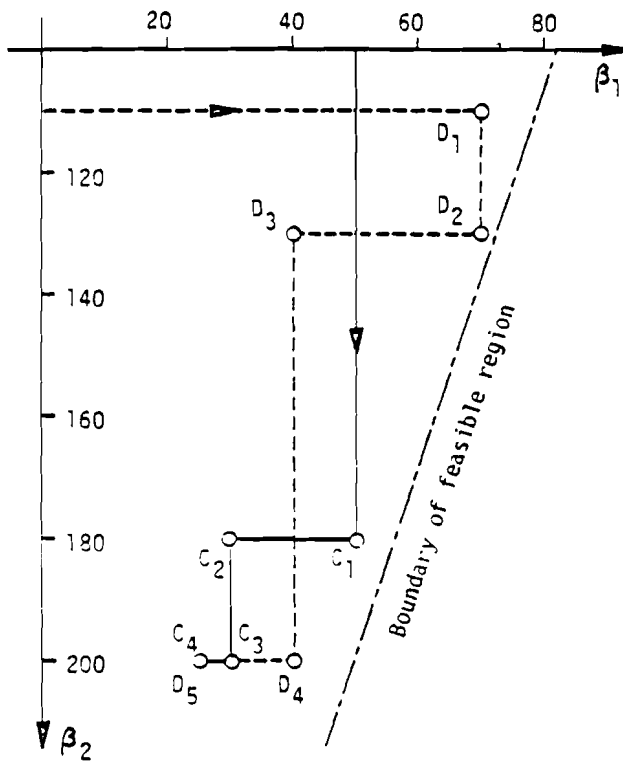

Figure 2. Decision process made by the second planner.

## 7. APPLICATION TO MACRO SOCIOECONOMIC MODELS

In the context of our IRDP, several socioeconomic models have been developed or are under development. In this section, we summarize the concept of application of our methodology to some models.

### 7.1. Basic Methodological Aspects for Decision Simulation

In order to investigate the effects of administrative policy and inhabitants' preferences on the regional development, we need a model that can depict the time evolution of the regional state under those decisions. For this purpose we may use the method of systems dynamics (SD) or something similar. But in constructing a SD model many subjective assumptions on variables and functional relationships are inevitable. Furthermore, the time requirement for simulation may become impractically large when the model includes some detailed microlevel sectors. Thus we have not made full use of the SD technique and will mainly rely upon the concept of quasistatic evolution of the economic and social status. In our quasistatic model, the core idea of the modeling and simulation might be interpreted as follows.

Let  $x$  be the vector of  $n$  activity variables which is directly associated with operational decision variables of the inhabitants (citizens), the enterprises, and the local authorities. The  $n$  vector  $x$  is composed of variables such as the consumption, or its rate of the income of the inhabitants, the amount of production and investment by enterprises, and the taxation and budgeting policy of the local governments. As the result of activity  $x$ , there will be brought about a variety of socioeconomic consequences such as the consumption of natural resources, changes in supply and demand in the market, the change in income of citizens, increase in social stocks, and emission of pollutants. Let  $a'_i x$  be the amount of the  $i$ th consequence, where  $a_i$  denotes the amount of  $i$ th consequence per unit activity, the prime denoting a vector transposition.

Due to the physical, exogeneous, or human-intentional reasons, the consequence  $a'_i x$  is generally limited to be more than some value  $b_i$ . (If the limitation is "less than" instead of "more than," it is readily converted to the equivalent "more than" expression for  $-a'_i x$ .) Mathematically, we can deal with this limitation by using the inequality constraint

$$a'_i x \geq b_i \quad i = 1, 2, \dots, m \quad (26)$$

If a certain activity variable itself is subject to a limitation, then we can include it in (26) by setting the corresponding  $a$  vector to a unit vector. Summing (26) over  $i$ , the constraints are concisely described by

$$Ax \geq b \quad (27)$$

where  $A$  is the  $m \times n$  matrix whose rows are  $a'_i$ , and  $b$  is an  $m$  vector. Let  $b^*$  be the most desirable value of  $b$ . In many real social

situations, it may happen that there is no feasible  $x$  to (27) if  $b = b^*$ . That is to say, no consistency may be obtained among the constraints if the desirable limitations are set independently. In such a case, we have to relax certain of the limitations to get a feasible value of  $x$ . Some constraints in (27) are hard ones which cannot be relaxed due to physical or other reasons, but the other constraints are soft ones which could be relaxed to some extent by human decision.

We now represent a set of social indicator indexes in terms of the activity  $x$ . The social indicators are indexes adopted as measures of the social state from the viewpoint of regional life quality as well as economic soundness. Therefore they might be considered as measures of the social utility derived from the relevant attributes. Let

$$y_j = c_j'x \quad j = 1, 2, \dots, r \quad (28)$$

be the level of  $j$ th indicator. Again in a vector-matrix expression, (28) is simply written as

$$y = Cx \quad (29)$$

where  $C$  is the  $r \times n$  vector whose rows are  $c_j'$  and  $y$  is an  $r$  vector. It is noted here that a certain  $c_j'x$  may be identical with a certain  $a_i'x$ .

Since, as a matter of course, we want to maximize the level of each indicator (utility) as far as possible, our problem is stated as a multiobjective maximization problem. Maximize

$$y = Cx \quad (30)$$

subject to

$$Ax \geq b, \quad b^* \geq b \geq b^0 \quad (31)$$

The elements of matrixes  $A$  and  $C$  are to be identified in the model by using socioeconomic variables, parameters, and equations, e.g., the production function, the input-output analysis, population dynamics, the social preference function, etc. Although we have assumed so far that, for simplicity, both (30) and (31) are modeled in linear forms we can extend them into nonlinear forms if necessary.

#### 2.1.1. The Case of A Single Decision Maker

If there is only one regional decision maker, the problem of (30) and (31) is a linear programming problem with multiobjectives. If, furthermore, the vector  $y$  can be reduced to a scalar quantity by some means, e.g., by the typical weighting technique, then the problem is a conventional one. In any case, first we check the feasibility of the constraint (31). If feasible, we proceed to determine the "optimal"  $x$ . The sense of optimality is clear in the case of one objective, but is not in the case of

multiobjectives. For the multiobjective optimization problem we have to rely upon the trade-off technique to determine optimality in the sense of preference.

If (31) is not feasible, we have to try to relax some soft constraints. Again a trade-off is needed among the relaxations, and the method developed in this paper can be effectively applied.

### 7.1.2. The Case of Several Decision Makers

If there exists more than one decision-making body in the region, and each decision body has its own set of indicators (or objectives or utilities), then the decision problem is a kind of gaming problem among the decision bodies. This kind of gaming or conflicting situation is a substantial feature of real society nowadays. In our whole regional model, we are considering three typical decision bodies, that is, the citizens, the private enterprises, and the regional government, whose objectives are quite often in mutual conflict. Furthermore, we are to consider a gaming among decision bodies belonging to different subregions.

For the gaming situation, the mathematical formulation is as follows. For the  $k$ th decision body, the activity variables (or the decision variables) vector is denoted by  $x_k$ , and the indicators vector by  $y_k$ . Then the problem for the  $k$ th body is as follows. Maximize

$$y_k = C_k x \quad (32)$$

subject to

$$Ax \geq b, \quad b^* \geq b \geq b^0 \quad (33)$$

where  $x$  is the direct sum of  $x_k$  and (33) is the common constraint to all the decision bodies. For the setting or the relaxation of (33), all the decision bodies must negotiate with one another in order to obtain mutual agreement.

In the game, the rule for decision choice will be much more complicated and difficult than in the nongaming situation, especially under the condition of multiobjectives and relaxable constraints. The model could be used for different aims, e.g., for testing intuitive decisions, for improving intuitive decisions, for examining the effect of information exchange between the decision makers, and for simulating negotiation, cooperation, and coalition. Any way, the man-model interactive decision process or the intervention of human decision in the regional evolution process is at the core of our interest.

The flow diagram of Figure 3 summarizes the above discussions.

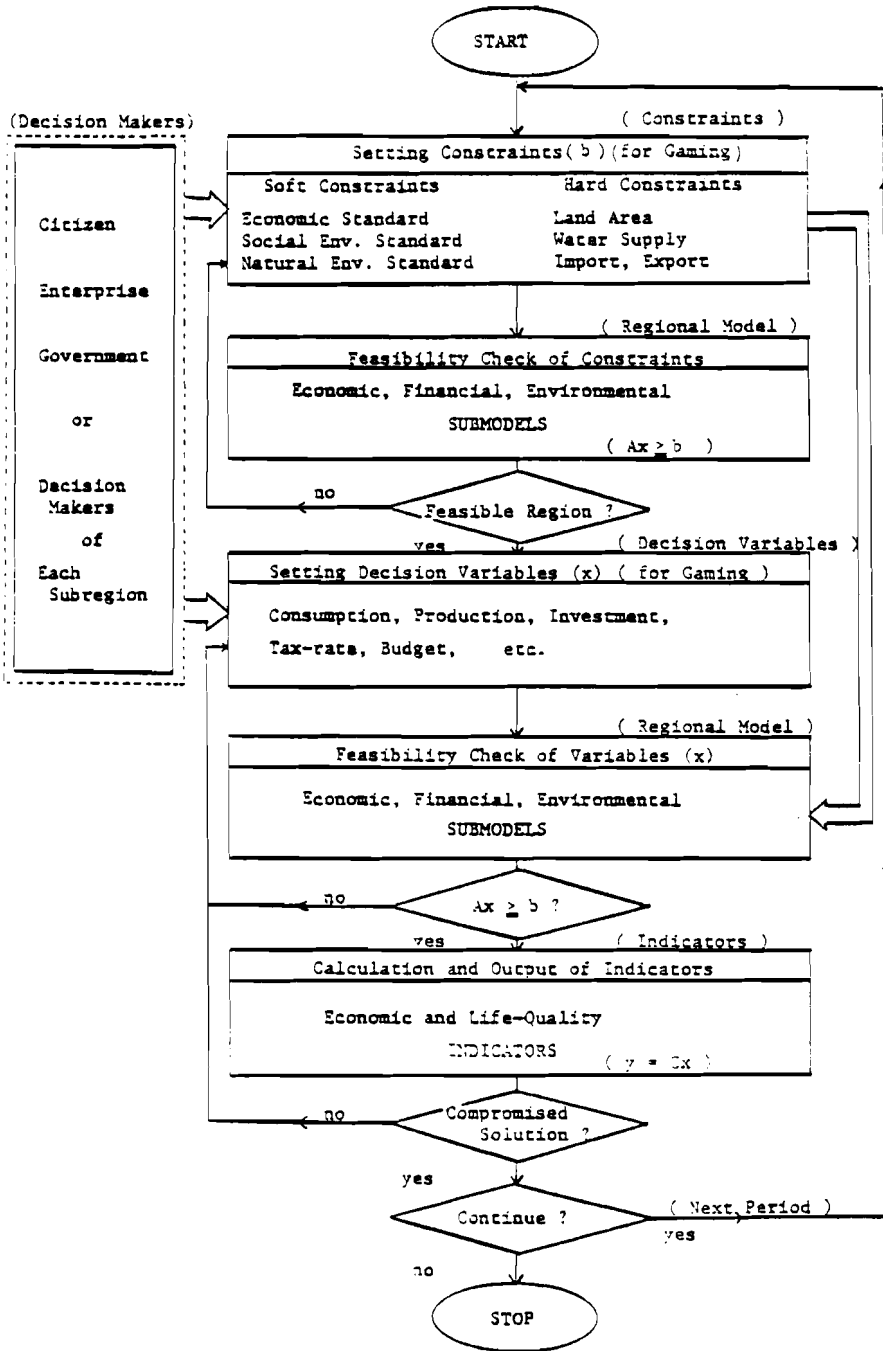

Figure 3. Flows in decision simulation.

## 7.2. Outline of the Model Structure

The model is to be constructed as an intelligible and persuasive one. For this purpose, best use should be made of realistic variables backed by data, and a powerful means of modeling and simulation [such as ISM (Interpretive Structural Modeling), DEMATEL (Decision Making Trial and Evaluation Laboratory), econometric modeling, input-output analysis, systems dynamics, (multi-objective) mathematical programming and optimization, decision analysis, gaming, or utility evaluation] should be appropriately utilized. Also the model is to be segmented into sectoral modules, and to be flexible enough to treat current problems of interest such as resource shortage, the gap between supply and demand of various goods, and environmental crises.

Figures 4 and 5 show the conceptual framework of the whole-Kinki-regional model and the interrelation structure among the subregional models, respectively. The whole-regional model is mainly used for gaming decisions among the citizens, enterprises, and the government, while the interrelated subregional model is used for gaming decisions among the subregional (prefectural) governments. Those models can also be used, if we wish, for a normative planning simulation.

### 7.2.1. *Decision and Activity*

The principal decision variables and/or activity variables are as follows.

#### *Citizen*

- propensity to consume
- pattern of consumption
- propensity to save
- pattern of saving, etc.

#### *Enterprise*

- investment policy
- production policy
- technology innovation
- factory allocation, etc.

#### *Government*

- taxation policy
- budgeting policy
- financial policy.

### 7.2.2. *Hard Constraints*

The hard constraints that are rigidly set according to the regional or the exogeneous limitations are exemplified by the following.



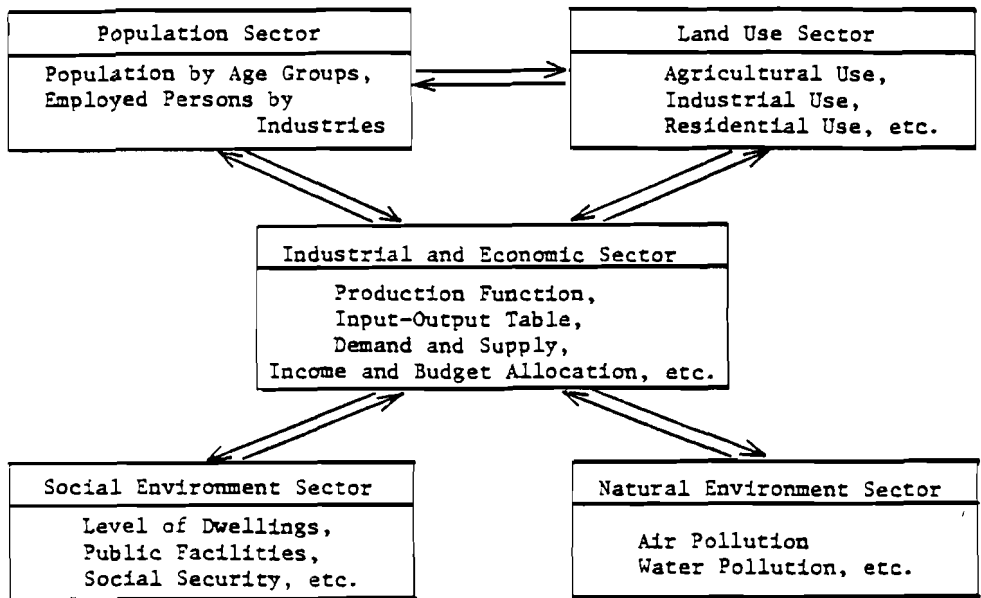

Figure 4. The whole regional model.

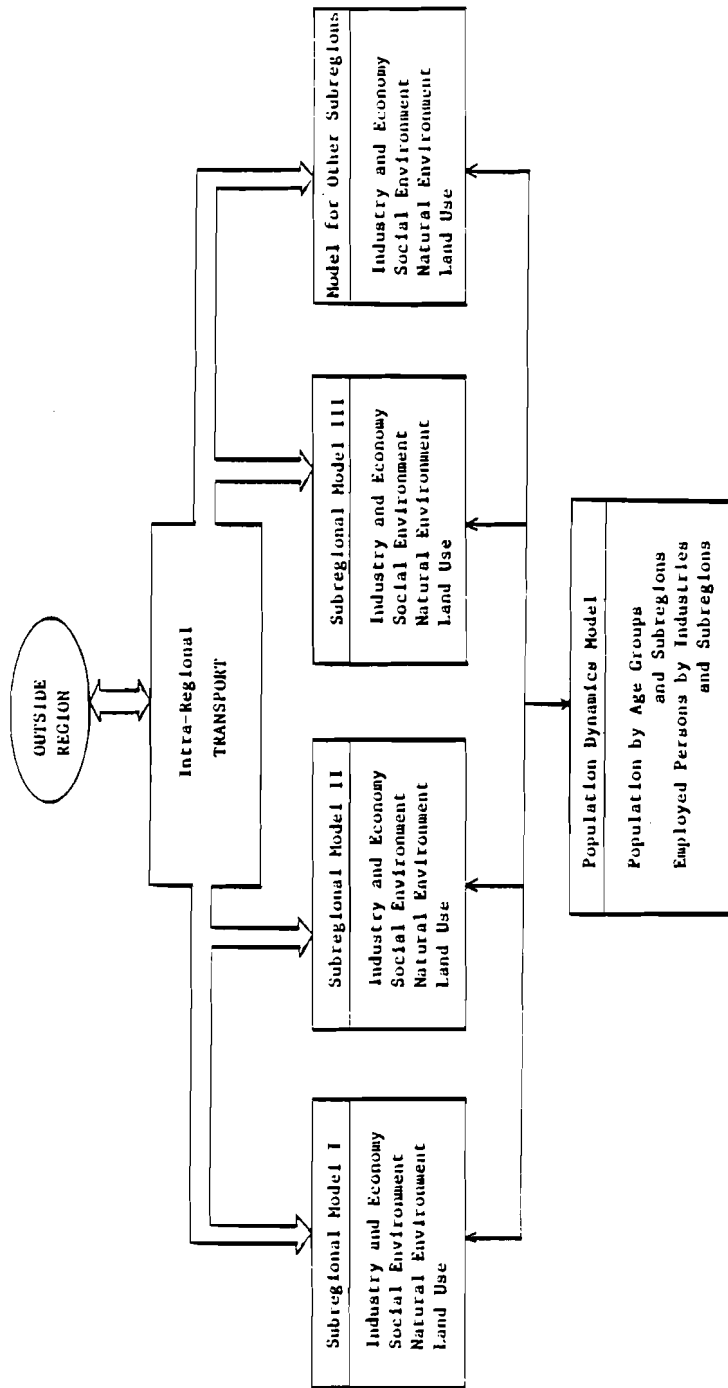

Figure 5. Subregional models and their interrelations.

*Raw material*

- import restriction.

*Land and water*

- inhabitable area
- cultivatable area
- reserved forest and green area
- upper bound of water supply, etc.

*Production*

- capital stock
- labor force, etc. (by industries).

*Demand*

- upper bound of export, etc.

7.2.3. *Soft Constraints*

The soft constraints that are determined more or less according to human intention or preference are exemplified by the following.

*Income level*

- dispensable income per capita.

*Housing level*

- number and quality of housings
- floor area per capita.

*Public facilities*

- medical
- safety
- education and culture
- transportation
- communication
- leisure, etc.

*Natural environment*

- air pollution ( $SO_x$ )
- water pollution (BOD)
- dust
- solid sewage
- noise and vibration
- safety from natural disasters
- green area, etc.

*Social security*

- for children, aged, handicapped, sick.

#### 7.2.4. Indicators

Some items in the soft constraints are considered to be the indicators.

#### 7.2.5. Other remarks

The population sector is a SD type model calculating the yearly population and labor change. The industrial and economic sector is composed of submodels for industrial production, economy, and finance.

#### 7.3. Some Results of Simulation

Some of the typical results obtained in our experimental simulation are illustrated in Figures 6 to 13.

### 8. CONCLUSION

A practical method of multiobjective planning based on a model of the linear programming type has been developed. Our approach starts with a problem having a single objective and several soft constraints. Adjustment of the set values of the soft constraints, which is done by finding the planner's preference, gives us a point of satisfactory compromise between the attainment of the objective and the requirement on the constraints.

For this purpose, first the constraint components that must be relaxed for getting feasibility of the original problem are found. Second, preferred set values of the inconsistent constraints and the preferred solution of the original problem are determined by an interactive procedure utilizing the concept of surrogate worth trade-off. A special procedure is invented to deal with more than two objectives.

The proposed method was applied to a type of optimum land-use planning in a rural region of Japan. The result obtained gives an important suggestion for the rational agriculture planning of the region.

An extension of the method to a more general class of mathematical programming has also been investigated, and will be reported in a separate paper.

### REFERENCES

- [1] Haimes, Y.Y., W.A. Hall, and H.T. Freedman (1975) Multiobjective Optimization in Water Resources Systems, The Surrogate Worth Trade-off Method. Elsevier.
- [2] Lasdon, L.S. (1970) Optimization Theory for Large Systems. Macmillan.
- [3] Yu, P.L., and G. Leitmann (1974) Compromise solutions, domination structures and Salukvadze's solution. JOTA 13:362-278.

- [4] Geoffrion, A.M. (1967) Solving bicriterion mathematical programs. *Oper. Res.* 15:39-54.
- [5] Sannomiya, N., Y. Nishikawa, and Y. Tsuchihashi (1975) Optimization under vector valued criteria and its application. Pages 109-112 in preprints of 4th SICE Symposium on Control Theory, Tokyo (in Japanese).
- [6] Kitamura, T. (1974) Yata District Master Plan in Tokoname City. Technical Report. Japan: Institute of Comprehensive Architectural Planning (in Japanese).
- [7] Sannomiya, N. (1976) The Surrogate Worth Trade-off Method-III. Pages 1-14 in Technical Report No. '76-2. Japan: Japan Association of Automatic Control Engineers, Research Group on Multiobjective Systems (in Japanese).

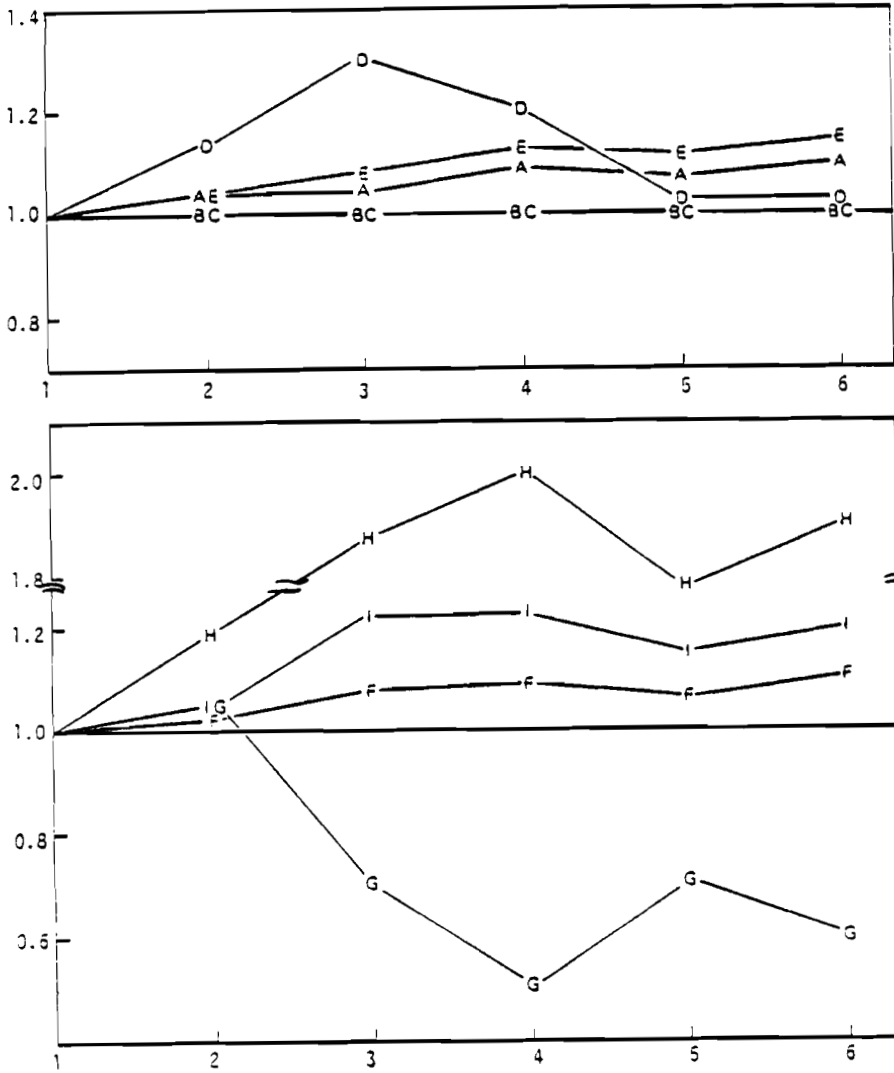

Increase ratio in production

Indicator	1	2	3	4	5	6	7	8	9
Increase ratio (%)	3.8	-0.2	-0.8	6.2	16.9	5.0	12.4	21.1	11.9

Figure 6. Simulation I—(1) Maximization of dispensible income.

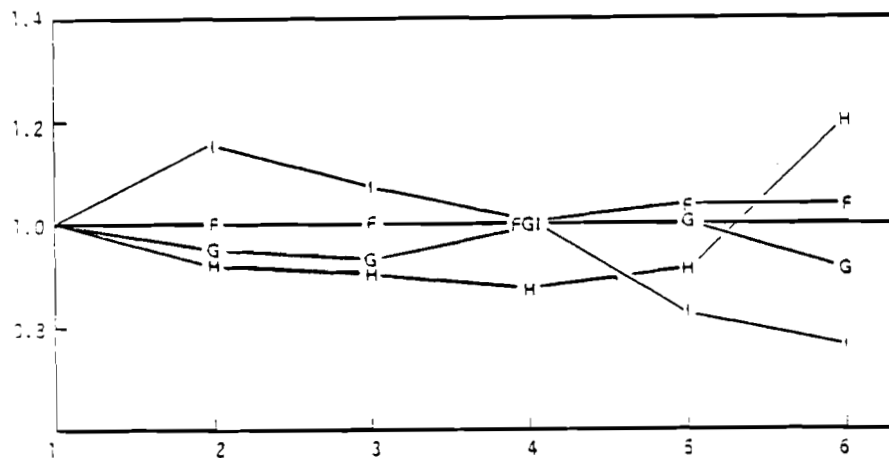
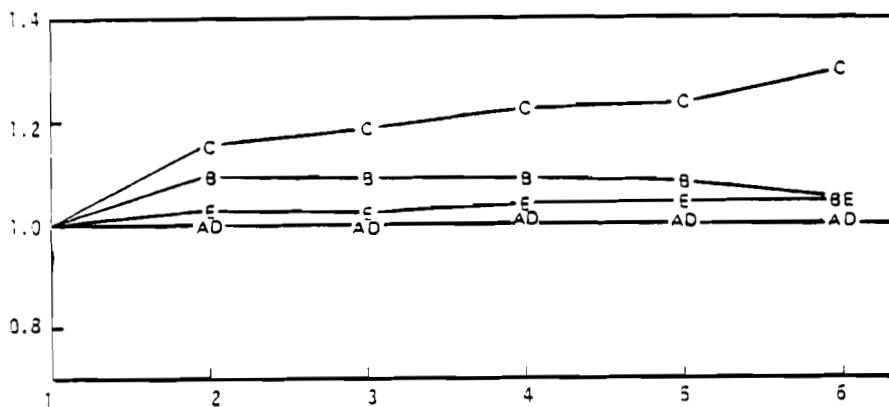

Increase ratio in production

Indicator	1	2	3	4	5	6	7	8	9
Increase ratio (%)	1.3	-13.8	-5.3	-1.3	14.7	0.6	-0.3	0.2	5.4

Figure 7. Simulation I—(2) Optimization of natural environment.

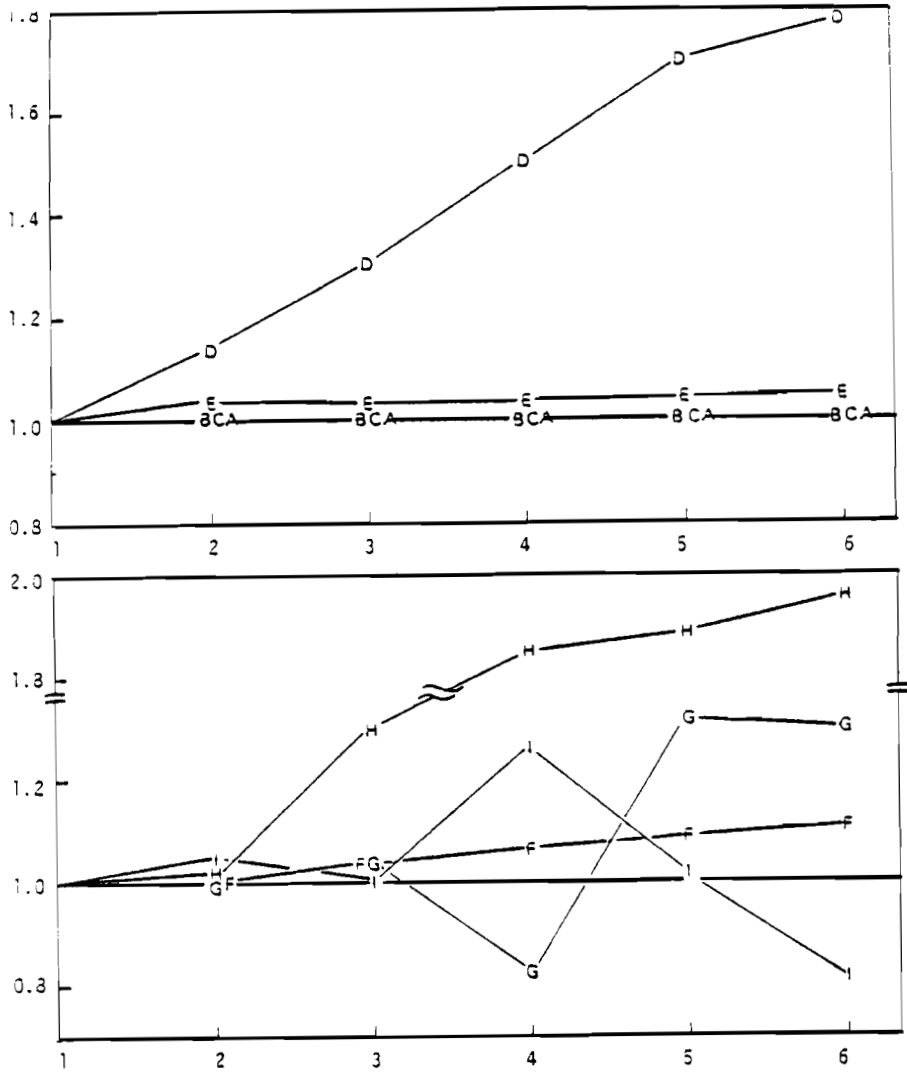

Increase ratio in production

Indicator	1	2	3	4	5	6	7	8	9
Increase ratio (%)	11.5	-13.8	-3.4	0.0	19.2	9.3	-0.6	15.3	16.2

Figure 8. Simulation I—(3) Maximization of social security.



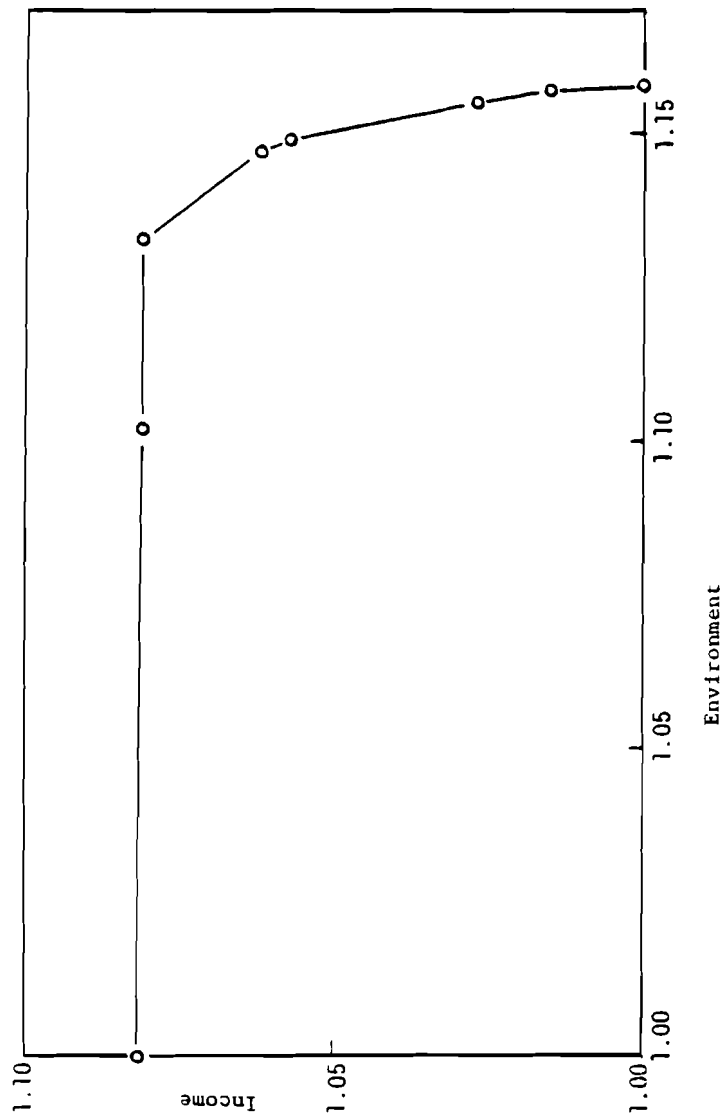
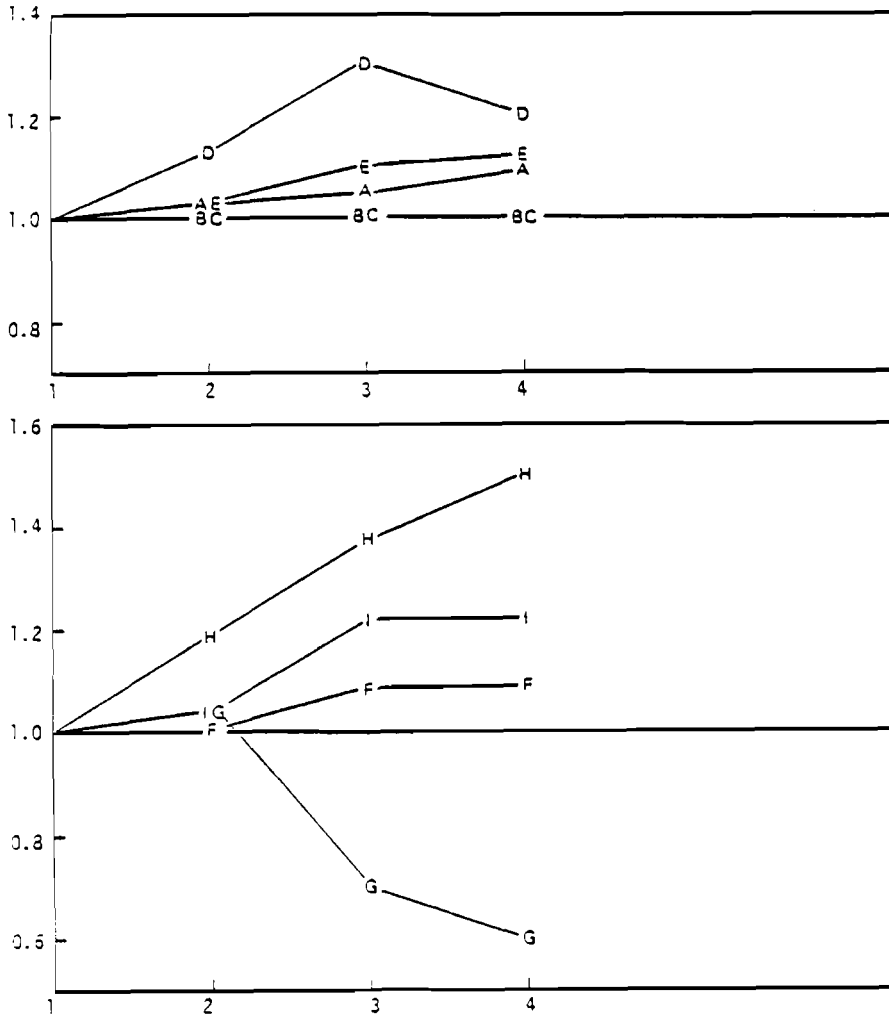

Figure 9. Simulation I---(4) Trade-off between income and environment.



Increase ratio in production

Indicator	1	2	3	4	5	6	7	8	9
Increase ratio (%)	8.4	-9.4	-1.3	5.7	14.3	6.1	13.5	6.3	9.7

Figure 10. Simulation II—(1) 15 percent increase of dispensable income per capita.

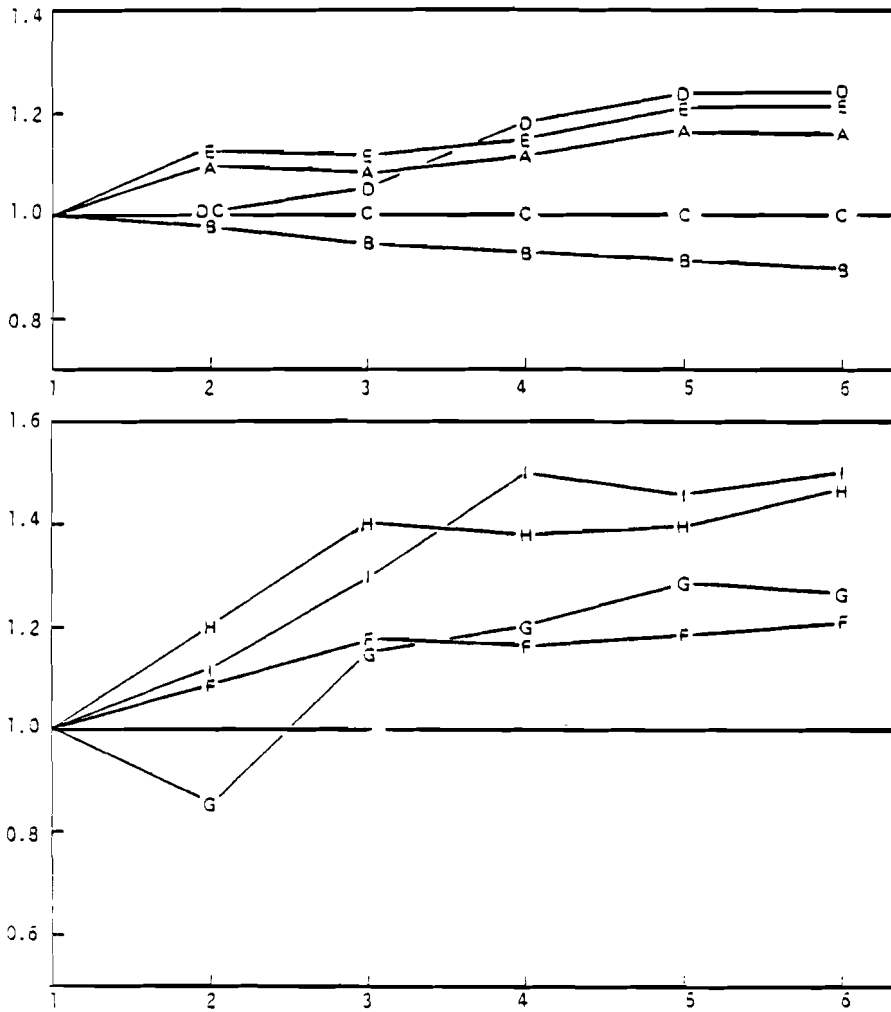

Increase ratio in production

Indicator	1	2	3	4	5	6	7	8	9
Increase ratio (%)	22.1	13.9	8.3	23.1	12.3	17.0	36.2	30.0	20.9

Figure 11. Simulation II—(2) 10 percent deterioration of natural environment.

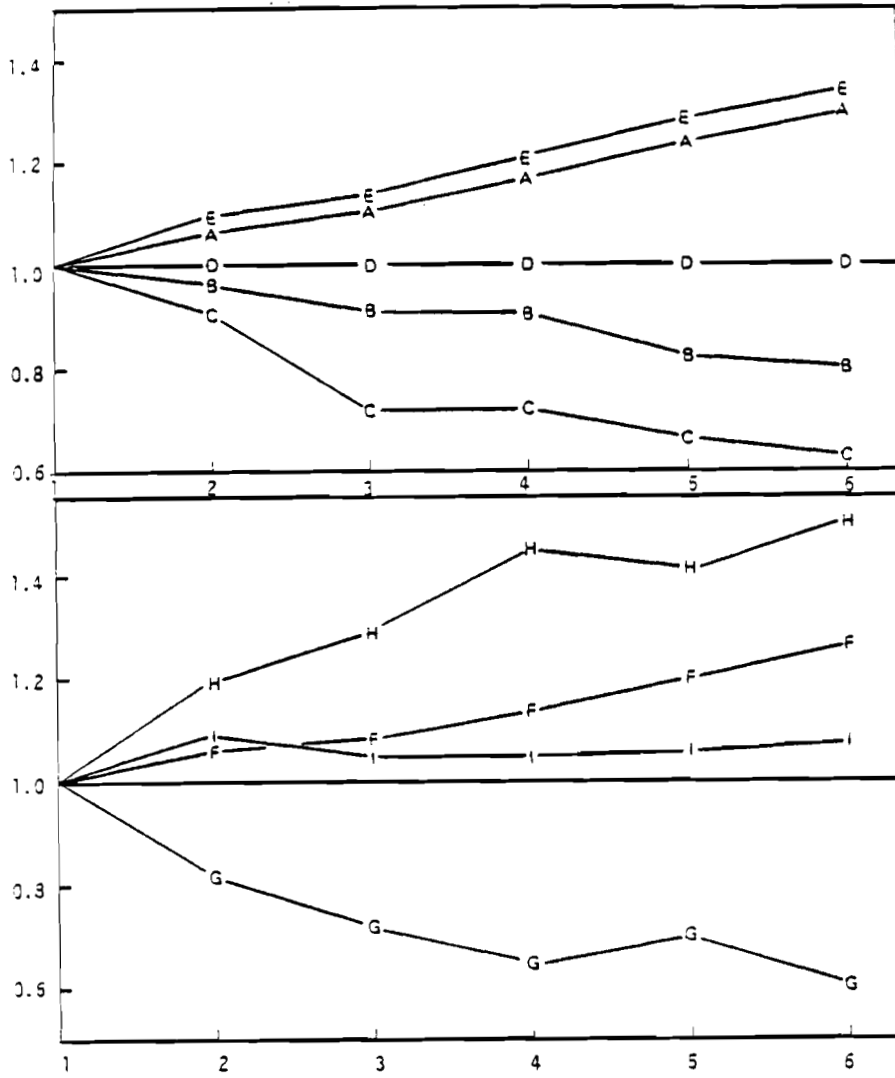

Increase ratio in production

Indicator	1	2	3	4	5	6	7	8	9
Increase ratio (%)	32.6	17.8	14.2	31.8	24.6	23.9	23.8	36.5	26.8

Figure 12. Simulation II—(3) 50 percent deterioration of natural environment.

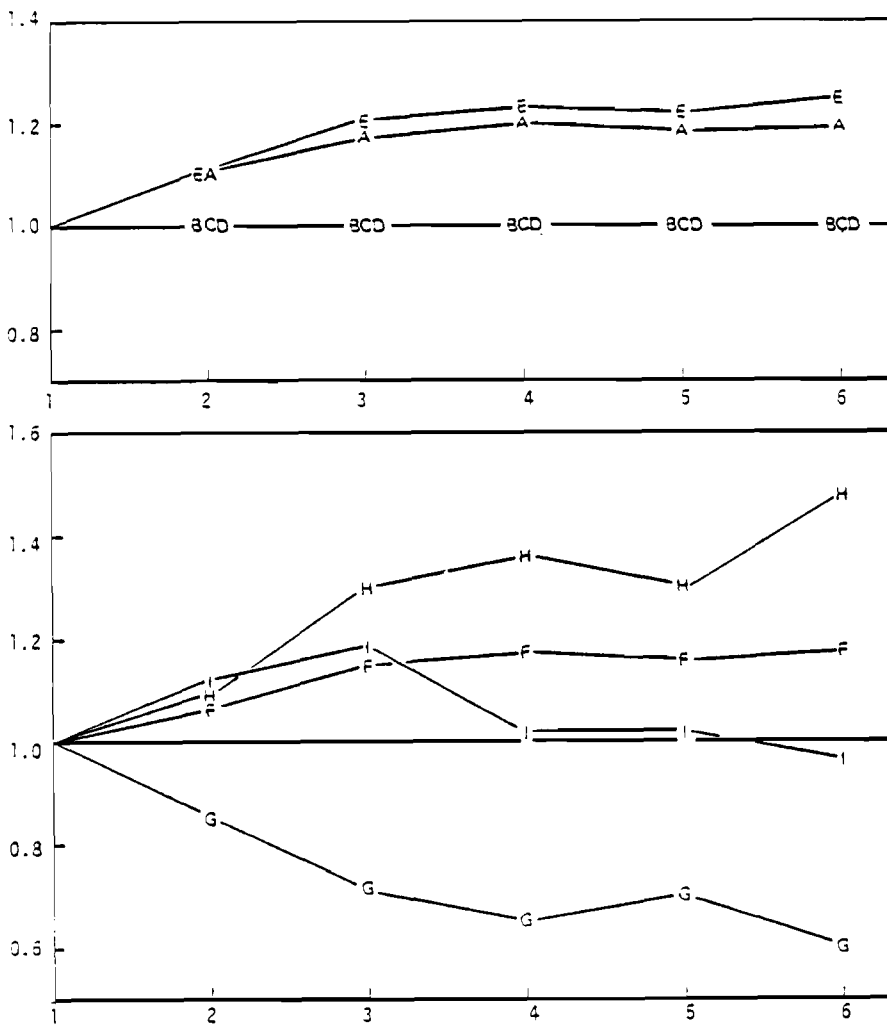

Increase ratio in production

Indicator	1	2	3	4	5	6	7	8	9
Increase ratio (%)	19.5	-13.8	6.4	17.7	24.4	15.3	15.2	28.7	18.7

Figure 13. Simulation II—(4) Three times increase in anti-pollution investment.

EVALUATION IN ENVIRONMENTAL SYSTEM PLANNING: THE  
NESTED LAGRANGIAN MULTIPLIER METHOD

F. Seo

*Kyoto Institute of Economic Research, Kyoto University,  
Kyoto, Japan*

M. Sakawa

*Department of Systems Engineering, Kobe University,  
Kobe, Japan*

1. INTRODUCTION

Environmental systems are generally considered as multiple-objective systems. In such systems, objectives are generally noncommensurable, that is, they cannot be compared with each other in terms of common units of measurement. Faced with this kind of situation, our problem is how to construct a proper standard for obtaining an optimal design of such complex systems. In other words, we are concerned with constructing a comprehensive standard for management, planning, and evaluation of environmental systems.

In environmental systems planning, our main concern is the maintaining and improving of the quality of life. The aim of this paper is to present a device for numerical measurement of satisfaction levels for residents in a given region. An overall welfare index will be derived as a standard for environmental evaluation.

Recently, the utility approach has attracted increasing attention in various fields. In this paper, the usefulness of this approach over conventional optimization methods, such as the Paretian approach, is examined. However, the utility approach inevitably includes indeterminateness and arbitrariness. For overcoming these problems the authors propose a new revised method for systems evaluation which combines external methods with multiattribute utility analysis. It will be shown that this new method is more efficient in the computational process of utility assessment. Next, this device will be demonstrated for the problem of environmental evaluation in the Kinki industrialized area in Japan. Some results are presented and an overall utility function derived. Based on the evaluation, some

suggestions for the reformation of industrial structure are proposed. Special stress is placed on the usefulness of extremal methods in obtaining dual optimal solutions for systems evaluation rather than in the acquisition of primal optimal solutions.

## 2. CRITERIA FOR EFFECTIVE METHODS FOR ENVIRONMENTAL SYSTEMS ANALYSIS

Environmental systems are distinguished by the fact that they are all large-scale and include many kinds of elements. It seems that a hierarchical modeling of multilevel systems in an orderly arrangement will be most efficient for analyzing this kind of large-scale system. Hierarchical modeling has two aspects: systems decomposition and coordination. This means that the elements included in a given system will be decomposed into subsystems and then consolidated consistently. We treat the elements in terms of various levels of objectives. An objectives hierarchy will be constructed corresponding to the systems decomposition and coordination. The following structuring of objectives provides a basis for the methodology for treating the hierarchical system: (i) decomposition of an overall objective for the system into many attributes; (ii) ordering of the attributes, which are considered as objectives in the subsystems, in an objectives hierarchy; (iii) consolidation of the objectives in the subsystems into a unified comprehensive objective. The criteria proposed here for the structuring of objectives have a decision support orientation. This implies the following criteria for a useful methodology:

- handling of noncommensurability, a characteristic shared by many elements in environmental systems;
- articulation of value trade-offs between conflicting objectives;
- practical possibility of determining priority among many objectives;
- interactive or sequential processes of decision making. In practice, possible participation of citizens as well as knowledgeable persons;
- clarification of evaluation for the systems design and policy proposals based on it;
- consideration and preservation of minor elements involved in the system.

In view of these criteria for selection of a methodology, we will present a short methodological review in the following section.

## 3. A METHODOLOGICAL REVIEW

### 3.1. Multiple-Objective Optimization Methods

The main aim of multiple-objective optimization methods is to select the preferred solution as the best compromise solution from among noninferior solutions (Pareto-optimal solutions).

There are three classes of approaches by which the preferred solutions can be found. The first is the most suitable for identification of the Pareto admissible frontier as a noninferior set. The weighting method and constraint method, which belong to this class, can provide much information about Pareto-optimal trade-off rates among objective functions. These methods have been utilized for optimal design of environmental systems [1, 2]. However, these methods themselves cannot determine the best compromise point in the Pareto admissible frontier. For example, the weighting parameters of the weighting method must be determined from outside the system. The monovalue system is characteristic for this method. Conventionally, price ratios for the components of GNP have been utilized as the weighting parameters in this pre-examined criterion. More recently, Dorfman and Jacoby [3] interpreted the parameters as "political weights" attached to utility functions for social interest groups. Even in this case, consensus among people, expressed as the relative optimal weights, had to be brought about by single-level decision making external to the system. In addition, the constraint method is computationally inefficient.

The second class of approaches can clearly articulate preferences among many objective functions. Goal programming, as well as the Lexicographic approach, have unique characteristics for setting targets or ordering objectives. They will be excellent methods if priority among targets is clear-cut or the preferences for the objectives have been predetermined. However, the information they provide concerning the best compromise solution is still external to the system; further, they do not enable explicit quantification of value trade-offs.

The third class aims at deriving the preferred solution from a noninferior set by means of interactive processes. Utility functions, or worth functions, are utilized as the criteria for the determination of ordering and for seeking the preferred point among noninferior (Pareto admissible) solutions. This method can also carry out the explicit quantification of value trade-offs among objectives.

### 3.2. Utility Approach for Preference Ordering

In general, the utility functions are a mapping from an  $n$ -dimensional Euclidean space  $E^n$  to  $E^1$  and are regarded as indices or scores to be utilized for numerical measurement of degrees of satisfaction attached to the effectiveness of objective functions. The representation of preference functions has two aspects:

$$(i) \quad \phi : a \rightarrow Y(a), \quad (a \in E^n, Y \in E^m)$$

$$(ii) \quad u : Y(a) \rightarrow R, \quad (R \in E^1)$$

where  $a$  is a direct product set of alternative plans of action.  $Y(a)$  is a vector that expresses a consequence of the action.  $R$  is a magnitude of preference numerically expressed in terms of a real (scalar) value.  $\phi$  is a structural function that describes the structure of the system.  $u$  is called *the multiatribute*



utility function, and has the consequences  $Y(a)$  of an action  $a$  as its attributes. The preferred solutions, as the highest point of the preference, can be explained as follows.

Suppose that we accept a decision making system. The preferred solutions are defined by a point where the Pareto admissible trade-off rates between objectives

$$\left( \lambda_{ij} = \frac{\partial f_i}{\partial f_j} \Big|_{\text{Pareto}} \right)$$

coincide with the social marginal rate of substitution

$$\left( S_{ij} = \frac{\partial f_i}{\partial f_j} \Big|_{\text{social}} \right)$$

supposed to be provided by a decision maker. In two-dimensional objective function space (Figure 1), point E shows the preferred solution in the Pareto admissible frontier. Although points C and D are also in the Pareto frontier, there is not such a coincidence. At point E, the Paretian trade-off rate is larger than the social marginal rate of substitution. This means that, at this point, the decision maker has a smaller evaluation for the trade-off rate than the Paretian shows. At point D, the situation is reversed. Point A and point B are inefficient (inferior) points.

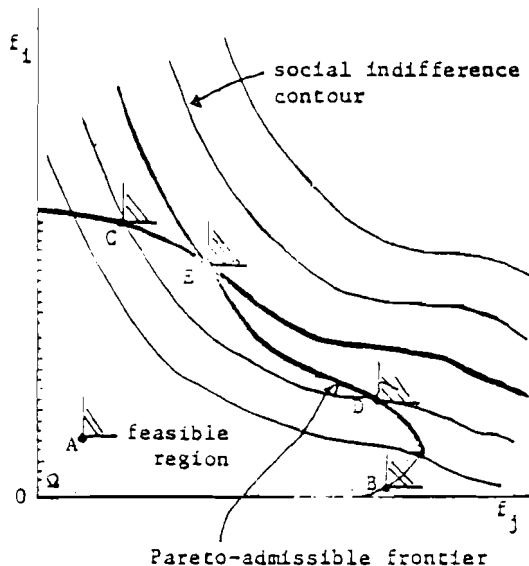

Figure 1. Pareto admissible frontier.

There are two ways to find the preferred solutions with any search procedure. One is to derive a Paretian frontier mathematically, and then to give a worth to each trade-off rate in the frontier. If the evaluation  $S_{ij}$  of the trade-off rate by the decision maker is preferable to the Paretian trade-off rate  $\lambda_{ij}$ , the Paretian trade-off rate will be enhanced along the Pareto frontier, and *vice versa*. Consequently, the point where the trade-off rate for the decision maker coincides with the Paretian trade-off rate will be found. The surrogate worth trade-off (SWT) method, which has been developed by Haines and Hall [4], is based on this approach. They consider the trade-off rates as a function of the present level of objectives, let us call them the trade-off rate functions, and also let us call the worth attached to the trade-off rate function the surrogate worth function. For this method, a precise specification of functional forms and presupposition of their differentiability are required.

The other way of finding the preferred solutions is to find directly the highest point of social preference attached to each performance level of objectives in the feasible region. The problem is formulated as follows

$$\begin{aligned} \max_{x \in \Omega} U[Y_1, Y_2, \dots, Y_m] \\ = [f_1(x_1), f_2(x_2), \dots, f_m(x_m)] \end{aligned} \quad (1)$$

The multiattribute utility function (MUF)  $u$  is a mapping from  $E^m$  to  $E^1$  as stated above.  $Y_i$  ( $i=1, \dots, m$ ) is an attribute of the utility function and is considered as a numerical value of the objective function  $f_i$  which is a mapping from  $E^n$  to  $E^1$ .  $\Omega$  is a feasible region which is a subset of  $E^n$ .  $x_j$  is an  $n$ -dimensional decision vector. In an objectives hierarchy,  $f_i$  itself is usually a utility function. In such cases the problem is to find, in the feasible region  $\Omega$ , a point  $x = (x_1, x_2, \dots, x_q)$  maximizing

$$\begin{aligned} u[u_1(x_1), u_2(x_2), \dots, u_q(x_q)] = u\{u_1[u^1(x_1^1), u^2(x_1^2), \dots, u^s(u_1^s)], \\ u_2[u^{s+1}(u_2^{s+1}), \dots, u^2(x_2^2)], \dots, u_q[u^{r+1}(x_q^{r+1}), \dots, u^m(x_q^m)]\} \end{aligned} \quad (2)$$

where  $x_j$  is a vector whose component is  $x_j^i$ . Probably  $x_j^i$  is also a vector. The procedure for finding an overall multiattribute utility function (2) is called *nesting*. Expression (2) indicates a decomposition of the system into  $q$  subsystems. The nesting procedures can be executed one after another in the objectives hierarchy.

It is not required for this approach to derive the Paretian frontier to obtain the preferred solution. In the process of deriving the multiattribute utility function, it is necessary to weight each utility function with a parameter which is called a scaling constant. The scaling constants are calculated by finding indifferent points between each attribute. Because the

attributes are objectives at a lower level of the objectives hierarchy, the indifference experiments can articulate value trade-offs between the objective functions at the lower level.

Thus, both of these methods for finding the preferred solutions seek the same point—though from different directions—during interactive processes for worth assessment. The multi-attribute utility analysis, which belongs to the latter approach has been developed by Raiffa, Keeney, and others [5, 6, 7, 8] etc. Since, with this method, it is not necessary to obtain any specific identification of the mathematical forms of any of the functions, this method is especially suitable for decision making under uncertainty. However, assumptions of preferential independence and utility independence are required [9]. These assumptions will be fulfilled more satisfactorily under the proper decomposition of systems and with the nesting procedure, which has been suggested.

#### 4. AN ALTERNATIVE UTILITY APPROACH: THE NESTED LAGRANGIAN MULTIPLIER METHOD

An alternative method for systems evaluation using the utility analysis is now proposed. This method is based on an original interpretation of the Lagrangian multipliers as shadow prices.

Consider a general mathematical optimization problem: find a point  $x^*$  to maximize

$$f_i(x) \quad (3)$$

subject to

$$h_j(x) \leq a_j \quad j = 1, \dots, s \quad (4)$$

$$g_k(x) \leq b_k \quad k = s+1, \dots, r \quad (5)$$

$$c_x \leq x_x \leq d_x \quad x = 1, \dots, n \quad (6)$$

where the constraint (4) corresponds to a target constraint imposed by the decision maker, the constraint (5) a technical constraint given by technological conditions,  $x$  is an  $n$ -dimensional vector whose components are decision variables and  $f_i(x)$  is an objective function. The subscript  $i$  shows a problem number. In the stratified multiple-objective decision system, a set of mathematical programming formulations will be applied at the lower level. That is, the multiple-objective (vector optimization) problem in the overall system is decomposed into many single-objective (scalar optimization) problems (3) and (6) as subsystems in a separable form at the lower level. In these independent subproblems, the target constraint will be obtained from the upper level by the decision maker. Therefore, the target constraints themselves can be regarded as the objectives at the upper level in a multiechelon system.

At the optimum situation, the Lagrangian multiplier  $\lambda_{ij}$ , corresponding to the  $j$ th target constraint in the  $i$ th problem, can be interpreted as the incremental prices of constraint requirements measured in units of the objective. In other words, the Lagrangian multiplier  $\lambda_{ij}$  shows a marginal unit of the target constraint constant  $a_j$  to be traded-off for one additional unit of the objective function  $f_i$ . This interpretation coincides with that of Luenberger [10]. The  $\lambda_{ij}$  correspond to the opportunity cost or the shadow price. The larger  $\lambda_{ij}$ , the smaller the opportunity cost of  $a_j$ , measured in terms of one marginal unit of sacrifice of  $f_i$ . This means that, in the present conditions, the degree of satisfaction for the performance level of  $a_j$  is already high. Conversely, the smaller  $\lambda_{ij}$ , the larger the opportunity cost of  $a_j$ , measured in terms of a marginal unit of  $f_i$ . This means that the degree of satisfaction for the present level of the performance of  $a_j$  is still low.

Based on this interpretation of the Lagrangian multipliers in the optimum situation, they are herein utilized for worth assessment of the system whose property has been described in the mathematical programming formulation. The evaluation procedure is as follows:

*Step 1.* Devising a preference hierarchy corresponding to an objectives hierarchy. This step is composed of decomposition of objectives and their stratification. In stratified systems, decision making is more concrete and more controllable at lower levels, and more complicated and less controllable at higher levels.

*Step 2.* Devising a mathematical programming formulation for each subsystem at the lower level of the stratified system.

*Step 3.* Calculation of the shadow prices and their utilization as measures of the effectiveness of the constraint requirements.

*Step 4.* Conversion of scale for the Lagrangian multipliers into a single-attribute utility function. For the utility function, numerical values of utilities are in the range from 0 to 1.

*Step 5.* Nesting of the utility functions into multiattribute utility functions.

*Step 6.* Derivation of an overall regional utility function.

Step 3 results in solving the standard mathematical programming problems. In step 4, because the numerical valuation of utilities is determined up to linear transformation [11], the conversion of scale will be linear. The scaling method is depicted in Figure 2 [13]. For steps 5 and 6, the multiattribute utility function method by Raiffa, Kenney, and others can be applied.

We call this method the revised multiattribute utility function method or the *Nested Lagrangian Multiplier (NML) Method*.

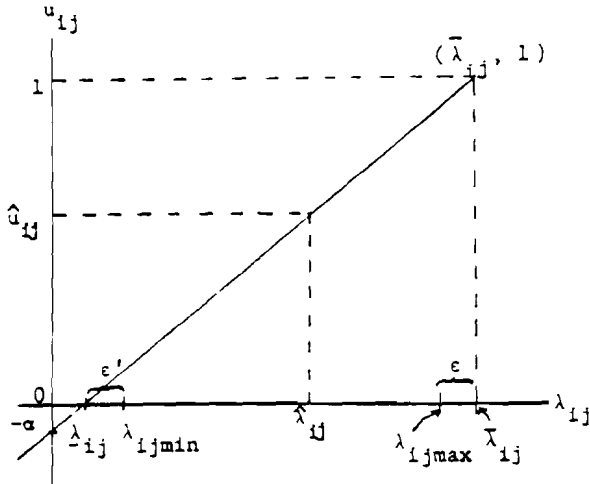

Figure 2. Scaling of the shadow prices.

#### 4.1. Remark 1

Although our method has similar characteristics both to the SWT method and the MUF method, it also has several different properties.

In solving a multiobjective optimization problem, although the SWT method considers the problem as a vector optimization problem, in practice it treats all the objective functions, except one, as constraints in the problem. In consequence, the Lagrangian multipliers are interpreted as the trade-off rate function between the objectives. The worth assessment is indirectly given to the trade-off function instead of the objective functions. In our method, from the beginning, based on the construction of a hierarchical modeling, a vector optimization problem is treated as a set of scalar optimization subproblems at the lower level. Further, each subproblem itself is considered to represent a composite of multilevel objectives. Ijili presented this idea first [12]. According to the problem formulation of systems, the Lagrangian multipliers are utilized for measurement of the performance of upper level objectives in terms of lower level objectives in the multiechelon systems. The worth assessment is *directly* given to the Lagrangian multipliers. The device for deriving the utility concept from the Lagrangian multipliers is simply the conversion of scale. In actual environmental systems, on the other hand, the introduction of decision making in

terms of judgement probability is inevitable. In view of this fact, at the upper level of a stratified system, we try to nest the single-attribute utility functions, which have been converted from the Lagrangian multiplier into the multiattribute utility function. In this process, the utilization of the Lagrangian multipliers for derivation of the single-attribute utility function will greatly reduce the interderminateness and the arbitrariness in the first stage of worth assessment. Because numerical ranges to be taken by the single-attribute utility functions are restricted from 0 to 1 in the NLM method, the indifference experiments in the process of derivation of the multiattribute utility function can be executed more efficiently with this method.

#### 4.2. Remark 2

The Lagrangian multipliers which have been utilized as the inverse image of (single-attribute) numerical utilities have a preference relation among their numerical values as well as an operation (linear convex combination) with a parameter  $\alpha$ . Namely, according to Neumann-Morgenstern theory [15], the existence of a real number  $S$ , which has the following properties, can be postulated:

- (i) weak ordering†
- (ii)  $S(\lambda^1) \geq S(\lambda^2)$  if and only if  $\lambda^1 \geq \lambda^2$
- (iii)  $S[\alpha\lambda^1 + (1 - \alpha)\lambda^2] = \alpha S(\lambda^1) + (1 - \alpha) S(\lambda^2)$

where  $\lambda^1, \lambda^2$  are two distinct values of the Lagrangian multipliers, and where ">" means "preferred to" and "=" means "indifferent to." Based on our interpretation of the Lagrangian multiplier, it can be supposed that  $S(\lambda^z) = \lambda^z$ .

The real number  $S$  can be linearly transformed to the numerical utility concept which has the same properties. For the numerical utility, although differences between utilities are numerically measurable, the position of the origin and unit of a numerical scale for the utilities can be arbitrarily decided.

In the following section, according to the procedure composed of step 1 and step 6 which has been described in this section, the nested Lagrangian multiplier method will be demonstrated for a case of environmental systems planning in the Osaka area.

---

†Weak ordering is the preference relation that satisfies the following axioms:

- (i) Transitivity: if  $A \geq B$  and  $B \geq C$  then  $A \geq C$
- (ii) Connectivity:  $A \geq B$  or  $B \geq A$

## 5. DEMONSTRATION OF THE NLM METHOD

### 5.1. Objective Area

The middle of Osaka prefecture is one of the most highly industrialized areas of Japan. This area faces Osaka Bay and is located between the Yodo river and the Yamato river basins (Figure 3). The Yodo river has many branches. The largest one of them is the Kanzaki river, which defines a boundary between Osaka and Hyogo prefectures. Osaka City, which is the second largest industrial and commercial area in Japan, is located between the Kanzaki and the Yamato rivers, and has many small city rivers that are branches of the Yodo river. The Neyu river passes through newly industrialized areas in the East Osaka district. The Neyu river also has many small branches, and runs down into the city rivers. Playing the role of a network of sewers, these rivers and their branches finally stream down into Osaka Bay. The bay is a part of the Inland Sea, which is the most important fishery area in Japan. Furthermore, the Yodo river is an important source of drinking water for residents near Osaka. Thus, the water pollution in the Yodo river basin has become increasingly serious along with the rapid industrial development since 1960. Air pollution is also at a critical level inside and outside of Osaka City. In addition, water supply capacity is limited in these areas. Although the sixth expansion program of the Osaka public water supply expanded capacity by more than 11 percent in 1975, the water resource problem should still be taken into consideration. This is because, although the city's water supply depends heavily on Lake Biwa and the Yodo river (which flows out of the lake), the water in Lake Biwa and the upper part of the Yodo river is drawn on for water services by other prefectures as well.

The limitations of land use in and near Osaka are obvious, since it is one of the most densely populated areas in Japan.

In addition to the overconcentration of industries in the Osaka region, new settlements and the transfer of plants to newly developed areas in the region have raised the problem of equity of income distribution, because such moves have often been motivated by the desire of industries to lower employees wages.

### 5.2. Devising the Objectives Hierarchy

A hierarchical system in the industrialized Yodo river basin areas is shown in Figure 4. This system is composed of two layers. In the first layer, mathematical programming models are formulated. In the second layer, decision analysis is applied. The regional authority sends criteria for environmental control to the first layer. These criteria are given as constraint constants.

In devising this hierarchical system, a functional decomposition as well as a regional decomposition has been carried out. First, the industrial area has been decomposed into Osaka City and the East Osaka area, which is composed of three small cities; Yao, Daito, and Higashi Osaka. Secondly, the environmental control

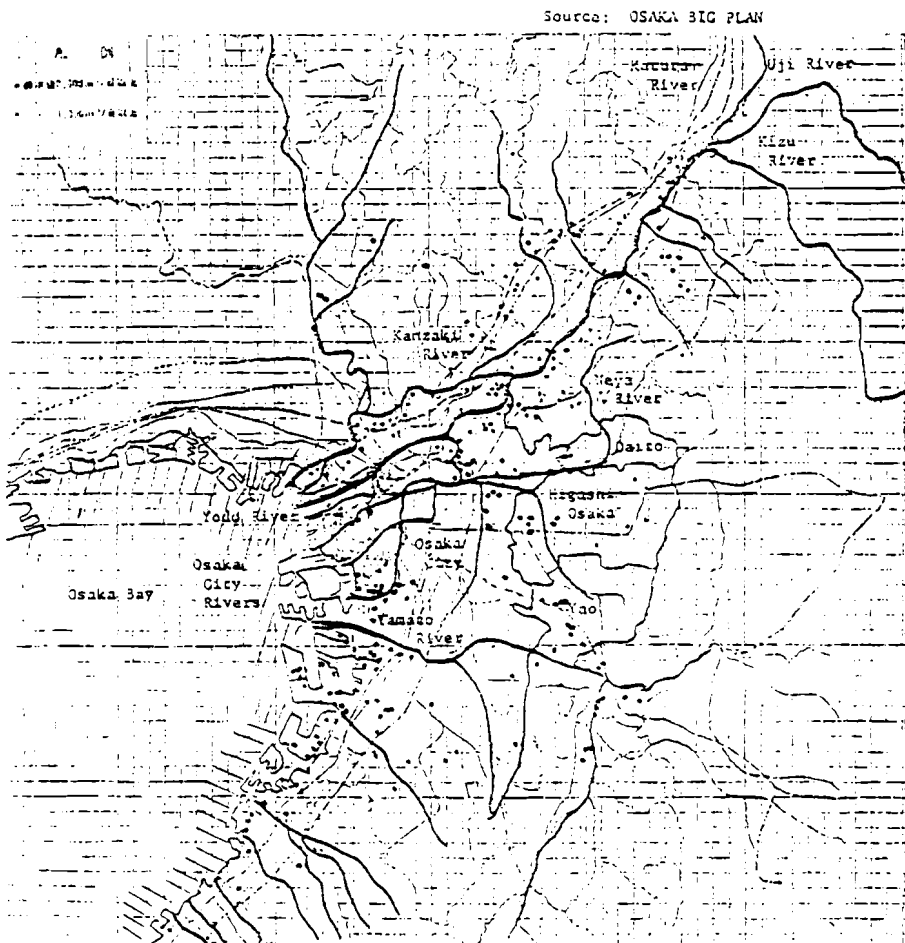

Figure 3. Major sources of water pollution in Osaka prefecture, 1970.



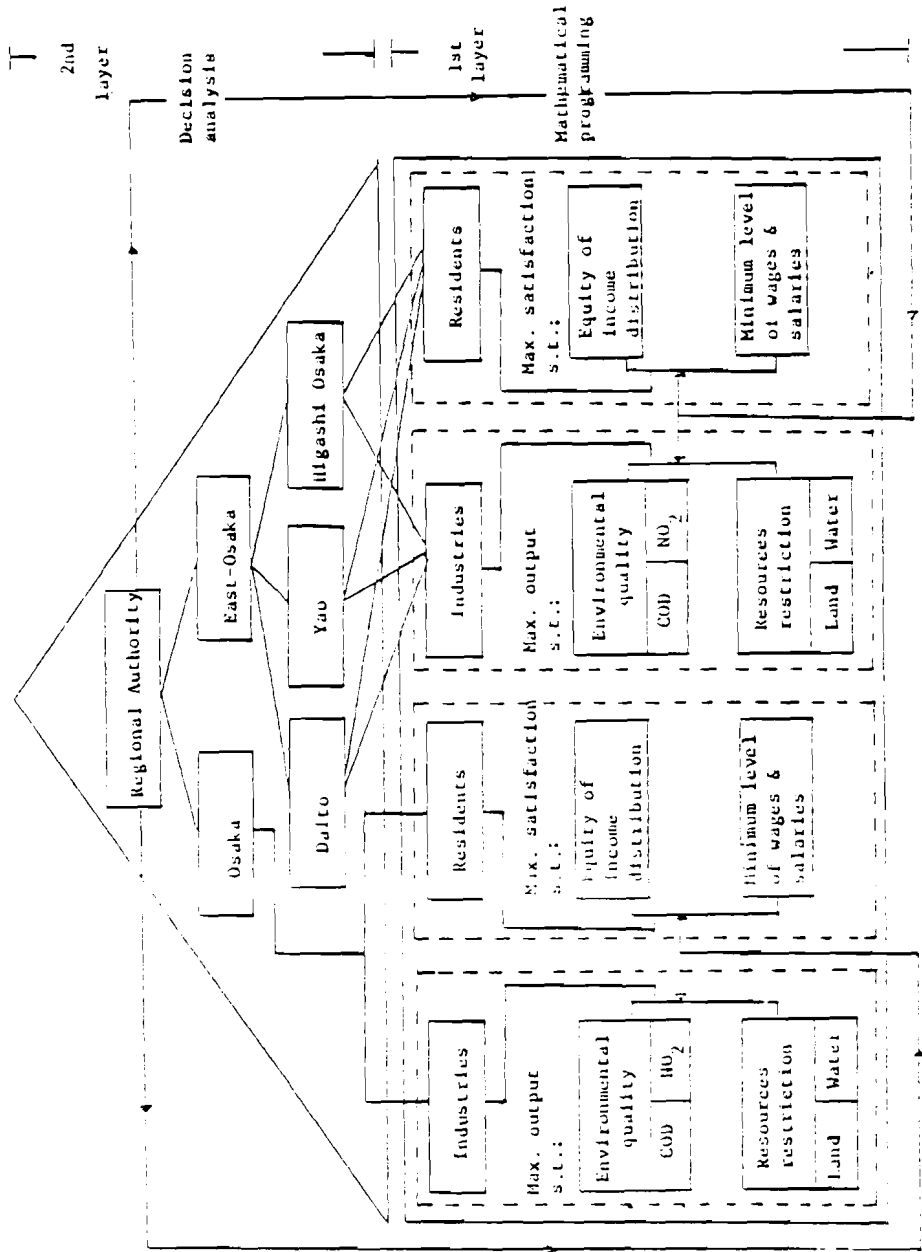

Figure 4. A hierarchical environmental system in the industrialized Yodo river basin.

planning in each city has been divided into industrial problems and residential problems. In the industrial problems, industrial agencies will be interested in maximizing the output of each industry in the region. In the residential problems, the residents, whom we have treated as the "day-time" population, or wage (and salary) earners, will be concerned with maximizing psychological satisfaction from their earnings. The decision maker should place some restrictions on their activities in view of social considerations. For this purpose, environmental quality standards and resources restrictions for the industrial problems, as well as the criteria of economic equity and minimum payment for the residential problems, have been introduced.

## 5.2. Problem Formulation and Computational Results

In the first layer, a mathematical programming problem is formulated. The regional problem for residents in each region is as follows. Maximize

$$f(w) = \sum_{j=1}^n (K - AB^{w_j}) \quad (7)$$

subject to

$$w_j \geq b_j \quad j = 1, \dots, n \quad (8)$$

$$\sum_{j=1}^n |w_j - \bar{w}| \leq v \quad (9)$$

where

- $j$  — industries
- $w_j$  — wages and salaries per employee per year (decision variable)
- $b_j$  — actual value of wages and salaries in 1974
- $\bar{w}$  — actual mean value of the unit payment in all the industries
- $v$  — the sum of the deviations from the actual mean value of wages and salaries

$K, A, B$  — parameters.

Constraint (8) is minimum requirement for wages and salaries in each industry, and constraint (9) is the equity requirement among all the industries. For the objective function, a modified exponential curve has been estimated.

$$f(w) = \sum_{j=1}^n (1.0102 - 0.9926 \times 0.76808^{w_j}) \quad (10)$$

For this problem, primal and dual optimal solutions have been obtained. Then the conversion of the Lagrangian multipliers into the single-attribute utility functions has been performed. An interpretation for numerical values of these utility functions has been presented in a previous paper, where using these single-attribute utility functions as components, the following multi-attribute utility functions have been derived [13].

*Utility Functions for the Residential Problem:  $U_R$*

*Osaka City*

$$U_{OSR} = \frac{1}{0.61} [(1 + 0.43 u_{OSm})(1 + 0.13 u_{OSe}) - 1] \quad (11)$$

*East Osaka area*

*Yao*

$$U_{YAR} = \frac{1}{21.1} [(1 + 19.0 u_{YAm})(1 + 0.95 u_{YAe}) - 1] \quad (12)$$

*Daito*

$$U_{DAR} = \frac{1}{0.31} [(1 + 0.25 u_{DAm})(1 + 0.05 u_{DAe}) - 1] \quad (13)$$

*Higashi Osaka*

$$U_{HGR} = \frac{1}{0.12} [(1 + 0.11 u_{HGm})(1 + 0.01 u_{HGe}) - 1] \quad (14)$$

where  $U_m$  is the utility function for the minimum wage requirement and  $U_e$  is for the equity requirement.

The industrial pollution control problem in each region is formulated as follows. Maximize

$$\sum_j f_j (K_j, L_j) = \sum_j (A_j K_j^{a_j} L_j^{b_j}) \quad (15)$$

subject to

$$\sum_j (w_{ij}/c_j) \tilde{K}_j \leq \bar{r}_j \quad (16)$$

$$\sum_j K_j / \sum_j L_j \leq \gamma \quad (17)$$

$$\alpha \tilde{K}_j \leq K_j \leq \beta \tilde{K}_j \quad (18)$$

$$\alpha' \tilde{L}_j \leq L_j \leq \beta' \tilde{L}_j \quad (19)$$

where

$j=1, \dots, n$  — industries

$i=1, \dots, 4$  — environmental factors (CO<sub>2</sub>, SO<sub>2</sub>, land and water)

- $K_j$  — capital value (book value of tangible fixed assets)  
 $L_j$  — number of employees  
 $w_{ij}$  — discharge of requirement of the environmental factor  $i$  per unit of shipments in the industry  $j$   
 $\kappa_j$  — capital coefficient, i.e., capital value per unit of shipments in the industry  $j$   
 $\tau_i$  — restriction or target level for the  $i$ th environmental element  
 $\gamma$  — actual overall capital intensity (ratio of total capital value to total number of employees)  
 $A_j, a_j, b_j$  — parameters in production functions for each industry  
 $\alpha, \beta, \alpha', \beta'$  — parameters that represent friction (resistance) for transfer of capital and labor ( $0 \leq \alpha, \alpha' \leq 1$ ;  $1 \leq \beta, \beta'$ ).

The objective function is a Cobb-Douglas-type production function. The function is homogeneous of degree one (i.e.,  $a_j + b_j = 1$ ). This means that if each factor is paid its marginal product, then the total output is distributed between labor and capital in respective proportions  $a_j$  and  $b_j$ . Constraint (16) is the target constraint and shows that the total amount of any environmental factor discharged or required by each industry shall not exceed a restriction imposed by the decision maker. Constraint (17) is the technical constraint. This constraint is also utilized for avoiding high levels of unemployment as a result of technological change occurring along with the reformation of industrial structure in each region. Constraints (18) and (19) are frictional constraints. Since drastic changes in the industrial structure are not desirable, frictional coefficients are imposed on each decision variable. They provide upper and lower bounds for the decision variables.

For case I of the industrial pollution control problem in Osaka City, parameter for capital  $\alpha$  has been supposed to be 0.5 and for  $\beta$  to be 1.5. The parameter for labor  $\alpha'$  has been supposed to be 0.6 and that for  $\beta'$  to be 1.4. The difference between fractional coefficients for capital and labor has been introduced because of the fact that it will be more difficult for laborers to adapt to unfamiliar industries. In all the other problems, it has been assumed that  $\alpha = \alpha' = 0.4$  and  $\beta = \beta' = 1.6$ . Thus in case I in Osaka, more drastic change of the industrial structures has been permitted.

The problem is to find optimal allocation of the production factors (capital and labor) among each industry, under the above restrictions.

Environmental restrictions in the target constraints are shown in Tables 1 and 2. Sources for data in the tables, as well as parameters in the problem formulations, have been obtained mainly from the *Industrial Statistics Survey Result Table of Industrial Statistics in 1974* published by the Statistical Office of Osaka prefecture, *Census of Manufactures: 1973 Report on Industrial Land and Water* published by the Research and Statistics Department, Minister's Secretariat, Ministry of International Trade and Industry, and the *Input-Output Table for Industrial Pollution Analysis in the Kinki Area in 1973* published by the Osaka Bureau of Trade and Industry. All the data have been published in Japanese.

In solving the nonlinear optimization problems, the augmented Lagrangian method proposed by Pierre and Lowes [14] has been utilized. Computational results for the industrial pollution control problem are as follows.

First, the dual optimal solutions  $\lambda$  in each region and the utility functions  $u(x)$ , which are converted from  $\lambda$ , are presented in Table 3. The diagnosis based on the numerical results is given in Table 4.

In Osaka, for example, the satisfaction levels for meeting of the environmental restrictions, measured in terms of production functions, are the highest for water use. In case II, Osaka and Yao, the meeting of environmental standards for COD will be the most troublesome. In Daito the restriction for COD has been relaxed. The satisfaction level for environmental restriction is the highest for COD in this region. In Higashi Osaka, by contrast, the environmental restriction for  $SO_2$  is the most rigorous. In consequence, the utility level for  $SO_2$  is the worst in Higashi Osaka. In case I of Osaka City, the utility level for  $SO_2$  is also the worst. However, in case II, the restriction for COD is more exacting than that for  $SO_2$ . Restrictions for both elements are much more rigorous for Osaka than for other regions. In case II, however, it will be noted that the limitation onland is more troublesome than for  $SO_2$ . Characteristics of technological changes which will accompany the environmental management policy can also be made clear. Capital-saving technological change will be induced more drastically in Osaka than in the East Osaka district.

Secondly, the primal solutions for decision variables  $K_i^*$  and  $L_i^*$  are acquired. They show the optimal allocation of capital and labor to each industry. Reallocation plans for capital in each region are presented in Tables 5 to 8. Code numbers for industrial classification are explained in Table 9. These results have common characteristics. Capital formation in the iron and steel industry, as well as in the chemicals and related products industry, should be dramatically reduced. In addition, the nonferrous metals industry and the fabricated metal product industry should decrease their capital formation in Osaka. On the other hand, in consumer industries, such as clothing products, lumber products, and furniture industries, as well as in machine industries, such as the electrical machinery industry, capital formation should be promoted. In the East Osaka district, capital investments in other machine industries, such as general machinery and precision machinery industries, are recommended.

Table 1. Environmental restrictions

	COD (ton/year)	SO <sub>2</sub> (ton/year)	Land (100m <sup>2</sup> )	Water (1000m <sup>3</sup> )
Osaka				
Case I	84,095	62,250	156,065	150,923
Case II	95,227	70,060	171,253	173,561
Yao	9,864	6,358	25,544	14,600
Daito	2,194	1,917	13,904	7,980
Higashi				
Osaka	11,824	10,417	58,162	33,382

Table 2. Reduction rates from current conditions in 1973.

	COD (%)	SO <sub>2</sub> (%)	Land (%)	Water (%)
Osaka				
Case I	47.0	46.0	9.0	0.0
Case II	40.0	40.0	0.0	+15.0
Yao	32.75	20.0	5.0	+15.0
Daito	25.0	20.0	5.0	+15.0
Higashi				
Osaka	32.75	27.0	5.0	+15.0

Table 3. Assessment of utility for environmental control.

	COD	SO <sub>2</sub>	Land	Water
Osaka City				
Case I	$\lambda$ 2.1642	0.9474	0.0	37.5866
	$\mu$ 0.0323	0.0012	-0.0230	0.9383
Case II	$\lambda$ 0.2275	14.4730	4.7484	30.3245
	$\mu$ 0.0008	0.4101	0.1307	0.8656
East Osaka district				
Yao	$\lambda$ 0.0000	11.5712	8.1213	6.1050
	$\mu$ 0.0	0.7714	0.5414	0.4070
Daito	$\lambda$ 10.9544	0.9618	7.2767	0.0
	$\mu$ 0.7121	0.0008	0.4503	-0.0676
Higashi	$\lambda$ 15.5528	0.1605	7.0646	9.1199
Osaka	$\mu$ 0.7760	0.0005	0.3483	0.4519

Table 4. Diagnosis.

	Satisfaction Level		Slackness	Tech. Change Capital Saving
	Minimum	Maximum		
Osaka				
Case I	SO <sub>2</sub>	Water	Land <sup>†</sup>	Drastic
Case II	COD	Water	0	Drastic
Yao	COD	SO <sub>2</sub>	0	Medium
Daito	SO <sub>2</sub>	COD	Water <sup>††</sup>	Medium
Higashi				
Osaka	SO <sub>2</sub>	COD	0	Medium

† 32.54 (100m<sup>2</sup>)†† 1025.56 (1000m<sup>3</sup>/year)

Table 5. Capital reallocation plan for Osaka City.

Industry Code	1974		Proposal: Case I		Proposal: Case II	
	Capital†	%	Capital†	%	Capital†	%
18.19	29,409	4.43	14,704	3.69	17,645	4.09
20	21,375	3.22	10,687	2.68	12,825	2.97
21	8,423	1.27	12,634	3.17	6,273	1.45
22	13,873	2.09	20,808	5.23	18,456	4.28
23	8,474	1.28	12,711	3.19	11,864	2.75
24	36,375	5.49	18,187	4.57	21,825	5.06
25	66,016	9.96	37,401	9.39	39,610	9.18
26	80,134	12.08	40,066	10.06	48,080	11.14
27	1,327	0.20	633	0.17	796	0.18
28	4,414	0.67	2,207	0.55	2,649	0.61
29	3,709	0.56	1,854	0.47	2,225	0.52
30	14,496	2.19	7,247	1.82	8,697	2.01
31	102,399	15.44	51,199	12.86	61,439	14.23
32	28,008	4.22	14,003	3.52	16,805	3.89
33	69,314	10.45	34,657	8.70	41,589	9.63
34	90,014	13.57	56,049	14.08	54,008	12.51
35	29,360	4.43	35,113	8.82	33,286	7.71
36	27,687	4.18	13,843	3.48	16,612	3.85
37	4,009	0.60	2,004	0.50	2,405	0.56
38	—	—	—	—	—	—
39	24,323	3.67	12,161	3.05	14,594	3.38
Total	663,139	100.00	398,198	100.00	431,683	100.00
Industrial Shipment Total	4,688,855	Base	3,351,800	(-)28.5	3,556,930	(-)24.1
% of Osaka prefecture	35.67		25.5		27.06	

† Million yen.

Table 6. Capital reallocation plan for Yao.

Industry Code	Capital: 1974		Capital: Proposed	
	(million yen)	(%)	(million yen)	(%)
18.19	5,033	7.78	3,830	5.63
20	1,619	2.50	971	1.43
21	223	0.34	312	0.46
22	310	0.48	434	0.64
23	697	1.08	976	1.43
24	4,655	7.19	2,793	4.10
25	998	1.54	599	0.88
26	2,800	4.33	1,680	2.47
27	—	—	—	—
28	—	—	—	—
29	193	0.30	116	0.17
30	1,229	1.90	737	1.08
31	2,398	3.71	1,439	2.11
32	3,498	5.40	4,683	6.88
33	10,267	15.86	9,919	14.57
34	9,223	14.25	11,369	16.70
35	9,612	14.85	13,457	19.76
36	2,465	3.81	1,479	2.17
37	2,961	4.58	4,145	6.09
38	—	—	—	—
39	6,538	10.10	9,154	13.44
Total	64,719	100.00	69,093	100.00
Industrial Shipment Total	414,812	(base)	454,474	9.6
% of Osaka prefecture	3.16		3.46	



Table 7. Capital reallocation plan for Daito.

Industry Code	Capital: 1974		Capital: Proposed	
	(million yen)	(%)	(million yen)	(%)
18.19	—	—	—	—
20	1,099	4.04	659	2.44
21	—	—	—	—
22	91	0.33	128	0.47
23	473	1.74	662	2.45
24	938	3.45	563	2.08
25	627	2.30	376	1.39
26	850	3.12	510	1.88
27	—	—	—	—
28	523	1.92	705	2.61
29	—	—	—	—
30	977	3.59	586	2.17
31	3,601	13.23	2,617	9.67
32	817	3.00	1,143	4.22
33	2,584	9.49	2,905	10.73
34	6,423	23.59	5,016	18.54
35	5,002	18.37	7,003	25.88
36	398	1.46	239	0.88
37	—	—	—	—
38	—	—	—	—
39	2,821	10.36	3,949	14.59
Total	27,224	100.00	27,061	100.00
Industrial Shipment Total	225,334	(Base)	257,625	14.1
% of Osaka prefecture	1.72		1.96	

Table 8. Capital reallocation plan for Higashi Osaka.

Industry Code	Capital: 1974		Capital: Proposed	
	(million yen)	(%)	(million yen)	(%)
18.19	3,106	2.53	1,864	1.50
20	2,036	1.66	1,222	0.99
21	894	0.73	609	0.49
22	508	0.41	711	0.57
23	3,281	2.67	4,594	3.71
24	4,967	4.04	2,980	2.41
25	4,683	3.81	2,810	2.27
26	3,571	2.91	2,143	1.73
27	—	—	—	—
28	322	0.26	193	0.16
29	259	0.21	155	0.13
30	—	—	—	—
31	15,844	12.90	9,910	8.00
32	8,100	6.60	5,430	4.38
33	23,735	19.33	27,872	22.50
34	20,100	16.37	26,130	21.09
35	6,903	5.62	9,664	7.80
36	8,872	7.22	5,730	4.63
37	1,204	0.98	1,685	1.36
38	—	—	—	—
39	14,414	11.74	20,179	16.29
Total	122,799	100.00	123,881	100.00
Industrial Shipment Total	944,655	(Base)	977,408	3.5
% of Osaka prefecture	7.19		7.44	

Table 9. Classification of industries.

Code	Industries
18.19	Foods
20	Textile mill products
21	Clothing products
22	Lumber and products
23	Furniture
24	Pulp and paper products
25	Printing and publishing
26	Chemicals and products
27	Coal and petroleum products
28	Rubber products
29	Leather products
30	Clay and stone products
31	Iron and steel
32	Nonferrous metals
33	Fabricated metal products
34	Machinery
35	Electrical machinery
36	Transportation equipment
37	Precision machinery
38	Ordnance
39	Miscellaneous

In total, capital values in all the industries will be greatly reduced in Osaka. Although capital-saving technological changes will be made, industrial shipments in Osaka City will also decrease drastically (by 24-28 percent). On the other hand, in the East Osaka district, capital value will increase. As a result, a transfer of labor from Osaka to the East Osaka district will take place. Increase of industrial shipments in this area will cover about 7.8-9.2 percent of the reduction in Osaka City. Because Osaka prefecture is composed of 31 cities, 11 towns and two villages, development of other areas in Osaka prefecture will make it possible to compensate for almost all of the loss of industrial shipments in Osaka City. This kind of industrial reallocation plan (a set of primal optimal solutions) is considered to be hidden behind the evaluation of environmental management plans (asset of dual optimal solutions). The reason is that, although our main concern is with the evaluation of numerical utility to be attributed to the environmental management plan, recognition of the industrial reallocation plan which is attached to the management plan will still attract the attention of policy makers.

Thirdly, we proceed to obtain the multiattribute utility functions through the nesting procedure. The multiattribute utility functions for industrial pollution control in each region are as follows:

Utility Functions for Industrial Pollution Control Problem:  $u_{IN}$

Osaka City

$$U_{OSIN} = \frac{1}{-0.8268} [(1 - 0.6614 u_{COD})(1 - 0.264 u_{SO_2})(1 - 0.1984 u_{land})(1 - 0.1323 u_{water}) - 1] \quad (20)$$

East Osaka district

Yao

$$U_{YAIN} = \frac{1}{-0.8871} [(1 - 0.2395 u_{COD})(1 - 0.07984 u_{SO_2})(1 - 0.7984 u_{land})(1 - 0.1996 u_{water}) - 1] \quad (21)$$

Daito

$$U_{DAIN} = \frac{1}{-0.6704} [(1 - 0.5363 u_{COD})(1 - 0.1073 u_{SO_2})(1 - 0.1341 u_{land})(1 - 0.0804 u_{water}) - 1] \quad (22)$$

Higashi Osaka

$$U_{HGIN} = \frac{1}{-0.5855} [(1 - 0.1317 u_{COD})(1 - 0.4391 u_{SO_2})(1 - 0.1098 u_{land})(1 - 0.0439 u_{water}) - 1] \quad (23)$$

Combining the multiattribute utility functions for residents with these ones for the industrial control problem, the composite utility functions for both problems are derived. Examples of the indifference experiment for finding the scaling constants are shown in Figure 5.

Utility Functions for Residential Problem and Industrial Pollution Control Problem:  $U_R$ ,  $U_{IN}$  in Each Region

Osaka City

$$U_{OS} = \frac{1}{0.1020} [(1 + 0.02856 U_{OSR})(1 + 0.714 U_{OSIN}) - 1] \quad (24)$$

East Osaka district

Yao

$$U_{YA} = \frac{1}{0.3125} [(1 + 0.05 U_{YAR})(1 + 0.25 U_{YAIN}) - 1] \quad (25)$$

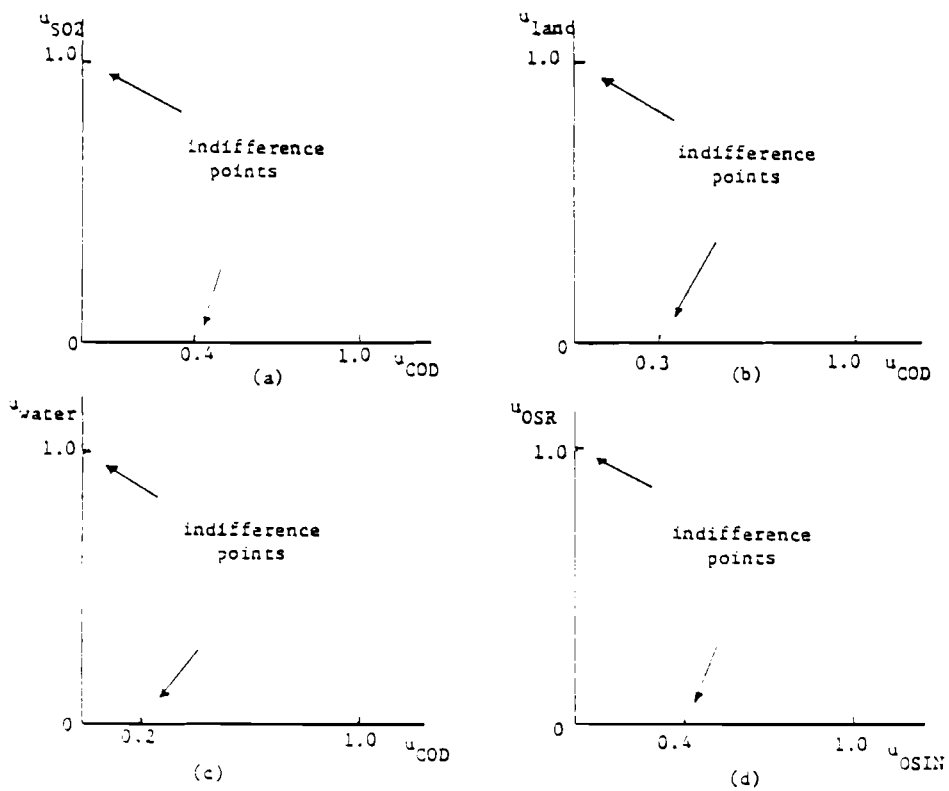

Figure 5. Trade-offs for environmental elements in Osaka City.

*Daito*

$$U_{DA} = \frac{1}{0.2076} [(1 + 0.0265 U_{DAR}) (1 + 0.1765 U_{DAIN}) - 1] \quad (26)$$

*Higashi Osaka*

$$U_{HG} = \frac{1}{0.1481} [(1 + 0.0333 U_{HGR}) (1 + 0.1111 U_{DAIN}) - 1] \quad (27)$$

An overall regional utility function is now derived using the above composite utility functions in each region.

*Overall Utility Functions:  $U_{EO}, U$*

*East Osaka district:  $U_{EO}$*

$$U_{EO} = \frac{1}{0.6406} [(1 + 0.5125 U_Y) (1 + 0.05765 U_{DA}) (1 + 0.0256 U_{HG}) - 1] \quad (28)$$

*Overall region:  $U$*

$$U(U_{EO}, U_{OS}) = \frac{1}{0.3125} [(1 + 0.25 U_{OS}) (1 + 0.05 U_{EO}) - 1] \quad (29)$$

Numerical values of these utility functions are now calculated in the preference hierarchy corresponding to the objectives hierarchy. Results are shown in Figure 6. We find the following characteristics in the hierarchical system:

(i). In general, utility levels for residential problems are lower than those for industrial pollution control problems. Above all, the satisfaction levels for minimum wages and salaries are the worst in each region.

(ii). The satisfaction levels in Osaka City are generally lower than in the East Osaka district. In the latter area, Higashi Osaka, which has come to resemble Osaka City, has the lowest overall level of satisfaction. The lowest level of satisfaction for a residential problem, in Yao, is a result of the low level of minimum wages and salaries in the region.

(iii). The poor satisfaction level for residents in Osaka City has been caused by the low level of economic equity in the city. In contrast to Osaka City, residents in the East Osaka district are the most satisfied from the viewpoint of equity. Within the district, Daito, whose development has been the most rapid, has the lowest utility level for equity.

(iv). With regard to resource restrictions, the utility level for land limitation in Osaka City is the worst among all the resources in either region.

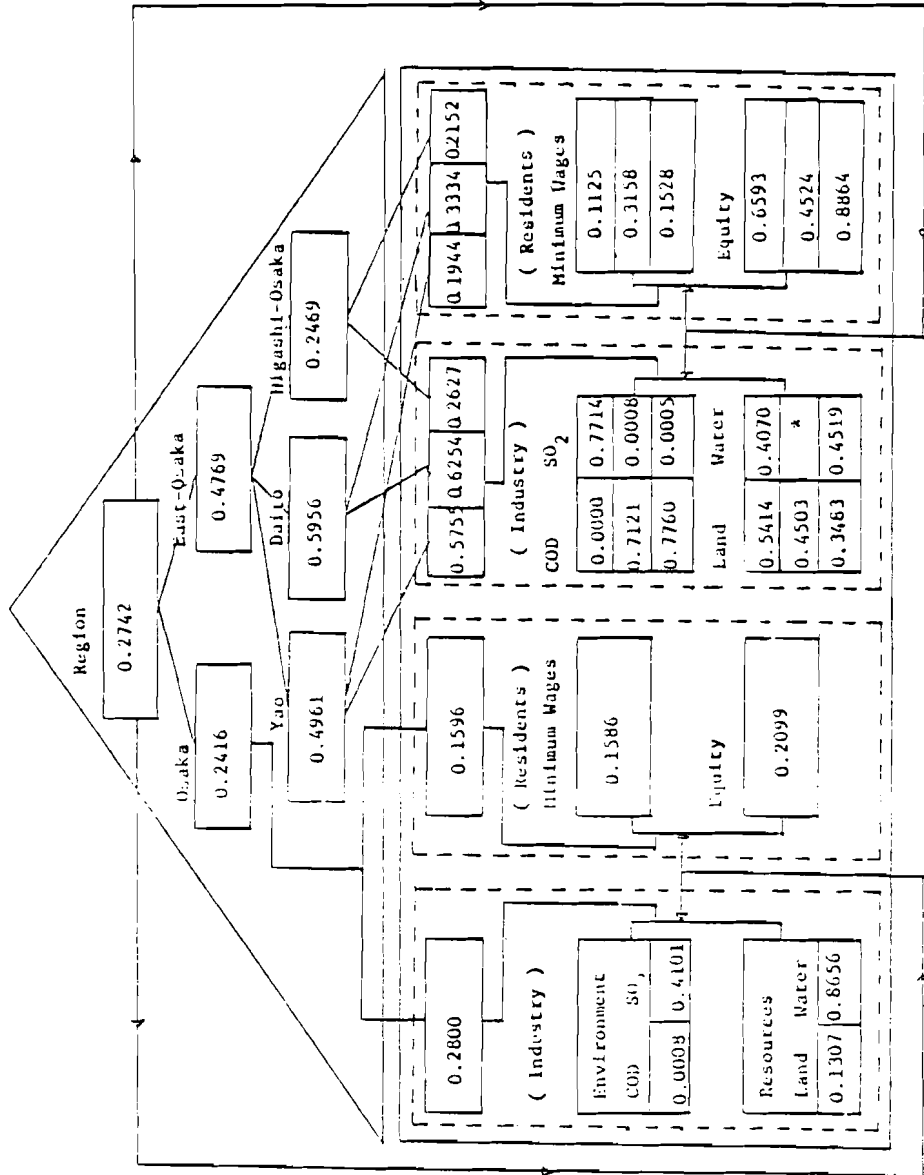

Figure 6. Regional utility assessment in industrialized Yodo river basin area.

The above properties coincide with the common understanding of the present situation in the Kinki area.

(v). Finally, we regard the above conclusions as a reference for decision support. That is, the numerical results of the utility assessment will indicate places where difficulties to be resolved exist. Low values of satisfaction level which exist in the environmental control systems will be sought out, and some proposals for resolving the problems will be presented; or, at the very least, the existence of problems faced in the control systems will be suggested. For example, raising of minimum wage levels, undertaking of public works for environmental control, and promotion of technological development for pollution prevention in specific fields are recommended to the decision makers. The end result is to clarify priorities for environmental policies, with preservation of minor elements.

## 6. CONCLUDING REMARKS

We are concerned with the practical applicability and effectiveness of extremal methods for the social sciences. In the socioeconomic field, data bases are often quite unreliable. Generally, analytic functions cannot be strictly applied for socioeconomic analysis. At most, only approximations to the analytic functions are applicable. Convexity assumptions are inapplicable in many cases.

In addition to the characteristics of modeling in the socioeconomic field, many of the optimal solutions obtained using extremal methods tend to go to extremes at zero values or upper and lower bounds. Because these bounds may be imposed on decision variables arbitrarily, this kind of solution will not always be desirable or practicable for socioeconomic analysis. On the other hand, socioeconomic models will inevitably have tremendous numbers of decision variables and constraints if the modeling becomes very large-scale and complex. This means that the computational time will be formidable.

In this paper, although some computational results have been presented, it has been suggested that direct utilization of primal optimal solutions in terms of absolute scale will be problematic in the social sciences. The solutions should be utilized only as a reference for policy proposal. For this purpose, utilization of dual optimal solutions for extremal methods in terms of relative scale (interval scale) is highly recommended. In other words, the interpretation and utilization of dual optimal solutions (*shadow prices*) will have much significance.

We have proposed the utilization of shadow prices as a device for evaluation of environmental control systems and the inclusion (nesting) of them in multiattribute utility functions. It has been shown that this method—the nested Lagrangian multiplier method—will satisfactorily fulfil the criteria for effective methods for environmental systems analysis.



In the computational processes, utilization of the NLM method basically depends on efficiency of derivation of the shadow prices. Although the augmented Lagrangian method which moderates the disadvantages of both penalty and primal-dual methods can obtain the shadow prices efficiently for general nonlinear programming problems, the computation time has still been a burden.

In addition, since the static characteristics of the modeling have placed a restriction on the effectiveness of environmental systems planning (it will vary with economic development in the areas) a dynamic version and application of the NLM method is to be expected.

#### REFERENCES

- [1] Marglin, S.A. (1962) Objectives of water-resource development: a general statement. In Design of Water-Resources Systems, edited by A. Maass et al. Harvard U.P.
- [2] Cohon, J.L., and D.H. Marks (1973) Multiobjective screening models and water resource investment. Water Resources Research.
- [3] Dorfman, R., and H.D. Jacoby (1972) An illustrative model of river basin pollution control. In Models for Managing Regional Water Quality, edited by R. Dorfman, D. Jacoby, and H.A. Thomas, Jr. Harvard U.P.
- [4] Haimes, Y.Y., W.A. Hall, and H.T. Freedman (1975) Multiobjective Optimization in Water Resources Systems; The Surrogate Worth Trade-off Method. Elsevier.
- [5] Raiffa, H. (1968) Decision Analysis. Addison-Wesley.
- [6] Keeney, R.L., and K. Nair (1975) Decision analysis for the siting of nuclear power plants-the relevance of multiattribute utility theory. Proceedings of the IEEE, 63(3).
- [7] Gros, J.G. (1974) A paretian environmental approach to power plant siting in New England. Ph.D. dissertation. Harvard University.
- [8] Keeney, R.L., and H. Raiffa (1976) Decisions with Multiple Objectives: Preferences and Value Tradeoffs. John Wiley.
- [9] Keeney, R.L. (1974) Multiplicative utility functions. Operations Research 22.
- [10] Luenberger, D.G. (1973) Introduction to Linear and Nonlinear Programming. Addison-Wesley.
- [11] Von Neumann, J., and O. Morgenstern (1944) Theory of Games and Economic Behavior. John Wiley.

- [12] Ijiri, Y. (1965) Management Goals and Accounting for Control. North-Holland.
- [13] Seo, F. (1977) Evaluation and control of regional environmental systems in the Yodo river basin; socioeconomic aspect. Proceedings of IFAC Symposium on Environmental Systems Planning, Design, and Control.
- [14] Pierre, D.A., and M.J. Lowe (1975) Mathematical Programming Via Augmented Lagrangians. Addison-Wesley.
- [15] Luce, R.D., and P. Suppes (1965) Preference, utility and subjective probability. In, Handbook of Mathematical Psychology, Vol. III, edited by R.D. Luce, R.R. Bush, and E. Galanter.
- [16] Karlin, S. (1959) Mathematical Methods and Theory in Games, Programming, and Economics.

## AN ASSESSMENT OF THE RESIDENTIAL ENVIRONMENT IN KYOTO CITY: A TRIAL TOWARD GROUP DECISION

H. Nakayama

*Department of Applied Mathematics, Konan University,  
Kobe, Japan*

K. Inoue

*Department of Precision Mechanics, Kyoto University,  
Kyoto, Japan*

Y. Sawaragi

*Department of Applied Mathematics and Physics, Kyoto  
University, Kyoto, Japan*

### 1. INTRODUCTION

Recently, in many social problems such as environmental management, one of the most serious difficulties has been to get the consensus of people concerned because of the multiplicity of their value judgments and the conflicts of their interests. As is well known, Arrow's general impossibility theorem shows that it is impossible in a general sense (under Arrow's five axioms) to aggregate individuals' value judgments into a social one [1]. Several researchers have tried to overcome this difficulty but it is considered to be essentially impossible. In group decision making, therefore, it seems rather important to analyze the group dynamics and/or to refine information available for decision makers to help their mutual understanding. With this in mind, in this paper we shall suggest a method supporting group decisions, which is called the Extended Contributive Rule (ECR) Method on the basis of multiattribute utility theory and report some experimental results in the assessment of the residential environment in Kyoto City.

### 2. DIFFICULTIES IN GROUP DECISIONS

Since Arrow published his general impossibility theorem in 1951 [1], many researchers have been interested in difficulties in group decision. In the following, we shall trace the formulation of Sen [2].

Let  $A$  denote the set of alternatives, let  $R^i$  ( $i=1, \dots, n$ ) represent the individual binary preference relations over  $A$ , and let  $R$  be the social preference relation. Throughout the paper, the  $R^i$  are assumed to be weak orders.<sup>†</sup>

Definition 1

For an arbitrary subset  $S$  of  $A$ , we define

$$\text{opt } [S, R] = \{a \in S \mid a R b \text{ for } \forall b \in S\}$$

$$\text{ext } [S, R] = \{a \in S \mid \nexists b \neq a \text{ such that } b R a, b \in S\}$$

Definition 2

A social choice function  $F$  is defined by a functional relation between the  $n$ -tuple of individual preferences  $(R^1, \dots, R^n)$  and the social preference  $R$ :

$$R = F (R^1, \dots, R^n)$$

Theorem 1 (Arrow's general impossibility theorem)

Suppose that there are at least two persons in the group and three alternatives, then there is no social choice function satisfying the following five conditions.

(1). Condition 0

The social preference  $R$  is a weak order.

(2). Condition 1 (Unrestricted Domain)

The domain of  $F$  must include all possible combinations of individual preference.

(3). Condition 2 (Pareto Principle)

For any pair,  $a, b$ , in  $A$ ,

$$a P^i b, \forall i \implies a P b$$

(4). Condition 3 (Independence of Irrelevant Alternatives)

Let

$$R = F (R^1, \dots, R^n)$$

$$R' = F (R^1, \dots, R^{n'})$$

If for any alternatives  $a, b$  in a subset  $S$  of  $A$

---

<sup>†</sup>That is, they are (i) reflexive;  $x R^i x, x \in A$  (ii) transitive;  $a R^i b, b R^i c \implies a R^i c$ , and (iii) connected;  $a R^i b$ , or  $b R^i a$  for  $a, b \in A$ .

$$a R^i b \iff a R^{i'} b, \quad \forall i$$

then we must have

$$\text{opt } [S, R] = \text{opt } [S, R']$$

(5). Condition D (Nondictatorship)

$$\exists i$$

such that

$$a P^i b \implies a P b \quad \forall a, b \in A$$

If one of these conditions is relaxed, we can get some possibility of the existence of a social choice function. In particular, it should be noted that the condition I is imposed in order to avoid the measurability of utility. Even under the assumption that each individual utility can be evaluated quantitatively, the following theorem means that interpersonal comparison of utilities is necessary for the existence of a social choice function.

Theorem 2 [2]

Let us assume that each individual utility  $u^i$  ( $i = 1, \dots, n$ ) can be evaluated quantitatively. We substitute the social choice function  $F(u^1, \dots, u^n)$  for  $F(R^1, \dots, R^n)$  in the conditions J and I, and define

$$a R^i b \iff u^i(a) \geq u^i(b)$$

If no interpersonal comparison of utilities is permitted, then there does not exist any social choice function consistent with the conditions O, U, P, I, and D.

As to measurable utilities, the utility analysis originated by von Neumann and Morgenstern seems to be useful because it takes risky circumstances into account. Under the assumption of interpersonal comparison, Keeney proved the following result concerning such a group utility  $u_G$

$$u_G = u(u^1, \dots, u^n)$$

Theorem 3 [3]

The conditions O, U, P, I, and D are interpreted as in Theorem 2. A given group cardinal utility function  $u_G = u(u^1, u^2, \dots, u^n)$  over uncertain alternatives is consistent with those conditions if and only if

$$u(u^1, \dots, u^n) = \sum_{i=1}^n k_i u^i \quad (1)$$

where  $k_i \geq 0$ ,  $i = 1, \dots, n$ , and  $k_i > 0$  for at least two  $k_i$ .

### 3. ECR METHOD

In the previous section, it was shown that there is no way of radically settling difficulties in group decisions from the normative viewpoint. We consider group decisions, therefore, as the results of a process of attaining a final decision gradually rather than as being made by some norms. In this event, the following two approaches become important in group decisions: (i) analysis of the structure of group dynamics such as interrelationships between people concerned and alteration of their attitudes and (ii) refinement of information through the procedure of group decision in order to help to improve understanding among people concerned. In the former approach, several models of group dynamics in social psychology have been suggested [4]. On the other hand, in the latter approach several effective methods have been developed, such as ISM [5] which objectifies the structure of consciousness. In the following, we shall state the ECR method, which helps understanding of the structure of group preferences.

In order to make an interpersonal comparison of utilities, it is useful for group members to consider themselves from the standpoint of others just as a benevolent dictator does. This includes, however, an ethical value judgment. Therefore, we try to make use of the obtained information as an input to brainstorming. To this end, the structure of the group preference is represented by a digraph obtained by considering the mean value and the variance of the intensity of individuals' preferences over the alternatives. At this time, every person in the group imposes his weight on each individual utility as a benevolent dictator.

Let  $u^i(\cdot)$  ( $i = 1, \dots, n$ ) denote the individual multiattribute utility function and  $k_{si}$  the weight that a person  $s$  imposes on the utility of a person  $i$ . Then, we can define a social preference  $P_\lambda$  as follows for any alternatives  $a_j, a_k \in A$

$$a_j P_\lambda a_k \iff \sum_{i=1}^n w_i \sigma_{jk}^i + \lambda \left[ \sum_{i=1}^n w_i \min(0, \sigma_{jk}^i) - \theta \right] > 0 \quad (2)$$

where

$$w_i = \left( \sum_{s=1}^n k_{si} \right) / n \quad (3)$$

$$\sigma_{jk}^i = u^i(a_j) - u^i(a_k) \quad (4)$$

Note that  $\lambda > 0$  is a parameter representing degrees of taking account of the variance of preferences, and  $\theta \geq 0$  is a threshold.

**Proposition 1**

The social preference  $P_\lambda$  is a strict partial order, that is, it is transitive and inflexive. Especially for  $\lambda = 0$ , if we define the indifference relation  $I$  by

$$a_j \bar{I} a_k \stackrel{\Delta}{=} \sum_{i=1}^n w_i \sigma_{jk}^i = 0 \quad (5)$$

then  $R = P_0 \cup I$  is a weak order.

$$(ii). \quad \lambda' > \lambda \geq 0 \Rightarrow P_{\lambda'} \subset P_{\lambda}$$

$$(iii). \quad \lambda' > \lambda \geq 0 \Rightarrow \text{ext} [S, P_{\lambda'}] \supset \text{ext} [S, P_{\lambda}] \text{ for } S \subset A$$

(iv). When  $\theta = 0$ , if

$$a P^i b \stackrel{\Delta}{=} u^i(a) - u^i(b) > 0 \quad (6)$$

then the social preference  $P_{\lambda}$  satisfies the condition  $P$  for every nonnegative  $\lambda$ . That is,

$$a P^i b, \forall i \Rightarrow a P_{\lambda} b, \forall \lambda \geq 0 \quad (7)$$

Moreover,

$$a R^i b, \forall i \Rightarrow a R_{\lambda} b, \forall \lambda \geq 0 \quad (8)$$

where

$$R_{\lambda} = P_{\lambda} \cup I_{\lambda}$$

$$a_j \bar{I}_{\lambda} a_k \stackrel{\Delta}{=} (\text{not } a_j P_{\lambda} a_k) \wedge (\text{not } a_k P_{\lambda} a_j)$$

(v). There exists a positive  $\Lambda$  such that

$$(a R^i b, \forall i) \wedge (a P^i b, \exists i) \Rightarrow a P_{\lambda} b, \forall \lambda > \Lambda \quad (9)$$

Proof

(i). Transitivity of  $P_{\lambda}$ : It should be noted by (4) that we have

$$\sigma_{j's}^i = \sigma_{jk}^i + \sigma_{ks}^i \quad (10)$$

Assume that

$$a_j P_{\lambda} a_k \stackrel{\Delta}{=} \sum_{i=1}^n w_i \sigma_{jk}^i + \lambda \left[ \sum_{i=1}^n w_i \min(0, \sigma_{jk}^i) - \theta \right] > 0$$

$$a_k P_{\lambda} a_s \stackrel{\Delta}{=} \sum_{i=1}^n w_i \sigma_{ks}^i + \lambda \left[ \sum_{i=1}^n w_i \min(0, \sigma_{ks}^i) - \theta \right] > 0$$

then we have by (10)

$$\begin{aligned}
& \sum_{i=1}^n w_i a_{js}^i + \lambda \left[ \sum_{i=1}^n w_i \min(0, a_{js}^i) - \theta \right] \\
&= \sum_{i=1}^n w_i (a_{jk}^i + a_{ks}^i) + \lambda \left[ \sum_{i=1}^n w_i \min(0, a_{jn}^i + a_{ks}^i) - \theta \right] \\
&\geq \sum_{i=1}^n w_i a_{jk}^i + \lambda \left[ \sum_{i=1}^n w_i \min(0, a_{jk}^i) - \theta \right] \\
&+ \sum_{i=1}^n w_i a_{ks}^i + \lambda \left[ \sum_{i=1}^n w_i \min(0, a_{ks}^i) - \theta \right] > 0 \quad (11)
\end{aligned}$$

Thus the transitivity of  $P_{\lambda}$  follows, that is

$$a_j P_{\lambda} a_k, a_k P_{\lambda} a_s \Rightarrow a_j P_{\lambda} a_s$$

Irreflexibility of  $P_{\lambda}$ : If  $k = j$ , then

$$a_{jj}^i = 0 \quad \forall i \quad (12)$$

Therefore,

$$\sum_{i=1}^n w_i a_{jj}^i + \lambda \left[ \sum_{i=1}^n w_i \min(0, a_{jj}^i) - \theta \right] \leq 0 \quad (13)$$

We have

$$\text{not } a_j P_{\lambda} a_j \quad (14)$$

Reflexibility of  $R$ : Recalling that

$$a_j P_0 a_k \iff \sum_{i=1}^n w_i a_{jk}^i > 0 \quad (15)$$

$$a_j I a_k \iff \sum_{i=1}^n w_i a_{jk}^i = 0 \quad (16)$$

yields that

$$a_j R a_k \iff \sum_{i=1}^n w_i a_{jk}^i \geq 0 \quad (17)$$

If we set  $k = j$ , then  $a_{jj}^i = 0$  for all  $i$ . Thus we have



$$\sum_{i=1}^n w_i a_{jj}^i = 0 \quad (18)$$

which means

$$a_j R a_j$$

Transitivity of  $R$ : The result is immediate from (10).

Connectedness of  $R$ : For any alternatives  $a_j, a_k \in A$ , one of the following cases is possible

$$(1) \quad \sum_{i=1}^n w_i a_{jk}^i \geq 0 \Rightarrow a_j R a_k$$

$$(2) \quad \sum_{i=1}^n w_i a_{jk}^i \leq 0 \Rightarrow \sum_{i=1}^n w_i a_{kj}^i \geq 0$$

because

$$a_{kj}^i = -a_{jk}^i \text{ for } \forall i$$

Namely

$$a_k R a_j$$

(ii). Since

$$\sum_{i=1}^n w_i \min(0, a_{jk}^i) - \theta$$

is nonpositive, if

$$a_j P_\lambda a_k \iff \sum_{i=1}^n w_i a_{jk}^i + \lambda' \left[ \sum_{i=1}^n w_i \min(0, a_{jk}^i) - \theta \right] > 0$$

then we have

$$0 < \sum_{i=1}^n w_i a_{jk}^i + \lambda' \left[ \sum_{i=1}^n w_i \min(0, a_{jk}^i) - \theta \right]$$

$$\leq \sum_{i=1}^n w_i a_{jk}^i + \lambda \left[ \sum_{i=1}^n w_i \min(0, a_{jk}^i) - \theta \right] \quad (19)$$

that is,  $a_j P_\lambda a_k$ . Accordingly, it follows that

$$P_{\lambda'} \subset P_\lambda \quad (20)$$

(iii). Suppose that for  $\lambda' > \lambda \geq 0$

$$a_j \in \text{ext} [S, P_\lambda] \xrightarrow{\Delta} (\exists a_k \neq a_j \text{ such that } a_k P_\lambda a_j, a_k \in S)$$

and

$$a_j \notin \text{ext} [S, P_{\lambda'}] \xrightarrow{\Delta} (\exists a_k \neq a_j \text{ such that } a_k P_{\lambda'} a_j, a_k \in S)$$

Then we have by the result of (ii)

$$a_k P_\lambda a_j \Rightarrow a_k P_{\lambda'} a_j$$

which contradicts

$$\exists a_k \neq a_j \text{ such that } a_k P_\lambda a_j$$

Therefore

$$a_j \in \text{ext} [S, P_\lambda] \Rightarrow a_j \in \text{ext} [S, P_{\lambda'}]$$

(iv). If  $a_j P^i a_k$  for all  $i$ , then  $c_{jk}^i = u^i(a_j) - u^i(a_k) > 0$  for all  $i$ . Thus we have

$$\sum_{i=1}^n w_i c_{jk}^i + \lambda \left[ \sum_{i=1}^n w_i \min(0, c_{jk}^i) \right] = \sum_{i=1}^n w_i c_{jk}^i > 0 \quad (21)$$

which means  $a_j P_\lambda a_k$ . Moreover, if we define

$$a_j I_\lambda a_k \iff (\text{not } a_j P_\lambda a_k) \wedge (\text{not } a_k P_\lambda a_j)$$

then it follows by  $c_{kj}^i = -c_{jk}^i \quad \forall i$  that

$$\begin{aligned} a_j I_\lambda a_k &\iff -\lambda \left[ \sum_{i=1}^n w_i \max(0, c_{jk}^i) \right] \leq \sum_{i=1}^n w_i c_{jk}^i \\ &\iff -\lambda \left[ \sum_{i=1}^n w_i \min(0, c_{jk}^i) \right] \end{aligned} \quad (22)$$

Accordingly, for  $R_\lambda = P_\lambda \cup I_\lambda$  we have

$$a_j R_\lambda a_k \iff \sum_{i=1}^n w_i c_{jk}^i + \lambda \left[ \sum_{i=1}^n w_i \max(0, c_{jk}^i) \right]^* \geq 0 \quad (23)$$

which gives

$$a_j R^i a_k, \forall i \Rightarrow a_j R_\lambda a_k, \forall \lambda \geq 0 \tag{24}$$

(v). First, we have for all  $\lambda \geq 0$

$$(a_j R^i a_k, \forall i) \wedge (a_j P^i a_k, \exists i) \Rightarrow a_j P_\lambda a_k \tag{25}$$

because

$$a_j P_\lambda a_k = \sum_{i=1}^n w_i \sigma_{jk}^i + \lambda \left[ \sum_{i=1}^n w_i \min(0, \sigma_{jk}^i) \right] > 0 \tag{26}$$

$$a_j R^i a_k = \sigma_{jk}^i \geq 0 \tag{27}$$

$$a_j P^i a_k = \sigma_{jk}^i > 0 \tag{28}$$

Conversely, if we meet the case of not  $[(a_j R^i a_k, i) \wedge (a_j P^i a_k, i)]$  then the following three cases are possible:

$$(1) \quad \sigma_{jk}^i = 0, \forall i \Rightarrow \sum_{i=1}^n w_i \min(0, \sigma_{jk}^i) = 0 \tag{29}$$

Thus, not  $a_j P_\lambda a_k, \forall \lambda \geq 0$

$$(2) \quad \left. \begin{array}{l} \sigma_{jk}^i < 0, \exists i \\ \text{and} \\ \sum_{i=1}^n w_i \sigma_{jk}^i \leq 0 \end{array} \right\} \Rightarrow \text{not } a_j P_\lambda a_k, \forall \lambda \geq 0 \tag{30}$$

$$(3) \quad \left. \begin{array}{l} \sigma_{jk}^i < 0, \exists i \\ \text{and} \\ \sum_{i=1}^n w_i \sigma_{jk}^i > 0 \end{array} \right\} \Rightarrow \left\{ \begin{array}{l} \sum_{i=1}^n w_i \sigma_{jk}^i + \left[ \sum_{i=1}^n w_i \min(0, \sigma_{jk}^i) \right] \geq 0 \\ \text{for all } \lambda \text{ such that} \\ \lambda \geq \frac{\sum_{i=1}^n w_i \sigma_{jk}^i}{-\sum_{i=1}^n w_i \min(0, \sigma_{jk}^i)} \equiv \Lambda \end{array} \right. \tag{31}$$

That is, not  $a_j R a_k$  for  $\forall \lambda \geq \Lambda$ .

Accordingly, for all  $\lambda \geq \Lambda$  we have

$$\text{not } [(a_j R^i a_k, \Psi_i) \wedge (a_j P^i a_n, \exists i)] \Rightarrow \text{not } a_j P_\lambda a_k \quad (33)$$

These statements prove that

$$(a_j R^i a_k, \Psi_i) \wedge (a_j P^i a_k, \exists i) \Rightarrow a_j P_\lambda a_k, \Psi_\lambda \geq \Lambda \quad (34)$$

If we set  $w_i = 1$  for all  $i$  and  $\lambda = 0$  and define

$$c_{jk}^i = \begin{cases} 1 & \text{for } u^i(a_j) - u^i(a_k) > 0 \\ 0 & \text{for } u^i(a_j) - u^i(a_k) = 0 \\ -1 & \text{for } u^i(a_j) - u^i(a_k) < 0 \end{cases} \quad (35)$$

then the social preference  $P$  defined by (3) equals that defined by the simple majority rule.<sup>o</sup> Saposnik showed that if, whether we use utility functions or not, we have

$$c_{jk}^i = c_{jr}^i + c_{rk}^i \quad \Psi_r \quad (36)$$

then the social preference  $P$  defined by

$$a_j P a_k \iff \sum_{n=1}^n c_{jk}^i > 0 \quad (37)$$

has transitivity. He called the social ordering by (37) a simple contributive rule. Accordingly, we call that by (1) an extended contributive rule in this paper.

Now, we try to visualize the structure of the social preference by a digraph. Define a matrix  $M = (m_{jk})$  as follows.

Definition 3

$$m_{jk} = \begin{cases} 1 & \text{when } a_k P_\lambda a_j \\ 0 & \text{otherwise} \end{cases}$$

We can get a digraph on the basis of  $M$ . In this event, a similar method to the interactive ISM method [5] yields the matrix  $M$  efficiently: choose an alternative  $a_s$  arbitrarily. By considering the relationship between  $a_s$  and others, we have three subsets as follows (Figure 1)

- (i). Lift set =  $\{a_j | a_j P_\lambda a_s\}$
- (ii). Drop set =  $\{a_j | a_s P_\lambda a_j\}$

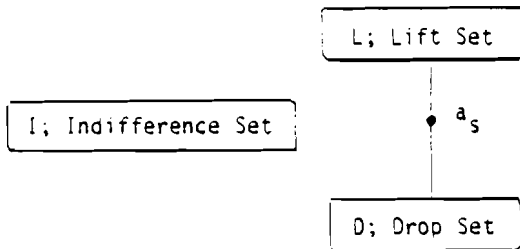

Figure 1. Partition of Alternatives.

(iii). Indifference set =  $\{a_j \mid \text{not } a_j P_\lambda a_s \text{ and not } a_s P_\lambda a_j\}$

The matrix  $M$  can be decided completely by the transitivity of the relation  $P_\lambda$ . That is, if we define the row vector  $\alpha = (1, 0, 0)$  and the column vector  $\beta = (0, 0, 1)^T$  as in Figure 2, then submatrices shown by dotted letters in Figure 2 are inferred by the transitivity of  $P_\lambda$ . This is shown by some matrix calculation as follows.

By the transitivity of  $P_\lambda$

$$(m_{jk} = 1) \wedge (m_{kr} = 1) \Rightarrow m_{jr} = 1 \quad (38)$$

and

$$m_{jr} = 0 \Rightarrow (m_{jk} = 0) \vee (m_{kr} = 0) \quad (39)$$

It follows, therefore, that

$$(m_{jk} = 1) \wedge (m_{jr} = 0) \Rightarrow m_{kr} = 0 \quad (40)$$

$$(m_{kr} = 1) \wedge (m_{jr} = 0) \Rightarrow m_{jk} = 0 \quad (41)$$

These logical relations can be rewritten by some matrix calculation, that is

$$(38) \Rightarrow \beta \alpha = \begin{bmatrix} 0 \\ 0 \\ 1 \end{bmatrix} (100) = \begin{bmatrix} 0 & 0 & 0 \\ 0 & 0 & 0 \\ 1 & 0 & 0 \end{bmatrix}$$

This means  $M_{DL} = 1$ .

	L	s	I	D	
L	MLL	0	0	0	a
s	1		0	0	
I	MIL	0	MII	0	
D	1	1	MDI	MDD	

b

Figure 2. Matrix M.

$$(40) \quad \overline{a^T a} = \begin{bmatrix} 1 & 0 & 0 \\ 1 & 1 & 1 \\ 1 & 1 & 1 \end{bmatrix}$$

This means  $M_{LI} = M_{LD} = 0$ .

$$(41) \quad \overline{b b^T} = \begin{bmatrix} 1 & 1 & 0 \\ 1 & 1 & 0 \\ 1 & 1 & 1 \end{bmatrix}$$

This means  $M_{LD} = M_{ID} = 0$ .

Note that the value of

$$\sum_{i=1}^n w_i c_{jk}^i$$

shows the intensity of the path between  $a_j$  and  $a_k$ . Weak paths are cut off actively by increasing the value of  $\lambda$ , that is, by thinking a lot of opposite opinions. Moreover, even if all the members agree with a preference with a weak intensity, the preference may be neglected by introducing a threshold  $\theta$ . Digraphs corresponding to several  $\lambda$ s show the structure of the group preference with the intensity.

As Keeney stated in his paper [3], it is not easy for each person to make interpersonal comparisons of utilities such as a benevolent dictator. As a result, the expected utility of the group  $u_G$  given by (1) may not lead the group to the final decision. However, the information obtained by the method stated may be of value for mutual understanding of the people concerned in brain storming.

Recall that our standpoint is that the group decision is due to the dynamics of the group and we provide some refined information toward a consensus of the people concerned.

#### 4. AN ASSESSMENT OF THE RESIDENTIAL ENVIRONMENT IN KYOTO CITY

The problem is as follows: There is a family that consists of a man, his wife, his parents, his brother, and his son. This family is looking for a residential district in Kyoto City in Japan. He wants to keep a grocery store at his home. His wife loves a quiet district with good views. His parents prefer a quiet and clean place with a lot of medical services. His brother, who is a worker commuting to Osaka, wants to live in a district with convenient access to the town center. His son is a highschool student and likes a quiet district with convenient access to the town center. He, his wife, and his brother are going to invest in a new house.

The structure of criteria is given by Figure 3. The utility function was obtained through discussion with all members. The result is given in Tables 1 and 2. The process for obtaining these utility functions followed the one suggested by Keeney and Raiffa [6]. The alternatives are nine administrative districts (Table 3). Ranking of alternatives based on each alternative utility is illustrated as a digraph in Figure 4. The result by ECR-methods is given in Figures 5 and 6. These figures become inputs to brain storming, which are of value in knowing the degree of coincidence of all the individuals' preferences (Figure 5) and the intensity of the preferences (Figure 6). It appears from these results that Sakyo, Ukyo and Kita may be considered to be better alternatives. However, any final selection is not made in this experiment because the division into nine alternatives is too rough in view of the characteristic of the problem.

#### 5. CONCLUDING REMARKS

In this paper, we considered group decisions as results of the process of attaining a final decision gradually rather than as being made by some norms. From this point of view, we suggested a method for refinement of the information through the procedure of decision making in order to improve understanding among people concerned. By the state method, the structure of group preferences can be clarified by the degree of coincidence of preferences of group members and by the intensity of preferences. Digraphs are valid to visualize the information, which is an input to brain storming. Interactive man-machine systems are efficient for this purpose. As assessment of the residential environment in Kyoto City proves the efficiency of the method.

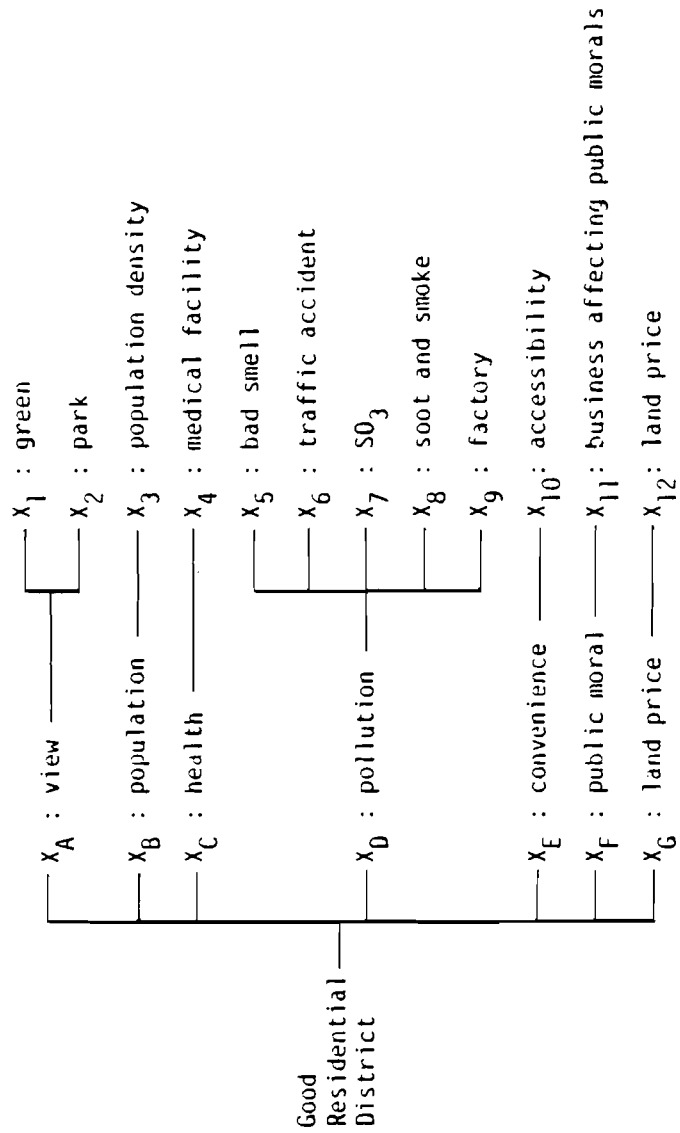

Figure 3. Hierarchical structure of attributes.



Table 1. Utility function for each attribute.

Attribute	Worst level	Best level	Utility function
$x_1$ Proportion of green area (%)	0	60	$u_1(x_1) = x_1/60$
$x_2$ Proportion of park area (%)	0	10	$u_2(x_2) = x_2/10$
$x_3$ Population density (person/km <sup>2</sup> )	18,500	500	$u_3(x_3) = (18500 - x_3)/18000$
$x_4$ Medical facility (number/10 <sup>3</sup> persons)	3	10	$u_4(x_4) = (x_4 - 3)/7$
$x_5$ Bad smell (number/year)	60	0	$u_5(x_5) = 1 - x_5/60$
$x_6$ Traffic accidents (number/year)	2,500	0	$u_6(x_6) = 1 - x_6/2500$
$x_7$ Sulphurous acid gas (mg/day/100 cm <sup>2</sup> )	1.7	0	$u_7(x_7) = 1 - x_7/1.7$
$x_8$ Soot and smoke (t/month/km <sup>2</sup> )	10	0	$u_8(x_8) = 1 - x_8/10$
$x_9$ Factory (number)	4,500	0	$u_9(x_9) = 1 - x_9/4500$
$x_{10}$ Accessibility to the center of the city (minutes)	60	0	$u_{10}(x_{10}) = 1 - x_{10}/60$
$x_{11}$ Offices of a business affecting public morals (number/km <sup>2</sup> )	200	0	$u_{11}(x_{11}) = 1.096 - 0.969 \exp(0.0122 x_{11})$
$x_{12}$ Land price (10 <sup>3</sup> yen/m <sup>2</sup> )	185	45	$u_{12}(x_{12}) = (185 - x_{12})/140$

Table 2. Individual multiattribute utility functions.

$$1 + KU = (1 + KK_A u_A) (1 + KK_B u_B) (1 + KK_C u_C) (1 + KK_D u_D) (1 + KK_E u_E) (1 + KK_F u_F) (1 + KK_G u_G)$$

$$1 + k_A u_A = (1 + k_A k_1 u_1) (1 + k_A k_2 u_2)$$

$$1 + k_D u_D = (1 + k_D k_5 u_5) (1 + k_D k_6 u_6) (1 + k_D k_7 u_7) (1 + k_D k_8 u_8) (1 + k_D k_9 u_9)$$

$$u_B = u_3, u_C = u_4, u_E = u_{10}, u_F = u_{11}, u_G = u_{12}$$

	Man	Wife	Parent	Brother	Son
$k_1$	0.8	0.9	0.8	0.64	
$k_2$	0.48	0.36	0.8	0.8	Additive form
$k_3$	-0.729	-0.802	-0.938	-0.859	$u_A = 0.6u_1 + 0.4u_2$
$k_5$	0.56	0.4	0.6	0.15	0.48
$k_6$	0.7	0.1	0.54	0.12	0.6
$k_7$	0.42	0.3	0.54	0.15	0.36
$k_8$	0.42	0.2	0.54	0.3	0.36
$k_9$	0.63	0.3	0.6	0.09	0.18
$k_{10}$	-0.981	-0.523	-0.983	0.689	-0.9
$K_A$	0.36	0.125	0.64	0.54	0.405
$K_B$	0.60	0.05	0.4	0.225	0.18
$K_C$	0.30	0.25	0.64	0.546	0.18
$K_D$	0.42	0.5	0.8	0.9	0.45
$K_E$	0.18	0.1	0.48	0.868	0.9
$K_F$	0.06	0.125	0.16	0.18	0.09
$K_G$	0.54	0.333	0.16	0.9	0.36
$K$	-0.955	-0.751	-0.994	-0.9998	-0.981

Table 3. Data from "Statistical information of Kyoto City."

Attribute	Kita	Kamigyo	Sakyo	Nakagyo	Higashiyama	Shimogyo	Minami	Ukyo	Fushimi
Proportion of green area	54.7	0	30.7	0.29	29.7	0.73	17.7	56.0	41.5
Proportion of park area	0.168	9.90	0.339	0.898	0.593	0.623	1.953	0.366	0.648
Population density	1434	17754	762	18022	4798	17240	6905	1879	3056
Medical facility	4.69	6.46	4.19	9.74	4.02	8.93	4.65	3.72	3.61
Bad smell	5	23	17	14	23	13	32	16	58
Traffic accident	979	999	1228	1484	1600	1762	1399	2051	1381
Sulphurous acid gas	0.5	1.2	0.5	1.0	1.0	1.2	1.4	0.9	1.7
Soot and smoke	7.0	7.5	8.0	8.0	7.0	8.5	9.0	7.0	7.0
Factory	2736	4490	530	2804	1372	1602	1264	1806	756
Accessibility to the center of the city	30	20	25	15	25	15	30	30	40
Offices of business affecting public morals	0.18	22.8	0.43	154.7	36.9	53.4	2.17	0.39	1.11
Land price	115.6	137.5	96.4	107.0	87.5	110.0	93.5	84.2	66.2

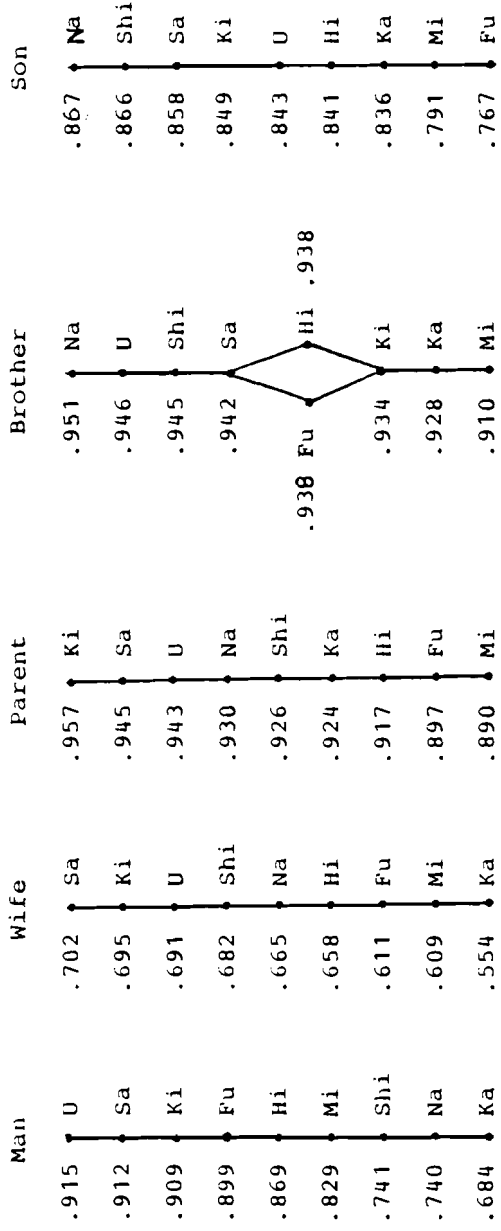

Figure 4. Individual Orderings of Alternatives.

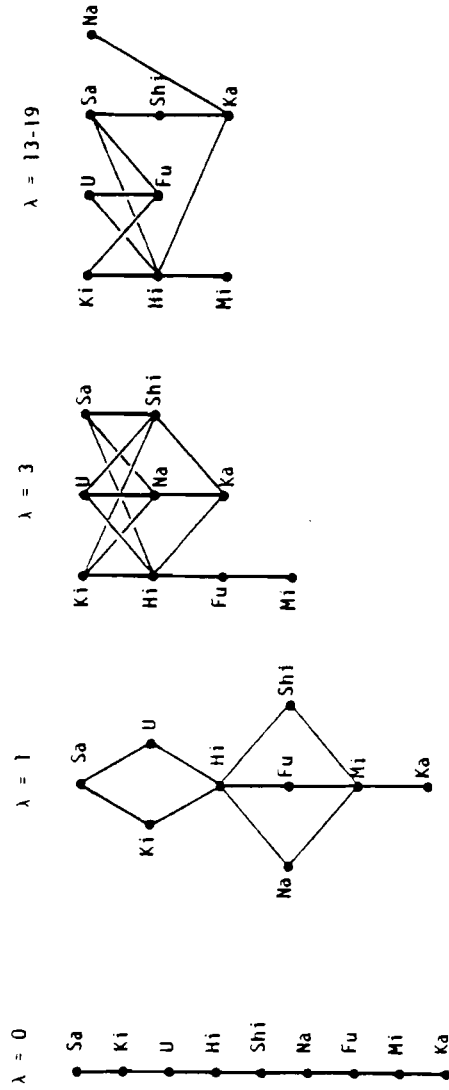

Figure 5. Social ordering by ECR method ( $\theta = 0$ ).

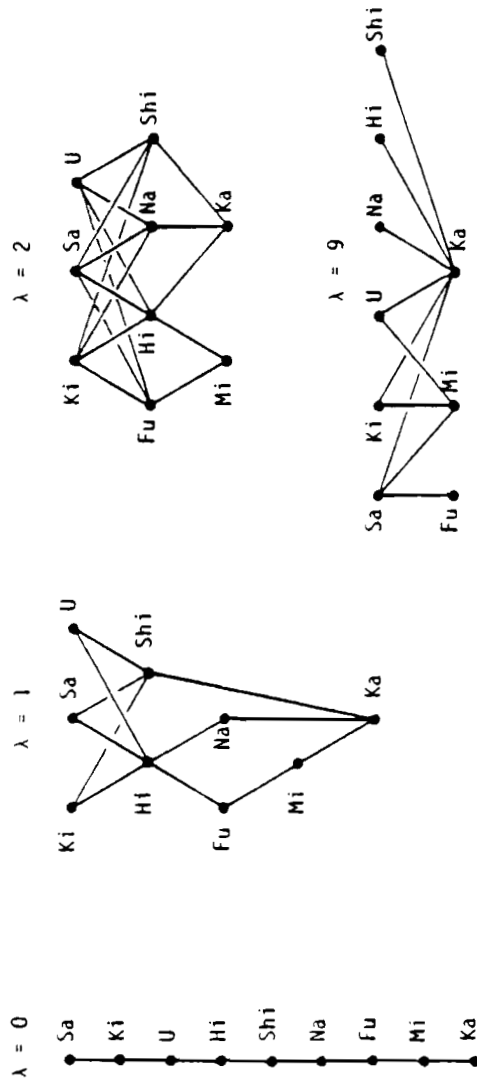

Figure 6. Social ordering with a threshold  $\theta = 0.005$ .

## ACKNOWLEDGMENTS

We would like to express our gratitude to Mr. T. Tanino, Mr. K. Katsumoto, and Mr. H. Matsuo from Kyoto University for their collaboration on this work.

## REFERENCES

- [1] Arrow, K.J. (1951) Social Choice and Individual Values. Wiley.
- [2] Sen, A.K. (1970) Collective Choice and Social Welfare. Holden-Day.
- [3] Keeney, R.L. (1976) A group preference axiomatization with Cardinal Utility. Management Science 23(2).
- [4] Cartwright, D., and A. Zander (eds) (1968) Group Dynamics; Research and Theory. 3rd Edition. Harper and Row.
- [5] Warfield, J.N. (1976) Societal Systems; Planning, Policy, and Complexity. Wiley.
- [6] Keeney, R.L., and H. Raiffa (1976) Decision with Multiple Objectives; Preferences and Value Tradeoffs. Wiley.

## SUMMARY OF THE DISCUSSION

J. Kacprzyk

The discussion after the first paper of the session focused mainly on the concept of soft constraints and its advantages. It was stressed that the introduction of such constraints to a problem formulation may make it closer to the way the people proceed. One suggestion was to couple this approach to somewhat similar ideas due to Tversky and Kornai; the second one concerned some actual planning procedures to obtain a more behavioral type of model. The introduction of soft constraints was appreciated as an example of the desired softening of the problem formulation.

With respect to the nested Lagrangian multiplier method used for solving the multicriterion problems, it was stated that it may give more insight into the problem, making it possible to get a fairly good model of economic type and to check the subjectivity of utility function assessment.

As to the paper devoted to the human judgments and assessments, the discussion mainly concerned the problem of data and their adequacy. It was stressed that the perception of a real situation by various social groups, including that of influence, political, or administrative power, may be quite different. Thus, the repetition of experiments for particular groups and a careful analysis of results obtained will probably help.

There was also a general discussion on the necessity of some soft mathematics for handling regional problems, or at least some of them. By their very nature, e.g., lack of clear-cut elements, multidimensionality, complication, and the considerable role of human factors, the regional problems cannot be treated as pure physical or technological systems. Thus, some softer approaches, making it possible to include in the problem formulation, e.g., lack of precise knowledge on facts and relations, human perception and judgment, and some partial truths are needed. Conventional mathematics is not always suitable for this task. Some



soft mathematics is therefore required. One such approach may be that based on the theory of fuzzy sets. This seems to be a fruitful area for applications. However, some related problems, as, for example, the definition of membership functions, should be solved.

As another approach, the introduction of soft constraints should also be taken into consideration. As to the increase of computer time requirements that may occur while using these soft approaches, it was stated that, owing to the progress in computer technology, computer time is becoming cheaper; thus, what really should count is the possibility of attaining more adequate descriptions.



PART VII

CONCLUDING REMARKS

Since this volume presents some work from ongoing, still not completed, IRD projects, these concluding remarks mainly concern the present stage of the research effort, with some views as to the project as a whole.

The work done so far includes a large spectrum of problems, issues, approaches, methods, etc. Thus, this volume is a valuable tool for anyone trying to formulate and solve regional development problems.

The importance of having some implemented models for various planning, programming, forecasting, simulations, and other purposes must be emphasized. However, a core model is lacking that couples these various models to particular specific aspects of the regional problématique. The relevance of such a model is self-evident; otherwise one cannot attain integration and comprehensiveness, the prerequisites of integrated regional development that are commonly accepted as the uniquely reasonable approach. While elaborating the concept of such a core model and implementing it, the consideration of Orgware components and their inclusion in the regional development system should be the next step.

Since the problem of attaining a consensus will grow in importance in the future, when more quality-of-life than growth-oriented development will occur, models should be developed further to reflect this new trend.

The methods and techniques used as the tools for solving the problems analyzed in this volume conform in general to the main contemporary opinions and trends. Thus, to give an example, the use of interactive man-machine approaches for solving multi-criterion problems is reasonable. One should, however, probably

pay more attention to organizing the man-machine interface to better reflect the inherent characteristics of human behavior. This does not have much to do with the problem of "softness."

As regional problems often involve actors (administrative, political, social, etc.) with incompatible interests, conflict analysis should be the subject of a more thorough consideration.

It was often stressed during the workshop, in both formal and informal discussions, that the problem of increasing the adequacy of regional problem description remains still valid and of extraordinary importance. One should not forget that the region is a complex socioeconomic system, of which not all the components may be handled owing to their inherent softness and indeterminism as mechanistic or technological systems and attacked via the conventional strict and crisp apparatus of systems analysis. Some softer approaches are, therefore, needed. The attempts presented are merely some first steps in this direction. Serious work here must be undertaken, because these approaches will surely be more and more relevant in view of the unavoidable transition from "simple" growth to human-oriented strategies in the majority of, if not all, future IRD programs.

The success of future research efforts on the Kinki IRDP and other IRD projects will surely depend to a considerable extent on what has been mentioned here. Obviously, many other issues, omitted here or even unpredictable now, will also have decisive impacts.

APPENDIX: OTHER PAPERS GIVEN AT THE WORKSHOP

A number of papers were given at the Workshop in June 1978 that are not included in this volume. They are listed below; they may be obtained from IIASA, or directly from their authors.

Regional Socioeconomic Activity Allocation Model—Osaka Area Simulation Study (OASIS).

*Y. Suzuki and P.S. Pak*

A Land-Use Model for Supporting Redevelopment Decisions in the Osaka Metropolitan Area.

*Y. Suzuki, P.S. Pak, K. Tsuji, T. Yamada, T. Murakami, K. Hirose and Y. Noto*

Demand Estimation of the Urban Expressway System of the Hanshin Expressway Public Corporation Using System Dynamics

*H. Hasegawa and T. Sasaki*

A Model to Support Decision Making for Energy Supply System of a Metropolitan Area

*Y. Suzuki, P.S. Pak, K. Ito, and T. Murakami*

A Quantitative Investigation of Inhabitants' Evaluation of Man-Made Lakes—The Case of Toban Area in Japan

*K. Nakagami, H. Itakura, and M. Takamatsu*

Modeling Conflicts in Water Resources Utilization

*N. Okada and K. Yoshikawa*

Multiobjective Optimization in Water Resources Problem for a Shingle River Basin—A Case Study of the Kakogawa River Basin

*M. Sakawa and Y. Sawarangi*

A Man-Machine Interactive Approach to an Integrated Regional Development Planning Problem—The Upper Stratum Submodel of Kinki IRDPM

*K. Ito, T. Aina, K. Shoji, and Y. Suzuki*

Methods of Interpretive Structural Modeling Considering Intra-  
sitivity in Human Judgments

*Y. Nishikawa and A. Udo*

On the Possibility of Including Imprecision in Some Mathematical  
Programming Models for the Kinki IRDP

*J. Kacprzyk*