

Working Paper

ENERGY ANALYSIS OVERVIEW OF NATIONS

Howard T. Odum
Elisabeth C. Odum

with sections by
Gisela Bosch
Leon C. Braat
William Dunn
Gordon de R. Innes
John R. Richardson
David M. Scienceman
Jan P. Sendzimir
David J. Smith
Michael V. Thomas

September 1983
WP-83-82



International Institute for Applied Systems Analysis □ A-2361 Laxenburg Austria

Telephone: +43 2236 715210 □ Telex: 079137 iiasa a □ Telefax: +43 2236 71313

NOT FOR QUOTATION
WITHOUT PERMISSION
OF THE AUTHOR

ENERGY ANALYSIS OVERVIEW OF NATIONS

Howard T. Odum
Elisabeth C. Odum

with sections by
Gisela Bosch
Leon C. Braat
William Dunn
Gordon de R. Innes
John R. Richardson
David M. Scienceman
Jan P. Sendzimir
David J. Smith
Michael V. Thomas

September 1983
WP-83-82

Working Papers are interim reports on work of the International Institute for Applied Systems Analysis and have received only limited review. Views or opinions expressed herein do not necessarily represent those of the Institute or of its National Member Organizations.

INTERNATIONAL INSTITUTE FOR APPLIED SYSTEMS ANALYSIS
A-2361 Laxenburg, Austria

CONTENTS

PART I. ENERGY ANALYSIS OVERVIEW OF NATIONS: CONCEPTS AND METHODS

1. EMBODIED ENERGY AND NATIONAL OVERVIEW	1
2. CALCULATING ACTUAL ENERGY FLOWS AND STORAGES	24
3. ENERGY TRANSFORMATION RATIOS AND CALCULATION OF EMBODIED ENERGY	36
4. SUMMARIZING PARAMETERS FOR NATIONAL OVERVIEW	46
5. ANALYSIS OF SUBSYSTEMS	55

PART II. ENERGY ANALYSIS OVERVIEW OF NATIONS: TWO CASE STUDIES

	62
6. ENERGY ANALYSIS OVERVIEW OF SPAIN	63
7. ENERGY ANALYSIS OVERVIEW OF LIBERIA	79
8. ENERGY ANALYSIS OVERVIEW OF NEW ZEALAND	115
9. ENERGY ANALYSIS OVERVIEW OF DOMINICA	143
10. ENERGY ANALYSIS OVERVIEW OF THE NETHERLANDS	180
11. ENERGY ANALYSIS OVERVIEW OF THE FEDERAL REPUBLIC OF GERMANY (FRG)	197
12. ENERGY ANALYSIS OVERVIEW OF THE U.S.S.R.	224
13. ENERGY ANALYSIS OVERVIEW OF BRAZIL	252
14. ENERGY ANALYSIS OVERVIEW OF AUSTRALIA	272

15.	ENERGY ANALYSIS OVERVIEW OF INDIA	289
16.	ENERGY ANALYSIS OVERVIEW OF POLAND	310
17.	ENERGY ANALYSIS OVERVIEW OF THE UNITED STATES OF AMERICA	332
18.	COMPARISONS	348
	REFERENCES	354
APPENDIX:	ENERGY ANALYSIS OF SUBSYSTEMS AND CALCULATIONS OF ENERGY TRANSFORMATION RATIOS	367

PART I. ENERGY ANALYSIS OVERVIEW OF
NATIONS: CONCEPTS AND METHODS

1. EMBODIED ENERGY AND NATIONAL OVERVIEW

Overview perspectives on whole nations and their public policies have often come from broad education, history, experience, interpretation of economic indices, and common-sense wisdom, all difficult to learn. As the world moves into uncharted patterns of culture, technology and environmental relationships, better ways are needed for gaining overviews of national systems and their processes.

In these studies an *energy systems procedure* is applied to nations, evaluating their energetics and basis for economic vitality. New perspectives result on growth, foreign trade, defense, environmental management, standard of living, carrying capacity and future trends.

Power and Value

While acknowledging the human individual choice of what is valuable and utilitarian from his perspective, the society as a whole develops ways to recognize and value those patterns that succeed and help cultural survival. If these depend on the rate of useful work accomplished (power), then evaluations of work ultimately predict what is valuable for survival. This theory of maximum power recognizes the flexibility of energy that allows excess energy availability to be used to meet all other needs, eliminate shortages, recycle materials, and cause the designs that maximize power to prevail. Considered over long time intervals, collective human choice recognizes what has been successful as valuable. Hence, energy as a property of all other flows is the common denominator for evaluating the resource basis for economies.

Earlier efforts to use energy and work as a value measure were discarded prematurely. They were not very successful because energy of various types were regarded as equivalent, whereas energies of different type do not accomplish similar work. However, by converting all types of energy into equivalent units of one type of energy, that of sunlight, various commodities may be compared on an equivalent ability-to-do-work for the combined system of humanity and nature. For more elaborate discussions of the historical roots and rationale of these energy theories of value that were continued by M. Boltzman and A.P. Lotka, see recent review (Odum 1983).

Energy Systems Analysis is the process of representing a system, such as a nation, with a network diagram in which the pathways are flows of energy and the pathway connections represent processes and entities of the system. With a special set of symbols that have mathematical and energy meanings, the energy network diagram shows in overview the way energy sources generate work processes and the workings of the economies of the nation and its environmental partner. Evaluating the energy flows of principal pathways provides quantitative measures of the energy-economic system.

Energy Language Symbols

The overview of a nation is facilitated by diagrams that show energy bases, causal relationships, parts, sources, and hierarchical relationships. Energy language symbols (Odum 1971, 1972, 1983) were used as given in Figure 1.1. Abundant forms of low quality are drawn on the left of a diagram and scarce, high quality forms of energy are on the right. Used energy passes out through the heat sink symbol at the bottom of the diagram. System boundaries are defined with a rectangle. Defining the boundary of consideration also defines outside flows as energy sources. When flows and storages are evaluated in units of solar equivalent energy (solar equivalent joules) these numbers are written on the diagram to show at a glance the relative importance of the item to the nation's economy.

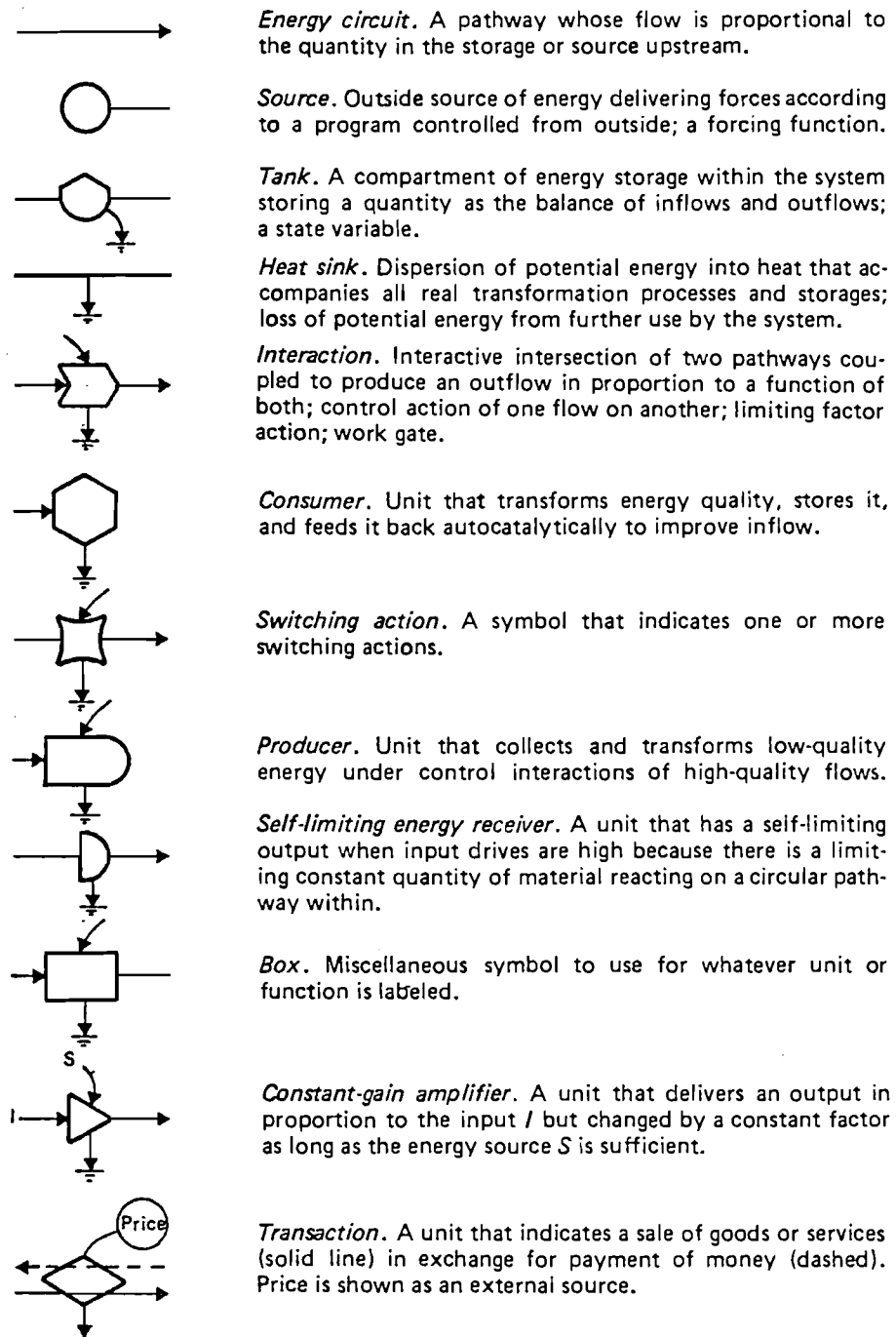

Figure 1.1. Symbols of the energy language used to represent national systems in overview (Odum 1983).

Generic Diagram of a Nation

A typical diagram for a nation is given in Figure 1.2 with main types of sources and components. Land-use systems are on the left, economic processes are in the middle, and the consumers and urban users are on the right. Foreign trade is shown with the rest of the world on the right side. Feedbacks are drawn counterclockwise. See, for example, the feedback of human service in Figure 1.2.

The Work of Nature

The vitality of a national economy depends on the productive work of its people and machines *and* on the productive work of natural processes of the landscape (Figure 1.3). Often the productive contributions of the landscape to the economy are indirect and not adequately recognized. Especially in underdeveloped countries, stocks of good soil, forests, minerals, water resources, coastal resources that utilize tide and waves, and favorable climates may be contributing to reduction of the human costs of living and economic operations, and reduction of the taxes that would be required if environmental services were less.

Since the exchange of money is between humans, paid to each other for labor and services, money does not measure the productive inputs of the environmental work that ultimately help give vitality to the economy and increase the gross national product, the real overall buying power of the economy. When payment is made for wood, agricultural products, fisheries' products, water, or minerals, that money is for the human service involved. The

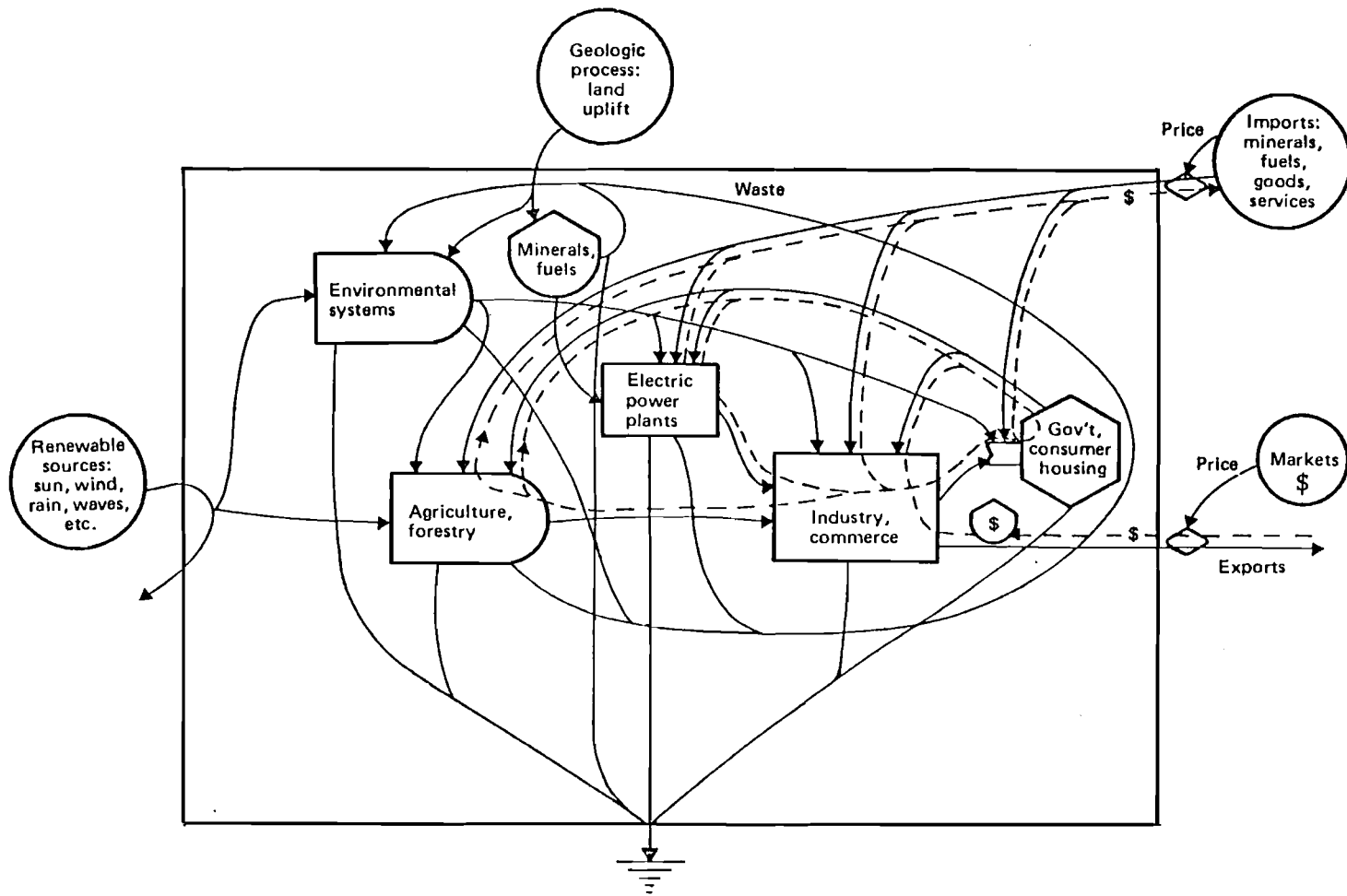

Figure 1.2. Generic diagram of the main features of a nation.

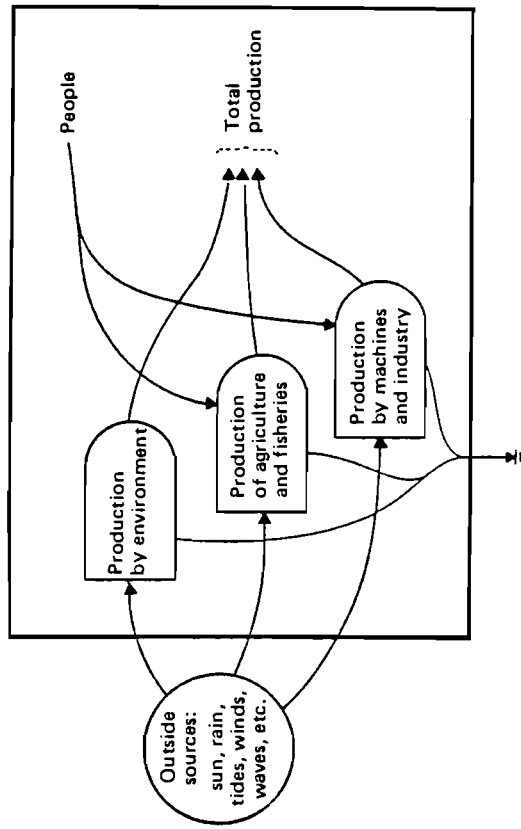

Figure 1.3. Useful productive work includes that of natural systems and that of people.

work of nature involved in developing the product is an additional contribution not measured by the money paid (see Figure 1.4).

To gain an overview of a country's economic basis one must examine both kinds of productive inputs, those from nature's work and those from the work of humans. By putting both in energy terms, they may be compared in the same units. Figures 1.5 and 1.6. show the basis for a national economy in its unpaid renewable resources, its non-renewable storages (reserves) and its purchased inputs. The flows of money only accompany part of these.

Tables and diagrams of energy storages and flows are prepared to show the relative importance of the various contributions to the economy including foreign trade. After all inputs and storages are evaluated in energy units, they may all be put on a dollar basis by their proportionate effect on the total money circulating (see GNP in Figure 1.5).

Because energy flows or storages of different types are of different quality, actual contents must be converted into equivalents of one type of energy, such as solar equivalent joules or coal equivalent joules. For example, when expressing the amount of electric energy for comparison with other types, one may multiply the electrical energy by 4.6 to get its equivalent wood energy. See Figure 1.7. The energy of one type (in this case wood) required to generate a unit of energy of another type (in this case electricity), is defined as the *energy transformation ratio*.

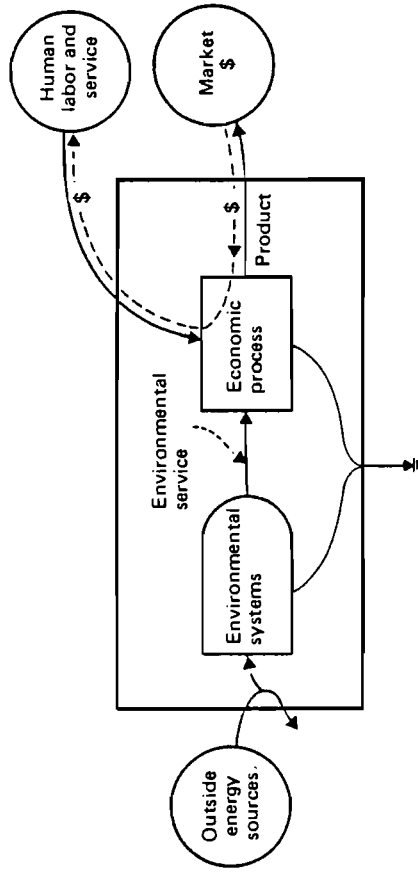

Figure 1.4. Diagram that shows money going for human service only, not to environmental service.

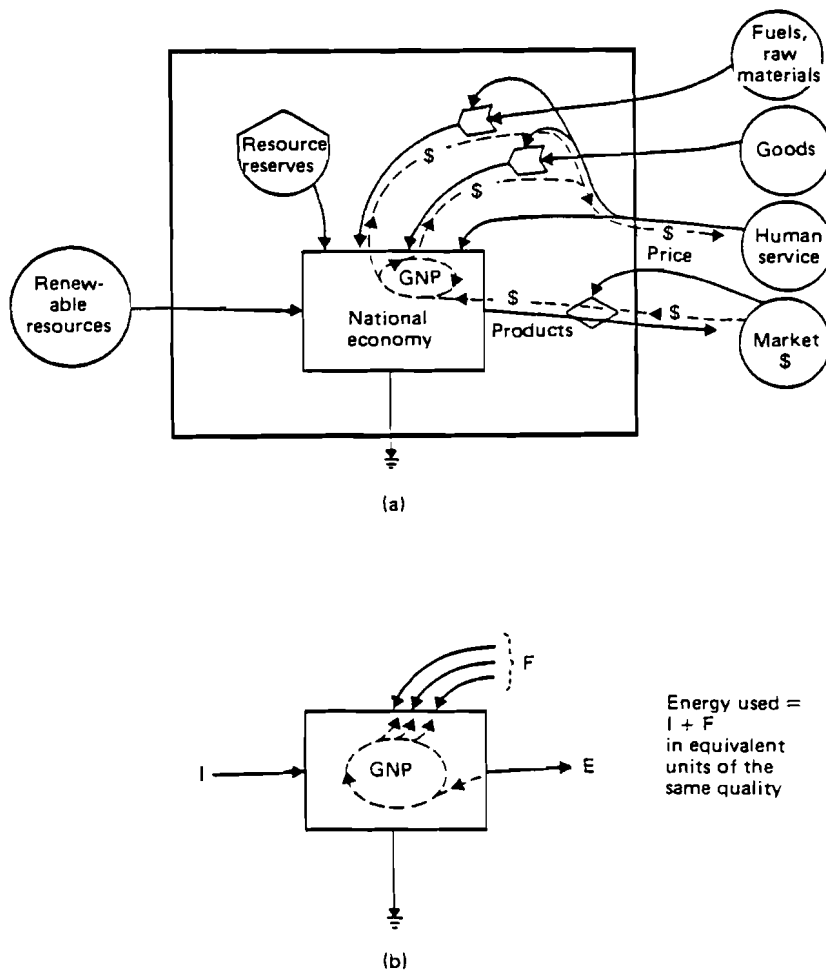
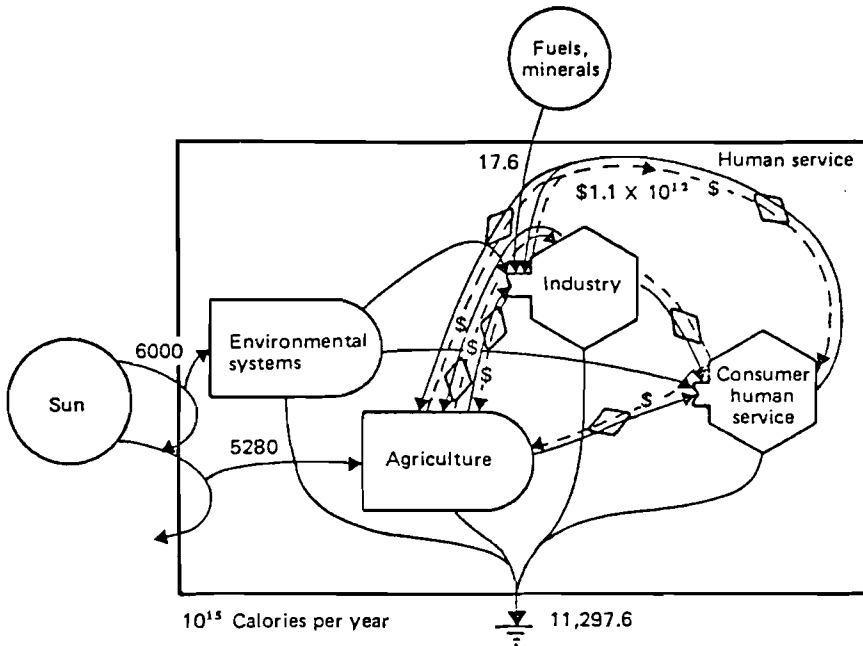
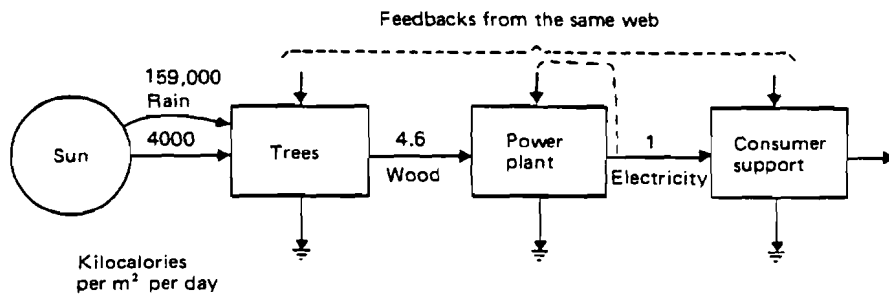

Figure 1.5. Overview diagrams of a national economy. (a) Main flows of dollars and energy; (b) Summary of procedure for summing embodied energy inflows. Exports are subtracted only if they are raw products exported without transformation, such as minerals.



Aggregated model of the economy of the United States in 1974 showing renewable (sun) energy and fuel base that converge in value in labor. Values are flows of actual energy (Odum, 1978).

Figure 1.6. Natural economy aggregated in four sectors showing energy bases.



(a)

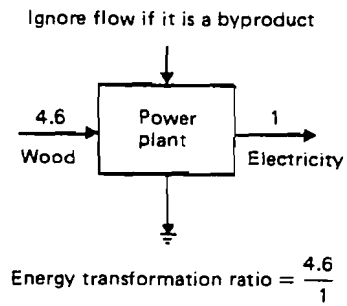

(b)

Figure 1.7. Diagrams illustrating energy quality transformations. (a) Abundant low quality energy is transformed by successive work to higher quality energy on the right; (b) Definition of energy transformation ration which relates energy to that which produces it. See Appendix A5.

This ratio is a useful measure of the quality of an input or product. Tables of energy transformation ratios have been developed from many studies making it easy to convert the data on energy flows of a country into energy values of one type of energy (i.e., solar or coal equivalents). See Section 5 and the Appendix. When the energy flows and storages are expressed in energy equivalents of one type, this expresses the flows and storages in terms of what energy would be required to generate that flow in various necessary transformations. The energy of one type that is required is called the *embodied energy of that type*.

After evaluating a nation's main storages, inputs, and products in units of embodied energy of one type, any pathway may be expressed in dollar equivalents. The percent that an input is of the total national embodied energy budget (including environmental products), is the percent that input is of the gross national product (see Figure 1.8).

Indices and Inferences

After principal flows and storages of a nation have been evaluated in units of embodied solar energy (solar equivalent joules), a number of indices and additional ratios may be calculated to help comparisons among nations, to predict trends, and evaluate alternative policies.

The proportion of embodied energy from within the country compared to that imported is a measure of self sufficiency. The per capita embodied energy is a measure of real standard of living

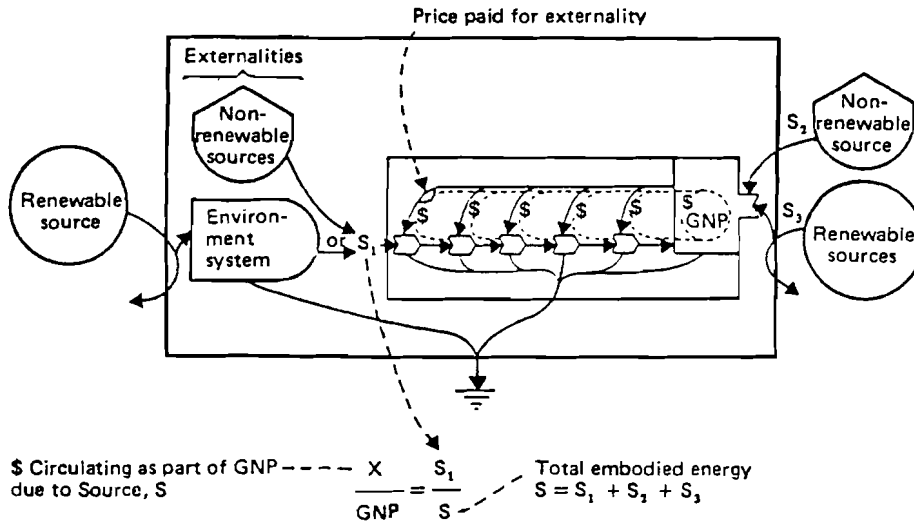

Relation of externalities to dollar circulation in an economy. The ultimate contribution of the environmental sources are much greater than the first price paid at point of entry of the inputs. The calculation of value in dollars per year is made by estimating the proportion the externality is of the total flow of embodied energy. This proportion of the GNP is due to the source evaluated (Odum, 1981).

Figure 1.8. Use of the energy proportion to estimate dollar circulation due to environmental resources.

including the unmonied support of individuals. The embodied energy per unit area is a measure of the intensity of the economy.

The ratio of the total budget of embodied energy to the total dollar circulation in any given year provides a measure of its buying power. This ratio is useful for evaluating those human services that are bought with money. The ability of a nation to support population, to exert influence, or grow is in proportion to the nation's embodied energy storages and flows. These measures can be used to estimate what is possible in programs and plans for development.

The contribution that traded products make to the country which receives them is in proportion to their embodied energy. The money the economy pays for raw products is often far less than the embodied energy in those products (see Figure 1.8). The money paid is for the human service part of the product's embodied energy not for the total work embodied.

A country receiving raw products in trade for finished products gets more stimulus to its economy because it is receiving the result of more useful work. See Figure 1.9. Underdeveloped countries often contribute much more to the economies of other countries when they sell a raw product than if they had used that raw product at home. Money is an inadequate measure of the ultimate economic effect of products in foreign trade.

The energy analysis procedures also allow various alternatives within a country to be analyzed simply in advance to determine if

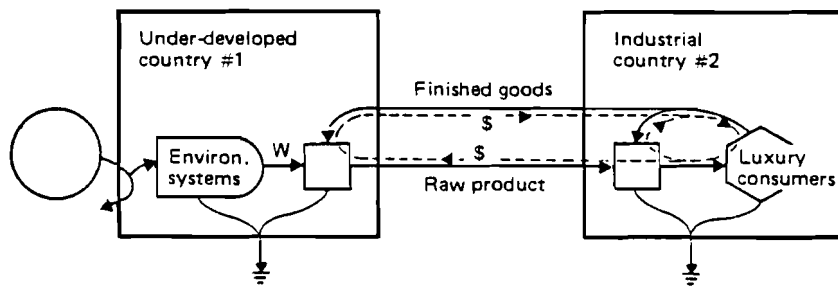

Figure 1.9. Energy and money relations in foreign trade. Although a balance of payments may exist in dollars, more work-stimulating real buying power goes from left to right than is returned from right to left. Work of nature, W, is not recognized in the payments made for the raw products.

the proposed activity will be economic or a drain to the economy. For example, if proposed sources of fuel (primary energy sources) do not yield more embodied energy than is required from the economy, they cannot be used to run the economy. Proposed investments to be economic must yield as much embodied energy for that purchased as competing systems of the same type at home or abroad.

Where a proposed investment involves an environmental resource, an environmental impact, or a change in use of environment, the new system can be judged in advance to be economic if it processes more embodied energy than alternative systems. Often a new system hurts an economy because the displaced former indirect environmental inputs to the economy were larger than the developed ones. The developed ones seemed to be more economic because they involved more visible human service and money-flow locally, whereas the indirect embodied energy supporting the economy was causing more unrecognized money flow in the gross national product. For example, a dam for hydroelectricity may eliminate services already stimulating the economy's real values more, such as migratory fish, wood cutting from self replacing forests, and water quality maintenance.

The energy analysis procedures are also being used for site selections for roads, technological installations, waste disposal processes, housing, etc. Maps of embodied energy help identify localities that should not be disturbed because of the high value of their inputs to the economy.

To help the reader understand the method and as an introduction to the examples of national energy analysis which follow, the procedural steps used to develop each national energy analysis overview are given.

Procedure

1. Assemble data on the country, its economic statistics, its physical statistics, its water budgets, its land use maps and percentages, summaries of its history, accounts of its culture, and major sectors of production by humans and by nature. Table 1.1 is a list of items needed.

2. Assemble as many people as possible who have experience in and knowledge about the country. Gather around a table with one person drawing an energy diagram for the country as others present discuss what they believe to be important parts. Thus a *moderately complex inventory diagram* is prepared for the country and its subsystems showing the main ways things that are being processed and are interacting. An example is given for Austria (Figure 1.10). Symbols are those of the energy circuit language invented for these purposes (see Figure 1.1).

3. From this experience the following lists are made:

(a) *Main flows from sources* include inputs from outside the country including environmental inputs of sun, river, tides, geological inputs, etc., and cultural inputs such as population, information, dollar investments, foreign trade, etc. Also included are flows from the storages (reserves) from within the country if they are being used up faster than replaced. These

Table 1.1. Data needed for energy analysis overview.

GNP or total income

Annual insolation

Coarse land-use map or table of areas (forest, pasture, wilderness, urban area, etc.)

Fuel consumption

Population, immigration

Tonnages and money paid for main imports and exports (i.e., grain, coal, fish, etc.)

Total money in foreign exchange

Rainfall and land elevations of main watersheds

Discharges of major rivers entering and leaving country

Estimated evapotranspiration

Mean winds, winter and summer

Rate of land uplift or rate of soil erosion

Organic content in soils and standing forests

Percentage of economy in main sectors (i.e., health, government, defense, etc.)

Electric generation, use, import, export

Length of coastline (if coastal)

Tidal height (if coastal)

Mean wave height (if coastal)

Economic Statistical Abstract if available

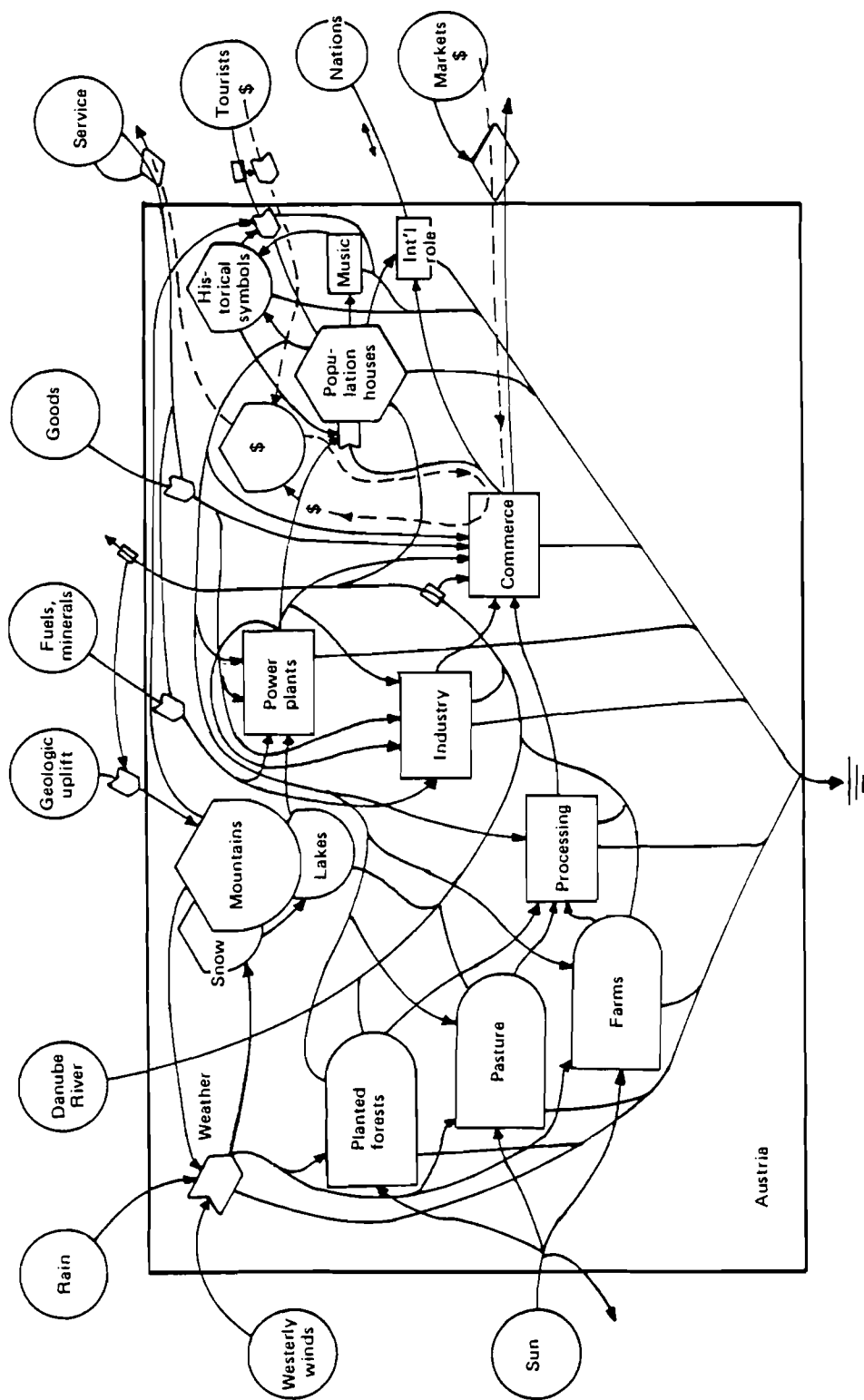

Figure 1.10. Moderately complex overview energy diagram of Austria.

items are evaluated in embodied energy terms in a *Table of Flows*. In diagrams, outside sources are circles placed outside the boundary frame.

(b) *Main storages within the country* often include natural products such as soils, minerals, forests, and ground water and also storages of economic products such as housing assets, transportation assets, and power plants. Items with turnover times less than one year are not included in this list. Items with longer turnover times are the ones evaluated in embodied energy terms in a table entitled *Table of Storages*. In diagrams, storages are tank symbols. Flows from these storages may drive the nation's economy or be exported.

(c) *Major subsystems* are those that need energy analysis (i.e., dams, mining activities, forestry activities, etc.). For these activities separate diagrams are prepared and evaluations made.

4. The Tables of Flows and Storages are evaluated for their embodied energy content in solar equivalents (or coal equivalents). This is done with a standard table format:

Footnote	Item	Actual energy	Energy transformation ratio	Embodied energy
----------	------	---------------	-----------------------------	-----------------

The table is completed with the following procedure:

(a) For each item the actual energy flow or storage is calculated with formulae given in Table 2.1.

(b) The energy transformation ratio (Figure 1.5) if available is taken from Table 3.1 in Section 3. If none is available, one is estimated from an analysis of the process which develops the item. See examples in the Appendices.

(c) The actual energy flow is multiplied by the energy transformation ratio to obtain the value for the final column, the embodied energy in the flow or storage. This is expressed in Calories or joules.

(d) Finally all the calculations and the sources of data and energy transformation ratios are included in a footnote under the main table cited by number or letter in the table.

5. An *aggregated national diagram* is prepared with the items that the evaluation tables showed to be important (contributing 5% or more to the national energy budget). A generic example was given as Figure 4.1. The embodied energy values are written on this diagram. This diagram is now ready for inspection and study to learn which items are relatively more important.

6. The *total embodied energy budget* of the country is calculated. This is the sum of all the inputs which have come from entirely independent sources. Care is required at this point to avoid double counting two inputs which ultimately came from the same source. The global sunlight over the ocean generates rains, winds, waves, and some of the geologic inputs to the country simultaneously. Where there are converging inputs that are really byproducts of the general work of the biosphere operating on sunlight, one selects the largest embodied energy, since this amount of embodied energy includes the inputs that are smaller.

In addition to the input flows of embodied energy from outside the country, there are the embodied energy contributions from use of stored resources within the country such as soils, wood, minerals, and ground water. The rate of use of each of these needs to be included in the *Table of Energy Flows*.

7. Using the total embodied energy flow budget for the country, and the gross national product, an *embodied energy to dollar ratio* is calculated. This ratio is subsequently used to evaluate the energy embodied in goods and services exported and to recognize the currency's relative buying power. This is a gross means of estimating a consumer price index. In Section 4 a table is given for calculating the ratio of total embodied energy used within the country to GNP.

8. Using the estimates of embodied energy flow and storages from the evaluation tables, calculate and assemble indices and ratios that are useful for comparing countries and gaining perspectives. A table is prepared of these indices. See Section 4.

2. CALCULATING ACTUAL ENERGY FLOWS AND STORAGES

After the overview energy diagram has been drawn for a country (Figure 1.2), the main energy flows and long term storages may be calculated using various data on geography, climate, oceanography, and economics for the country. Earlier a manual was developed for environmental energy evaluations (Odum et al. 1983). In this present effort, the principal formulae were modified and assembled as Table 2.1 and 2.2. Units were arranged to yield results in joules whereas the earlier manual had results as kilocalories. For each formula the various data are identified first as words and then with their units, leaving an underlined blank where a data item characteristic of a particular country was substituted. The calculation formats in Tables 2.1 and 2.2 were used in each subsequent section on a different country.

After these rough overview calculations were made for each country, the results constitute a "first law analysis" and if placed on a national energy diagram, it would be a "first law diagram." All inflowing energy must be accounted for in outflows or increases of storages.

However, ability to do work is not proportional to actual energy where energies of different quality are being compared. As explained in Section 4 and calculated in later sections, the actual energy flows and storages were multiplied by energy transformation ratios so as to express all values in solar equivalent units. After this was done, it was possible to see which ones were major and which ones were minor for a country. Thereafter, more care and detail was used to evaluate the flows that turned out to be the major ones.

In general the higher the quality of energy, the less is the actual energy and the higher the solar energy embodied.

Obviously, such overall calculations as geopotential of rain or chemical potential of land uplift are very approximate when done for a whole country using averages. This procedure does indicate immediately which flows are worth more careful calculations; summing one province at a time.

Table 2.1. Formulae used for calculating actual energy flows—joules per year.

DIRECT SUNLIGHT

Area of country is that of land plus continental shelf.

$$(\text{Area of country}) (\text{Average of insolation}) =$$

$$(\text{___ m}^2) (\text{___ J/m}^2/\text{yr}) =$$

KINETIC ENERGY OF WIND USED AT SURFACE

Kinetic energy of wind at 1000m is multiplied by its height, density, eddy diffusion coefficient, the wind gradient, and area of country.

$$(\text{height}) (\text{density}) (\text{diffusion coefficient}) (\text{wind gradient}) (\text{area})$$

$$(1000 \text{ m}) (1.23 \text{ kg/m}^3) (\text{___ m}^3/\text{m}/\text{sec}) (3.154 \text{ E7 sec/y})$$

$$(\text{___ m}/\text{sec}/\text{m})^2 (\text{___ m}^2)$$

Typical values of eddy diffusion and vertical gradient coefficients are:

	Eddy dif- fusion		Vertical gradient	
	January	July	January	July
Flint, Michigan	40.2	8.3	8.0E-3	3.8E-3
Oakland, Calif.	8.4	1.0	4.3E-3	1.6E-3
Tampa, Fla.	2.8	1.7	2.3E-3	1.5E-3

For other data see NRC Manual (Odum et al. 1983).

CHEMICAL POTENTIAL ENERGY IN RAIN

$$(\text{Area including shelf}) (\text{Rainfall}) (G) =$$

Where G is Gibbs free energy of rainwater relative to salt water within evapotranspiring plants or in seas receiving rain.

G is 4.94 J/g . See footnote &.

$$(\text{___ m}^2) (\text{___ m}/\text{yr}) (4.94 \text{ J/g}) (1\text{E6 g/m}^3) =$$

Table 2.1 continued.

CHEMICAL POTENTIAL ENERGY IN RIVER

(Volume flow) (Density) (G) =

where G is Gibbs free energy of river water relative to sea water

$$G = \frac{(8.33 \text{ J/Mole/deg})(300^\circ\text{C})}{(18 \text{ g/mole})} [\text{Log}_e \frac{(1\text{E}6 - S)}{(965,000)} \text{ J/g}]$$

where S is dissolved solids in parts per million.

$$G = (138.8 \text{ J/g}) [\text{Log}_e \frac{(1\text{E}6 - S)}{(965,000)}]$$

$$(\text{--- m}^3/\text{yr}) (1\text{E}6 \text{ g/m}^3) (\text{--- G J/g}) =$$

CHEMICAL POTENTIAL ENERGY WITH WATERS USED WITHIN A COUNTRY

Combine chemical potential energies calculated for rain and rivers:

(Rain) + (Inflowing rivers) - (Outflowing rivers)

If rivers reach the sea within the national boundary, combine:

(Rain) + (Inflowing rivers)

Alternative approach, combine:

(water evapotranspired) + (waters reaching sea within boundaries)

EARTH CYCLE

(Land area) (heat flow per area)

$$(\text{--- m}^2) (\text{--- J/m}^2/\text{y})$$

Heat flow: old, stable, 1 E6 J/m²/y; rapid orogeny, 3-10 E6 J/m²/y

NET UPLIFT

(area) (uplift rate) (density) (0.5) (uplift) (gravity)

$$(\text{--- m}^2) (\text{--- m/y}) (\text{--- E}3 \text{ kg/m}^3) (0.5) (\text{--- m}) (9.8 \text{ m/sec}^2)$$

$$= \text{--- J/y}$$

Table 2.1 continued.

NET LOSS OF EARTH

Loss of clays from the area in river discharge or wind that is in excess of formation rate. See Appendix A18.

Typical formation rate, $31.2 \text{ g/m}^2/\text{y}$

(earth cycle rate) (density)

$$(\text{___E-6 m/y}) (\text{___E6 g/m}^3) = \text{___g/m}^2/\text{y formation}$$

(erosion outflow) - (formation rate) (area of country)

$$(\text{___g/y}) - (\text{___g/m}^2/\text{y}) (\text{___m}^2) = \text{___g/y}$$

Then multiply by ETR/g to get embodied solar energy.

CHEMICAL POTENTIAL ENERGY IN IMPORTED AND EXPORTED COMMODITIES WHOSE VALUE IS USED IN REACTIONS WITH OXYGEN (FOOD, FIBER, WOOD ETC.)

$$(\text{Weight per year}) (G) =$$

where G is the Gibbs free energy of oxidation with atmosphere. For organic substances with high free energies and small entropy changes of state in oxidation, G is practically equal to the bomb calorimetry values of heat of combustion (enthalpy changes). See tables of calorie value in nutrition tables and handbooks. For carbohydrates, starch, wood, etc., about 4 kcal/g; for proteins wool, etc., about 5 kcal/g dry; for fats and oils about 7-9 kcal/g. Multiply by 4186 to represent as joules.

where G (Gibbs free energy) is small, calculate its value from the chemistry of the reaction

$$(\text{___T/yr}) (\text{___G J/g}) (1\text{E6 g/T}) =$$

NET LOSS OF TOPSOIL

Topsoil erosion rate in excess of profile formation rates are evaluated. See Appendix A18. Areas with mature vegetation are assumed to have little net gain or loss of topsoil

Typical formation rate, $1260 \text{ g/m}^2/\text{y}$ or $8.54 \text{ E5 J/m}^2/\text{y}$ in areas in natural vegetation succession.

Typical erosion rates of topsoils from farmed areas Larson et al. 1983 from U.S., are:

	$\text{g/m}^2/\text{y}$		$\text{g/m}^2/\text{y}$
Pacific states	250	Cornbelt, delta area	1000
Mountain states	260	Southeastern states	850
Plains	500	Appalachian states	1250
		Northeastern states	700

Table 2.1 continued.

Actual energy of net loss:

$$\begin{aligned}
 & (\text{farmed area}) (\text{erosion rate}) - (\text{successional area}) (\text{formation rate}) \\
 & (\text{___ m}^2) (\text{___ g/m}^2/\text{y}) - (\text{___ m}^2) (\text{___ g/m}^2/\text{y}) = \text{___ g/y} \\
 & (\text{___ g/y}) (0.03 \text{ organic}) (5.4 \text{ kcal/g}) (4186 \text{ J/kcal}) = \text{___ J/y}
 \end{aligned}$$

or

$$(\text{___ T/m}^2) (\text{___ m}) (\text{___ organic fraction}) (5.4\text{E}6 \text{ kcal/T}) (4186 \text{ j/kcal}) =$$

GEEPOTENTIAL IN INFLOWING RIVERS

(flow volume) (density) (height of river entry - river egress) (gravity)

$$(\text{___ m}^2) (\text{___ m}) (\text{___ m/y}) (1\text{E}3 \text{ kg/m}^3) (9.8 \text{ m/sec}^2) =$$

GEEPOTENTIAL IN RAIN USED

$$\begin{aligned}
 & (\text{area}) (\text{mean elevation**}) (\text{runoff}) (\text{density}) (\text{gravity}) = \\
 & (\text{___ m}^2) (\text{___ m}) (\text{___ m/y}) (1\text{E}3 \text{ kg/m}^3) (9.8 \text{ m/sec}^2) =
 \end{aligned}$$

OCEAN WAVES ABSORBED AT THE SHORE

(shore length) (1/8) (density) (gravity) (height squared) (velocity) =

$$\begin{aligned}
 & (\text{___ m}) (1/8) (1.025\text{E}3 \text{ kg/m}^3) (9.8 \text{ m/sec}^2) (\text{___ m}^2) (\text{___ m/sec}) \\
 & (3.154\text{E}7 \text{ sec/y}) =
 \end{aligned}$$

where velocity is square root of $gd = [(9.8 \text{ m/sec}^2) (\text{___ m deep})]^{1/2}$

TIDE ABSORBED IN ESTUARIES

(area elevated) (0.5) (tides/yr) (height squared) (density) (gravity) =

$$(\text{___ m}^2) (0.5) (706/\text{yr}) (\text{___ m})^2 (1.0253 \text{ E}3 \text{ kg/m}^3) (9.8 \text{ m/sec}^2) =$$

0.5 x height is center of gravity

Table 2.1 continued

TIDE ABSORBED ON CONTINENTAL SHELVES

Same as above multiplied by 0.1 to 0.5.

CHEMICAL POTENTIAL ENERGY IN IMPORTED AND EXPORTED COMMODITIES
WHOSE VALUE IS IN ITS CONCENTRATION**

(Weight per year) (G) =

where G is the Gibbs free energy per unit weight relative to concentration of the commodity in the environment. For example G for iron ore is 14.2, Gilliland et al. (1981).

(___ T/yr) (___ G J/g) (1E6 g/T) =

COAL FLOWS OR OUTFLOWS

(Weight per year) (energy per unit weight) =

(___ T/yr) (3.18 E10 J/T) =

OIL INFLOWS OR OUTFLOWS

(Barrels per year) (energy per barrel)

(___ bbl/yr) (6.28 E9 J/bbl) =

NATURAL GAS INFLOWS OR OUTFLOWS

(Volume of gas/yr) (energy per unit volume) =

(___ thsd cubic ft/yr) (1.1 E9 J/thsd cubic ft.) =

OR

(___ therms/yr) (1.055 E5 J/therm) =

FLOW OF ELECTRIC POWER

(Power Units for a time) (Energy per unit Power for a time)

(___ KWH/yr) (3.60 E6 J/KWH)

OR

(capacity of power plant) (% of capacity) (hours per year)

(energy/unit)

(___ kilowatt) (___ %/100) (1.40 E9 J/kw/yr) =

Table 2.1 continued.

GEOPOTENTIAL IN NET ROCK UPLIFT

(height of Elevated rock) (Area) (rock density) (half of elevation rate) (gravity) =
 $(\text{__mm/yr})^2 (1\text{E-}6 \text{ m}^2/\text{mm}^2) (\text{__m}^2) (\text{__E}3 \text{ kg/m}^3) (0.5) (\text{height}) (9.8 \text{ m/sec}^2) =$

ELECTRICAL OUTPUT OF NUCLEAR PLANTS

Evaluate electricity delivered
 $(\text{__KWH}) (3.6 \text{ E}6 \text{ J/KWH})$

HEAT PRODUCTION OF FISSION

(Weight of uranium used per time) (fraction U 235) (Energy per unit U 235)
 $(\text{__T/yr U}_3\text{O}_8) (0.007) (1 \text{ E}6 \text{ g/T}) (7.95 \text{ E}10 \text{ J/gU}235)$

EMBODIED ENERGY IN IMPORTED OR EXPORTED SERVICE

$(\$ \text{ paid for Imports}) (\text{Ratio of SEJ/\$ for that year})^\ddagger$

Footnotes to Table 2.1.

- * Where data are in kilocalories (kcal), multiply by 4186 J/kcal.
- + Conventions for exponents, 2×10^7 is 2E7, 5×10^{-3} is 5E-3.
- ** Elevation measured relative to low point on the nation's border where rivers leave the country.
- & Gibbs free energy for 10 ppm rain relative to sea water salinity in evapotranspiring plants or to estuaries receiving freshwaters.

$$G = \frac{RT}{w} \log_e C_2/C_1 = \frac{(8.33 \text{ J/mole/deg}) (300^\circ\text{C})}{(18 \text{ g/mole})} [\log_e \frac{(999,990)}{(965,000)}]$$

$$2.3 \log_{10} \frac{999,990}{965,000} = .0355$$

$$= 4.94 \text{ J/g} = 4.94\text{E}6 \text{ J/m}^3 \text{ rainwater,}$$

Footnotes to Table 2.1 continued.

++ Effective concentration is that solution concentration in equilibrium with solid. For solids it is the solution concentration in which they are used. Environmental concentration is the solution concentration of waters in the soils and surface waters of the nation. Molecular weight is the mean molecular weight of the effective components of the commodity.

$$G = \frac{(8.33 \text{ j/mole/deg}) (300^{\circ}\text{C})}{(\text{Effective molecular weight})}$$

$$[\text{Log}_e \frac{(\text{Effective concentration})}{(\text{Environment concentration})}] \text{ J/g}$$

Gibbs free energy of a chemical reaction is that of its standard states (gas at 1 atmosphere, solutions at 1 molar, and solids with assumed activity = 1) plus a term for the concentration differences from standard state that includes products in numerator and reactants in denominator of logarithmic term

$$\Delta G = \frac{\Delta G_o}{W} + \frac{RT \text{ Log}_e \frac{(c)(d)}{(a)(b)}}{W} \text{ J/g}$$

where G_o is obtained using standard free energy tables, W is molecular weight of commodity, (c) and (d) are concentrations of products, (a) is concentration of commodity, (b) is pressure of oxygen (0.21), R is 8.33 J/Mole/deg, and T is Kelvin Temperature.

‡ See Figure 4.2.

Table 2.2. Formulae used for calculating actual energy in storages.

GEOHERMAL HEAT STORAGE POTENTIAL

$$\begin{aligned}
 & (\text{resevoir volume}) (\text{density}) (\text{specific heat}) (\Delta T)^2 (1/T) (0.5) \\
 & (\text{__m}^3) (1\text{E}6\text{cm}^3/\text{m}^3) (\text{__g}/\text{cm}^3) (\text{__gcal}/\text{g}/\text{deg}) (\text{__}^\circ)^2 (1/\text{__}^\circ\text{K}) (0.5) \\
 & (4.186 \text{ J/gcal}) =
 \end{aligned}$$

POTENTIAL ENERGY IN STORED ORGANIC MATTER (FUELS, SOIL, PEAT, WOOD, ETC.)

$$(\text{volume of material}) (\text{density}) (\text{organic fraction}) (G)$$

$$\text{where } G = (\text{__kcal}/\text{g}) (4186 \text{ j/kcal})$$

$$(\text{__m}^3) (1\text{E}6\text{cm}^3/\text{m}^3) (\text{__g}/\text{cm}^3) (\text{__organic}) (\text{__G}) =$$

Typical soil: 5.4 kcal/g; fraction organic; 0.03 g/g;
density, 1.47 g/m³

$$\begin{aligned}
 & (1 \text{ E}6 \text{ cm}^3/\text{m}^3) (1.47 \text{ g}/\text{cm}^3) (0.03) (5.4 \text{ kcal}/\text{g}) (4186 \text{ J/kcal}) \\
 & = 10.0 \text{ E}8 \text{ J}/\text{m}^3
 \end{aligned}$$

OR

$$(\text{Weight}) (\text{chemical potential energy per unit weight})$$

$$(\text{__T}) (1\text{E}6 \text{ g}/\text{T}) (\text{__kcal}/\text{g}) (4186 \text{ J/kcal})$$

OR for fuel gas

$$(\text{volume}) (\text{chemical potential energy per volume})$$

$$(\text{__thsd cubic feet}) (1.05\text{E}9 \text{ J}/\text{thsd cubic feet})$$

GEOPOTENTIAL OF ELEVATED MATERIALS [WATER, MOUNTAINS (ROCK) ETC]

$$\begin{aligned}
 & (\text{volume}) (\text{density}) (\text{gravity}) (\text{height of center of gravity} \\
 & \text{of mass})
 \end{aligned}$$

$$(\text{__m}^3) (1\text{E}6 \text{ cm}^3/\text{m}^3) (\text{__g}/\text{cm}^3) (1\text{E}-3 \text{ kg}/\text{g}) (9.8 \text{ m}/\text{sec}^2) (\text{__m})$$

Table 2.2 continued.

CHEMICAL POTENTIAL ENERGY OF WATER AND GROUNDWATER STORAGE

(Water volume) (density) (G)

where G is Gibbs free energy of water relative to salt water

$$G = \frac{(8.33 \text{ J/mole/deg}) (300^{\circ}\text{C})}{(19 \text{ g/mole})} [\text{Log}_e \frac{(1\text{E}6 - S)}{(965,000)}] \text{ J/g}$$

where S is ppm solutes,

To estimate volume of ground waters:

(Volume of land mass) (porosity fraction)

$$(\text{___m}^3) (\text{___}) = (\text{___m}^3)$$

Typical porosities:	Shale	.10
	Granite	.05
	Limestone	.10
	Basalt	.10
	Sands	.25
	Gravels	.40

$$(\text{___m}^3) (1\text{E}6 \text{ g/m}^3) (\text{___G}) =$$

CHEMICAL POTENTIAL ENERGY OF MINERAL DEPOSITS

(Volume) (density) (G)

where G is Gibbs free energy of the mineral relative to the surrounding environment in which it is used, dispersed or destroyed in chemical reactions,

For common minerals typical values for G are:

Table 2.2 continued.

	<u>J/g</u>	Appendix
Phosphate deposits	58.3	6, note 4
Copper ore	1.65	
Bauxite (Al ore)	65.3	12
Iron ore	14.2	13
Potassium (KCl)	702.0	15, note 8
Nitrogen (NH ₃)	2170.0	16, note 3

CHEMICAL POTENTIAL ENERGY OF BEDROCK READILY AVAILABLE (UPPER 10 m)

$$(\text{Volume}) (\text{density}) (G) =$$

where G is the Gibbs free energy of the bed rock relative to states after weathering.

Typical values of G are:

	<u>Density, g/cm³</u>	<u>G, J/g</u>
Shale	2.40	100
Sand, sandstone	3.17	611
Limestone	1.95	50
Granite	2.61	50
Basalt	2.79	172

$$(\text{___ m}^3) (1E6 \text{ cm}^3/\text{m}^3) (\text{___ g/cm}^3) (G) =$$

NUCLEAR ENERGY

Heat equivalents from Schipper (1975)

(Weight of Uranium ore) (Fraction U235 in ore) (heat per weight)

$$(\text{___ T}) (0.007) (1E6 \text{ g/T}) (7.95E10 \text{ J/g U235})$$

3. ENERGY TRANSFORMATION RATIOS AND CALCULATION OF EMBODIED ENERGY

The energy transformation ratio measures the joules of one type of energy that must be transformed to generate a joule of another type of energy. The ratio measures the factor by which one type of energy must be utilized to generate an energy of higher quality. Figure 3.1 is an example where the energy transformation ratio, in terms of energy of the type A on the left, is 20 joules of type A per joule of type B.

Examination of the transformation ratios in real systems that have been operating for long periods under competitive circumstances, provides ratios that may approach the maximum that can be transformed at competitive, full power conditions.

If all kinds of energy are expressed in terms of solar energy reaching earth, the ratio becomes a numerical scale of the amount of work involved in generating various types of energy. Since flexibility, scarcity and ability to amplify increase as the energy transformation ratios from sunlight increase, the ratios constitute a scale for measuring energy quality.

The energy transformation ratios provide an easy shorthand for calculating embodied energies in units of one type, simply by multiplying the actual energy flow or storage of one type by its solar energy transformation ratio. To obtain energy transformation ratios from real world measurements, one constructs a systems diagram in which all of the inputs are known. Then these are all converted to embodied energies of solar quality using available energy transformation ratios. Then the ratio

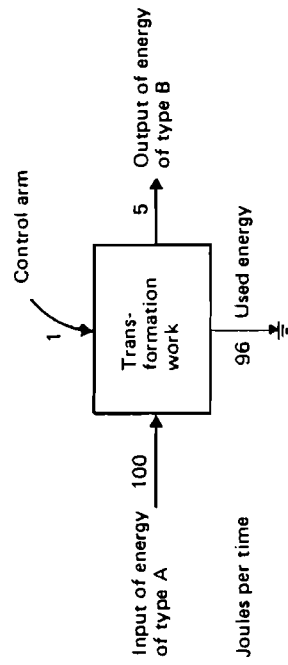

$$\text{Energy transformation ratio} = \frac{A}{B} = \frac{100}{5} = 20$$

Figure 3.1. Definition of energy transformation ratio when the control arm input is a feedback from B and can be ignored as it is not an energy source.

for the commodity is calculated by dividing the sum of inputs expressed in solar equivalent joules by actual output energy in the commodity produced. An example of this procedure is given in Figure 3.2. Others are given in the Appendix.

A table of energy transformation ratios is given in Table 3.1. Many of these ratios were used in various evaluations of flows and storages in national energy analyses in later chapters. Many of the system energy diagrams that were evaluated to calculate energy transformation ratios in Table 3.1 are assembled as an Appendix.

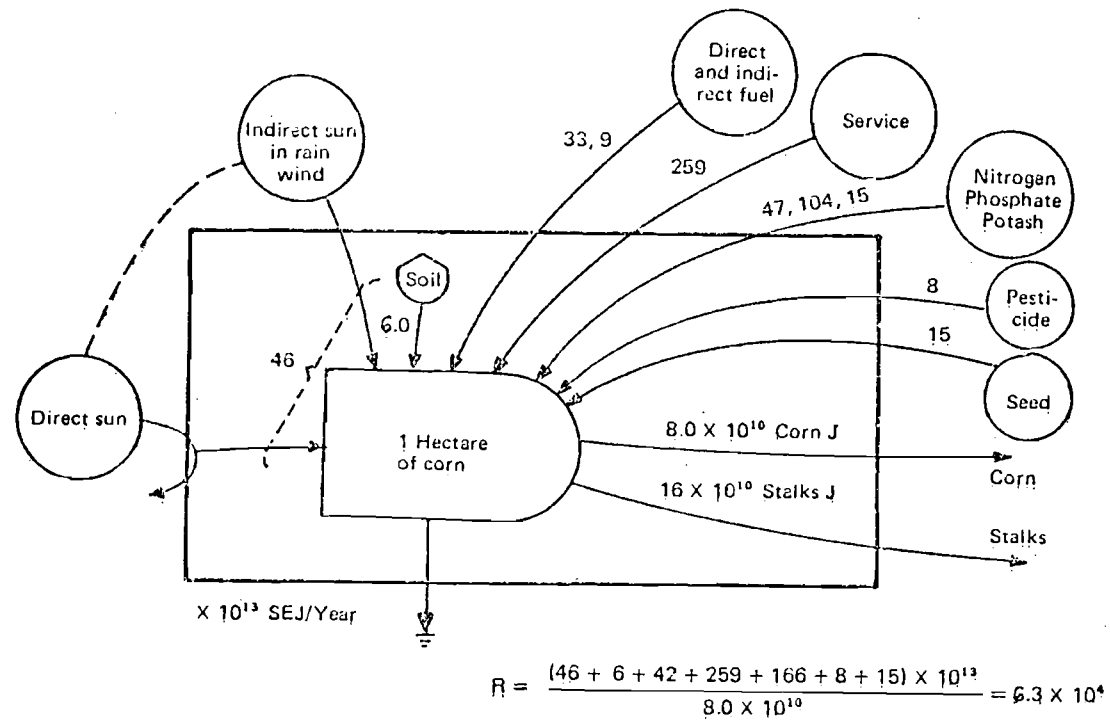

Figure 3.2. Energy diagram of industrial corn production.

Table 3.1. Energy transformation ratios from solar energy used.

Footnote	Energy type	Energy transformation ratio Solar equivalent joules per joule SEJ/J
1	Solar energy	1.0
2	Surface winds: vapor gradient- kinetic energy-	62.0 623.0
3	Tides	23564.0
4	Physical energy in elevated rain	8888.0
5	Physical energy in elevated river flow	23564.0
6	Chemical potential energy in rain: over land- in rivers-	15423.0 41068.0
7	Waves absorbed at shore	25889.0
8	Earth cycle Net uplift- Geothermal heat (Appendix A2) Geothermal convection (Appendix A3)	2.90 E4 5.5 E18 6.1 E3 1.8 E4
9	Iron, 9.13 E14 SEJ/T Steel, 1.78 E15 SEJ/T Machinery, 6.7 E15 SEJ/T Aluminum ingots, 1.63 E10 SEJ/T	10.1 E6 1.97 E7 7.50 E7 -
10	Phosphate rock 1.41 E10 SEJ/g Nitrogen fertilizer Potassium fertilizer Iron ore, 8.55 E8 SEJ/g Bauxite, 8.5 E8 SEJ/g	4.14 E7 1.69 E6 2.62 E6 6.01 E7 1.32 E7
11	Fuels: Rainforest wood harvested Coal Oil Electricity Natural gas Liquid motor fuel, ethanol Ethanol Corn stalks Straw Dung	3.49 E4 3.98 E4 5.3 E4 15.9 E4 4.8 E4 6.6 E4 6.0 E4 3.0 E4 4.3 E3 2.7 E4
12	Primitive corn Industrial corn Sugar Bananas Coconuts Coconut oil Copra	2.7 E4 6.8 E4 8.4 E4 5.3 E5 1.9 E4 1.2 E4 6.9 E5
13	Rubber Soap Wool	2.1 E4 7.2 E5 3.8 E6

Table 3.1 continued

Footnote	Energy type	Energy transformation ratio Solar equivalent joules per joule SEJ/J
14	Primitive labor	8.1 E4
	Bullock work	1.23 E5
15	Sheep meat	1.71 E6
	Calves	4.0 E6
	Milk	2.2 E5
	Butter	1.3 E6
16	Selected high quality logs	31.1 E5
	plantation pine	6.7 E3
17	Top soil	6.3 E4
	Earth (clay), 1.71 E9 J/g	-
18	Uranium	1.8 E3

Footnotes to Table 3.1.

1. Solar energy input absorbed, 3.93 E24 J/yr. See Appendix 1. Energy transformation ratio is 1 by definition.

2. Wind used at surface of the earth estimated as 10% of total flux of wind energy, 2E12 kw (Monin 1972).

$$(2 \text{ E12 kw}) (1 \text{ J/sec/watt}) (1 \text{ E3 w/kw}) (3.154 \text{ E7 sec/yr})$$

$$(0.10) = 6.31 \text{ E21 J/yr}$$

ETR as ratio of total biosphere input, 3.93 E24 SEJ/yr (Appendix 2) to surface wind energy:

$$\frac{3.93\text{E}24 \text{ SEJ/yr}}{6.31 \text{ E21 J/yr}} = 623. \text{ SEJ/J surface wind}$$

Water vapor gradient in wind

Total mass of water in atmosphere = 1.24 E19 g; turnover time for water in the atmosphere = 11.23 d (Monin 1972); mean flux of vapor, 1.24 E19 g/11.23 d = 1.104 E18 g/d.

Gibbs free energy per gram =

$$\frac{(8.33 \text{ J/mole/deg}) (275 \text{ deg}) \text{Log}_e (7\text{mb}/2\text{mb})}{(18 \text{ g/mole})}$$

$$= 159 \text{ J/g vapor}$$

World vapor gradient flux:

$$(1.104 \text{ E18 g/d}) (365 \text{ d/y}) (159 \text{ J/g}) = 6.41 \text{ E22 J/y}$$

$$\text{ETR: } \frac{(3.94 \text{ E24 SEJ/y})}{(6.41 \text{ E22 J/y})} = 61.5$$

Footnotes to Table 3.1 continued.

3. Tidal physical energy absorbed in estuaries and on shelves. Energy transformation ratio the same as that for elevated stream waters.

4. Physical energy in rain on elevated land.

World's rain on land, $105,000 \text{ km}^3/\text{yr}$; average elevation of land, 875 m (Ryabchikov 1975).

$$(1.05 \text{ E}5 \text{ km}^3) (1 \text{ E}12 \text{ kg.km}^3) (9.8 \text{ m/sec}^2) (8.75 \text{ E}2 \text{ m}) \\ = 9.0 \text{ E}20 \text{ J/yr}$$

$$\text{ETR: } \frac{8.0 \text{ E}24 \text{ SEJ/yr}}{9.0 \text{ E}20 \text{ J/yr}} = 8888. \text{ SEJ/J}$$

5. Physical energy in stream flow.

Global runoff, $39.6 \text{ E}3 \text{ km}^3/\text{yr}$ (Todd 1970); average elevation, 875 m

$$(39.6 \text{ E}3 \text{ km}^3/\text{yr}) (1 \text{ E}12 \text{ kg/km}^3) (9.8 \text{ m/sec}^2) (875 \text{ m}) = \\ = 3.395 \text{ E}20 \text{ J/yr}$$

$$\text{ETR: } \frac{8.0 \text{ E}24 \text{ SEJ/yr}}{3.4 \text{ E}20 \text{ J/yr}} = 2.36 \text{ E}4 \text{ SEJ/J}$$

6. Chemical potential energy in rain.

Continental rain $105,000 \text{ km}^3/\text{yr}$, 10 ppm rain compared to 35,000 ppm.

$$\text{Gibbs free energy/g} = \frac{(8.33 \text{ J/Mole/deg}) (300^\circ\text{C})}{(18 \text{ g/mole})}$$

$$\text{Log}_e \frac{(999,990)}{(965,000)} = 4.94 \text{ J/g}$$

$$(1.05 \text{ E}5 \text{ km}^3/\text{yr}) (1 \text{ E}15 \text{ g/km}^2) (4.94 \text{ J/g Gibbs free energy}) \\ = 5.187 \text{ E}20 \text{ J/yr}$$

6A. Chemical potential energy in rivers.

Rivers represent concentration over water dispersed as rain. A transformation ratio for world average river is given: global runoff, $39.6 \text{ E}3 \text{ km}^3/\text{y}$, typical dissolved solids, 150 ppm.

Footnotes to Table 3.1. continued

Gibbs free energy per gram water:

$$= \frac{(8.33 \text{ J/mole/deg})(300^{\circ}\text{C})}{(19 \text{ g/mole})} = \text{Log}_e \frac{(999,850)}{(965,000)}$$

$$(3.96 \text{ E}19 \text{ cm}^3/\text{y})(0.99985 \text{ g/cm}^3)(4.92 \text{ J/g}) = 1.948 \text{ E}20 \text{ J water/y}$$

$$\text{ETR: } \frac{(8.0 \text{ E}24 \text{ SEJ/Y})}{(1.948 \text{ E}20 \text{ J water/y})} = 4.11 \text{ E}4 \text{ SEJ/J river water}$$

$$\text{ETR: } \frac{8.0 \text{ E}24 \text{ SEJ/yr}}{5.187 \text{ E}20 \text{ J/yr}} = 15423 \text{ SEJ/J}$$

7. Wave energy absorbed at shore estimated as the energy of average wave coming ashore (Kinsman 1965) multiplied by facing shorelines.

$$(1.68 \text{ E}8 \text{ kcal/m/yr})(4.39 \text{ E}8 \text{ m})(4186 \text{ J/kcal}) = 3.09 \text{ E}20 \text{ J/yr}$$

$$\text{ETR: } \frac{8.0 \text{ E}24 \text{ SEJ/yr}}{3.09 \text{ E}20 \text{ J/yr}} = 25889 \text{ SEJ/J}$$

8. Earth cycle

Work of earth uplift replacing erosion without net change in elevation indicated by heat flow. From Sclater et al. (1980); continental heat flow is $2.746 \text{ E}20 \text{ J/y}$; solar equivalents from Appendix A3.

$$\text{ETR: } \frac{(8.0 \text{ E}24 \text{ SEJ/y})}{(2.746 \text{ E}20 \text{ S/y})} = 2.90 \text{ E}4 \text{ SEJ/J continent heat flow}$$

Net uplift

Land elevation, 875 m over 1 billion years; density 2.6 T/m^3 ;
 (area)(uplift per time)(density)(0.5)(uplift per time)(9.8 m/sec^2)
 $(1.5 \text{ E}14 \text{ m}^2)(875 \text{ m}/1 \text{ E}9 \text{ y})(2.62 \text{ E}3 \text{ kg/m}^3)(0.5)(875 \text{ m}/1 \text{ E}9 \text{ y})$
 $(9.8 \text{ m/sec}^2) = 1.47 \text{ E}6 \text{ J/g}$; see Appendix A8.

$$\text{ETR: } \frac{(8.0 \text{ E}24 \text{ J/y})}{(1.47 \text{ E}6 \text{ J/y})} = 5.44 \text{ E}18 \text{ SEJ/J}$$

9. Iron, steel, machinery; see Appendix A13; aluminum ingots, see Appendix A12.

Footnotes to Table 3.1. continued.

10. Phosphate, see Appendix A6, note 4.
Potassium, see Appendix A15
Iron ore, see Appendix A7.
Bauxite, see Appendix A7.
Nitrogen, see Appendix A16.
11. Fuels, see Appendix A5, Parts 1-3; ethanol, Appendix A17.
Corn stalks, Appendix A9; straw and dung, Appendix A19.
12. Corn, Appendix A9; sugar, Appendix A17; bananas, Figure 9.4;
Coconuts, Figure 9.5.
13. Rubber, see Figure 7.5; soap, Figure 9.5; wool, Appendix A11.
14. Human Labor.

Hand labor as in primitive agriculture, the energy per area of support; Gibbs free energy in rain, 4.94 J/g from footnote 6, Table 3.1.

$$(4.94 \text{ J/g}) (1 \text{ E6 g/m}^3) (1 \text{ A/person}) (0.405 \text{ Ha/A}) (1 \text{ m}^3/\text{m}^2) \\ (1 \text{ m}^3 \text{ rain/m}^2) (1 \text{ E4 m}^2/\text{Ha}) = 2.00 \text{ E10 J/person}$$

Embodied energy per person:

$$(2.0 \text{ E10 water J/person}) (1.54 \text{ E4 SEJ/J water}) \\ = 3.09 \text{ E14 SEJ/person/y}$$

$$\text{ETR: } \frac{3.09 \text{ E14 SEJ/person}}{(2500 \text{ kcal/person/day}) (4186 \text{ J/kcal}) (365 \text{ d/y})}$$

$$= 8.09 \text{ E4 SEJ/J}$$

See also Appendix A9a.

15. Sheep meat, Appendix A11; calves, butter, milk, Appendix A19.
16. Selected high quality rain forest timbers shipped. See Figure 7.6; plantation pine, see Appendix A10.

Footnotes to Table 3.1. continued.

17. Top soil, see Appendix A18.

18. Uranium in fission reactor

109 E13 kcal U235 generated 4.9 E13 kcal net

Coal equivalents of electricity (Kylstra and Ki Han 1975)

$$\frac{109. E13 \text{ kcal U235}}{4.9 E13 \text{ coal kcal}} = 22.2 \text{ uran J/coalJ}$$

$$\frac{3.98 E4 \text{ SEJ/coalJ}}{22.2 \text{ uran J/coalJ}} = 1793 \text{ SEJ/uran J}$$

4. SUMMARIZING PARAMETERS FOR NATIONAL OVERVIEW

As described in Section 1, energy systems analysis provides a way to gain an overview of a nation's economy and its basis in its resources and foreign trade. Embodied energy calculations, indices, and ratios provide overview perspectives on causes, trends, and alternative public policies.

Ratio of Embodied Energy Flow to Dollar Circulation

For each nation there is a ratio of embodied solar energy generating economic value each year and the currency circulating in that country that year. As evaluated in this study, all the contributing embodied energy flows are included, those of environmental renewable sources, those of nonrenewable resources within the country, and those of imported commodities including human services from outside.

In Figure 4.1 the main categories of energy flow contributing to the buying power of the economy are shown. The embodied energy used within the country is the sum of inputs minus unused exports. See Table 4.1.

Human service is the final sector toward which most other environmental, industrial, and commercial sectors converge their work in hierarchical organizations of humanity and nature. The total embodied energy of the nation's economy used within the country was taken as the basis for the nation's human services for which monies were circulated from human to human. Gross national product is a traditional measure of circulation of money through people. The ratio between the total embodied energy

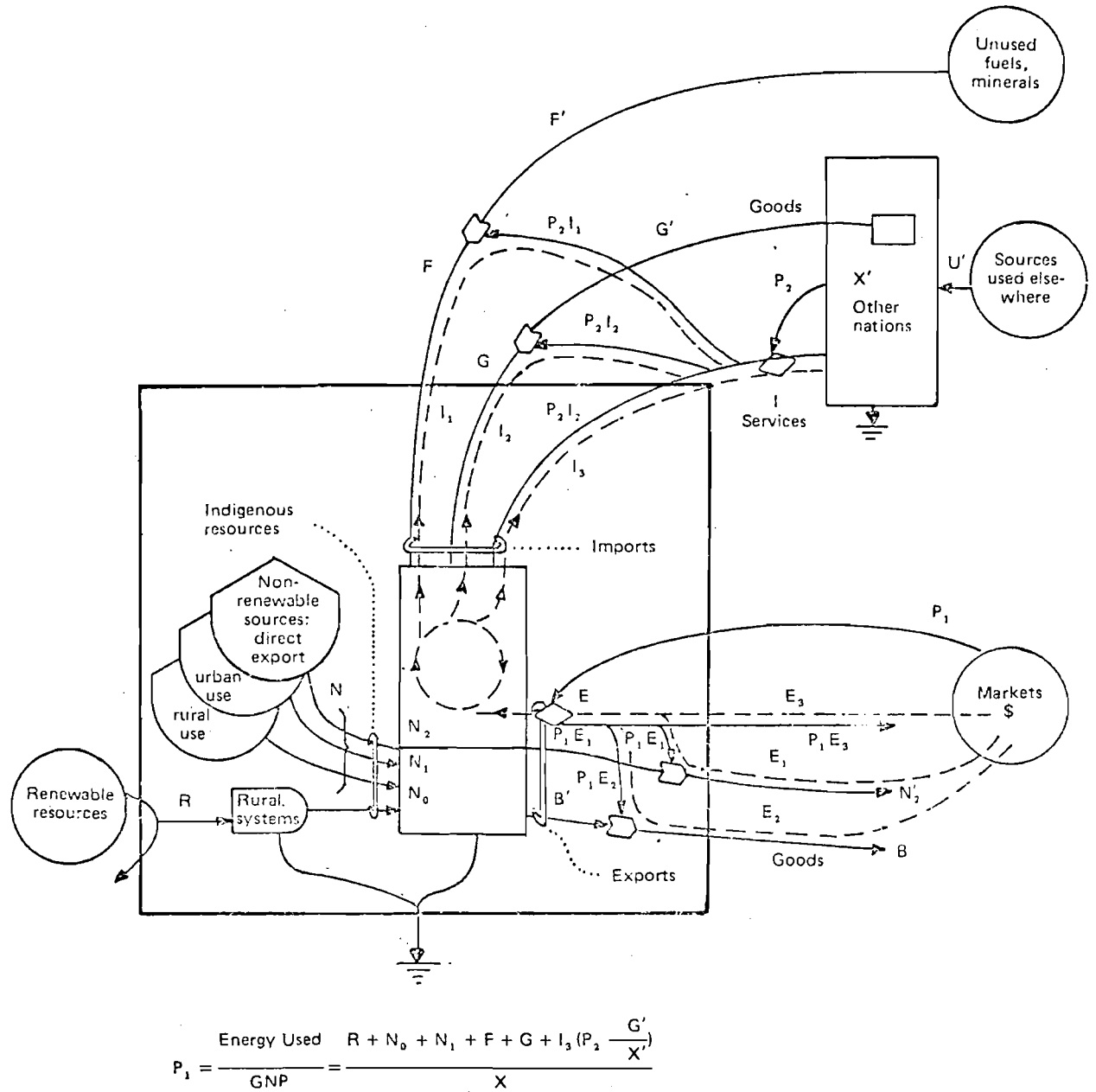

Figure 4.1. Summary diagram of the embodied energy flows of a country. An evaluation table is given as Table 4.1. Indices from these values are calculated in Table 4.2.

Table 4.1. Summary flows for a nation (see Figure 4.1).

Letter in Figure 4.1	Item
R	Renewable sources used, SEJ/y
N	Non-renewable sources flow from within the country (SEJ/yr): N ₀ dispersed rural source (SEJ/y) N ₁ concentrated use (SEJ/yr) N ₂ exported without use (SEJ/y)
F	Imported minerals and fuels (SEJ/y)
G	Imported Goods (SEJ/yr)
P ₂ I	Imported Service (SEJ/yr)
I	Dollars paid for imports (\$/y)
E	Dollars paid for exports (\$/y)
P ₁ E	Exported Services (SEJ/y)
B	Exported Products, transformed within the country (SEJ/y)
X	Gross National Product (\$/y)
P ₂	Ratio embodied energy to dollar of imports (SEJ/\$)
P ₁	Ratio embodied energy to dollar within the country and for its exports (SEJ/\$)

used and the gross national product indicates the real work equivalent of a unit of currency spent for human service.

As the diagram in Figure 4.1 shows all money goes to human service only. Even when one buys fuels or goods, the money is for the human service in processing the fuels or goods, only indirectly for externalities of energy and materials from the environment. The environment never receives money for its work.

Since undeveloped countries have large ratios of embodied energy supporting a small monied economy, the embodied energy to dollar ratios are larger than in developed countries. This means that the money buys more of nature's work in the undeveloped country although it may not be recognized that nature's work is flowing to people, much of it indirectly in providing cheap wood, soils, clean air, clean water, cheap waste disposal, cheap foods, etc.

When a purchase is made from another country, it is that country's embodied energy-to-dollar ratio that determines how much real service one can purchase. In order to evaluate imports to a country, the embodied energy in the services of the country from which imports come was used. If imports are from a developed country, the ratio for the United States was used. As given in Appendix A4, this ratio includes renewable energy and fuel used both on solar equivalent basis. In evaluating the embodied energy in services exported, the country's own ratio of embodied energy-to-dollar ratio was used.

In calculating the embodied energy used by the country, flows of products that pass without work transformations (N_2) are omitted since they were not used within the country's economy. See, for example, the flow of iron ore from Liberia. It might be reasoned that other exports should be subtracted also. However, if the export product or service has been generated by transformations within the economy, its embodiment represents energy already used. For definition of the energy-dollar ratio within a country, see expression in Figure 4.1.

Services

As shown in Figure 4.1, money paid for imports and derived from exports or other inputs circulates as part of the gross national product (x). Some care is required to evaluate the energy embodied in these services using energy-dollar ratios (P_2 and P_1) and dollar flows (dashed lines). It is easy to double count although double counting errors are usually small. Figure 4.1 shows relationships of the following:

Evaluation of fuels and minerals (F , N₂)

When imports of fuels and minerals are estimated using total energy transformation ratios, embodied energy of services of bringing the mineral (P_2I_1 or P_1E_1) is included.

Evaluation of goods (G , B)

If imported or exported goods are evaluated with energy transformation ratios because they are of special interest or are energy intensive, embodied energy of services (P_2I_2 or P_1E_2) is included.

Evaluation of miscellaneous services (P₂I₃, P₁E₃)

Services not included in bringing minerals or goods evaluated separately are evaluated with energy dollar ratios (P_1 or P_2) multiplied by remaining dollar flow (I_3 or E_3). As the Figure 4.1 shows, to avoid double counting one must subtract any dollar flow already included from the total dollar flow (I or E) before multiplying energy-dollar ratio to obtain embodied energy contribution. If goods have been evaluated separately, the energy used directly in making the goods is already included in the goods evaluation. Consequently the energy in goods must be subtracted

from the evaluation of miscellaneous services also. This can be done subtracting B' or G' from energy of energy-dollar ratio. The corrected ratios are: $(P_2 - \frac{G}{X})$ or $(P_1 - \frac{B'}{X'})$

Analysis without evaluating goods separately; goods and service

When no goods are evaluated separately, the analysis of imports and exports contains only the unused energy of minerals and the evaluation of service.

By using energy-dollar ratio to evaluate services, one is including the energy for goods as well. Sometimes we call this category goods and services.

Subsystems

In chapter 5, steps to evaluate services in subsystems are given so that double counting is avoided there as well.

The following important property of the embodied energy concept is quite different from the first law which makes actual energies additive. To avoid double counting when evaluating embodied energy, an energy flow that is a by-product of another energy flow is not counted separately. Where both have the same source, the one with the larger embodied energy is used, for it includes the energy used to generate the second flow with less embodied energy. The second flow is less because some of it was diverted to another part of the globe.

The energy dollar ratios of countries change with inflation, and the ratio may be one of the best measures of inflation. Figure 4.2 is a graph of the overall embodied energy to dollar ratio of the United States. This graph is useful for converting dollar data from various years to embodied energy of services,

Indices Using Embodied Energy for National Overview

Various flows calculated in Table 4.1 are combined in various ways in Table 4.2 to provide perspectives on national overview, to compare countries, and to suggest public policies. Relative roles of renewable, nonrenewable, imports, concentrated, and rural energies are examined. Self-sufficiency, energy concentration per area, and energy per person as an index of living standard are calculated.

Carrying capacity is the number of people that can be supported at a stated standard of living. This is estimated for current sources and for development in which outside resources are attracted in a ratio of 7 to 1 typical of the developed countries. Also included is the carrying capacity on renewable resources only.

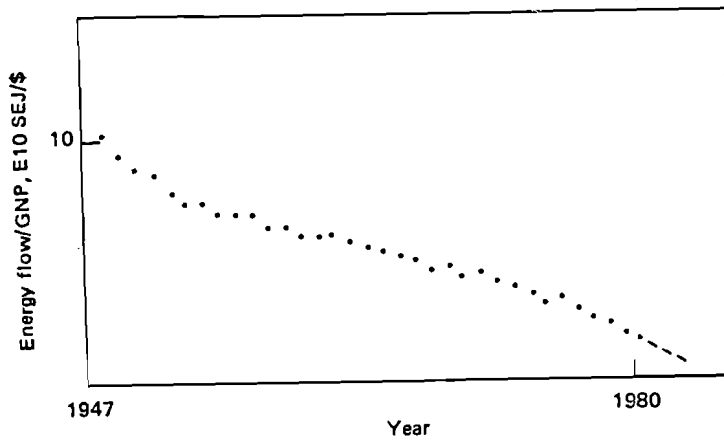

Figure 4.2, Ratio of embodied solar energy flow to GNP in the United States. Energy was estimated as the sum of solar equivalents of rain (Gibbs free energy) and the solar equivalents of oil. See Table A4b.

Table 4.2. Indices using embodied energy for national overview.

Item	Name of Index	Expression See Figure 4.1
1	Renewable embodied energy flow	R
2	Flow from indigenous nonrenewable reserves	N
3	Flow of imported embodied energy	$F+G+P_2I$
4	Total embodied energy inflows	$R+N+F+G+P_2I$
5	Total embodied energy used, U	$U = N_0+N_1+R+F+G+P_2I$
6	Total exported embodied energy	$B+P_1E$
7	Fraction of embodied energy used derived from home sources	$(N_0+N_1+R)/U$
8	Exports minus imports	$(N_2+B+P_1E) - (F+G+P_2I)$
9	Ratio of exports to imports	$(N_2+B+P_1E)/(F+G+P_2I)$
10	Fraction used, locally renewable	R/U
11	Fraction of use purchased	$(F+G+P_2I)/U$
12	Fraction used that is imported service	P_2I/U
13	Fraction of use that is free	$(R+N_0)/U$
14	Ratio of concentrated to rural	$(F+G+P_2I+N_1)/(R+N_0)$
15	Use per unit area	$U/(\text{area})$
16	Use per capita	$U/(\text{population})$
17	Renewable carrying capacity at present living standards	$(R/U)(\text{population})$
18	Developed carrying capacity at same living standards	$8(R/U)(\text{population})$
19	Fuel use per person	$(\text{Fuel})/(\text{population})$
20	Fraction electric	$(\text{Electricity use})/u$

Total use of nonrenewable resources, N, is made up of that which is rurally dispersed and used, N_0 ; that used intensively, N_1 ; and raw product exported without much transformation, N_2 .

Whereas goods export, B, and service export, P_1E carry embodied energy that may be derived from imports, they represent transformations and are the products of use.

5. ANALYSIS OF SUBSYSTEMS

Many questions of public policy concern important subsystems of an economy, such as agroecosystems, mining systems, manufacturing systems, tourist systems, etc. Energy analysis overviews can be prepared for these in the same way as described already for the whole nation. Diagrams are drawn, pathways evaluated in actual energy units, and then converted to embodied solar joules. The final summary diagrams can be used to calculate energy transformation ratios for the product of that system. Examples of these are given in the Appendix to this study.

A generic diagram for a production subsystem is given in Figure 5.1. Usually there are the inputs from the environment and sectors of environmental work. Connecting with these on the right are human economic activities that transform, process, and transport the products. Shown as a countercurrent of dashed lines are the flows of money where human services are involved. Included also are money flows to repay investments, interest, etc.

When the diagram has been completed with embodied energy flows calculated for the main flows, several useful ratios may be calculated to help interpretations. Where flows have a common source and are by-products, such as winds, waves, and rain generated by the global weather system, only the largest is used, usually the rain energy.

The *net energy yield ratio* is the embodied energy of the output divided by the embodied energy of the inputs to the process fed back from the economy. See Figure 5.2. This ratio

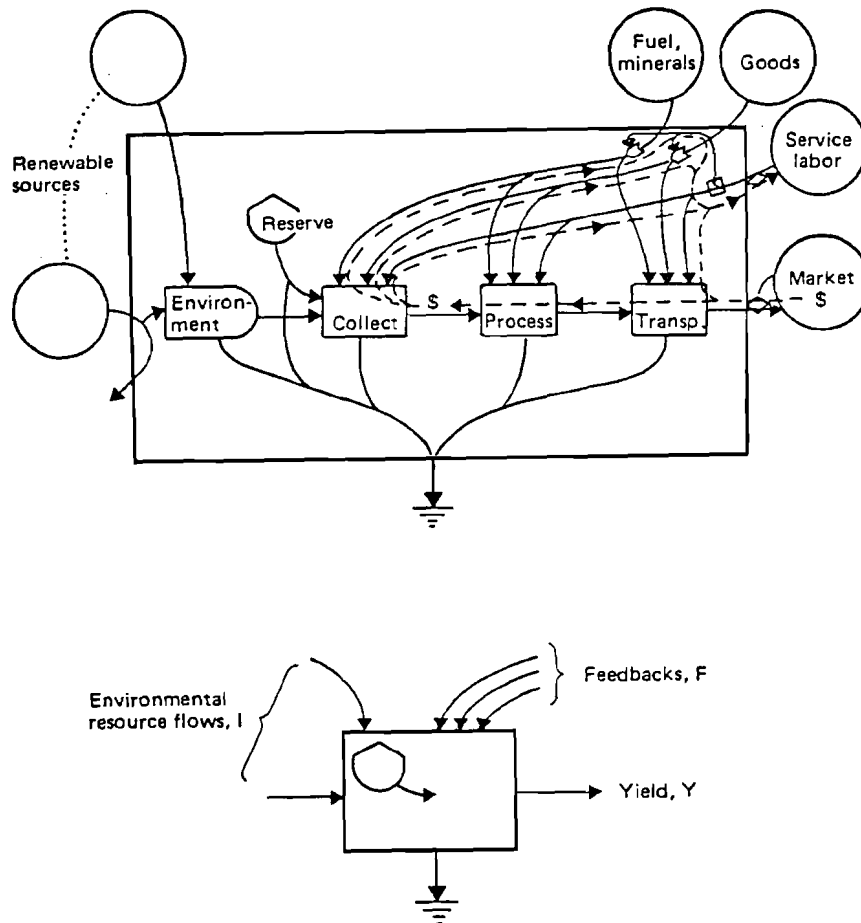

Figure 5.1. Generic diagram for a production subsystem. (a) typical components; (b) aggregated three arm diagram.

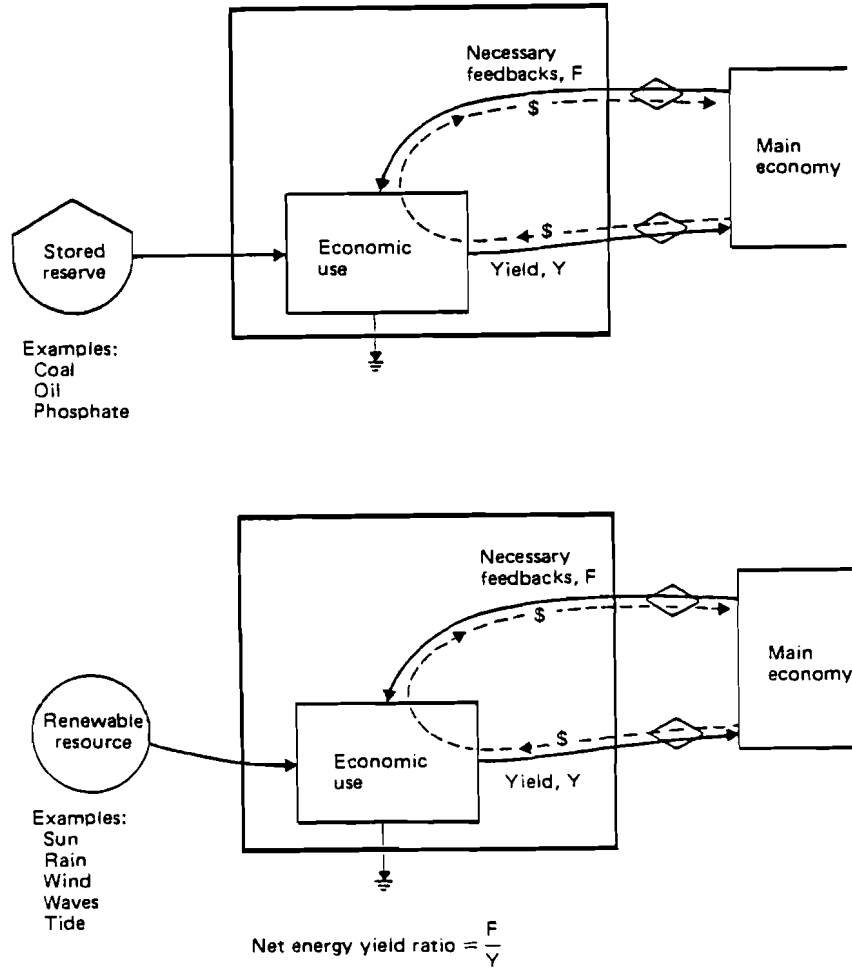

Figure 5.2. Diagram defining the net energy yield ratio for evaluating primary energy sources. Both F and Y should be in embodied energy units of the same quality. (a) nonrenewable source; (b) renewable resource.

indicates whether the process can compete in supplying a primary energy source for the economy. In the recent past the ratio for buying foreign oil was about 6 to 1. Processes yielding less than this are not economic as primary energy sources.

The *energy investment ratio* is the ratio of the embodied energy fed back from the economy to the embodied energy inputs from the free environment. See Figure 5.3. This ratio indicates if the process is economic as a utilizer of the economy's investments in comparison with alternatives. To be economic the process should have a smaller ratio than competitors so that its prices are less and it can compete in the market. Its prices are less when it is receiving a higher percentage of its useful work free from the environment than its competitors. The world ratio in 1980 was 1.4 but the energy voracious United States was about 8 (Appendix A.4).

Some systems may be useful without being a good primary source (having high net energy yield ratio) or being good secondary source (having a competitive energy investment ratio). If the system is a consumer system such as a household or hospital, it may draw some environmental energies into its processes thus making the consumption more efficient. The appropriate index to evaluate measures for improving consumer efficiency in units of embodied energy is service increase (ΔY) for increase in *energy invested* (ΔF). See Figure 5.4.

The energy analysis of subsystems may be useful for evaluating the degree of industrialization, contributions of environment and associated environmental loading, for anticipating success of subsystems being considered for development.

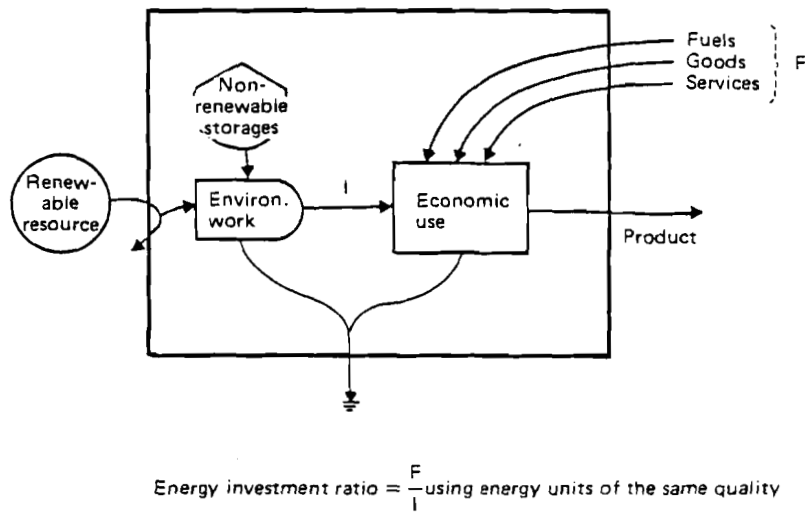
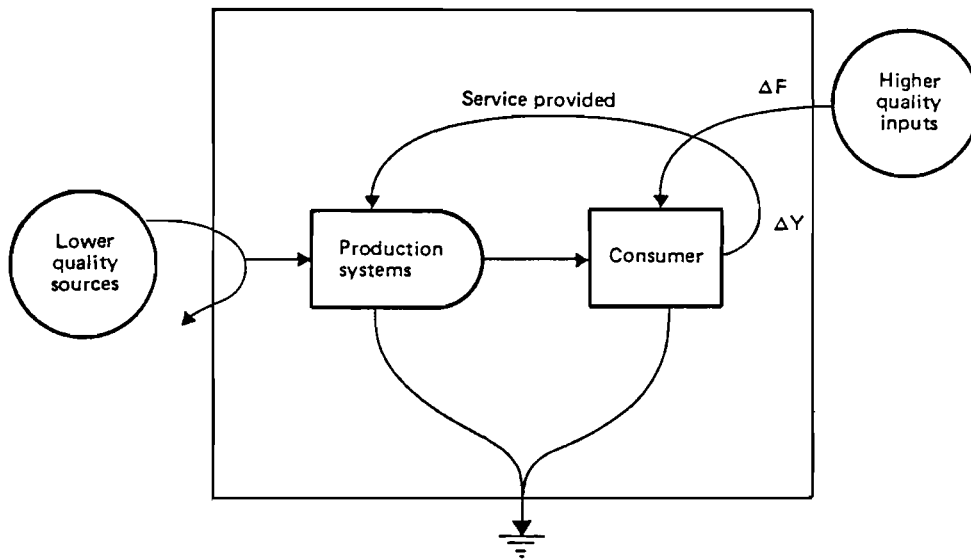

Figure 5.3. Diagram defining the energy investment ratio for evaluating whether matching of investments with environmental contributions is competitive and its loading of environmental systems.



Consumer
efficiency
amplifier

$$\frac{\Delta Y}{\Delta F} = \frac{\text{Service increase}}{\text{Investment increase}^*}$$

*High quality feedback

Figure 5.4. Diagram defining consumer efficiency amplifier.

Some of the subsystem analyses are included with the main text about a country. Others are included as an appendix, especially when their purpose was to evaluate an energy transformation ratio.

Estimating Embodied Energy of Service of a Subsystem

A subsystem such as corn production (Figure 3.2) receives services, but also contributes the embodied energy of its direct energy sources to the general economy and to the energy-dollar ratio. To avoid double counting, the contribution of the subsystem energy (s) back to the economy must be subtracted from the energy-dollar ratio (P) before that ratio is used to calculate services to the subsystem. The corrected energy-dollar ratio to use is:

$$\left(P - \frac{S}{X} \right) \quad \text{where X is GNP}$$

Where services are less than 10% of a subsystem and the category of subsystems is less than 10% of the national energy budget, the correction is less than 1% and may be ignored.

In the corn example calculated in Appendix A9b, the correction is 3%.

PART II. ENERGY ANALYSIS OVERVIEW OF
NATIONS: TWO CASE STUDIES

Howard T. Odum
Environmental Engineering Sciences,
University of Florida, Gainesville

6. ENERGY ANALYSIS OVERVIEW OF SPAIN

Introduction

This is an overview energy analysis of Spain (Figure 6.1), its system of humanity and nature, and the interplay of renewable resources, indigenous nonrenewable resources, and imported resources that generate the economy. Procedures and methods used were those given in Part I, Sections 1 to 5. After energy diagrams were drawn (Figure 6.2), actual energy storages and flows were estimated. Then energy transformation ratios were multiplied by the actual energy data to represent all kinds of energy storages and flows as embodied, solar-equivalent joules. Various indices and ratios were evaluated to help compare Spain with other nations, evaluate public policy alternatives, and suggest trends.

Work was aided by discussions held with the participants of a symposium on energy and environment in Madrid, November 17-19,

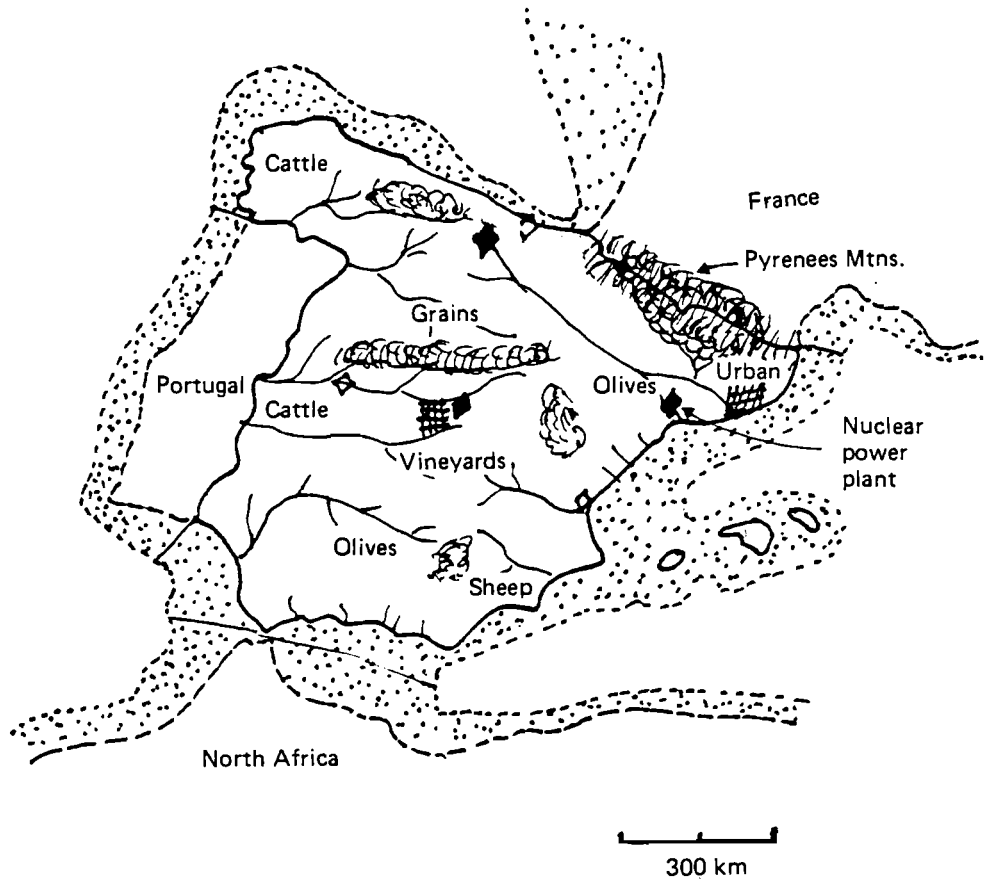

Figure 6.1. Map of Spain, its continental shelf, and main land uses; modified from World Atlas of Agriculture, vol. 1.

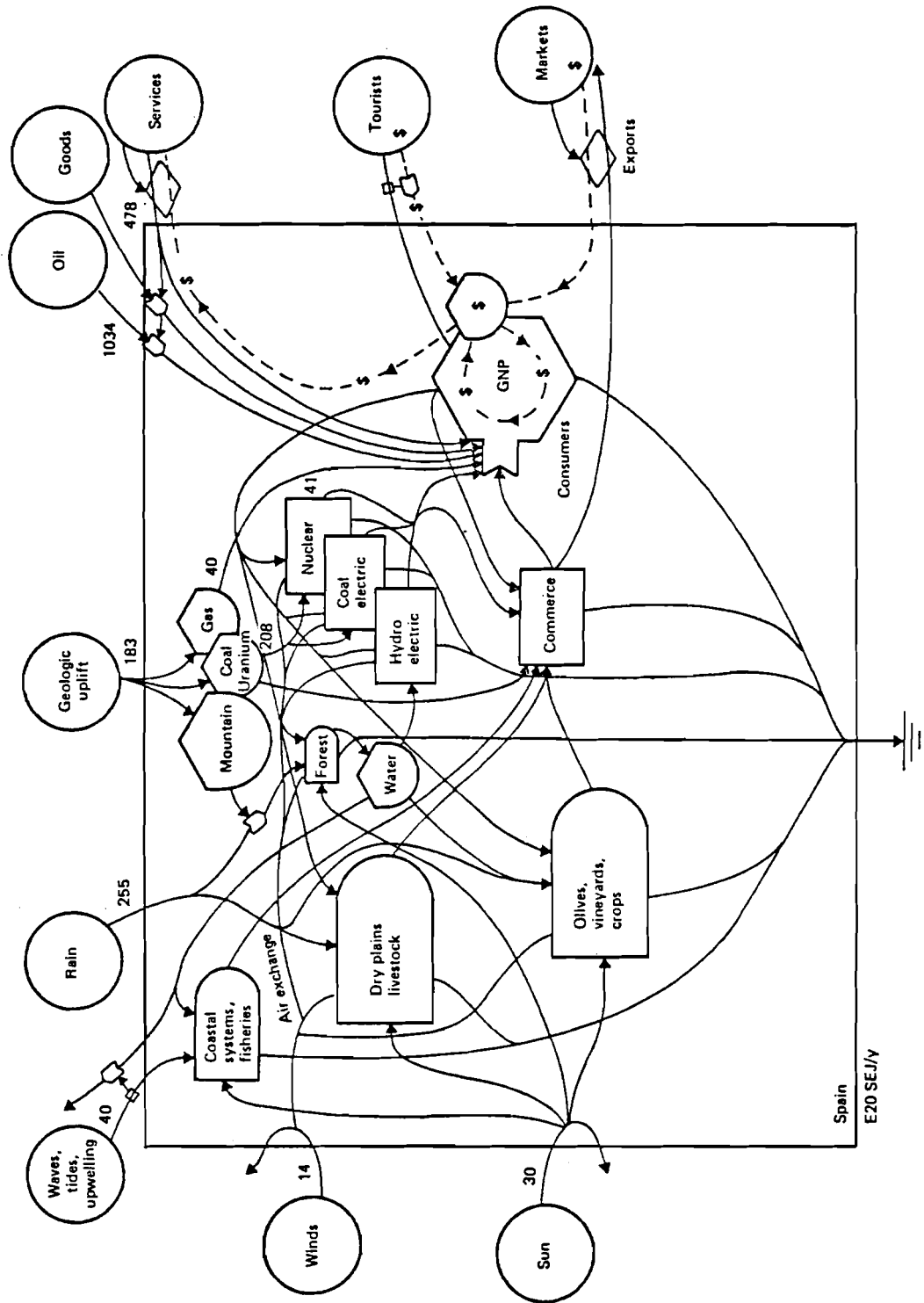

Figure 6.2. Energy diagram of the energy system of Spain.

1982 and staff of the Division of Environment, Ministerio de Obras Publicas and Urbanismo. Data for 1980 were obtained from National Energy Plan of 1981 by the Ministerio de Industria Y Energia (1982) and from U.N. Statistics (1981). Figure 6.3 is an energy summary for Spain given by Ministerio de Industria Y Energia (1982). Like most national energy summaries, much of the economic resource base from environmental energies was not included. In the present analysis all the main energy sources were included on an equivalent basis by converting all to embodied solar equivalent joules.

Results

The main features of Spain's area pattern are summarized in the map in Figure 6.1. The system of causal interactions for Spain is given in Figure 6.2. Energy sources and symbols are arranged from left to right in order of their energy transformation ratios from sunlight. Spain with a long coastline on the Atlantic Ocean and Mediterranean Sea receives substantial work of the sea in tides and waves, and from nutrient upwelling which helps generate fisheries. Located in the Mediterranean climate belt, subsiding atmosphere associated with mid-latitude high pressure cells inhibits rains in summer. Winds are light stratus, and air pollution problems are similar to those of California. Plains are pasture lands but dry in summer; sunny agriculture consists of olive groves and vineyards. Forests occur in mountains, which support some hydroelectric power generation. Geologic uplift has generated coal, uranium deposits, and some natural gas. The economy is moderately industrialized, much of

Diagram of energy flows in the spanish economy in 1981
(Estimate)

Unit: M tce

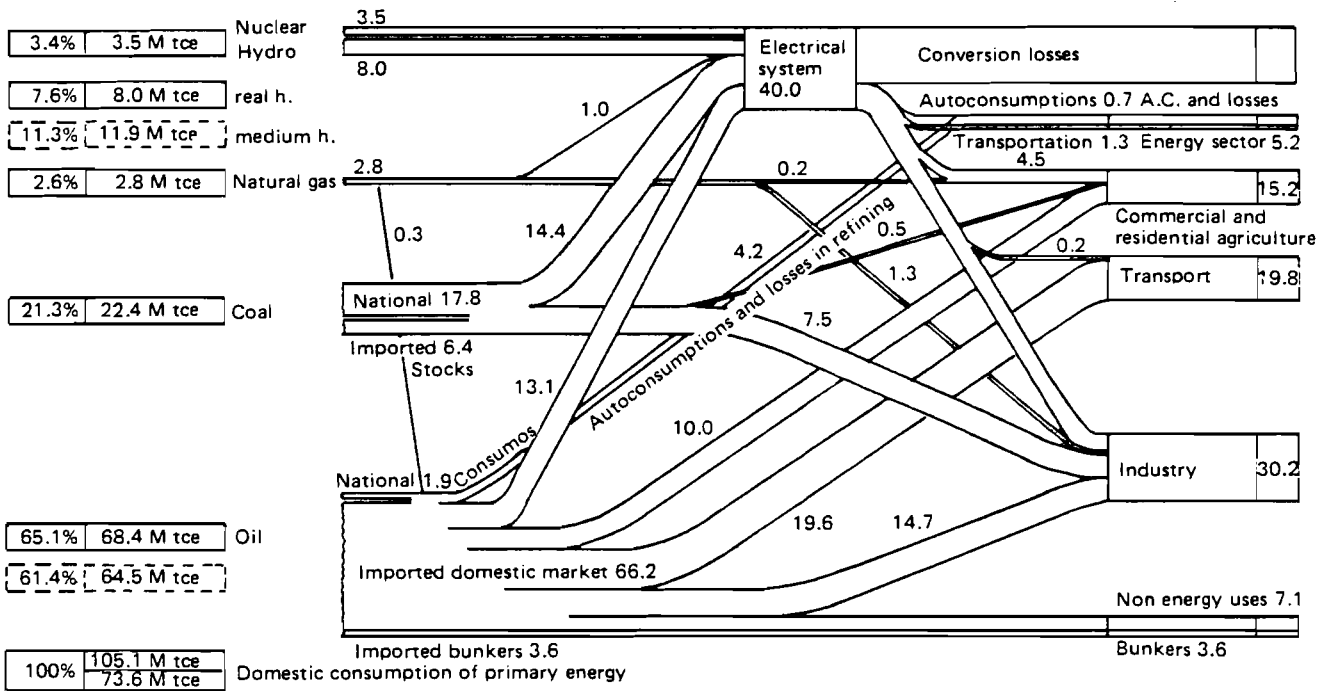

Figure 6.3. Fuels and electricity for Spain. (Ministerio de Industria Y Energia 1982)

E6 Tonne Coal Equivalents

it is based on imported oil. There are four nuclear power plants. Exports are wines, olives, coal, foods, and cattle products. Tourist trade helps bring in funds to purchase fuels.

The systems diagram of Spain (Figure 6.2) has embodied solar energy equivalent joules written on the pathways. Calculations for these are given in Tables 6.1 and 6.2. The embodied energy contributions from environmental renewable sources are as great as that from fuels.

A more aggregated summary overview is given in Figure 6.4 which has values calculated in Table 6.3, including embodied energy to dollar ratio for Spain. The three arm diagram in Figure 6.4b shows at a glance the relative role of indigenous resources, imported resources, and the embodied energy balance of trade.

Finally, in Table 6.4 various indices and ratios are assembled and calculated using the embodied energy results, population data, and geographical data.

Discussion

The magnitudes of the energy sources in Table 6.1 characterize the forcing pressures to which the culture and economy of Spain is being developed. Expressed on a similar embodied energy scale, they constitute a deterministic tendency, assuming one accepts the premises that work generates real economic value.

Next in importance to the large oil import and embodied energy in services that went into imports, embodied solar energy

Table 6.1. Energy flows in Spain.

Foot-note	Item	Actual energy* J/y	Energy Transformation Ratio** SEJ/J	Embodied Solar Energy SEJ/yE20
1	Direct sunlight	3.9 E21	1	30.0
2	Winds absorbed	1.09 E18	1268	13.8
3	Ocean waves	0.83 E17	25889	21.4
4	Tides on shelf	7.31 E16	23564	18.6
5	Rain, mechanical	2.5 E17	8888	222.
6	Rain, chemical, potential	16.5 E17	15444	255.
7	Earth cycle	5.9 E17	2.9 E4	171.
8	Top soil	6.0 E16	6.3 E4	38.
9	Oil imported	20.0 E17	5.17 E4	1034.
10	Coal imported	1.88 E17	3.98 E4	75.
11	Coal from local sources	5.22 E17	3.98 E4	208.
12	Natural gas	0.82 E17	4.8 E4	40.
13	Nuclear electricity	2.56 E16	15.9 E4	41.
	total electricity	29.3 E16	15.9 E4	465.
14	Imported services	2.07 E10 (\$/yr)	2.31 E12 (SEJ/\$)	478.

Footnotes for Table 6.1.

(Statistics on fuels and electricity from Ministerio de Industria Y Energia 1982). Geographic statistics from Goodes World Atlas (1979).

* See Table 2.1 for formulae and explanations for each category of actual energy used.

** See Table 3.1 for energy transformation ratios given here.

1. Direct sunlight

Area of Spain $5.09 \text{ E}11 \text{ m}^2$ and its shelf $1.6 \text{ E}11 \text{ m}^2$, multiplied by annual solar energy

$$(6.69 \text{ E}11 \text{ m}^2) (1.4 \text{ E}6 \text{ kcal/m}^2/\text{yr}) (4186 \text{ J/kcal}) = 3.9 \text{ E}21 \text{ SEJ/yr}$$

Footnotes to Table 6.1 continued.

2. Wind absorbed using values typical of Oakland, California.

$$\begin{aligned} & (\text{Volume}) (\text{density}) (\text{eddy diffusion coef.}) (\text{vertical gradient})^2 \\ & (\text{area of country}) \\ & (10^3 \text{m}) (1.23 \text{ kg/m}^3) (4.7 \text{ m}^3/\text{m}/\text{sec}) (3.154 \text{ E7 sec/yr}) \\ & (3.0 \text{ E-3 m/s/m})^2 (6.69 \text{ E11 m}^2) = 1.09 \text{ E18 J/y} \end{aligned}$$

3. Ocean waves absorbed.

$$\begin{aligned} \text{where speed of waves} &= \sqrt{gz} = \sqrt{(9.8 \text{ m/sec}^2) (6\text{m})} \\ & (3.154 \text{ E7 sec/yr}) = 2.42 \text{ E8 m/yr} \end{aligned}$$

Atlantic coast line (944 km)

$$\begin{aligned} & (9.4 \text{ E5 m}) (1/8) (1.025 \text{ E3 kg/m}^3) (9.8 \text{ m/sec}^2) (0.6\text{m})^2 \\ & (1.5 \text{ E8 m/yr}) = 0.64 \text{ E17 J/y} \end{aligned}$$

Other coasts (1120 km)

$$\begin{aligned} & (11.2 \text{ E5 m}) (1/8) (1.025 \text{ E3 kg/m}^3) (9.8 \text{ m/sec}^2) (0.3\text{m})^2 \\ & (1.5 \text{ E8 m/yr}) = 0.19 \text{ E14 J/y} \end{aligned}$$

4. Tide absorbed on shelf (90 km x 2064 km)

$$\begin{aligned} & (0.5) (1.65 \text{ E11 m}^2) (0.5) (706/\text{yr}) (0.5\text{m})^2 (1.025 \text{ E3 kg/m}^3) \\ & (9.8 \text{ m/sec}^2) = 7.31 \text{ E16 J/y} \end{aligned}$$

5. Geopotential in rain used

7.03 E4 GWH potential (Ministerio de Industria y Energia 1982)

$$\begin{aligned} & (7.03 \text{ E4 GWH}) (1 \text{ E6 KWH/EWH}) (860 \text{ kcal/kWH}) (4186 \text{ J/kcal}) \\ & = 253 \text{ E17 J/y} \end{aligned}$$

OR

$$\begin{aligned} & (6.09 \text{ E11 m}^2) (500\text{m}) (0.1 \text{ m/y}) (1 \text{ E3 kg/m}^3) (9.8 \text{ m/sec}^2) \\ & = 2.49 \text{ E17 J/y} \end{aligned}$$

6. Chemical potential in rain used.

$$(6.69 \text{ E11 m}^2) (0.5 \text{ m/yr}) (4.94 \text{ J/g}) (1 \text{ E6 g/m}^3) = 1.65 \text{ E17 J/y}$$

Footnotes to Table 6.1 continued.

7. Earth cycle

(heat flow) (area)

$$(1 \text{ E6 J/m}^2/\text{y}) (5.9 \text{ E11 m}^2) = 5.9 \text{ E17 J/y}$$

8. Top soil

11.6 E6 ha forest; 23.3 E6 ha agriculture (World Atlas of Agriculture 1969); (formation)-(erosion)

$$(1.16 \text{ E11 m}^2) (1260 \text{ g/m}^2/\text{y}) - (2.33 \text{ E11 m}^2) (250 \text{ g/m}^2/\text{y})$$

$$= 8.79 \text{ E13 g/y}$$

$$(8.79 \text{ E13 g/y}) (0.03 \text{ org.}) (2.26 \text{ E4 J/g org.})$$

$$= 6.0 \text{ E16 J/y formation}$$

9. Imported Oil.

68.4 E6 T coal equivalents (Ministerio of Industria Y Energia 1982)

$$(6.4 \text{ E6 TEC/yr}) (7 \text{ E6 kcal/TEC}) (4186 \text{ J/kcal}) = 2.0 \text{ E18 J/yr}$$

10. Imported coal.

6.4 E6 T coal

$$(6.4 \text{ E6}) (7 \text{ E6 Kcal/T}) (4186 \text{ J/kcal}) = 1.87 \text{ E17 J/y}$$

11. Local coal used.

$$(17.8 \text{ E6 T/g coal}) (7 \text{ E6 kcal/T}) (4186 \text{ J/kcal}) = 5.22 \text{ E17 J/yr}$$

12. Natural gas used, 2.8 E6 tonne equivalents of coal.

$$(2.8 \text{ E6 Tec}) (7 \text{ E6 kcal/Tec}) (4186 \text{ J/kcal}) = 0.82 \text{ E17 J/yr}$$

13. Nuclear electricity

$$(1/4) (3.5 \text{ E6 coal equiv.T}) (7 \text{ E6 kcal/Tec}) (4186 \text{ J/kcal})$$

$$= 2.56 \text{ E16 J/yr}$$

$$\text{Total electricity: } (40 \text{ E6 T coal/y}) (7 \text{ E6 kcal/T}) (4186 \text{ J}) (0.25)$$

$$= 2.93 \text{ E17 J/y}$$

14. Imported services

U.S.\$ equivalent paid for imports in 1978, \$20.72 E9; energy/\$ for U.S., Appendix A4.

Table 6.2. Energy storages in Spain*

Foot-note	Item	Actual energy J	Energy Transformation ratio** SEJ/J	Embodied solar energy stored SEJ E22
1	Soil	6.1 E19	1.3 E4	79.3
2	Wood	1.70 E19	3.5 E4	59.5
3	Freshwater	1.53 E19	4.1 E4	62.7
4	Coal reserves	4.9 E19	4.0 E4	196.
5	Uranium	1.63 E19	1793	2.9
	Total			400.4

Footnotes to Table 6.2.

*Storages with turnover times longer than one year.

**From Table 3.1 (Section 3, this study).

1. Soil: $(5.09 \text{ E11 m}^2) (6 \text{ E8 J/m}^3) (0.2 \text{ m}^3/\text{m}^2) = 6.11 \text{ E19 J}$
2. Wood stock: $11.6 \text{ E6 Ha (World Atlas of Agriculture 1969)}$
 $(11.6 \text{ E10 m}^2) (1 \text{ E4 g/m}^2) (3.5 \text{ kcal/g}) (4186 \text{ J/kcal})$
 $= 1.70 \text{ E19 J}$
3. Ground water in upper 100m; $(5.09 \text{ E11 m}^2) (100 \text{ m})$
 $(0.10 \text{ pore space}) (1 \text{ E6 gH}_2\text{O/m}^3) (3 \text{ J/g}) = 1.53 \text{ E19}$
4. Coal reserves: (Ministeria de Industria Y Energia 1982)
 $(1.676 \text{ E9 T}) (7 \text{ E6 kcal/T}) (4186 \text{ J/kcal}) = 4.91 \text{ E19 J}$
5. Uranium: (Ministeria de Industria Y Energia 1982)
 $29.25 \text{ E3 T U}_3\text{O}_8\text{j}; \quad 0.7\% \text{ U235}; \quad 1.9 \text{ E7 kcal/g U235}$
 Actual nuclear energy stored available to fission:
 $(29.25 \text{ E3 T uran.}) (0.007 \text{ U235/uran.}) (1 \text{ E6 g/T})$
 $(1.9 \text{ E7 kcal/g}) (4186 \text{ J/kcal}) = 1.63 \text{ E19 J}$

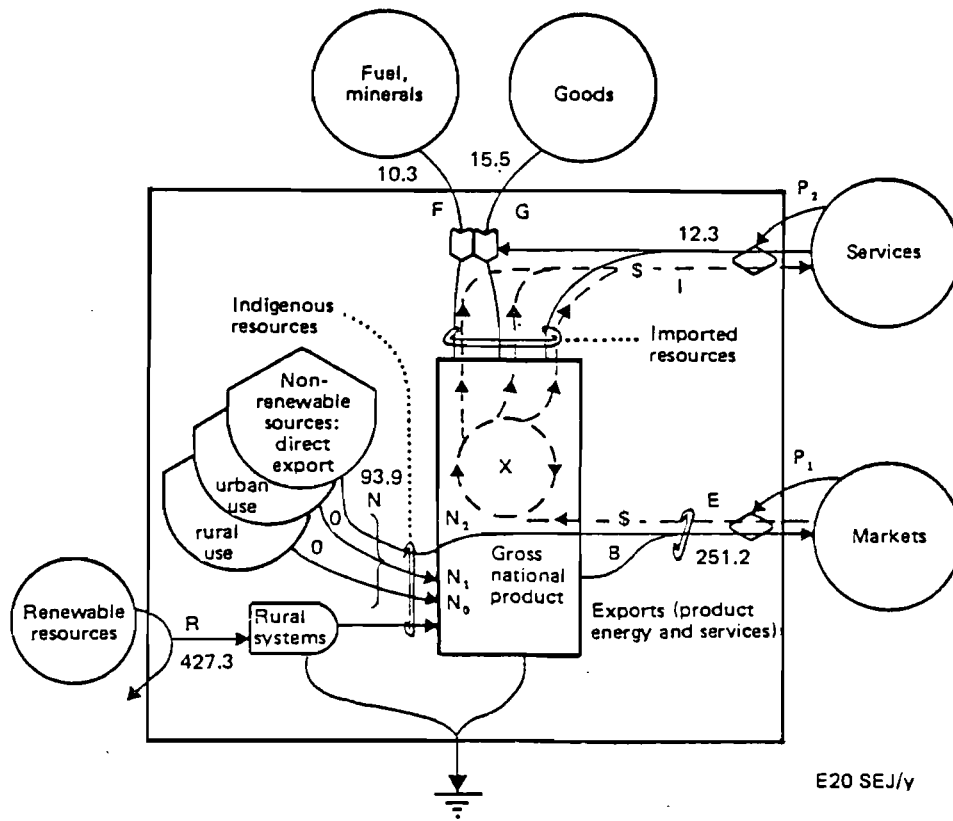

$$P_1 = \frac{\text{Energy Used}}{\text{GNP}} = \frac{R + N_0 + N_1 + F + G + P_2 I}{X}$$

(a)

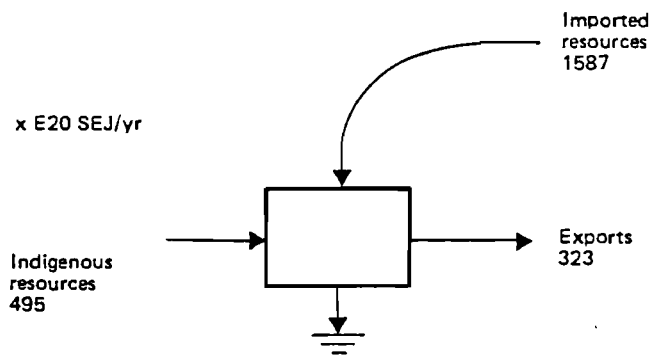

(b)

Figure 6.4. Aggregated overviews of Spain.
 (a) Diagram for Table 6.3 where pathways were evaluated in solar equivalent joules; (b) Further aggregation to form a three-arm diagram.

Table 6.3. Summary flows for Spain, see Figure 8.4.

Letter in Figure 6.4	Item	Numerical value	
R	Renewable sources used, SEJ/yr	255.0	E20
N	Nonrenewable sources flow from within the country (SEJ/yr):		
	N ₁ concentrated use (SEJ/yr)	248.0	
	N ₂ exported without use (SEJ/yr)	0.003	E20
F	Imported minerals and fuels (SEJ/yr)	1109.0	E20
G	Imported goods (SEJ/yr)	-	
P ₂ I	Imported service (SEJ/yr)	478.0	E20
I	Dollars paid for imports (\$/yr)	34.8	E9
E	Dollars paid for exports (\$/yr)	20.7	E9
P ₁ E	Exported services (SEJ/yr)	323.0	E20
B	Exported products, transformed within the country (SEJ/yr)	-	
X	Gross National Product (\$/yr)	134.0	E9
P ₂	Ratio embodied energy to dollar of imports (SEJ/\$, 1978)	2.37	E12
P ₁	Ratio embodied energy to dollar with- in the country and for its exports (SEJ/\$)	1.56	E12

R Largest of the solar inputs was used, chemical potential of rain, Item 6, Table 8.1.

N₁ Natural gas and local coal, items 11 and 12, Table 6.1.

F Sum of imported oil and coal, items 9 and 10, Table 6.1.

X National product, 1.022 E12 Pesetas; 0.0131 US\$/peseta 1978.

$$P_1 = \frac{R + N_1 + F + G + P_2 I}{X} = \frac{(255 + 248 + 1109 + 478) E20}{134 E9}$$

$$= 1.56 E12 \text{ SEJ}/\$$$

G,B Goods were not evaluated separately; their embodied energy was included in services.

Table 6.4. Indices using embodied energy for national overview of Spain

Item	Name of index and expression, see Figure 4.1		
1	Renewable embodied energy flow	R	255 R20 SEJ/y
2	Flow from indigenous non-renewable reserves	N	240 E20 SEJ/y
3	Flow of imported embodied energy	F+G+P ₂ I	1587 E20 SEJ/y
4	Total embodied energy inflows	R+N+F+G+P ₂ I	2090 E20 SEJ/y
5	Total embodied energy used, U	U = N ₁ +R+F+G+P ₂ I	2090 E20 SEJ/y
6	Total exported embodied energy	B+P ₁ E	323 E20 SEJ/y
7	Fraction of embodied energy used derived from home sources	(N ₁ +R)/U	0.24
8	Imports minus exports	(N ₂ +B+P ₁ E) - (F+G+P ₂ I)	631 E20 SEJ/y
9	Ratio of exports to imports	(N ₂ +B+P ₁ E)/(F+G+P ₂ I)	0.43
10	Fraction used, locally renewable	R/U	0.122
11	Fraction of use purchased	(F+G+P ₂ I)/U	0.76
12	Fraction used that is imported service	P ₂ I/U	0.23
13	Fraction of use that is free	(R+N ₀)/U	0.24
14	Ratio of concentrated to rural	(F+G+P ₂ I+N ₁)/(R+N ₀)	7.2
15	Use per unit area (5.05 E11 m ²)	U/(area)	3.12 E11 SEJ/m ² /y
16	Use per capita (34.6 E6 people)	U/(population)	6.15 E15 SEJ/yr/cap
17	Renewable carrying capacity at present living standard	(R/U) (population)	4.2 E6 people
18	Developed carrying capacity at same living standard	8(R/U) (population)	33 E6 people
19	Ratio of use to GNP,	P ₁ = U/(GNP)	1.56 E12 SEJ/\$

in rainfall is most important even though the country has dry provinces. Waves and tide although large when considered for a coastal province, are not large when prorated over the area of the whole country.

The summary in Figure 6.4b shows the preponderance of the economic basis in outside imports (76%). The ratio to indigenous matching resources from the environment (7.2) is large, representing a high degree of economic and development environmental loading. The total embodied energy input per person and per area is large.

The ratio of concentrated energy to rural energies is about as high as the United States. These indices indicate the high degree of development of available environmental resources, perhaps indicating little basis for attracting additional investment. The embodied energy per dollar circulating is somewhat less than that of the United States. Only one-fourth of the present standard of energy per person is based on indigenous resources, making the present economy dependent on continued symbiotic relationships with North African oils.

Comparing rates of total energy use (2.08 E23 SEJ/y) with total reserves in Table 6.2 (40.0 E23 SEJ) indicates little way to sustain current economic levels without fossil fuel imports. The total embodied energy reserve would last only 20 years.

The carrying capacity without outside imports would be 4 million people at the present standard of living (Table 6.4).

The present economy is highly dependent on a favorable balance of energy with North Africa, at current prices receiving net energy of 7 to 1 relative to embodied energy of dollar trade. Proximity to North Africa provides a 10% edge in transportation costs for fuels, and future availability may depend on an integration of economic and noneconomic feedbacks of service to North Africa to reinforce the mutual advantages of continued fuel supply.

Because nuclear plants are only competitive in supplying electricity, their use depends on electric demand. If general growth is not possible, and energy per person not likely to go higher, then demand for high quality energy of electricity is not likely to increase. Hence further investment in nuclear plants is not good policy. Nuclear plants are not a good net energy for supplying general heating or substitution for solid and liquid fuels used directly.

Whereas underdeveloped countries with large undeveloped environmental energy attractions may develop further attracting investments in competition with developed and overdeveloped nations, Spain is already among those countries that may turn down as North African net energies of oil and gas decline early in the next century or sooner.

SUMMARY

An energy analysis of the main energy flows driving the economy of humans and life support systems was made including environmental energies, fuels, and imports, all expressed as embodied solar equivalents. The total embodied energy use (2090 E20 SEJ/yr) is 76% from imported sources, oil and embodied energy of services accumulated in purchased goods. The embodied energy flows from the environment are modest, because the share of global inputs such as rain and geological uplift flux are modest. Consequently, the ratio of outside investments to attracting natural resources is already large, like other industrialized countries. The population level is already close to the carrying capacity that is competitive. With less free embodied energy from environmental sources, the energy per dollar is less than in underdeveloped countries and some developed ones. If the present economy were running entirely on stored reserves of fuels, soils, wood, etc., it would last only 20 years. Its carrying capacity for steady state on its renewable sources is only 4.2 million people, compared to 34 million in 1980. Continued availability of foreign oil at a favorable balance of energy trade, currently about 7 to 1 net energy, is the basis for present economic activity and must decrease as the net energy of foreign oil purchases goes down. Close economic integration with North Africa may determine how long this is possible in the future.

Elisabeth C. Odum
*Santa Fe Community College,
Gainesville, Florida*

Howard T. Odum
*Environmental Engineering Sciences,
University of Florida, Gainesville*

7. ENERGY ANALYSIS OVERVIEW OF LIBERIA*

Introduction

Understanding the relationships of energy flow to economies is a major area of scientific inquiry. When the flows and processes of national systems are fully combined using energy to include the environmental inputs, flows of money, hierarchical patterns, human roles, and international exchanges, new ways of determining economic vitality are suggested. The study of a system in this way is called energy analysis. Now, the goals of international exchanges are directed by considerations of the balance of money payments. This analysis proposes that the balance of embodied energy be the goal.

Liberia (Figure 7.1), 111 E3 km^2 in area, with a population of about 1.8 million (1977), is located on the west coast of

*Expanded from a report for a course in energy analysis at the University of Florida in 1979.

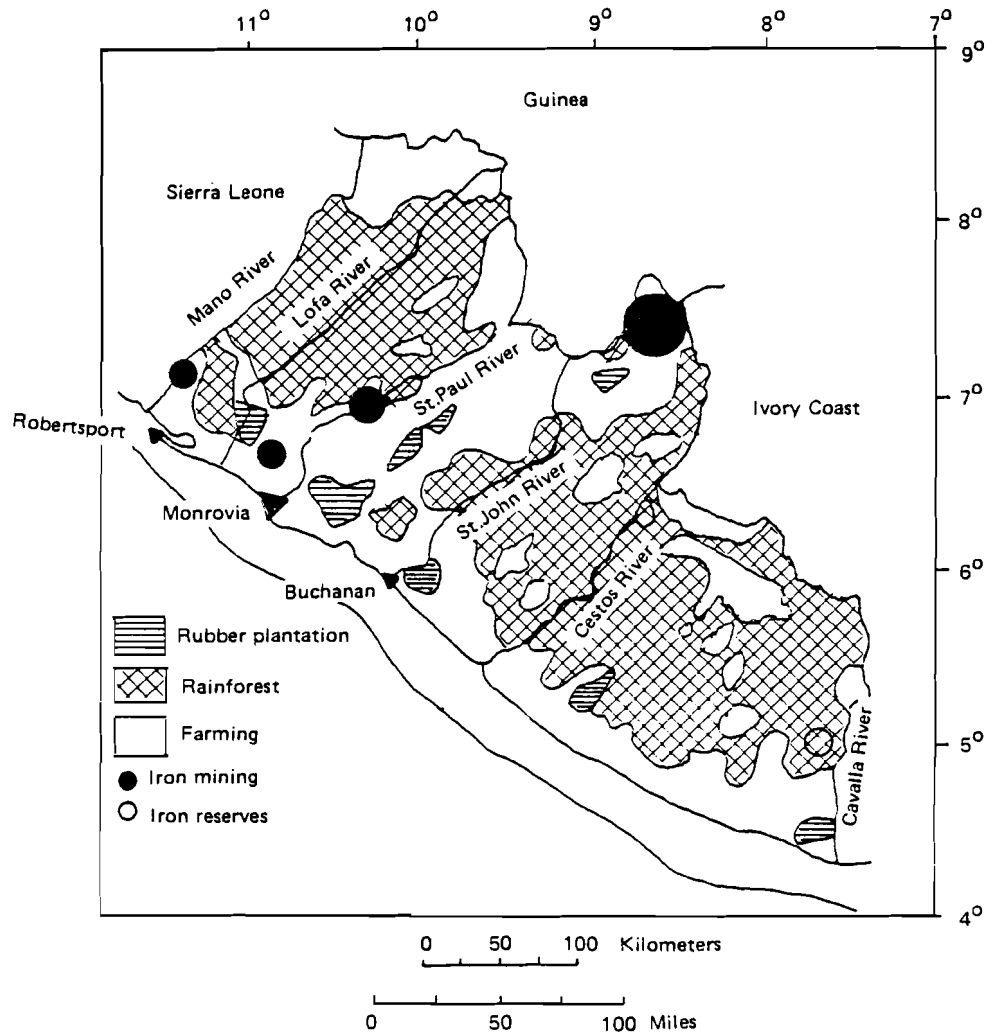

Figure 7.1. Land use map of Liberia. (Data compiled from Van Chi-Bonnardel 1973).

Africa between 5° and 8° north. It is bordered on the northwest by Sierra Leone, on the north by Guinea, and on the east by the Ivory Coast. It has a 563 km Atlantic Ocean coastline on the southwest.

There are three regions: a littoral plain edged by a straight sandy and mangrove shoreline, a plateau, and mountains. The climate is humid with alternating long rainy and short dry seasons. There are six major rivers which are not accessible for transportation, but which have been estimated as having the hydroelectric potential of several hundred thousand KW. Hydroelectricity could be a valuable resource providing industry and jobs.

One of the major questions is whether it is necessary for small countries to contribute to the economies of larger nations in order to maximize the power of the whole international system. Is there a way to make their internal useful embodied energy per person more equal to that of the countries like the Netherlands and Japan which import more embodied energy than they export?

Comparative studies of countries and energy sources may help determine national patterns of economics and international relations. Liberia is part of the group of nations that has resources which have not been tapped and also does not import much energy in fuels or goods. The average income was about \$400 per capita in 1977 (Collier Ency. 1982); 95% of the people were illiterate; and there was little local industrialization. The mining and export of iron, its largest export, did not affect many Liberian people. About half of the rubber,

which was 14% of their exports, was grown by small farmers, but was almost all exported. Only about half of the wood production was used locally.

Several questions may be raised about how this country can use its resources to maximize its own power. How can a small country with a relatively small population use a large resource like iron to benefit its own people?

Rubber plantations are an important economic activity (Figure 7.1). They were started by large rubber companies from the United States in 1926. As production increased, the trend was toward more small local producers. But, when fossil fuels became more available and the world demand for natural rubber decreased, the rubber-producing part of the economy became depressed. As fuel costs rise and the world can produce less synthetic fossil-fuel rubber, the demand for natural rubber may increase. How can Liberia exploit this resource to its best advantage, with or without the big American companies of Goodyear and Firestone?

The rain forest, which covered one-third of the land in 1977 was rapidly being destroyed. The amount cut was much greater than was being replaced. What land-use policy can sustain a long term yield?

In 1820 the Liberia coast was settled by liberated black slaves from the American colonies. In 1847 the independent Republic of Liberia was proclaimed under President Tubman. Later the interior was included. The 5% Americo-Liberians had the education and held the political power until 1980. In that year Master Sargeant Samuel Kenyon Doe overthrew President Tolbert

and set up the People's Redemption Council of the Armed Forces of Liberia. This ruling group were from the "country people" which were 95% of the population and came from many different tribes.

There were some roads, most of which were built in World War II, and an iron-mining railroad, but most of the interior had little intercommunication. Because of the open-door economic policy of Presidents Tubman and Tolbert, there are many foreign companies. The per capita income was one of the highest in Africa. Most of the population was farmers who grew rice and manioc with slash-and-burn agriculture. The most important commercial crops were coffee, oil palm, piassava palm, bananas, and peanuts.

Rubber was the principle export crop; timber was important. Iron mining provided the largest export income. Mining of diamonds, gold, bauxite, and other minerals was a potential source of export income.

There were some small industries on the coast, including rubber processing plants. These and most of the domestic trade were run for foreign interests. Exports were iron, rubber, wood, diamonds, and coffee. The country imported foods, fuel, chemicals, and capital equipment. Foreign aid came from the U.S. and Western European countries.

Many foreign ships flew the Liberian flag, and the Liberian merchant fleet had several large oil tankers and ore carriers. Few regulations and low fees encouraged foreign registrations.

The population of about 1.8 million (1977) lived mostly in rural areas. The overall density was .17/ha (10/km²), with a 3.5% growth rate (U.N, 1981a). Only blacks could become citizens. Malaria-carrying anopheles mosquitos, tsetse flies, and poor sanitation in the cities facilitated diseases. Most large wildlife had been destroyed.

Methods

The Liberian energy system was described, evaluated, and studied using the following steps.

A complex national diagram was drawn using the energy systems language. An aggregated diagram was used as a plan in which each pathway was evaluated with a calculation table. The energy of the surrounding ocean area was included as part of the country's energy sources. Subsystem diagrams of the major economic flows were evaluated.

Most energy transformation ratios were taken from Section 3. The energy transformation ratios of rubber and rainforest wood, in terms of sunlight, were calculated in this paper.

Various ratios (net energy yield ratio, energy investment ratio, etc.), were calculated to compare subsystems. A basic overview diagram was used to represent totals for overall comparisons. Several ratios (outside-inside energy ratio, embodied energy trade ratio, etc.), were calculated to compare Liberia with other countries and to support predictions and recommendations.

Results

An energy diagram for Liberia is given in Figure 7.2. It shows the energy system of Liberia which includes outside energy sources, productive land uses, mineral storages, industries and the primarily human systems.

The energy flows are summarized in Table 7.1 and the storages in Table 7.2. In Figure 7.3 the diagram is aggregated to show the evaluated flows. Although the energy of the direct sun is high since Liberia is near the equator, the embodied solar energy in water purity in rain is sixty times greater. Since it is larger than any of the other solar-based sources, it was used as the country's outside renewable energy flow for further calculations. The runoff from rivers and rain is also high, because of the inland mountains and the high rainfall of a rain forest climate. The geological uplift is less than the world average because Liberia is part of the large steady African plate. Ocean waves average about 1.2 meters along a coastline of 568 km, where most of their energy is absorbed on sandy shores and mangroves.

Energy-Dollar Ratio

The energy-dollar ratio (Table 7.3) for Liberia in 1977 was calculated from energy inflows from water purity, imported fuel, and imported goods and services (Figure 7.3). The Gross National Product (GNP) is the sum of the Gross Domestic Product (GDP) and the dollars from exports, foreign aid, investment, and the revenues from the merchant fleet.

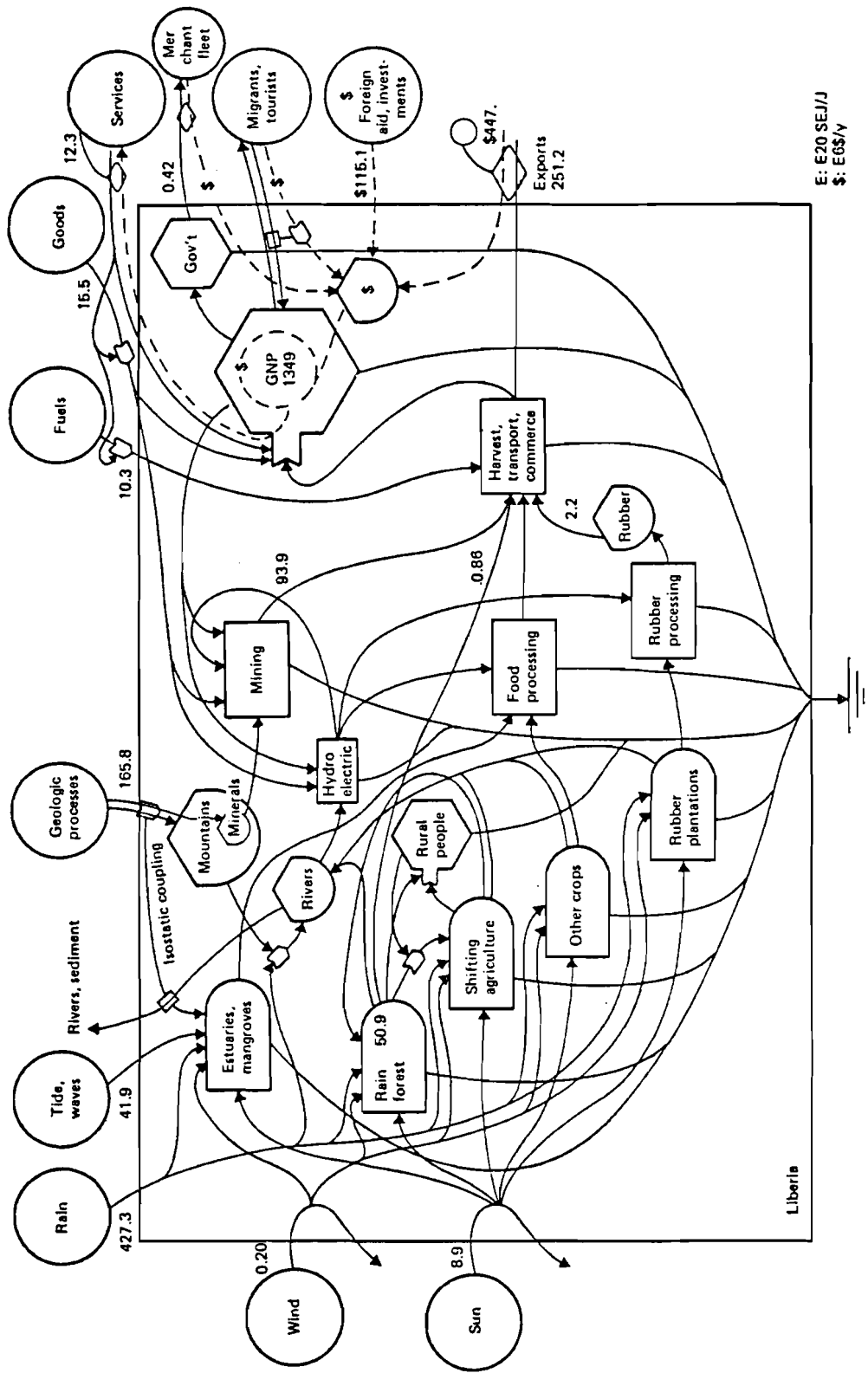

Figure 7.2. Energy diagram of Liberia.

Table 7.1. Energy flows of Liberia.

Foot-note	Type of Energy	Actual Energy* J/y	Energy Transformation Ratio** (ETR) SEJ/J	Embodied Solar Energy E20 SEJ/y
1	Direct sunlight	6.9 E20	1	6.9
2	Wind	1.65 E16	1268	0.20
3	Rain, chemical potential	2.76 E18	15444	427.3
4	Rain, geopotential	8.19 E17	8888	72.8
5	Tide	3.75 E16	23564	8.8
6	Waves	1.28 E17	25889	33.1
7	Rivers, sediment	2.07 E10		
8	Rivers, geopotential	1.72 E17	23564	40.7
9	Top soil	1.34 E16	6.25 E4	8.4
10	Earth cycle	2.2 E11	2.71 E10	59.6
11	Net loss of earth 4.98 E5 T	-	1.71 E15/T	8.5
12	Iron production	1.56 E14	6.0 E7	93.9
13	Rubber production	11.5 E14	22.2 E4	2.55
14	Rainforest wood production	6.79 E14	30.8 E4	2.09
15	Electricity, hydro	1.08 E15	15.9 E4	1.72
16	Electricity, thermal	1.99 E15	15.9 E4	3.16
17	Iron exports	1.56 E14	6.0 E7	93.9
18	Rubber exports	11.5 E14	20.6 E4	2.37
19	Rainforest wood exports	2.78 E14	30.8 E4	0.86
20	Merchant fleet, exports	—	—	0.42
21	Services in export	—	—	114.9
22	Services imported	—	—	12.29
23	Fuel imports	19.9 E15	5.17 E4	10.3
24	Goods imported	3.0 E16	5.17 E4	15.5
25	Foreign aid	—	—	.81
26	Foreign investment	—	—	1.85

Footnotes to Table 7.1.

*See Table 2.1 for formulae and explanations for each category of actual energy calculations.

**See Table 3.1 for energy transformation ratios given here.

1. Direct sunlight

Sunlight: $1.30 \text{ E}6 \text{ kcal/m}^2/\text{y}$ (Sellars 1965) = $5.44 \text{ E}9 \text{ J/m}^2/\text{y}$

Liberia: $11,370 \text{ km}^2 = 11.14 \text{ E}10 \text{ m}^2$. Continental shelf average width 17 mi = 28 km. Coastline: 568 km. Total area (land and shelf): $12.73 \text{ E}10 \text{ m}^2$ (Min. Info. 1979).

(Total area) (Average insolation)

$$(12.73 \text{ E}10 \text{ m}^2) (5.44 \text{ E}9 \text{ J/m}^2/\text{y}) = 6.9 \text{ E}20 \text{ J/y}$$

2. Wind

Used typical values for Tampa, Florida in July: Eddy diffusion $1.7 \text{ m}^3/\text{m}^2/\text{sec}$, vertical gradient 1.5 m/s/m (Odum et al. 1983)

(mass) (eddy diffusion) (vertical gradient)² (area)

$$(1 \text{ m}^2) (1000 \text{ m}) (1.23 \text{ kg/m}^3) (1.7 \text{ m}^3/\text{m}^2/\text{s}) (3.14 \text{ E}7 \text{ s/y})$$

$$(1.5 \text{ E-}3 \text{ m/s/m})^2 (11.14 \text{ E}10 \text{ m}^2) = 1.65 \text{ E}16 \text{ J/y}$$

3. Rain, chemical potential

Precipitation: $174.9'' = 4.4 \text{ m/y}$ (Min. Info. 1979b)

(area land + shelf) (av. rain) (Gibbs free energy) (units)

$$(12.73 \text{ E}10 \text{ m}^2) (4.4 \text{ m/y}) (4.94 \text{ J/g}) (1 \text{ E}6 \text{ g/m}^3) = 2.76 \text{ E}18 \text{ J/y}$$

4. Rain geopotential

Average elevation: 250 m (von Gnielinski 1972), Runoff: 3 m/y (Min. Info. 1979b)

(area land) (av. elevation) (runoff) (density) (gravity)

$$(11.14 \text{ E}10 \text{ m}^2) (250 \text{ m}) (3 \text{ m/y}) (1 \text{ E}3 \text{ kg/m}^3) (9.8 \text{ m/s}^2)$$

$$= 8.19 \text{ E}17 \text{ J/y}$$

Footnotes to Table 7.1 continued.

5. Tide

Mean tide amplitude, spring tide: 1.2 m (Dietrick 1963).
Absorbing area of shelf (estuaries negligible): 525 km
straight coastline, average width 28 km. 730 tides/y.

$$(\text{shelf area}) (0.5) (\text{tides/y}) (\text{av. ht.})^2 (\text{density}) (\text{gravity})$$

(% absorbed)

$$(1.47 \text{ E}10 \text{ m}^2) (0.5) (706/\text{y}) (1.2 \text{ m}) (1.2 \text{ m}) (1.025 \text{ E}3 \text{ kg/m}^3)$$

$$(9.8 \text{ m/s}^2) (.5) = 3.75 \text{ E}16 \text{ J/y}$$

6. Waves

To get wave velocity: $Gd = (\text{gravity}) (\text{depth}) = (9.8 \text{ m/s}^2)$
(4 m) = $39.2 \text{ m}^2/\text{s}^2$. Wave velocity = $\text{sq. rt } Gd = 6.26$.
Average wave height: 0.99 m.

$$(\text{straight shore lgth}) (1/8) (\text{density}) (\text{gravity}) (\text{ht})^2 (\text{velocity})$$

$$(525 \text{ E}3 \text{ m}) (1/8) (1.025 \text{ E}3) (9.8 \text{ m/s}^2) (.99 \text{ m}) (.99 \text{ m}) (6.3 \text{ m/s})$$

$$(3.15 \text{ E}7 \text{ s/y}) = 1.28 \text{ E}17 \text{ J/y}$$

7. Rivers, physical potential in sediment load

Erosion: 50-100 tons/km² (Snead 1980)

$$(\text{erosion/area/y}) (\text{area}) (\text{gravity}) (\text{average elevation})$$

$$(75 \text{ E-}6 \text{ T/m}^2/\text{y}) (11.14 \text{ E}10 \text{ m}^2) (1 \text{ E}3 \text{ kg/T}) (9.8 \text{ m}^2/\text{s}^2) (250 \text{ m})$$

$$= 2.05 \text{ E}13 \text{ J/y}$$

8. Rivers, flowing geopotential

Volume flow of the 6 major rivers: 58 mil acre-feet (Min.
Info. 1979 a)

$$(\text{volume flow}) (\text{density}) (\text{av. ht. river}) (\text{gravity})$$

$$(7.05 \text{ E}10 \text{ m}^3/\text{y}) (1 \text{ E}3 \text{ kg/m}^3) (250 \text{ m}) (9.8 \text{ m/s}^2) = 1.72 \text{ E}17 \text{ J/y}$$

9. Top soil deposition

$$(\text{farmed area}) (850 \text{ g/m}^2/\text{y}) - (\text{area of secondary forest})$$

$$(1260 \text{ g/m}^2/\text{y}) (2280 \text{ sq. mi.}) (2.6 \text{ E}6 \text{ m}^2/\text{sq. mi}) (850 \text{ s/m}^2/\text{y}) -$$

$$- (4.85 \text{ E}6 \text{ acres}) (4046.9 \text{ m}^2/\text{acre}) (1260 \text{ g/m}^2) (1.97 \text{ E}13 \text{ s/m}^2/\text{y})$$

$$(0.03) (5.4 \text{ kcal/g}) (4186 \text{ J/kcal}) = 1.34 \text{ E}16 \text{ J/y}$$

Footnotes to Table 7.1 continued.

$$\begin{aligned} & (\text{elevation rate}) (\text{area}) (\text{density}) (\text{J/g}) \\ & (0.5 \text{ E-5 m/y}) (11.14 \text{ E10 m}^2) (2.6 \text{ E6 g/m}^3) (50 \text{ J/g}) \\ & = 7.24 \text{ E13 J/y} \end{aligned}$$

10. Rock uplift, geopotential

Rock uplift of granite assumed 1/5 of world rate (Judson 1968): 0.5 cm/1000 y.

$$\begin{aligned} & (\text{elevation rate}) (\text{area}) (\text{rock density}) (0.5) (\text{gravity}) \\ & (\text{elevation}) \\ & (0.5 \text{ E-5 m/y}) (11.14 \text{ E10 m}^2) (2.6 \text{ E3 kg/m}^3) (0.5) (9.8 \text{ m/s}^2) \\ & (0.5 \text{ E-5 m/y}) = 3.5 \text{ E4 J/y} \end{aligned}$$

11. Net loss of earth

Erosion: 50-100 T/km²/y (Snead 1980); typical formation rate, 31.2 g/m²/y.

$$\begin{aligned} & ((\text{erosion rate}) - (\text{formation rate})) (\text{area of country}) \\ & ((75 \text{ g/m}^2) - (31.2 \text{ g/m}^2)) (11,370 \text{ E6 m}^2) = 4.98 \text{ E11 g/y} \end{aligned}$$

Since the data on the earth formation rate in moist tropics are not available, this earth loss value was omitted from the totals.

12. Iron

Iron ore (Fe content) mined: 11.0 E6 metric tons, 1977 (U.N. 1981). Free energy: 14.2 J/g (Gilliland 1983).

$$\begin{aligned} & (\text{T/y}) (\text{Gibbs free energy}) \\ & (11.0 \text{ E6 T/y}) (14.2 \text{ J/g}) (1 \text{ E6 g/T}) = 1.56 \text{ E14 J/y} \end{aligned}$$

13. Rubber

Rubber produced: 78.5 E3 metric tons/y (U.N. 1981). 3.5 kcal/g.

$$\begin{aligned} & (\text{T/y}) (\text{Gibbs free energy}) \\ & (78.5 \text{ E3 T/y}) (1.47 \text{ E4 J/g}) (1 \text{ E6 g/T}) = 1.15 \text{ E15 J/y} \end{aligned}$$

Footnotes to Table 7.1 continued.

14. Rainforest wood

Production of roundwood without bark: $4.6 \text{ E}6 \text{ m}^3$, 1977.
Sawn wood production: $233 \text{ E}3 \text{ m}^3$, 1977 (U.N. 1981).
Total wood produced: $4.83 \text{ E}6 \text{ m}^3$. Density of rainforest
wood: 0.8 g/cm^3 ; 4.2 kcal/g . Grams of wood: (wood m^3)
(density) = $(4.83 \text{ E}6 \text{ m}^3)(.8 \text{ g/cm}^3)(1 \text{ E}4 \text{ cm}^3/\text{m}^3) = 3.86 \text{ E}10 \text{ g}$
(T/y) (kcal/g) (4186 J/kcal)
 $(3.86 \text{ E}10 \text{ g})(4.2 \text{ kcal/g})(4186 \text{ J/kcal}) = 6.79 \text{ E}14 \text{ J/y}$

15. Electricity, hydro

$300 \text{ E}6 \text{ kWh}$, 1977 (U.N. 1981)
 $(300 \text{ E}6 \text{ kWh/y})(3.6 \text{ E}6 \text{ J/kWh}) = 1.08 \text{ E}15 \text{ J/y}$

16. Electricity, thermal

$552 \text{ E}6 \text{ kWh}$, 1977 (U.N. 1981)
 $(600 \text{ E}6 \text{ kWh/y})(3.6 \text{ E}6 \text{ J/kWh}) = 1.99 \text{ E}15 \text{ J/y}$

17. Iron exports

All iron is exported.

18. Rubber exports

All rubber produced is exported.

19. Rainforest wood exported

41% of the cut wood is exported (Min. Info. 1979a).
 $(.41)(6.79 \text{ E}14 \text{ J/y}) = 2.78 \text{ E}14 \text{ J/y}$

20. Merchant Fleet Export

(Local energy/\$ ratio) (\$)
 $(2.57 \text{ E}13 \text{ SEJ/\$})(\$16.5 \text{ E}6) = 0.42 \text{ E}20 \text{ SEJ}$

Footnotes to Table 7.1 continued.

21. Services exported

(Local energy/\$ ratio) (\$)

$$(2.57 \text{ E13 SEJ}/\$) (447 \text{ E6 } \$) = 114.9 \text{ E20 SEJ}$$

22. Services imported

(US energy/\$ ratio) (\$)

$$(2.31 \text{ E12 SEJ}/\$) (532 \text{ E6 } \$) = 12.29 \text{ E20 SEJ}$$

23. Fuels imported

.6 E6 T coal equivalent (Sivard 1981). 1 mtce = 5.05 bbl oil:

$$(5.05 \text{ bbl}) (.6 \text{ E6 T}) = 3.0 \text{ E6 bbl oil}$$

$$(3.0 \text{ E6 bbl}/\text{y}) (6.28 \text{ E9 J}/\text{bbl}) = 19.9 \text{ E15 J}/\text{y}$$

24. Goods imported

Imports, 1977: 532 E6 \$US; food 28%, machinery, etc., 72% (Min. Info. 1979a). Rice in fuel equivalents: 26.47 MJ/1974 \$; machinery in fuel equivalents: 82.0 MJ/1974 \$ (Fluck and Baird 1980). Inflation rate of 50%/year reduces values to rice in 1977 \$ = 22.5 MJ/\$; machinery in 1977 \$ = 69.7 MJ/\$.

$$\text{Food: } (.28) (532 \text{ E6 } \$) (22.5 \text{ E6 J}/\$) = 3531.6 \text{ E12 J}$$

$$\text{Machinery: } (.72) (532 \text{ E6 } \$) (69.7 \text{ E6 J}/\$) = 26697.9 \text{ E12 J}$$

$$\text{Total} = 3.0 \text{ E16 J fuel eq.}/\text{y}$$

25. Foreign aid

35 E6 \$ US (Min. Info. 1979b)

$$(35 \text{ E6 } \$\text{US}) (2.31 \text{ E12 SEJ}/\$) = .81 \text{ E20 SEJ}/\text{y}$$

26. Foreign investment

80.1 E6 \$US (Min. Info. 1979b)

$$(80.1 \text{ E6 } \$\text{US}) (2.31 \text{ E12 SEJ}/\$) = 1.85 \text{ E20}$$

Table 7.2. Energy Storages of Liberia.

Foot-note	Type of Energy	Actual Energy J	Energy Transformation Ratio (ETR) SEJ/J	Embodied Solar Energy E24 SEJ
1	Rainforest soil, chem.	4.7 E19	6.25 E4	2.9
2	Rubber plantation trees	-	-	0.0027
3	Rainforest wood, marketable	1.42 E19	30.8 E4	4.37
4	Rainforest wood, local use	2.05 E19	3.49 E4	0.72
5	Iron, chemical	16.1 E15	6.0 E7	0.97
6	Bedrock (granite), chem.	14.54 E19	1.71 E7	2486.3
7	Mountain rock, geo.	7.09 E18	7.21 E15	(51.2 E33)

Footnotes to Table 7.2.

1. Rainforest soil, chemical potential

(Volume of material) (density) (organic fraction)

(J/g organic matter)

(.18 m) (11.14 E10 m²) (1.47 E6 g/m³) (0.07 E-3)

(2.26 E4 J/g) = 4.7 E19 J

2. Rubber plantation trees

Plantation area: 7.7 E8 m². Renewable energy and labor used: 2.19 E20 SEJ/y (Table 7.7). Trees produce for 25 years (Ency. Brit 1973)

(annual energy used) (average tree age)

(2.19 E20 SEJ/y) (12.5 y) = 0.000027 E26 SEJ/y

3. Rainforest wood, marketable quality

8.95 E6 acres virgin forest, 4.85 E6 acres secondary forest (Min. Info. 1979). 50,000 g/m² virgin; 10,000 g/m² secondary. 4.2 kcal/g virgin; 3.5 kcal/g secondary.

Footnotes to Table 7.2 continued.

Virgin forest:

$$\begin{aligned} & (\text{area}) (\text{wood } \text{g}/\text{m}^2) (\text{kcal}/\text{g}) (\text{J}/\text{kcal}) \\ & (8.95 \text{ E6 acres}) (4047 \text{ m}^2/\text{acre}) (50,000 \text{ g}/\text{m}^2) (4.2 \text{ kcal}/\text{g}) \\ & (4186 \text{ J}/\text{kcal}) = 3.18 \text{ E19 J} \end{aligned}$$

Secondary forest:

$$\begin{aligned} & (4.85 \text{ E6 acres}) (4047 \text{ m}^2/\text{acre}) (10,000 \text{ g}/\text{m}^2) (3.5 \text{ kcal}/\text{g}) \\ & (4186 \text{ J}/\text{kcal}) = 2.88 \text{ E18 J} \end{aligned}$$

Total:

$$31.8 \text{ E18 J} + 2.88 \text{ E18 J} = 24.7 \text{ E18 J}$$

41% of the cut wood is exported.

$$(34.7 \text{ E18 J}) (.41) = 1.4 \text{ 2E19 J}$$

4. Rainforest wood, local use

41% of the wood is exported. Total: 34.7 E18 J

$$(.59) (34.7 \text{ E21 J}) = 2.05 \text{ E19}$$

5. Iron deposits, chemical potential

Estimated reserves: 1138.3 E6 tons (Collier Ency. 1982).
14.2 J/g (Gilliland 1983).

$$(1138 \text{ E6 T}) (1 \text{ E6 g}/\text{T}) (14.2 \text{ J}/\text{g}) = 16.1 \text{ E15 J}$$

6. Bedrock (granite) chemical potential

$$\begin{aligned} & (\text{area}) (\text{depth}) (\text{granite density}) (\text{J}/\text{g}) \\ & (11.14 \text{ E10 m}^2) (10 \text{ m}) (1 \text{ E6 cm}^3/\text{m}^3) (2.61 \text{ g}/\text{cm}^3) (50 \text{ J}/\text{g}) \\ & = 14.54 \text{ E19 J} \end{aligned}$$

7. Mountain rock, geopotential

10 m crust of land bare rock.

(av.ht.) (area) (granite density) (gravity) (ht. center of gravity of mass)

$$\begin{aligned} & (10\text{m}) (11.14 \text{ E10 m}^2) (1 \text{ E6 cm}^3/\text{m}^3) (2.6 \text{ g}/\text{cm}^3) (1 \text{ E-3 kg}/\text{g}) \\ & (9.8 \text{ m}/\text{s}^2) (245) = 7.09 \text{ E18 J} \end{aligned}$$

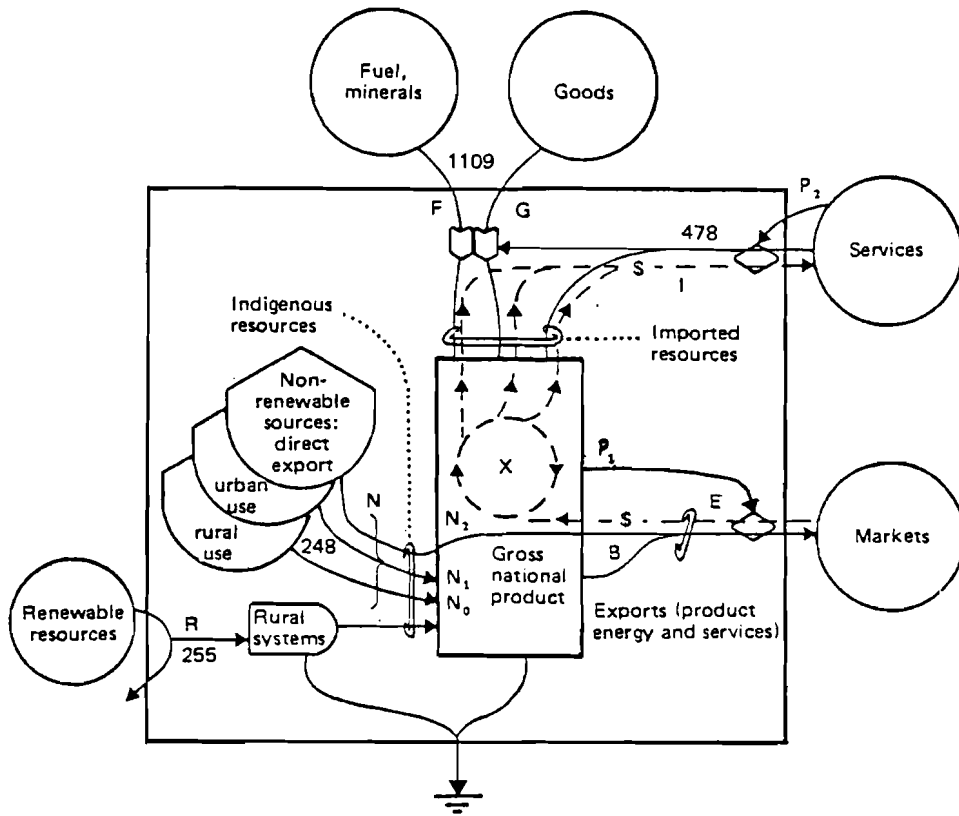

$$P_1 = \frac{\text{Energy Used}}{\text{GNP}} = \frac{R + N_0 + N_1 + F + G + P_2 I}{X}$$

(a)

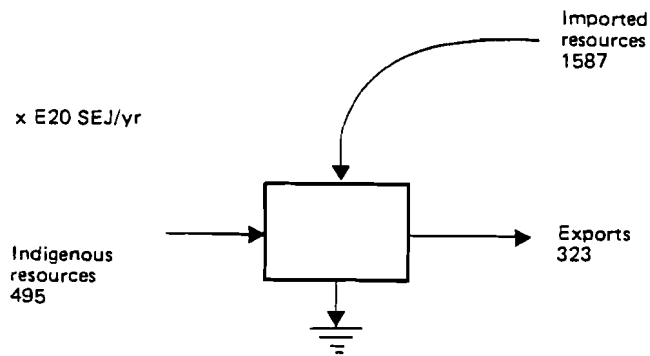

(b)

Figure 7.3. Summary diagram of the embodied energy flows of Liberia. Evaluations are given in Table 7.3. Indices from these values are calculated in Table 7.4.

Table 7.3. Summary flows for Liberia in Figure 7.6.

Letter in Figure 7.6	Item	Embodied solar energy E20 SEJ/y	Dollars E6 \$/y
R	Renewable sources used, SEJ/yr (rain, chem)	427.3	—
N	Nonrenewable sources flow within the country (SEJ/yr):		
	N ₀ Dispersed rural source (SEJ/yr)	—	—
	N ₁ Concentrated use (SEJ/yr)	—	—
	N ₂ Exported without use (iron)	93.9	—
F	Imported minerals and fuels (SEJ/yr)	10.3	—
G	Imported goods (SEJ/yr)	15.5	—
P ₂ I	Imported service (SEJ/yr)	12.3	—
I	Dollars paid for imports (\$/yr)	—	532.
E	Dollars paid for exports (\$/yr)	—	447.
P ₁ E	Exported services (SEJ/yr)	154.2	—
B	Exported products, transformed within the country (SEJ/yr) (rubber, wood)	3.1	—
X	Gross National Product (\$/yr)	—	1349
P ₂	Ratio embodied energy to dollar of imports (SEJ/\$) (US)	2.60 E12 SEJ/\$	
P ₁	Ratio embodied energy to dollar of country and for its exports (SEJ/\$)	3.45 E13 SEJ/\$	

Footnotes to Table 7.3.

- R Chemical potential energy of rain is the largest renewable source (Table 7.1): 427.3 E20 SEJ/y.
- N₂ Iron (Table 7.1): 93.9 E20 SEJ/y.
- F Fuels imported: (19.9 E15 J) (5.17 E4 SEJ/J = 10.3 E20 SEJ/y).
- G Goods imported: rice, machinery, consumer goods (Table 7.1): 15.5 E20 SEJ/y.

Footnotes to Table 7.3 continued.

P_2I Labor, service: (532 E6 \$US) (2.31 E12 SEJ/\$) =
= 12.3 E20 SEJ/y
Since the double-counting of services (P_2I) in fuels (F)
and goods (G) is small in Liberia, no correction was made.

I Dollars paid for imports: 532 E6 \$US

E Dollars received for exports: 447 E6 \$US

P_1E Exported service: (3.45 E13 SEJ/\$) (447 E6 \$) =
= 154.2 E20 SEJ/y.

B Exported products transformed within the country; (Table
7.1). Rubber: 2.22 E20 SEJ/y; wood: 0.86 E20 SEJ/y;
2.22 E20 + 0.86 E20 = 31 E20 SEJ/y.

X Gross national product (Min. Info. 1979b):

(GDP) + (export \$,E) + (aid) + (investment) + (merchant
fleet)

(770 + 447 + 35 + 80.1 + 16.5) E6 \$ = 1349 E6 \$

P_2 US energy/\$ ratio (Appendix A4): 2.60 E12 SEJ/\$

P_1 Energy/dollar ratio, $P_1 = \frac{R + N_0 + N_1 + F + G + P_2I}{X}$:
$$\frac{(427.3 + 10.3 + 15.5 + 12.3)E20 \text{ SEJ/y}}{1349 \text{ E6 } \$/y} = \frac{465 \text{ E20}}{1349 \text{ E6}} =$$

= 3.45 E13 SEJ/\$

The ratio of 3.45 E13 SEJ/\$1 is more than 10 times that of the U.S. (2.60 E12 SEJ/\$). For every dollar an importer paid Liberia, he got 10 times the embodied energy which that dollar would buy in the U.S.

Energy Evaluation of the Balance of Trade

The embodied energy in international exchange is given in Figure 7.4. The service energy flows for the exports were calculated using the energy-dollar ratio of Liberia, and the service for the imports was calculated from the energy-dollar ratio of the U.S. as the average for the nations from which Liberia imported. Any payment of dollars to Liberia was calculated with the Liberian ratio: imports were calculated with the U.S. ratio.

The money balance of payments shows that Liberia paid out a small amount more money than it took in. But, the embodied energy trade ratio shows a tremendous net drain of energy. The country's greater embodied energy in exports than imports indicated its grouping among the colony-type countries which export more embodied energy than they import.

National Overview Ratios

Various ratios, calculated from data in Figure 7.3 and Table 7.3 are given in Table 7.4. These include ratios of outside to inside energies, exports to imports, fuel use to environmental energies, energy per person, and carrying capacity. These ratios can be used for predictions and comparisons with other countries.

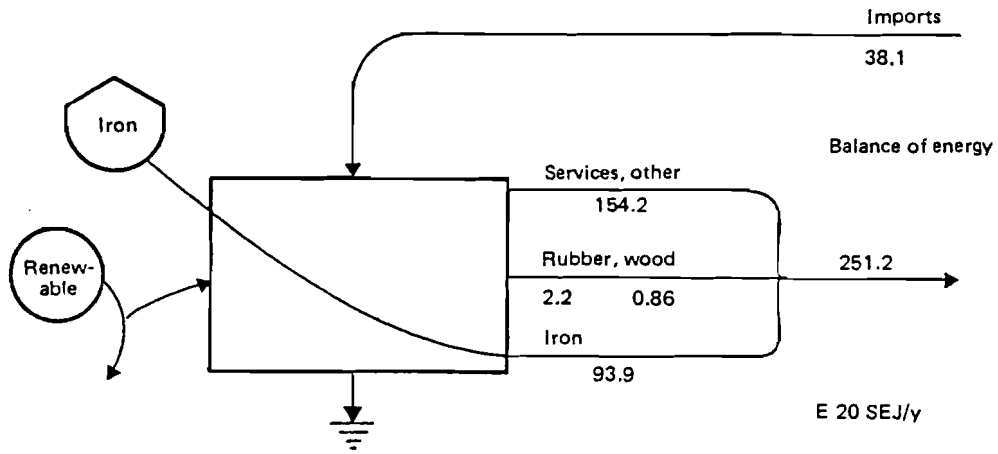

(a)

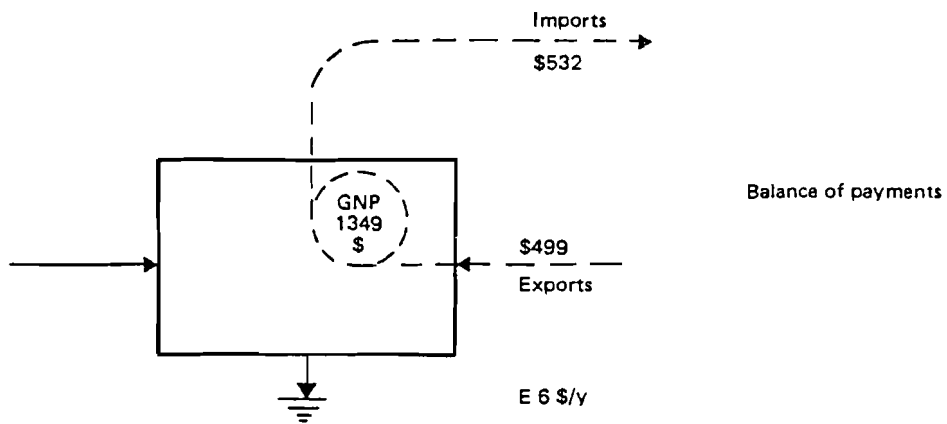

(b)

Figure 7.4. Flows in international trade.
(a) Energy flows; (b) Dollar flows.

Table 7.4. Indices using embodied energy for overview of Liberia.

Item	Name of index and expression, see Figure 6.6.		
1	Renewable embodied energy flow	R	427.3 E20 SEJ/y
2	Flow from indigenous non-renewable reserves	N	93.9 E20 SEJ/y
3	Flow of imported embodied energy	$F+G+P_2I$	38.1 E20 SEJ/y
4	Total embodied energy inflows	$R+N+F+G+P_2I$	559.3 E20 SEJ/y
5	Total embodied energy used, U	$U = N_1+R+F+G+P_2I$	465.4 E20 SEJ/y
6	Total exported embodied energy	$B+P_1E$	405.4 E20 SEJ/y
7	Fraction of embodied energy used derived from home sources	$(N_1+R)/U$	0.92
8	Exports minus imports	$(N_2+B+P_1E) - (F+G+P_2I)$	213.1 E20 SEJ/y
9	Ratio of exports to imports	$(N_2+B+P_1E)/(F+G+P_2I)$	6.6/1
10	Fraction used, locally renewable	R/U	0.92
11	Fraction of use purchased	$(F+G+P_2I)/U$	0.082
12	Fraction used that is imported service	P_2I/U	0.026
13	Fraction of use that is free	$(R+N_0)/U$	0.92
14	Ratio of concentrated to rural	$(F+G+P_2I+N_1)/(R+N_0)$	0.089
15	Use per unit area (11.14 E10 m ²)	$U/(\text{area})$	4.18 E11 SEJ/m ² /y
16	Use per capita (1.8 E6 population)	$U/(\text{population})$	2.6 E16 SEJ/cap/y
17	Renewable carrying capacity at present living standard	$(R/U) (\text{population})$	1.65 E6 people
18	Developed carrying capacity at same living standard	$8(R/U) (\text{population})$	13.2 E6 people
19	Ratio of use to GNP (energy-dollar ratio)	$P_1 = U/(\text{GNP})$	3.45 E13 SEJ/\$

Total use of nonrenewable resources, N , is made up of that which is rurally dispersed and used, N_0 ; that used intensively, N_1 ; and raw product exported without much transformation, N_2 . Whereas goods export, B and service export, P_1E carry embodied energy that may be derived from imports, they represent transformations and are the products of use.

Subsystems

Three subsystems were analysed, iron and rubber as the most important exports, and rain forest wood export as the most important natural system.

Iron

Iron which was concentrated by the geological processes millions of year ago is a very high quality resource. Liberia in 1977 was the eleventh largest producer of iron in the world (U.N. 1981). Liberia's iron should become more important as supplies decrease in other countries and its mining becomes more efficient. Even though the calculation of its reserves (Table 7.2) was not based on the net energy of the estimated reserves, it may be that Liberia will have iron available to export at the 1977 rate for 100 years, if there is fuel to transport it.

As shown in Table 7.5, the export of iron with its embodied energy may be compared with the money received for this iron. When both are put in units of equivalent energy, SEJ/y, the yield to the outside purchaser is found to be 93.9 E20 SEJ to 11.18 E20 SEJ received by Liberia. In other words, the export of iron stimulated the outside economy about nine times more than Liberia's.

Diamonds, gold and other minerals may be mined in the future.

Table 7.5.

Foot-note	Item	Units per y	Actual Energy J/y	ETR SEJ/J	E20 SEJ/y
1	Iron export	11,0 E6 T	1.56 E14	6.0 E7	93.9
2	Transport fuel		296 E12	5.3 E4	0.42
3	Payments received	\$ 484.1 E6		2.31 E12 SEJ/\$	11.18

Footnotes to Table 7,5.

1. Table 7.1.
2. Distance shipped: av. 75 km. 0,96 MJ/T/km (Fluck and Baird 1980). (11,0 E6 T) (0,96 E6 J/T/km) (75 km) = 396 E12 J.
3. Dollars 484.1 E6/y (Min. Info. 1979a).

Rubber

Rubber was the largest cash crop produced in Liberia. About half was produced on small farms with Liberian owners and half by large U.S. companies. A small amount was processed within the country. The workers who tended the trees lived relatively steady lives in small villages near streams for washing and plots for growing food. An energy diagram of a rubber plantation is given in Figure 7.5.

It shows the net energy yield ratio of 1.6/1, a small but positive net energy. The investment ratio of 1.7/1 was less than the 8/1 of the U.S. but about equal to the world average ratio of 1.6/1 (Section 5). The embodied energy trade ratio showed a loss for the country of embodied energy compared to what the income would buy, but the ratio was not so bad as for the iron mining.

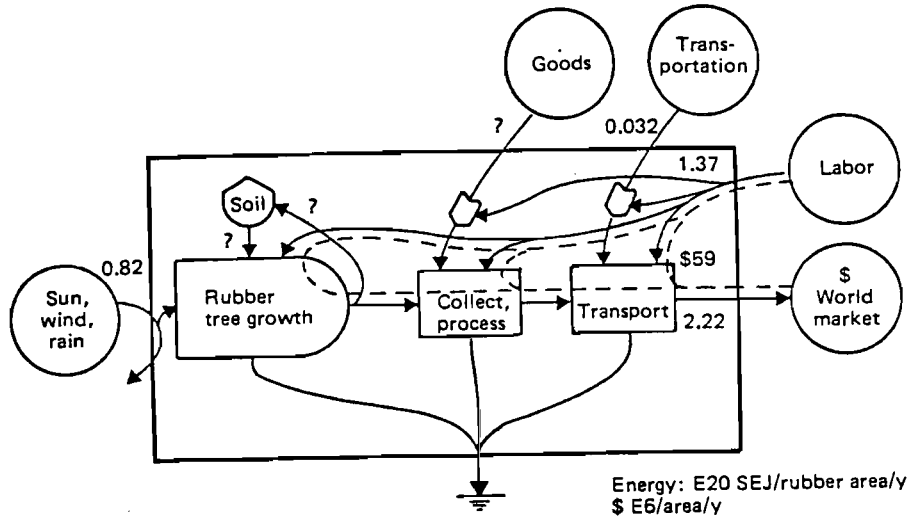

(a)

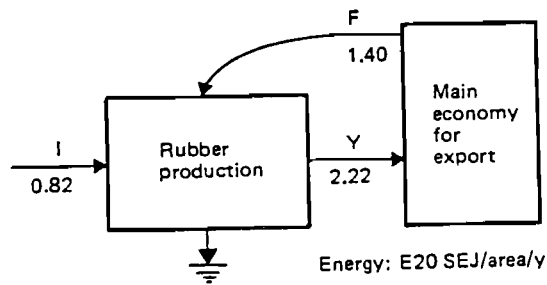

(b)

$$\begin{aligned}
 Y/F &= 1.6 \\
 F/I &= 1.7 \\
 ETR &= 20.6 \text{ E4 SEJ/J}
 \end{aligned}$$

Figure 7.5. Energy flows in natural rubber production.
 (a) Embodied energies and dollars of main flows; (b) Aggregated summary.

The energy transformation ratio for rubber production of 20.6 E4 SEJ/J (Table 7.6) was more than that for rainforest wood clear-cut (3.49 E4 SEJ/J) but less than for rainforest wood selectively logged (30.0 E4 SEJ/J) (Table 3.1).

As fuels become more scarce in the world, the net energy yield ratio will go down, and rubber may not be worth growing. However, as there becomes less fossil fuel to manufacture synthetic rubber, it may be worthwhile to the industrial countries to buy natural rubber, even if it is no longer a net energy.

Another factor is the trend toward more local production. This may decrease the fuel inputs, raising the yield ratio. More local production would also mean more stimulus to the local economy.

Rain Forest

Liberia's 9 million acres of rain forest were fast being depleted (Figure 7.6). Subsistence shifting agriculture can rotate the land use in a steady state system. But, much more was being cut commercially than was being reforested. If the figures are right and the trends continue, all the rain forest will be gone by the year 2010.

The forest consists of very high quality trees: teak, mahogany, walnut, ironwood, makore, and sikon (classified in 1957 and called *Tetraberlinia tubmaniana*, after the former president). About 40% of the cut timber was exported, at a net energy ratio of 547/1 (Table 7.7). This is consistent with the high net energy of the harvest of New Zealand podocarp trees (Odum and Odum 1979). The embodied energy trade ratio was very low, another example of the great loss from Liberia of its embodied energy.

Table 7.6. Liberian rubber plantation subsystem (for Figure 7.5).

Foot-note	Kind of energy	Actual energy	Energy transformation ratio (ETR) SEJ/J	Embodied solar energy E20 SEJ/rubber area/y
1	Renewable inflow, I	5.31 E15	15,444	0.82
2	Rubber yield, Y	10.79 E14	2.06 E5	2.22
3	Labor, services	—	—	1.54
4	Transport	19.0 E12 CEJ	1.7 E5 fuel	.032
5	Total feedback, F	—	—	1.57
6.	Energy transformation ratio of collected rubber			2.22 E5 SEJ/J

Footnotes to Table 7.6.

1. Renewable energy inflow, I

Rain: 4.4 m/y; runoff: 3 m/y; 4.4 - 3 = 1.4 m/y used.

$$(1.4 \text{ m/y}) (4.94 \text{ J/g}) (1 \text{ E6 g/m}^3) = 6.9 \text{ E6 J/m}^2/\text{y}$$

$$(6.9 \text{ E6 J/m}^2) (7.7 \text{ E8 m}^2) = 5.31 \text{ E15 J/area/y}$$

$$(5.31 \text{ E15 J/area}) (15,444 \text{ SEJ/J}) = .82 \text{ E20 SEJ/area/y}$$

2. Rubber produced

Production: 170.4 E6 lbs; export revenue: 59.1 E6 \$US; 294,400 acres, 65% cultivated (Min. Info 1979b). 3.349 kcal/g

$$(294 \text{ E3 acres}) (.65) (4047 \text{ m}^2/\text{acre}) = 7.7 \text{ E8 m}^2 \text{ area}$$

$$(170.4 \text{ E6 lbs}) (453.6 \text{ g/lb}) = 7.7 \text{ E10 g/y}$$

$$(7.7 \text{ E10 g/y}) (3.349 \text{ kcal/g}) (4186 \text{ J/kcal}) = 10.79 \text{ E14 J/y yield}$$

3. Export services of nonrenewable feedback

\$ export: 59.1 E6 \$US, 1977 (Min. Info. 1979a); energy/\$ ratio: 2.60 E12 SEJ/\$US

$$(2.60 \text{ E12 SEJ/$US}) (59.1 \text{ E6 \$}) = 1.54 \text{ E20 SEJ/y}$$

Footnotes to Table 7.6 continued.

4. Transportation part of nonrenewable feedback

Average width of country = 125 km from plantation by truck.
170.4 E6 lbs rubber. Transport: 1.78 E6 J/T/km (Fluck and Baird 1980)

$$(1.79 \text{ E6 J}) (179.4 \text{ E6 lbs}) (1/2000 \text{ T/lb}) (125 \text{ km}) = 19.0 \text{ E12 J/y}$$

5. Feedback

$$\text{Labor + transport: } F = 1.54 \text{ E20} + .032 \text{ E20} = 1.57 \text{ E20 SEJ/y}$$

6. Energy transformation ratio

ETR = (I + F)/y; F = labor service and transport

[(natural inflow) + (labor) + (transport)]/(rubber yield)

$$(10.66 \text{ E10 SEJ/m}^2/\text{y})(7.7 \text{ E8 m}^2) + (59.1 \text{ E6 } \$/\text{y})(2.60 \text{ E12 SEJ}/\text{\$})$$

$$+ (19.0 \text{ E12 J/y})(1.7 \text{ E5 SEJ/y}) = 2.39 \text{ E20 SEJ/y}$$

$$2.39 \text{ E20 SEJ}/10.79 \text{ E14 J} = 2.22 \text{ E5 SEJ/J}$$

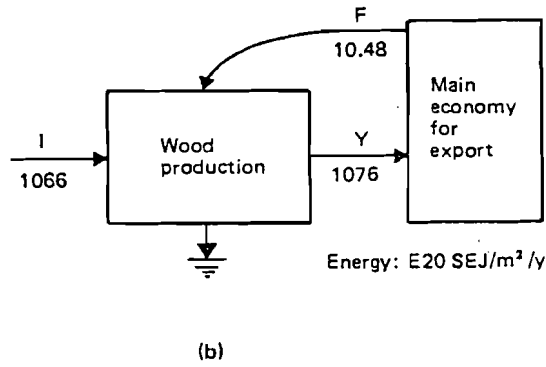
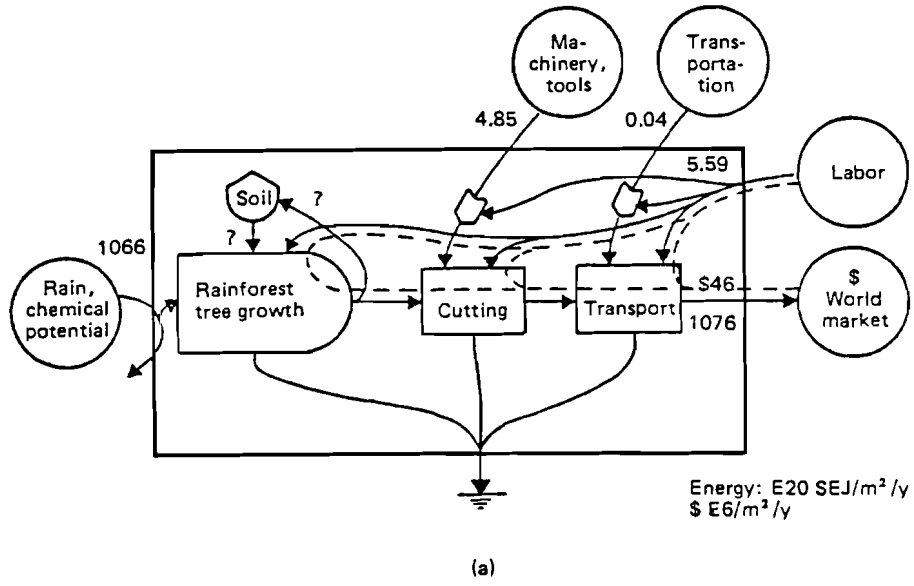

$Y/F = 102.7$
 $F/I = 0.0098$
 $ETR = 30.8 \text{ E4 SEJ/J}$

Figure 7.6. Energy flows in rain forest wood production.
 (a) Embodied energies and dollars of main flows; (b) Aggregated summary.

Table 7.7. Liberian rain forest wood production subsystem (for Figure 7.6).

Foot-note	Kind of energy	Actual energy J/m ² /y	Energy transformation ratio (ETR) SEJ/J	Embodied solar energy E10 SEJ/m ² /y
1	Rain, I	6.9 E8	15,444	1066.0
2	Wood yield, Y	3.5 E7	30.7 E4	1076.0
3	Export, services	—	—	5.9
4	Feedback, transport, fuel	2.4 E3	1.7 E5 (fuel ETR)	.04
5	Feedback, cutting	2.85 E5	1.7 E5 (fuel ETR)	4.85
6	Selected rainforest timbers shipped:		30.8 E4	

Footnotes to Table 7.7.

1. Renewable inflow, rain embodied in the wood

Rain: 4.4 m/y; runoff: 3m/y (Min.Info 1979a); 100 years to grow rainforest trees.

4.4 m - 3 m = 1.4 m/y used.

$$(1.4 \text{ m}^3) (4.94 \text{ J/g}) (1 \text{ E6 g/m}^3) (100 \text{ y}) = 6.9 \text{ E8 J/m}^2/\text{y}$$

2. Yield of rainforest wood production

Total rainforest: 12 E6 acres; 4% cut/y (Min.Info. 1979a).
Yield: sawnwood 233 E3 m³; roundwood 4.6 E6 m³, 1977 (U.N. 1981). Density of rainforest wood: 0.8 g/cm³.

Area cut: (12 E6 acres) (4047 m²/acre) (.04) = 1.9 E9 m²/y

Yield: (4.8 E6 m³/y) (0.8 g/cm³) (1 E6 cm³/m³) = 3.84 E12 g/y

(4.2 kcal/g) (4186 J/kcal) = 17.58 E3 J/g

(3.84 E12 g) (17.58 E3 J/g) = 6.79 E16 J/y

(6.79 E16 J/y) / (1.95 E9 m²) = 3.48 E7 J/m²/y

Footnotes to Table 7.7 continued.

3. Export services

US energy/dollar ratio: 2.31 E12 SEJ/\$US (Table A4).

Export \$: 46 E6 \$US (Min. Info. 1979a)

$$(46 \text{ E6 } \$\text{US}) (2.31 \text{ E12 SEJ}/\$US) / (1.9 \text{ E9 m}^2) = 5.59 \text{ E10 SEJ}/\text{m}^2/\text{y}$$

4. Transportation fuel

46% exported (Min. Info. 1979a). Transport energy costs:
1.78 E6 J/T/km (Fluck and Baird 1980). Estimated distances
to Monrovia: 1/3 - 100 km, 1/3 - 150 km, 1/3 - 184 km.

$$(3.86 \text{ E10g}) (1 \text{ E-6 T/g}) (.46) = 1.78 \text{ E4 tons exported.}$$

$$(1/3) (1.78 \text{ E4 T}) (1.78 \text{ E6 J/T/km}) (100 \text{ km} + 150 \text{ km} + 184 \text{ km})$$

$$= 4.61 \text{ E12 J}$$

$$(4.61 \text{ E12 J}) / (1.9 \text{ E9 m}^2) = 2.4 \text{ E3 J}/\text{m}^2$$

5. Cutting energies

Forest cutting, logging: 52 E6 J/m³; debarking: 28 E6 J/m³;
loading: 33 E6 J/m³ (N.Z. Min. Forestry 1979)

$$(113 \text{ E6 J}/\text{m}^3) (4.8 \text{ E6 m}^3 \text{ wood}/\text{y}) / (1.9 \text{ E9 m}^2) = 2.85 \text{ E5 J}/\text{m}^2/\text{y}$$

6. Energy transformation ratio

(I + F)/actual J of wood; F = feedback service and trans-
port and cutting in SEJ/m²/y

$$(1066. + 5.59 + 0.04 + 4.85) \text{ E10 SEJ} / 3.5 \text{ E7 J} = 3.08 \text{ E5 SEJ}/\text{J}$$

Discussion

Economic growth

The ratio of outside energy flow to inside flow (.082, Table 7.4) is lower than in most countries and suggests that much more foreign investment can be attracted to Liberia. Therefore, the economic energy prediction would be for more growth.

More stimulus to the economy may result if more of its own embodied energy is used at home. After achieving a balance of cutting and growth in the rain forest, more use of wood within Liberia is possible for its own development of housing, furniture, and crafts. The crafts could be sold to tourists and exported. (As tourists, we could not find any crafts to buy.)

Another suggestion would be to train local workers and executives at all levels, so the embodied energy of their salaries would feed into the Liberia economy.

Rubber

The trend toward more local production of rubber may continue as industrial rubber from fuels becomes relatively more expensive. Perhaps more of the rubber could be refined and manufactured locally. A plant could be set up to make tires, which could then be exported. In this way embodied energy generates jobs within the country.

Hydroelectric Power

Three hundred million kWh (1.08 E15 joules) were produced in 1977 (U.N. 1981); this was 1/3 of the total electricity

produced (Table 7.1). There is great potential for much more since the country has mountains, rivers, and a steady large rainfall. The potential in rivers is $40.7 \text{ E}20$ SEJ/Y (Table 7.1, Footnote 8). This is $7.13 \text{ E}9$ kWh per year, 23 times the present production.

Hydroelectric power plants, built while fuel for bulldozers is still fairly cheap, may supply electric demand as it develops. The electricity will increase the standard of living throughout the country. And, since it is a renewable energy source, it may take the place of oil as its availability decreases. Perhaps the energy of hydroelectric power can be adapted to process iron.

Rain Forest

The cutting of the rain forest both by slash-and-burn farmers and the commercial interests is causing destruction of this valuable potentially-renewable resource. Between 1971 and 1977 only $5.0 \text{ E}7 \text{ m}^2$ (12,300 acres) (Min. Info. 1979a) have been reforested by planting, only about .4% of the area logged.

A plan is needed for growing as much wood and soil as that used, possibly through land rotation planning. Much of the land was owned by the federal government, and all of it was under the control of the Forestry Development Authority. Since the logging was done in concessions, a government forestry policy might be enforced.

Energy Density

The embodied energy use per m^2 is 4.18 E11 SEJ/y. This is very close to that of the U.S. (5.2 E11 SEJ/ m^2 /y). The United States used much more fuel, but Liberia has more renewable energy in its rain, sun, rivers, and mountains.

Energy Per Person

Fuel use per person in Liberia (5.7 E14 SEJ/y) is only about 4% of that in the U.S. (153 E14 SEJ/person/y). However, a better measure of the standard of living is total embodied energy per person. In Liberia this is 2.6 E16 SEJ per person per year, almost the same as the 2.0 E16 SEJ/person/y of the U.S. Even though Liberia does not have the industry and commerce often considered evidence of a high standard of living, the renewable energy per person is very high. Except for the population crowded in cities, the people used renewable energies like those of the sun, wood, water, and homegrown food which did not appear in the money economy. The average income of about \$400 per person in 1977 (U.N. 1981) only represented about 5% of the total energy per person.

The population increase of 3.4% per year (U.N. 1981) will cause the energy per person to decrease if there is no increase in the country's total energy.

Carrying Capacity

The 1977 population was 1.8 million people. If the country existed on only its renewable energies, its carrying capacity at the 1977 standard of living would be only 1.7 million people.

If the country attracted as much economic development as countries like the United States, about eight times more energy would flow in the country. Then the carrying capacity could be eight times greater, about 13.2 million people, at the same standard of living, or the same number of people at an eight times greater energy per person.

If the country could process more of its renewable energies at home and then charge a higher price for them, they would have more money to buy more fuels. This would also increase the carrying capacity.

Education

None of this development can happen without education of the 95% who are illiterate. Education increases the embodied energy of people who can then do more complicated work which can increase the total embodied energy of the country. They can do more jobs in the present industries and expand to others. The poor distribution of resources, and the squalor of Monrovia are indications of the challenge to the educated.

The maximum power principle suggests that energy may find its best use. We shall wait to see what that means in the real world of Liberia.

SUMMARY

This paper is an overview of the energy system of Liberia, including the flows of energy from its resources, land uses, and external trade.

Liberia's economic basis (energy used within the country) was 92% from renewable energies and 8% from imports in 1977. A large flow of embodied energy in iron ore was exported. If its embodied energy can be estimated from its generation rate in the earth cycle, its value was $93.9 \text{ E}20$ solar energy joules (SEJ), a quantity capable of greatly stimulating an economy that can use it. The relatively small amount of energy embodied in Liberia's imports ($38.1 \text{ E}20 \text{ SEJ/y}$) indicates it was sending away more valuable energy in iron than it was receiving in the imports of fuels, goods, and services. Renewable local energies used per person ($2.37 \text{ E}16 \text{ SEJ/y}$) and per m^2 ($3.8 \text{ E}11 \text{ SEJ/y}$) were large, but fuel energies used were small. The rural economy was self-contained, with most of the resources not yet developed for the advantage of the Liberian people.

Howard T. Odum

*Environmental Engineering Sciences and
Center for Wetlands
University of Florida, Gainesville*

Elisabeth C. Odum

*Santa Fe Community College
Gainesville, Florida*

David J. Smith

*Joint Centre for Environmental Sciences
University of Canterbury, Christchurch
New Zealand*

8. ENERGY ANALYSIS OVERVIEW OF NEW ZEALAND

Located in the strong westerly wind belts of the southern hemisphere oceans, New Zealand is a micro-continent that receives much more than its share of environmental energies including strong winds, tides, waves, active orographic uplift processes, heavy rain and snow-falls, and normal solar insolation. The two main islands are shown in Figure 8.1 which also shows the mosaic of present land uses: vast areas of sheep and cattle pastures, native forest patches on mountains and rainy west coast, alpine and tussock grasslands on high mountain slopes, plantation forests, and areas of thorn forest of gorse caused by earlier grazing practices. The mountains of the northern island are volcanic; a longitudinal ridge of rugged mountains of the southern alps are metamorphosed sedimentary rocks, low in phosphorus, uplifting and eroding in a rapid earth cycle. In this chapter an energy analysis overview is evaluated of the economy of humanity and nature of New Zealand.

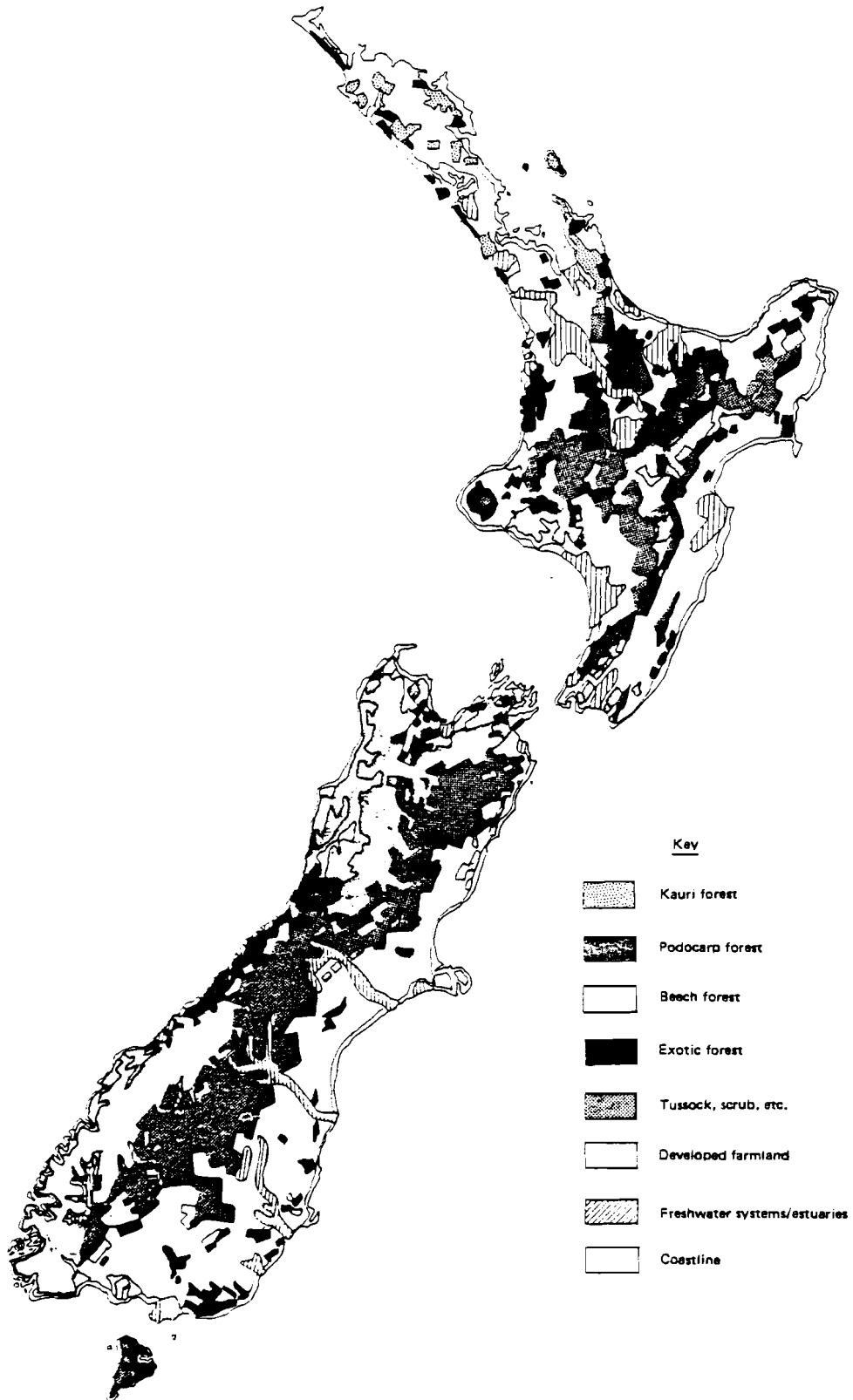

Figure 8.1. Ecosystems and land use of New Zealand.

Figure 8.2 is a moderately aggregated energy network diagram of the main features of the system of humanity and nature of New Zealand compiled following group discussions on what appears important in New Zealand.

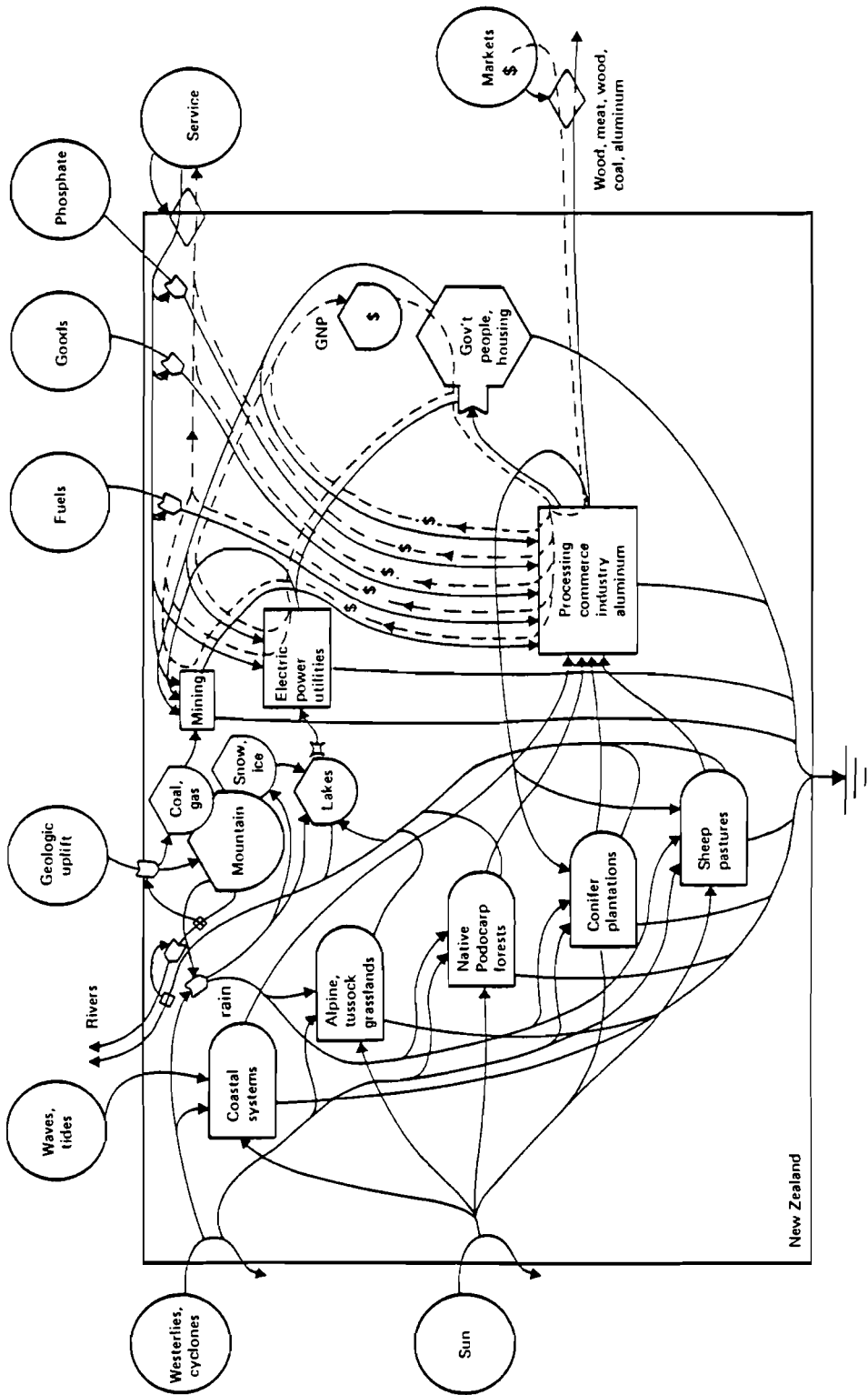

Figure 8.2. Moderately complex overview energy diagram of New Zealand.

ACKNOWLEDGEMENTS

This chapter is a revision of an earlier paper: Energy System of New Zealand and the Use of Embodied Energy for Evaluating Benefits of International Trade (Odum and Odum 1980) written while on an Erskine Fellowship of the University of Canterbury, Christchurch.

We are grateful for the stimulating exchange with Professors Philip Corbet and John Hayward, former and present directors of the Joint Centre for Environmental Sciences (now Environmental Resource Centre); Professor John Peet, Department of Chemical Engineering; Professor George Knox, Zoology; James Baines and Graeme Scott of the Environmental Resource Centre and Professor Kevin O'Conner, Tussock Grasslands and Mountain Lands Institute, during our sabbatical stays at the University of Canterbury. David J. Smith contributed many calculations, but did not see the final version. Figure 8.1 was adapted by Jennifer Merton from a Conservation Week poster, N.Z. Post Office Savings Bank 1979.

METHODS

Methods of energy analysis are those given in Chapters 1-5. These differ from those in our earlier paper (Odum and Odum 1980) by the following: earth heat energy inputs in solar equivalents have been added to the inputs of land processes; a higher solar equivalent for fossil fuels has been used based on data on the wood power plant at Jari, Brazil and on assigning a proportionate earth energy to observed coal in the crust. Net earth uplift was distinguished from earth cycle without net uplift in estimating land processes. For details see Appendices.

RESULTS

The main flows of energy are tabulated in Table 8.1 and the stored reserves are in Table 8.2. Items in tables are comparable, but not all additive since some include others. From these individual items, various categories of embodied energy flows were assembled in Table 8.3 and the accompanying Figure 8.3. Finally, indices of the system were calculated in Table 8.4.

DISCUSSION

Examination of the overview diagram of energy flows in embodied solar equivalents in Figure 8.3b confirms the qualitative diagram (Figure 8.2) in showing the environmental energy support to be as large as the fuels and imports. The list of energy sources running the combined economy of nature and humanity is like a signature to which the environmental systems, land uses,

and culture adapt. That which is distinct in New Zealand is reflected in the magnitudes of the embodied energies of the basic environmental flows.

ENERGY SIGNATURE OF THE ECONOMY

The largest flows in Table 8.1 are the energies of the earth cycle although here there are still questions about the accuracy of the energy transformation ratios. New Zealand landscape is spectacular with signs of uplifting lands, landslides, rapid erosion, and streams heavily laden with boulders and gravels.

Importance of high winds is consistent with the small leaf sizes of evergreen mountain beech forests, episodes of extreme summer drying in foehn winds and incidents of wind-fall in exotic tree plantations.

Importance of large waves and tides are obvious in the wave-cut headlands, coarse beaches, and abundant marine faunas on tidal mud flats.

Heavy precipitation represents a convergence of global energy to New Zealand. The chemical potentials of fresh waters drive exceptional yields of livestock, agriculture and forest production. The chemical potential is relative to saltwater in plant leaves which is maintained by strong winds with drying air, part of which is generated by mountain action providing foehn wind.

Table 8.1. Energy flows of New Zealand, 1980.

Foot-note	Type of Energy	Actual Energy J/y	ETR SEJ/J or SEJ/T	Embodied Solar Energy E20 SEJ/y
Indigenous, renewable sources				
1	Direct sunlight	23.7 E20	1.0	21.2
2	Wind kinetic energy	0.85 E20	663.0	563.0
3	Rain and snow, geopotential	18.1 E17	8.9 E4	161.0
4	Rain, chemical potential	22.1 E17	1.6 E4	341.0
5	Tides	4.1 E17	2.4 E4	96.6
6	Waves	1.18 E18	2.6 E4	306.0
7	Earth cycle, physical energy	1.04 E18	2.9 E4	290.0
8	Hydroelectricity	6.73 E16	1.6 E5	108.0
Renewable production				
9	Plantation wood	7.06 E15	1.87 E4	13.2
10	Wool production	7.47 E15	3.84 E6	287.0
11	Meat production	3.05 E15	1.71 E6	51.8
Indigenous, non-renewable sources				
12	Net topsoil gain, 4.1 E12 g/y	-	1.71 E9 /g	70.0
13	Geothermal electricity	3.77 E15	1.6 E5	6.0
14	Native wood use	7.86 E15	3.49 E4	2.7
15	Coal	5.5 E16	4.0 E4	22.0
16	Indigenous oil	0.41 E16	5.3 E4	0.2
17	Natural gas	3.7 E16	4.8 E4	17.8
18	Fuel electricity			
	coal	6.83 E15	4.0 E4	2.7
	gas	4.0 E15	4.8 E4	1.9
	oil	0.77 E15	6.6 E4	0.5
Imports				
19	Potash	1.05 E14	2.62 E6	2.8
20	Imported Oils	1.78 E17	5.3 E4	94.3
21	Phosphate, 1.209 E6 T	-	1.4 E16 /T	170.0
22	Bauxite, 2.59 E5 T	-	8.5 E14 /T	2.2
23	Iron and steel, 4.5 E5 T	-	16.0 E14 /T	7.6
24	Sugar	2.53 E15	8.4 E4	2.1
25	Services embodied in imports \$5.17 E9 imports	-	1.64 E12 /\$	84.7
Exports				
26	Wool, 2.85 E5 T	5.96 E15	3.84 E6	229.0
27	Meat, 6.6 E5 T	3.05 E15	1.71 E6	52.0
28	Butter, margarine, 2.42 E5 T			
29	Plantation timber	1.22 E16	6.72 E3	0.8
30	Aluminum, 1.2 E5 T	-	1.63 E16 /T	19.6
31	Iron ore, 3.5 E6 T	-	8.5 E14 /T	29.7
32	Services in exports \$5.15 E9	-	3.0 E12 /\$	154.0

Footnotes for Table 8.1

1. Direct Sunlight

$5.14 \text{ E9 J/m}^2/\text{y}$ (Lisle 1960); area of New Zealand, 2.69 E11 m^2 ; continental shelf area, 1.57 E11 m^2 (to 100 m depth); total area, 4.26 E11 m^2 ; albedo 20% over land.

Over land:

$$(0.8)(5.14 \text{ E9 J/m}^2/\text{y})(2.69 \text{ E11 m}^2) = 11.1 \text{ E20 J/y}$$

$$\text{Over shelf: } (5.14 \text{ E9 J/m}^2/\text{y})(1.97 \text{ E11 m}^2) = 10.1 \text{ E20 J/y}$$

$$\text{Total: } 21.2 \text{ E20 J/y}$$

2. Wind kinetic energy

Vertical diffusion coefficient used for Medford, Oregon (Swaney 1978), winter, $5.2 \text{ m}^2/\text{s}$; summer, $-.02 \text{ m}^2/\text{s}$; vertical gradient: winter, 3.4 E-3 m/s/m ; summer, $-.18 \text{ m/s/m}$. Height of wind, 1000 m; density, 1.23 kg/m^3 ; area, 2.69 E11 m^2 .
winter:

$$(0.5 \text{ y})(1000\text{m})(1.23 \text{ kg/m}^3)(5.2 \text{ m}^2/\text{s})(3.154 \text{ E7 s/y})$$

$$(3.14 \text{ E-3 m/s/m})^2(2.69 \text{ E11 m}^2) = 2.67 \text{ E20 J/y}$$

$$(0.5 \text{ y})(1000 \text{ m})(1.23 \text{ kg/m}^3)(0.02 \text{ m}^2/\text{s})(3.154 \text{ E7 s})$$

$$(.18 \text{ E-3 m/s/m})^2(2.69 \text{ E11 m}^2) = 3.4 \text{ E16 J/y}$$

3. Rain and snow, geopotential

Average elevation: 483 m; runoff: 1.42 m/y (Toebes 1972).

(Area land)(average elevation)(runoff)(density)(gravity)

$$(2.69 \text{ E11 m}^2)(483 \text{ m})(1.42 \text{ m/y})(1 \text{ E3 kg/m}^3)(9.8 \text{ m/s}^2)$$

$$= 18.1 \text{ E17 J/y}$$

4. Rain, chemical potential

Rainfall: average between 600 and 1500 mm/y (N.Z. 1981);
G is 4.94 J/g.

(area including shelf)(rainfall)(G)

$$(4.26 \text{ E11 m}^2)(1.050 \text{ m/y})(4.94 \text{ J/g})(1 \text{ E6 g/m}^3) = 2.21 \text{ E18 J/y}$$

Footnotes for Table 8.1 continued

5. Tides absorbed on continental shelf.

Shelf area: $1.57 \text{ E}11 \text{ m}^2$; average tidal height: 1.92 m.

$$\begin{aligned} & (\text{shelf area}) (0.5) (\text{tides/y}) (\text{ht. squared}) (\text{density}) (\text{gravity}) \\ & (1.57 \text{ E}11 \text{ m}^2) (0.5) (706 \text{ /y}) (1.92 \text{ m}) (1.92 \text{ m}) (1.025 \text{ E}3 \text{ kg/m}^3) \\ & (9.8 \text{ m/s}^2) = 0.41 \text{ E}18 \text{ J/y} \end{aligned}$$

Tides absorbed in estuaries

Area of estuaries: $0.39 \text{ E}11 \text{ m}^2$; 100% absorbed.

$$\begin{aligned} & (\text{estuary area}) (0.5) (\text{tides/y}) (\text{ht. squared}) (\text{density}) (\text{gravity}) \\ & (.39 \text{ E}11 \text{ m}^2) (0.5) (706 \text{ /y}) (1.92 \text{ m}) (1.92 \text{ m}) (1.025 \text{ E}3 \text{ kg/m}^3) \\ & (9.8 \text{ m/s}^2) = 5.1 \text{ E}17 \text{ J/y} \end{aligned}$$

Total tidal energy = $2.3 \text{ E}18 \text{ J/y}$

6. Waves

Forty % of the coast was used as beach absorbing 100%;
60% was taken as rock faces reflecting 1/2 of energy;
Mean power of waves in Taranaki Bight at Maui A oil drilling
platform, 25 kw/m (R.M. Kirk); facing shore line, $3.0 \text{ E}6 \text{ m}$

$$\begin{aligned} & (25 \text{ E}3 \text{ w/m}) (3.0 \text{ E}6 \text{ m}) (1 \text{ J/s/watt}) (3.154 \text{ E}7 \text{ s/y}) (0.5) \\ & = 1.18 \text{ E}18 \text{ J/y} \end{aligned}$$

7. Earth cycle, physical energy

$$\begin{aligned} & 1.5 \text{ mm/y (Adams 1978); heat flow assumed, } 4.0 \text{ E}6 \text{ J/m}^2\text{/y} \\ & (4.0 \text{ E}6 \text{ J/m}^2\text{/y}) (2.61 \text{ E}11 \text{ m}^2) = 1.04 \text{ E}18 \text{ J/y} \end{aligned}$$

8. Hydroelectricity

1981, New Zealand Yearbook 1980:

$$(18,691 \text{ E}9 \text{ watt hr/y}) (1 \text{ J/s/watt}) (3600 \text{ s/hr}) = 6.73 \text{ E}16 \text{ J/y}$$

Footnotes for Table 8.1 continued

9. Plantation wood

1981, New Zealand Yearbook 1980:

$(9372 \text{ E}3 \text{ m}^3/\text{y}) (0.5 \text{ E}6 \text{ g/m}^3) (3.6 \text{ kcal/g}) (4186 \text{ J/kcal})$

$= 7.06 \text{ E}16 \text{ J/y}$

10. Wool production

1981, New Zealand Yearbook 1980:

$(357 \text{ E}3 \text{ T/y}) (1 \text{ E}6 \text{ g/T}) (5 \text{ kcal/g}) (4186 \text{ J/kcal})$

$= 7.47 \text{ E}15 \text{ J/y}$

11. Meat production

1981, New Zealand Yearbook 1980:

$(6.615 \text{ E}5 \text{ T/y}) (0.22 \text{ protein}) (4 \text{ kcal/g}) (4186 \text{ J/kcal})$

$(1 \text{ E}6 \text{ g/T}) = 3.05 \text{ E}15 \text{ J/y}$

12. Net soil

See Appendix A18 and Table 2.1

Net loss of earth not calculated because rate of earth formation not known.

Net change of topsoil

Use rate from Pacific states of U.S. and cultivated acreage, $14.2 \text{ E}10 \text{ m}^2$; $6 \text{ E}10 \text{ m}^2$ in soil forming succession,

$(14.2 \text{ E}10 \text{ m}^2) (250 \text{ g/m}^2/\text{y}) - (6 \text{ E}10 \text{ m}^2) (1260 \text{ g/m}^2/\text{y}); 6 \text{ E}10 \text{ m}^2$

$= 4.1 \text{ E}12 \text{ g/y soil gain}$

13. Geothermal electricity

1981, New Zealand Yearbook 1980:

$(29 \text{ E}15 \text{ J/y heat}) (0.13 \text{ efficiency in practice})$

$= 3.77 \text{ E}15 \text{ J/y electricity.}$

Footnotes for Table 8.1 continued

14. Native wood use

$$(559 \text{ E3 m}^3/\text{y}) (0.8 \text{ E6 g/m}^3) (4.2 \text{ kcal/g}) (4186 \text{ J/kcal}) \\ = 7.86 \text{ E15 J/y}$$

15. Coal use

$$1981, \text{ New Zealand Yearbook } 1980: 55 \text{ E15 J/y}$$

16. Indigenous oil

$$1981, \text{ New Zealand Yearbook } 1980: 3.7 \text{ E16 J/y}$$

17. Natural gas

$$1981, \text{ New Zealand Yearbook } 1980: 3.7 \text{ E16 J/y}$$

18. Fuel generated electricity

$$1981, \text{ New Zealand Yearbook } 1980:$$

$$\text{coal: } (2.33 \text{ E5 T}) (1 \text{ E6 g/T}) (7 \text{ kcal/g}) (4186 \text{ J/kcal}) \\ = 6.83 \text{ E15 J/y}$$

$$\text{oil: } (1.75 \text{ E4 T}) (44 \text{ E6 J/kg}) (1 \text{ E3 kg/T}) \\ = 0.77 \text{ E15 J/y}$$

$$\text{gas: } 4.0 \text{ E15 J/y}$$

19. Potash

1981, New Zealand Yearbook 1980; 702 J/g KCl, see Footnote 8, Table A15.

$$(149 \text{ 752 T KCl}) (1 \text{ E6 g/T}) (702 \text{ J/g}) \\ = 1.05 \text{ E14 J/y}$$

20. Imported oil use

$$1981, \text{ New Zealand Yearbook } 1980: 178 \text{ E15 J/y}$$

Footnotes for Table 8.1 continued

21. Imported phosphate

1981, New Zealand Yearbook 1980: 1.209 E6 T/y; ETR, Appendix A6.

22. Imported bauxite use

1981, New Zealand Yearbook 1980: 2.59 E5 T/y; ETR Appendix A12

23. Imported iron and steel

1981, N.Z. Yearbook 1980: 4.5 E5 T/y; ETR, Appendix A13

24. Sugar import

1981, N.Z. Yearbook 1980: 1.51 E5 T/y; ETR, Appendix A17.

(1.51 E5 T/y) (1 E6 g/T) (4 kcal/g) (4186 J/kcal)

= 2.53 E15 J/y

25. Human services embodied in all imports

1981, N.Z. Yearbook 1980: \$5.17 E9 Imports; Energy dollar ratio for 1980 for U.S. from Appendix A4.

26. Wool export

1981, N.Z. Yearbook 1980:

(285 E3 T/y) (1 E6 g/T) (5 kcal/g) (4186 J/kcal)

= 5.96 E15 J/y

27. Meat export

1981, N.Z. Yearbook 1980: 6.6 E5 T/y; assume 22% protein

(6.62 E5 T/y) (1 E6 g/T) (0.22) (5 kcal/g) (4186 J/kcal)

= 3.05 E15 J/y

Footnotes for Table 8.1 continued

28. Butter, margarine

1981, N.Z. Yearbook 1980: $2.42 \text{ E}5 \text{ T /y}$ at $\$360 \text{ E}6 \text{ /y}$

29. Plantation wood

1981, N.Z. Yearbook 1980: $1.62 \text{ E}6 \text{ m}^3/\text{y}$ wood,
 $(1.62 \text{ E}6 \text{ m}^3/\text{y}) (1 \text{ E}6 \text{ cm}^3/\text{m}^3) (0.5 \text{ g/cm}^3) (3.6 \text{ kcal/g}) (4186 \text{ J/kcal})$
 $= 1.22 \text{ E}16 \text{ J/y}$

30. Aluminum ingot export

1981, N.Z. Yearbook 1980:
 $(1.20 \text{ E}5 \text{ T/y}) (1 \text{ E}6 \text{ g/T}) = 1.2 \text{ E}11 \text{ g/y}$

31. Iron ore export

1981, N.Z. Yearbook 1980:
 $3.5 \text{ E}6 \text{ T/y}$

32. Services in exports

1981, N.Z. Yearbook 1980: $\$5.15 \text{ E}9$ exports
Energy dollar ratio for New Zealand from Table 8.4

Table 8.2. Energy evaluation of resource reserves of New Zealand.

Foot-note	Type of energy	Actual Energy E18 J	Energy Trans.ratio SEJ/J or SEJ/g	Embodied Solar Energy E20 SEJ
1	Coal	57.	4.0 E4	22800.0
2	Natural gas	6.9	5.3 E4	3657.0
3	Native wood	82.6	3.23 E4	26680.0
4	Plantation wood	7.8	6.22 E3	485.0
5	Topsoil	142.0	2.5 E6	1,800,000.0
6	Iron sands, 856.0 E12 g	-	8.6 E8 /g	7361.0
7	Lignite	61.0	3.8 E4	23180.0
8	Geothermal heat			
	70 ⁰ -180 ⁰ C	47.0	6.1 E3	2867.0
	>180 ⁰ C	31.0	1.5 E4	4650.0

Footnotes for Table 8.2

1. Coal

57 E18 J recoverable (Ministry of Energy 1981)

2. Natural gas and oil condensate

Kapuni, 0.43 E18 J/ gas, 0.22 E18 J condensate;
 Maui, 5.5 E18 J gas, 0.78 E18 J condensate;
 McKee, 0.122 E18 J gas (Ministry of Energy 1981).

3. Native wood

1975 (Bray 1979), 23.5 E14 g carbon

(23.5 E14 gC) (2 g wood/gC) (4.2 kcal/g) (4186 J/kcal)

= 8.26 E19 J

Appropriate ETR is for unharvested wood Appendix A5.

Footnotes for Table 8.2 continued

4. Plantation wood

1975 biomass, $2.6 \text{ E}14 \text{ g carbon}$ (Bray 1979)

$(2.6 \text{ E}14 \text{ gc}) (2 \text{ g wood/gc}) (3.6 \text{ kcal/g}) (4186 \text{ J/kcal})$

= $7.8 \text{ E}18 \text{ J}$

Appropriate ETR is for unharvested wood (Appendix A10).

5. Top soil

soil carbon (Bray 1979) $31.3 \text{ E}14 \text{ g carbon}$

$(31.3 \text{ E}14 \text{ gc}) (2 \text{ g organic/gc}) (5.4 \text{ kcal/g}) (4186 \text{ J/kcal})$

= $1.42 \text{ E}20 \text{ J}$

6. Iron sands

1981, N.Z. Yearbook 1980: $852 \text{ E}6 \text{ T}$

7. Lignite, recoverable (Ministry of Energy 1981)

$(2.43 \text{ E}9 \text{ T}) (1 \text{ E}6 \text{ g/T}) (6 \text{ kcal/g}) (4186 \text{ J/kcal})$

= $6.1 \text{ E}19 \text{ J}$

Energy transformation ratio interpolated between wood and coal as $3.8 \text{ E}4 \text{ SEJ/J}$.

8. Geothermal heat

$31 \text{ E}18 \text{ J}$ above 180°C convertible to electricity

$47 \text{ E}18 \text{ J}$ between 70°C and 180°C

0.1 electrical J per thermal J above 180° (Ministry of Energy 1981); ETR used, 0.1 of $1.544 \text{ E}5$

STORED RESERVES

Stored reserves of various kinds are given in Table 8.2.

Natural gas from offshore wells and coal reserves are important. During periods when the snow fields and glaciers are

retreating as during recent years of this century, the ice melting is a small non-renewable input to hydroelectric system not yet evaluated. As in other areas of intensive agriculture, there are losses in reserves of stored soil. Erosion rate is faster than the steady state earth cycle rate. The net balance of earth (clays) was not evaluated, lacking data, but top soil was the most valuable resource. Evaluation in Table 8.1, Footnote 12, suggests that topsoil may be forming in areas of gorse, pinelands and other suressional areas faster than lost in farming. Soil loss was prevalent in earlier times of over-grazing, forest burning, etc. The work of the land in providing elevated catchment provides geopotential energy from the rains and snows, much of which is already harnessed in hydroelectric conversion. Part of the South Island hydroelectricity goes by undersea cables to the Auckland urban center of the north, and part operates a large aluminum ingot plant on the southern tip of the South Island.

The non-renewable uses at present are relatively small. Geothermal steam is non-renewable, since new bore holes must tap new rock areas as old ones are cooled. Addition of new geothermal use diverts hot springs already in use for local heating, cooking, and tourist attractions. Virgin forest cutting is small; most remaining areas are in demand for conservation, wildlife, aesthetics, tourists, watershed protection, etc.

The nation is highly developed with 85% of its population being urban. Generally the urban areas run on imported oils and imported iron and steel. Bauxite ore for the aluminum plant is imported from Australia. Especially in the South Island, the major use of phosphatic fertilizer from Christmas Island is the

basis of the pastures where excess of phosphate induces nitrogen fixation by clovers to complement plant needs. Although the price is not high, the embodied energy imported in phosphate is very large.

The traditional major export of wool and meat continues, and the export of wood and paper products increased. On a embodied energy basis, wool, aluminum and iron sands were large exports where dollar values may be misleading.

Table 8.3. Summary flows for New Zealand in Figure 8.3.

Letter in Figure	Item	Embodied Solar Energy E20 SEJ/y	Dollars E9 \$/y
R	Renewable sources used, SEJ/yr (rain, chem. plus tides)	438.	-
N	Non-renewable sources flow within the country (SEJ/yr):		
	N ₀ dispersed rural source (SEJ/yr)	87.0	-
	N ₁ Concentrated use (SEJ/yr)	40.0	-
	N ₂ Exported without use	42.0	-
F	Imported minerals & fuels (SEJ/yr)	221.0	-
G	Imported goods (SEJ/yr)	7.7 +	-
P ₂ I ₃	Imported service (SEJ/yr)	67.8	-
I	Dollars paid for imports (\$/y)	-	5.172
E	Dollars paid for exports (\$/yr)	-	5.152
P ₁ E ₃	Exported services (SEJ/yr)	119.0	-

Table 8.3. continued

Letter in Figure	Item	Embodied Solar Energy E20 SEJ/y	Dollars E9 \$/y
B	Exported products, transformed within the country (SEJ/yr) (wool, timber, aluminium)	250.0	-
X	Gross National Product (\$/yr)	-	26.0
P ₂	Ratio embodied energy to dollar of imports (SEJ/\$ US)	1.64 E12 SEJ/\$	-
P ₁	Ratio embodied energy to dollar of country & for its exports (SEJ/\$)	2.97 E12 SEJ/\$	

Footnotes for Table 8.3

R Highest global input the chemical contribution of rain plus tides (wind and rock uplift not used pending better data on rates).

N₀ Non-renewable cutting of podocarp forest, net soil

N₁ Urban use of New Zealand coal and gas

N₂ Export of fuel and iron sands

F Imported oil, phosphate, bauxite

G Imported goods: sugar, rubber, organic materials, iron and steel

P₂I₃ Import service, corrected by subtracting \$ for fuels and goods separately evaluated: oil, phosphate, bauxite

$$I_3 = (\$5.172 - 0.94 - 0.05 - 0.04) \text{ E9}$$

$$= \$4.14 \text{ E9 /g}$$

Footnotes to Table 8.3. continued

I & E New Zealand Yearbook 1981).

$P_1 E_3$ Subtract \$ already included for wool, timber, aluminum

$$E_3 = (\$5.152 - 0.93 - 0.053 - 0.151) = \$4.02 \text{ E9 /y}$$

$$(2.97 \text{ E12 SEJ/\$}) (\$4.02 \text{ E9 /y}) = 1.19 \text{ E22 SEJ/y}$$

B Wool, timber aluminum

X Gross domestic product, \$20.908 E9 plus imports,
5.172 E9 \$/y = \$26.0 E9

P_2 Appendix A4, 1.64 E12 SEJ/\$

$$P_1 = \frac{\text{Energy used}}{\text{GNP}} = \frac{R + N_0 + N_1 + F + G + (P_2 - G'/x) I_3}{X}$$

$$P_1 = \frac{(438 + 40 + 221 + 7.7) \text{ E20} + (1.64 \text{ E12}) (4.19 \text{ E9})}{26.0 \text{ E9 } \$/y}$$

$$= 2.97 \text{ E12 SEJ/\$}$$

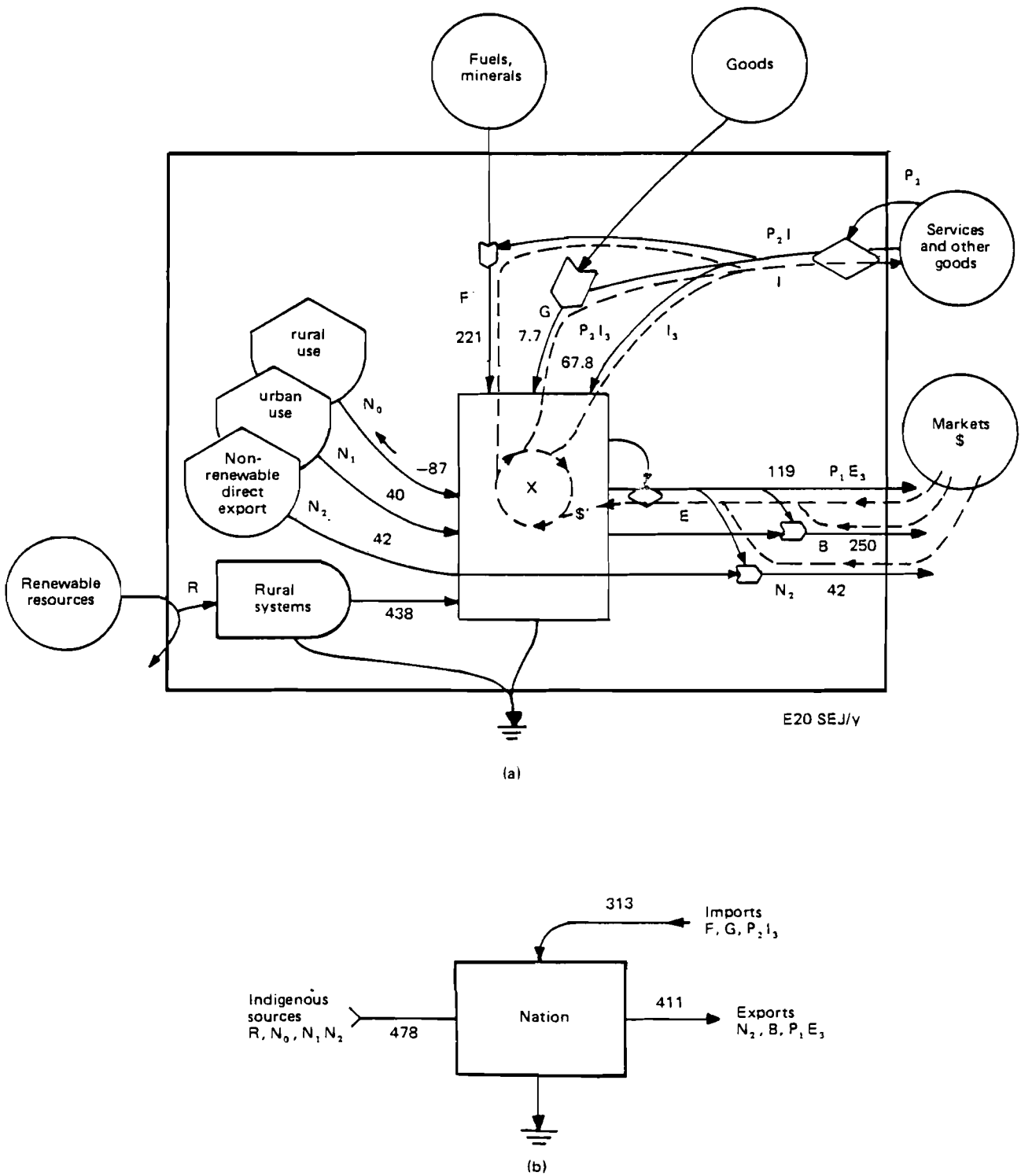

Figure 8.3. Summary diagram of the embodied energy flows of New Zealand. An evaluation table is given as Table 8.3. Indices from these values are calculated in Table 8.4. (a) Flows in Table 8.3; (b) further aggregation to form a three-arm diagram.

Table 8.4. Indices using embodied energy for overview of New Zealand.

Item	Name of index & expression, see Figure 8.3		
1	Renewable embodied energy flow	R	438. E20 SEJ/y
2	Flow from indigenous non-renewable reserves	N	70. E20 SEJ/y
3	Flow of imported embodied energy	F+G+P ₂ I	314. E20 SEJ/y
4	Total embodied energy inflows	R+N+F+G+P ₂ I	746. E20 SEJ/y
5	Total embodied energy used, U	U=N ₀ +N ₁ +R+F+G+P ₂ I	791. E20 SEJ/y
6	Total exported embodied energy	B+P ₁ E	1420. E20 SEJ/y
7	Fraction of embodied energy used derived from home sources	(N ₀ +N ₁ +R)/U	0.60
8	Exports minus imports	(N ₂ +B+P ₁ E) - (F+G+P ₂ I)	98. E20 SEJ/g
9	Ratio of exports to imports	(N ₂ +B+P ₁ E)/(F+G+P ₂ I)	1.31
10	Fraction used, locally renewable	R/U	0.55
11	Fraction of use purchased	(F+G+P ₂ I)/U	0.4
12	Fraction used that is imported service	P ₂ I/U	0.09
13	Fraction of use that is free	(R+N ₀)/U	0.54
14	Ratio of concentrated to rural	(F+G+P ₂ I+N ₁)/(R+N ₀)	0.81
15	Use per unit area (2.69 E11 m ²)	U/(area)	2.94 E11 SEJ/m ² /y
16	Use per capita (3.1 E6 pop.)	U/population	2.55 E16 SEJ/cap/y
17	Renewable carrying capacity at present living standard	(R/U) (population)	1.71 E6 people
18	Developed carrying capacity at same living standard	8(R/U) (population)	13.6 E6 people
19	Fuel fraction	F/U	0.17

Energy Density

Per unit area, the total embodied energy in New Zealand is large because many of the environmental energies are greater than in other areas, (2.94 E11 SEJ/m²/y). Although the human economy is well developed in use of fuels for urban life and industries, the spatial concentration of these assets is small compared to Japan and Germany.

Energy per Capita

With a population of 3.1 million people over a large land area, the population density is 11.5 persons per km². The environmental energy per person is very large and when combined with the fuel allocation per person, a rich level of embodied energy per person results, 2.55 E16 SEJ/person.

Self Sufficiency

A self sufficiency index is the fraction of the embodied energy which is indigenous, which is 60% for New Zealand. When self sufficiency is estimated from money only, the fraction of the gross national product, which is internal (GDP), is 80.4%. The New Zealand standard of living is much more dependent on imported oil and phosphate than recognized by economic data.

However, the economy is maximized by encouraging the most use of outside fuels so long as a favorable ratio of embodied energy results from the trade. Fluctuations in fuel and phosphate costs are the principal short range factor affecting the economy.

Development Stage

Highly developed countries utilize free indigenous sources to attract economic activities that match high quality fuels, goods, and services to the environmental resources with which they interact in productive transformation. Economic development may be indicated by the fraction of energy use which is purchased, 44% for New Zealand. A related index is the ratio of concentrated energies to rural base resource, 0.77 for New Zealand. These ratios are much higher than underdeveloped countries, but not as high as the most industrialized. In other words, New Zealand has considerable rural and free resources for further economic development. Very high is the ratio of electrical energy use to total use $(113 \text{ E}20 \text{ J/y}) / (791 \text{ E}20 \text{ J/y}) = 0.14$.

Overall Ratio of Embodied Energy to Dollar Flow

The total embodied energy in use within the country may be divided by the total gross national product expressed in the contemporary U.S. dollar equivalents (Table 8.4). The resulting embodied energy to dollar ratio, is an index of the amount of resources driving the circulating money. Conversely, the ratio indicates how much real work a dollar was buying. The ratio for New Zealand, $3 \text{ E}12 \text{ SEJ} / 1980 \text{ \$}$, is high. As a predictor and indicator of buying power, the energy/dollar ratio is like a consumer price index. The energy-dollar ratio measures what is contributed when services are purchased. Countries with a high ratio like New Zealand are contributing more

services per dollar in trade. Prices are less, and dollars buy more services.

Foreign Trade

When foreign trade and other money exchanges are examined in dollars, there is nearly a balance, but money does not indicate the ultimate contribution of raw products to an economy's buying power. The energy dollar ratio provides a quick shorthand way to evaluate relative advantage of foreign trade based on dollar values. The country with the higher energy dollar ratio gives more ultimate economic value to its trading partner than it receives. For example, New Zealand with a high energy dollar ratio gets less from buying foreign fuel than the United States, because it gives more in exchange.

When foreign trade is examined in the aggregate in Figure 8.3, New Zealand is found to export more embodied energy than it receives. Its policy in recent years to accentuate export of raw products (such as timber, meat, wool, coal, etc.) causes foreign trade to decrease its own economic vitality, the opposite effect intended. The situation would be even more to the disadvantage of the local economy if it were not receiving a large embodied energy in its phosphate and fuels energies imports.

A better policy from local point of view is to eliminate export commodities (wool, meat, wood, aluminum, iron ore, coal) and let the end uses of these products develop in the local economy providing jobs there. This may be understood by realizing that elimination of exports would cause prices to fall locally

making industries using these products to prosper at home attracting outside investments and ultimately exporting high quality finished products with much higher embodied energy return.

Alternatively, equivalent embodied energy in non-monied service might be negotiated from trading partners so that aid is received in categories of defense, cultural exchange, information, etc.

Carrying Capacity

The capacity of a country to support people may be estimated from embodied energy flows in various contingencies (Table 8.2). First is the carrying capacity if only the renewable energies were available as may eventually be the situation. For New Zealand retaining the current energy per person, this is 1.7 million people, 54% of the present. If the matching fuels and other intensive energies could be increased to the ratio found in the most developed nations with a ratio of 8 times the renewable base, a population for New Zealand would be 13.9 million people.

Land Use

As indicated in Figure 8.1, the heavy emphasis in land use is on cash crop exports in sheep meat, wool, exotic plantation timber, and aluminum produced from dammed valleys generating hydroelectric power. Since this policy has the reverse effect on the economy intended, diversification to provide more variety

of products for a more balanced self-sufficient economy can ultimately generate more home use of embodied energy and gain more in exchange.

Large areas of little-used lands in gorse thorn scrub result from sheep roaming and eliminating native tree seedlings. Areas without trees for reseeded are so broad that the natural rapid regeneration of high quality forests and soils when left fallow is not proceeding. Protecting lands so that natural revegetation can occur has the highest of all net energy yields of all resources. New Zealand needs a crash program to restore the gene pools in every square kilometer of such lands to facilitate the work of nature in regenerating high value. The preliminary calculation of soil balance in Table 8.1 already recognizes a net gain from such lands.

Trends

The various indices of embodied energy suggest that some economic growth and concurrent population growth may occur without loss of standard of living, especially as recent export policies are discarded, as some of the land uses are changed, and manufacture of more finished products develops. Restoring electric trains instead of trying to trade aluminum ingots for motor fuels is far better energetics. If the world outside passes its crest of total economic assets and growth in the next decade or so, New Zealand will then be in a strong position to be a regional economic center of the south seas, using its sail boats and sea fisheries more at home, with less contracting of its economy than most of the highly developed countries.

In our previous paper (Odum and Odum 1979) we included a simulation computer model which showed a sustained economy by reducing foreign trade of raw products, with a gradual economic decrease in the next century especially after phosphate fertilizer may become in short supply and imported at high cost.

Our energy analysis reported first in 1977 and improved here, seems to be more realistic in defining basis for growth than other statements of trend not based on energy which predicted growth (Jansen 1977; Ministry of Energy 1978, 1981).

J.P. Sendzimir, W. Dunn, and H.T. Odum
*Center for Wetlands and Environmental
Engineering and Sciences
University of Florida, Gainesville*

9. ENERGY ANALYSIS OVERVIEW OF DOMINICA*

Introduction

The System of Dominica

Dominica is the largest of the Windward Islands in the Lesser Antilles of the Carribean and has a land area of approximately 790 square kilometers (see Figure 9.1). Being the product of the fusion of three volcanoes, Dominica is the most mountainous island of the Lesser Antilles. The overwhelming influence of runoff and landslides of the mountainous interior dominates the narrow band of gentle slopes which gird the island's perimeter. The largest peak of the interior highlands is Morne Diablotin (1440 m). Rainfall is high in relation to other islands in the Carribean and most environments on earth, ranging from 2030 mm/year at the seaside capitol of Roseau to over 9000 mm/year in the cloud forests at the mountain summits. The mountains' blocking of the trade winds carrying moist tropical air causes a large runoff of high quality rainwater with great chemical potential energies which support the work of weathering and forest growth.

* Work initiated in Energy Analysis Courses at the University of Florida, supported by a project with T.A. Robertson for the Agency for International Development, and completed at the International Institute for Applied Systems Analysis, Laxenburg, Austria.

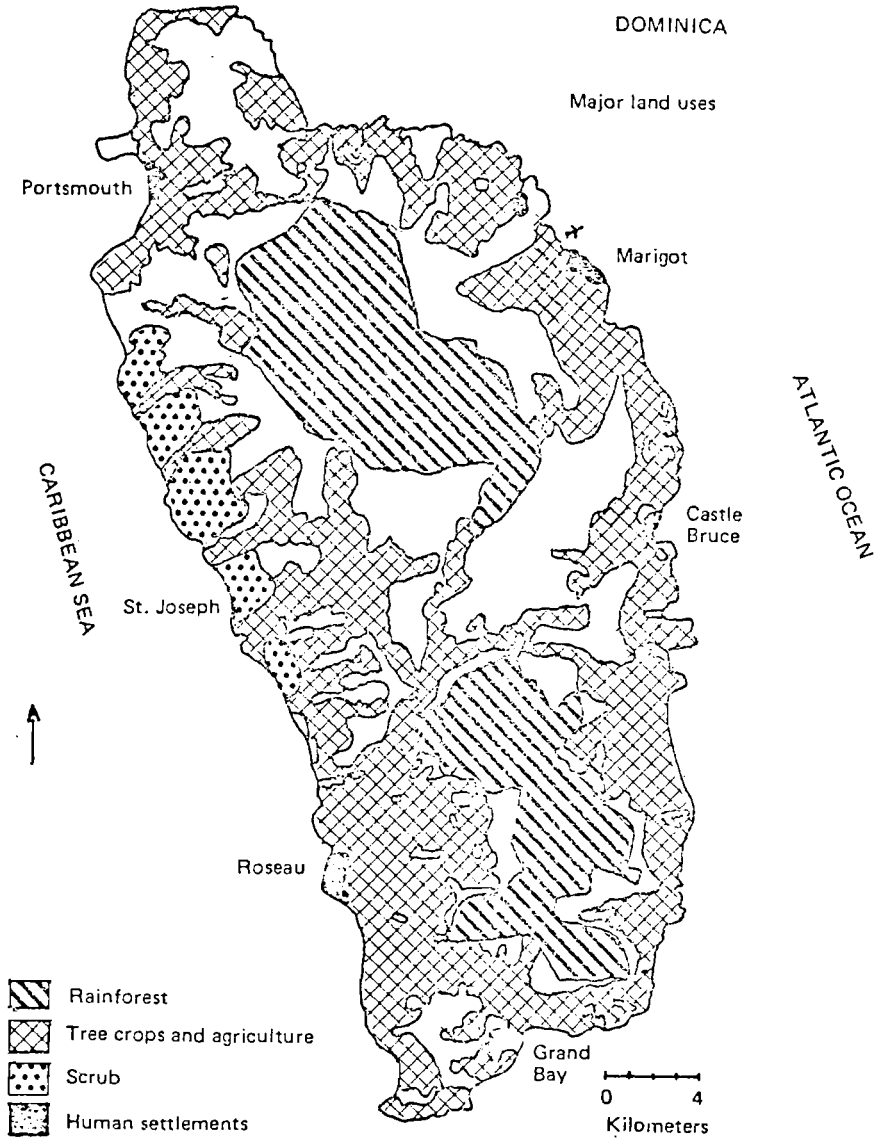

Figure 9.1. Land use map of Dominica adapted from United Nations (1975).

The dissipation of gravitational potential energy as rain-water flows down from the summits, serves to shape the landscape. However, much of this energy currently washes straight into the sea without being harnessed economically, such as for hydropower. The interaction of high rainfall and volcanic soils has produced cloud forests on the peaks and rain forests on the upper slopes (see Figure 9.2). Inaccessibility from markets and rugged topography have daunted many attempts to replace these forests with intensive agriculture. Most people have been supported with shifting cultivation in small plots utilizing rain forest soils and wood for short periods. The virgin rain forest has diminished from roughly two-thirds of the island's area to 1/3 at present.

Dominica is rich in other environmental input with high embodied energies, including sun, wind, waves, tides, rapid geologic uplift and thermal input from volcanic activity. The energies of severe hurricanes pulse through the system on an irregular basis; several having swept the island in the late 1970's and early 1980's. The immediate effects of winds, floods and high tides are destructive to housing, roads and docks, but the long term effects of such storms may be to increase weathering, accelerate geological cycles and pulse natural ecosystems.

Except under the cloud cover of the summits, tropical solar input is relatively high in Dominica by world standards. The trade winds from the east and south-east with a long, uninterrupted length of fetch over the Atlantic Ocean, drive waves onto Dominica's eastern shore. The rocky shores of Dominica reflect a sizable portion of the wave energy back into the sea. The

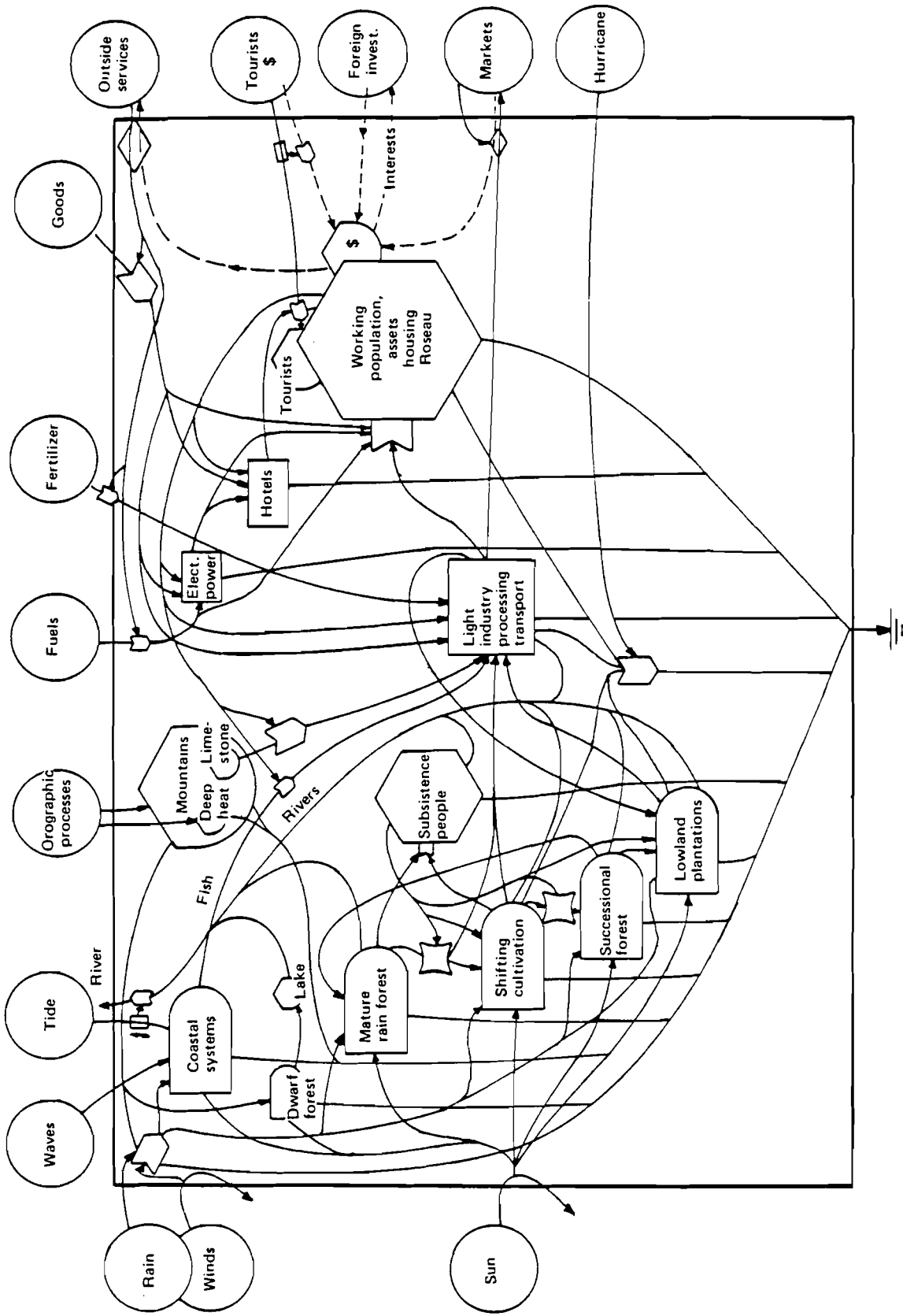

Figure 9.2. Energy diagram of the main compounds and processes of Dominica, West Indies.

trade winds also bring moisture which condenses into rain at the cooler elevations and further moderates the climate by dispersing heat. The steepness of Dominica's marine slopes allows little area on its oceanic shelves for the work of tidal energies.

Persistent hot springs from volcanic activity might support geothermal power generation.

Human Processes in Dominica

Human activity within the system of Dominica centers on agriculture, primarily banana and coconut plantations and cropping and modest development of light industry, such as processing oils and juice manufacture. More than 75% of Dominica's 100,000 agricultural acres consists of low-energy farms less than 10 acres in size. Fishing exists on a small scale, but is important as a local source of protein. Requirements for domestic power and light industry have been supplied by small-scale hydroelectric power generation facilities.

A small tourist trade is an important source of foreign exchange. The ruggedness of the terrain has made development of tourism infrastructure (airport, roads and protected harbor) quite difficult to establish and maintain. The lack of transportation facilities and sunny sites for hotels has certainly kept the flow of visitors to a low level. The airport is on the side of the mountains opposite from the main town and the sunnier beaches. The exceptional resource of beautiful, virgin rain forest has not yet caught the imagination of the international tourist as much as sunny beaches on other islands with less rain.

Dominica's interaction with the world is limited. The oscillating development of boom-and-bust, one crop agricultures with fluctuating prices, over the decades has never established long lasting trade relations in any one area.

In this chapter, overview perspectives are generated by energy analysis of main environmental and economic flows of the island system. The procedures and methods outlined in Sections 1-5 were used.

Results

The complex energy relationships in the system of Dominica are shown in Figure 9.2, an energy diagram including significant outside energy sources, storages and energy uses in the land and industries and the predominantly human systems of Dominica. Energy flows are listed in Table 9.1, and energy storages are listed in Table 9.2.

In Table 9.1, tropical solar direct radiation is high by world standards, but is dwarfed by the more indirect solar equivalents in inputs of rain and waves. In particular, the chemical potential of pure rain water was approximately 31 times the embodied energy of direct sunlight.

The energy flow of rock uplift was of similar magnitude owing to the high degree of geological activity in this orographic region. The entire arc of the Lesser Antilles archipelago overlies the subduction zone where the Atlantic Plate dives westward under the Carribean basin.

Since rainwater's purity is the largest of the inputs from the solar driven biosphere, it was used to represent natural flows. It includes all other environmental flows, which are by-products.

Much of the geopotential energy of rain runs off in streams concentrated further by the island mountain topography.

Table 9.2. lists the important energy storages of Dominica.

Table 9.1. Energy flows in Dominica in 1979.

Foot-note	Types of Energy	Actual Energy J/y	Energy Trans. Ratio SEJ/J	Embodied solar energy E18 SEJ/y
1.	Direct Sunlight	5.65 E18	1	5.6
2.	Wind	1.33 E16	1268	16.9
3.	Rain-chem. pot.	1.13 E16	15,444	175.0
4.	Rain-geopotential	8.33 E15	8888	74.0
5.	Waves	1.82 E15	25,889	47.0
6.	Earth Cycle	3.75 E15	2.98 E4	111.0
7.	Bananas	4.25 E13	4.54 E5	19.0
8.	Coconuts & products	1.34 E14	2.09 E5	63.0
9.	Fruits & Veg. Juice	-	-	6.4
10.	Internal use of rainforest	-	-	371.0
11.	Imported services	(39.6 E6 US\$)	(2.37 E12 SEJ/US\$)	93.9
12.	Fuels imported			
	Liquid motor fuels	2.52 E14	6.6 E4	16.6
13.	Electricity	5.42 E10	15.9 E4	0.0009
14.	Tourism (3.16 E6 US\$)	-	2.37 E12/US\$	7.4
15.	Single Hurricane	2.28 E15	4.08 E4	92.0
16.	Hurricanes	2.28 E14	4.08 E4	9.2
*	Others	-	-	-

*Tides and fertilizer use were calculated and found negligible compared to other items. Preliminary calculations showed the embodied energy of imported goods was less than 9% of imported services.

Footnotes for Table 9.1.

1. Direct sunlight

Sunlight: $1.8 \text{ E}6 \text{ kcal/m}^2/\text{y}$ (Sellers, 1965) = $7.53 \text{ E}9 \text{ J/m}^2/\text{y}$.
Dominica's area: 289.5 miles square (World Bank 1981)
= $7.5 \text{ E}8 \text{ m}^2$. Continental shelf: marine slopes descend so steeply that very little shelf area exists. Marine maps showed 600 foot depths routinely within 400 yards of shore.

(Total area) (Average insolation)

$$(7.5 \text{ E}8 \text{ m}^2) (7.53 \text{ E}9 \text{ J/m}^2/\text{y}) = 5.65 \text{ E}18 \text{ J/y}$$

2. Wind

Eddy diffusion: $4.5 \text{ m}^3/\text{m}^2/\text{sec}$; vertical gradient:
 $3.2 \text{ E}-3 \text{ m/s/m}$ (Newell 1972).

$$(1 \text{ m}^2) (1000 \text{ m}) (1.23 \text{ kg/m}^3) (4.5 \text{ m}^3/\text{m}^2/\text{sec}) (3.14 \text{ E}7 \text{ sec/y})$$

$$(3.2 \text{ E}-3 \text{ m/s/m})^2 (7.5 \text{ E}8 \text{ m}^2) = 1.33 \text{ E}15 \text{ J/y}$$

3. Rain - Chemical potential

Precipitation: 3050 mm/y (United Nations 1975).
(area) (average rainfall) (Gibbs free energy) (conversion factor)

$$(7.5 \text{ E}8 \text{ m}^2) (3.05 \text{ m}) (4.94 \text{ J/g}) (1 \text{ E}6 \text{ g water/m}^3) = 1.13 \text{ E}6 \text{ J/y}$$

4. Rain - Geopotential

Average elevation: 609 m (derived from averaging the elevational areas of a topographical map of Dominica).
Runoff: 1.86 m (since the average evapotranspiration figure for Puerto Rican rainforest is 39% (Odum and Pigeon 1970), then the runoff is 61% or $(0.61) (3.05 \text{ m/y}) = 1.86 \text{ m/y}$.
(area) (ave. elevation) (runoff) (density of water) (gravity)

$$(7.5 \text{ E}8 \text{ m}^2) (609 \text{ m}) (1.86 \text{ m/y}) (1 \text{ E}3 \text{ kg/m}^3) (9.8 \text{ m/s}^2) =$$

$$= 8.33 \text{ E}15 \text{ J/y}$$

5. Waves

Wave velocity derived by multiplying (gravity) (depth at measurement point) and taking the square root of the product:
 $(9.8 \text{ m/s}^2) (4 \text{ m}) = \text{sq. rt. } (39.2 \text{ m}^2/\text{s}^2) = 6.26 \text{ m/s}$. Wave height: 4 feet = 1.22 m (Table 19 of Synoptic Meteorological Observations, U.S. Naval Weather Service Command Straight shoreline length: $4.84 \text{ E}4 \text{ m}$, taken from a line drawn on a map of Dominica perpendicular to prevailing trade winds which

Footnotes for Table 9.1. continued

generate waves.

(straight shoreline length) (1/8) (density) (gravity) (ht)²
(velocity)

$4.84 \text{ E}4 \text{ m} (1/8) (1.025 \text{ E}3 \text{ g/m}^2) (9.8 \text{ m/s}^2) (1.22 \text{ m})^2 (6.26 \text{ m/s})$
 $(3.15 \text{ E}7 \text{ s/y}) = 1.82 \text{ E}15 \text{ J/y}$

6. Earth cycle

(heat flow in an active orographic area) (area)

$= (5 \text{ E}6 \text{ J/m}^2/\text{y}) (7.5 \text{ E}8 \text{ m}^2) = 3.75 \text{ E}9 \text{ J/y}$

7,8. Bananas, coconuts, coconut oil and derivative products.
See subsystems analysis, Tables 9.5. and 9.6., Figures 9.4.
and 9.5.

9. Fruits, vegetables and juices

Total acreage for fruit and vegetable cultivation: 3,400
acres (United Nations 1975). Natural energy/acre: 9.44
E14 SEJ/acre (Footnote 3, Table 9.1.);
Fossil fuel/hectare: 4.97 GJ/ha (Slesser 1978, Table 8.1)

$(3400 \text{ acres}) (9.44 \text{ E}14 \text{ SEJ/acre/y}) = 3.2 \text{ E}18 \text{ SEJ/y}$

$(1.14 \text{ E}6 \text{ US\$}) (2.37 \text{ E}12 \text{ SEJ/US\$}) = 2.7 \text{ E}18 \text{ SEJ/y}$

$(1,376.5 \text{ ha}) (4.97 \text{ GJ/ha}) (6.6 \text{ E}4 \text{ SEJ/J}) = 4.52 \text{ E}17 \text{ SEJ/y}$

Total embodied energy = 6.36 E18 J/y

10. Internal use of rainforest

See Footnote 3, Table 9.3.

11. Imported Services

Total import dollars in 1979: 39.4 \$ E6 US\$ (World Bank
1981a).

$(39.6 \text{ E}6 \text{ US\$}) (2.37 \text{ E}12 \text{ SEJ/US\$}) = 9.33 \text{ E}19 \text{ SEJ/y}$

Footnotes for Table 9.1. continued

12. Fuels imported

Total volumes of gasoline, kerosene, diesel and fuel oils imported in 1979 are 1,197 E3 gal., 61 E3 gal., 432 E3 gal. and 79 E3 gallons respectively. (World Bank 1981). Actual calorie conversion factors, from (Odum et al. 1983) are 36,225 kcal/gal., 34,030 kcal/gal., 34,030 kcal/gal. and 37,431 kcal/gal.

Actual energy calculations:

gasoline	(1,197 E3 gal)	(36,225 kcal/gal)	= 4.34 E10 kcal
kerosene	(61 E3 gal)	(34,030 kcal/gal)	= 2.09 E9 kcal
diesel	(432 E3 gal)	(34,030 kcal/gal)	= 1.47 E10 kcal
fuel oils	(79 E3 gal)	(37,431 kcal/gal)	= 2.99 E9 kcal

Total actual energies:

liquid motor oils = 6.02 E10 kcal) (4186 J/kcal) = 2.52 E14 J/y
 fuel oils = 2.99 E9 kcal) (4186 J/kcal) = 1.25 E13 J/y

13. Electricity

Average electricity generation from 1978 to 1979:
15,048 KWH (World Bank 1981)

(15,048 KWH/y) (3.6 E5 J/KWH) = 5.42 E10 J/y

14. Tourism

Total tourism income: 3.18 E6 US \$/y (World Bank 1981a).
Energy/\$ ratio from the U.S.A. representing tourist origins.

(3.18 E6 US\$) (2.37 E12 SEJ/US\$) = 7.35 E18 SEJ/y

15. Hurricane

Energy per hurricane, 4.85 E5 kcal/m²/day (Hughes 1952).
3% kinetic energy; 10% energy dispersed to the surface,
see Appendix A14. Passage time, 0.5 days.

(Energy per unit area) (hours exposed) (area)

(4.85 E5 kcal/m²day) (0.03) (0.10) (0.5 day) (7.5 E8 m²)

(4186 J/kcal) = 2.28 E15 J/hurricane passage

16. Hurricane per year

Values taken from footnote 15 divided by the interval
between hurricanes, 10 years.

Footnotes for Table 9.1. continued

$$\frac{(2.28 \text{ E15 J/hurricane})}{(10 \text{ years})} = 2.28 \text{ E14 J/y}$$

Table 9.2. Embodied energy in storages in Dominica in 1979.

Foot- note	Type of energy	Actual energy J	Energy transformation ratio SEJ/J	Embodied solar energy E19 SEJ
1	Old rainforest	9.83 E16	3.49 E4	343.0
2	Secondary forest	5.23 E15	1.9 E4	9.9
3	Cropland	3.49 E16	1.9 E4	66.0
4	Soil	3.4 E17	6.26 E4	2129.0
5	Limestone	6.9 E14	2.29 E8	15824.0

Footnotes to Table 9.2.

1. Old tropical rainforest

Area, rainforest reserve plus national parks: 43,000 acres = 1.74 E8 m² (United Nations 1975). Organic matter density: 332 T/ha, living biomass in vegetation, plus 7.6 T/ha, litter (Brown and Lugo, Biotropica, Vol. 14, No. 3, p. 172). Forest organic matter combustion value: 4.1 kcal/g (Odum et al. 1983, p. E10).

$$(329.6 \text{ T/ha}) (1 \text{ E6 g/T}) (\text{ha}/1 \text{ E4 m}^2) (4.1 \text{ kcal/g}) (1.74 \text{ E8 m}^2) \\ (4186 \text{ J/kcal}) = 9.83 \text{ E16 J}$$

2. Secondary forest

Storages of organic matter (above and below ground biomass plus litter) not including soil. Area of secondary forest (regrowth of cut rainforest): 33,700 acres = 1.36 E8 m² (United Nations 1975, p. 36). Dominica's secondary forest assumed to be quite similar to a Cadam tree plantation in Puerto Rico (Odum and Pigeon 1970). Density and organic matter storage calculations were taken from the aforesaid plantation data as follows:

Ten tree crown diameters were averaged and the resultant average was halved to obtain the average radius. Multipli-
cation by pi gave the average circular area under a tree

Footnotes for Table 9.2. continued

crown. Organic matter stored per tree: 30,718 g (Odum and Pigeon 1970).

Average diameter = 13.9 ft = 4.24 m; average radius,
= 2.12 m

Tree crown area = $(2.12 \text{ m})^2 (3.1416) = 14.1 \text{ m}^2$

Organic matter stored in secondary forest

$(30,718 \text{ g dry weight}/14.1 \text{ m}^2) (4.2 \text{ kcal/g}) (1.36 \text{ E}8 \text{ m}^2)$
 $(4186 \text{ J/kcal}) = 5.23 \text{ E}15 \text{ J}$

3. Cropland

Tree crop areas, including uncultivated areas and pockets on steep slopes: 26,000 acres and 62,180 acres respectively (United Nations 1975, p. 45). Assuming that the uncultivated crop area has a biomass approximately half way between the mean and highest value of cultivated land, 7000 g/m^2 (Whittaker 1975) and that cultivated tree crop land has a biomass value at the bottom of the same-range, 2178.6 g/m^2 . Actual energy calculations for both types are:

Uncultivated crop area:

$(62180 \text{ acres}) (4046.8 \text{ m}^2/\text{acre}) (7000 \text{ g/m}^2) (4.2 \text{ kcal/g})$
 $(4186 \text{ J/kcal}) = 3.1 \text{ E}16 \text{ J}$

Cultivated tree crop area:

$(26,000 \text{ acres}) (4046.8 \text{ m}^2/\text{acre}) (2179 \text{ g/m}^2) (4.2 \text{ kcal/g})$
 $(4186 \text{ J/kcal}) = 4.03 \text{ E}15 \text{ J}$

Total actual energy for both types: = $3.49 \text{ E}16 \text{ J}$

4. Soil

High quality organic soils are confined to the virgin forest, see Footnote 1, Table 9.2. for area: $1.74 \text{ E}8 \text{ m}^2$. Red-yellow clay loam was used as a representative soil because it's the closest approximation of Lesser Antilles soil types (Mason 1922; Shillingford 1972). Soil organic matter: 350 T/y (Brown and Lugo, Biotropica, Vol. 14, No. 8)

$(350 \text{ T/ha}) (1.74 \text{ E}8 \text{ m}^2) (1\text{ha}/4046.8 \text{ m}^2) (2.26 \text{ E}4 \text{ J/g}) (1 \text{ E}6 \text{ g/T})$
= $3.4 \text{ E}17 \text{ J}$

Footnotes for Table 9.2. continued

5. Limestone in old reefs and sea deposits (chemical potential)

Total volume of deposit: $5.0 \text{ E6 yd}^3 = 3.82 \text{ E6 m}^3$ (United Nations 1975, p. 83). Actual energy per weight: 611 J/g (See Table 2.1.). Density: 1.9 E6 g/m^3 .

(Volume) (Density) (Actual energy/weight)

$$(3.82 \text{ E6 m}^3)(1.9 \text{ E6 g/m}^3)(611 \text{ J/g}) = 4.43 \text{ E15 J}$$

Limestone deposits represent many years of marine reef activity storing calcium carbonate. Energy storages involved in human activity such as secondary forest and cropland, are almost insignificant compared to natural storages, being several orders of magnitude smaller than those of soils or rainforests.

The increasing size and importance of storages as a function of the time required for building them is evident in Table 9.2. Human dominated subsystems, such as cropland or secondary forest, store far less energy than the rainforest since the latter has taken at least 500 to 1,000 years to build its structure of energy dense trees and soils. Biomass found in secondary forest has not concentrated much energy or grain structure in 10 to 30 years to have much value for combustion or furniture.

Aggregated overview

Further aggregating, Table 9.3. summarizes the flows that drive the economy directly and indirectly. These flows are also drawn in Figure 9.2. The main sources of work to the island's economy directly and indirectly are: water, imported fuels, imported goods and services and the drain of stored biomass in rainforests and soils.

Table 9.3. Summary flows for Dominica in Figure 9.3.

Letter in Figure	Item	Embodied solar energy E19 SEJ/y	Dollars E6 \$/y
R	Renewable sources used, SEJ/yr (rain, chem.)	17.5	-
N	Nonrenewable sources flow within the country (SEJ/yr):		-
	- N ₀ dispersed rural source (SEJ/yr)	37.1	-
	- N ₁ concentrated use (SEJ/yr)	-	-
	- N ₂ exported without use	-	-
F	Imported minerals and fuels (SEJ/yr)	1.66	-
G	Imported goods (SEJ/yr)	-	-
P ₂ I	Imported service (SEJ/yr)	9.34	-
I	Dollars paid for imports (\$/yr)	-	39.6
E	Dollars paid for exports (\$/yr)	-	9.4
P ₁ E	Exported services (SEJ/yr)	3.95	-
B	Exported products, transformed within the country (SEJ/yr)	9.14	-
X	Gross National Product (\$/yr)	-	75.4
P ₂	Ratio embodied energy to dollar of imports (SEJ/\$) (US)	2.37 E12 SEJ/US\$	-
P ₁	Ratio embodied energy to dollar of country and for its exports (SEJ/\$)	8.7 E12 SEJ/US\$	-

Footnotes for Table 9.3.

R Chemical potential energy of rain is the largest renewable energy source (Footnote 3, Table 9.1): 1.75 E20 SEJ/y.

N₀ Reduction of virgin forest in Dominica from 67% to 38% in 20 years (United Nations 1975) corresponds to a 1.5% loss/y. Since regrowth of such high quality wood and soil biomass requires more than 150 years, they are nonrenewable resources within the time frame of the present economy.

Footnotes for Table 9.3. continued

Rural use of nonrenewable wood and soil, calculations:

(annual use %) (total embodied energy of virgin rain forest)

$(0.015)(343 \text{ E19 SEJ}) = 5.15 \text{ E19 SEJ/y}$

(annual use %) (total embodied energy of virgin rainforest soils)

$(0.015/y)(2129 \text{ E19 SEJ}) = 3.19 \text{ E20 SEJ/y}$

Total use of indigenous nonrenewable energy sources

$= 3.71 \text{ E20 SEJ/y}$

N₁ There was little concentrated energy use.

N₂ Only 2% of the estimated 251 E6 board feet of virgin timber has been exported as lumber (United Nations, 1975), and the operations as of 1979 were negligible. Limestone deposits of 5 E6 cubic yards were similarly unexploited. Therefore, N₂, nonrenewable resource exports without internal use, were negligible.

F Total imported fuel embodied energies (Footnote 12, Table 9.1): 1.66 E19 SEJ/y .

G Imported goods, according to preliminary calculations were only 8.5% of the embodied energy of imported services and thus were negligible.

P₂E Imported services: 9.1 E19 SEJ/y (Footnote 11, Table 9.1).

I Dollars for imports: $34.6 \text{ E6 US\$}$ (World Bank 1981a).

E Dollars from exports: $9.4 \text{ E6 US\$}$ (World Bank 1981a).

P₁E Exported services (P₁E):

$(4.20 \text{ E12 SEJ/US \$})(9.4 \text{ E6 US\$}) = 3.95 \text{ E19 SEJ/y}$

B Exported products: 9.14 E19 SEJ/y (see Footnotes 7-9, Table 9.1).

Footnotes for Table 9.3. continued

X Gross National Product (X): 75.4 E6 US\$. This is the sum of the gross domestic product (GDP): 45.4 E6 US\$ (United Nations 1975) plus export: 9.4 E6 US\$ (World Bank 1981) plus foreign aid: 12.6 E6 US\$ (World Bank 1981, p. 157) plus financing: 7.9 E6 US\$ (World Bank 1981, p. 11).

P₂ Ratio of the United States annual embodied energy flow to import dollars (P₂): 2.37 E12 SEJ/US\$/y.

P₁ Ratio of Dominica's embodied energy flow to dollars of GNP:

$$P_1 = \text{Energy used/GNP} = \frac{R + N_0 + N_1 + F + G + P_2 I}{75.4 \text{ E6 US dollars}} =$$

$$= 8.7 \text{ E12 SEJ/US\$}$$

Energy-Dollar ratio

The total energy used (Figure 9.3) was divided by the gross national product (GNP) in US dollars to obtain an energy/dollar ratio (P₁).

The Gross National Product (GNP) was estimated as the sum of the Gross Domestic Product (GDP) plus the money flows of exports, investments and foreign aid. The latter, foreign aid, was notably higher than normal in 1979 owing to special disaster relief for hurricane damage. Dominica's energy/dollar ratio is almost four times that of the U.S.A. Use of embodied energy storages of rainforest and soil was the large energy value generated by the work of subsistence farmers which was not recognized by dollar circulation figures.

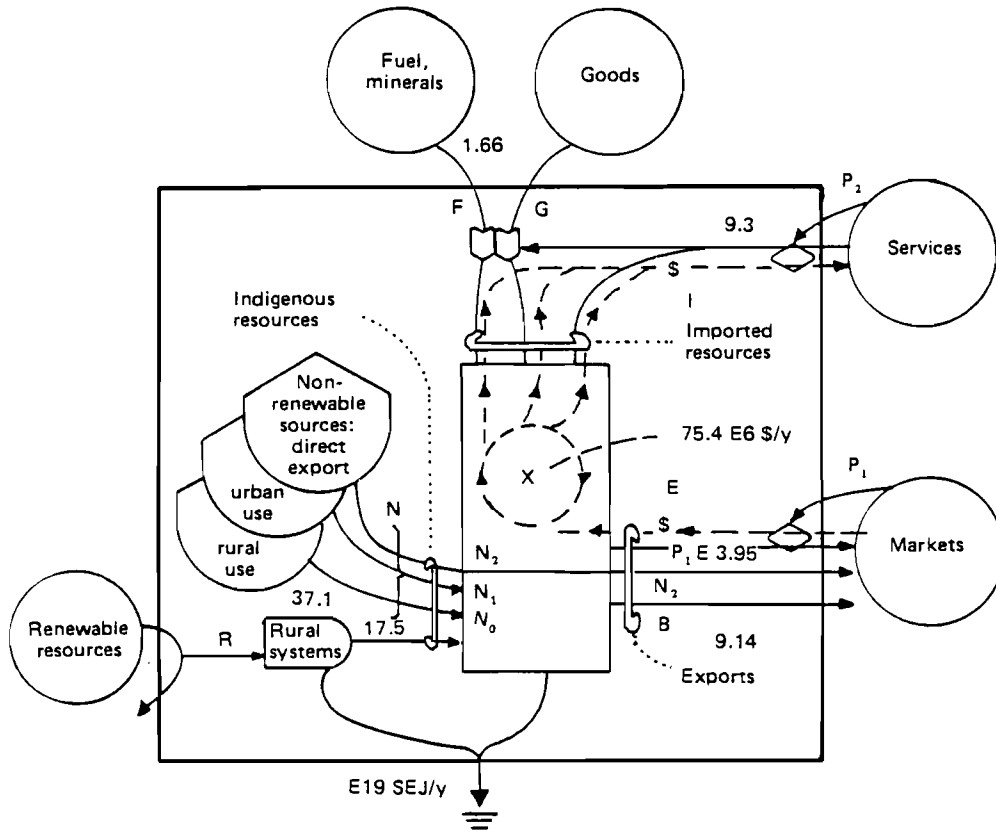

Figure 9.3. Summary diagram of the embodied energy flows of Dominica. An evaluation table is given as Table 9.3. Indices from these values are calculated in Table 9.4.

Energy Evaluation of the Trade Balance

International trade is included in Figure 9.2 and flows were evaluated in Figure 9.3. Export flow was mainly the sum of embodied energies in the two exporting subsystems, bananas and coconuts, plus those of fruits, vegetables and juices. The embodied energy of the import services was calculated based on an energy/dollar ratio (P_2) estimated for the various nations exporting to Dominica. The embodied energy of imported goods was found in preliminary analysis to be an insignificant fraction of imported services.

The balance of money payments showed a four-fold higher outflow than inflow. The difference is composed of investments, foreign aid and loans. However, the balance of embodied energy flows showed 1.5 times greater inflow than outflow.

National Overview Ratios

Table 9.4 lists various ratios calculated from data in Table 9.3 and Figure 9.3. These include ratios of outside to indigenous sources, export/import energies, fuel use/environmental energies, energy/person, energy/area and carrying capacities for the whole island. These ratios are useful both for predictions and international comparisons.

Subsystems

Two subsystems were analyzed as they were the most significant embodied energy exports from Dominica: 1) bananas, 2) coconuts and derivative products, copra, coconut oil and soap.

Table 9.4. Indices using embodied energy for overview of Dominica.

Item	Name of index and expression, see Figure 9.3		
1	Renewable embodied energy flow	R	1.75 E20 SEJ/y
2	Flow from indigenous non-renewable reserves	N	3.71 E20 SEJ/y
3	Flow of imported embodied energy	$F+G+P_2 I$	1.10 E20 SEJ/y
4	Total embodied energy inflows	$R+N+F+G+P_2 I$	6.56 E20 SEJ/y
5	Total embodied energy used, U	$U=N_0+N_1+R+F+G+P_2 I$	6.56 E20 SEJ/y
6	Total exported embodied energy	$B+P_1 E$	1.31 E20 SEJ/y
7	Fraction of embodied energy used derived from home sources	$(N_0+N_1+R)/U$	0.83
8	Exports minus imports	$(N_2+B+P_1 E)-(F+G+P_2 I)$	2.09 E19 SEJ/y
9	Ratio of exports to imports	$(N_2+B+P_1 E)/(F+G+P_2 I)$	1.19
10	Fraction used, locally renewable	R/U	0.27
11	Fraction of use purchased	$(F+G+P_2 I)/U$	0.17
12	Fraction used that is imported service	$P_2 I/U$	0.14
13	Fraction of use that is free	$(R+N_0)/U$	0.83
14	Ratio of concentrated to rural	$(F+G+P_2 I+N_1)/(R+N_0)$	0.20
15	Use per unit area (7.5 E8 m ²)	$U/(\text{area})$	8.75 E11 SEJ/m ²
16	Use per capita (80,000 population)	$U/(\text{population})$	8.2 E15 SEJ/per.
17	Renewable carrying capacity at present living standard	$(R/U) (\text{population})$	21,600 people
18	Developed carrying capacity at same living standard	$8(R/U) (\text{population})$	172,800 people
19	Ratio of use to GNP (energy-dollar ratio)	$P_1 = U/(\text{GNP})$	8.70 E12 SEJ/\$

Bananas

A subsystem diagram for bananas is given as Figure 9.4 and evaluations are in Table 9.5 for those bananas exported.

Bananas have dominated both agricultural land use and agricultural export revenues for decades in Dominica. The apparent small scale, low energy production system has required minor fossil fuel inputs when compared to service and the natural input of rain. However, subsistence farming consumes a large amount of embodied energy in the form of rain forest and soil biomass. Comparison of total embodied energy to total actual energy yielded an energy transformation ratio of 5.3 E5 SEJ/J. The embodied energy of exported bananas was 2.2 E19 SEJ/y or 24.7% of agricultural exports.

Coconuts and derivative products

A subsystem diagram for coconut agriculture and copra processing is given in Figure 9.5 and the evaluations are in Table 9.6.

Land use for coconut agriculture has been a fraction, about a third, of that for bananas. However, the investment in copra processing facilities and the annual use of large amounts of fossil fuel relative to other agricultural products makes coconut oil and products the highest embodied energy export. The large increases in embodied energy incurred with additional fossil fuel input, are evident in Figure 9.5. The differences in the embodied energies between coconuts, coconut oils and derivative soaps are ten and thirty-fold respectively. The

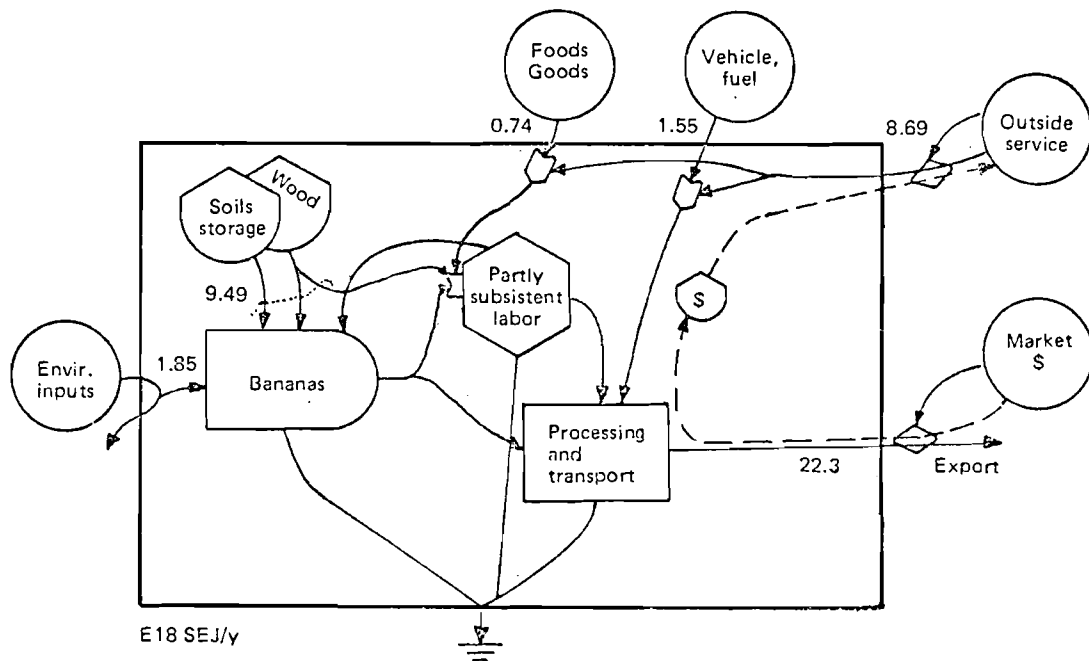

Figure 9.4. Energy flows in low energy banana plantings of Dominica.

Table 9.5. Evaluation of banana agro-ecosystem of Dominica.

Foot-note	Item	Actual energy J/y	ETR SEJ/J	Embodied solar energy E18 SEJ/y
1	Rain transpired	1.20 E14	1.54 E4	1.85
2	Soil and wood used	2.72 E14	3.49 E4	9.49
3	Goods, food	-	-	0.74
4	Service, 3.66 E6 US\$	-	2.37 E12/\$	8.69
5	Fuel used	2.53 E13	6.6 E4	1.55
6	Exported bananas	4.25 E13	5.25 E5	22.3

Footnotes for Table 9.5

Low energy banana agro-ecosystems in Dominica

Since farms greater than 5 acres in size occupy 60% of all farm acreage, and total banana acreage was a dispersed 39,000 acres in 1970 (Marie 1979), then subsistence farms are taken to be 15,600 acres (40% of the total). A 3 year cultivation rotation implies that 1/3 of this acreage is in use at any time, so $(0.3)(15,600) = 5140$ acres = 2.13 E3 hectares.

1. Solar equivalents of transpired rain

(rain transpired per area) (area) (Gibbs free energy per weight)

$$(3.05 \text{ m rain}) (0.39 \text{ transpired}) (5140 \text{ acres}) (4.05 \text{ E3 m}^2/\text{A})$$

$$(4.94 \text{ J/g}) (1 \text{ E6 g/m}^3) = 1.20 \text{ E14 J/y}$$

2. Soil and wood use

Grams/square meter calculations are taken from Footnote 2, Table 9.2. A three year crop rotation means that in effect 1/3 of the 2,176 g/m², or 762.2 g/m², is consumed each year. Forest organic matter combustion value: 4.2 kcal/g (Odum et al.. 1983).

$$(2.13 \text{ E3 ha}) (762.2 \text{ g/m}^2) (1 \text{ E4 m}^2/\text{ha}) (4.2 \text{ kcal/g})$$

$$(4186 \text{ J/kcal}) = 2.72 \text{ E14 J/y}$$

Footnotes for Table 9.5. continued

3. Goods, food

Portions of national imports estimated from the proportion that banana sales is of total national sales (40% of national sales, so $0.4 \times 9.2 \text{ E6 US \$} = 3.6 \text{ E6 US \$}$).

$$\frac{(3.6 \text{ E6 US \$})}{(39 \text{ E6 US \$})} (8.0 \text{ E18 SEJ/y}) = 7.39 \text{ E17 SEJ/y}$$

4. Services from sales

As indicated in Figure 9.3, money received for banana export may be used to evaluate the services external to the banana system. In 1978 37,016 t at 247.6 \$US/t

$$(0.4)(3.7 \text{ E4 t})(2.476 \text{ E2 \$/t}) = \$3.66 \text{ E6 (1978)}$$

5. Fuels used

Fuel proportion that banana sales are of total sales

$$\frac{(3.6 \text{ E6 \$})}{(\$39 \text{ E6})} (2.52 \text{ E14 J/g}) = 2.35 \text{ E13 J/y}$$

6. Bananas exported

37,016 t in 1978 (World Bank 1981). Since subsistence farms occupy 40% of all farms, then 14,806 metric tons exported originated from subsistence farms. Fresh bananas with 1.040 kca./g in flesh; flesh is 2/3 of total banana (Liu, 1980).

(weight of bananas)(energy content)

$$(1.48 \text{ E4 t/y})(1 \text{ E6 g/t})(1.04 \text{ kcal/g})(0.66)(4186 \text{ J/kcal})$$

$$= 4.25 \text{ E13 J/y exported from banana plantings}$$

Total embodied energy sum of inputs (Figure 9.3)

$$\frac{1.93 \text{ E19 SEJ/y}}{4.25 \text{ E13 J/y}} = 5.25 \text{ E5 SEJ/J}$$

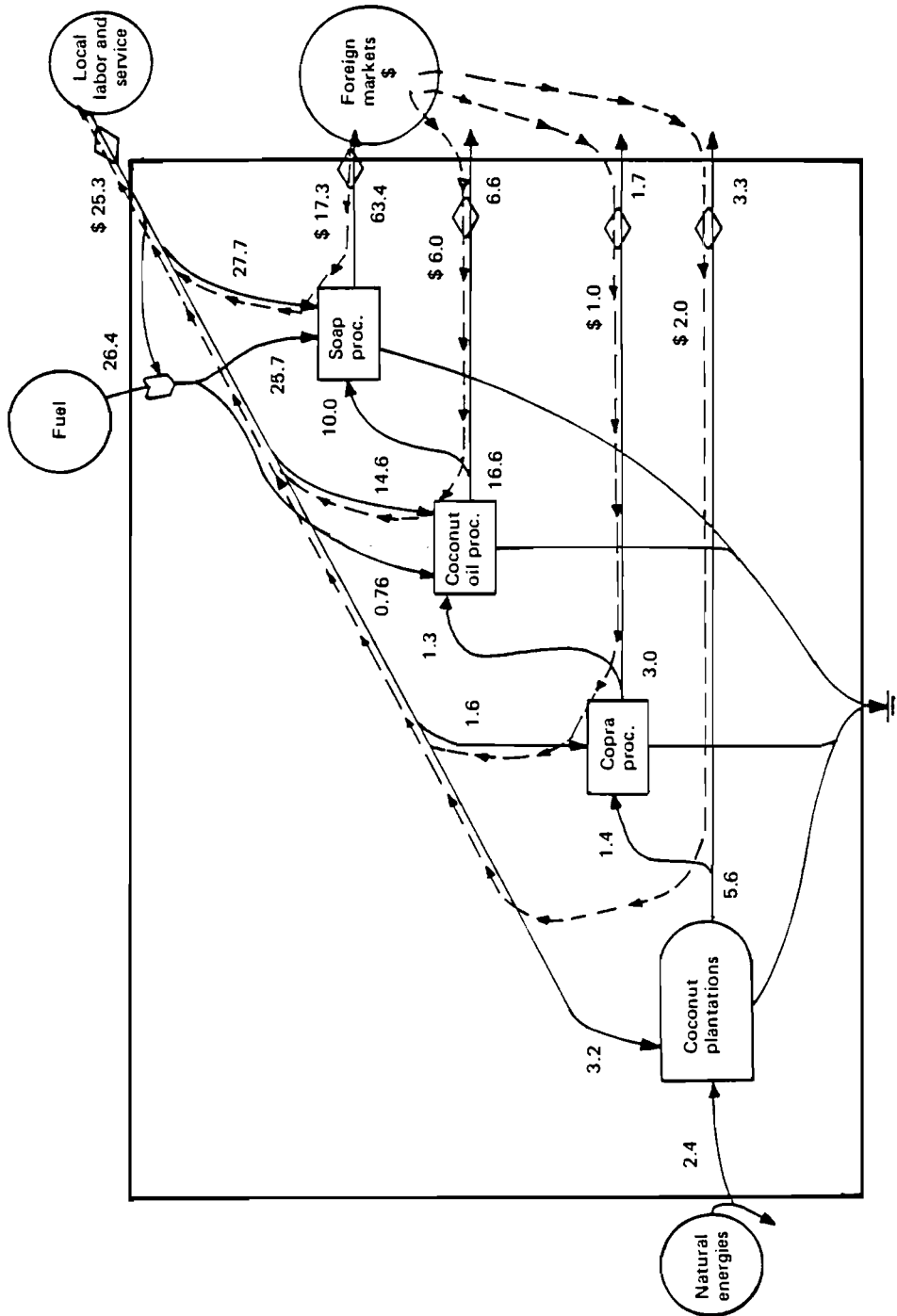

Figure 9.5. Summary diagram of coconuts and derivate products industry in Dominica in E18 SEJ/y and \$ E5 US.

Table 9.6. Flows for evaluating the embodied energy of coconuts and derivative products.

Foot- note	Item	Actual energy J/y	Energy transforma. ratio SEJ/J or SEJ/\$	Energy solar energy E18 SEJ/y
1	Natural energy	1.57 E4	1.54 E4	2.4
2	Labor handling coconuts, 2.0 E6 US\$	-	1.6 E13 /\$	3.2
3	Labor for copra 1.0 E5 US\$	-	1.6 E13 /\$	1.6
4	Labor handling oil 9.12 E5 US\$	-	1.6 E13 /\$	14.6
5	Fuel for oil dehydration	1.15 E13	6.6 E4 -	0.76 -
6	Labor for making soap, 1.73 E6 US\$	-	1.6 E13 /\$	27.7
7	Fuel for soap process	3.9 E14	6.6 E4	25.7
8	Coconut products			
	coconuts	1.8 E14	2.4 E4	3.4
	copra	4.4 E13	6.9 E4	3.0
	oil	1.4 E14	1.2 E5	16.6
	soap	8.85 E13	7.2 E5	63.4

Footnotes for Table 9.6.

1. Solar equivalents of transpired rain

(3.0 meters rain) (0.39 transpired) (6,725 acres) (4.05 E3 m²/A)

(4.94 J/g) (1 E6 g/m³) = 1.57 E14 J/y

2. Labor of harvesting and handling coconuts

Production cost/acre: 187.89 EC\$ = 69.59 US\$ (J. Marie 1979).

Yield/acre: 1.3 metric tons (United Nations 1975); 1979

coconut export: 703 metric tons (World Bank 198a).

Total acreage = 703 metric tons/1.3 m.t./acre = 537 acres.

(69.59 US\$/acre) (537 acres) = 3.7 E5 US\$.

3. Copra export revenue: 1.05 E5 US\$.

World Bank (1981a) (see Table 3.2).

Footnotes for Table 9.6 continued

4. Labor of handling oil

1979 coconut oil production (World Bank 1981) = 396 E3 gal.
= 1663 E3 liters x (0.8679 g/l) = 3.62 E3 m.t.
Total US purchases of coconut oil in 1979 divided into
total price paid, yield a figure of 251.80 US\$/metric ton.
Dominica's energy/dollar ratio: 1.6 E13 SEJ/US\$ (Table 9.3).

(3.62 E3 metric tons oil)(US \$251.80/m.t.) = 9.12 E5 US\$

5. Fossil fuel dehydrating coconut oil

Coconut oil is made more saleable by driving off any remaining water by raising the oil temperature to 110°C for several hours. 0.540 kcal/g is the dehydration energy of water molecules not chemically bonded (bonds of hydration) to the molecules of oil. A multiplication factor of 1.4 was used to account for the sixty percent reduction during the dehydration process.

Process heat energies

= (3.62 E3 m.t.)(1 E6 g/m.t.)(.54 kcal/g)(1.4)(4186 J/kcal)
= 1.15 E13 J/y

6. Labor for production of soap

The World Bank (1981) in Table 3.2, p. 143 lists toilet and laundry soap export as 2,182 metric tons at a price of US\$ 794.7/m.t. for a total of US\$ 1,734,035 in export revenue.

7. Fuel for soap processing

Fuel use for soap processing on Dominica assumed to be similar to US production of soap is (30.1 kg/person)(230 E6 people) = 6.92 E9 kg and requires 2.95 E11 kcal. Fossil fuel use per kg = (2.95 E11 kcal)/(6.92 E9 kg) = 42.6 kcal/kg.

(42.6 kcal/kg)(4186 J/kcal)(1 E6 kg/T)(2182 T) = 3.9 E14 J/y

8. Coconuts and derivative products exported

Coconuts

1979 coconut export weight: 703 T (World Bank 1981, p. 143)
Coconut production in 1979: 11,721 (World Bank 1981, p. 174).
Coconut composition: 28% meat, 72% fiber (Encyclopedia Brittanica 1974, p.472).

Footnotes for Table 9.6 continued

Actual energy calculations:

$$\begin{aligned} \text{Fiber} &- (0.72) (11,721 \text{ T}) (1 \text{ E6 g/T}) (4 \text{ kcal/g}) (4186 \text{ J/kcal}) \\ &= 1.4 \text{ E14 J} \end{aligned}$$

$$\begin{aligned} \text{Meat} &- (0.28) (11,721 \text{ T}) (0.5 \text{ water}) (1. \text{ E6 g/T}) (4.94 \text{ J/G}) \\ &= 8.1 \text{ E9 J} \end{aligned}$$

$$\begin{aligned} &(0.28) (11,721 \text{ T}) (0.3 \text{ oil}) (1 \text{ E6 g/T}) (8.816 \text{ kcal/g}) (4186 \text{ J/kcal}) \\ &= 1.8 \text{ E14 J} \end{aligned}$$

Labor embodied energy: 3.3 E18 SEJ/y (Footnote 2, Table 9.6).
Natural embodied energy:

$$\begin{aligned} &(540 \text{ acres}) (3 \text{ m rain/y}) (4.05 \text{ E3 m}^2/\text{A}) (4.94 \text{ J/g}) (1 \text{ E6 g/m}^3) \\ &= (1.26 \text{ E13 J}) (1.54 \text{ E4 SEJ/J}) = 1.95 \text{ E17 SEJ/y} \end{aligned}$$

Total embodied energy in coconuts: 3.4 E18 SEJ/y

Energy transformation ratio using solar equivalents of rain and labor used:

$$(3.4 \text{ E18 SEJ/y}) / (1.8 \text{ E14 J/y}) = 2.43 \text{ E4 SEJ/J}$$

Copra

1979 export: 574 T for 0.1 E6 US \$; 1979 total copra production: 2704 T (World Bank 1981, p. 143, 175). Average coconut outputs worldwide: 4500 nuts/acre, 30 nuts/10 lbs. copra (Encyclopedia Brittanica 1974, p. 472). Rain and transpiration data (see Footnote 3, Table 9.1). Embodied energy calculations:

$$\begin{aligned} \text{Natural} &(2704 \text{ T}) (1 \text{ E3 kg/T}) (2.2 \text{ lbs./kg}) (30 \text{ nuts/10 lbs. copra}) \\ &(1 \text{ acre/4500 nuts}) (3 \text{ m rain}) (0.39 \text{ transpired}) \\ &(4.05 \text{ E3 m}^2/\text{acre}) (4.94 \text{ J/g}) (1 \text{ E6 g/m}^3) (1.54 \text{ E4 SEJ/J}) \\ &= 1.4 \text{ E18 SEJ/y} \end{aligned}$$

$$\begin{aligned} \text{Labor} &(0.1 \text{ E6 US \$}) (1.6 \text{ E13 SEJ/US \$}) \\ &= \underline{1.6 \text{ E18 SEJ/y}} \end{aligned}$$

Total embodied energy of copra: = 3.0 E18 SEJ/y

Energy of fatty acids in coconut oil: 9.4 kcal/g (Mitchell 1979, p. 81).

Footnotes for Table 9.6 continued

Composition of copra: prepressed copra - water (5%), oil (70%), fiber (25%), post pressed copra - protein (21.3%), oil (7%), fiber (71.7%) (Encyclopedia Britannica 1974). Actual energy of protein: 1520 kcal/kg (Mitchell 1979). Actual energy of fiber: 4 kcal/g (Odum et al. 1983). Actual energy calculations:

$$\text{Protein } (0.21) (2704 \text{ T}) (1 \text{ E3 kg/T}) (1520 \text{ kcal/kg}) (4186 \text{ J/kcal}) = 3.66 \text{ E12 J}$$

$$\text{Oil } (0.07) (2704 \text{ T}) (1 \text{ E6 g/T}) (9.4 \text{ kcal/g}) (4186 \text{ J/kcal}) = 7.45 \text{ E12 J}$$

$$\text{Fiber } (0.72) (2704 \text{ T}) (1 \text{ E6 g/T}) (4 \text{ kcal/g}) (4186 \text{ J/kcal}) = 3.25 \text{ E13 J}$$

$$\text{Total actual energy of copra: } = 4.35 \text{ E13 J}$$

Energy transformation ratio using solar equivalents of rain and labor used:

$$(3.0 \text{ E18 SEJ/y}) / (4.35 \text{ E13 J/y}) = 6.9 \text{ E4 SEJ/J}$$

Coconut Oil

Embodied energy of fuel used for oil processing: 7.6 E17 SEJ (see Footnote 5, Table 9.6). Embodied energy of labor: 1.46 E19 SEJ/y (see Footnote 4, Table 9.6). Dividing total copra oil content (0.7 x 2704 T = 1893 T oil) into total embodied energy of copra/y yields 1.6 E15 SEJ/T oil. Multiplying 800 T oil times the latter gives 1.28 E18 SEJ/y embodied energy of copra to oil industry. Total embodied energy:

$$(7.6 \text{ E17 SEJ}) + (1.46 \text{ E19 SEJ/y}) + (1.28 \text{ E18 SEJ/y}) = 16.6 \text{ E18 SEJ/y}$$

Total actual energy:

$$(3.62 \text{ E3 T}) (1 \text{ E6 g/T}) (9.4 \text{ kcal/g}) (4186 \text{ J/kcal}) = 1.42 \text{ E14 J/y}$$

Energy transformation ratio using the embodied energies of labor, fuel and oil derived from copra:

$$(16.6 \text{ E18 SEJ/y}) / (1.42 \text{ E14 J/y}) = 1.16 \text{ E5 SEJ/J}$$

Footnotes for Table 9.6. continued

Soap

Embodied energy of fuel for soap processing: 25.7 E18 SEJ/y (see Footnote 7, Table 9.6). Embodied energy of labor for soap processing: 27.7 E18 SEJ/y (Footnote 6, Table 9.6). Embodied energy of coconut oil: 1.0 E19 SEJ/y (percentage of total oil production used for soap manufacture). Total embodied energy of soaps:

$$(1.0 \text{ E19 SEJ/y}) + (25.7 \text{ E18 SEJ/y}) + (27.7 \text{ E18 SEJ/y}) = \\ = 63.4 \text{ E18 SEJ/y}$$

Actual energy of lauric acid (predominant constituent of oils used to make soap): 8.816 kcal/g (Weast 1974). Total production of toilet and laundry soaps: 2398 T (World Bank 1981, p. 175). Actual energy calculations:

$$(2398 \text{ T}) (1 \text{ E6 g/T}) (8.816 \text{ kcal/g}) (4186 \text{ J/kcal}) = 8.85 \text{ E13 J}$$

Energy transformation ratio using the embodied energies of labor, fuels and coconut oil:

$$(63.4 \text{ E18 SEJ/y}) / (8.85 \text{ E13 J/y}) = 7.2 \text{ E5 SEJ/J}$$

Coconuts and derivate products (cont'd)

energy transformation ratio, 2.4 E4 SEJ/J, is 4% of that of bananas, which indicates that banana cultivation uses much more high-quality energy (biomass of rainforest wood and soils) than coconut cultivation. The embodied energy of exported coconuts and derivative products was 7.5 E19 SEJ/y or 68% of agricultural imports.

Fruits, Vegetables and Juices

The acreage devoted to the cultivation of fruits and vegetables compared to that for coconuts and bananas, was relatively minor. The embodied energy of fruit, vegetable and juice exports was 6.4 E18 SEJ/y or 7.0% of agricultural exports compared to 69% and 24% for coconut products and bananas respectively.

Discussion

Main Basis for the Economy

The overview diagram in Figure 9.3 and the indices in Table 9.4, provide an overview of the basis of the economy of Dominica in energy terms. The main basis of the economy is the indigenous use of environmental energies, particularly the stored energies of rainforest woods and soils. By contrast the purchased embodied energies of imports are only 10% of the entire energy basis (item 11, Table 9.4).

The Monied Economy

The circulation of money in gross national product (Figure 9.3; Table 9.3) was about 69.6 million dollars per year, of which 39.6 million dollars per year was paid for imports (57%). Only 9.4 million dollars was received for exports (14%), the rest of the income coming from loans, investments, foreign aid, etc.

Dominica's trade balance might appear less dependent on foreign money sources in years other than 1979 when severe hurricane damage to export crops brought abnormal amounts of disaster relief and required special reinvestment in the capital assets of plantation and hotels and the power distribution network.

Previous Emphasis on Bananas

Part of the difficulty in developing the economy of Dominica arose when efforts to make the banana export industry were not very successful. Note the low energy bananas system in Figure 9.4 compared to that of Taiwan (Pimentel 1978). Bananas are industrialized with more difficulty in Dominica's steep terrain, torrential rains, and poor transportation facilities as compared with economic competition from Ecuador and elsewhere. Earlier there were special trade prices with Great Britain and investment money went primarily into attempts to make the banana export industry competitive.

From the Second World War until Britain's joining of the European Common Market Dominica's banana export was supported by lower tariffs into the U.K. Despite this protection, more efficient producers (such as Ecuador) managed to hold export prices to a level which left Dominica's producers with little profit, 3 cents per pound (J. Marie 1979). Joining the EEC in 1973 has forced the U.K. to dismantle the support structure and expose Dominica to open market pressures which may finally depress the banana industry to much lower levels. By 1980 banana output was at 70% of 1976 levels.

Present Self-Sufficiency

Since much of the economy is not accompanied by money, the evaluation based on energy provides a more favorable view of life in Dominica. On an energy basis 39% (Table 9.4, Item 7) of the economy is derived from home sources. The embodied energy of exports and imports is nearly balanced.

However, much of the environmental energy basis is being used in a nonrenewable way because of loss of soils and rainforest trees used faster than their regrowth. Almost 40% of Dominica's high quality storages in rainforest and soils have been drained in the last 20 years to maintain present economic activity. It appears that Dominica's energy basis for self-sufficiency is declining and dependence on external sources will increase ever faster. Exhaustion of natural storages deplete the basis for foreign investment and depress the economy. However, when export cropping in the highlands no longer pays, rainforests may have a chance to rebuild wood and soil storages for another cycle.

Economic Growth Potential

Economic development often proceeds with investments to draw resources of the environment into commerce ultimately increasing the input of fossil fuels and fuel based goods and services adding to the indigenous energy resources involved. This process is little developed in Dominica where the ratio of concentrated to rural energy is only 0.20. The ratio of electrical energy flow to total energy flow is only 0.0014% compared to values for New Zealand, 0.15; Spain, .22; and the USSR, 0.194.

Although the potential for attracting invested foreign embodied energy inputs is large, so far this process has been unsuccessful in generating exports that can compete well in international markets.

Embodied Energy-Dollar Ratio

The embodied energy-dollar ratio for Dominica is four times that of the United States, but 1/4 that of Liberia (Chapter 7). The ratio shows in another way how much of the system is outside the economy of circulating money. Anyone importing from Dominica to the United States obtains four times more embodied energy than is in the buying power of the dollar spent in the United States. Consequently, efforts to export raw products such as bananas, do not stimulate the home economy as much as complete processing which draws more dollars into the economy per embodied energy invested. Trade arrangements judged on the basis of dollar exchanges benefit the country with the lower energy dollar ratio.

Energy Density

In Dominica, the embodied energy use/square meter is $8.8 \text{ E}11 \text{ SEJ/m}^2$ (Table 9.4, Item 15). This ratio is about twice that of the U.S.A. and Liberia and reflects the enormous environmental energy flow per person contributed by the use of virgin forest and soil storages which was 56% of the total energy use in Dominica (Footnote 10, Table 9.1). On a per area basis, this flow dwarfs the fossil fuel energy use in the U.S.A. and the large natural energy flows in Liberia.

Energy per Person

Fuel use per person in Dominica, $2.08 \text{ E}14 \text{ SEJ/y}$, is approximately 35% of the of the United States, $5.7 \text{ E}14 \text{ SEJ/y}$. A more incisive measure of the energy standard of living might be total

embodied energy per person (Item 16, Table 4). By this measure Dominica, 8.2 E15 SEJ/y, is 41% of the U.S.A., 2.0 E16 SEJ/y, and 31% of Liberia, 2.6 E16 SEJ/y.

Usually the resource inputs per person are indicated with fuel energy per person or other indices of commerce and industry. At least in an overall sense, Dominica's flows of renewable energies give them a comparable standard of living. The embodied energy in annual income (474 US\$/y, World Bank 1981), is only 55% of the total embodied energy use per person (7.58 E15 SEJ/1.39 E16 SEJ).

Carrying Capacity

The 1979 population was 82,699 people. The renewable carrying capacity or population level sustainable were Dominica to exist only on its renewable energy inputs (after rain forests are used) would be 21,600 people.

At the present rate of wood and soil use, the remaining rain forests will be used up in 60 years. During the period of time before, investments may be attracted and populations supported which will not be supportable later. Dominica is self-sufficient now, but on a declining resource. Changed land uses with land rotations and fertilizers may be needed to provide an alternative system to rain forest use.

The developed carrying capacity ratio in Table 9.4, indicates the carrying capacity if the economic development were that of the most industrialized nations, with eight times more embodied energy use than supplied from local renewable sources. For

Dominica with people at their present standard of living, the carrying capacity would be 172,800 people, much larger than the present population of 80,000. Unless it declines, the annual population growth rate, 1.6%/y (CIA 1977) will result in less energy per person if the economic developments that allow outside energy imports are not found.

Hydroelectric Potential

Part of balanced development is providing low cost electric supplies to all parts of a country. The interaction of high rain input and strong mountain uplift has created over three hundred rivers on Dominica. Many of these rivers have sufficient energy to drive turbines or machines on a fairly continuous basis without the necessity of maintaining a large water area uphill. Without the expense of building large dammed reservoirs, relatively inexpensive hydropower could be established. Whether this energy drives mills directly or turbine dynamos for electricity will depend on the type of manufacturing capacity national policy pursues. Such a rurally available power source could provide the capacity to process agricultural products locally and thus bring more jobs and embodied energy to the local economy. Renewable hydropower may be available long after fossil fuels become too expensive. Developing such capacity will contribute to Dominica's immediate and future vitality.

Whereas geothermal energy is apparently available in hot spring areas of Dominica, the hydroelectric potentials require less special technology and are more renewable.

Renewable Forest Options

Tropical forest plantations develop useful light density roundwood products with a 20 year rotation especially if fertilizers are applied, although the products are inferior for many purposes as long as virgin forest wood is available.

Letting natural processes restore and regenerate soils and forests is the normal pattern on Dominica and elsewhere. In the shifting agricultural patterns, over 10 to 20 years are needed to develop appropriate soil conditions for another two or three years crop. This pattern may be improved with additional inputs, improved diversity of crops, fertilizers, etc.

For rugged watersheds and high lands with highest rainfalls, a longer rotation of 100 years may allow high quality timber at little cost, providing trees can receive protection and gene pools can be retained in clusters to provide seeding for fast forest regeneration.

Perhaps through import of exotics, plantations of high quality botanical products, pharmaceuticals, etc., not in competition with other areas, may increase the conversion of the large embodied energies of Dominica into means for economic development.

Developing a high diversity of tropical tree crops for local consumption could help local standards of living by routing the embodied environmental energies into human use.

Future

The unusual energy signature of Dominica provides a challenge to couple the economy of humans to the exceptional flows of water, uplifting lands, tropical growing conditions, and tropical seas. If more of the world's tourists can learn the fascination of seeing the best preserved rainforest island in the hemisphere, their funds may help to maintain the economic balance to help preserve some of the virgin forests. The future for Dominica is more promising than for some dry desert islands already over-populated.

Leon C. Braat
*Institute for Environmental Studies,
Free University, Amsterdam*
and
*International Institute for Applied
Systems Analysis, Laxenburg, Austria*

10. ENERGY ANALYSIS OVERVIEW OF THE NETHERLANDS

Introduction

An embodied energy analysis of the Netherlands for the year 1980 is presented. The analysis includes flows and storages of renewable and nonrenewable resources within the country, and flows from external sources, such as sunlight, rain, rivers, fuels, and goods and services. The objective of the analysis is to give an overview of and insight in the energy basis for the Dutch economic and environmental system and to provide an alternative quantitative basis for policy recommendations at the national level.

The procedure employed has been described in Part I of the report and in earlier versions in Odum et al. (1981) and Odum (1983). The major steps in the procedure are:

- (1) Development of an energy flow diagram, summarizing all energy flows across the border, all major flows through country subsystems, and describing the main storages of renewable and nonrenewable resources.
- (2) Estimation of actual energy flows and storages, converting all units into energy units.
- (3) Calculation of embodied energy in the flows and the storages, expressed as embodied energy units of the same quality, solar equivalent joules.
- (4) Calculation of relevant ratio's and indices for evaluation of the economic state, policies, and potential.

The Country

The Netherlands is a delta country with approximately 30 percent of the land area below sea level. This part is protected from the North Sea and Rhine and Meuse river branches by an extensive network of dikes and by circa 300 km of coastal dunes. The lowlands have clay soils, of marine or fluvial origin. The uplands are covered by pleistocene sands and fine, wind-carried clays.

There is no virgin ecosystem left in the country; most of the land that is not in cultivation, is heathland and abandoned pine plantations. Many of the lakes are eutrophic due to heavily fertilized agriculture, while some are showing acid rain impacts.

The population of 1980 counted 14,091,000 people of which 75 percent live in urbanized areas. The total land area is 37,000 km², of which 30 percent is permanent pasture land, 23 percent arable and permanent crop land, 30 percent urban area, 8 percent lakes, estuaries and rivers, 9 percent woodland and the precious dunes cover almost 1 percent.

In Figure 10.1 the boundary between uplands and lowlands is shown, as well as the branches of the Rhine and Meuse river, the coastal dune ridge and the major lakes and estuaries. Furthermore, the area which has been designated as Dutch North Sea territory is delineated, showing the main oil and natural gas fields.

The System Diagram

A medium complexity diagram of the Netherlands is shown in Figure 10.2. Embodied solar equivalent joules are written on the major pathways and storages. The relative importance of the energy flows of different forms can thus be evaluated. The diagram includes the natural energy input flows of sun, wind, rain, waves, tide, and rivers interacting with fuel energy and flows of imported goods and services through the major characteristic subsystems of the country. Dunes and dikes, polders, the natural gas reserve, the intensive agriculture and the petrochemical industry form a combination of subsystems unique in the world.

The values of the flows are summarized in Table 10.1, containing actual energy values, energy transformation ratios and

calculated embodied energy values. The storages are listed in Table 10.2. Calculations and sources of data are presented in the footnotes to the tables.

Aggregated Diagram

In Figure 10.3 the flows and subsystems of Figure 10.2 have been aggregated or selected for. For reasons of double counting only the largest solar-driven energy input flow is considered when evaluating the energy budget for a nation. In the case of the Netherlands the combined input of the independent chemical potential energies of rain, falling on the country and rivers flowing into the country form the largest natural energy input flow.

Imported energies include the energy embodied in fuels, goods and in services (corrected for double-counting). In the Netherlands an important source is the national reserve of natural gas. The exploited gas is partly consumed (613 E20 SEJ/yr) but is mostly exported without transformations (831 E20 SEJ/yr).

Figure 10.3a is an aggregated summary diagram to facilitate comparison of countries. Figure 10.3b, the so-called three-arm diagram, summarizes input and output flows to the economy, distinguishing indigenous sources, imported sources and exports only.

The flows depicted in Figure 10.3 are listed in Table 10.3 as is the calculation of the embodied energy to dollar (1980 \$ = 2 guilders) ratio. The embodied energy to dollar ratio for the United States for 1980 has been used to calculate the embodied energy of imported services.

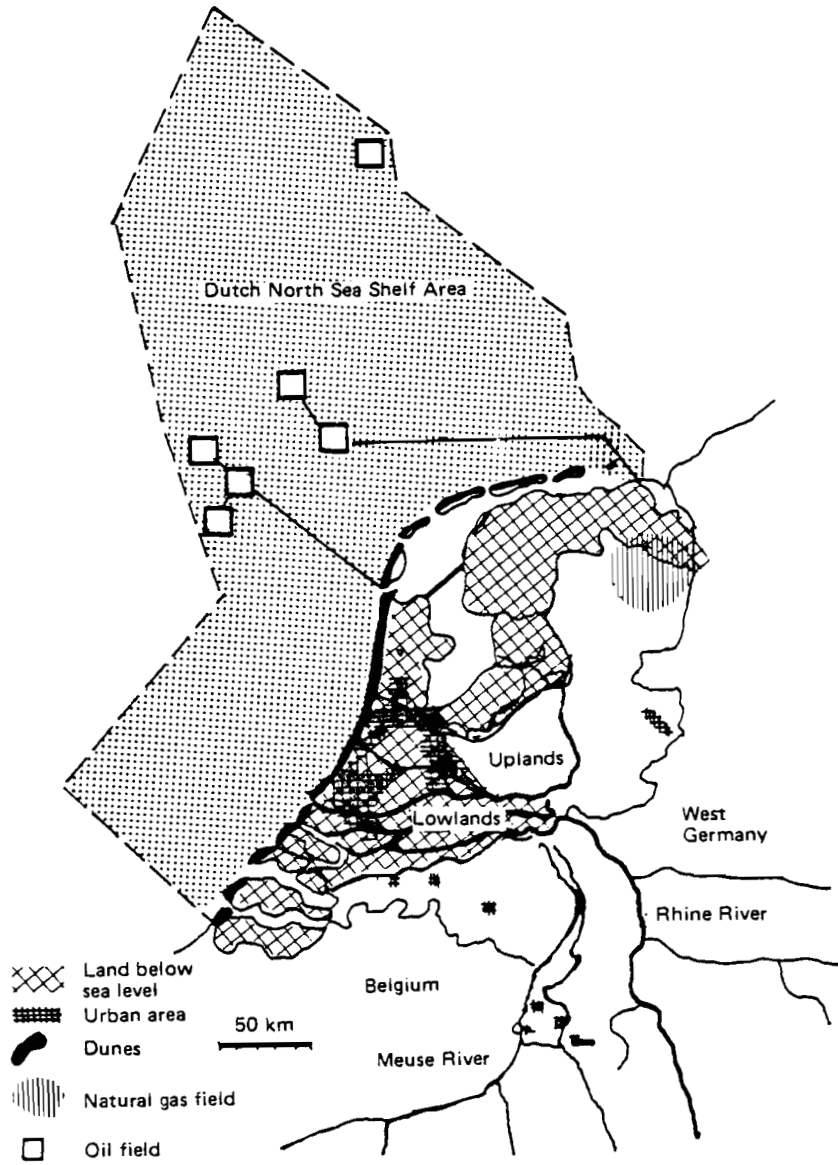

Figure 10.1. The Netherlands.

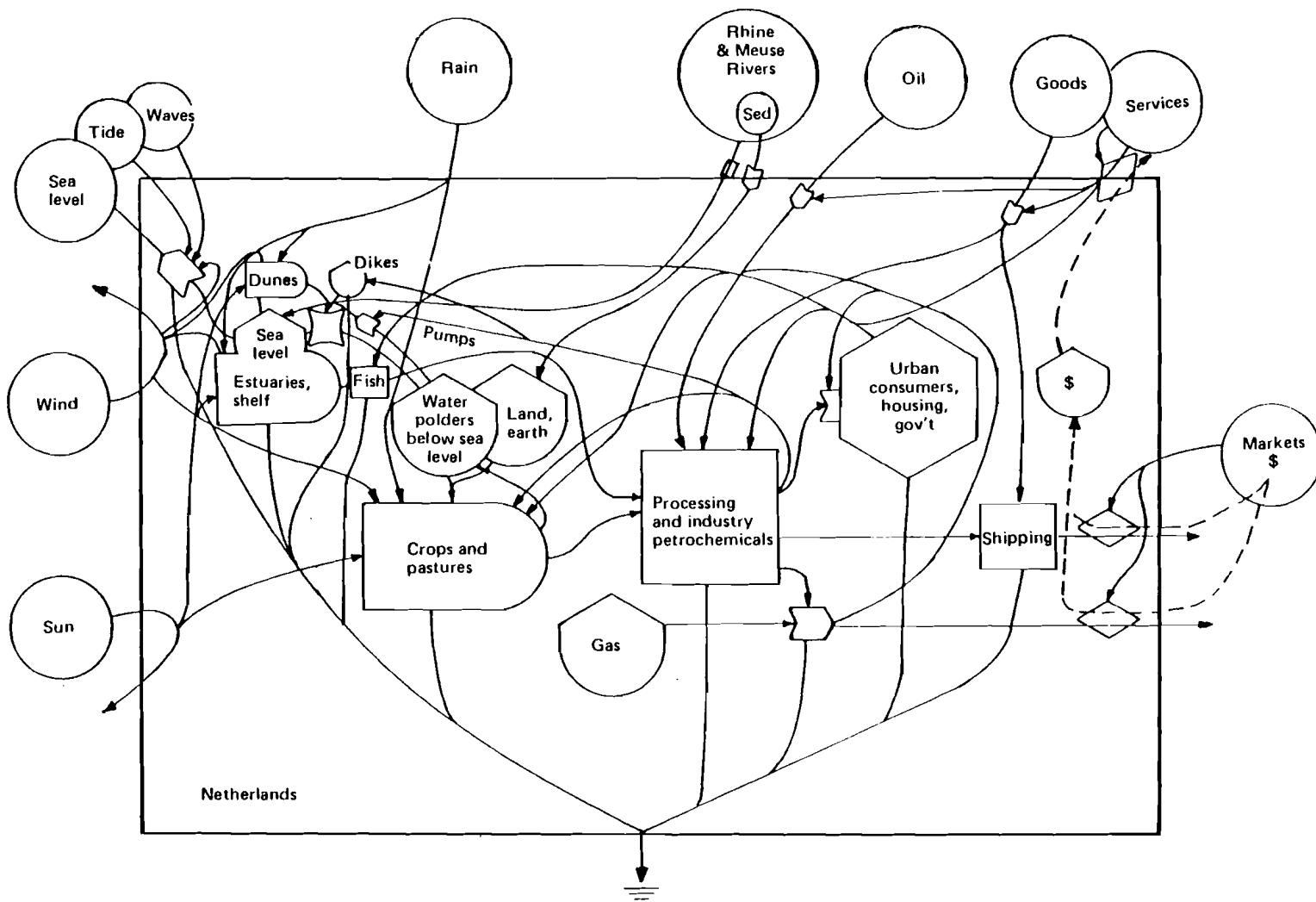

Figure 10.2. Energy diagram of the Netherlands.

Table 10.1. Energy flows of the Netherlands.

Foot-note	Item	Actual energy J/yr	ETR SEJ/J	Embodied solar energy SEJ/yr E20
1	Direct sunlight	3.0 E20	1	3.0
2	Wind absorbed	4.9 E17	663	3.2
3	Waves absorbed	4.7 E16	25889	12.1
4	Tide			
	- in estuaries	1.3 E13	23564	0.003
	- on shelf	5.1 E17	33564	120.4
5	Rain			
	- geopotential	3.6 E15	8888	0.3
	- chemical potential	3.9 E17	15423	59.7
6	Rivers			
	- geopotential	1.6 E17	23564	37.7
	- chemical potential	3.9 E17	41068	159.8
7	Top soil use	1.5 E15	62500	0.9
8	Earth flow*	0.9 E12	1.7 E9	15.3
9	Coal			
	- imported	2.2 E17	39800	87.6
	- exported	6.0 E16	39800	23.9
	- used	1.6 E17	39800	63.7
10	Oil			
	- imported	2.9 E18	53000	1557.1
	- local source	6.7 E16	53000	35.5
	- exported	1.4 E18	66000	950.4
	- used	1.4 E18	66000	943.8
11	Natural gas			
	- imported	1.2 E17	48000	57.6
	- local source	2.9 E18	48000	1387.2
	- exported	1.7 E18	48000	831.4
	- used	1.3 E18	48000	613.4
12	Electric power			
	- imported	1.8 E15	159000	2.9
	- nuclear source	1.5 E16	159000	24.0
	- exported	2.9 E15	159000	4.7
	- used	2.2 E17	159000	349.8
13	Embodied energy in imported goods and services	—	—	1115.0
	Embodied energy in exported goods and services	—	—	1516.0

*Flow in grams per year; ETR in SEJ/gram.

Footnotes to Table 10.1.

1. Direct sunlight

area land: $3.7 \text{ E}10 \text{ m}^2$ (CBS 1982); area shelf: $5.0 \text{ E}10 \text{ m}^2$ (estimated from map); annual solar energy: $3.4 \text{ E}9 \text{ J/m}^2/\text{yr}$ (KNMI 1980).

$$*(8.7 \text{ E}10 \text{ m}^2)(3.4 \text{ E}9 \text{ J/m}^2/\text{yr}) = 2.99 \text{ E}20 \text{ J/yr}$$

2. Wind absorbed

height: 1000 m; vertical gradient: $12 \text{ E}-3 \text{ m/s}$; eddy diffusion coefficient: $25 \text{ m}^3/\text{m}^2/\text{sec}$; time factor: $3.154 \text{ E}7 \text{ s/yr}$; density: 1.23 kg/m^3

$$*(2.4 \text{ E}-3 \text{ /s})^2(1.23 \text{ kg/m}^3)(25 \text{ m}^3/\text{m}^2/\text{sec})(3.154 \text{ E}7 \text{ s/yr})(8.7 \text{ E}10 \text{ m}^2)(1000 \text{ m}) = 4.86 \text{ E}17 \text{ J/yr}$$

3. Waves absorbed

(a) shore length: $3 \text{ E}5 \text{ m}$ (estimate from map); density: $1.025 \text{ E}3 \text{ kg/m}^3$; gravity: 9.8 m/sec^2 ; time factor: $3.154 \text{ E}7 \text{ sec/yr}$; height 1m (estimate); velocity: 5.422 m/s ; factor: $1/8$

$$*(3 \text{ E}5 \text{ m})(1.025 \text{ E}3 \text{ kg/m}^3)(1/8)(9.8 \text{ m/sec})(1 \text{ m})^2(5.422 \text{ m/s})(3.154 \text{ E}7 \text{ s/yr}) = 6.44 \text{ E}16 \text{ J/yr}$$

(b) wave energy: $\pm 3.1 \text{ kW/m}$ 3100 J/s/m (Wave Power Systems MIT 1979)

$$*(3100 \text{ W/m})(3 \text{ E}5 \text{ m})(3.154 \text{ E}7 \text{ sec/yr}) = 2.93 \text{ E}16$$

4a. Tides absorbed in estuaries

area elevated: $630 \text{ E}6 \text{ m}^2$ (estimated); tides per year: 706; height: 2.4 m (estimated); density: $1.025 \text{ E}3 \text{ kg/m}^2$; gravity: 9.8 m/s^2 ; factor: 0.5

$$*(630 \text{ E}6 \text{ m}^2)(706)(2.4 \text{ m})^2(1.025 \text{ E}3 \text{ kg/m}^2)(9.8 \text{ m/s})(.5) = 12.88 \text{ E}12 \text{ J/yr}$$

4b. Tides absorbed on continental shelf

same formula, multiplied by .5; area shelf: $5 \text{ E}10 \text{ m}^2$

$$*5.11 \text{ E}17 \text{ J/yr}$$

Footnotes to Table 10.1 continued.

5a. Rain—geopotential

area: $8.7 \text{ E}10 \text{ m}^2$; mean elevation: 10 m (estimate from map);
runoff: .425 m (calculated from rainfall and evaporation;
evaporation data from CBS 1978); density: $1 \text{ E}3 \text{ kg/m}^3$; grav-
ity: 9.8 m/sec^2

$$(8.7 \text{ E}10 \text{ m}^2) (10 \text{ m}) (.425 \text{ m}) (1 \text{ E}3 \text{ kg/m}^2) (9.8 \text{ m/sec}^2)$$

$$= 3.62 \text{ E}15$$

5b. Rain—chemical potential

area: $8.7 \text{ E}10 \text{ m}^3$; rainfall: .9 m/yr (KNMI 1980); Gibbs
free energy: 4.94 J/g; area factor: $1 \text{ E}6 \text{ g/m}^2$

$$*(8.7 \text{ E}10 \text{ m}^3) (.9 \text{ m/yr}) (4.94 \text{ J/g}) (1 \text{ E}6 \text{ g/m}^2) = 3.87 \text{ E}17 \text{ J/yr}$$

6a. Rivers—geopotential water

flow volume: $80 \text{ E}9 \text{ m}^3/\text{yr}$ (Stiff 1980); density: $1 \text{ E}3 \text{ kg/m}^2$;
height of river entry: 20 m (estimated from map); gravity:
 9.8 m/sec^2

$$*(80 \text{ E}9 \text{ m}^3/\text{yr}) (1 \text{ E}3 \text{ kg/m}^3) (20 \text{ m}) (9.0 \text{ m/sec}^2) = 1.57 \text{ E}16 \text{ J/yr}$$

6b. Rivers—chemical potential water

flow volume: $80 \text{ E}9 \text{ m}^3/\text{yr}$; density: $1 \text{ E}6 \text{ g/m}^3$; Gibbs free
energy: 138.8 ($\log_e 1 \text{ E}6 - 600/965000$) J/g for 600 ppm
(calculated from Stiff 1980)

$$*(80 \text{ E}9 \text{ m}^3/\text{yr}) (1 \text{ E}6 \text{ g/m}^3) (4.858 \text{ J/a}) = 3.89 \text{ E}17$$

7. Top soil used

farmed area: $2.035 \text{ E}10 \text{ m}^2$ (= 55% of land area); erosion
rate: $250 \text{ g/m}^2/\text{yr}$ (A); successional area: $296 \text{ E}10 \text{ m}^2$ (8%
of land area); soil formation rate = $1260 \text{ g/m}^2/\text{yr}$; organic
fraction: 0.5 (guess)

$$*(2.035 \text{ E}10 \text{ m}^2) (250 \text{ g/m}^2/\text{yr}) - (.296 \text{ E}10 \text{ m}^2) (1260 \text{ g/m}^2/\text{yr})$$

$$= + 135.8 \text{ E}10 \text{ g/yr}$$

$$*(135.8 \text{ E}10 \text{ g/yr}) (.05) (5.4 \text{ kcal/g}) (4186 \text{ J/kcal})$$

$$= 1.5 \text{ E}15 \text{ J/yr}$$

Footnotes to Table 10,1 continued.

8. Earth flow*

Sediment inflow: 3 E6 tons/yr; sediment outflow into the North Sea: .25 E6 tons/yr; net input: 2.75 E6 tons/yr = 2.75 E12 gr/yr

9-12. Fuel flows and electricity

E15 J/yr

	Production	Import	Export	Gross consumption
Coal	—	220	60	164
Oil/petrol products	67	2938	1930	1436
Natural gas	2885	120	1732	1262
Electricity				
- conv.	210	1.8	2.9	205
- nuclear	15	—	—	15

Data: Central Bureau of Statistics 1981, The Hague.

13. Embodied energy/f ratio

1980; %1 = f 2.00 in 1980;

GNP : f 332340 E6 = \$ 166,170
 Import: f 152279 E6 = \$ 76,139
 Export: f 146860 E6 = \$ 73,430

Data: Central Bureau of Statistics 1981. For calculation see Table 10.3

*The Netherlands is part of a subsiding area of the globe. Sediment flows are considered instead of erosion and formation of earth.

Table 10.2. Energy storage in the Netherlands, 1980.

Foot-note	Item	Actual energy J/yr	ETR SEJ/J	Embodied energy SEJ/yr E20
1	Geothermal heat	8.0 E18	6055	484.4
2	Top soil	3.08 E19	62500	17219.0
3	Natural gas	7.8 E19	48000	37440.0
4	Crude oil	1.6 E18	53000	869.0
5	Wood	4.3 E17	6700	28.8
6	Geopotential of polderland	5.4 E13	23600	0.01
7	Fresh water	10.2 E16	41000	41.8

Footnotes to Table 10.2.

1. Geothermal heat

estimated potential of water in crust rock: 1/3 of the area, 1/2 utilizable layer of 100 meters; porosity 15%; temperature 100°C at 2000-3000 m.depth

$$20 \text{ years} \times 800 \text{ E15 J} \times .5 = 8000 \text{ E15 J}$$

Source: A.E.R. 1982.

2. Soil organic matter storage

area: 3.7 E10 m^2 ; volume: $1 \text{ E06 cm}^3/\text{m}^2$ (100 cm x 10.000 cm²)/cm²; density: 1.47 g/m^3 ; organic fraction: $.05 \text{ gC/g}$ (Stiboka 1980); $G = 5.4 \times 4186 \text{ J/g}$

$$(3.7 \text{ E10 m}^2) (.5 \text{ E6 cm}^3/\text{m}^2) (1.47 \text{ g/m}^3) (.05 \text{ gC/g})$$

$$(5.4 \times 4186 \text{ J/g}) = 5.08 \text{ E19 J}$$

3. Natural gas

reserves: 2326 E9 m^3 (A.E.R. 1982)

$$(2326.9 \text{ E9 m}^3) (33.5 \text{ E3 J/m}^3) = 7.7951 \text{ E19 J}$$

4. Crude oil

reserves: 56 E6 mtons CE (UN 1981)

$$(56 \text{ E6 mtons CE} \times 29.31 \text{ E9 J.m}^3) = 1.64 \text{ E18 J}$$

Footnotes to Table 10.2 continued.

5. Wood

area: $2.9 \text{ E}9 \text{ m}^2$ (CBS 1982); weight: $1 \text{ E}4 \text{ g/m}^2$ (estimate from Odum et al. 1981); energy content: 14651 J/g

$$(2.9 \text{ E}9 \text{ m}^2) (1 \text{ E}4 \text{ g/m}^2) (14651 \text{ J/g}) = 4.2488 \text{ E}17 \text{ J}$$

6. Geopotential of polderland

area: 30% of $3.7 \text{ E}10 \text{ m}^2$; weight factor: $1 \text{ E}-3 \text{ kg/g}$; average depth: 1 m; volume factor: $1 \text{ E}6 \text{ cm}^3/\text{m}^3$; gravity: 9.8 m/s^2 ; density for water: 1 gr/cm^3 ; height of center of gravity: $.5 \times 1 \text{ m} = .5 \text{ m}$

$$(.3) (3.7 \text{ E}10 \text{ m}^2) (1 \text{ m}) (1 \text{ E}6 \text{ cm}^3/\text{m}^3) (9.8 \text{ m}^2/\text{s}^2) (1 \text{ gr/cm}^3)$$

$$(.5) = 5.4 \text{ E}13 \text{ J}$$

7. Freshwater storage

(a) lakes

volume: 5 m (depth) x $450 \text{ E}06 \text{ m}^2 = 2200 \text{ E}6 \text{ m}^3$;
G: $138.8 \text{ /Cg e}(999900/965000)\text{J/g}$

$$(2200 \text{ E}6 \text{ m}^3) (1 \text{ E}6 \text{ g/m}^3) (4.93 \text{ J/g}) = 1.08 \text{ E}16 \text{ J}$$

(b) groundwater

volume land mass: $2 \text{ m} \times 3.7 \text{ E}10 \text{ m}^2 = 7.4 \text{ E}10 \text{ m}^3$; porosity fraction: .25

$$(7.4 \text{ E}10 \text{ m}^3) (.25) (1 \text{ E}6 \text{ g/m}^3) (4.93 \text{ J/g}) = 9.12 \text{ E}16 \text{ J}$$

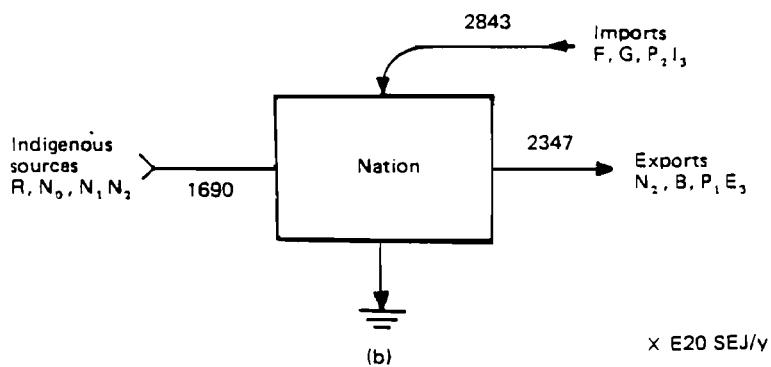
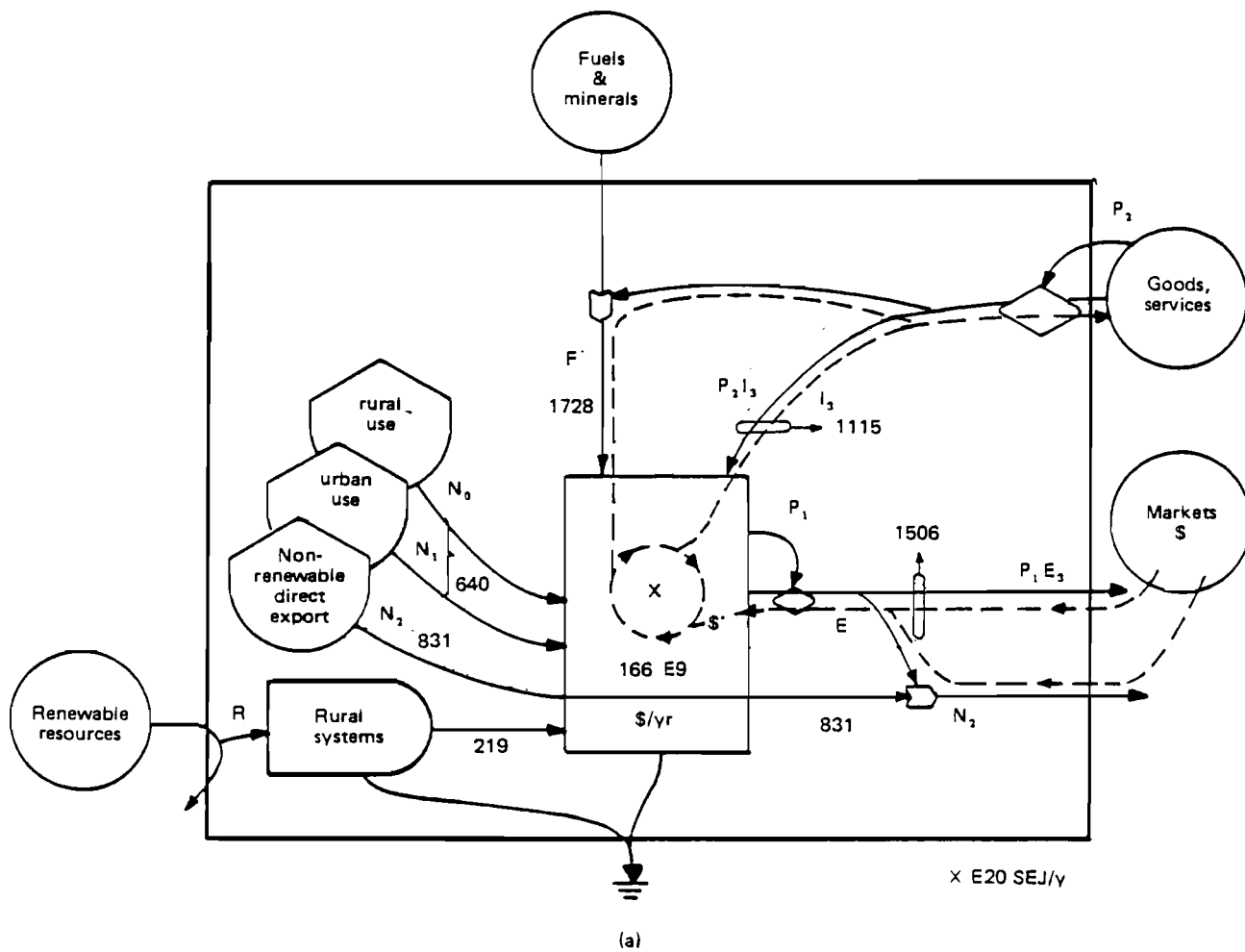

Figure 10.3. Summary diagrams of the embodied energy flows of the Netherlands. (a) main flows; (b) three-arm diagram.

Table 10.3. Summary of energy flows for the Netherlands.

Letter in Figure	Item	Embodied solar energy E20 SEJ/y	Dollars E9 \$/y
R	Renewable sources used, SEJ/yr	219	—
N	Nonrenewable sources flow within the country (SEJ/yr):		
	N ₀ Dispersed rural source (SEJ/yr)	0.9	—
	N ₁ Concentrated use (SEJ/yr)	640	—
	N ₂ Exported without use	831	—
F	Imported minerals and fuels (SEJ/yr)	1728	—
P ₂ I ₃	Imported goods and services (SEJ/yr)	1115	—
I	Dollars paid for total imports (\$/yr)	—	86
	Dollars paid for fuel imports (\$/yr)	—	18
E	Dollars obtained for exports (\$/yr)	—	84
	Dollars obtained for fuel exports (\$/yr):	—	16
P ₁ E ₃	Exported services (SEJ/yr)	1516	—
X	Gross National Product (\$/yr)	—	166
P ₂	Ratio embodied energy to dollar of imports (SEJ/\$) (US)	1.64 E12 SEJ/\$	
P ₁ *	Ratio embodied energy to dollar of country and for its exports (SEJ/\$)	2.23 E12 SEJ/\$	

$$\begin{aligned}
 * \\
 P_1 &= \frac{R + N_1 + I + P_2 I_3}{X} = \frac{(219 + 640 + 1728 + 1115) \text{ E20 SEJ/yr}}{166 \text{ E09 } \$/\text{yr}} \\
 &= \frac{3702 \text{ E20 SEJ/yr}}{166 \text{ E09 } \$/\text{yr}} = 2.23 \text{ E12 SEJ/} \$
 \end{aligned}$$

Discussion

Table 10.4 presents an overview of the energy basis of the Netherlands in the form of flow values, ratios between various flows, energy density indices and a carrying capacity index. The country imported 496 E20 SEJ more in 1980 than it exported. In money terms the difference is 2,709 million dollars. To calculate the embodied energy of the imported goods and services, the energy to dollar ratio of the United States for 1980 was used, given that most of the imported goods and services come from developed countries, and that except for West Germany (see Chapter 11), energy to dollar ratios of European Community countries are not yet available.

The ratios of energy input flows to energy use indicate that the Netherlands is very dependent on purchased energy. The three-arm diagram (Figure 10.3b) obscures this fact since the natural gas throughput flow (831 out of 1690 E20 SEJ) is included in the input flow. Only 23 percent of the energy used is from home sources, and only 6 percent is locally renewable. The carrying capacity index indicates that in the case that fuel availability decreases, only a small fraction of the present population could be sustained in the country, at least at the present standard of living.

This energy analysis has focused on the flows and storages at the national level. Various flows have been assessed in an indirect way, because energy transformation ratios are not yet available for all goods and products. Energy analyses of subsystems need to be carried out to produce these ETR's. Furthermore, given the mutual dependency of, for example, the European

Table 10.4. Indices.

Index Name	Expression	Value
1 Renewable embodied energy flow	R	219 E20 SEJ/yr
2 Indigenous nonrenewable flow	N	1471 E20 SEJ/yr
3 Imported embodied energy flow	$F+P_2 I_3$	2843 E20 SEJ/yr
4 Total embodied energy flow	$R+N+F+P_2 I_3$	4533 E20 SEJ/yr
5 Total embodied energy used	$R+N_1+F+P_2 I_3=U$	3702 E20 SEJ/yr
6 Total exported embodied energy	$B+P_1 E_3+N_2$	2347 E20 SEJ/yr
7 Import minus exports	$(F+P_2 J)-(N_2+B+P_2 E)$	496 E20 SEJ/yr
8 Ratio of exports to imports	$(N_2+P_1 E_3)-(N_2+B+P_2 I_3)$	0.83
9 Fraction used from home sources	$(N_0+N_1+R)/U$	0.23
10 Fraction used locally re	R/U	0.06
11 Fraction used that is purchased	$(F+P_2 I_3)/U$	0.77
12 Fraction used that is imported goods & services	$P_2 I_3/U$	0.30
13 Fraction used that is free	$(N_0+N_1+R)/U$	0.23
14 Ratio of concentrated to rural use	$(F+P_2 I_3+N_1)(R+N_0)$	15.9
15 Use per unit land area (A = 3.7 E10 m ²)	U/A	1000.5 E10 SEJ/m ² /y
16 Use per capita (C = 14 E06)	U/C	264.4 E14 SEJ/C/y
17 Renewable carrying capacity at present living standards	(R/U)*population	0.84 E06 people
18 Ratio of used embodied energy to GNP	$P_1 = U/GNP$	2.23 E12 SEJ/\$/yr
19 Fuel per capita	(All fuel used)/population	116 E14 SEJ/C/yr
20 Fraction electricity	Electricity/U	0.09

Community countries an energy study of the EC trade relationships may not only provide insights for policy but also produce actual energy to dollar ratios for the import flows.

ACKNOWLEDGMENTS

The energy analysis presented here was made in the summer of 1983 as part of the "energy overview of nations" project at the International Institute for Applied Systems Analysis (IIASA), Laxenburg, Austria.

The work was aided by an energy analysis of the Netherlands by T. de Jong for the year 1978, using earlier embodied energy analyses, procedures, and methods (Odum et al.1981), as a class project of the energy analysis course of H.T. Odum in Gainesville, Florida.

Acknowledgments are due to H.T. Odum and the energy analysis group for assistance and a stimulating time, to IIASA for supplying the working environment and facilities and to the Institute for Environmental Studies for material and moral support.

Gisela Bosch
*International Institute for Applied
Systems Analysis, Laxenburg, Austria*

Howard T. Odum
*Environmental Engineering Sciences,
University of Florida, Gainesville*

11. ENERGY ANALYSIS OVERVIEW OF THE FEDERAL REPUBLIC OF GERMANY (FRG)

Introduction

This is an energy analysis of the main energy flows of the Federal Republic of Germany (FRG), with its systems of nature and humanity and its interplay of renewable resources, indigenous non-renewable resources and imported resources that generate the economy. An aggregated diagram was used to represent totals for overall comparisons. Several ratios (outside-inside energy ratio, embodied energy trade ratio, etc.), were calculated to compare the FRG with other countries and to support predictions.

The FRG, a country in north western Europe, cuts across three of Europe's major east-west regions. In the south are the Alps, in the central part of the country is the Central Upland and in the north is the Northern Lowland. With the rest of western Europe, West Germany shares a temperate maritime climate.

There is a general air stream from west to east and an annual precipitation of 800 mm/y. In general winter temperatures decline eastward and southwards, in the latter case because of increased altitude (mean January temperature is 0°C). In summer temperatures decline from south to north with an average July temperature of 17°C.

In West Germany soil varies mostly in relation to local conditions of rock type. The soil of the Alps varies according to the height and degree of the slope but they tend to be shallow and stony. The best soils are found in the Central Uplands and the Alpine Foreland. Formerly covered with broadleaved forest they are now mostly cleared and provide fine grey-brown podzolic or brown forest soil. The sands of the Northern Lowland have been badly leached. Clay, humus and plant nutrients are washed out of the surface layers and are accumulated as a layer of hardpan, unfavorable to agriculture.

There is very little natural vegetation. In the higher and lower massifs of the Alps and the Central Uplands the beech forests merge upwards into a mixed forest of beech and silver fir and then into spruce. The better soils have been cleared for agriculture. On the poor sandsoils of the Northern Lowlands planted Scots pines and open heathland have replaced the original open oak forest. Today, out of the total area of West Germany (248,643 square km), 35.5 percent is cropland, 79.4 percent is forest, 24.2 percent is pastureland and the rest is for urban use, transportation and other minor things. The land-use is shown in Figure 11.1 (Collier 1981). In 1937, 39.6 million people lived in the area of the FRG. Because of massive immigration

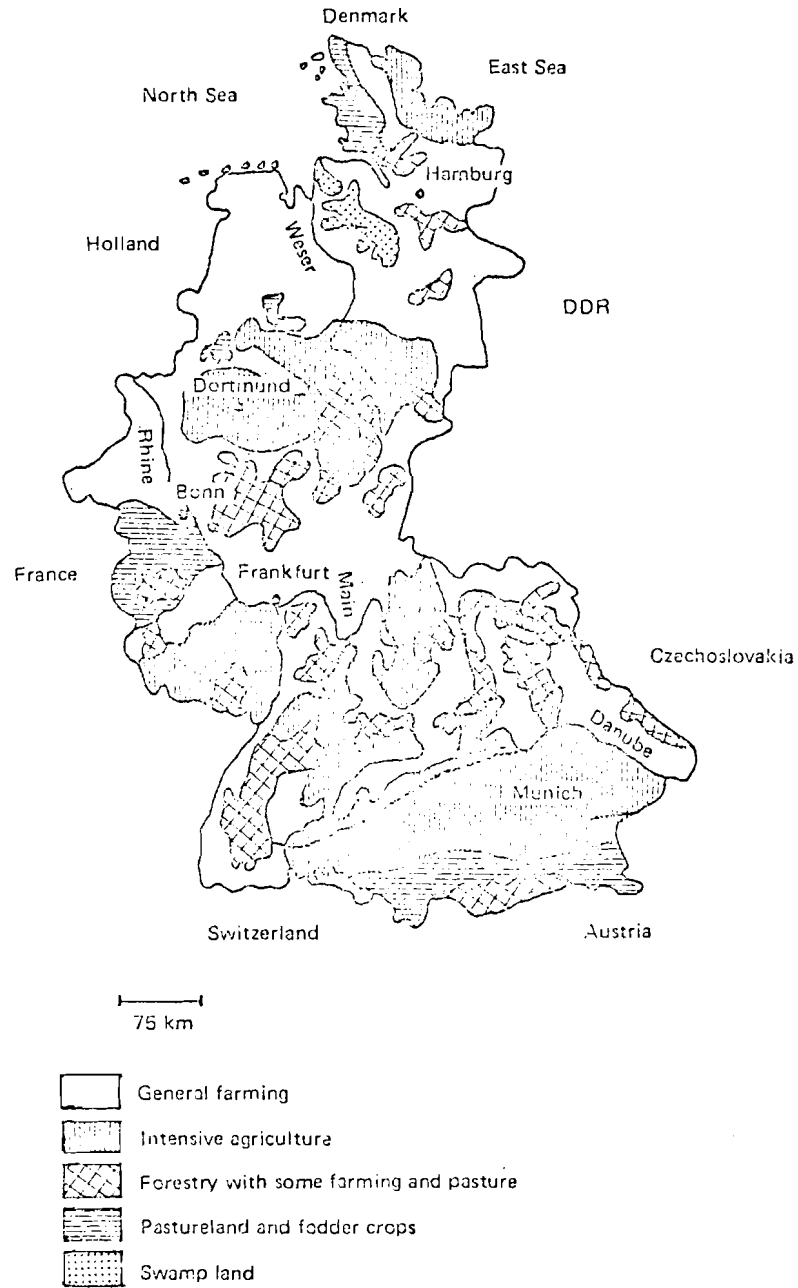
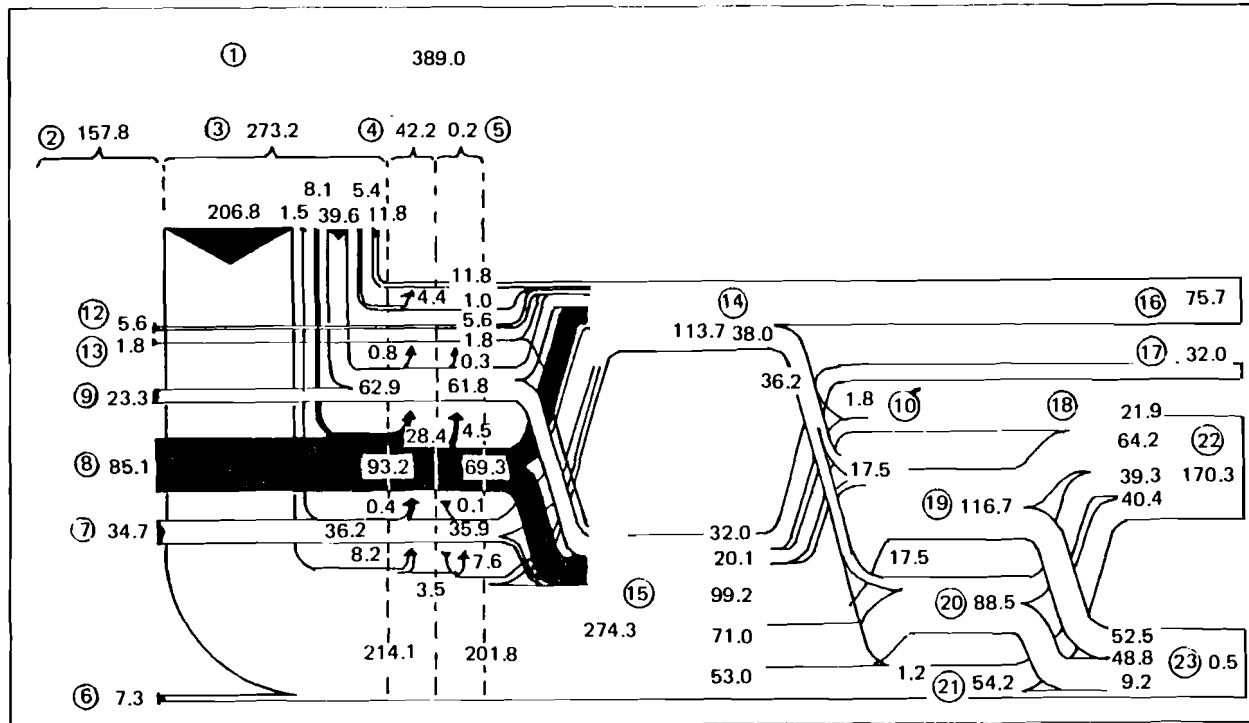

Figure 11.1. Land uses in West Germany (modified from Collier 1981).



E6 T coal equivalents per year

1 - primary energy use, 2 - indigenous energy sources, 3 - exogenous energy sources, 4 - export, net removal out of energy stocks, 6 - crude oil, 7 - lignite, 8 - stone coal, 9 - gas, 10 - electricity, 11 - nuclear energy, 12 - hydroelectric energy, 13 - remaining energy, 14 - energy sources for electricity production, 15 - energy sources for final use, 16 - energy industry fuel use and loss, 17 - nonenergetic use, 18 - energy use for conversion, 19 - household and small users, 20 - industry, 21 - transport, 22 - energy loss, 23 - used energy

Figure 11.2. Energy flow (primary and electricity) of West Germany (Jahrbuch fuer Bergbau 1982/83).

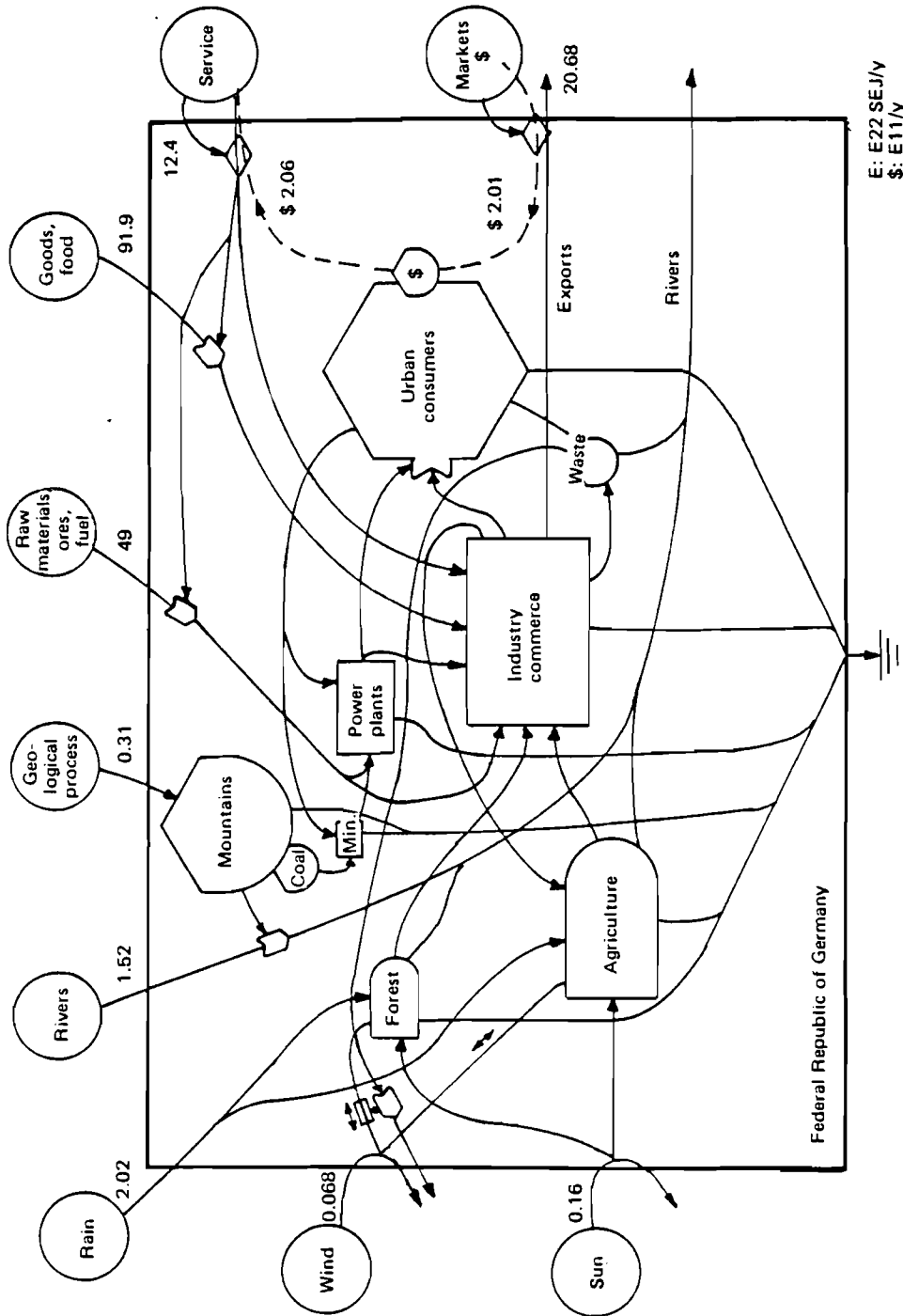

Figure 11.3. Overall energy diagram of the Federal Republic of Germany.

(refugees after the World War II and foreign workers in the 60's) the population increased up to 61.5 million people. This results in an average population density of 248 people/square km, which is unevenly distributed. 75 percent of the people live in cities, 22 percent live in the 20 biggest cities (> 250,000 inhabitants). By 1980 4.4 million foreign people immigrated.

West Germany is a member of the European Economic Community (EEC) and with about 50 percent of the total export the other countries of the EEC are the most important trading partners. Other main purchasers of exports are the USA, Switzerland, Australia and Sweden. Previous efforts to overview energy flows in West Germany included only the web of fuels and electricity (Figure 11.2).

In this chapter, energies of environment, services and trade are included, representing all flows and reserves in embodied solar equivalents (Figure 11.3).

Methods

The procedures and methods used were those given in Part I, sections 1 to 5. After an energy diagram was drawn (Figure 11.3) the actual energy storages and flows were estimated and multiplied by the energy transformation ratios (Table 11.1). This calculation converts all storages and flows in embodied solar-equivalent Joules (SEJ) which allows the comparison and evaluation of the different storages and flows.

Most data (1979) were derived from the following references: Statistisches Jahrbuch 1981 fuer die Bundesrepublik Deutschland; and

Jahrbuch fuer Bergbau, Energie, Mineraloel and Chemie 1982/83. The introduction is an abstract from Collier's Encyclopedia (1981). The water budget of the nation was found to be important to embodied energy calculations. See water budget given by Keller (1972).

The unit of currency in the FRG is the Deutsche Mark. In 1980 the UN exchange rate was 1.959 DM/\$. This exchange rate was used in the whole report despite the fact that all the data are from 1979, because in 1979 the exchange rate was exceptionally low (1.73 DM/\$) and has not been experienced before or since.

Results

The energy flows of importance are summarized in Table 11.1 and the storages are listed in Table 11.2. Then in Table 11.3 flows are aggregated with care to avoid double counting with the help of the overview diagram in Figure 11.4. It includes outside energy sources, storages and energy uses, industries and predominantly human systems. Finally, various indices of the energy and economic relationships are calculated in Table 11.4.

Since the embodied solar energy in the chemical potential in rain is larger than any of the other solar based sources, it includes all other environmental flows, which are by-products. For further calculations it was used as the country's outside renewable energy flow.

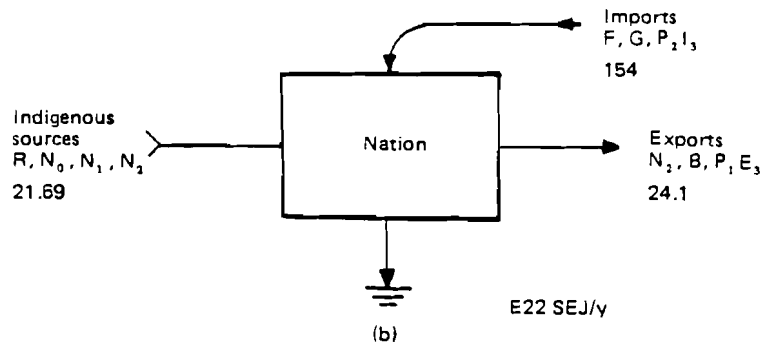
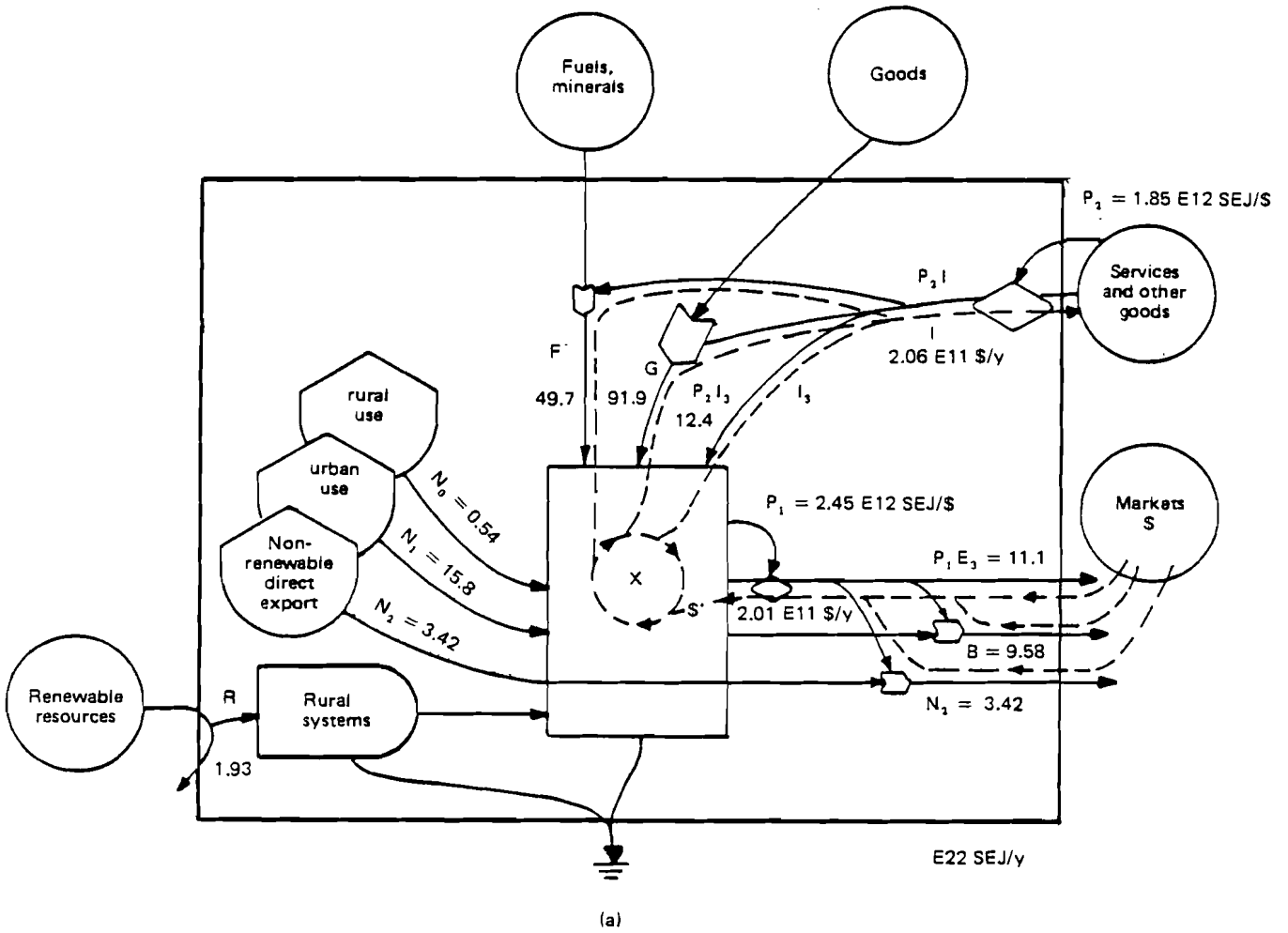

Figure 11.4. Aggregated overview of the Federal Republic of Germany. (a) diagram for Tabel 11.3; (b) further aggregation in the form of a three-arm diagram.

The net loss of weathered rock and other matter (earth) as well as topsoil was calculated. Compared with the storage of topsoil this loss is not severe.

The FRG has very little mineral and fuel resources. The only exception is coal of very high quality, which can even be exported, despite its extensive use in the iron and steel industry. Apart from that the FRG has to import most of the fuel and minerals it needs to maintain its highly developed industrial production. The imported items with the largest quantities of embodied solar equivalents were aluminium, crude oil and phosphate. Most of the electricity demand was met by thermal plants which run either on oil, coal or gas. 8 percent of the total production came from nuclear plants and 5 percent from hydroelectric power stations.

About half of all exports were accounted for by machinery and transportation equipment as well as basic manufactured items like iron, steel and chemicals. The main imports were machinery, oil and oil-products, natural gas (in increasing quantities since 1980), and food and clothing.

Of the West Germany workforce, 45 percent were employed in industry; followed by banking, insurances and other services, with 31.8 percent; and commerce transportation and communication with 17 percent. About 5 percent of the workforce were working in the agricultural field. As in all other western countries, the unemployment rate has risen sharply in the mid 1970s. By the beginning of 1983 it was over 2 million people or nearly 9

percent of the total workforce. The income per capita derived by dividing the GNP by the number of capita, was 11,614 \$/y in 1979.

Energy/Dollar Ratio

The energy/dollar ratio (Figure 11.3 and Table 11.4) for the FRG in 1979 was calculated from the chemical potential energy of rain, nonrenewable indigenous resources, used within the country, imported fuels, minerals, goods and services, and the Gross National Product (GNP). The FRG energy/dollar ratio in 1979 was 2.45 E12 SEJ/\$, about 30 percent higher than the US (1.85 E12 SEJ/\$). This suggests that for every dollar that an importer paid the FRG for its products, he received 30 percent more embodied energy than that dollar would buy in the US.

Energy Evaluation of the Trade Balance

The embodied energy in international trade is given in Figure 11.4b. The embodied energy of the imports and exports were calculated from the energy flow of the minerals, fossil fuels and goods, added to the service energy (labor, paid in dollars) multiplied by the energy/dollar ratio of the USA (Table 11.3). The German economy is highly export oriented. Despite this fact the money balance of payments shows a 5 billion dollar deficit. In 1979, \$2.01 E11 were received for exports, but \$2.06 E11 had to be spent on imports. On an embodied energy basis, however, the trade ratio shows a huge net gain: imports were 6.4 times the exports.

Table 11.1. Energy flows of the FRG.

Foot-note	Type of energy	Actual energy J/y	ETR SEJ/y	Embodied solar energy E22 SEJ/y
1	Direct sunlight	1.64 E21	—	0.164
2	Rain			
	- chemical potential	1.25 E18	15444	1.93
	- geopotential	1.12 E17	8888	0.099
3	Rivers			
	- chemical potential	8.67 E15	41068	0.036
	- geopotential	6.20 E17	23564	1.46
4	Wind kinetic	1.03 E18	663	0.068
5	Net loss of soil			
	- earth	1.8 E12 kg/y	1.71 E9 SEJ/g	0.308
	- topsoil	3.76 E16	6.25 E4	0.235
6	Goods used in reaction with oxygen (import-export)	1.58 E17	*	2.04
7	Goods used whose value is in its concentration (import-export)			
	- phosphate	1.47 E15	4.14 E7	6.08
	-(NH ₄) ₂ SO ₄	-8.44 E15	1.69 E6	-1.43
	- cement	-0.11 E15	—	—
	- NaCl	-2.16 E12	—	—
	- Fe-ore	1.65 E15	6.02 E7	9.93
	- Raw Fe and steel	-3.7 E10	10.11 E6	-3.74 E17
	- refined Fe and steel	-6.51 E14	1.84 E7	-1.20
	- Cu-ore	1.82 E12	—	—
	- Cu and Cu-products	6.8 E13	—	—
	- Bauxite	2.39 E14	1.32 E7	0.315
	- Al and Al-products	5.6 E13	1.63 E10	91.3
8	Machines	-6.87 E14	6.94 E7	-4.768
9	Chemical products	1.85 E17	3.45 E4 **	0.621
10	Coal			
	- import-export	-5.47 E17	3.98 E4	-2.18
	- exported	8.59 E17	3.98 E4	3.42
	- used	3.98 E18	3.98 E4	15.8
11	Oil import	5.04 E18	5.30 E4	26.7
12	Natural gas import	1.40 E18	4.8 E4	6.7
13	Electricity			
	- import	2.26 E15	15.9 E4	0.036
	- used	1.13 E18	15.9 E4	17.97
	- output of nuclear plants	9.1 E16	15.9 E4	1.45

*See Footnote 6.

**ETR: 2/3 of oil ETR

Footnotes to Table 11.1.

1. Direct sunlight

Area: 248,643 km² (Statistisches Jahrbuch 1981 f.d. FRG)
 Shelf area: 58,535 km² (estimated)
 Total area: 307,178 km² = 307,178 E6 m²
 Sunlight on the surface: 110 kcal/cm²/y (Odum et al. 1983)
 Albedo: 14%
 Annual radiation: $\frac{1.0 \cdot 110 \text{ kcal/cm}^2/\text{y}}{0.86} = 127.9 \text{ kcal/cm}^2/\text{y}$
 $= 1.279 \text{ E6 kcal/m}^2/\text{y}$

2a. Rain—chemical potential

Annual evapotranspiration of rain water: 0.825 m/y (Keller, 1972)
 Total area: 307,178 E6 m²
 Gibbs free energy: 4.94 J/g
 $(0.825 \text{ m/y}) (307178 \text{ E6 m}^2) (4.94 \text{ J/g}) (1 \text{ E6 g/m}^3)$
 $= 1.25 \text{ E18 J/y}$

2b. Rain—geopotential

Run-off: 0.355 m/y (Keller, Water Balance in the FRG, Figure 11.2)
 Mean elevation: 130 m (Kemp 1981)
 Area: 248,643 E6 m²
 $(\text{area}) (\text{mean elevation}) (\text{run-off}) (\text{density}) (\text{gravity})$
 $(2.48 \text{ E11 m}^2) (130 \text{ m}) (0.355 \text{ m/y}) (1 \text{ E3 kg/m}^3) (9.8 \text{ m/s}^2)$
 $= 1.12 \text{ E17 J/y}$

3a. Rivers—chemical potential

Incoming rivers: 0.332 m/y (Keller 1972)
 Run-off: 0.296 m/y
 Total run-off: 0.628 m/y
 Dissolved solids: 0.41 E3 g/l (Internationale Kommission zum Schutze des Rheins gegen Verschmutzung 1979)
 Gibbs free energy: $\frac{(8.33 \text{ J/mol/deg}) (300^\circ\text{C})}{18 \text{ g/mol}} \log_e \frac{(1 \text{ E6}^{-10})}{(1 \text{ E6}^{-410})}$
 $= 5.55 \text{ E-2 J/g}$
 $(\text{total run-off}) (\text{area}) (\text{density}) (G)$
 $(0.628 \text{ m/y}) (2.48 \text{ E11 m}^2) (1 \text{ E6 g/m}^2) (5.55 \text{ E-2 J/g}) = 8.67 \text{ E15 J/y}$

Footnotes to Table 11.1 continued.

3b. Rivers-geopotential

Outflow volume and altitude

Rhine:	7.8 E10 m ³ /y	;	381 m	(Showers 1973;
Danube:	4.4 E10 m ³ /y	;	580 m	Michelin 1982)
Ims	2.3 E10 m ³ /y	;	213 m	
Elbe	2.2 E10 m ³ /y	;	22 m	
Weser-Werra	1.05 E10 m ³ /y	;	163 m	
Main	0.315 E10 m ³ /y	;	237 m	

(flow volume) (height of entry-egress) (density) (gravity)

Rhine

$$(7.8 \text{ E10 m}^3/\text{y}) (381 \text{ m}) (1 \text{ E3 kg/m}^3) (9.8 \text{ m/sec}^2) = 2.9 \text{ E17 J/y}$$

Danube

$$(4.4 \text{ E10 m}^3/\text{y}) (580 \text{ m}) (1 \text{ E3 kg/m}^3) (9.8 \text{ m/sec}^2) = 2.5 \text{ E17 J/y}$$

Ims

$$(2.3 \text{ E10 m}^3/\text{y}) (213 \text{ m}) (1 \text{ E3 kg/m}^3) (9.8 \text{ m/sec}^2) = 0.48 \text{ E17 J/y}$$

Elbe

$$(2.2 \text{ E10 m}^3/\text{y}) (22 \text{ m}) (1 \text{ E3 kg/m}^3) (9.8 \text{ m/sec}^2) = 0.047 \text{ E17 J/y}$$

Weser-Werra

$$(1.05 \text{ E10 m}^3/\text{y}) (163 \text{ m}) (1 \text{ E3 kg/m}^3) (9.8 \text{ m/sec}^2) = 0.168 \text{ E17 J/y}$$

Main

$$(0.315 \text{ E10 m}^3/\text{y}) (237 \text{ m}) (1 \text{ E3 kg/m}^3) (9.8 \text{ m/sec}^2) = 0.073 \text{ E17 J/y}$$

$$6.2 \text{ E17 J/y}$$

4. Wind energy

Wind speed (v): 4.20 cm/sec (H.E. Landsberg 1977)

Total area (A): 307,178 E10 cm²

Height (d): 1 E4 cm

Density (air) (p): 1.2 E-3 g/cm³

Eddy diffusion coefficient (c_e): 1 E4 cm²/sec

Wind energy: 1/2 p v² A c_e 1/d

$$\frac{(1/2) (1.2 \text{ E-3 g/cm}^3) (420 \text{ cm/sec})^2 (307178 \text{ E10 cm}^2)}{1 \text{ E4 cm}} \left(\frac{1 \text{ E4 cm}^2/\text{sec}}{1 \text{ E4 cm}} \right)$$

$$= 3.25 \text{ E17 g cm}^2/\text{sec}^3 = 1.03 \text{ E18 J/y}$$

Footnotes to Table 11.1 continued.

5a. Net loss of soil—earth

Erosion: 9.6 E9 kg/y (Snead 1980)
Formation rate: 31.2 E-3 kg/m²/y (Table 2.1)
Area of Germany: 248643 E6 m²

(erosion outflow)-(formation rate)(area of country)

$$(9.6 \text{ E9 kg/y}) - (31.2 \text{ E-3 kg/m}^2/\text{y}) (248643 \text{ E6 m}^2) = 1.8 \text{ E9 kg/y}$$

5b. Net loss of soil—top soil

Farmed land: 89.1% ; 221541 E6 m²
Erosion rate: 250 g/m²/y (Table 2.1, same as for the pacific states)

W. Germany does not have any successional area

(farmed land)(erosion rate)

$$(221541 \text{ E6 m}) (250 \text{ g/m}^2/\text{y}) = 5.54 \text{ E13 g/y}$$

$$(5.54 \text{ E13 g/y}) (0.03 \text{ organic}) (5.4 \text{ kcal/g}) (4186 \text{ J/kcal})$$

$$(5.54 \text{ E13 g/y}) (0.03 \text{ organic}) (5.4 \text{ kcal/g}) (4186 \text{ J/kg})$$

$$= 3.76 \text{ E16 J/y}$$

6. Goods used in reaction with oxygen (Statistisches Jahrbuch 1981 f.d. FRG):

Import 1979

live animals, meat and meat products: 1.233 E6 kg
fish: 649 E6 kg
dairy (1/2 milk, 1/2 cheese): 543 E6 kg
grains: 5247 E6 kg
wood: 9969 E6 kg

Export 1979

live animals, meat and meat products: 813 E6 kg
fish: 202 E6 kg
dairy (almost all milk): 2511 E6 kg
grains: 2063 E6 kg
wood: 1959 E6 kg

Import-Export 1979

live animals, meat and meat products: 420 E6 kg
fish: 447 E6 kg
dairy: -1968 E6 kg
grains: 3184 E6 kg
wood: 8010 E6 kg

Footnotes to Table 11.1 continued.

Actual energy: (Burnett 1978, Fluck and Baird 1980)

beef: 15.8 E6 J/kg
 fish: 4.3 E6 J/kg
 milk: 2.7 E6 J/kg
 cheese: 13.5 E6 J/kg
 grain: 13.9 E6 J/kg
 lumber: 13.8 E6 J/kg

Actual joules:

beef:	(420 E6 kg) (15.8 E6 J/kg)	=	6.6 E15 J/y
fish:	(447 E6 kg) (4.3 E6 J/kg)	=	1.9 E15 J/y
milk:	(271 E6 kg) (2.7 E6 J/kg)	=	0.7 E15 J/y
	-(2511 E6 kg) (2.7 E6 J/kg)	=	-6.8 E15 J/y
cheese:	(271 E6 kg) (13.5 E6 J/kg)	=	3.7 E15 J/y
grain:	(3184 E6 kg) (13.9 E6 J/kg)	=	44.3 E15 J/y
lumber:	(8010 E6 kg) (13.8 E6 J/kg)	=	108.1 E15 J/y
			<hr/>
			158.5 E15 J/y

ETR (food): 6.84 E4
 ETR (hard wood): 3.08 E5
 ETR (soft wood): 6.72 E3 } 1.57 E5

$$(50.4 \text{ E15 J/y}) (6.84 \text{ E4 SEJ/J}) = 3.45 \text{ E21 SEJ/y}$$

$$(108.1 \text{ E15 J/y}) (1.57 \text{ E5 SEJ/J}) = \frac{16.97 \text{ E21 SEJ/y}}{20.42 \text{ E21 SEJ/y}}$$

7. Goods used, whose value is in its concentration (Statistisches Jahrbuch f.d. FRG 1981)

Phosphate:

import: 9.752 E5 t/y
 export: 0.547 E5 t/y

import-export:

 9.205 E5 t/y

Actual energy (Appendix A6): 1.6 E9 J/t

$$(9.205 \text{ E5 t}) (1.6 \text{ E9 J/t}) = 1.47 \text{ E15 J/y}$$

(NH₄)₂ SO₄

import: 2.319 E6 t/y
 export: 2.900 E6 t/y

import-export

 -0.581 E6 t/y

Actual energy (Slessor and Lewis 1979): 14.5 E9 J/t

$$(-0.581 \text{ E6 J/y}) (14.5 \text{ E9 t/y}) = 8.42 \text{ E15 J/y}$$

Footnotes to Table 11.1 continued.

Cement:

import: 3.727 E6 t/y
export: 4.358 E6 t/y

import-export: -0.631 E6 t/y

actual energy (Slesser and Lewis 1979): 0.18 E9 J/t

$$(-0.631 \text{ E6 t/y}) (0.18 \text{ E9 J/t}) = 0.11 \text{ E15 J/y}$$

Nacl:

import: —
export: -2499300 t/y

import-export: -2499300 t/y

$$\begin{aligned} \text{actual energy: } G &= \frac{(8.33 \text{ J/mol/deg}) (300^\circ\text{C})}{40 \text{ g/mol}} \log_e \frac{999980}{1} \\ &= 8.63 \text{ E5 J/kg} \end{aligned}$$

$$(-2,499,300 \text{ E3 kg/y}) (8.63 \text{ E5 J/kg}) = -2.16 \text{ E15 J/y}$$

Fe-ore:

import: 52 E6 t/y
export: 2.9 E6 t/y

import-export: 49.1 E6 t/y

actual energy (extrapolated from Gilliland et al. 1978):
3.37 E7 J/t

$$(49.1 \text{ E6 t/y}) (3.37 \text{ E7 J/t}) = 1.65 \text{ E15 J/y}$$

Raw Fe and steel:

import: 0.27 E3 t/y
export: 0.68 E3 t/y

import-export -0.41 E3 t/y

actual energy (extrapolated from Gilliland et al. 1978):
90.4 E6 J/t

$$(-0.41 \text{ E3 t/y}) (90.4 \text{ E6 J/t}) = 3.7 \text{ E10 J/t}$$

Refined Fe and Steel:

import: 14.7 E6 t/y
export: 21.9 E6 t/y

import-export: -7.2 E6 t/y

actual energy (extrapolated from Gilliland et al. 1978):
90.4 E6 J/t

$$(-7.2 \text{ E6 t/y}) (90.4 \text{ E6 J/t}) = 6.51 \text{ E14 J/y}$$

Footnotes to Table 11.1 continued.

Cu-ore:
import: 1.1 E6 t/y
export: 1.0 E4 t/y

import-export: 1.1 E6 t/y
actual energy (Lavine and Butler 1982): 1.65 E6 J/t
(1.1 E5 t/y) (1.65 E6 J/t) = 1.815 E12 J/y

Cu-products:
import: 0.9 E6 t/y
export: 0.5 E6 t/y

import-export: 0.4 E6 t/y
actual energy (Lavine and Butler 1982): 1.7 E8 J/t
(0.4 E6 t/y) (1.7 E8 J/t) = 6.8 E13 J/y

Bauxite:
import: 3.7 E6 t/y
export: 2.1 E4 t/y

import-export: 3.67 E6 t/y
actual energy (Lavine and Butler 1982): 6.5 E7 J/t
(3.67 E6 t/y) (6.5 E7 J/t) = 2.39 E14 J/y

Al and Al-products:
import: 0.88 E6 t/y
export: 0.60 E6 t/y

import-export: 0.28 E6 t/y
actual energy (Lavine and Butler 1982): 2.0 E8 J/t
(0.28 E6 t/y) (2.0 E8 J/t) = 5.6 E13 J/y

8. Iron and steel end-products (machines)

import: 5.7 E6 t/y
export: 13.3 E6 t/y

import-export: -7.6 E6 t/y
actual energy (see App. 13 Table 13c): 90.4 E6 J/t
(-7.6 E6 t/y) (90.4 E6 J/t) = -6.87 E14 J/y

Footnotes to Table 11.1 continued.

9. Chemical products

import:	9.9 E6 t/y
export:	3.27 E6 t/y
	<hr/>
import-export:	6.63 E6 t/y
actual energy (Odum et al. 1983):	27.9 E9 J/t
(6.63 E6 t/y) (27.9 E9 J/t) = 1.85 E17 J/y	

10. Coal

Stone-coal:	
import:	8.91 E6 t/y
export:	27.59 E6 t/y
	<hr/>
import-export	-18.68 E6 t/y
actual energy (Statistisches Jahrbuch f.d. FRG):	30.65 E9 J/t
(-18.68 E6 t/y) (30.65 E9 J/t) = -5.73 E17 J/y	

Lignite:	
import:	2.44 E6 t/y
export:	0.82 E6 t/y
	<hr/>
import-export	1.62 E6 t/y
actual energy (Statistisches Jahrbuch f.d. FRG):	16.26 E9 J/t
(1.62 E6 t/y) (16.26 E9 J/t) = 0.26 E17 J/y	

Stone coal	-5.73 E17 J/y
+	
Lignite	+0.26 E17 J/y
	<hr/>
	-5.47 E17 J/y

Coal export:

stone-coal	27.59 E6 t/y
actual energy (30.65 E9 J/t)	(27.59 E6 t/y) = 8.46 E17 J/y
lignite	0.82 E6 t/y
actual energy (16.26 E9 J/t)	(0.82 E6 t/y) = 0.133 E17 J/y
	<hr/>
total export of coal:	8.593 E17 J/y

Footnotes to Table 11.1 continued.

Coal used inside

stone coals:	65.7	E6	t/y	
lignite:	121.3	E6	t/y	
actual energy (stone coal)	30.65	E9	J/t	
actual energy (lignite)	16.26	E9	J/t	
(65.7 E6 t/y) (30.65 E9 J/t) =	2.01	E18	J/y	
(121.3 E6 t/y) (16.26 E9 J/t) =	1.97	E18	J/y	
	<hr/>			
	3.98	E18	J/y	

11. Crude oil

import:	1.12	E8	t/y	
export:	—			
actual energy (Table 2.1):	4.5	E10	J/t	
(1.12 E8 t/y) (4.5 E10 J/t) =	5.04	E18	J/y	

12. Natural gas

import:	39717	E6	m ³ /y	
export:	—			
actual energy (Stat. Jahrbuch f.d. FRG):	35169	E3	J/m ³	
(3.97 E10 m ³ /y) (3.5 E7 J/m ³) =	1.40	E18	J/y	

13. Electricity

import:	2.264	E15	J/y	
inside use:	1.13	E18	J/y	
output of nuclear plants:	9.1	E16	J/y	

Table 11.2. Energy storages of the FRG.

Foot-note	Type of energy	Actual energy J	Energy Transfor. Ratio (ETR) SEJ/J	Embodied solar energy E23 SEJ/y
1	Coal reserves	7.32 E21	3.98 E4	2900.
2	Plant biomass	1.64 E16	1.76 E4	0.003
3	Water & groundwater chemical potential	1.97 E19	41068	8.09
4	Topsoil	7.05 E19	6.25 E4	44.

Footnotes to Table 11.2.

1. Coal reserves

Stone-coal reserves (Jahrbuch f. Bergbau 1982/83) 230 200 E6 t
 Actual energy (Statist. Jahrbuch f. FRG) 29.89 E9 J/t
 (230 300 E6 t) (29.89 E9 J/t) = 6.88 E21 J

Lignite reserve (Jahrbuch f. Bergbau 1982/83) 55000 E6 t
 Actual energy (Statist. Jahrbuch f. FRG) 8.08 E9 J/t
 (55 000 E6 T) (8.08 E9 J/t) 0.44 E21 J
 Total coal reserves 7.32 E21 J

2. Plant biomass (chemical potential)

Land use (Collier 1981)

35.5% crop land 8.8 E4 km²
 29.4% forest 7.3 E4 km²
 24.2% pasture land 6.0 E4 km²
 10.9% urban, transportation 2.7 E4 km²

Actual energy (Whittaker 1975):

	Net primary production t/km ² /y	Combustion E10 J/t	Land use E4 km ²	Actual energy J/y
Cultivated land	0.65	1.72	8.8	9.8 E14
Warm temperate mixed forest	0.50	1.97	7.3	7.2 E14
Temperate grassland	1.0	1.67	6.0	10.0 E14

Footnotes to Table 11.2 continued

Turnover time for warm temperate mixed forest	20 y
Actual energy production per year	7.2 E14 J/y
(7.2 E14 J/y) (20 y)	= 1.44 E16 J
Total organic matter	
Cultivated land (turnover time = 1 year)	9.8 E14 J
Warm temperate mixed forest (turnover time = 20 years)	1.44 E16 J
Temperate grassland (turnover-time = 1 year)	10.0 E14 J
	<hr/>
	1.69 E16 J

3. Groundwater, chemical potential

Estimated volume of ground water:

(depth) (area) (porosity)

$$(100 \text{ m}) (248 \ 643 \ \text{E}6 \ \text{m}^2) (0.16) = 3.98 \ \text{E}12 \ \text{m}^3$$

$$G = \frac{(8.33 \ \text{J/mol/deg}) (300^\circ\text{C})}{(18 \ \text{g/mol})} \log_e \frac{(1 \ \text{E}6 - 10)}{(965 \ 000)}$$

$$= 4.94 \ \text{J/g}$$

(volume) (density) (G)

$$(3.98 \ \text{E}12 \ \text{m}^3) (1 \ \text{E}6 \ \text{g/m}^3) (4.94 \ \text{J/g}) = 1.97 \ \text{E}19 \ \text{J}$$

4. Topsoil

Areas in Footnote 2; organic content, Brady (1974)

(7.3 E6 ha forest) (176 E6 g org./ha) (5.4 kcal/g) (4186 J/kcal)

$$= 2.90 \ \text{E}19 \ \text{J}$$

(16.1 E6 ha Agric.) (114 E6 g org./ha) (5.4 kcal/g) (4186 J/kcal)

$$= 4.15 \ \text{E}19 \ \text{J}$$

$$\text{Total: } (2.90 + 4.15) \ \text{E}19 \ \text{J}$$

Table 11.3. Summary flows for West Germany in Figure 11.4.

Letter in Figure	Item	Embodied Solar Energy E22 SEJ/y	Dollars E9 \$/y
R	Renewable sources used, SEJ/yr (rain, chem.)	1.93	
N	Nonrenewable sources flow within the country (SEJ/yr):		
	-N ₀ dispersed rural source (SEJ/yr)	0.54	
	-N ₁ concentrated use (SEJ/yr)	15.8	
	-N ₂ exported without use (iron)	3.42	
F	Imported minerals & fuels (SEJ/yr)	49.7	
G	Imported goods (SEJ/yr)	91.9	
P ₂ I ₃	Imported service (SEJ/yr)	12.4	
I	Dollars paid for imports (\$/yr)		206.0
E	Dollars paid for exports (\$/yr)		201.1
P ₁ E ₃	Exported services (SEJ/yr)	11.1	
B	Exported products, transformed within the country (SEJ/yr) (rubber, wood)	9.58	
X	Gross National Product (\$/yr)		715.0
P ₂	Ratio embodied energy to dollar of imports (SEJ/\$) (US)	1.85 E12 SEJ/\$	
P ₁	Ratio embodied energy to dollar of country & for its exports (SEJ/\$)	2.45 E12 SEJ/\$	

Footnotes for Table 11.3.

R Chemical potential energy is the largest renewable source (Table 11.1.): 1.93 E22 SEJ/y.

-N₀ Net loss of earth and soil is the dispersed rural source (Table 11.1.): 0.54 E22 SEJ/y.

-N₁ Coal use within West Germany (Table 11.1.): 15.8 E22 SEJ/y

-N₂ Coal export (Table 11.1.): 3.42 E22 SEJ/y

F Imported minerals and fuels (Table 11.1.):

Iron ore	9.93	E22	SEJ/y
Bauxite	0.33	E22	SEJ/y
Phosphate	6.08	E22	SEJ/y
Gas	6.7	E22	SEJ/y
Oil	<u>26.7</u>	E22	SEJ/y
	49.74	E22	SEJ/y

G Imported goods (Table 11.1.):

Aluminum	91.3	E22	SEJ/y
Chemical products	0.6	E22	SEJ/y
Electricity	<u>0.036</u>	E22	SEJ/y
	91.936	E22	SEJ/y

$P_2 I_3$ $I_3 = \$$ paid for imported service (1979) (Statistisches Jahrbuch f.d. FRG 1981):

$$131743 \text{ E6 DM/y} = 67 \text{ E9 \$/y}$$

$$P_2 I_3 = (1.85 \text{ E12 SEJ/\$}) (67 \text{ E9 \$/y})$$

$$= 1.24 \text{ E23 SEJ/y}$$

I \$ paid for imports (1979) (Statistisches Jahrbuch f.d. FRG, 1981) 206 E9 \$/y

E \$ paid for exports (1979) (Statistisches Jahrbuch f.d. FRG, 1981) 201 E9 \$/y

$P_1 E_3$ $E_3 = \$$ received for exports (1979) (Statistisches Jahrbuch f.d. FRG 1981): 89 092 E6 DM/y = 45478 E6 \$/y

$$P_1 E_3 = (2.45 \text{ E12 SEJ/\$}) (45 \text{ 478 E6 \$/y})$$

$$= 1.11 \text{ E23 SEJ/y}$$

B Exported products transformed within the country (Table 11.1):

$(\text{NH}_4)_2 \text{SO}_4$	1.43	E22	SEJ/y
refined iron & steel	1.20	E22	SEJ/y
machines	4.77	E22	SEJ/y
coal	<u>2.18</u>	E22	SEJ/y
	9.58	E22	SEJ/y

Footnotes for Table 11.3. continued

X Gross National Product (1979) (Stat. Jahrbuch f.d. FRG 1981):
 715 E9 \$/y

P₂ US energy/\$ ratio (Appendix A4): 1.85 E12 SEJ/\$

P₁ Energy/\$ ratio

$$P_1 = \frac{R + N_0 + N_1 + F + G + P_2 I_3}{X}$$

$$= \frac{(1.93 + 1.63 + 15.8 + 49.03 + 91.9 + 15.9) \text{ E22 SEJ/y}}{715 \text{ E9 } \$/y}$$

$$= 2.41 \text{ E12 SEJ/\$}$$

Table 11.4. Indices using embodied energy for overview of West Germany.

Item	Name of index and expression, see Figure 6.6	
1	Renewable embodied energy flow	R 1.93 E22 SEJ/y
2	Flow from indigenous non-renewable reserves	N 19.76 E22 SEJ/y
3	Flow of imported embodied energy	$F+G+P_2 I_3$ 153.3 E22 SEJ/y
4	Total embodied energy inflows	$R+N+F+G+P_2 I_3$ 178.49 E22 SEJ/y
5	Total embodied energy used, U	$U=N_0+N_1+R+F+G+P_2 I_3$ 175.02 E22 SEJ/y
6	Total exported embodied energy	$B+P_1 E$ 20.68 E22 SEJ/y
7	Fraction of embodied energy used derived from home sources	$(N_0+N_1+R)/U$ 0.104
8	Exports minus imports	$(N_2+BP_1 E) - (F+G+P_2 I)$ -116.82 E22
9	Ratio of exports to imports	$(N_2+B+P_1 E)/(F+G+P_2 I)$ 0.24
10	Fraction used, locally renewable	R/U .01
11	Fraction of use purchased	$(F+G+P_2 I)/U$ 0.88
12	Fraction used that is imported service	$P_2 I/U$.07
13	Fraction of use that is free	$(R+N_0)/U$.01
14	Ratio of concentrated to rural	$(F+G+P_2 I_3+N_1)/(R+N_0)$ 68.46
15	Use per unit ₂ area (248643 E6 m ²)	$U/(\text{area})$ 7.04 E12 SEJ/y/m ²
16	Use per capita (61.56 E6)	$U/(\text{population})$ 2.84 E16 SEJ/cap/y
17	Renewable carrying capacity at present living standard	$(R/U)(\text{population})$ 6.79 E5 people
18	Developed carrying capacity at same living standard	$8(R/U)(\text{population})$ 5.43 E6 people
19	Ratio of use to GNP (energy-dollar ratio)	$P_1 = U/(\text{GNP})$ 2.45 E12 SEJ/\$

Total use of nonrenewable resources, N, is made up of that which is rurally dispersed and used, N₀; that used intensively, N₁; and raw product exported without much transformation, N₂. Whereas goods export B and service export, P₁E carry embodied energy that may be derived from imports, they represent transformations and are the products of use.

Discussion

West Germany has a high dependence on energy supplies from other countries. Only 10% of the embodied energy used to run the economy is derived from home sources; both renewable sources (rain) and nonrenewable sources (coal). Compared with their role in the USSR (3.3%), US (17%) or Spain (76%), foreign energy supplies are a major element in the West German economy and also influence its politics such as foreign and military affairs. A dramatic economic decline can be predicted in case of energy-supply shortage from the outside world. The first signs of decline were seen during the oil shock in 1973 which caused the first big recession after the Second World War.

Carrying capacity

If the economy were running only on its own renewable sources, West Germany could only support 1.1% or 6.79 E5 people of the present population at today's standard of living. The developed carrying capacity is the number of people the country could support if it attracts 8 times more non-renewable energy than renewable energy, as the US does. In West Germany there would be 5.43 E6 people or 8.8% of the current population. Thus, it seems that in terms of attracting outside energy to match and interact with its own renewable energy, the FRG is ten times more "developed" than the US.

Energy use

At the moment, every West German inhabitant uses 2.84 E16 SEJ/y. In comparison, one person uses in Liberia 2.6 E16 SEJ/y, in the USSR 1.69 E16 SEJ/y, in Dominica 8.2 E15 SEJ/y and in Spain 6.15 E15 SEJ/y.

An index which shows how much a country is "developed" might be the ratio of electricity consumption/capita. With 2.9 E15 SEJ/y, West Germany has about the same ratio as the USSR, but 1.6 times that of Poland and 10.7 times that of Liberia.

The great dependence of the West German economy on non-renewable, mainly imported energy is shown in the ratio of the concentrated (fuel, goods, services) to rural (chemical potential energy in rain and soil loss) energy (Table 11.4.) In the FRG it is 21 times of the USSR and 10 times of the US.

Figure 11.4b. shows that despite the more or less balanced money flow (Table 11.3.), the FRG sends 6.4 times less embodied energy out of the country than it actually imports. This fact is one of the reasons why the West German economy is one of the most prosperous in the world.

Elisabeth C. Odum
*Santa Fe Community College,
Gainesville, Florida*

Howard T. Odum
*Environmental Engineering Sciences
University of Florida, Gainesville*

John Richardson
*Environmental Engineering Sciences
University of Florida, Gainesville*

12. ENERGY ANALYSIS OVERVIEW OF THE U.S.S.R.

Introduction

This is an energy analysis overview of the main resource basis for the USSR. By estimating embodied energy of imports, fuels, and environmental energies, all on the same basis, perspectives are gained as to what is important.

With a total area of 22,402,200 km², the Soviet Union is the world's largest nation, more than twice the size of Canada, China, or the USA, one-sixth of the earth's land surface. Its population density was 12/km², with a 0.9 growth rate (U.N. 1981). The relatively low average population density results mainly from its position in cold, high latitudes, from 35° N to 78° N. A conventional and polar view of the geographical position of the USSR in the world (Figure 12.1) emphasizes its size and northern latitudes. The northern boundary is the Arctic Ocean which is frozen nearly all year. In no place does the Soviet Union touch open warm oceans.

Its interior northern location imposes severe climatic restrictions and consequent limitations on soil and habitability. Three-quarters of the population and agriculturally productive land are in the south and west. Many of the natural resources are far from these centers. The country stretches nearly 10,000 km. from west to east, crossing 11 time zones, a tremendous expanse in terms of transportation.

The natural vegetation areas are shown in Figure 12.2. Precipitation is somewhat low over most of the USSR (average 0.53 m/y) with a decline from the western boundary and the Pacific towards the interior. The tundra is underlain by permafrost; soils and vegetation are poorly developed. The taiga has shorter but colder winters, low rainfall and acid soils of coniferous forest. Much of the steppe lands are used for agriculture with heavy fertilization in less fertile parts. The steppe grades southwards through the dry semi-desert to true desert where, over large areas, there is little or no vegetation. The mountain vegetation varies from conifers to broad-leaved forests.

About 10% of the land is arable and 15% is used for grazing. The major crops are wheat, corn, rye, potatoes and sugar beets. The USSR was formerly a net exporter of food, but now with meat consumption up and more grain needed to feed livestock, some grain is imported.

The USSR has close political, military, and trade ties with the other centrally planned economies. The Council for Mutual Economic Assistance (COMECON) included the USSR, the German Democratic Republic, Poland, Czechoslovakia, Bulgaria, Hungary, Albania, Romania, Mongolia and Cuba. Vietnam became a member in 1979.

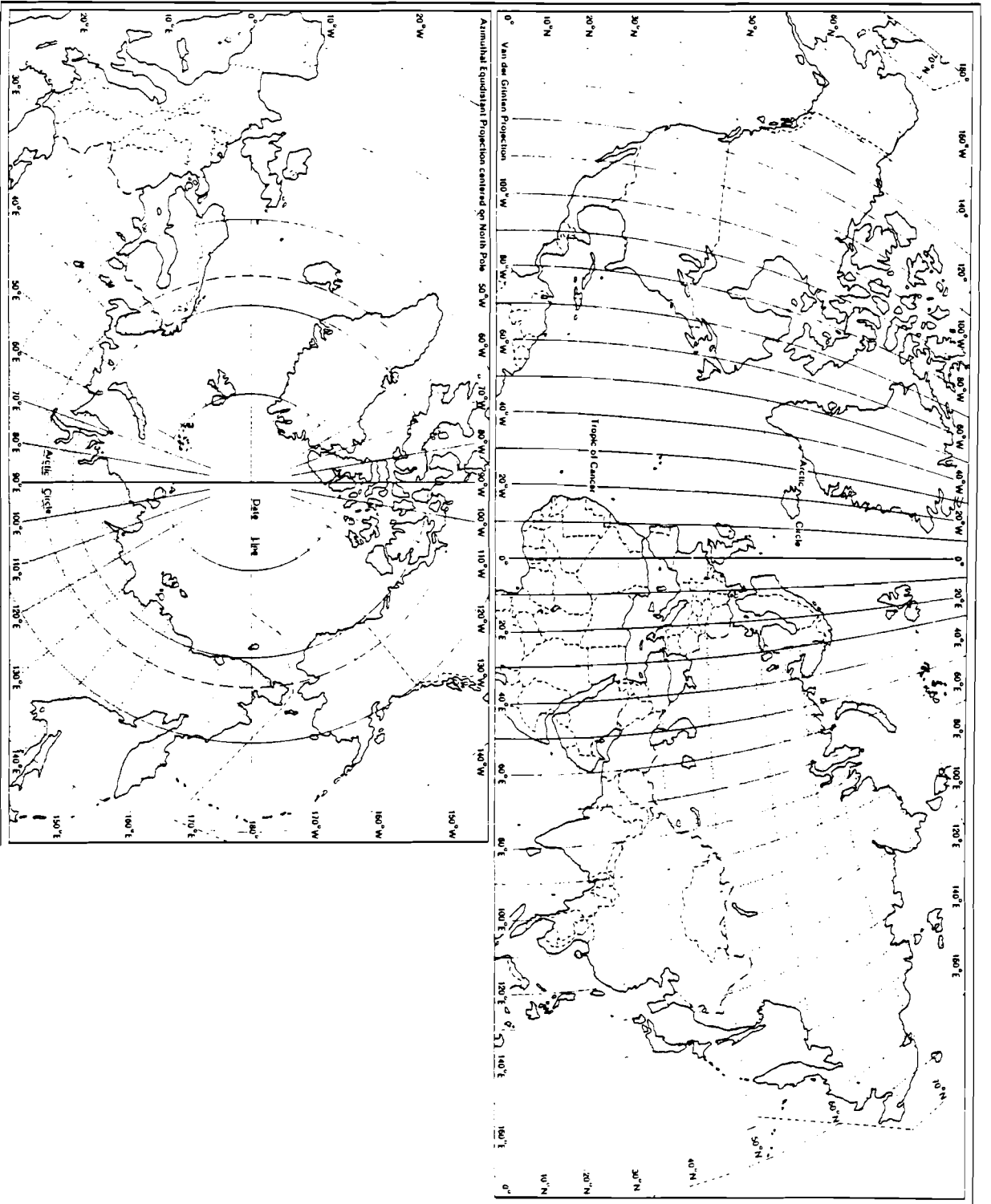

Figure 12.1. World map showing the U.S.S.R. (a) conventional view; (b) popular view (redrawn from Dewdney, 1982).

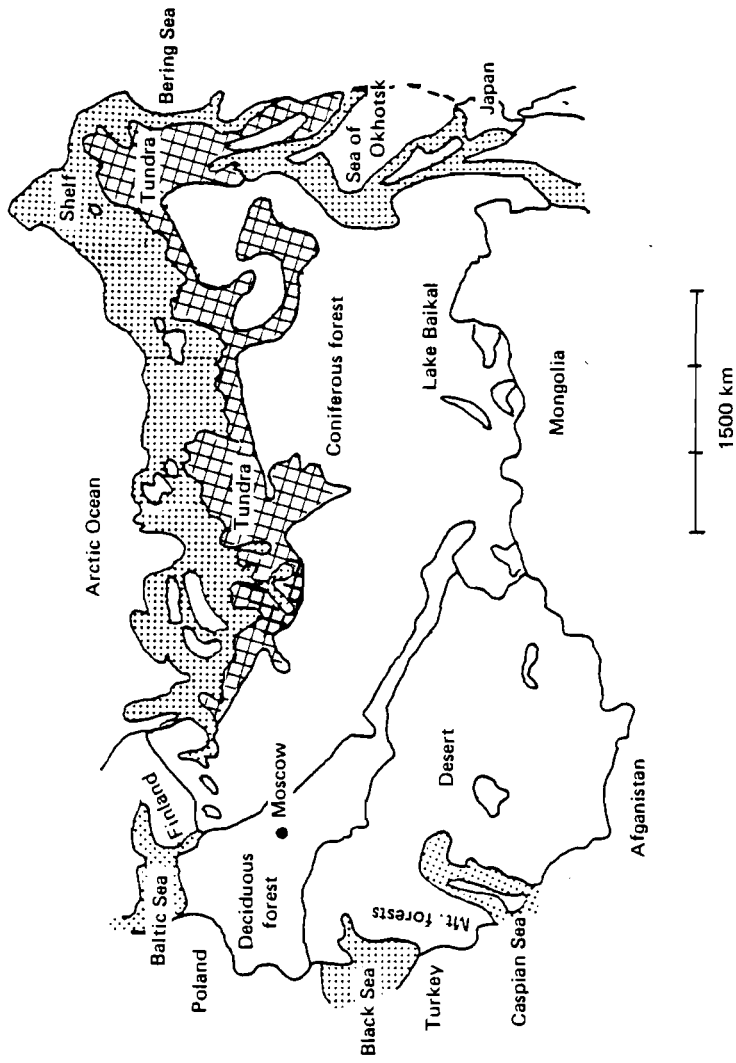

Figure 12.2 Land use map of U.S.S.R.

Methods

Methods of energy analysis were those given in Sections 1-5. The USSR energy system was diagrammed and evaluated in energy terms. A complex national diagram drawn using the energy systems language is Figure 12.3.

Most data were derived from the following five references; Vienna Institute for Comparative Economic Studies 1981, COMECON Foreign Trade Data; Dewdney, J.C., 1982, U.S.S.R. in Maps; United Nations 1981, 1979/80 Statistical Yearbook; United Nations 1981, 1980 Yearbook of International Trade Statistics Vol. I. Whereas these data provide a general overview of the USSR, a more complete analysis of so large and complex a nation will require analysis of other energy flows not yet included here. More data are needed on embodied energies of minerals.

An aggregated diagram was used to represent totals for overall comparisons. Several ratios (outside-inside energy ratio, embodied energy trade ratio, etc.), were calculated to compare the USSR with other countries and to support predictions. The gross national product was estimated in three ways.

Results

Figure 12.3 shows the energy system of the USSR which includes outside energy sources, productive land uses, mineral storages, industries and the primarily human systems.

The energy flows are summarized in Table 12.1 and the storages in Table 12.2. Since the embodied solar energy in the chemical potential in rain is larger than any of the other

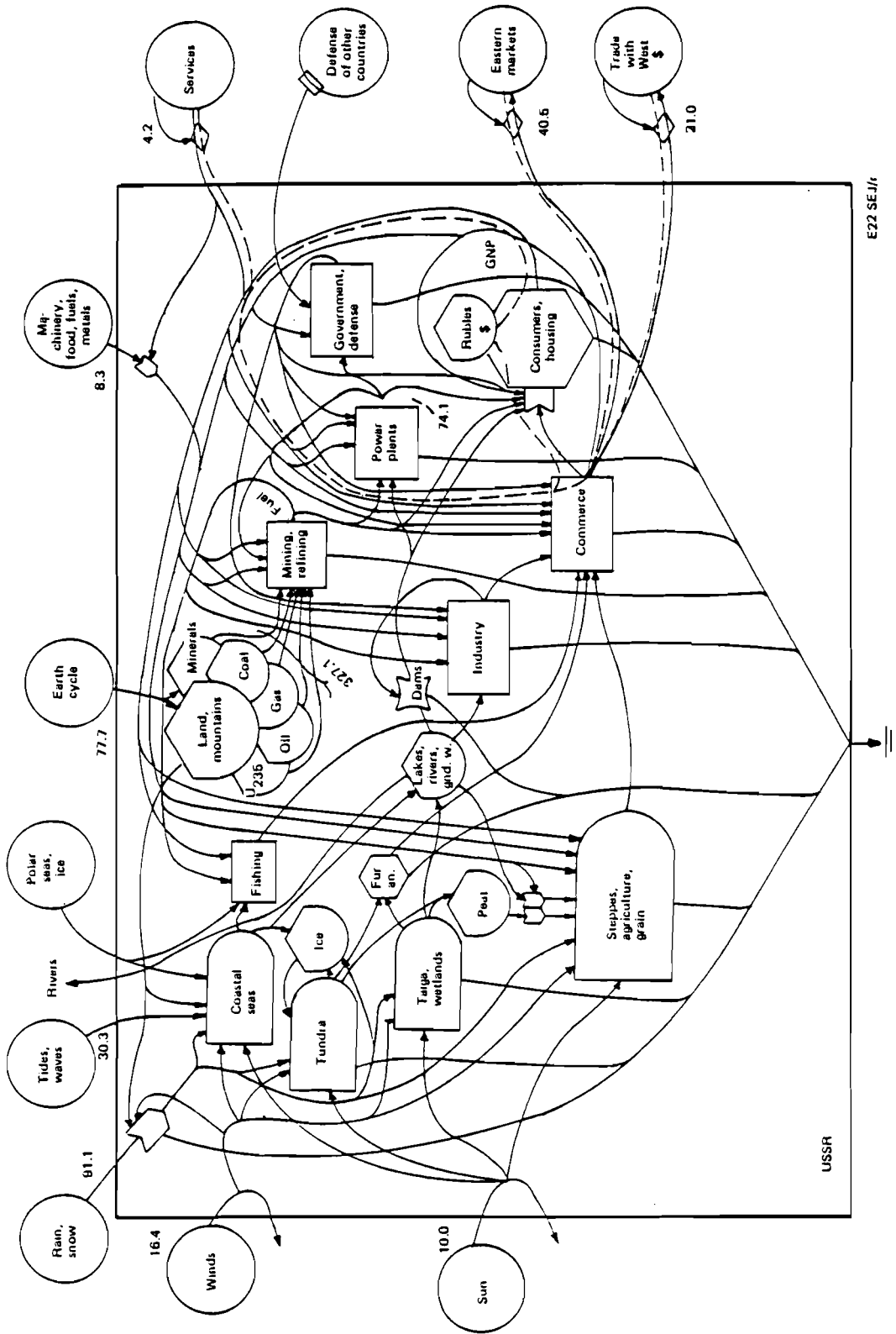

Figure 12.3. Energy diagram of the U.S.S.R.

Table 12.1. Energy flows of the U.S.S.R.

Foot-note	Type of Energy	Actual Energy J/y	Energy Transformation Ratio SEJ/J or SEJ/T	Embodied Solar Energy E22 SEJ/y
1.	Direct sunlight	9.98 E22	1	9.98
2.	Wind, kinetic	2.48 E20	663	16.4
3.	Rain, chemical potential	5.9 E19	15,444	91.1
4.	Rain, geopotential	1.93 E19	8,888	16.9
5.	Tide	1.27 E18	23,564	29.7
6.	Waves	2.22 E15	25,889	0.57
7.	Earth cycle	3.68 E19	2.9 E4	77.7
8.	Earth deposition, 2.72 E8 T	-	1.71 E15/T	46.5
9a.	Iron production	1.89 E15	6.02 E7	11.4
9b.	Iron export	-	-	1.9
10a.	Coal production	2.30 E19	3.98 E4	91.5
10b.	Coal export	7.96 E17	3.98 E4	3.2
11a.	Oil production	2.74 E19	5.3 E4	148.4
11b.	Oil export	7.27 E18	5.3 E4	38.5
11c.	Oil import	4.24 E17	5.3 E4	2.2
12a.	Natural gas production	1.58 E19	4.8 E4	75.8
12b.	Natural gas export	-	-	4.6
12c.	Natural gas import	0.46 E18	4.8 E4	2.2
13.	Hardwood timber harvest	0.54 E18	5.7 E4	3.07
14a.	Softwood timber harvest	3.7 E18	1.9 E4	7.0
14b.	Softwood timber export	-	-	0.35
15a.	Machinery & equipment imports 3.3 E6 T	-	5.9 E15/T	1.95
15b.	Machinery & equipment exports 1.8 E6T	-	5.9 E15/T	1.06
16.	Food imports	1.64 E17	2.67 E4	0.44
17a.	Electricity production	4.66 E18	15.9 E4	74.1
17b.	Hydroelectricity	6.08 E17	15.9 E4	9.6
17c.	Nuclear electricity	1.4 E17	15.9 E4	2.2
18.	Minerals, metals import	8.82 E14	1.69 E7	1.5
19.	Phosphate import, 8.2 E3 T	-	1.41 E16/T	0.0093
20.	Services in imports	-	-	31.4
21.	Services in exports	-	-	16.2

Footnotes for Table 12.1

1. Direct sunlight

Area: $22.4 \text{ E6 km}^2 = 22.4 \text{ E12 m}^2$ (Dewdney 1982);

Shelf area: 413 E10 m^2 (est.);

Total: 26.5 E12 m^2 Insolation: $90 \text{ kcal/cm}^2/\text{y}$ (Sellars 1965)
(area) (ave. insolation)

$(26.5 \text{ E12 m}^2) (90 \text{ kcal/cm}^2/\text{y}) (4186 \text{ J/kcal}) (1 \text{ E4 cm}^2/\text{m}^2)$

$= 9.98 \text{ E22 J/y}$

2. Wind, kinetic

Eddy diffusion: $24.85 \text{ m}^3/\text{m}^2/\text{s}$;

Vertical gradient: 6.56 E-3 m/s/m

(using Albany, N.Y. as similar, Odum et al. 1983).

(mass) (eddy diffusion) (vertical gradient)² (area) (.5y)

Jan.: $(1 \text{ m}^2) (1000 \text{ m}) (1.23 \text{ kg/m}^3) (24.85 \text{ m}^3/\text{m}^2/\text{s}) (3.14 \text{ E7 s/y})$

$(6.56 \text{ E-3 m/s/m}) (6.56 \text{ E-3 m/s/m}) (22.4 \text{ E12 m}^2) = 4.7 \text{ E20 J/y}$

July: $(1 \text{ m}^2) (1000 \text{ m}) (1.23 \text{ kg/m}^3) (4.94 \text{ m}^3/\text{m}^2/\text{s}) (3.154 \text{ E7 s/y})$

$(3.46 \text{ E-3 m/s/m}) (3.46 \text{ E-3 m/s/m}) (22.4 \text{ E12 m}^2) (.5) = 2.57 \text{ E19 J/y}$

Average total: $4.7 \text{ E20} + 0.26 \text{ E20} = 4.96 \text{ E20}/2 = 2.48 \text{ E20 J/y}$

3. Rain, chemical potential

Rainfall: $530 \text{ mm/y} = .53 \text{ m/y}$ (Bochkov et al. 1972).

$(22.4 \text{ E12 m}^2) (.53 \text{ m /y}) (4.94 \text{ J/g}) (1 \text{ E6 g/m}^3): 5.9 \text{ E19 J/y}$

4. Rain, geopotential

Average elevation: 440 m (est. from Dewdney 1982);

runoff: 0.2 m (Bochkov 1972)

(area) (ave. elevation) (runoff) (density) (gravity)

$(22.4 \text{ E12 m}^2) (440 \text{ m}) (.2 \text{ m/y}) (1 \text{ E3 kg/m}^3) (9.8 \text{ m/s}^2)$

$= 1.93 \text{ E19 J/y}$

Footnotes for Table 12.1 continued

5. Tide

Continental shelf est.: $413 \text{ E}10 \text{ m}^2$; ave. tide height: 0.93 m .
(shelf area) (0.5) (tides/y) (ht)² (density) (gravity) (% absorb.)
($4.13 \text{ E}12 \text{ m}^2$) (0.5) (706/y) (.93) (.93) (1.025 E kg/m^3) (9.8 m/s^2)
(.1) = $1.27 \text{ E}18 \text{ J/y}$

6. Waves absorbed at the shore

Shore of Pacific with waves: $6 \text{ E}6 \text{ m}$, est; $370 \text{ E}6 \text{ J/m}$ (Crabbe & McBride 1978).

($6\text{E}6 \text{ m}$) ($370 \text{ E}6 \text{ J/m}$) = $2.22 \text{ E}15 \text{ J/y}$

7. Earth cycle

Rock: $1.2 \text{ E}6 \text{ J/m}^2/\text{y}$ (Table 2.1)

(energy flow through land/ m^2) (area)

($1.2 \text{ E}6 \text{ J/m}^2/\text{y}$) ($22.4 \text{ E}12 \text{ m}^2$) = $2.68 \text{ E}19 \text{ J/y}$

8. Earth deposition

Av. erosion: $19.07 \text{ T/km}^2/\text{y}$ (Snead 1980); typical formation rate: $31.2 \text{ g/m}^2/\text{y}$ (Table 2.1).

(formation rate) (area of country) - (erosion rate) (area)

($31.2 \text{ g/m}^2/\text{y}$) ($22.4 \text{ E}12 \text{ m}^2$) - ($19.07 \text{ g/m}^2/\text{y}$) ($22.4 \text{ E}12 \text{ m}^2$)

= $-5.67 \text{ E}15 \text{ g/y}$ eroded = $2.72 \text{ E}14 \text{ g/y}$ deposited

Topsoil deposition:

Farmed area: $0.55 \text{ E}13 \text{ m}^2$, successional area; $0.75 \text{ E}13 \text{ m}^2$ (Dewdney 1982); average erosion rate $687 \text{ g/m}^2/\text{y}$, average formation rate $1260 \text{ g/m}^2/\text{y}$ (Table 2.1).

(farmed area) (erosion rate) - (successional area) (formation rate)

($0.55 \text{ E}13 \text{ m}^2$) ($687 \text{ g/m}^2/\text{y}$) - ($0.75 \text{ E}13 \text{ m}^2$) ($1260 \text{ g/m}^2/\text{y}$)

= $-5.67 \text{ E}15 \text{ g/y}$ deposited

(--- g/y) (0.03 organic) (5.4 kcal/g) (4186 J/kcal)

Footnotes for Table 12.1 continued

$$(5.67 \text{ E15 g/y}) (0.03) (5.4 \text{ kcal/g}) (4186 \text{ J/kcal}) = 3.85 \text{ E18 J/y}$$
$$(\text{ETR: } 6.25 \text{ E4 SEJ/J}) (3.85 \text{ E18 J/y}) = 2.40 \text{ E13 SEJ/y}$$

9a. Iron production

Iron-ore (Fe content): 133 E6 T, 1978 (UN 1981); Gibbs free energy: 14.2 J/g (Gilliland 1983).

$$(133 \text{ E6 T/y}) (14.2 \text{ J/g}) (1 \text{ E6 g/T}) = 1.89 \text{ E15 J/y}$$

9b. Export: 17% (Goldman 1979)

$$(1136.9 \text{ E20}) (.17) = 193 \text{ E20 SEJ/y}$$

10a. Coal production

Production: 724 E6 T, 1978 (Dewdney 1982).

$$(724 \text{ E6 T/y}) (3.18 \text{ E10 J/T}) = 2.30 \text{ E19 J/y}$$

10b. Export: (1.4 E9 \$) (\$50.32/s.t.) (0.9 s.t./T) = 2.5 E7 T

$$(2.5 \text{ E7 T}) (3.18 \text{ E10 J/T}) = 7.96 \text{ E17 J/y}$$

11a. Oil production

Production: 572 E6 T, 1978 (UN 1981a).

$$(572 \text{ E6 T}) (7.5 \text{ bbl/T}) (6.28 \text{ E9 J/bbl}): 26.9 \text{ E18 J/y}$$

11b. Export: 27% (Jt. Ec. Com. 1979)

$$(26.9 \text{ E18 J/y}) (.27) = 7.27 \text{ E18 J/y}$$

11c. Oil import: 9 E6 T/y

$$(9 \text{ E6 T/y}) (7.5 \text{ bbl./T}) (6.28 \text{ E9 J/bbl.}) = 4.24 \text{ E17 J/y}$$

12a. Natural gas production

Production: 407 E9 m³, 1979 (Dewdney 1982).

$$(407 \text{ E9 m}^3) (1.1 \text{ G J/28.3 m}^3) (1 \text{ E9 J/GJ}) = 1.58 \text{ E19 J/y}$$

Footnotes to Table 12.1 continued

12b. Export: 6% (Jt.Ec.Com. 1979); to west: 40% of export.

$$7584 \text{ E20 SEJ/y} (.06) = 455 \text{ E20 SEJ/y}$$

12c. Natural gas import

1976: 1.18 E7 thousand m³ (UN Trade 1981b).

$$11.8 \text{ E9 m}^3 (1.1 \text{ GJ}/28.3 \text{ m}^3) (1 \text{ E9 J}/\text{GJ}) = .46 \text{ E18 J/y}$$

13. Hardwood timber harvest

Total timber harvest: 350-380 E6 m³/y; 325 E6 m³ is softwood, conifers (Dewdney 1982); hardwood density: 0.8 E6 g/m³.

$$(40 \text{ E6 m}^3/\text{y}) (0.8 \text{ E6 g}/\text{m}^3) (4 \text{ kcal}/\text{g}) (4186 \text{ J}/\text{kcal}) = \\ = 0.54 \text{ E18 J/y}$$

14a. Softwood timber harvest

Density: 0.5 E6 g/m³; 4 kcal/g.

$$(325 \text{ E6 m}^3/\text{y}) (0.5 \text{ E6 g}/\text{m}^3) (4 \text{ kcal}/\text{g}) (4186 \text{ J}/\text{kcal}) \\ = 3.7 \text{ E18 J/y}$$

14b. Export: 4-5% of softwood (Dewdney 1982).

$$(703 \text{ E20 SEJ}) (.05) = 35.2 \text{ E20 SEJ}$$

15a. Machinery and equipment

32% of exports (52.2 E9 \$) = 12.4 E9 \$; 61% of imports (50.5 E9 \$) (Colliers); T/\$ for machine tools (UN Trade 1981b); (5140 T)/(46.7 E6 \$) = 1.1 E-4 T/\$.

$$\text{imports: } (.61) (50.5 \text{ E9 } \$\text{US}) = 3.0 \text{ E10 } \$; (3 \text{ E10 } \$)$$

$$(1.1 \text{ E-4 T}/\$) = 3.3 \text{ E6 T/y}$$

15b. exports: (.32) (52.2 E9 \$US) = 1.67 E10 \$; (1.67 E10 \$)

$$(1.1 \text{ E-4 T}/\$) = 1.8 \text{ E6 T/y}$$

Footnotes to Table 12.1 continued

16. Food imports

Food imports, 1978: 8.0 E9 \$; 9.8 E6 T, est. from food imports (UN 1982); 4 kcal/g.

$$(9.8 \text{ E6 T}) (1 \text{ E6 g/T}) (4 \text{ kcal/g}) (4186 \text{ kcal/J}) = 1.64 \text{ E17 J/y}$$

17a. Electricity production

Production: 1,295 E9 kWh (UN 1982).

$$(1.295 \text{ E12 kWh/y}) (3.6 \text{ E6 J/kWh}) = 4.66 \text{ E18 J/y}$$

17b. Hydroelectricity

0.169 E12 kWh (UN 1982)

$$(.169 \text{ E12 kWh}) (3.6 \text{ E6 J/kWh}) = 6.08 \text{ E17 J/y}$$

17c. Nuclear electricity

0.039 E12 kWh (UN 1982)

$$(0.039 \text{ E12 kWh}) (3.6 \text{ E6 J/kWh}) = 1.4 \text{ E17 J/y}$$

18. Metals and mineral imports

10% of imports (Colliers 1982); imports: 50.5 E9 \$ (UN 1981a). $G = 90.4 \text{ E6 J/T}$; $.002 \text{ T/\$}$ (UN Trade 1981).
 $(.1) (50.5 \text{ E9 \$}) = 5.05 \text{ E9 \$}$ almost equal to $4.9 \text{ E9 \$}$, iron and steel (UN Trade 1981).

$$(.002 \text{ T/\$}) (4.9 \text{ E9 \$}) (90.4 \text{ E6 J/T}) = 8.82 \text{ E14 J/y}$$

ETR of refined iron and steel, Appendix A13.

19. Phosphate fertilizer import

Import: 8200 T/y (FAO 1978). Production: 5.59 E6 T.
Import 0.1 % of amount used.

20. Service in imports

Imports, 1978: 50.5 E9 \$US (UN 1981a); (see Table 12.3, P₂I)

$$4.2 \text{ E22 SEJ/y}$$

Footnotes to Table 12.1 continued

21. Service in exports

Exports, 1978: 52.2 E9 \$US (UN 1981a); (Table 12.3, P₁I)
 5.0 E22 SEJ/y

Table 12.2. Energy storages of the U.S.S.R.

Foot- note	Type of Energy	Actual Energy J	Energy Transforma. Ratio (ETR) SEJ/J	Embodied Solar Energy	
				E24	SEJ
1	Soil, chemical potential	4.69 E18	6.25 E4	0.293	
2	Forest wood, conifers	2.22 E21	1.9 E4	42.1	
3	Forest wood, deciduous	3.52 E20	5.7 E4	20.1	
4	Water storage, chemical	2.22 E20	15,444	3.4	
5	Iron, chemical potential	1.57 E18	6.02 E7	94.5	
6	Coal	8.8 E21	3.98 E4	350.2	
7	Natural gas	3.8 E20	4.8 E4	41.8	
8	Oil	3.8 E20	5.3 E4	20.1	

Footnotes for Table 12.2

1. Soil, chemical potential

Surface soil: 0.8m deep; average organic matter taken from a similar US area: 3.3% (Brady 1974).

(volume)(density)(organic fraction)(G)

$$(.8 \text{ m})(22.4 \text{ E12 m}^2)(1 \text{ E6 cm}^3/\text{m}^3)(1.47 \text{ g/m}^3)(.033)(5.4 \text{ kcal/g}) = 4.69 \text{ E18 J}$$

2. Forest wood, conifers

Forests: 700 E6 hectares = 700 E10 m², 90% conifers (Dewdney 1982);
 taiga: 60% = 170 T/ha, 40% = 260-280 T/ha (IIASA Data Bank)

Footnotes to Table 12.2 continued

$[(.6) (170 \text{ T/ha}) + .4 (270 \text{ T/ha})] (1 \text{ E}6 \text{ g/T}) / (1 \text{ E}4 \text{ m}^2/\text{ha}) = 2.1 \text{ E}4 \text{ g/m}^2$
in 90%

$(.9) (700 \text{ E}10 \text{ m}^2) (2.1 \text{ E}4 \text{ g/m}^2) (4 \text{ kcal/g}) (4186 \text{ J/kcal}) = 2.22 \text{ E}21$

3. Forest wood, deciduous

10% of forest; 30 kg /m^2 (Lieth & Whittaker 1975); 4 J/g .

$(.1) (700 \text{ E}10 \text{ m}^2) (3.0 \text{ E}4 \text{ g/m}^2) (4 \text{ kcal/g}) (4186 \text{ J/kcal}) = 3.52 \text{ E}20$

4. Water storage, chemical potential

$45,000 \text{ km}^3$ fresh water including lakes, swamps, glaciers and snow cover, river ice fields. (Bochkov 1982).

$(45,000 \text{ km}^3) (1 \text{ E}9 \text{ m}^3/\text{km}^3) (1 \text{ E}6 \text{ g/m}^3) (4.94 \text{ J/g}) = 2.22 \text{ E}20 \text{ J}$

5. Iron chemical

World reserves, 1972: $251,000 \text{ E}6 \text{ T}$, USSR 44% (Alexandersson and Klevebring 1978); 14.2 J/g (Gilliland 1983).

$(.44) (251 \text{ E}9 \text{ T}) (1 \text{ E}6 \text{ g/T}) (14.2 \text{ J/g}) = 1.57 \text{ E}18 \text{ J}$

6. Coal

Known reserves: $2.76 \text{ E}11 \text{ T}$ (UN 1981a).

$(2.76 \text{ E}11 \text{ T}) (3.18 \text{ E}10 \text{ J/T}) = 8.8 \text{ E}21 \text{ J}$

7. Natural gas

Reserves: $23.0 \text{ E}12 \text{ m}^3$ (UN 1981a).

$(22.4 \text{ E}12 \text{ m}^3) (1.1 \text{ GJ}/28.3 \text{ m}^3) (1 \text{ E}9 \text{ J/GJ}) = 8.7 \text{ E}20 \text{ J}$

8. Oil

Reserves: $7990 \text{ E}6 \text{ T}$ (UN 1981a).

$(7.99 \text{ E}9 \text{ T}) (7.5 \text{ bbl/T}) (6.28 \text{ E}9 \text{ J/bbl}) = 3.8 \text{ E}20 \text{ J}$

solar-based sources, it was used as the country's outside renewable energy flow for further calculations. Seventy-three percent of the economy runs on the indigenous nonrenewable storages of fuels and minerals. Only about 3% is dependent on international trade.

The Soviet Union has many mineral resources. It is the world's leading producer of iron, lead, manganese, mercury, potash and silver, and the second or third largest producer of asbestos, chrome, cobalt, copper, diamonds, gold, magnesite, nickel, phosphate, salt, sulfur, tungsten, vanadium and zinc. The USSR is self-sufficient in most minerals, with imports of bauxite and tin (Dowdney 1982).

Soviet fuel production not only supplies domestic needs, but also permits considerable export. After Saudi Arabia, it is the largest exporter of oil; after the Netherlands, it is the largest exporter of natural gas. Only 10% of the fuel reserves are in the European part which is close to the centers of population and industry. Many of the largest fuel deposits are in Siberia and Central Asia, far from the main consuming centers and in areas of harsh climatic conditions. In 1978, Siberia produced about a third of the country's oil, coal and natural gas.

Of the 1.3 trillion kWh of electricity produced in 1978, about 13% was from hydroelectric power plants and 5-6% from nuclear plants. Most of the thermal plants use coal. There are several hydro-plants under construction and the potential is for more hydro-power.

Energy-dollar Ratio

The energy-dollar ratio (Figure 12.4 and Table 12.3) for the USSR in 1978 was calculated from the chemical potential energy of water, imported goods and services, indigenous nonrenewable energy sources and the Gross National Product.

The USSR energy/\$ ratio of 3.37 E12 SEJ/\$ is about 30% more than that of the US (2.37 E12 SEJ/\$) and of the Federal Republic of Germany (2.45 E12 SEJ/\$). For every dollar that an importer paid the USSR, he received 30% more embodied energy than that dollar would buy in the US or West Germany.

Energy Evaluation of the Balance of Trade

The embodied energy in international trade is given in Figure 12.4b. The energy flows for the exports were calculated from the energies of the flows of goods added to the service labor energy calculated with the energy/\$ ratio of the USSR. The energy of the service labor flows in the imports were calculated proportionately using the energy/\$ ratios of several countries from which the imports came.

The money balance of payments shows that the USSR received \$2 billion more than it paid for imports. On an embodied energy basis, however, the trade ratio shows a large net loss; exports were 1.7 times more than imports. The country's greater embodied energy in exports was mostly in exported fossil fuels which have a much greater embodied energy than the manufactured goods imported.

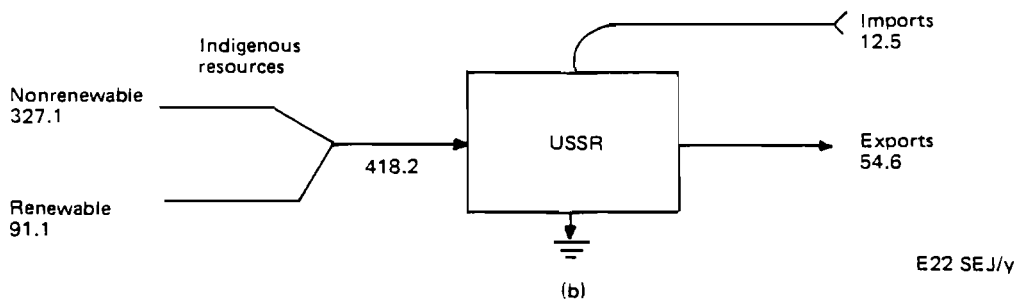
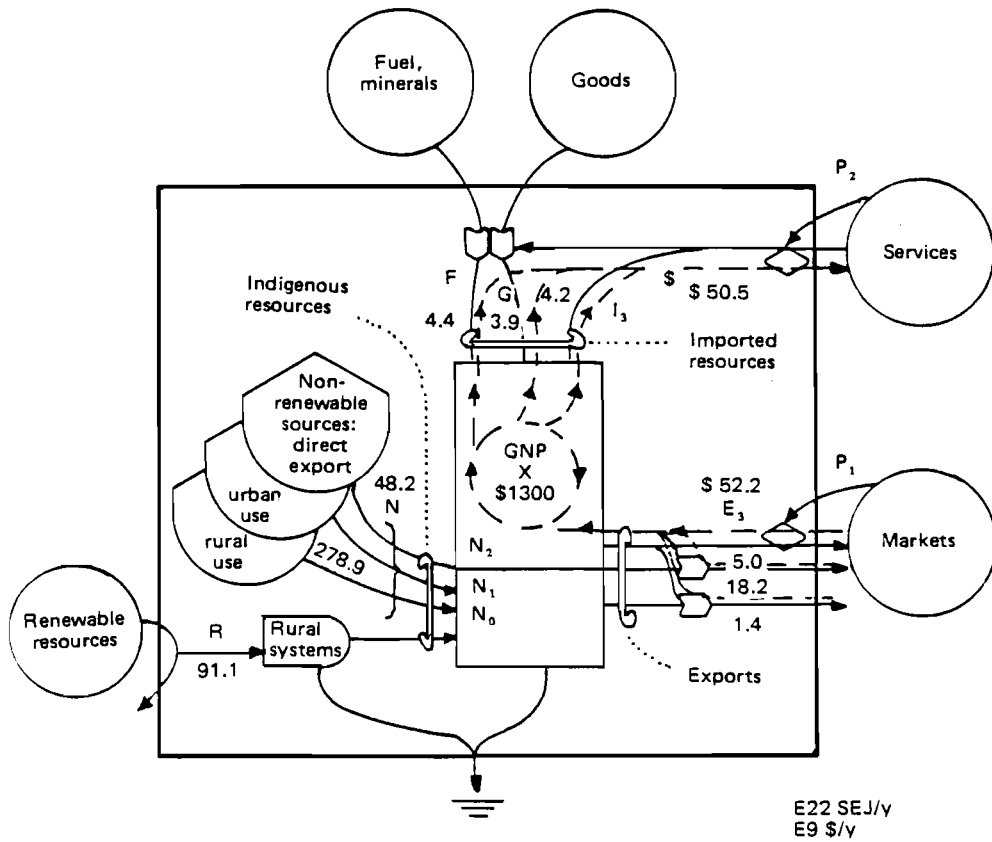

Figure 12.4. Summary diagrams of the embodied energy flows of the U.S.S.R. (a) main flows; (b) three-arm diagram.

Table 12.3. Summary flows for U.S.S.R. in Figure 12.4.

Letter in Figure 12.4	Item	Embodied Solar Energy E22 SEJ/y	Dollars E9 \$ /y
R	Renewable sources used (rain,chem.)	91.1	-
N	Nonrenewable indigenous sources		-
	N ₀ dispersed rural sources	-	-
	N ₁ Concentrated urban use (iron, coal, oil, gas)	278.9	-
	N ₂ Exported without use (iron, coal, oil, gas)	48.2	-
F	Imported minerals and fuels	4.4	-
G	Imported goods	3.9	-
P ₂ I ₃	Imported service	4.2	-
I	Dollars paid for imports,1978	-	50.5
E	Dollars paid for exports,1978	-	52.2
P ₁ E ₃	Exported service	5.0	-
B	Exported products transformed in the country (wood, machinery)	1.4	-
X	Gross national product	-	1300.
P ₂	Embodied energy/dollar ratio of US	2.37 E12 SEJ/\$	
P ₁	Embodied energy/dollar ratio of USSR	3.37 E12 SEJ/\$US	

Footnotes to Table 12.3

R Chemical potential energy of rain is the largest renewable source (Table 12.1): 91.12 E22 SEJ/y

N N₀

N₁ Used in the country: E22 SEJ/y; iron - 9.5, coal - 88.3, oil - 109.9, natural gas - 71.2 = 278.9 E22 SEJ/y

N₂ Exported without use: E22 SEJ/y: iron - 1.9, coal ; 3.2, oil - 38.5, gas- 4.6 = 48.2 E22 SEJ/y

Footnotes to Table 12.3 continued

F Imported fuels: oil and gas = 4.4 E22 SEJ/y

G Imported goods: machinery + food + metals

$$(1.95 + .44 + 1.5) E22 = 3.89 E22 SEJ/y$$

P₂I₃ Total imports: 50.5 E9 \$US; to 3 categories of countries:
17.6 E9 \$ to developed market, 7.3 E9 \$ to developing,
25.5 E9 \$ to centrally planned (UN Trade 1981). Using
average energy/\$ ratios for each category:

(\$)(average energy/\$ ratio of US, West Germany, Spain -
developed market)

$$(17.6 E9 \$) (2.19 E12 SEJ/\$) = 3.85 E22 SEJ/y$$

(\$)(average energy/\$ ratio of Liberia + Dominica - developing)

$$(7.3 E9 \$) (26.4 E12 SEJ/\$) = 19.27 E22 SEJ/y$$

(\$)(energy/\$ app. ratio of USSR - centrally planned)

$$(25.5 E9 \$) (3.25 E12 SEJ/\$) = 8.59 E22 SEJ/y$$

Total: 31.42 E22 SEJ/y

Energy/\$ ratio of imports: 31.42 E22 SEJ/50.5 E9 \$ =
6.2 E12 SEJ/\$

Services not already calculated in the goods: 7.6 E9 \$
(6.7 E9 \$)(6.2 E12 SEJ/\$) = 4.2 E22 SEJ/y

Services not already calculated in the fuel and goods:
14.8 E9 \$

$$P_1 E_3 (3.37 E12 SEJ/\$) (14.8 E9 \$US) = 5.0 E22 SEJ/y$$

B Machinery and wood: (106.0 + 35.2) E20 = 141.2 E20 SEJ/y

X GNP: US, 1978, 2.2 E12 \$; USSR, 60% of US = 1.32 E12 \$US or
population: 2.6 E8; GNP/capita \$4550. (World Bank 1982) =
1.18 E12 \$ or 1976, \$ 1.3 E12 (Goldman 1979);
1.3 E12 \$US used.

$$P_1 = (R + N_1 + F + G + P_2 I) / X$$

$$(91.1 + 278.9) 4.4 + 3.9 + 4.2) E22 SEJ/y /$$

$$1300 E9 \$/y = 2.94 E12 SEJ/\$$$

National Overview Ratios

Various ratios calculated from data in Figure 12.4 and Table 12.3 are given in Table 12.4.

Table 12.4. Indices using embodied energy for overview of the U.S.S.R.

Item	Name of Index	Expression See Figure 12.4	Value
1.	Renewable embodied energy flow	R	91.1 E22 SEJ/y
2.	Flow from indigenous nonrenewable reserves	N	327.1 E22 SEJ/y
3.	Flow of imported embodied energy	$F + G + P_2 I_3$	12.5 E22 SEJ/y
4.	Total embodied energy inflows	$R + N + (F + G + P_2 I_3)$	431.5 E22 SEJ/y
5.	Total embodied energy used, U	$U = N_0 + N_1 + R + (F + G + P_2 I_3)$	382.5 E22 SEJ/y
6.	Total exported embodied energy	$B + P_1 E$	6.4 E22 SEJ/y
7.	Fraction of embodied energy used derived from home sources	$(N_0 + N_1 + R) / U$.97
8.	Exports minus imports	$(N_2 + B + P_1 E) - (F + G + P_2 I_3)$	42.1 E22 SEJ/y
9.	Ratio of exports to imports	$(N_2 + B + P_1 E) / (F + G + P_2 I_3)$	4.4 /1
10a.	Fraction used of locally renewable	R/U	.24
10b.	Fraction used of nonrenewable local	$(N_0 + N_1) / U$.73
11.	Fraction of use purchased abroad	$(F + G + P_2 I_3) / U$.03
12.	Fraction used that is imported service	$P_2 I_3 / U$	7%
13.	Fraction of use that is free	$(R + N_0) / U$.24
14.	Ratio of concentrated to rural	$(F + G + P_2 I_3 + N_1) / (R + N_0)$	3.2 /1
15.	Use per unit area (22.4 E12 m ²)	U/(area)	1.71 E11 SEJ/m ² /y
16.	Use per capita (2.6 E8 population)	U/(population)	1.47 E16 SEJ/cap/y
17.	Fuel per capita	373.3 E22 SEJ/y / (population)	1.46 E16 SEJ/cap/y
18.	Renewable carrying capacity at present standard of living	(R/U) (population)	.62 E8 people
19.	Developed carrying capacity at the same standard of living	8 (R/U) (population)	5.0 E8 people
20.	Ratio of use to Gross National Product (energy-dollar ratio)	$P_1 = U/ \text{GNP}$	2.94 E12 SEJ/\$US

Discussion

The USSR has a high degree of self-sufficiency. Ninety-seven percent of the embodied energy used to run the economy is derived from home sources; both renewable sources (e.g. sun, wind, waves and ice) and nonrenewable sources (e.g. soil, coal, oil, natural gas and iron). The 3% from foreign trade is a minor element in the economy when compared with its role in the Federal Republic of Germany (93%) or Spain (76%).

Seventy-three percent of the economy runs on nonrenewable indigenous sources of fuels, metals, and minerals and only 24% on renewable sources. As the supplies of nonrenewable energies are being used up and those available become farther from the industrial areas, their net energy decreases and the economy may decline.

Carrying Capacity

If the economy were running only on the renewable sources, it could support only about 24% of the population at the present standard of living (energy per person) or the same population at 24% of the present energy per person.

One index of the amount of development in a country is the ratio of fuels and goods to environmental energy. The USSR ratio of 4.4/1 compares with New Zealand of 0.77/1 and the US of 7/1. If the USSR developed more local fuel use to match its renewable energies, it might support a population 1.9 times the 1978 population at the standard of living of that year.

Whether proposals to increase agriculture production by redirecting excess water from the north toward the south would be a net benefit on an embodied energy basis remains for further analysis.

Electric Power

The ratio of electric power to total power may be an index of the over or under development of an economy. The ratio for the USSR is .19, less than Spain (.22), and about the same as New Zealand (.15).

Additional hydroelectric power plants may be a better choice than more nuclear plants since the net energy yields of hydroelectric plants are often much more than nuclear plants.

Forestry Resources and Transportation

Soviet timber production is mostly softwood from the coniferous trees of the taiga, with a small amount of hardwoods. Most of the production and consumption is in the western regions where some deliberate reforestation has been necessary. In Siberia the annual cut is barely 10% of the annual growth. As the available wood becomes farther from its users its net energy becomes lower and it becomes more expensive. Plans are proposed to make wood products which have more embodied energy per unit than logs and boards. Theory suggests that products with more embodied energy per unit may be shipped further more economically.

Soviet transportation policy has concentrated on freight handling and intensive use of railroads. A new railroad line,

the Baykal-Amur Mainline (BAM) which will parallel the Trans-Siberian line, is designed to facilitate the exploitation of the natural resources of East Siberia and the Far East and to strengthen links between the western and eastern parts of the country. Extensive pipeline construction has created a network for oil and natural gas, most within the country, but some to European countries.

International Relations

As shown in Figure 12.5b the imports and exports in dollars between the USSR and other centrally controlled economies was almost evenly balanced. However, Figure 12.5a shows that the embodied energy trade was unbalanced with $4\frac{1}{2}$ times more energy going from the USSR than it received from these countries. This imbalance was also true for the USSR's trade with the developed market economies. (See Table 12.5).

A traditional point of view would regard the deficit in foreign trade as limiting purchase of technical equipment abroad and advocate more export of products even at low prices. If, however, economic products are generated in proportion to embodied energy use, then an opposite policy would maximize the economy. Restricting exports of fuels and raw materials with more use at home would generate more capital assets and growth, ultimately improving the balance of dollars by exporting more valuable products.

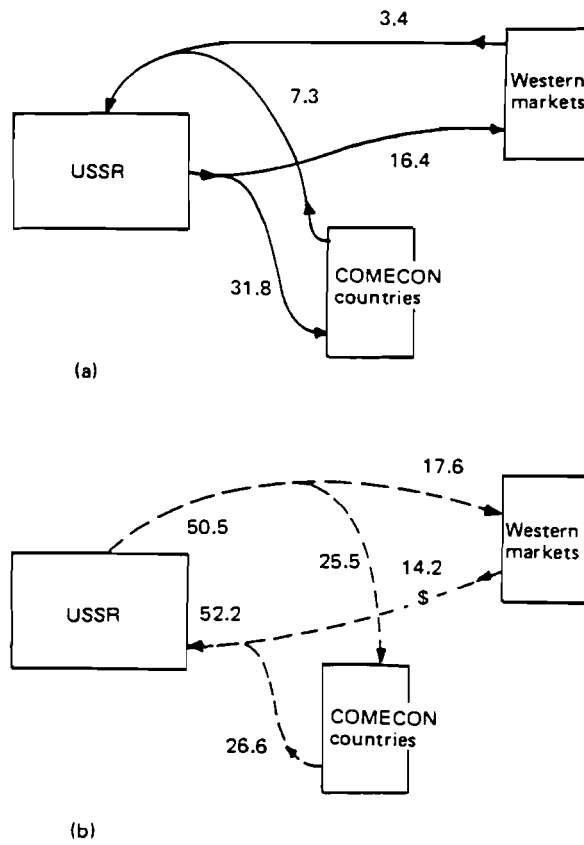

Figure 12.5. Import-export relations between the U.S.S.R., Comecon, and Western markets. (a) embodied energy, (b) dollars.

Table 12.5. Summary of foreign trade with U.S.S.R.
(see Figure 12.5)

Foot- note	Type of Energy	Actual Energy J/y or T/y	Energy Transforma. Ratio SEJ/J	Embodied Solar Energy E22 SEJ/g
Imports from Western markets:				
1.	Grain	3.11 E17 J	2.67 E4	0.83
2.	Machinery	7.16 E5 T	58.95 E14 SEJ/T	0.42
3.	Iron/steel plates	4.95 E4 T	16.45 E14 SEJ/T	0.008
4.	Plastic products	6.9 E15 J	-	-
5.	Service	-	-	<u>2.18</u>
	Total:			3.44
Imports from COMECON countries:				
6.	Natural gas	4.24 E17	5.3 E4	2.2
7.	Machinery	2.5 E6 T	58.95 E14 SEJ/T	1.5
8.	Oil	1.48 E17 J	5.3 E4	0.78
9.	Service	-	-	<u>2.79</u>
	Total:			7.27
Exports to Western markets:				
10.	Oil	-	-	12.8
11.	Gas	-	-	1.8
12.	Coal	-	-	1.1
13.	Timber	-	-	0.35
14.	Services	-	-	0.17
15.	Aluminum	87.6 T	1.63 E16 SEJ/T	<u>0.14</u>
	Total:			16.36
Exports to COMECON countries:				
16.	Oil	-	-	25.7
17.	Natural gas	-	-	2.7
18.	Coal	-	-	2.1
19.	Services	-	-	0.3
20.	Machinery	1.764 E6	58.95 E14 SEJ/T	<u>1.0</u>
	Total:			31.8

Footnotes for Table 12.5

1. Grain: 18.6 E6 T, US, Canada, Australia; 3.60 E9 \$.
 $(18.6 \text{ E6 T})(1\text{E6 g/T})(4 \text{ kcal/g})(4186 \text{ J/kcal}) = 3.11 \text{ E17 J/y}$
2. Machinery: 4.25 E9 \$ (Vienna 1981);
1.685 E-4 T/\$ (Appendix A13).
 $(4.25 \text{ E9 } \$)(1.685 \text{ E-4 T}/\$) = 7.16 \text{ E5 T/y}$
3. Iron/steel plates: .45 E9 \$ (Vienna 1981); 1.1 E-4 T/\$
(UN,1981).
 $(.45 \text{ E9 } \$)(1.1 \text{ E-4 T}/\$) = 4.95 \text{ E4 T}$
4. Services: 17.6 E9 \$ paid for imports from west; 9.2 E9 \$ net
after subtracting services in goods; US en/\$ ratio: 2.37 E12 SEJ/\$
 $(9.2 \text{ E9 } \$)(2.37 \text{ E12 SEJ}/\$) = 2.18 \text{ E22 SEJ}$
5. Plastic products: 1.25 E8 \$ US (Vienna 1981).
1.31 E-3 T/\$ (New Zealand 1981); 10 kcal/g.
 $(1.31 \text{ E-3 T}/\$)(1.25 \text{ E8 } \$)(10 \text{ kcal/g})(1 \text{ E6 g/T})(4186 \text{ J/kcal})$
 $= 6.9 \text{ E15 J}$
6. Natural gas from Afghanistan: 9 E6 T; .46 E9 \$.
 4.24 E17 J/y
7. Machinery: 15 E9 \$ exported Eastern Europe to USSR (Vienna
1981); 1.685 E-4 T/\$ (Appendix A13).
 $(15 \text{ E6 } \$)(1.685 \text{ E-4 T}/\$) = 2.5 \text{ E6 T}$
8. Oil: 543 E6 \$ (Vienna 1981); \$23/bbl.
 $(543 \text{ E6 } \$)(1/\$23/\text{bbl})(6.28 \text{ E9 J/bbl}) = 1.48 \text{ E17 J}$
9. Service paid for imports from centrally planned: 25.5 E9 \$
(UN Trade 1981); net services: 9.5 E9 \$; USSR energy/\$ ratio:
2.94 E12 SEJ/\$US.
 $(9.5 \text{ E9 } \$)(2.94 \text{ E12 SEJ}/\$) = 2.79 \text{ E22 SEJ}$

Footnotes for Table 12.5 continued

10. Oil: Exported 38.5 SEJ/y (Table 12.1); 1/3 exported to the West.
11. Gas: Exported 4.6 SEJ/y (Table 12.1); 40% to the West.
12. Coal: Exported 3.2 SEJ/y (Table 12.1); 1/3 to the West.
13. Timber exported to the West: 0.35 SEJ/y (Table 12.1).
14. Services with exports to West: 14.2 E9 \$; net services: 0.6 E9 \$; USSR energy/\$ ratio: 2.94 E12 SEJ/\$.
$$(0.6 \text{ E9 } \$)(2.94 \text{ E12 SEJ}/\$) = 0.17 \text{ E22 SEJ}/y$$
15. Aluminum: 13.1 E7 \$ (Vienna 1981); 1.63 E10 SEJ/g. \$1500 (1979) /T (Appendix A11).
$$(13.1 \text{ E7 } \$)/(1500 \text{ } \$ /T)(1.63 \text{ E10 SEJ } /g)(1 \text{ E6 g}/T)$$
$$= .14 \text{ E22 SEJ}/y$$
16. Oil exported: 38.5 SEJ/y (Table 12.1); 2/3 exported to the East.
17. Gas exported: 4.6 SEJ/y (Table 12.1); 60% to the East.
18. Coal exported: 3.2 SEJ/y (Table 12.1); 2/3 to the East.
19. Services with exports to the East: 26.6 E9 \$; net services: 1.1 E9 \$; USSR en/\$ ratio: 2.94 E12 SEJ/\$.
$$(1.1 \text{ E9 } \$)(2.94 \text{ E12 SEJ}/\$) = 0.32 \text{ E22 SEJ}/y$$
20. Machinery: 10.36 E6 \$ (Vienna 1981); 1.685 E-4 T/\$ (Appendix A13).
$$(10.36 \text{ E9 } \$)(1.685 \text{ E-4 T}/\$) = 1.746 \text{ E6 T}$$

The imbalance in international trade of embodied energy outlined in Figure 12.5, may have important meaning for international relations. The excess of energy exports may stimulate and be balanced by the advantages of cooperative trade links and beneficial cultural exchanges that help encourage peaceful international relations. Cooperative arrangements among COMECON countries include construction of joint projects which are concentrated in the fields of energy and industrial materials. Recently trade with the western countries has also played an increasing role in Soviet industrial development. Examples of increasing interdependency of East and West are the natural gas pipelines from the USSR into Europe and the recent agreement (1983) with Austria to exchange electrical power.

Although the USSR has a high degree of self-sufficiency and foreign trade is a minor element in its economy, the situation has changed considerably in the post-war period. Planning has led to increased mutual dependence between the USSR and its neighbors. More recently, trade with the West has played an increasing role in the Soviet economy and in this sense East and West have, to some degree, become more dependent on each other.

Howard T. Odum*

*Environmental Engineering Sciences and
Center for Wetlands
University of Florida, Gainesville*

13. ENERGY ANALYSIS OVERVIEW OF BRAZIL

Introduction

This is an energy analysis overview of Brazil; its vast environmental resources, the Amazon basin and its highly developed urban areas to the south; all considered on a common basis of the embodied energy in solar equivalents. (See Figure 13.1). As with other chapters on nations analyzed in this study, this chapter includes an overview map, and energy systems diagram, tables of energy flows and energy storages, a summarizing diagram, and a table of analytical indices.

In 1975, the author participated in a Brazilian national energy conference at Porto Alegre arranged by the legislative assembly of Rio Grande Del Sol. A very preliminary energy analysis of some aspects of Brazils economy was published in

* International Institute for Applied Systems Analysis, summer, 1983.

proceedings (Odum 1977) pointing out net energy fallacies in the optimism of that time regarding nuclear power, sugar-cane alcohol, oil shale, continued growth, and lack of appreciation of the existing wood economy. With improved methods and more detail, this chapter provides further insight into the basis for the Brazilian system.

Acknowledgement

Work was aided by a contract between the Center for Wetlands of the University of Florida and the Cousteau Society for Energy Analysis Perspectives on the Amazon, done in collaboration with Mark T. Brown and Robert Christansen. I am grateful for comments on the earlier study from Celso Testa, Deputy Director, Estado do Grande do Sul, Assembleia Legislativa, Comissao de Obras Publicas, Porto Alegre; P.T. Alvim, Visiting Professor at University of Florida; and scientific and management staffs at Jari, Brazil.

Methods

Methods are given in Chapters 1-5. Main data sources were year book statistics of Brazil (Fundacao Instituto Brasileiro de Geografia E Estatistica 1981); a useful summary by Goldemberg (1982) and OLADE energy summary by Banados (1981). Corrections were made for double counting in use of dollar flows to estimate embodied energy of services. Evaluation of sediment (earth) budget is tentative pending more detailed data.

Results

Figure 13.1 shows a map of Brazil stressing the importance of the rains of the intertropical convergence of winds and sediment inflows. Included is the marine ecosystems of the continental shelf which is estuarine in nature at the Amazon mouth. The population of 121 million people is mainly outside of the Amazon Basin with large area of tropical and sub-tropical agriculture and pastures.

The main features and processes of the nation are diagrammed in an energy diagram in Figure 13.2, the large environmental resources in rivers, forests, and agriculture on the left coupled to the urban centers on the right. Outside imports are relatively small. Most of the electric power is hydroelectric.

The flows are evaluated in Table 13.1. Embodied energy in rain and river inflows is the largest and drives many of the other flows evaluated separately such as wood production, hydroelectric power and coffee. Much of the valuable water-related embodied energy passes out to sea, some contributing to estuarine fisheries, but possibly there would be net energy in routing water to the dry parts of the country.

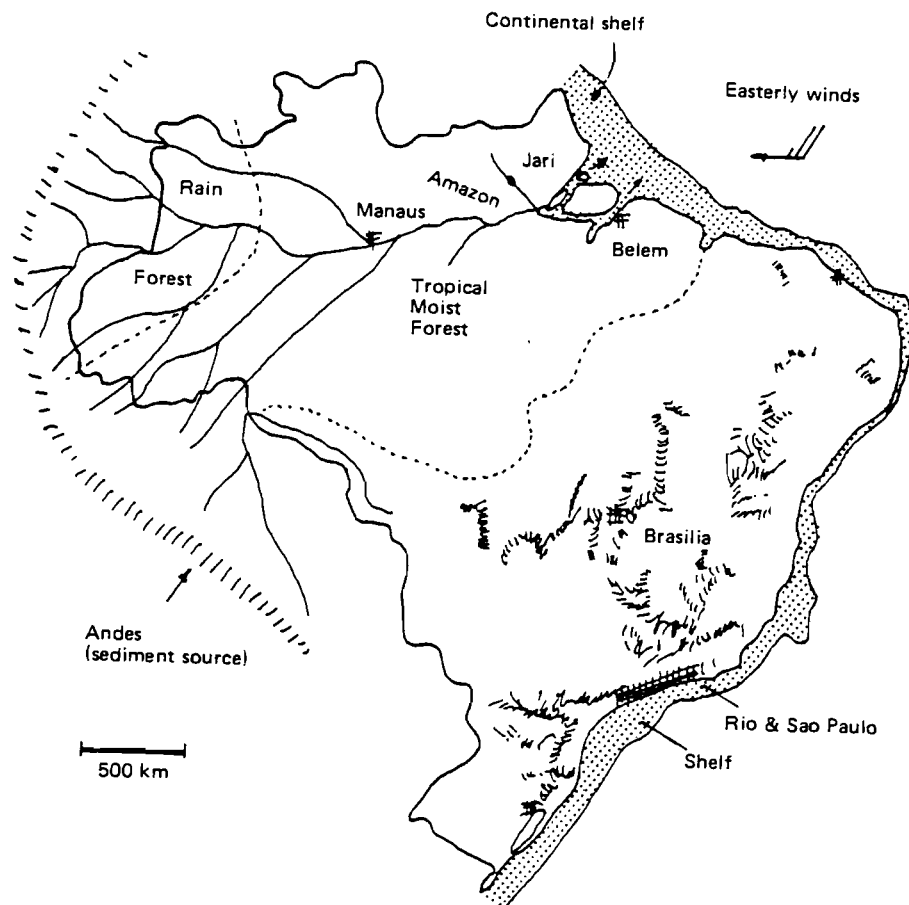

Figure 13.1. Overview map of Brazil.

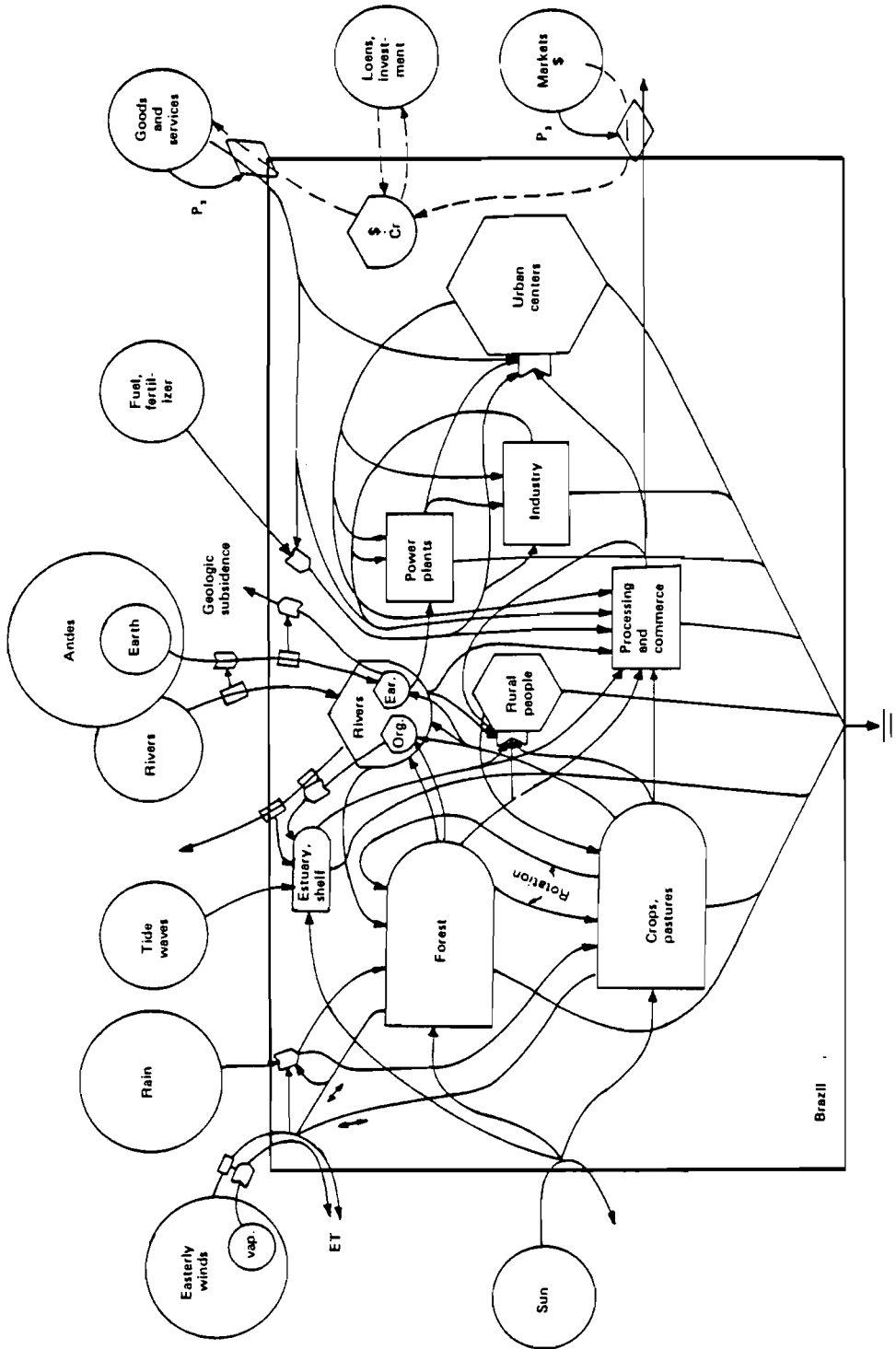

Figure 13.2. Energy diagram of Brazil.

The storages of embodied energy given in Table 13.2 show enormous values in wood biomass and top soils. When the fuel uses (16 SEJ/y) in Table 13.1 are compared to storages of fossil fuels in Table 13.2 (2412 SEJ) the depletion time is 153 y, much longer than that available to most nations. Growth of native forest (73 E22 SEJ/y) is 1.32% of the 5550 E22 SEJ stored in forest biomass (Table 13.2).

The calculation of sediment balance indicates the role of Andes generating earth exported to Brazil in excess of that going to the ocean, contributing to the long term subsidence cycle. These inflows are a valuable input to Varzea forest floodplains carrying nutrients and soil-making earth.

Calculation of topsoil loss and formation is dependent on estimates of area of forest in successional regrowth which is large because of the shifting agriculture and other rotations. Until data being accumulated in carbon-dioxide related studies provide more detail, the sketchy calculation suggests considerable reformation of soil of the same magnitude as that washing out to sea.

Table 13.1. Energy flows in Brazil.

Foot-note	Type of energy	Actual energy		ETR		Embodied solar energy	
		J/y		SEJ/y		E22	SEJ/y
1	Direct sun	4.6	E22	1.		4.6	
2	Chemical potential						
	Rain	6.76	E19	1.5	E4	101.0	
	Inflowing river	1.34	E19	4.1	E4	55.0	
3	Geopotential of rain	4.66	E19	8.9	E3	41.5	
4	Geopotential of runoff						
	Within Brazil	1.35	E19	2.35	E4	31.8	
	Flowing into Brazil	1.07	E19	2.35	E4	25.1	
5	Hydroelectricity	5.0	E17	1.59	E5	8.0	
6	Total electricity, 1980	5.7	E17	1.59	E5	9.1	
7	Waves	8.55	E17	2.59	E4	2.2	
8	Tide	2.37	E14	2.35	E4	0.56	
9	Net earth inflow			1.71	E9/g	94.0	
	0.55 E15 g/y	-					
10	Net topsoil formation	2.18	E18	6.25	E4	13.6	
11	Wood growth	2.22	E19	3.3	E4	73.3	
12	Lumber use	1.65	E18	3.5	E4	5.7	
Fuel uses:							
13	Fuelwood use (in oil J)	0.89	E18	3.5	E4	3.1	
14	Charcoal use (in oil J)	1.31	E17	7.0	E4	0.92	
15	Oil consumption:						
	indigenous	3.78	E17	5.3	E4	2.0	
	imported	2.24	E18	5.3	E4	11.9	
16	Coal consumption (in oil J)	1.47	E17	5.3	E4	0.78	
17	Uranium use	4.9	E16	1.79	E3	0.008	
18	Natural gas	3.0	E16	4.8	E4	0.144	
19	Alcohol use	1.09	E17	6.0	E4	0.65	
20	Sugar cane bagasse	2.71	E17	6.11	E4	1.65	
Exports:							
21	Amazon organic discharge	1.26	E18	6.25	E4	7.9	
22	Bauxite	5.9	E13	1.32	E7	0.08	
23	Iron ore	8.48	E14	6.0	E7	5.09	
24	Wood and paper	2.64	E16	3.0	E5	0.79	
25	Sugar	2.14	E16	8.4	E4	0.18	
26	Coffee, 6.22 E5 T/y	-		-		-	

Table 13.1 continued.

Foot-note	Type of energy	Actual energy J/y	ETR SEJ/y	Embodied solar energy E22 SEJ/y
Imports:				
27	Potash	1.23 E15	2.62 E6	0.32
28	Phosphate	1.06 E14	4.14 E7	0.44
29	Nitrogen	2.99 E14	1.69 E6	0.05
30	Fuels	2.24 E18	53.0 E4	11.9

Footnotes for Table 13.1.

1. Direct sun

Insolation 140 kcal/cm²/y (Sellers 1965)

Area, 8.51 E12 m² land + 0.67 E12 shelf = 9.18 E12

Land: albedo 15%

$$(0.85) (8.51 \text{ E12 m}^2) (140 \text{ kcal/cm}^2/\text{y}) (4186 \text{ J/kcal}) (1 \text{ E4 cm}^2/\text{m}^2)$$

$$= 4.24 \text{ E22 J/y}$$

Shelf:

$$(0.67 \text{ E12 m}^2) (140 \text{ kcal/cm}^2/\text{y}) (4186 \text{ J/kcal}) (1 \text{ E4 cm}^2/\text{m}^2)$$

$$0.392 \text{ E22 J/y}$$

$$\text{Total: } 4.633 \text{ E22 J/y}$$

2. Chemical potential

Rain: Mean of annual rainfall of 27 capital cities, 1589 mm/g (Fundacao Instituto Brasileiro de Geografia e Estatistica 1980).

$$(8.51 \text{ E12 m}^2) (1.589 \text{ m/y}) (5 \text{ J/g}) (1 \text{ E6 g/m}^3)$$

$$= 6.76 \text{ E19 J/g}$$

Inflowing river: dissolved solids, 67 g/m³; water inflow, 2.73 E12 m³/y (Marlier 1973)

$$(2.73 \text{ E12 m}^3/\text{y}) (G) (1. \text{ E6 g/m}^3) = 1.34 \text{ E19 J/y}$$

$$\text{where } G = 138 \text{ Log}_e \frac{(999,933)}{(965,000)} = 4.9 \text{ J/g}$$

Footnotes for Table 13.1. continued

3. Geopotential of rain

Data from Footnote 3

$$(1.589 \text{ m/y}) (1 \text{ E3 kg/m}^3) (8.51 \text{ E12 m}^2) (9.8 \text{ m/sec}^2) (352 \text{ m})$$

$$= 4.66 \text{ E19}$$

4. Geopotential of runoff from within Brazil

Runoff estimated as rain minus pan evaporation
(1.589 m/y - 1.128 m/y); 27 rain storms, 26 evaporation
stations and mean elevation from hypsometric data (Fundacao
Instituto Brasileiro de Geografia e Estatistica 1980)

$$(0.461 \text{ m/y}) (8.51 \text{ E12 m}^2) (1 \text{ E3 kg/m}^3) (9.8 \text{ m/sec}^2) (352 \text{ m})$$

$$= 1.35 \text{ E19 J/y}$$

Flowing into Brazil:

$$2.72 \text{ E12 m}^3/\text{y} \text{ or more (Marlier 1973)}$$

$$(2.73 \text{ E12 m}^3/\text{y}) (400 \text{ m}) (1 \text{ E3 kg/m}^3) (9.8 \text{ m/sec}^2)$$

$$= 1.07 \text{ E19 J/y}$$

5. Hydroelectricity

Fundacao Instituto (1980)

$$(34.1 \text{ E6 T oil equiv.}) (44 \text{ E9 J/T})$$

$$= 1.50 \text{ E18 J/y oil equivalents}$$

$$\frac{(1.50 \text{ E18 oil J/y}) (3.33 \text{ E4 SEJ/oil})}{(1.59 \text{ E5 SEJ/J elect})} = 5.0 \text{ E17 J elect}$$

6. Total electricity (1980)

7% thermal power added to hydroelectric power.

Footnotes for Table 13.1 continued

7. Waves

6100 km facing coastline
Wave height, 0.6 m in 10 m water assumed similar to other
trade wind region, South Florida

$$(3.35 \text{ E7 kcal/m/y}) (4186 \text{ J/kcal}) (6.1 \text{ E6 m}) \\ = 8.55 \text{ E17 J/y}$$

8. Tide

$$(0.5) (0.67 \text{ E12 m}^2 \text{ shelf}) (1 \text{ m})^2 (706/\text{y}) (1.023 \text{ E3 kg/m}^3) \\ (9.8 \text{ m/sec}^2) (.1) \\ = 2.4 \text{ E7 J/y}$$

9. Net earth inflow

Earth from Andes + earth formation in Brazil-Amazon discharge
area of Andes drainage outside Brazil contributing earth
estimated from map as 6.22 E11 m^2 ; earth
cycle of Amazon Basin, 50 E-6 m/y ; for Andes source of
sediment value for Himalayas used, 848 E-6 m/y (Ollier 1981);
Sediment discharge of Amazon, 1 E15 g/y (Snead 1980).

$$(\text{Andes input}) + (\text{Brazil formation}) - (\text{Amazon discharge}) \\ (0.33 (6.22 \text{ E11 m}^2) (848 \text{ E-6 m/g}) (2.6 \text{ E6 g/y}) + (8.51 \text{ E12 m}^2) \\ (50 \text{ E-6 m/g}) (2.6 \text{ E6 g/m}^2) - (1 \text{ E15 g/y}) = \\ = 0.55 \text{ E15 g/y deposited*}$$

* may be equal to geological subsidies.

10. Top soil formation

On agricultural areas, 8.1 E11 m^2 , loss rate assumed for
southeastern U.S., $850 \text{ g/m}^2/\text{y}$ (Larson et al. 1983);
new soil formation assumed on half of forest area,
 2.5 E12 m^2

$$(\text{soil formed}) - (\text{soil eroded}) \\ = (2.5 \text{ E12 m}^2) (1260 \text{ g/m}^2/\text{y}) - (8.1 \text{ E11 m}^2) (850 \text{ g/m}^2/\text{y}) \\ = 3.21 \text{ E15 g/y} \\ (3.21 \text{ E15 g/y}) (0.03 \text{ organic}) (5.4 \text{ kcal/g}) (4186 \text{ J/kcal}) = \\ 2.18 \text{ E18 J/y}$$

Footnotes for Table 13.1. continued

11. Wood growth

Estimated 2614 E6 g/ha in 100 y at Jari; see Appendix A5.

$$(261 \text{ g/m}^2/\text{y}) (4 \text{ kcal/g}) (4186 \text{ J/kcal}) = 4.37 \text{ E6 J/m}^2/\text{y}$$

$$(4.37 \text{ E6 J/m}^2/\text{y}) (5.08 \text{ E12 m}^2 \text{ forest}) = 2.22 \text{ E19 J/y}$$

12. Lumber

(Fundacao Instituto 1980) 1977.

$$(1.22 \text{ E8 m}^3) (0.8 \text{ E6 g/m}^3) (4 \text{ kcal/g}) (4186 \text{ J/kcal})$$

$$= 1.65 \text{ E18 J/y}$$

13. Fuelwood use

Bañados (1981), for 1980

$$(2.0 \text{ E7 T oil equiv.}) (44 \text{ E9 J/T}) = 0.89 \text{ E18 oil J/y}$$

14. Charcoal use

Goldemberg (1982) for 1979

$$(2.98 \text{ E6 T oil equiv./y}) (44 \text{ E9 J/T}) = 1.31 \text{ E17 oil J/y}$$

15. Oil consumption

Bañados (1981) 1980:

indigenous--

$$(8.593 \text{ E6 T oil equiv.}) (44 \text{ E9 J/T}) = 3.78 \text{ E17 J/y}$$

imported--

$$(51.0 \text{ E6 T oil equiv.}) (44 \text{ E9 J/T}) = 2.24 \text{ E18 J/y}$$

16. Coal consumption

1980 domestic production, Bañados (1981)

$$(3.34 \text{ E6 T oil equiv.}) (44 \text{ E9 J/T}) = 1.47 \text{ E17 oil J/y}$$

Footnotes for Table 13.1. continued

17. Uranium use

Fundacao Instituto (1980)

(1.114 E6 T oil equiv.) (44 E9 J/T) = 4.9 E16 J/y

18. Natural gas

Fundacao Instituto (1980)

(0.68 E6 T oil equiv.) (44 E9 J/T) = 3.0 E16 J/y

19. Alcohol use

(2.47 E6 T oil equiv.) (44 E9 J/T) = 1.09 E17 J/y

20. Sugar cane bagasse

Fundacao Instituto (1980)

(6.168 E6 T oil equiv.) (44 E9 J/T) = 2.71 E17 J/y

21. Amazon organic discharge

Richey et al. (1980)

22. Bauxite

Fundacao Instituto (1980) 0.91 E6 T/y @ \$3.55 E8 U.S.

(0.91 E6 T/g) (65.3 E6 J/T)

23. Iron ore

Fundacao Instituto (1980) 5.97 E7 T/y @ \$8.91 E8 U.S.

(5.97 E7 T/y) (14.2 E6 J/T)

24. Wood and paper

Fundacao Instituto (1980) 1.28 E6 T/y @ \$2.47 E8 U.S.

(1.579 E6 T/y) (4 E6 kcal/T) (4186 J/kcal)

Footnotes for Table 13.1. continued

25. Sugar

1.28 E6 T/y @ \$2.47 E8 U.S.

(1.28 E6 T/y) (4 E6 kcal/T) (4186 J/kcal)

26. Coffee

Fundacao Instituto (1980)

6.22 E5 T @ \$1.99 E9 U.S.

Imports (Fundacao Instituto, 1980)

27. Potash

(1.758 E6 T) (702 E6 J/T) @ \$1.77 E8

28. Phosphate

(1.40 E6 T) (76.4 E6 J/T) @ \$2.78 E8

29. Nitrogen

(1.38 E6 T) (2170. E6 J/T) @ \$1.63 E8

30. Fuels

See Footnotes 13-18.

Table 13.2. Energy storages in Brazil

Foot-note	Type of energy	Actual energy E18 J	ETR SEJ or SEJ	Embodied solar energy E23 SEJ
1	Petroleum	8.11	5.3 E4	4.3
2	Natural gas	1.83	4.8 E4	0.88
3	Coal	592.0	4.0 E4	236.0
4	Uranium oxide	70.0	1.8 E3	126.0
5	Wood Biomass	1720.0	3.2 E4	550.0
6	Top soil, litter	3108.0	6.2 E4	1927.0

* Shale oil reserves are given by Goldemberg (1982) and pilot plants are operating, but there is no evidence that the net energy is sufficient to contribute to the economy.

Footnotes for Table 13.2

1-4 fuel reserves from Goldemberg (1982)*

1. Petroleum

$$(198 \text{ E6 m}^3) (41 \text{ E9 J/m}^3) = 8.11 \text{ E18 J}$$

2. Natural gas

$$(47 \text{ E9 m}^3) (3.89 \text{ E7 J/m}^3) = 1.83 \text{ E18 J}$$

3. Coal

$$(2.2 \text{ E10 T}) (26.9 \text{ E9 J/T}) = 5.92 \text{ E20}$$

4. Nuclear

Reserve at less than \$95 (1979, U.S.) per kg.:

$$(0.007) (1.26 \text{ E5 T u}_3\text{o}_8) (1. \text{E6 g/T}) (7.95 \text{ E10 J/g u}^{235})$$

$$= 7.0 \text{ E19 J}$$

Footnotes for Table 13.2. continued

5. Wood Biomass

Biomass assumed half mature; half 15 years of succession (Uhl 1983);

$$(2.54 \text{ E}12 \text{ m}^2) (3.7 \text{ E}4 \text{ g/m}^2) (4 \text{ kcal/g}) (4186 \text{ J/g}) = 1.57 \text{ E}21 \text{ J}$$

$$(2.54 \text{ E}12 \text{ m}^2) (4.0 \text{ E}3 \text{ g/m}^2) (3.6 \text{ kcal/g}) (4186 \text{ J/g}) = 1.53 \text{ E}20 \text{ J}$$

$$= 1.72 \text{ E}21 \text{ J}$$

ETR used, wood unharvested, $3.23 \text{ E}4 \text{ SEJ/J}$; Appendix A5.

6. Top soil including litter

Land areas (Goldemberg 1982) forest, $5.1 \text{ E}12 \text{ m}^2$; Cropland, $4.1 \text{ E}11 \text{ m}^2$; pasture, $4.1 \text{ E}11 \text{ m}^2$; other $1.29 \text{ E}12 \text{ m}^2$; half of forest assumed mature with $3.5 \text{ E}4 \text{ g/m}^2$ organic matter; half of forest assumed successional with $1.7 \text{ E}4 \text{ g/m}^2$

$$(2.54 \text{ E}12 \text{ m}^2) (3-5 \text{ E}4 \text{ g/m}^2) (5.4 \text{ kcal/g}) (4186 \text{ J/kcal}) = 20 \text{ E}20 \text{ J}$$

$$(2.54 \text{ E}12 \text{ m}^2) (1.7 \text{ E}4 \text{ g/m}^2) (5.4 \text{ kcal/g}) (4186 \text{ J/kcal}) = 9.7 \text{ E}20 \text{ J}$$

$$(4.1 \text{ E}11 \text{ m}^2) (0.5 \text{ m}) (1.5 \text{ E}6 \text{ g/m}^3) (0.02 \text{ kcal/g}) (4186 \text{ J/kcal})$$

$$= 0.26 \text{ E}20 \text{ J}$$

$$(4.1 \text{ E}11 \text{ m}^2) (0.5 \text{ m}) (1.5 \text{ E}6 \text{ g/m}^3) (0.03 \text{ kcal/g}) (4186 \text{ J/kcal})$$

$$= 0.038 \text{ E}20 \text{ J}$$

$$(1.29 \text{ E}12 \text{ m}^2) (0.5 \text{ m}) (2.0 \text{ E}6 \text{ g/m}^3) (0.02 \text{ kcal/g}) (4186 \text{ J/kcal})$$

$$= 1.08 \text{ E}20 \text{ J}$$

Total: $3108 \text{ E}18 \text{ J}$

Summary Diagram

In Figure 13.3 and Table 13.3 is given an aggregated summary of embodied energy flows that support the economy of Brazil. Indices are calculated from these and are given in Table 13.4.

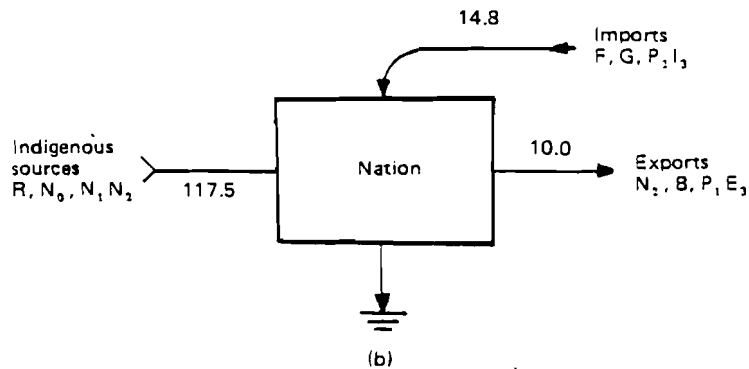
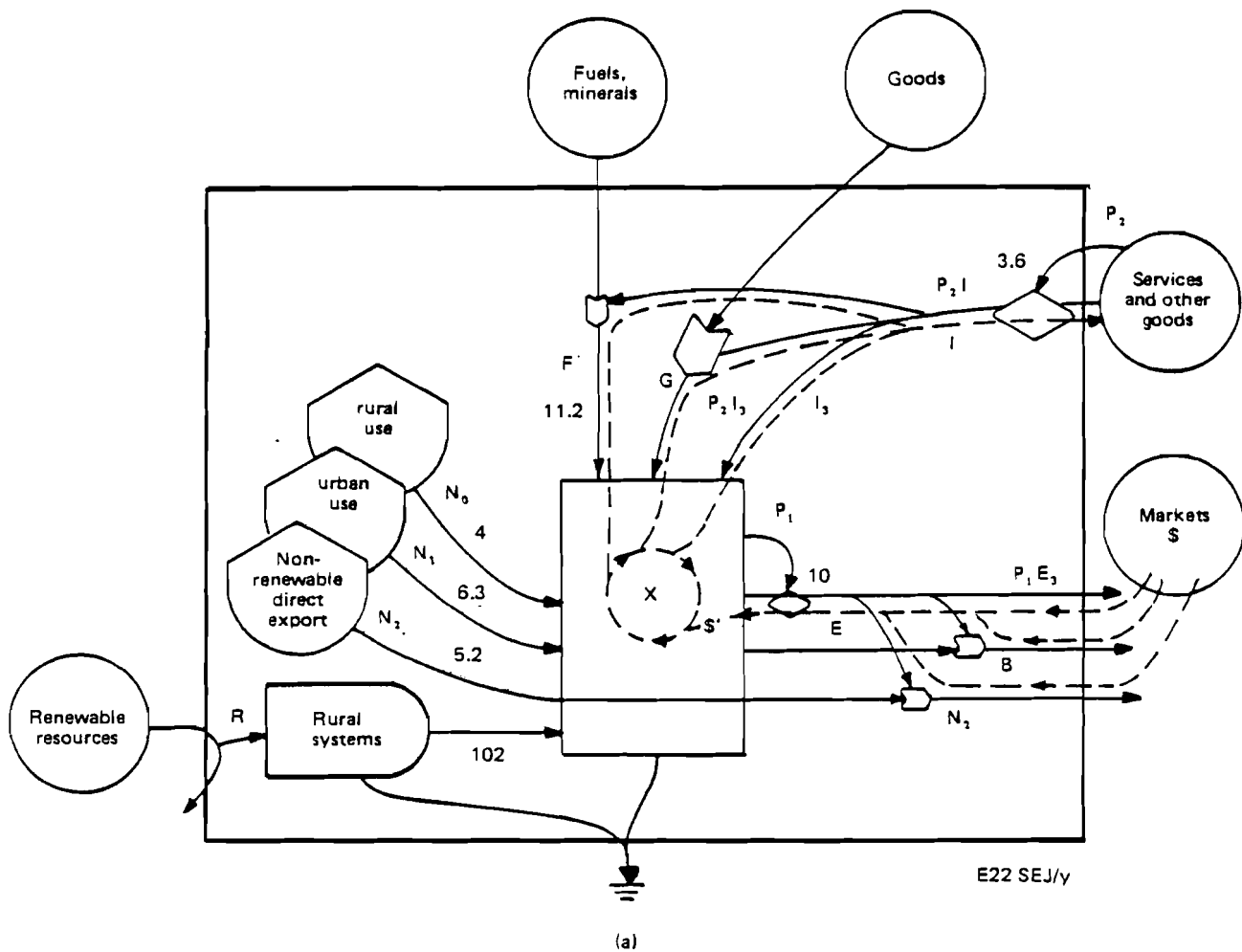

Figure 13.3. Summary of embodied energy flows of Brazil. See Table 13.1 and 13.3.

Table 13.3. Summary flows for Brazil in Figure 13.3.

Letter in Figure	Item		
R	Renewable sources used, SEJ/yr	102.0	E22
R'	River from Andes	55.0	E22
N	Nonrenewable sources flow within the country (SEJ/yr):		
	N_0 dispersed rural source (SEJ/yr)	4.0	E22
	N_1 concentrated use (SEJ/yr)	6.3	E22
	N_2 exported without use (iron)	5.17	E22
	$N_2' = N_2$ minus service	12.7	E22
F'	Imported minerals and fuels (SEJ/yr)	11.2	E22
F	F' minus services		
G	Imported goods (SEJ/yr)	-	
P_2I	Imported service (SEJ/yr)	3.62	E22
I	Dollars paid for imports (\$/yr) (1979, U.S.)	\$19.9	E9
E	Dollars paid for exports (\$/yr) (1979, U.S.)	15.2	E9
P_1E	Exported services (SEJ/yr)	10.0	E22
B	Exported products, transformed within the country (SEJ/yr) (rubber, wood)	-	
X	Gross National Product (\$/yr) (1979, U.S.)	\$2.135	E11
P_2	Ratio embodied energy to dollar of imports (SEJ/\$) (1979, U.S.)	\$1.85	E12
P_1	Ratio embodied energy to dollar of country and for its exports (SEJ/\$)	6.66	E12

Debt in 1983 was 83.0 E9 \$.

Footnotes for Table 13.3

- R Chemical potential of rain plus tide; this assumes salt-fresh interaction mainly at Amazon mouth.
- N_0 (Native forest fuelwood, 3.1; charcoal, 0.92) E22
- N_1 (Lumber, 5.7; coal 0.59) E22
- N_2 (Iron ore, 5.09; bauxite, 0.08) E22
- F' Imported minerals with services subtracted \$US (1979):
(fuel, 7.33; phosphate, 0.278, potash, 0.177; nitrogen, 0.16) E9/g
- Service = (\$US per year) (Energy-dollar ratio for US in 1979)
- $(\$8.0 \text{ E9}) (1.85 \text{ E12 SEJ}/\$) = 1.48 \text{ E22}$
- $F' = (12.71 - 1.48) \text{ E22} = 11.23 \text{ E22}$
- F (fuel, 11.9; phosphate, 0.44; potash, 0.32; nitrogen, 0.05 E22) = 12.71 E22
- G Not separated from total service
- $P_2 I$ (US Energy-dollar ratio for 1979) (Brazilian imports in \$)
 $(1.85 \text{ E12 SEJ}/\$) (19.9 \text{ E9 US\$ 1979})$
 $= 3.68 \text{ E22}$
- I & E (Fundacao Instituto 1981)
- $P_1 E$ $(6.6 \text{ E12 SEJ}/\$) (\$15.2 \text{ E9}) = 10.0 \text{ E22 SEJ}/y$
- B Export goods not isolated from services in overview calculation. Energy sources to wood, coffee, sugar, etc. already included in R
- X Cruzeiro to US\$ 1979 = 25.8 Cr/\$
(Fundacao Instituto 1980)
GNP, \$2.135 E11 US 1979.
- P_2 Appendix A5
- P_1 U/GNP; U from Table 13.4
 $(190.2 \text{ E22 SEJ}/y) / (\$2.135 \text{ E11}) = 8.9 \text{ E11 SEJ}/\$$

Table 13.4. Indices using embodied energy for overview of Brazil.

Item	Name of index and expression, See Figure.			
1	Renewable embodied energy flow	$R + R'$	157.0	E22
2	Flow from indigenous nonrenewable reserves	N	15.5	E22
3	Flow of imported embodied energy	$F+G+P_2 I$	14.8	E22
4	Total embodied energy inflows	$R+N+F+G+P_2 I$	190.9	E22
5	Total embodied energy used, U	$U=N_0+N_1+R+F+G+P_2 I$	178.2	E22
6	Total exported embodied energy	$B+P_1 E+N_2$	10.0	E22
7	Fraction of embodied energy used derived from home sources	$(N_0+N_1+R)/U$	0.91	
8	Exports minus imports	$(N_2+B+P_1 E)-(F+G+P_2 I)$	0.37	E22
9	Ratio of exports to imports	$(N_2+B+P_1 E)/(F+G+P_2 I)$	1.025	
10	Fraction used, locally renewable	R/U	0.83	
11	Fraction of use purchased	$(F+G+P_2 I)/U$	1.8	
12	Fraction used that is imported service	$P_2 I/U$	0.03	
13	Fraction of use that is free	$(R+N_0)/U$	0.86	
14	Ratio of concentrated to rural	$(F+G+P_2 I+N_1)/(R+N_0)$	0.19	
15	Use per unit area (9.18 E12)	$U/(\text{area})$	2.08	E11 SEJ/m ²
16	Use per capita (121 E6 population)	$U/(\text{population})$	1.57	E16 SEJ/per.
17	Renewable carrying capacity at present living standard	$(R/U)(\text{population})$	100.0	E6 people
18	Developed carrying capacity at same living standard	$8(R/U)(\text{population})$	800.0	E6 people
19	Fuel per person	$(\text{fuel use})/(\text{pop.})$	1.55	E15 SEJ/pers.
20	Fraction electric	$(\text{total elect.})/U$	0.07	

Either on a money (9%) or an embodied energy basis (9%) the exports and imports are a small proportion of the total system. Although in dollars there was an export to import ratio of 1.31 in embodied energy terms, the ratio in embodied energy terms was about balanced (1.025). Brazil has a high degree of self-sufficiency and continuing availability of resources.

Indices for degree of economic development are intermediate indicating a partially developed economy (Energy per dollar, ratio of concentrated to rural energy use, fraction electric; see Table 13.4).

The energy per person is large where environmental resources are included. In other words a family with a dooryard garden living along an Amazon tributary has a substantial and varied existence although the part of their living passing through the monetized economy is small. To the extent that the shifting agriculture is renewable, these resources are renewable, although the press of population reproduction and immigration is increasing the density of people relative to the forest making the pattern more and more one of mining the forest life support role.

The various indices show a good energy basis, little justifying the difficult economic state and loan default threats in 1983. Perhaps misunderstanding the real energy basis of the economy and the net energy of alternatives caused errors. For example, loan capital went into little-yielding alcohol, nuclear plants, and exporting raw materials of high embodied energy for very little return, etc. Devaluing the currency was intended to bring in a better balance of trade, but may have done the opposite. Where a country exports raw materials, it gives the purchaser even more embodied energy per dollar.

Howard T. Odum
*Environmental Engineering Sciences,
University of Florida, Gainesville*

Gordon de R. Innes
*New South Wales Department of
Environment and Planning, Sydney,
Australia*

David Scienceman
Farm Clubs of Australia

Michael V. Thomas
*Agricultural Engineering, University
of Florida, Gainesville*

14. ENERGY ANALYSIS OVERVIEW OF AUSTRALIA

This section is an embodied energy evaluation of the main features of Australia, a sparsely populated nation-continent (Figure 14.1) with large central desert, long coral reefs and wide shelf, a history that began with grazing and mining, but with its people now predominately urban. Some of the distinctive factors such as water limitations are shown in the energy diagram (Figure 14.2).

ACKNOWLEDGMENT

Calculations in this chapter were completed at the International Institute for Applied Systems Analysis at Laxenburg, Austria, in the summer of 1983. Work was initiated with papers by David Scienceman and Michael V. Thomas done while participating in energy analysis project of the Center for Wetland, University

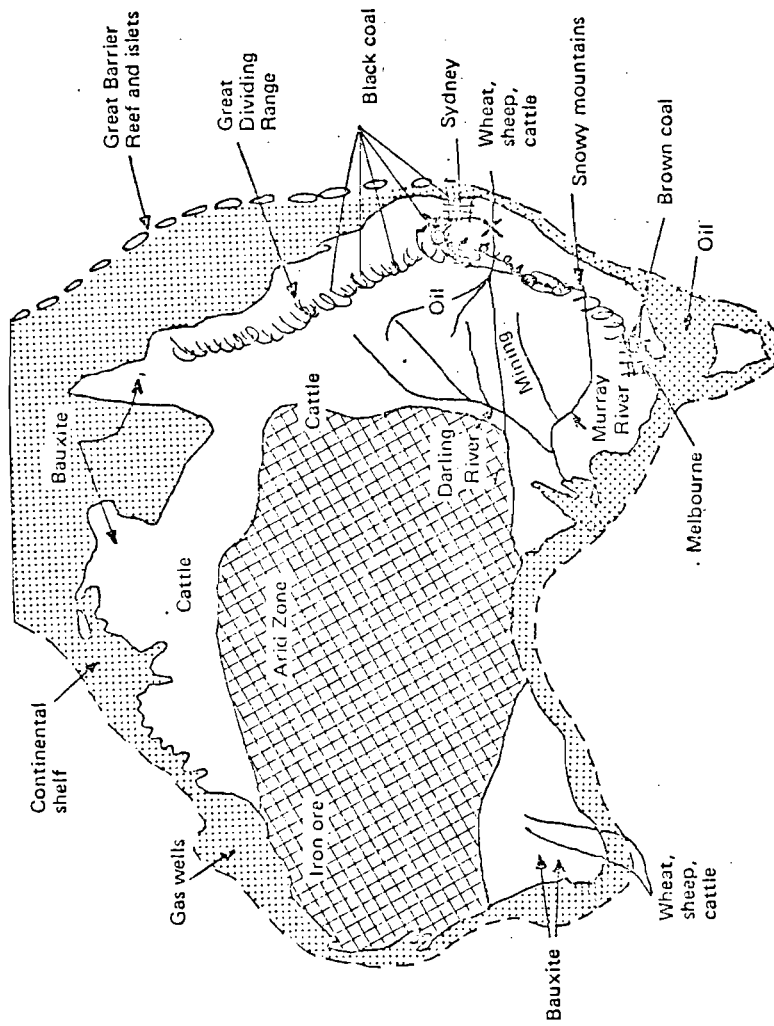

Figure 14.1 Main features of Australia.

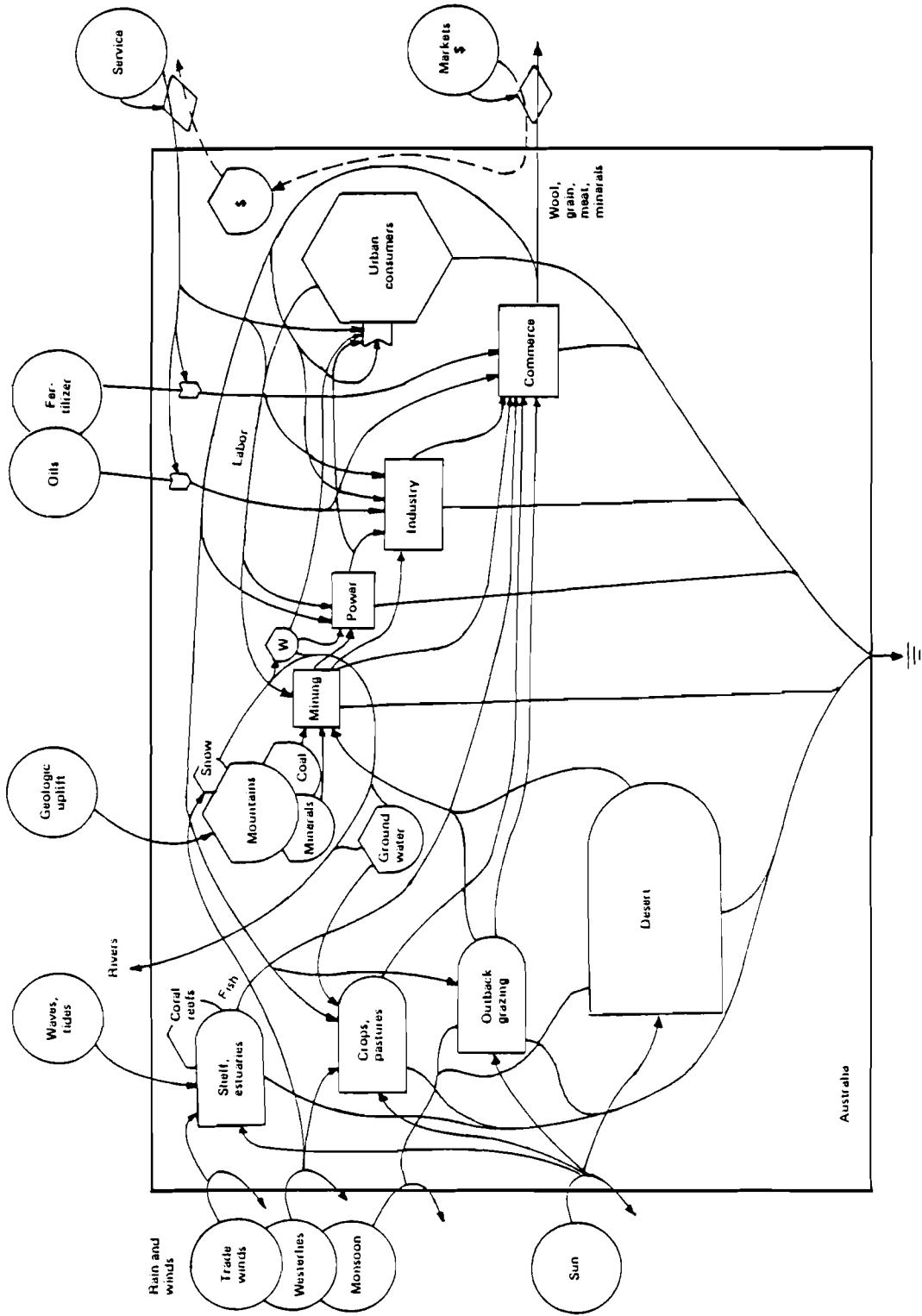

Figure 14.2 Energy diagram of Australia.

of Florida, Gainesville in 1982. Gordon Innes participated as a Churchill Fellow on leave from Planning Division, Government of New South Wales, Sydney, Australia, in Gainesville and at Laxenburg.

METHODS

Methods of energy analysis were those given in sections 1-5. The Australian energy system was diagrammed and evaluated in energy terms.

A complex national diagram was drawn using the energy systems language. An aggregated diagram was used to represent totals for overall comparisons. Several ratios were calculated to compare Australia with other countries and to support predictions.

RESULTS

Figure 14.2 shows the energy system of Australia which includes outside energy sources, productive land uses, mineral storages, industries, and the primarily human systems.

The energy flows are summarized in Table 14.1 and the storages in Table 14.2. Since the embodied solar energy in the chemical potential in rain is larger than any of the other solar-based sources, it and the tidal energy were used as the country's outside renewable energy flow for further calculations.

Table 14.1 Energy flows for Australia.

Footnote	Energy Type	Actual Energy J/y	ETR SEJ/y or SEJ	Solar Embodied Energy E22 SEJ/y
1	Direct sunlight	5.32 E22	1	5.32
2	Wind	2.19 E19	663	1.45
3	Rain, chemical potential	2.12 E19	1.54 E3	32.8
4	Rain, geopotential	1.014 E18	8.88 E3	0.90
5	Tide	0.913 E18	2.36 E4	2.15
6	Wave energy	0.56 E19	2.59 E4	14.5
7	Earth loss, 0.95 E14 g/m ² /y	--	1.71 E9 J/g	16.2
8	Top soil loss	5.5 E18	6.25 E4	34.3
9	Oil			
	production	9.34 E17	5.3 E4	4.95
	imports (see footnote 21)	--	--	0.904
	exports	--	--	0.48
	consumed	1.36 E18	5.3 E4	7.2
10	Gas			
	natural gas	0.274 E18	4.8 E4	1.31
	ethane	7.29 E12	4.8 E4	0.035
	Liquified Petroleum Gas (LPF)			
	production	7.38 E16	7 E4	0.52
	use in Australia	--	--	1.95
	LPG export	7.22 E16	7 E4	0.51
11	Coal			
	production	2.08 E18	4 E4	8.32
	export	1.18 E18	4 E4	4.72
	use	0.79 E18	4 E4	3.15
	brown coal use	2.89 E17	4 E4	1.15
12	Uranium production	6.82 E17	1.79 E3	0.12
13	Electricity	3.10 E17	1.59 E5	4.93
<u>Exports</u>				
9-12	Fuels	--	--	5.71
14	Grains	7.71 E15	2.7 E4	0.02

Table 14.1 continued.

Footnote	Energy Type	Actual Energy J/g	ETR	Solar Embodied Energy E22 SEJ/y
15	Beef, veal	1.58 E16	4.0 E6	6.3
16	Sheep	0.40 E15	1.7 E6	6.8
	Wool	1.03 E16	3.8 E6	3.9
17	Sugar	4.15 E16	8.4 E4	0.35
18	Butter	1.06 E15	1.3 E6	0.14
19	Iron, 3.0 E6 T/g	--	1.2 E15/T	0.36
	Iron ore, 74.7 E6 T/y	--	8.5 E8/g	6.39
20	Alumina, 6.32 E12 T/y	--	8.58 E8/g	0.57
<u>Imports</u>				
21	Fuels	162.6 E15	--	0.904
22	Phosphate rock, 1.51 E6 T/y	--	1.41 E10/g	4.26
23	Potassium fertilizer, 1.57 E5 T/g	--	9.5 E8/g	0.03

Footnotes to Table 14.1

1. Direct sunlight

Average insolation, $5.18 \text{ E9 J/m}^2/\text{y}$ (Ballentyne 1976); Land area including Tasmania, 7.682 E12 m^2 (Australian Bur. Stat. 1981a).

Area of continental shelf, 2.573 E12 m^2 estimated from National Geographic Atlas (Nat. Geo. At. 1981); total area, 10.255 E12 m^2 .

Insolation over land:

$$(5.18 \text{ E9 J/m}^2/\text{y}) (7.682 \text{ E12 m}) = 3.98 \text{ J/y}$$

Insolation over land and shelf:

$$(5.18 \text{ E9 J/m}^2/\text{y}) (10.255 \text{ E12 m}^2) = 5.31 \text{ E22 J/y}$$

Footnotes to Table 14.1 continued.

2. Wind

Eddy viscosity assumed from Oakland California and Tampa, Florida (Swaney 1978), $2.8 \text{ m}^2/\text{s}$; Vertical velocity gradient estimated from 18 locations around Australia, 5 E-3 m/s/m (Australia, Dept. of Meteorology 1977)

$$(1 \text{ m}^2) (1000 \text{ m}) (1.23 \text{ kg/m}^3) (2.8 \text{ m}^3/\text{m/s}) (3.154 \text{ E7 s/y}) \\ (5 \text{ E-3 m/s/m})^2 (7.682 \text{ E12 m}^2) = 2.1 \text{ E19 J/y}$$

3. Rain, chemical potential

average rainfall, 0.42 m/y (Australian Bur. Stat. 1981a)

$$(0.42 \text{ m/y}) (10.25 \text{ E12 m}^2/\text{y}) (4.94 \text{ J/g}) (1 \text{ E6 g/m}^3) = 2.12 \text{ E19 J/y}$$

4. Rain, geopotential

mean elevation, 300 m (Australian Bur. Stat. 1981a);
runoff fraction, 0.107

$$(7.682 \text{ E12 m}^2) (300 \text{ m}) (0.107) (0.42 \text{ m/y}) (1 \text{ E3 kg/m}^3) (9.8 \text{ m/s}^2) \\ = 1.014 \text{ E18 J/y}$$

5. Tide

$$(9.8 \text{ m/s}^2) (2.573 \text{ E12 m}^2) (0.5) (706 \text{ tides/y}) (1 \text{ m}^2) \\ (1.025 \text{ E3 kg/m}^3) = 0.913 \text{ E18 J/y}$$

6. Wave energy

mean wave height, 0.6 m (Lawson and Youll 1977; Lawson and Abernathy 1977)

$$(0.125) (1.025 \text{ E3 kg/m}^3) (9.8 \text{ m/s}^2) (0.6 \text{ m})^2 (26.2 \text{ m/s}) \\ (3.154 \text{ E7 s/y}) (30 \text{ E6 m}) (0.5) = 0.56 \text{ E19 J/y}$$

7. Earth

Erosion rate $75 \text{ T/km}^2/\text{g}$ over $1/3 \text{ } 2.56 \text{ E12 m}^2$ of Australia; deserts neutral (Snead 1980); earth formation, $11 \text{ mm}/1000 \text{ g}$ (Ollier, 1981); 0.5 assumed lost during formation (Appendix A18)

$$(11 \text{ E-6 m/y}) (2.3 \text{ E6 g/m}^3) (0.5) = 12.65 \text{ g/m}^2/\text{y} \\ (75 \text{ T g/m}^2/\text{y}) (2.56 \text{ E12 m}^2) - (12.65 \text{ g/m}^2/\text{y}) (7.682 \text{ E12 m}^2) \\ = -0.95 \text{ E14 g/m}^2/\text{y}$$

Footnotes to Table 14.1 continued.

8. Topsoil

Balance between natural vegetation building soil and erosion from farmed areas; other areas assumed neutral.

Erosion rate used for New Mexico croplands, 290 g/m²/y (Larson et al. 1983); topsoil formation rate assumed 500 y or 1260 g/m²/y (Appendix A18); forest land generating new soil, 41.9 E10 m².

$$(290. \text{ g/m}^2/\text{y}) (19.7 \text{ E10 m}^2 \text{ cropland})$$

$$(290. \text{ g/m}^2/\text{y}) (17.9 \text{ E10 m}^2 \text{ cropland}) - (1260 \text{ g/m}^2/\text{y}) (41.9 \text{ E10 m}^2)$$

$$= 4.16 \text{ E14 g/y}$$

$$(81.2 \text{ E14 g/y}) (5.4 \text{ kcal/g}) (4186 \text{ J/kcal}) (0.03) = 5.5 \text{ E18 J/y}$$

9. Oil

Australian energy statistics (1981-1982)

Production: 25,323 E bl; 36.9 E6 J/l

$$(2.53 \text{ E 10 l}) (3.69 \text{ E7 J/l}) = 9.34 \text{ E17 J/y}$$

Consumed:

1.356 E18 J/y (Dept. Nat. Dev. 1982)

Exported:

Fuel	Heat content	J/g E15	ETR	E22 SEJ/y
Automotive gasoline	0.286 x 34.36	9.8	6.6 E4	0.06
Aviation gasoline	0.023 x 33.01	0.76	6.6 E4	0.01
Aviation turbine fuel	0.326 x 36.89	12.0	6.6 E4	0.08
Automotive diesel oil	0.523 x 38.21	20.0	5.3 E4	0.11
Industrial and marine diesel fuel	0.043 x 38.89	1.67	5.3 E4	0.01
Fuel oil	0.244 x 40.10	9.48	5.3 E4	0.05
Lubricating oils and other	0.277 x 40.10	11.1	5.3 E4	0.06
All other	0.474 x 40.10	19.0	5.3 E4	0.10
Total				0.48

Footnotes to Table 14.1 continued.

10. Gas

Natural gas

production, 7.016 E12 ℓ/y , heat content, 39 E3 J/ ℓ

$$(7.016 \text{ E12 } \ell/y) (39 \text{ E3 J}/\ell) = 0.274 \text{ E 18 J/y}$$

Ethane

$$(1.10 \text{ E11 } \ell/y) (66.35 \text{ J}/\ell) = 7.29 \text{ E12}$$

Liquified Petroleum Gas

Production:

$$(2.917 \text{ E9 } \ell/y) (25.304 \text{ E6 J}/\ell) = 7.38 \text{ E16 J/y}$$

Export:

$$(2.855 \text{ E9 } \ell/y) (25.3 \text{ E6 J}/\ell) = 7.22 \text{ E16 J/y}$$

LPG Use

$$(7.38 - 7.22) \text{ E16} = 0.16 \text{ E16 J/y}$$

Gas use, by difference.

11. Coal

Production, 7.09 E7 T/y; export, 3.79 E7 T/y; heat content, 29.4 E9 J/T (average of coal from Queensland coal and New South Wales); coal used in Australia heat content, 26.7 E9 J/T; brown coal heat content, 9.47 E9 J/T.

Production:

$$(7.09 \text{ E7 T/y}) (29.4 \text{ E9 J/T}) = 2.08 \text{ E18 J/y}$$

Export:

$$(3.79 \text{ E7 T/y}) (29.4 \text{ E9 J/T}) = 1.11 \text{ E18 J/y}$$

Use (final demand) 0.79 E18 J/y

Brown coal

Production:

$$(30.485 \text{ E6 T/y}) (9.47 \text{ E9 J/T}) = 2.89 \text{ E17 J/y}$$

Footnotes to Table 14.1 continued

12. Uranium

Export currently suspended, production,
(1452 T/y) (0.47 E15 J/T) = 6.82 E17 J/y

13. Electricity

85,981 E6 kwh/y = 3.10 E17 J/y

Exports

14. Grains

Australian yearbook (Aust. Bur. Stat. 1981a), 1977 \$

wheat 1.83 E17 J/y @ \$1.011 E9

barley 2.22 E16 J/y @ \$0.120 E9

oats 3.66 E15 J/y @ \$0.019 E9

total 7.71 E15 J/y @ \$1.150 E9

15. Beef and veal 1.58 E16 J/y @ \$0.826 E9

16. Sheep meat 0.40 E16 J/y @ \$0.18 E9

Wool 1.03 E15 J/y @ \$0.99 E9

17. Sugar 4.15 E16 J/y @ \$0.536 E9

18. Butter 1.06 E15 J/y @ \$0.044 E9

19. Iron export

1.60 E6 T/y iron and steel imports; 0.519 E6 T/y pig iron;
0.89 E6 T/y iron ore concentrate; total, 3.0 E6 T/y; ETR
average of iron and steel, 1.2 E15 SEJ/J

20. Aluminum

alumina and bauxite: 6.69 E6 T/y produced

6.32 E6 T/y exported

Footnotes to Table 14.1 continued

21. Fuel imports - see summary for 1977-1978:

Fuel	Heat content	J/g E15	ETR	SEJ/y
Automotive gasoline	758 x 34.360	E12 = 26.03	6.6 E4	0.172
Aviation gasoline	73 x 33.010	E12 = 2.41	6.6 E4	0.016
Aviation turbine fuel	100 x 36.890	E12 = 3.69	6.6 E4	0.024
Automotive diesel oil	529 x 38.211	E12 = 20.21	5.3 E4	0.107
Industrial and marine diesel fuel	382 x 38.211	E12 = 14.86	5.3 E4	0.079
Fuel oil	2001 x 40.1	E12 = 80.24	5.3 E4	0.425
Lubricating oils and greases	54 x 40.1	E12 = 2.17	5.3 E4	0.012
Oil shale	324 x 40.1	E12 = 12.99	5.3 E4	0.069
Total		162.62 E15		0.904

22. Phosphate rock, Australian Bureau of Statistics 1981a

23. Potassium fertilizer, Australian Bureau of Statistics 1981a

Table 14.2 Energy storages in Australia.

Footnote	Energy Type	Actual Energy J	ETR SEJ/J or SEJ/gm	Solar Embodied Energy SEJ E23
1	Crude oil and condensate	15 E18	5.3 E4	7.95
2	Natural gas	24 E18	4.8 E4	11.52
3	Liquified petroleum gas	3 E18	7.0 E4	2.1
4	Black coal	788 E18	3.98 E4	314.0
5	Brown coal	355 E18	3.98 E4	141.0
6	Uranium	168 E18	1.79 E3	30.1
7	Ground water	4.94 E21	2.35 E4	1161.0
8	Biomass of wood	2.09 E20	3.3 E4	69.0
9	Top soil	1.49 E20	6.25 E4	93.0

Footnotes to Table 14.2

1-6. Australian Energy Statistics (Dept. Nat. Dev. 1982): figures are for estimated recoverable reserves only.

7. UNESCO (1978) Water Resources of the Earth

8. Biomass of wood

Total forest area, 4.30 E7 ha (Australian Bureau of Statistics 1981a); organic matter in dry forest, 291 t/ha (Lugo and Brown 1982)

(291T/ha) (4.3 E7 ha) (4 E6 kcal/T) (4186 J/ha) = 2.09 E20 J

9. Top soil

Desert and arid range not evaluated;

Organic matter in dry forest soil, 142 T/ha (Brown and Lugo 1982); forest area, see note 8;

Organic matter in farm land, 27.4 T/ha;

Footnotes to Table 14.2 continued

(Brady 1974); area of cropland, $17.9 \text{ E}10 \text{ m}^2$ (Dept. Nat. Dev. 1981b)

$$(142 \text{ T/ha})(4.3 \text{ E}7 \text{ ha}) + (27.4 \text{ T/ha})(17.9 \text{ E}6 \text{ ha}) = 6.59 \text{ E}9 \text{ T}$$

$$(6.59 \text{ E}9 \text{ T organic})(1 \text{ E}6 \text{ g/T})(5.4 \text{ kcal/g})(4186 \text{ J/kcal})$$

$$= 1.49 \text{ E}20 \text{ J}$$

Table 14.3 Summary flows for Australia, 1977-1978. See Figure 14.3.

Letter in Figure 14.3	Item	
R	Renewable sources used, SEJ/yr (rain, chem)	35 E22
N	Nonrenewable sources flow within the country (SEJ/yr):	
	N_0 Dispersed rural source (SEJ/yr)	50.5 E22
	N_1 Concentrated use (SEJ/yr)	14.4 E22
	N_2 Exported without use	14.8 E22
F	Imported minerals and fuels (SEJ/yr)	6.0 E22
G	Imported goods (SEJ/yr)	2.0 E22
$P_2 I_3$	Imported service (SEJ/yr)	1.0 E22
I	Dollars paid for imports (\$/yr)	\$ 15.03 E9
I_3	Dollars paid for services	\$ 3.86 E9
E	Dollars paid for exports (\$/yr)	\$ 14.0 E9
E_3	Dollars received for services	\$ 1.72 E9
$P_1 E_3$	Exported services (SEJ/yr)	2.1 E22
B	Exported products, transformed within the country (SEJ/yr)	17.50 E2
X	Gross National Product (\$/yr)	\$ 90.25 E9
P_2	Ratio embodied energy to dollar of imports (SEJ/\$) (US)	2.37 E12
P_1	Ratio embodied energy to dollar of country and for its exports (SEJ/\$) 1977-1978 \$	12.07 E12

Footnotes to Table 14.3

Data were taken from Table 14.1 as follows

- R Rain representing the largest of those from the biosphere plus tide.
- N_0 Soil use (erosion).
- N_1 Fuel, bauxite and iron.
- N_2 Coal, iron, alumina, zinc.
- F Petroleum, motor fuels, phosphate, potash.
- G Machinery, oil, lubricants.
- P_2I_3 Services using US energy dollar ratio corrected by subtracting services in fuels (F) and goods (G) using dollar costs.
- I_3 Australian economic statistics (Reserve Bank of Australia May 1982).
- E Total exports (Australian economic statistics, May 1982).
- E_3 Exported services, Australian economic statistics, E minus dollars already included in minerals and fuels, exports (N_2) and goods (B).
- P_2E_3 Services calculated as product of E_3 and Australian energy dollar ratio (P_2).
- B Coal, meat, cereal, wood, wool, sugar, butter, iron, see Table 14.8.
- X GNP (Australian economic statistics, May 1982).
- P_2 US energy-dollar ratio
- P_1
$$\frac{R + N_0 + N_1 + F + G + P_2I_3}{X}$$

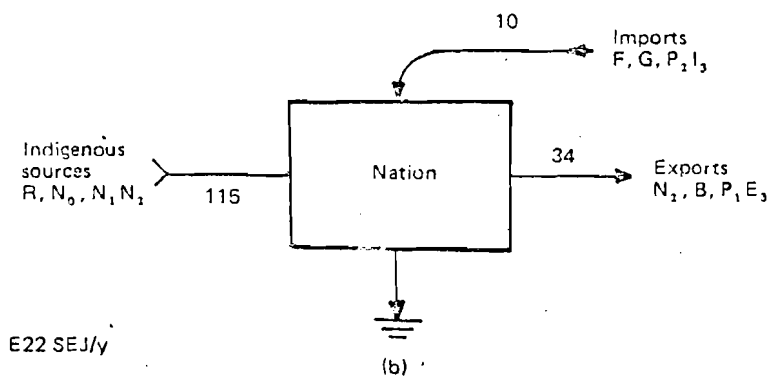
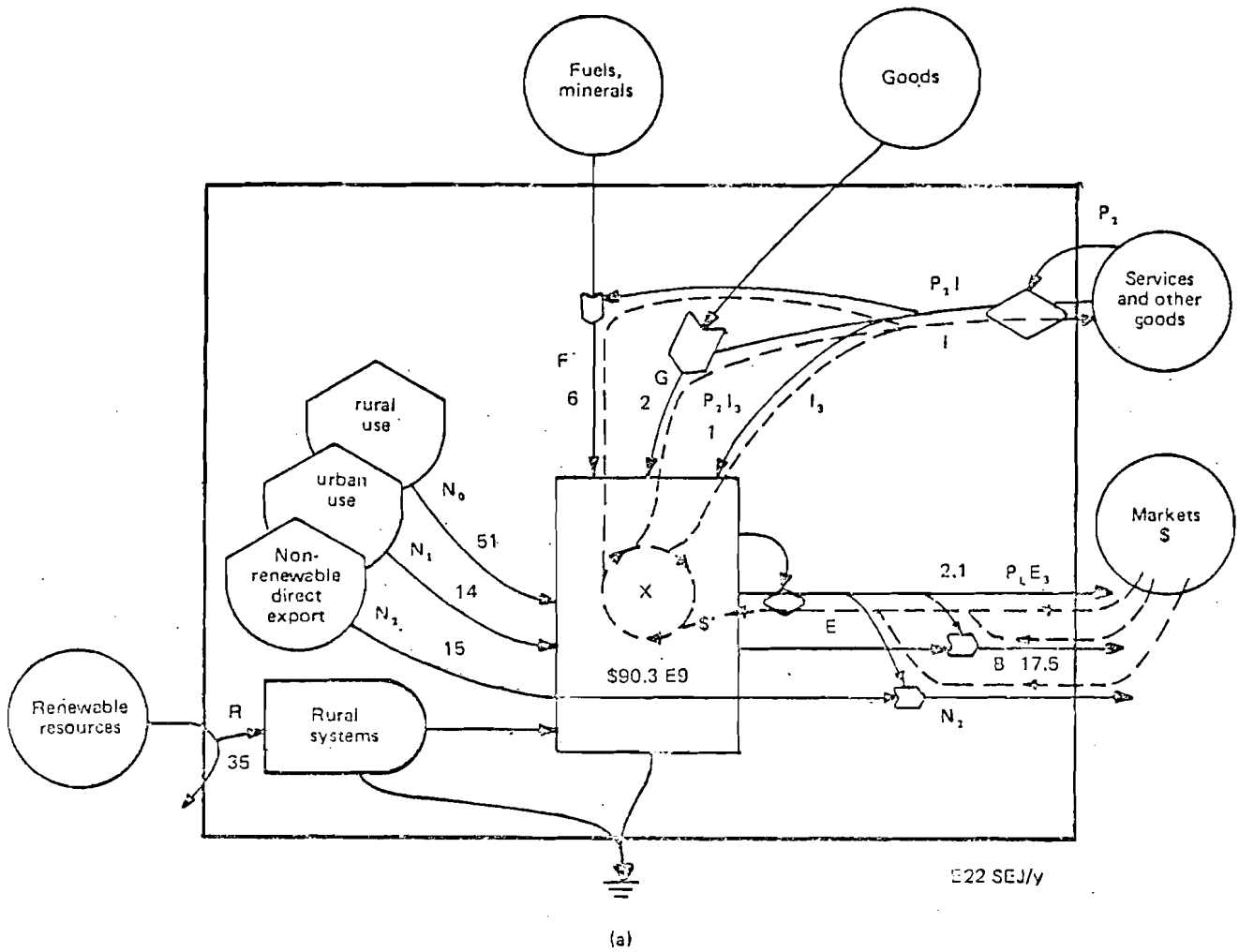

Figure 14.3 Summary diagram of the embodied energy flows of Australia, 1977-1978. An evaluation table is given as Table 14.3. Indices from these values are calculated in Table 14.4.

Table 14.4 Indices using embodied energy for overview of Australia. See Figure 14.3.

Item	Name of index and expression		
1	Renewable embodied energy flow	R	35 E22
2	Flow from indigenous non-renewable reserves	N	79.6 E22
3	Flow of imported embodied energy	$F+G+P_2I_3$	9 E22
4	Total embodied energy inflows	$R+N+F+G+P_2I_3$	123.6 E22
5	Total embodied energy used, U	$U=N_0+N_1+R+F+G+P_2I_3$	108.9 E22
6	Total exported embodied energy	$B+P_1E_3+N_2$	34.4 E22
7	Fraction of embodied energy used derived from home sources	$(N_0+N_1+R)/U$	91.7
8	Exports minus imports	$(N_2+B+P_1E_3)-(F+G+P_2I_3)$	24.3 E22
9	Ratio of exports to imports	$(N_2+B+P_1E_3)/(F+G+P_2I_3)$	3.4
10	Fraction used, locally renewable	R/U	0.32
11	Fraction of use purchased	$(F+G+P_2I_3)/U$	0.09
12	Fraction used that is imported service	P_2I_3/U	0.008
13	Fraction of use that is free	$(R+N_0)/U$	0.79
14	Ratio of concentrated to rural	$(F+G+P_2I_3+N_1)/(R+N_0)$	0.29
15	Use per unit area (7.68 E12 m ²)	U/(area)	14.2 E10 SEJ/m ²
16	Use per capita (14.5 E6 population)	U/(population)	7.6 E16 SEJ/person
17	Renewable carrying capacity at present living standard	(R/U) (population)	4.6 E6 people
18	Developed carrying capacity at same living standard	8 (R/U) (population)	71.0 E6 people
19	Fuel use per person	(Fuel use)/(population)	93.3 E14 SEJ/person
20	Fraction electric	(electric power)/U	0.45

Summary

Tables 14.3 and 14.4 and Figure 14.3 show large embodied energy flows of natural resources as the main basis for the country. Part of this (32%) is renewable, and another large part is non-renewable, indigenous coal, fuel, and soil reserves. On a dollar basis the imports were about 17% of GNP; whereas, the embodied energy of imports was only 10% of the energy basis.

The embodied energy of exports was three times that of imports largely due to export of fuels and minerals. Trade seems to be stimulating partner nations far more than Australia. Usually environmental resources attract investments that bring in high quality fuels and other imports to match their large indigenous energies. The very low ratio of imports to indigenous flows shows that this basis for economic stimulus is mainly missing in Australia.

Because of the large arid areas, the energy density is low; but with relatively few people, the energy per person is large.

More economic growth may be possible by importing more resources, exporting less, and developing more ways to utilize the resources of a dry continent.

Elisabeth C. Odum
*Santa Fe Community College,
Gainesville, Florida*

Howard T. Odum
*Environmental Engineering Sciences
University of Florida, Gainesville*

15. ENERGY ANALYSIS OVERVIEW OF INDIA

Introduction

This is an energy analysis of the system of India. By estimating the embodied energy of environmental resources, fuels, international trade, and their interactions, perspectives are gained as to how the country works and what is important.

India is the seventh largest country in the world, with an area about half that of the United States. (Figure 15.1). It is separated from the rest of Asia by mountains and the sea. Bounded by the Himalayan mountains in the north, it stretches southwards tapering off into the Indian Ocean. It covers an area of 329 million m².

The mainland comprises four well-defined regions; namely, the great mountain zone of the Himalayas, the highest mountains in the world; the Indo-Gangetic Plain formed by the basins of the Indus, Ganges and Brahmaputra rivers; the desert region, and the southern peninsula.

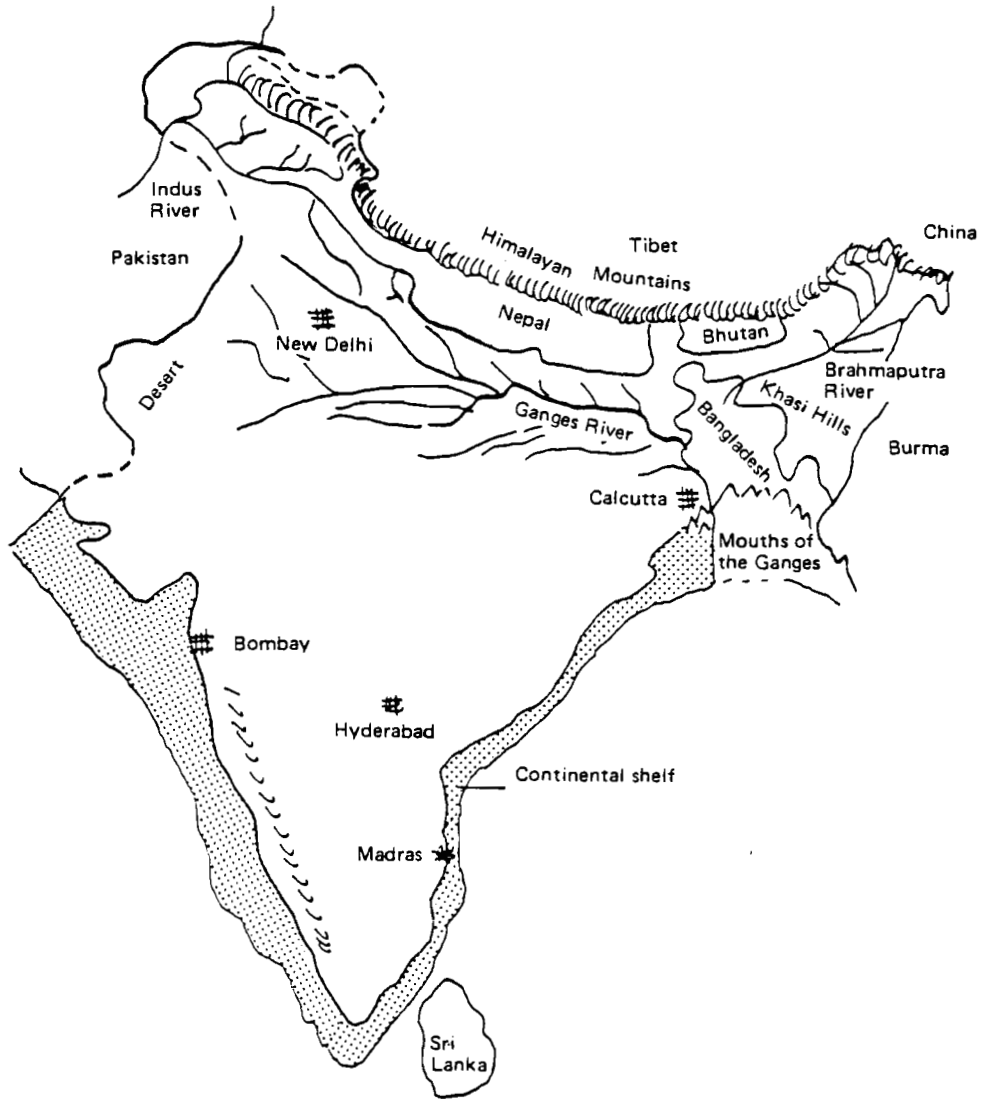

Figure 15.1. Map of India.

Rainfall varies from a few centimeters a year in the west, to 1000 centimeters in the Khasi Hills in the northeastern corner, often considered one of the wettest places in the world. Most of the rainfall comes from the inblowing summer monsoon winds. Periodic cyclonic storms (hurricanes) are part of the weather system's energy inflow. With such a great variation in rainfall and a range of about 30° of latitude and of nearly 9,100 meters of altitude, there is a great variety of vegetation, both in forests and agricultural products.

In 1978, the population was 630 million, with a growth rate of 2.2%. The population size is second to China's. The population density is 221/km², compared to 12/km² in the USSR and 381/km² in the Netherlands. Seventy-five percent of the people are rural, with a 36% literacy. Agriculture contributed nearly 1/2 of the national income. It is first in the world in agricultural production of ground nuts, and second in rice.

Over wide areas the soils have been degraded by erosion or by continuous cropping without much rotation or fertilizer. Forests, about 23% of the land, mostly government-owned, were used for wood production and grazing, with consumption much beyond the maximum sustainable yield.

Methods

Methods of energy analysis were those given in Sections 1-5. The Indian energy system was diagrammed and evaluated in energy terms. A complex national diagram was drawn using the energy systems language. An aggregated diagram was used to represent totals for overall comparisons. A study of the cattle system is

in Appendix A19. Several ratios were calculated to compare India with other countries and to support predictions. Export of raw products such as minerals and gems was not fully evaluated.

Results

. Figure 15.2 shows the energy system of India which includes outside energy sources, the Himalayas with its mineral resources, land uses of forests and agriculture, industries, and the urban system.

The energy flows are summarized in Table 15.1 and the storages in Table 15.2. Since the embodied solar energy in the chemical potential in rain is larger than any of the other solar-based sources, it (plus the tidal energy) was used as the country's outside renewable energy flow for further calculations.

The most important sources of commercial energy are coal and oil. Coal is its major indigenous nonrenewable fuel resource; at the present rate of use of the estimated reserves, the supply will last about 20 years. India relies on imports for meeting about 65% of its oil requirements. Coal and hydro power were used primarily for electricity production. Firewood, cow dung cakes and vegetable waste were used for rural heating and cooking.

Industrialization increased rapidly in the last decade. About 51% of the total energy use was based on fuels, both local and imported. Imports were industrial supplies, fuels, machinery, and food (in drought years). Exports were textile products, metal products and metals (especially iron ore), and agricultural products.

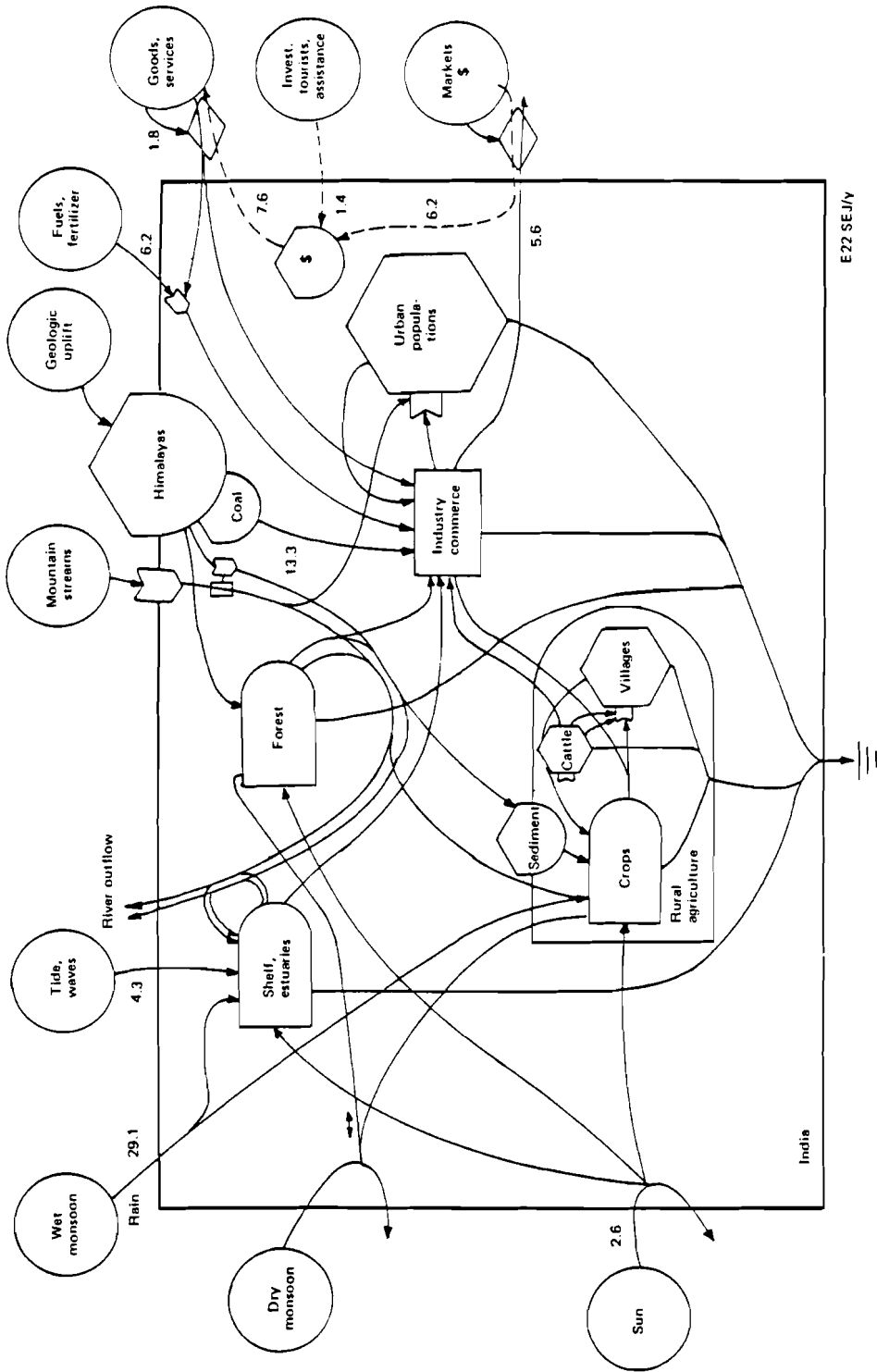

Figure 15.2. Energy diagram of India.

Table 15.1. Energy flows of India

Foot-note	Type of energy	Actual energy* J/y	Energy transfor. ratio** SEJ/J	Embodied solar energy E22 SEJ/y
1	Direct sunlight	2.62 E22	1.0	2.62
2	Storms	6.76 E16	4.08 E4	0.28
3	Rain, chem.potential	1.89 E19	15423	29.1
4	Rain, geopotential	8.0 E18	8888	7.1
5	Tide	1.81 E18	23564	4.27
6	Waves	4.6 E17	2.59 E4	1.08
7	Rivers, sediment	1.65 E19	-	-
8	Rivers, geopotential	9.7 E18	23564	22.8
9	Earth cycle	3.95 E12	2.71 E10	10.7
10	Net deposition of earth, 73.7 E6 T	-	1.71 E15 J/T	12.6
11	Net loss of topsoil	1.59 E18	6.24 E4	9.9
12a	Electricity, thermal	2.17 E17	15.9 E4	3.45
12b	Electricity, hydro	1.70 E17	15.9 E4	2.70
12c	Electricity, nuclear	9.97 E15	15.9 E4	0.158
13	Coal production & use	3.34 E18	3.98 E4	13.3
14	Oil production & use	4.86 E17	5.3 E4	2.58
15	Natural gas prod. & use	5.27 E16	4.8 E4	0.25
16	Roundwood prod. & use	3.41 E18	3.49 E4	11.9
17	Fuel wood	2.4 E16	3.49 E4	0.0038
18	Dung production & use	1.8 E10	3.0 E5	5.27 E15
Imports, 1978				7.6 E9 \$
19	Goods imported:			0.50
	1) Machinery	2.36 E5 T	62.11 E14 SEJ/T	0.147
	2) Iron & steel	2.18 E6 T	16.58 E14 SEJ/T	0.36
20	Fuel oil imported	8.63 E17	5.3 E4	4.57
21	Phosphate imported	1.03 E6 T	1.44 E16 SEJ/T	1.48
22	Nitrogen fertilizer imports	1.9 E6 T	4.19 E15 SEJ/T	0.79
23	Services & other goods imp.	-	-	1.79
Exports, 1978				6.2 E9 \$
24	Iron ore exported	21.2 E6 T	8.55 E14 SEJ/T	1.81
25	Services & other goods exp.	-	-	3.9
26	Tourism	-	-	0.4 E9 \$
27	International assistance	-	-	1.1 E9 \$

Footnotes for Table 15.1

* See Table 2.1 for formulae and explanations for each category of actual energy calculations.

** See Table 3.1 for energy transformations given here.

1. Direct sunlight

Land area: $3.29 \text{ E6 km}^2 = 3.29 \text{ E12 m}^2$; Est. $172 \text{ kcal/cm}^2/\text{y}$ (Sellers 1965). Shelf area est. from map: 0.354 E6 km^2 :
Total area = 3.64 E6 km^2

(area including shelf) (average insolation)

$$(3.64 \text{ E6 km}^2) (1 \text{ E6 m}^2/\text{km}^2) (1.72 \text{ E6 kcal/m}^2/\text{y}) (4186 \text{ J/kcal}) \\ = 2.62 \text{ E22 J/y}$$

2. Storms

Average number of storms: $7.4 /\text{y}$ (Rao 1975); Appendix A14.

$$(\text{storms/y}) (\text{m}^2/\text{storm}) (2 \text{ days/storm}) (4.85 \text{ E5 kcal/m}^2/\text{d}) \\ (4186 \text{ J/kcal}) (0.03) (0.10) \\ (7.4 /\text{y}) (7.5 \text{ E8 m}^2) (2\text{d}) (4.85 \text{ E5 kcal/m}^2/\text{d}) (4186 \text{ J/kcal}) \\ (0.03) (0.10) = 6.76 \text{ E16 J/y}$$

3. Rain, chemical potential

Rainfall: 105 cm/y (Rao 1975); area including shelf: 3.64 E12 m^2 ; G: 4.94 J/g (Table 2.1)

(area incl. shelf) (rainfall) (G)

$$(3.64 \text{ E12 m}^2) (105 \text{ cm/y}) (1 \text{ E-2 m/cm}) (1 \text{ E6 g/m}^3) (4.94 \text{ J/g}) \\ = 1.89 \text{ E19 J/y}$$

4. Rain geopotential

Average elevation: est. from map, 582 m .

(mean elevation) (runoff) (density) (gravity)

$$(582 \text{ m}) (1.4 \text{ E12 m}^3/\text{y}) (1 \text{ E3 kg/m}^3) (9.8 \text{ m/s}^2) \\ = 8.0 \text{ E18 J/y}$$

Footnotes for Table 15.1. continued

5. Tide absorbed on continental shelf

Established average, 3.8 m (Snead 1980);
Shelf area: $0.354 \text{ E}12 \text{ m}^2$ (Footnote 1)

$$\begin{aligned} & (\text{area of shelf}) (0.5) (\text{tides /y}) (\text{ht. squared}) (\text{density}) \\ & (\text{gravity}) (\% \text{ absorbed}) \\ & (.354 \text{ E}12 \text{ m}^2) (0.5) (706 \text{ /y}) (3.8 \text{ m})^2 (1.025 \text{ E}3 \text{ kg/m}^3) \\ & (9.8 \text{ m/s}^2) (.1) = 1.81 \text{ E}18 \text{ J/y} \end{aligned}$$

6. Waves

Estimated straight coastline: 3000 km; wave height assumed similar to other trade-wind region, South Florida: 0.6 m in 10 m water.

$$(3.35 \text{ E}7 \text{ kcal/m/y}) (4186 \text{ J/kcal}) (3.0 \text{ E}6 \text{ m}) = 4.2 \text{ E}17 \text{ J/y}$$

7. Rivers, physical potential in sediment load.

Erosion: $1100.3 \text{ m}^3/\text{km}^2/\text{y}$; ave. sediment load; density: 0.8 g/cm^3 (Rao 1975).

$$\begin{aligned} & (\text{erosion vol.}) (\text{density}) (\text{area}) (\text{gravity}) (\text{ave. elevation}) \\ & (1100.3 \text{ m}^3/\text{km}^2/\text{y}) (0.8 \text{ g/cm}^3) (1 \text{ E}6 \text{ cm}^3/\text{m}^3) (3.29 \text{ E}6 \text{ km}^2) \\ & (9.8 \text{ m}^2/\text{s}^2) (582 \text{ m}) = 1.65 \text{ E}19 \text{ J/y} \end{aligned}$$

8. Rivers, flowing geopotential

$1.7 \text{ E}12 \text{ m}^3$ (Rao 1975); estimated ave. ht. rivers: 582 m

$$\begin{aligned} & (\text{volume flow}) (\text{density}) (\text{ave. ht. river}) (\text{gravity}) \\ & (1.7 \text{ E}12 \text{ m}^3/\text{y}) (1 \text{ E}3 \text{ kg/m}^3) (582 \text{ m}) (9.8 \text{ m/s}^2) = 9.7 \text{ E}18 \text{ J/y} \end{aligned}$$

9. Earth cycle

$1.2 \text{ J/m}^2/\text{y}$, heat

$$\begin{aligned} & (\text{land area}) (\text{heat flow /m}^2/\text{y}) \\ & (3.29 \text{ E}12 \text{ m}^2) (1.2 \text{ J/m}^2/\text{y}) = 3.95 \text{ E}12 \text{ J/y} \end{aligned}$$

Footnotes for Table 15.1. continued

10. Net formation of earth

Erosion: 880 T/km² (Footnote 7); typical formation rate: 31.2 g/m²/y (Table 3.1); Himalayan formation rate: 2204 T/km²/y (Ollier 1981); map est. of Himalayas: 3.63 E5 km².

(erosion rate)(area)/3 - (formation rate for Himalayas) -
(formation rate for rest of India)

(880 T/km²)(3.29 E6 km²)/3 - (2204 T/km²)(3.63 E5 km²)

- (31.2 T/km²/y)(2.93 E6 km²) = 73.7 E6 T/y deposition

11. Net loss of top soil

Farmed area: 294.35 E6 ha (Pendse 1982); typical farm erosion rate for SE states U.S.: 850 T/km²/y; typical formation rate in areas of natural vegetation succession: 1260 g/m²/y.

(farmed area)(erosion rate) - (successional area)
(formation rate)

(294.35 E10 m²)(850 g/m²/y) - (12.6 E10 m²)(1260 g/m²/y)

= 2.34 E15 g/y

(2.34 E15 g/y)(0.03 organic)(5.4 kcal/g)(4186 J/kcal)

= 1.59 E18 J/y

12a. Electricity thermal

Production, 1978: 60,188 E6 KWh (United Nations 1981a)

(60.2 E9 KWh)(3.60 E6 J/KWh) = 2.17 E17 J/y

12b. Electricity, hydro

Production, 1978: 47,172 E6 KWh (United Nations 1981a)

(47.1 E9 KWh)(3.60 E6 J/KWh) = 1.70 E17 J/y

12c. Electricity, nuclear

2770 E6 KWh, 1978 (United Nations 1981a)

(2.77 E9 KWh)(3.6 E6 J/KWh) = 9.97 E15

Footnotes for Table 15.1. continued

13. Coal production and use

1978 coal: 1.01 E8 T/y, lignite: 3606 E3 T (UN 1981a);
Total: 1.05 E8 T/y

$$(1.05 \text{ E8 T/y}) (3.18 \text{ E10 J/T}) = 3.34 \text{ E18 J/y}$$

14. Oil production and use

1978, 11271 E3 T (UN 1981a)

(11261 E3 T) (1 E6 g/T) (1/454 lb/g) (4680 kcal/lb)

$$(4186 \text{ J/kcal}) = 4.86 \text{ E17 J/y}$$

15. Natural gas production and use

1978, 12598 E12 cal (UN 1981a)

$$(12598 \text{ E12 cal}) (4.186 \text{ J/cal}) = 5.27 \text{ E16 J/y}$$

16. Roundwood production and use

216 E6 m³ (UN 1981a), approximately 12% coniferous.

coniferous: (.12) (216 E6 m³) (0.6 E6 g/m³) (3.6 kcal/g)
(4186 J/kcal) = 2.3 E17 J/y

hardwood: (.88) (216 E6 m³) (1 E6 g/m³) (4 kcal/g)
(4186 J/kcal) = 3.18 E18 J/y

Total roundwood: = 3.41 E18 J/y

17. Fuel wood (including wood for charcoal)

14.4 E5 m³ nonconiferous (Ministry of Information, India
1981).

$$(14.4 \text{ E5 m}^3) (1 \text{ E6 g/m}^3) (4 \text{ kcal/g}) (4186 \text{ J/kcal}) = 2.4 \text{ E16 J/y}$$

18. Dung production and use: Appendix A19.

19. Goods imported

1) Machinery: 1.399 E9 \$ (UN 1981b); 1.69 E-4 T/\$
(Appendix A13).

$$(1.399 \text{ E9 \$}) (1.69 \text{ E-4 T/\$}) = 2.36 \text{ E5 T/y}$$

2) Iron and steel: 4.03 E8 \$ (UN 1981b); 5.4 E-3 T/\$
(Appendix A13).

$$(4.03 \text{ E8 \$}) (5.4 \text{ E-3 T/\$}) = 2.18 \text{ E6 T/y}$$

Footnotes for Table 15.1. continued

20. Fuel oil imported

18.32 E6 T, 1.97 E9 \$ (UN 1981b)

$(18.32 \text{ E6 T}) (7.5 \text{ bbl/T}) (6.28 \text{ E9 J/bbl}) = 8.63 \text{ E17 J/y}$

21. Phosphate imported

8.30 E5 T + 1.98 E5 T = 1.03 E6 T/y, \$75.2 E6 \$ (UN 1981b)

22. Nitrogen fertilizer imported

5498 T + 1.9 E6 T = 1.9 E6 T, \$392.6 E6 \$ (UN 1981b)

23. Other goods and services imported

1978, 7.56 E9 \$ US (UN 1981b); US energy /\$ ratio:
2.37 E12 SEJ/\$.

$(7.56 \text{ E9 \$}) (2.37 \text{ E12 SEJ/\$}) = 1.79 \text{ E22 SEJ/y}$

24. Iron ore exports

Production, 1978,79: 38.8 E6 T, export 21.2 E6 T (Pendse
1982); 268.1 E6 \$ US (UN 1981b)

25. Services and other goods exported

1978 exports: 6.19 E9 \$ US; India energy /\$ ratio:
6.36 E12 SEJ/\$.

$(6.19 \text{ E9 \$}) (6.36 \text{ E12 SEJ/\$}) = 3.9 \text{ E22 J/y}$

26. Tourism

403 E6 \$ (UN 1981a)

(403 E6 \$)

27. International assistance

1.129 E9 \$ (UN 1981a)

(1.129 E9 \$)

Table 15.2. Energy Storages of India

Foot-note	Type of energy	Actual energy J	ETR SEJ/J or SEJ/T	Embodied solar energy E24 SEJ
1	Soil	2.12 E20	6.24 E4	13.2
2	Coal	6.6 E19	3.98 E4	2.63
3	Oil	1.36 E19	5.3 E4	0.72
4	Natural gas	9.22 E19	4.8 E4	4.43
5	Uranium	1.66 E19	1.79 E3	0.03
6	Iron ore, chemical	1.32 E17	6.02 E7	7.95
7	Fresh water	2.37 E18	15,444	0.04
8	Forest wood, total	-	-	12.4
	1) Coniferous	1.52 E19	6.72 E3	0.102
	2) Nonconiferous	3.52 E20	3.49 E4	12.3

Footnotes for Table 15.2

1. Soil

Average organic matter (tons/acre) in unfertilized soils after being continuously cropped: 11.42 (Brady 1974)

$(11.42 \text{ T/acre}) (2.5 \text{ E-4 acre/m}^2) (3.29 \text{ E12 m}^2) (5.4 \text{ kcal/g})$

$(1 \text{ E6 g/T}) (4186 \text{ J/kcal}) = 2.12 \text{ E20 J/y}$

2. Coal

Reserves: 2.26 E9 T (UN 1981a)

$(2.26 \text{ E9 T}) (7 \text{ E6 kcal/T}) (4186 \text{ J/kcal}) = 6.6 \text{ E19 J}$

3. Oil

Reserves: 316 E6 T (UN 1981a)

$(316 \text{ E6 T}) (1 \text{ E6 g/T}) (1/454 \text{ lb/g}) (4680 \text{ kcal/lb}) (4186 \text{ J/kcal})$

$= 1.36 \text{ E19 J}$

Footnotes for Table 15.2 continued.

4. Natural gas

239 E9 m³, 9216 kcal/m³

$$(239 \text{ E9 m}^3) (9216 \text{ kcal/m}^3) (4186 \text{ J/kcal}) = 9.22 \text{ E18 J}$$

5. Uranium

1979: 29800 T (UN 1981a), no production

$$(29.8 \text{ E3 T}) (0.007) (1 \text{ E6 g/T}) (7.95 \text{ E19 J/gU235}) = 1.66 \text{ E19 J}$$

6. Iron, chemical

Reserves 1979: 9,300 E6 T (UN 1981a); 14.2 J/g (Gilliland 1983)

$$(9,300 \text{ E6 T}) (14.2 \text{ J/g}) (1 \text{ E6 g/T}) = 1.32 \text{ E17 J}$$

7. Fresh water

surface: 1.47 E11 m³, ground: 3.33 E11 m³ (Rao 1975)

$$(4.80 \text{ E11 m}^3) (1 \text{ E6 g/m}^3) (4.94 \text{ J/g}) = 2.37 \text{ E18 J}$$

8. Forest wood

74.8 E6 ha: 4.8 E6 ha coniferous, 70.0 E6 ha non-coniferous (Pendse 1982)

$$\begin{aligned} \text{coniferous: } & (4.8 \text{ E6 ha}) (1 \text{ E4 m}^2/\text{ha}) (2.1 \text{ E4 g/m}^2) (3.6 \text{ kcal/g}) \\ & (4186 \text{ J/kcal}) = 1.52 \text{ E19 J} \end{aligned}$$

$$\begin{aligned} \text{non-coniferous: } & (70.0 \text{ E6 ha}) (1 \text{ E4 m}^2/\text{ha}) (3.0 \text{ E4 g/m}^2) \\ & (4 \text{ kcal/g}) (4186 \text{ J/kcal}) = 3.52 \text{ E20 J} \end{aligned}$$

Energy-dollar Ratio

The energy-dollar ratio (Figure 15.3 and Table 15.3) for India in 1978, was calculated from the chemical potential energy of water and tide, imported goods and services, indigenous non-renewable energy sources, and the gross national product.

The energy/\$ ratio of India was 6.36 E12 SEJ/\$, about 2 1/2 times that of the U.S., twice that of the U.S.S.R., and 1/6 of Liberia. This means that for every dollar that an importer paid to India, he received 2 1/2 times more embodied energy than that dollar would buy in the U.S. or 1/6 of the embodied energy it would buy in Liberia.

Balance of trade

The embodied energy in international trade in 1978 is given in Figure 15.3b. The energy flows for the exports were calculated as the sum of the embodied energies of the flows of goods and the service labor energy calculated from the energy/\$ ratio of India. The energy of the service labor flows accompanying the imports were calculated with the energy/\$ ratio of the USA as a representative trading country.

The money balance of payments shows that India's imports were greater than its exports by \$1.4 billion. International assistance, loans and tourist dollars made up this deficit.

On an embodied energy basis, India's imports were about 1.4 times greater than its exports. These helped industrial development. They increased the average energy per person. Most of the exports were manufactured goods for which more embodied

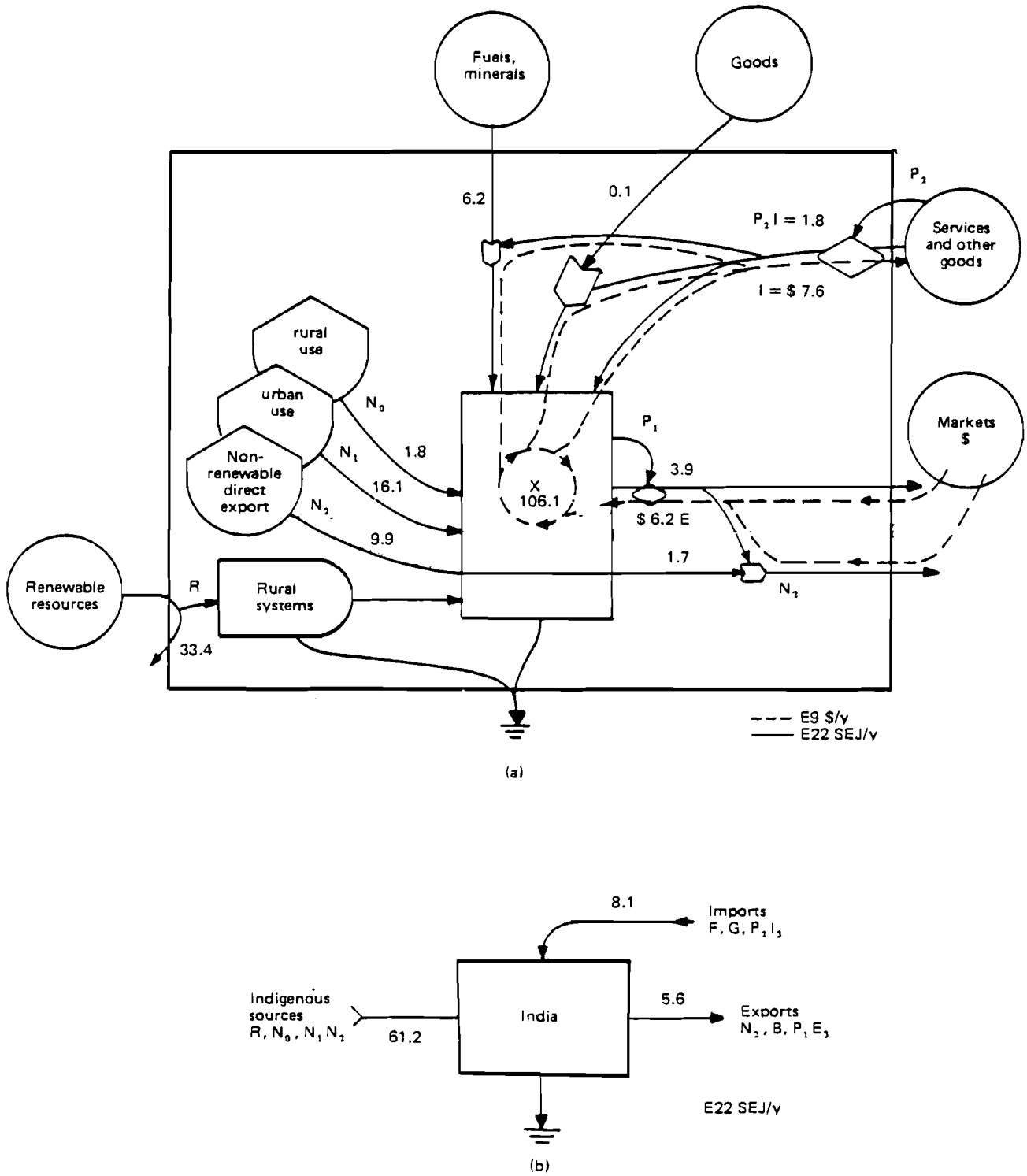

Figure 15.3. Summary diagrams of the embodied energy flows of India, 1978. An evaluation table is given as Table 15.3. Indices from these values are calculated in Table 15.4.

Table 15.3 Summary flows for India in Figure 15.3.

Letter in Figure 15.3	Item	Embodied Solar Energy E22 SEJ/y	Dollars E9 \$/y
R	Renewable sources used (rain and tide)	33.4	-
N	Nonrenewable sources flow within the country ($N_0 + N_1 + N_2$):		
	N_0 Dispersed rural source (soil)	9.9	-
	N_1 Concentrated use (fuels)	16.1	-
	N_2 Exported without use (iron ore)	1.8	-
	N_2' Exported without use minus services	1.7	-
F	Imported minerals and fuels	6.8	-
F'	Imported minerals and fuels without services	6.2	-
G	Imported goods	0.5	-
G'	Imported goods without services	0.1	-
P_2I	Services and other goods imported	1.8	-
I	Dollars paid for imports	-	7.6
E	Dollars paid for exports	-	6.2
P_1E	Exported goods and services	3.9	-
B'	Exported products transformed within the country	-	-
X	Gross National Product	-	106.1
P_2	Ratio embodied energy to dollars of imports (US energy/\$ ratio)	2.37 E12 SEJ/\$	
P_1	Ratio embodied energy to dollar of India and for its exports (energy/\$ ratio)	6.36 E12 SEJ/\$	

Footnotes to Table 15.3

R, N, F, G, P₂I, P₁E (Table 15.1)

N₂¹ Iron ore exports: 1.81 E22 SEJ/y, 0.268 E9 \$; India en/\$:
6.36 E12 SEJ/\$. Services included (6.36 E12 SEJ/\$)
(0.268 E9 \$) = .17 E22 SEJ/y

$$N_2^1 = \text{total } N_2 - \text{services} = 1.7 \text{ E22 SEJ/y}$$

F' Oil imported: 4.57 SEJ/y, 1.97 E9 \$ (Table 15.1):
US energy/\$ ratio: 2.37 E12 SEJ/\$. Services included in
oil: (1.97 E9 \$)(2.37 E12 SEJ/\$) = 0.47 E22 SEJ/y

Phosphate imported: 1.48 E22 SEJ/y, \$75.2 E6 \$. Services
included: (75.2 E6 \$)(2.37 E12 SEJ/\$) = 1.78 E20 SEJ/y

Nitrogen imported: 0.796 E22 SEJ/y, 392.6 E6 \$. Services
included: (392.6 E6 \$)(2.37 E12 SEJ/\$) = 9.3 E20 SEJ/y

$$F' = \text{total } F - \text{services} = 6.8 - 0.6 = 6.2 \text{ SEJ/y}$$

G' Imported machinery and iron and steel: 0.5 SEJ/y, \$1.8 E9 \$.
Services included: (1.8 E9 \$)(2.37 E12 SEJ/\$US)
= 0.43 E22 SEJ/y.

$$G' = \text{total } G - \text{services} = 0.5 - 0.4 = 0.1 \text{ SEJ/y}$$

B' Included in P₁E.

X GNP 86,927 E7 Rupees, 1978-79; 1978 1 Rupee = .122 \$
(Pendse 1982). GNP = 106.1 E9 \$

$$P_1 = \frac{R + N_0 + N_1 + F + G + P_2 I}{X}$$

$$= \frac{(33.4 + 9.9 + 16.1 + 6.8 + 0.6 + 0.7) \text{ E22 SEJ}}{106.1 \text{ E9 \$}}$$

$$= 6.36 \text{ E12 SEJ/\$}$$

energy than raw products. The import of fuel oil was also an advantage as it brought in more embodied energy than the money would buy in India.

The Rural Cattle Village System

In Appendix A19 is given a diagram (Figure A19 and Table A19) evaluating the simple cattle system of India. It was almost completely self-sufficient, with the human and animal labor recycling back into the system. About 40% of the dung is used for fertilizer back on the fields and the rest for cooking fuel. Butter and milk and sometimes calves were sold to buy special cattle feed and goods for human use.

In the past this system has been self-sustaining. However, with India's increase in population and industry and the hope for better jobs, some of the people have been migrating to the cities.

National Overview Ratios

Various ratios, calculated from data in Figure 15.3 and Table 15.3 are given in Table 15.4.

Discussion

India in 1978 was quite self-sufficient. Its 12% from foreign trade compares with 9% for the USSR and 93% for West Germany (FRG). About 50% of its economy was dependent on indigenous renewable sources, such as sun, rain, tides, and storms. Thirty-nine percent of the economy ran on indigenous nonrenewable sources of coal and other fuels, minerals, and soil.

Table 15.4 Indices using embodied energy for overview of India.

Item	Name of index and expression, see Figure 15.3		
1	Renewable embodied energy flow	R	33.4 E22 SEJ/y
2	Flow from indigenous non-renewable reserves	N	27.8 E22 SEJ/y
3	Flow of imported embodied energy	$F'+G'+P_2I$	8.1 E22 SEJ/y
4	Total embodied energy inflows	$R+N+F'+G'+P_2I$	69.3 E22 SEJ/y
5	Total embodied energy used, U	$U=N_0+N_1+R+F'+G'+P_2I$	67.5 E22 SEJ/y
6	Total exported embodied energy	$N_2+B'+P_1E$	21.8 E22 SEJ/y
7	Fraction of embodied energy used derived from home sources	$(N_0+N_1+R)/U$	0.88
8	Imports minus exports	$(F'+G'+P_2I) - (N_2+B'+P_1E)$	2.5 E22 SEJ/y
9	Ratio of exports to imports	$(N_2+B'+P_1E)/(F'+G'+P_2I)$	0.69
10	Fraction of use renewable	R/U	0.49
11	Fraction of use imported	$(F'+G'+P_2I)/U$	0.12
12	Fraction used that is imported service	P_2I/U	0.03
13	Fraction of use that is free	$(R+N_0)/U$	0.64
14	Ratio of concentrated to rural	$(F'+G'+P_2I+N_1)/(R+N_0)$	0.55
15	Use per unit area (3.29 E12 m ²)	U/(area)	2.05 E11 SEJ/m ²
16	Use per capita (6.3 E8 population, 1978)	U/(population)	1.07 E15 SEJ/cap
17	Renewable carrying capacity at present living standard	(R/U) (population)	3.1 E8 population
18	Developed carrying capacity at same living standard	8(R/U) (population)	24.8 E8 population
19	Ratio of use to GNP (energy-dollar ratio)	$P_1 = U/(\text{GNP})$	6.36 E12 SEJ/\$
20	Fraction electric	(total electric)/(U)	0.09
21	Fuel per person	(fuel use)/(population)	3.97 E14 SEJ/cap

Carrying Capacity

If the economy were running only on the renewable sources, it could support only about 50% of the population at the 1978 standard of living (energy per person) or the same population at 50% of the present energy per person.

One index of the amount of development in the country is the ratio of fuels to environmental energy. The Indian ratio of 0.55 compared with that of New Zealand of 0.77 and the US of 5.0. If India kept its population stable and developed its energy-to-environment ratio up to that of the US, it could raise the energy per person 12 times more than it was. Its 1978 energy per person was very low, 1.07 E15 SEJ/y compared to Liberia's 26 E15 SEJ/y and West Germany's 28 E15 SEJ/y.

Electric Power

The ratio of electric power to total embodied energy use may be another index of economic development. The ratio for India was 0.09, less than New Zealand (0.16) and the USSR (0.169), and more than Liberia (0.01).

Additional hydroelectric power plants are possible on the high mountain rivers.

Soil, Forestry and Agriculture

Forests which occupied about 22.7% (74.8 E6 ha) of the area of India in 1978, were used for timber production and grazing. The National Forest Policy aimed at maintaining 1/3 of total area of forests. Even though 3.8 E6 ha had been reforested, there had been a loss of forest area of about 4.5 E6 ha in the last 30

years. This loss was due to the pressure of the increased population, which cut the wood and diverted the land to agriculture and development.

Much of the wood harvested was used directly as fuel or made into charcoal for home cooking fires. Some wood products were exported to make shellac.

The forests are theoretically renewable. But, as the soil is deteriorating and the population increasing, the forests are being consumed. Added fertilizer could help renew these soils. Rotating use of forest and agricultural lands allow the soils to rebuild themselves.

Summary

There are two ways to increase the energy per person in a country—increase the flows of energy and reduce the number of people. In considering the energy situation in India, the energy balance of trade was a positive flow of energy. However, India was still losing in the export of iron ore, and the consumption of coal, soil, and forests.

Some people feel that the rural cattle-dung system (Appendix A19) in the villages should be encouraged as an efficient use of local environmental and human energies as well as to give stability to the social and economic system of the whole country.

J.P. Sendzimir and Gisela Bosch
Center for Wetlands
and
Environmental Engineering Sciences
University of Florida
Gainesville

16. ENERGY ANALYSIS OVERVIEW OF POLAND

INTRODUCTION

This is an energy analysis of the main energy flows of the Polish People's Republic, with its systems of nature and humanity and its interplay of renewable resources, indigenous non-renewable resources and imported resources that generate the economy. An aggregated diagram was used to represent totals for overall comparisons. Several ratios (outside-inside energy ratio, embodied energy trade ratio, etc.), were calculated to compare the Polish People's Republic with other countries and to support predictions.

Poland, (Figure 16.1), a country in northeastern Europe, is bordered on the north by the Baltic Sea, on the south by Czechoslovakia, on the east by the Soviet Union and on the west by the German Democratic Republic. Poland can be divided into three main regions. South of Silesia are the mountains of the Sudetes and the Carpathians. The Carpathians are higher and

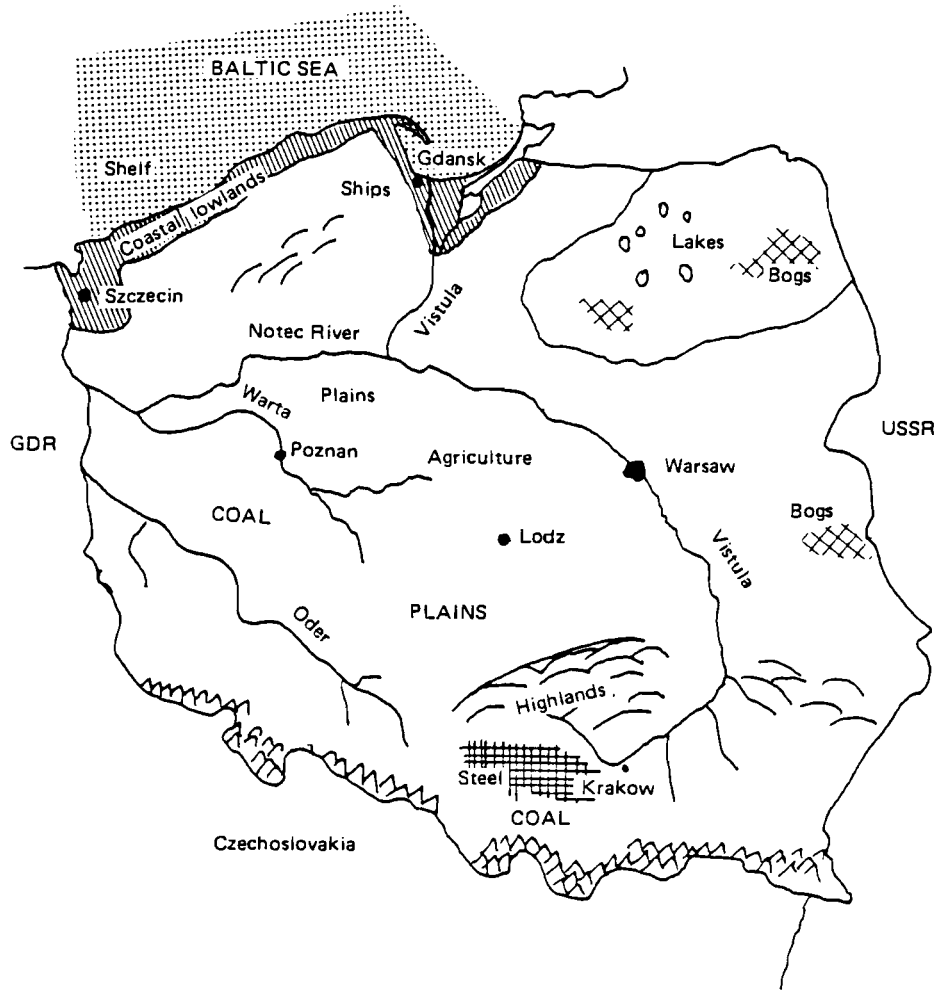

Figure 16.1. Map of Poland, its main geographical features, land uses and energy storages as modified from the Oxford Economic Atlas of the World.

younger than the Sudetes and reach a maximum elevation of 2500 m. North of the mountains lies the fertile, loess-covered region of Silesia. It has a well drained loamy soil in which sugar beets, rye and potatoes are grown. Upper Silesia contains one of Europe's richest coal fields. Two-thirds of Poland's total area ($3.12 \times 10^{11} \text{ m}^2$) is a low-lying plain, which is part of the North European Plain, divided by several ridges formed by boulder clay, sand, and gravel the ice sheets of the Ice Age have left. The region is of considerable agricultural importance especially for cereal production. North of the Central Lowlands several hundred lakes are spread out over this moraine region. Out of the total area of Poland 66% is crops and pastureland, 27% is forest and the rest of it is for urban use.

Climatically Poland is open to the influence of the prevailing, variable westerly winds. Summers are warm with a mean July temperature of 19° C . Winters are very cold with strong winds from the Russian plains. The temperatures are below freezing point for at least two winter months with a mean temperature of -3° C .

In 1977 there were 34.5 million people. The average population density was $110.6 \text{ people/km}^2$, with 12% of the total population living in the eight biggest cities of the country.

METHODS

The procedures and methods used were those given in part I, sections 1 to 5. After an energy diagram was drawn (Figure 16.2), the actual energy storages and flows were estimated and multiplied by the energy transformation ratios (Tables 16.1 and 16.2).

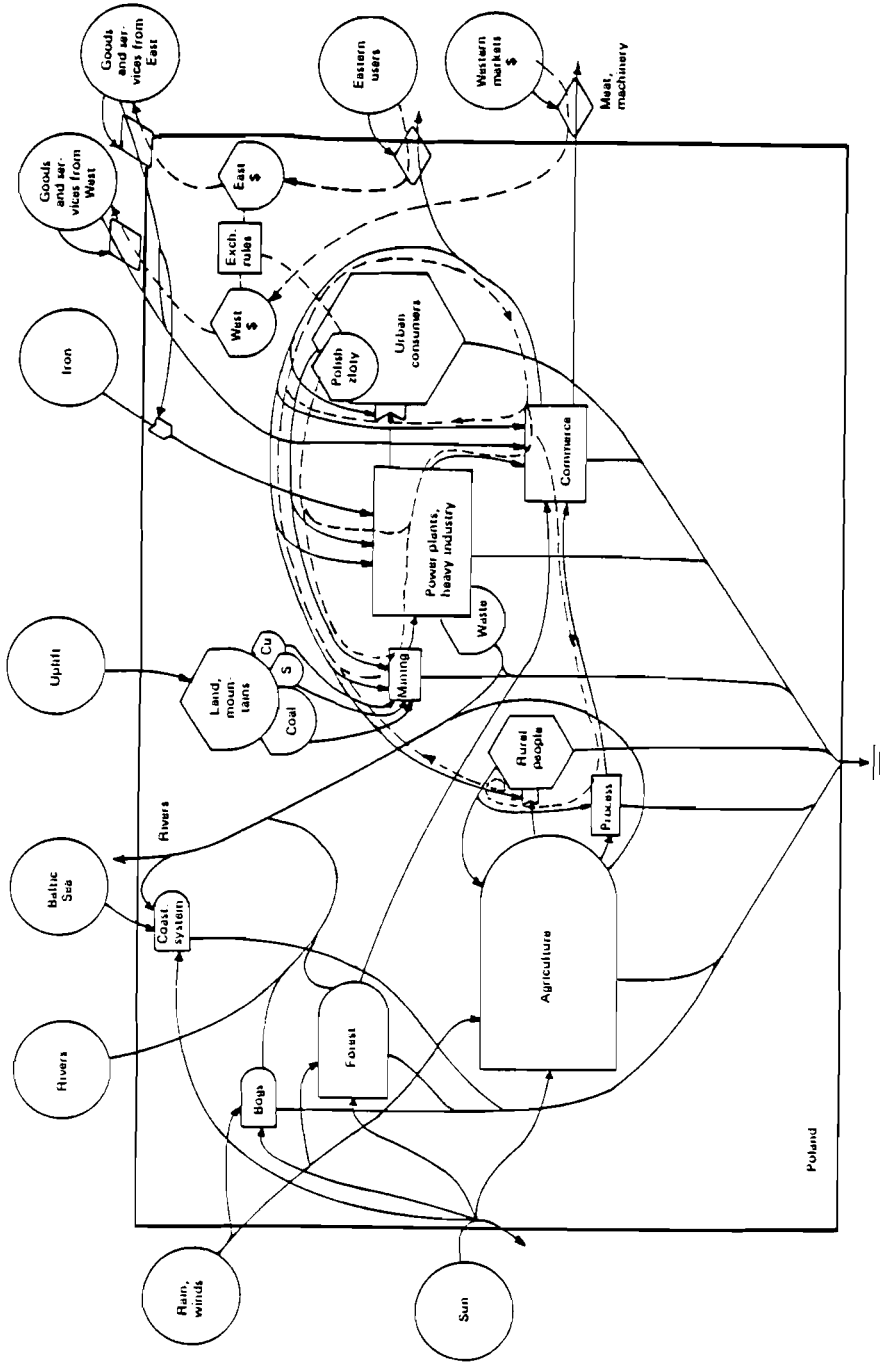

Figure 16.2 Energy diagram of Poland (H.T. Odum).

This calculation expresses all storages and flows in embodied solar-equivalent joules (SEJ) which allows the comparison and evaluation of the different storages and flows.

Most data (1977) were derived from the following references: Comecon Foreign Trade Data 1980, Rocznik Statystyczny 1978, FAO Fertilizer Yearbook 1978 and United Nations Yearbook of International Trade Statistics 1980. The introduction was abstracted from Collier's Encyclopedia 1981. The unit of currency in the Polish People's Republic is the Zloty. In 1977 the exchange rate was 0.301 \$/Zloty (Comecon Data 1981).

The total embodied energy of coal consumed in Poland, less the embodied energies of coal used for electricity and home heating, was used as the fossil fuel embodied in industrial production. In the absence of direct statistics this production was used as the energy embodied in industrial exports, probably an overestimate.

RESULTS

Poland's complex energy relationships are shown in Figure 16.2, an energy diagram showing significant outside energy sources, internal storages and energy uses. Energy flows are listed in Table 16.1, and energy storages are listed in Table 16.2.

Table 16.1 shows that the dominant natural inflow of energy is the chemical potential of rain, although the heat flow in "Earth Cycle" may be of similar importance. Even larger flows directly involved in the human economy are 1) coal export and consumption, 2) oil import, 3) electricity production, and 4) iron ore import.

Table 16.1 Energy flows of Poland.

Footnote	Type of Energy	Actual Energy J/y	ETR SEJ/J or SEJ/\$	Solar Embodied Energy E21 SEJ/y
1	Direct sunlight	1.31 E21	1	1.31
2	Rain, geopotential	1.47 E17	8,888	1.30
3	Rain, chem. potential	1.03 E18	15,444	15.9
4	Rivers, geopotential	7.32 E16	23,564	1.73
5	Net formation of earth	--	--	2.73
6	Net loss of topsoil	1.68 E16	6.25 E4	1.05
7	Earth cycle	4.12 E17	2.98 E4	12.3
8	Wood use internally	2.29 E17	3.5 E4	8.0
9	Sulfur exported	--	--	--
10	Goods net export	5.03 E16		15.9
11	Fuels			
11.1	Coal (export-import)	1.32 E18	3.98 E4	52.5
	Coal (total production)	6.36 E18	3.98 E4	253.1
11.2	Oil (import-export)	6.4 E17	5.3 E4	33.9
11.3	Gas (import-export)	9.7 E16	4.8 E4	4.6
12	Electricity			
12.1	Electricity (import-export)	1.08 E14	15.9 E4	0.017
12.2	Electricity production	3.9 E17	15.9 E4	62.0
13	Goods used whose value is in its concentration (import-export)			
13.1	Fe-ore	5.7 E14	6.02 E7	34.3
13.2	Raw Fe and steel	1.58 E14	1.01 E7	1.6
13.3	Refined Fe and steel	4.79 E13	1.84 E7	0.88
13.4	Fe and steel end products	3.19 E12	6.94 E7	0.22
13.5	Bauxite	4.48 E12	1.32 E7	0.06

Table 16.1 continued.

Footnote	Type of Energy	Actual Energy J/y	ETR SEJ/J or SEJ/\$	Solar Embodied Energy E21 SEJ/y
13.6	Magnesium ore	--	--	--
13.7	Chrome ore	--	--	--
13.8	Zinc	--	--	--
13.9	Copper export	11.8 E3 T/y	4.7 E15 SEJ/T	0.55
13.10	Rubber	2.6 E15	2.1 E4	0.05
13.11	Fertilizer (import)			
	Phosphate	9.66 E5 T	1.44 E16 SEJ/T	13.9
	Nitrogen	1.53 E6 T	2.48 E9 SEJ/T	3.8 E15

Footnotes to Table 16.1

1. Direct sunlight

Area of Poland, $3.12 \text{ E}11 \text{ m}^2$, and its shelf area, $0.35 \text{ E}10 \text{ m}^2$ (The London Times 1973), multiplied by annual solar energy, $90 \text{ kcal/cm}^2/\text{yr}$ (Sellers 1965)

(Total area) (conversion factor) (heat/area) (conversion factor)
 $(3.47 \text{ E}11 \text{ m}^2) (1 \text{ E}4 \text{ cm}^2/\text{m}^2) (90 \text{ kcal/cm}^2/\text{y}) (4186 \text{ J/kcal})$
 $= 1.31 \text{ E}21 \text{ J/y}$

2. Rain, Geopotential

Average elevation: 150 m (averaging of elevation areas on map, Rocznik Statystyczny 1978 (1978), p. XXXI), Runoff: $317 \text{ mm/y} \approx 0.32 \text{ m/y}$ (total runoff from Vistula and Oder rivers, UNESCO 1978)

(Land area) (av. elevation) (runoff) (density) (gravity)
 $(3.12 \text{ E}11 \text{ m}^2) (150 \text{ m}) (.32 \text{ m/y}) (1 \text{ E}3 \text{ kg/m}^3) (9.8 \text{ m/s})$
 $= 1.47 \text{ E}17 \text{ J/y}$

Footnotes to Table 16.1 continued.

3. Rain, chemical potential

Precipitation: $600 \text{ mm/y} = 0.6 \text{ m/y}$ (Statystyczny Rocznik 1978 (1978))

(Total area) (average rain/y) (Gibbs free energy) (units)

$$(3.47 \text{ E}11 \text{ m}^2) (0.6 \text{ m/y}) (4.94 \text{ J/g}) (1 \text{ E}6 \text{ g/m}^3) = 1.03 \text{ E}18 \text{ J/y}$$

4. Rivers, flowing geopotential

Volume flow of the 2 major rivers, Vistula and Oder: $49.8 \text{ km}^3/\text{y}$. Average height of the rivers: 150 m.

(Volume flow) (water density) (av. river ht.) (gravity)

$$(49.8 \text{ km}^3/\text{y}) (1 \text{ E}9 \text{ m}^3/\text{km}^3) (150 \text{ m}) (9.8 \text{ m/s}^2) (1 \text{ E}3 \text{ kg/m}^3) \\ = 7.32 \text{ E}16 \text{ J/y}$$

5. Net formation of earth

Formation rate: $31.2 \text{ g/m}^2/\text{y}$ (Appendix A.18)

Erosion rate: $10\text{-}50 \text{ T/km}^2/\text{y}$ ($30 \text{ T/km}^2/\text{y}$ average) over 80% of Poland, $10 \text{ T/km}^2/\text{y}$ over 20% of Poland (Snead 1980, Map 1-15, p. 33).

Weighted average erosion rate: $26 \text{ T/km}^2/\text{y} = (26 \text{ g/m}^2/\text{y}) (3.12 \text{ E}11 \text{ m}^2) \\ = 8.1 \text{ E}12 \text{ g/y}$

(Erosion outflow) - (formation rate) (area of country)

$$(8.1 \text{ E}12 \text{ g/y}) - (31.2 \text{ g/m}^2/\text{y}) (3.12 \text{ E}11 \text{ m}^2) \\ = -1.6 \text{ E}12 \text{ g/y} = \text{net formation}$$

$$(1.6 \text{ E}12 \text{ g/y}) (1.71 \text{ E}9 \text{ SEJ/g}) = 2.73 \text{ E}12 \text{ SEJ/y formation}$$

6. Net loss of topsoil

Typical formation rate: $1260 \text{ g/m}^2/\text{y}$ or $8.54 \text{ E}5 \text{ J/m}^2/\text{y}$ (Appendix A.18).

Erosion rate: $700 \text{ g/m}^2/\text{y}$ (same as farmland in the North-eastern USA, Appendix A.18).

Agricultural land: $1.91 \text{ E}11 \text{ m}^2$, forested land $8.64 \text{ E}10 \text{ m}^2$ (Rocznik Statystyczny 1978 (1978), p. 199).

(Farmed area) (erosion rate) - (successional area) (formation rate)

Footnotes to Table 16.1 continued.

$$(1.91 \text{ E}11 \text{ m}^2) (700 \text{ g/m}^2/\text{y}) - (8.64 \text{ E}10 \text{ m}^2) (1260 \text{ g/m}^2/\text{y}) \\ = 2.48 \text{ E}13 \text{ g/y}$$

net erosion

$$(2.48 \text{ E}13 \text{ g/y}) (0.03 \text{ organic}) (5.4 \text{ kcal/g}) (4186 \text{ J/kcal}) \\ = 1.68 \text{ E}16 \text{ J}$$

7. Earth cycle

Heat flow in the ground in Poland: $1 \mu\text{cal/cm}^2/\text{s}$ (Sclater et al. 1980)

$$(3.15 \text{ E}7 \text{ s/y}) (1 \text{ E}-6 \text{ cal/cm}^2/\text{s}) (1 \text{ E}4 \text{ cm}^2/\text{m}^2) (1 \text{ kcal}/1 \text{ E}3 \text{ cal}) \\ (4186 \text{ J/kcal}) (3.12 \text{ E}11 \text{ m}^2) = 4.12 \text{ E}17 \text{ J/y}$$

8. Wood used internally

Total production: $23,756 \text{ E}3 \text{ m}^3 = 16.6 \text{ E}6 \text{ T}$ (Rocznik Statystyczny 1978 (1978), p. 254)

Exports: $484 \text{ E}3 \text{ T}$ (Comecon Data 1981)

Actual energy/T: $13.8 \text{ E}9 \text{ J/T}$ (Fluck and Baird 1980)

(Total weight)(actual joules/T)

$$(16.6 \text{ E}6 \text{ T}) (13.8 \text{ E}9 \text{ J/T}) = 2.29 \text{ E}17 \text{ J/y}$$

9. Sulfur export

Total 1977 export: $4399 \text{ E}3 \text{ T}$ (Rocznik Statystyczny 1978 (1978), p. 292)

10. Goods used in reaction with oxygen

Imports 1977 (Rocznik Statystyczny 1978 (1978), p. 291)

Meat	98447 T
Grains	3.88 E6 T
Wood products (paper, cellulose)	4.24 E5 T
Cut timber ($213,000 \text{ m}^3$) (0.7 T/m^3)	1.49 E5 T

Exports 1977 (Rocznik Statystyczny 1978 (1978), p. 291)

Meat	159,382 T
Sugar	251,000 T
Alcohol	281 E5 liters
Livestock	245 E3 T

$$\text{Wood} \quad (692 \text{ E}3 \text{ m}^3) \left(\frac{0.7 \text{ E}6 \text{ g}}{\text{m}^3} \right) \left(\frac{1 \text{ T}}{1 \text{ E}6 \text{ g}} \right) = 484 \text{ E}3 \text{ T}$$

Footnotes to Table 16.1 continued.

(Imports-Exports) 1977

Livestock, meat and meat products	-305,935 T
Grains	3.88 E6 T
Wood and wood products	89 E3 T
Sugar	-251 E3 T
Alcohol	-281 E5 liters

Actual energy (Burnett 1978) (Fluck and Baird 1980)

Beef	15.8 E9 J/T
Grains	13.9 E9 J/T
Lumber	13.8 E9 J/T
Sugar	16.7 E9 J/T
Alcohol	16.7 E9 J/T

Actual joules

Beef (-305,935 T) (15.8 E9 J/T)	= -4.83 E15 J/y
Grains (3.88 E6 T) (13.9 E9 J/T)	= 5.39 E16 J/y
Lumber (80 E3 T) (13.8 E9 J/T)	= 1.10 E15 J/y
Sugar (-251 E3 T) (16.7 E9 J/T)	= -4.19 E15 J/y
Alcohol (-28 E3 T) (16.7 E9 J/T)	= -4.67 E14 J/y

TOTAL = 5.03 E16 J/y

Embodied energy (ETR's from Table 3.1)

Beef (4.83 E15 J/y) (4.0 E6 SEJ/J)	= -1.93 E22 SEJ/y
Grains (5.39 E16 J/y) (6.8 E4 SEJ/J)	= 3.67 E21 SEJ/y
Lumber (1.10 E15 J/y) (3.5 E4 SEJ/J)	= 3.86 E19 SEJ/y
Sugar (4.19 E15 J/y) (8.4 E4 SEJ/J)	= -3.52 E20 SEJ/y
Alcohol (4.68 E14 J/y) (6.0 E4 SEJ/J)	= -2.81 E19 SEJ/y

TOTAL = -1.59 E22 SEJ/y

11. Fuels (Comecon Foreign Trade Data 1980 (1981))

11.1 Coal

a) Hard coal

Import	1.08 E6 T/y
Export	39.3 E6 T/y
(Import-Export)	-38.22 E6 T/y
Actual energy (Stat. Yearbook for FRG 1981)	30.65 E9 J/T
(-38.22 E6 T/y) (30.65 E9 J/T)	-1.17 E18 J/y

b) Lignite

Import	--
Export	3.38 E6 T/y
(Import-Export)	-3.38 E6 T/y
Actual energy (Stat. Yearbook for FRG 1981)	16.26 E9 J/T
(-3.38 E6 J/y) (16.26 E9 J/T)	-5.46 E16 J/T

Footnotes to Table 16.1 continued.

c) Coke		
Import		--
Export		<u>3.11 E6 T/y</u>
(Import-Export)		-3.11 E6 T/y
Actual Energy (Stat. Yearbook for FRG 1981)	30.65 E9 J/T	
(-3.11 E6 J/y) (30.65 E9 J/T)		-9.53 E16 J/y
d) Total coal production (Rocznik Statystyczny 1978 (1978))		
Hard coal	186.1 E6 T/y	
Actual energy (Stat. Yearbook for FRG 1981)	30.65 E9 J/T	
(186.1 E6 T) (30.65 E9 J/T)		5.7 E18 J/y
Lignite		
Actual energy (Stat. Yearbook for FRG 1981)	16.26 E9 J/T	
(40.8 E6 T/y) (16.26 E9 J/T)		6.6 E17 J/y
11.2 Crude oil		
Import	16.4 E6 T/y	
Export	<u>2.15 E6 T/y</u>	
(Import-Export)	14.25 E6 T/y	
Actual energy (Table 2.1)	4.5 E10 J/T	
(14.25 E6 T/y) (4.5 E10 J/T)		6.4 E17 J/T
11.3 Natural and manufactured gas		
Import	2.76 E9 m ³ /y	
Export	--	
(Import-Export)	<u>2.76 E9 m³/y</u>	
Actual energy (Stat. Yearbook for FRG 1981)	35169 E3 J/m ³	
(2.759 E9 m ³) (35169 E3 J/m ³)		9.7 E16 J/y
12. Electricity (Rocznik Statystyczny 1978 (1978), p. 167)		
12.1 Electricity trade		
Import	3111 E6 kwh/y	
Export	<u>3081 E6 kwh/y</u>	
(Import-Export)	30 E6 kwh/y	
(30 E6 kwh/y) (3.6 E6 J/kwh)		1.08 E14 J/y
12.2 Electricity production		
Conversion factor	1.09 E11 kwh/y	
	3.6 E6 J/kwh	
(1.09 E11 kwh/y) (3.6 E6 J/kwh)		3.9 E17 J/y
13. Goods used whose value is in its concentration (import-export) (Comecon Foreign Trade Data 1980 (1981))		
13.1 Fe-ore		
Import	16.94 E6 T/y	
Export	--	
(Import-Export)	<u>16.94 E6 T/y</u>	
Actual energy (extrap. from Gilliland et al. 1978)	3.37 E7 J/T	
(16.94 E6 T/y) (3.37 E7 J/T)		5.71 E14 J/y

Footnotes to Table 16.1 continued.

13.2 Raw Fe and steel	
Import	1.75 E6 T/y
Export	--
(Import-Export)	<u>1.75 E6 T/y</u>
Actual energy (extrap. from Gilliland et al. 1978)	9.04 E7 J/T
(1.75 E6 T/y) (9.04 E7 J/T)	1.58 E14 J/y
13.3 Refined Fe and steel	
Import	1.59 E6 T/y
Export	1.06 E6 T/y
(Import-Export)	<u>0.53 E6 T/y</u>
Actual energy (extrap. from Gilliland et al. 1978)	9.04 E7 J/T
(0.53 E6 T/y) (9.04 E7 J/T)	4.79 E13 J/y
13.4 Fe and steel end-products	
Import (incomplete data)	90045 T/y
Export (incomplete data)	54700 T/y
(Import-Export)	<u>35345 T/y</u>
Actual energy (extrap. from Gilliland et al. 1978)	9.04 E7 J/T
(35345 T/y) (9.04 E7 J/T)	3.19 E12 J/T
13.5 Bauxite	
Import	69 E3 T/y
Export	--
(Import-Export)	<u>69 E3 T/y</u>
Actual energy (Lavine and Butler 1982)	6.5 E7 J/T
(69 E3 T/y) (6.5 E7 J/T)	4.48 E12 J/y
13.6 Magnesium-ore	
Import	340 E3 T/y
Export	--
(Import-Export)	<u>340 E3 T/y</u>
13.7 Chrom-ore	
Import	698 E3 T/y
Export	--
(Import-Export)	<u>698 E3 T/y</u>
13.8 Zinc	
Import	220 E3 T/y
Export	62.3 E3 T/y
(Import-Export)	<u>157.7 E3 T/y</u>
13.9 Copper	
Import	--
Export	118 E3 T/y
(Import-Export)	<u>-118 E3 T/y</u>

Footnotes to Table 16.1 continued.

Rough calculation of the Cu-ETR:

Total energy required for the Cu-production (Slessor 1978)	97 E6 J/kg
ETR for coal (97 E6 J/kg) (3.98 E4 SEJ/J)	3.98 E4 SEJ/J
ETR for Cu-ore	= 3.86 E12 SEJ/kg
ETR for Cu	+ 0.85 E12 SEJ/kg
	<u>4.7 E12 SEJ/kg</u>
	4.7 E15 SEJ/T
13.10 Rubber	
Import (UN 1981b)	179 E3 T/y
Export	--
(Import-Export)	<u>179 E3 T/y</u>
Gibbs Free Energy (Table 7.1, footnote 13)	1.47 E10 J/T
(179 E3 T/y) (1.47 E10 J/T)	2.63 E15 J/y
13.11 Fertilizer consumption (imported) (FAO 1979)	
phosphate (natural)	966245 T/y
nitrogen	1528932 T/y
13.12 Cement (Rocznik Statystyczny 1978 (1978))	
Import	263.3 E3 T/y
Export	<u>1590.8 E3 T/y</u>
(Import-Export)	-1327.5 E3 T/y
Actual energy (Slessor and Lewis 1979)	0.18 E9 J/T
(-1327.5 E3 T/y) (0.18 E9 J/T)	2.39 E14 J/y

Table 16.2 Energy storages in Poland.

Footnote	Item	Actual Energy J	Energy Transformation Ratio SEJ/J	Embodied Solar Energy Stored E23 SEJ
1	Fuel resources	1.4 E21	3.98 E4	560.0
2	Soils			
	Farmed land	1.22 E19	6.25 E4	7.6
	Forested land	1.55 E19	6.25 E4	9.7
3	Wood	2.53 E19	6.7 E3	1.7

Footnotes to Table 16.2

1. Fuel resources and reserves

Solid fuels, coal, geological resources: 48,150 E6 tons coal equivalent (Comecon Data 1981 (1982), p. 424). Natural gas "ultimate recoverable reserves": 4600 E15 J (Comecon Data 1981 (1982), p. 424).

Solid fuels:

$$(48,150 \text{ E6 TCE}) (7 \text{ E6 kcal/T}) (4186 \text{ J/kcal}) = 1.4 \text{ E21 J}$$

2. Topsoils

Sum of areas of farmed soils and forest soils. Organic matter in farmed soils: 11.4 T/acre (Brady 1974). Total farmed acreage: 19111 E3 ha = 1.91 E11 m² (Rocznik Statystyczny 1978 (1978), p. 199). Total forested area: 8640 E3 ha = 8.64 E10 m² (Rocznik Statystyczny 1978 (1978), p. 199).

Farmed soils:

$$\frac{(1.91 \text{ E11 m}^2) (11.4 \text{ T/A}) (1 \text{ E6 g/T}) (5.4 \text{ kcal/g}) (4186 \text{ J/kcal})}{(4.05 \text{ E3 m}^2/\text{A})}$$

$$= 1.22 \text{ E19 J}$$

Forest soils:

$$(8.64 \text{ E10 m}^2) (0.03 \text{ organic}) (0.18 \text{ m}) (1.47 \text{ g/cm}^3) (1 \text{ E6 cm}^3/\text{m}^3) \\ (5.4 \text{ kcal/g}) (4186 \text{ J/kcal}) = 1.55 \text{ E19 J}$$

3. Wood

Total forested area: 8.64 E10 m² (Rocznik Statystyczny 1978 (1978), p. 199). Above-ground dry biomass, averaging between young oak-pine forest and mature spruce-fir forest: 20,000 g/m² (Lieth and Whittaker 1975, p. 80).

(Forested area) (Biomass/area) (Actual energy/biomass)

$$(8.64 \text{ E10 m}^2) (20 \text{ E3 g/m}^2) (3.5 \text{ kcal/g}) (4186 \text{ J/kcal})$$

$$= 2.53 \text{ E19 J}$$

Flows shown in Table 16.1 are aggregated in Table 16.3 and Figure 16.3. In Table 16.4 various indices of energy and economic relationships are calculated to allow the comparison and evaluation of the different storages and flows.

Poland's workforce of over 16 million people is divided between agriculture (38%), industry (26%), and other, primarily service (36%). The income per capita was about 1587 US dollars per person in 1977.

Table 16.3 Summary flows for Poland in Figure 16.4.

Letter		E21 SEJ/y
R		15.9
N		
	N ₀ Dispersed rural	1.05
	N ₁ Concentrated use	200.6
	N ₂ Exported without use	52.6
F	Import minerals and fuels (SEJ/y)	72.86
G	Import goods (SEJ/y)	16.65
P ₂ I ₃	Import services (SEJ/y)	23.4
I	\$ paid for imports	1.46 E10 \$
E	\$ paid for exports	1.23 E10 \$
P ₁ E ₃	Exported services	39.0
B	Export products	0.55
X	Gross National Product	5.49 E10 \$/y
P ₂	Ratio embodied energy \$ ratio (US) (Table A4b)	2.60 E12 SEJ/y
P ₁	Ratio embodied energy/\$ and for its exports (SEJ/\$)	6.0 E12 SEJ/y

Footnotes to Table 16.3

R	Chemical potential energy of rain (Table 16.1, Footnote 3)	
N ₀	Net loss of topsoil (Table 16.1, Footnote 6)	
N ₁	Coal internal use	
	Total coal production (Table 16.1, Footnote 11.1)	253.1 E21 SEJ/y
	Coal export (Table 16.1, Footnote 11.1)	52.5 E21 SEJ/y
	(Total coal production-coal export)	200.6 E21 SEJ/y
N ₂	Coal export (Table 16.1, Footnote 11.1)	
F	Imported minerals and fuels (Table 16.1, Footnotes 11 and 13)	
	Crude oil	33.9 E21 SEJ/y
	Gas	4.6 E21 SEJ/y
	Fe-ore	34.3 E21 SEJ/y
	Bauxite	<u>0.06 E21 SEJ/y</u>
		72.86 E21 SEJ/y
G	Imported goods (Table 16.1, Footnote 13)	
	Raw Fe and steel	1.6 E21 SEJ/y
	Refined Fe and steel	0.88 E21 SEJ/y
	Fe and steel products	0.22 E21 SEJ/y
	Rubber	0.05 E21 SEJ/y
	Fertilizer	<u>13.9 E21 SEJ/y</u>
		16.65 E21 SEJ/y
P ₂ I ₃	I ₃ = money paid for services	
	I ₁ = money paid for minerals and fuels (UN 1981b)	
	petroleum	1.51 E9 \$/y
	natural gas	0.13 E9 \$/y
	Fe and nonfer. ore	<u>0.73 E9 \$/y</u>
		2.37 E9 \$/y
	I ₂ = money paid for goods and food	
	grain	7.36 E8 \$/y
	fertilizer	4.44 E8 \$/y
	iron and steel	16.22 E8 \$/y
	machines	<u>4.35 E8 \$/y (1)</u>
		32.37 E9 \$/y
	I = 14.6 E9 \$/y	

(1) only includes ca. 10% of the total machines export because of incomplete data in G

Footnotes to Table 16.3 continued.

$$\begin{aligned} I_3 &= I - (I_1 + I_2) \\ &= 14.6 \text{ E9 } \$/y - (2.37 \text{ E9 } \$/y + 3.24 \text{ E9 } \$/y) \\ &= 8.99 \text{ E9 } \$/y \end{aligned}$$

$$\begin{aligned} P_2 I_3 &= (2.60 \text{ E12 SEJ}/\$)(8.99 \text{ E9 } \$/y) \\ &= 23.4 \text{ E21 SEJ}/y \end{aligned}$$

I \$ paid for imports (UN 1981)

E \$ paid for exports (UN 1981)

$P_1 E_3$ E_3 = \$ paid for services

$E_1 + E_2$ = \$ paid for products (UN 1981)

Meat	3.35	E8	\$/y
Sugar	1.06	E8	\$/y
Alcohol	1.07	E8	\$/y
Livestock	1.12	E8	\$/y
Wood	1.80	E8	\$/y
Vegetables	1.60	E8	\$/y
Non-Ferrous-ore	3.89	E8	\$/y
Coal	35.10	E8	\$/y
Petroleum products	2.15	E8	\$/y
Pig iron	0.77	E8	\$/y
Refined iron and steel	5.26	E8	\$/y
Copper	0.39	E8	\$/y
Machines (incomplete)	0.44	E8	\$/y
Cement	0.36	E8	\$/y
	<hr/>		
	58.36	E8	\$/y

$$E = 1.23 \text{ E10 } \$/y$$

$$\begin{aligned} E_3 &= E - (E_1 + E_2) \\ &= 1.23 \text{ E10 } \$/y - 0.58 \text{ E10 } \$/y \\ &= 0.65 \text{ E10 } \$/y \end{aligned}$$

$$\begin{aligned} P_1 E_3 &= (6.0 \text{ E12 SEJ}/\$)(0.65 \text{ E10 } \$/y) \\ &= 39 \text{ E21 SEJ}/y \end{aligned}$$

B Cu-export

0.55 E21 SEJ/y

Footnotes to Table 16.3 continued.

P_1 : embodied energy to \$ of country for its exports

$$P_1 = \frac{R + N_0 + N_1 + F + G + P_2 I_3}{X}$$

$$= \frac{(15.9 + 1.05 + 200.6 + 72.86 + 16.65 + 23.4) E21 \text{ SEJ/y}}{5.49 E10 \text{ \$/y}}$$

$$= 6.0 E12 \text{ SEJ/\$}$$

B' Embodied energy which goes out in exported machines, steel, etc. overestimated as coal used minus that used in power plants and home heating. (Rocznik Statystyczny 1978 (1978))

stone coal		4.44 E7 T/y
		3.66 E7 T/y
(stone coal) (30.65 E9 J/T)	=	2.37 E18 J/y
(lignite) (16.26 E9 J/T)	=	<u>0.595 E18 J/y</u>
		2.97 E18 J/y
(2.97 E18 J/y) (3.98 E4 SEJ/J)	=	118 E21 SEJ/y
electricity use (Table 16.1)		62 SEJ/y
(coal used for electricity-production and home heating)		
- (coal used for electricity)		
(118 E21 SEJ/J) - (62 SEJ/J)	=	56.0 E21 SEJ/y
Total coal consumption (Table 16.3)		200.6 E21 SEJ/y
- coal used for electricity production and home heating		<u>118.0 E21 SEJ/y</u>
coal used in the industry		82.6 E21 SEJ/y

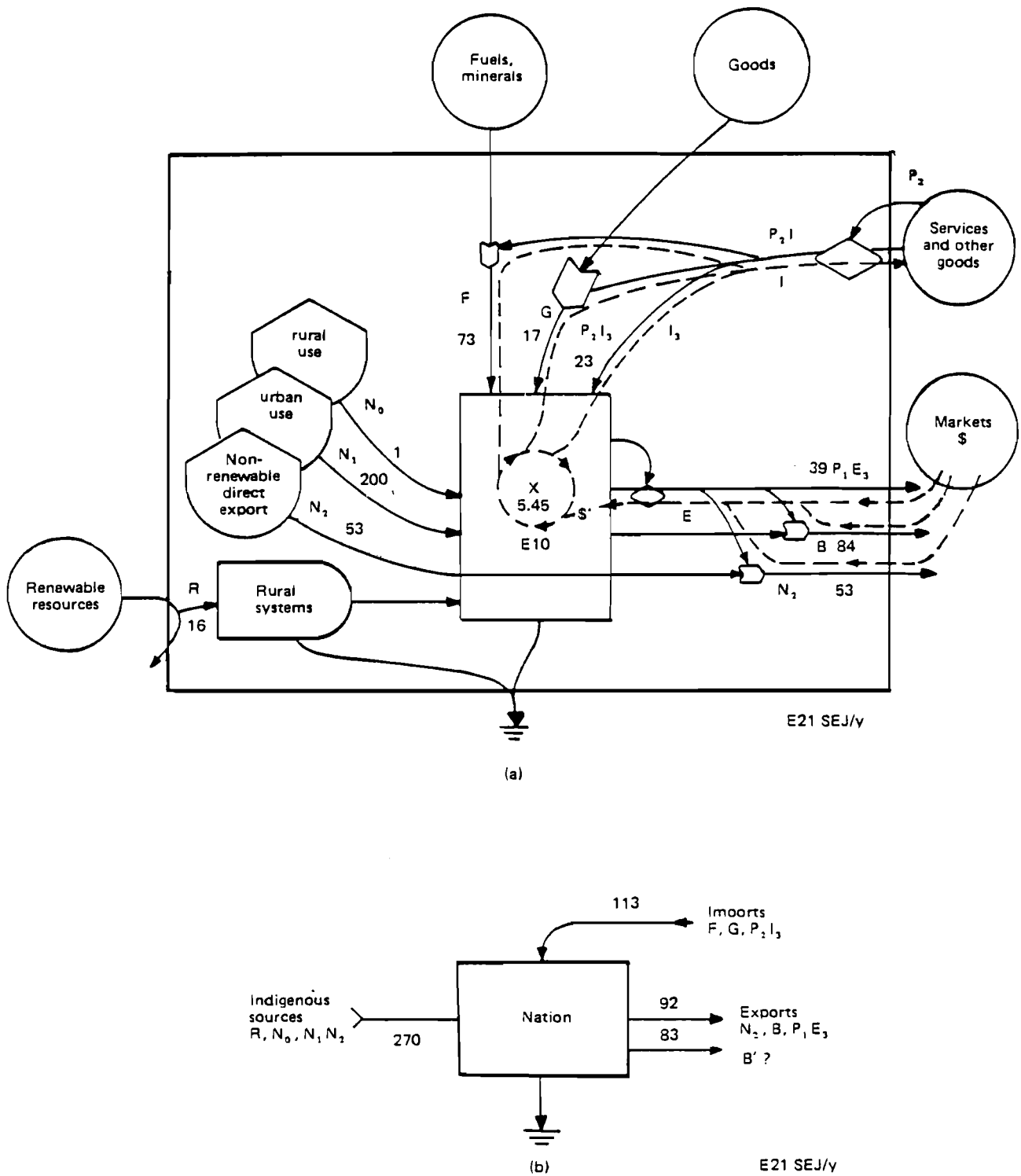

Figure 16.3 Summary diagram: (a) embodied energy flow, (b) international trade.

Table 16.4 Indices using embodied energy for overview of Poland.

Item	Name of index and expression, see Figure 6.6		
1	Renewable embodied energy flow	R	15.9 E21 SEJ/y
2	Flow from indigenous nonrenewable reserves	N	254.25 E21 SEJ/y
3	Flow of imported embodied energy	$F+G+P_2 I_3$	112.91 E21 SEJ/y
4	Total embodied energy inflows	$R+N+F+G+P_2 I$	383.06 E21 SEJ/y
5	Total embodied energy used, U	$U=N_0+N_1+R+F+G+P_2 I$	330.46 E21 SEJ/y
6	Total exported embodied energy	$B+P_1 E$	39.55
7	Fraction of embodied energy used derived from home sources	$(N_0+N_1+R)/U$	0.66
8	Exports minus imports	$(N_2+B+P_1 E)-(F+G+P_2 I_3)$	61.84 E21 SEJ/y
9	Ratio of exports to imports	$(N_2+B+P_1 E)/(F+G+P_2 I)$	1.55
10	Fraction used, locally renewable	R/U	0.05
11	Fraction of use purchased	$(F+G+P_2 I)/U$	0.34
12	Fraction used that is imported service	$P_2 I/U$	0.07
13	Fraction of use that is free	$(R+N_0)/U$	0.05
14	Ratio of concentrated to rural	$(F+G+P_2 I+N_1)/(R+N_0)$	18.5
15	Use per unit area (3.12 E11 m ²)	U/(area)	1.06 E12 $\frac{SEJ}{m^2}$
16	Use per capita (34.5 E6)	U/(population)	9.58 E15 $\frac{SEJ}{capita}$
17	Renewable carrying capacity at present living standard	(R/U) (population)	1.66 E6 people
18	Developed carrying capacity at same living standard	8(R/U) (population)	1.33 E7 people
19	Ratio of use to GNP (energy-dollar ratio)	$P_1 = U/(GNP)$	6.0 E12 $\frac{SEJ}{\$}$
20	<u>electricity</u> capita	$\frac{62 E21 SEJ/y}{34.5 E6}$	1.8 E15 $\frac{SEJ}{capita}$

DISCUSSION

In 1977 Poland's economy was greatly supported by energy flows from indigenous sources such as rain and coal. This is reflected in the ratio of locally derived embodied energies used compared to total energy use (item 7, Table 16.4) which was 66%. Other national economies, such as the United States and the Federal Republic of Germany, seem to have depended more on outside energy sources. Their ratios are 17% and 30%, respectively.

Energy Evaluation of Trade Balance

Poland's 1977 energy-dollar ratio, calculated by converting zlotys to dollars at the official exchange ratio, Table 16.4 item 19, is more than two and one half times that of the Federal Republic of Germany. This suggests that western dollars flowing into Poland to purchase goods or services would draw about 250% more embodied energy than they would in West Germany. The balance of trade with the Soviet Union similarly depends on the relative currency exchange rate set and the relative embodied energy per unit exchange.

The embodied energy in international trade is given in Figure 16.3b. If the high embodied energy of coal going into steel, ships, etc. is estimated, a larger export than import is found.

Energy Density

Poland's energy density, $1.06 \text{ E}12 \text{ SEJ/m}^2$ (item 15, Table 16.4) is one-seventh that of the Federal Republic of Germany and almost three times that of the United States. Although

Poland has a large rural population, it has a moderately high energy density when the heavy industry is included.

Energy Per Person

Poland's energy/person, 9.6 E15 SEJ/capita, is one-third of that of West Germany (FRG) and 60% of that of the USSR. In energy terms the standard of living may be higher in the USSR because of larger relative flows of natural energy and indigenous fossil fuels, and higher in West Germany because of larger relative flows of imported energies.

Carrying Capacity

The country, with a population of 35 million people, was 95% dependent on indigenous and imported fuels. The carrying capacity on only renewable energies would be only 1.7 million people at the 1977 standard of living, or the 1977 population at 5% of the energy per person.

Poland's ratio of concentrated fuel energy to renewable rural energies was 18.5/1. This indicated a highly industrialized country: it compared to Spain of 7.2/1, the USA of 7/1, and West Germany of 68/1. However, a large fraction of the people are in rural lower energy agriculture not a part of the industrialization.

As fuels and metals yield less net energy and the world's consumption of products of heavy industry declines, countries like Poland, based on oil and steel, may have to find other bases for their populations.

Elisabeth C. Odum
*Santa Fe Community College,
Gainesville, Florida*

Howard T. Odum
*Environmental Engineering Sciences and
Center for Wetlands, University of
Florida, Gainesville, Florida*

17. OVERVIEW ENERGY ANALYSIS OF THE UNITED STATES OF AMERICA

This is an overview energy analysis of the United States of America. It is a large country including arctic environs of Alaska, temperate regions including mountains, deserts and some tropical areas in Hawaii and Puerto Rico. Most of its 230 million people live in cities with a high level of fuel and electric consumption.

The methods given in chapters 1-5 were used here to calculate the solar embodied energy of main energy flows supporting the economy in 1980 (Table 17.1) and of main resource storages (Table 17.2). Energy diagrams were given previously (Odum 1983, chapter 23), and maps of energy and resource distribution in the USA for calculating embodied energy (Odum et al. 1983).

As in chapters on other nations, main categories of indigenous energy use, imports, and exports were summarized (Table 17.3 and 17.4) and portrayed in a diagram (Figure 17.1).

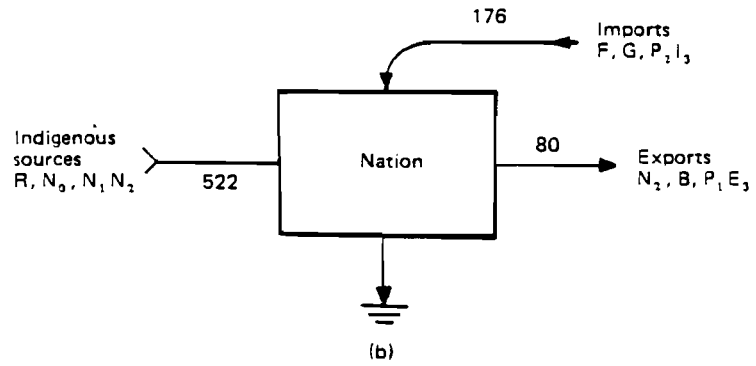
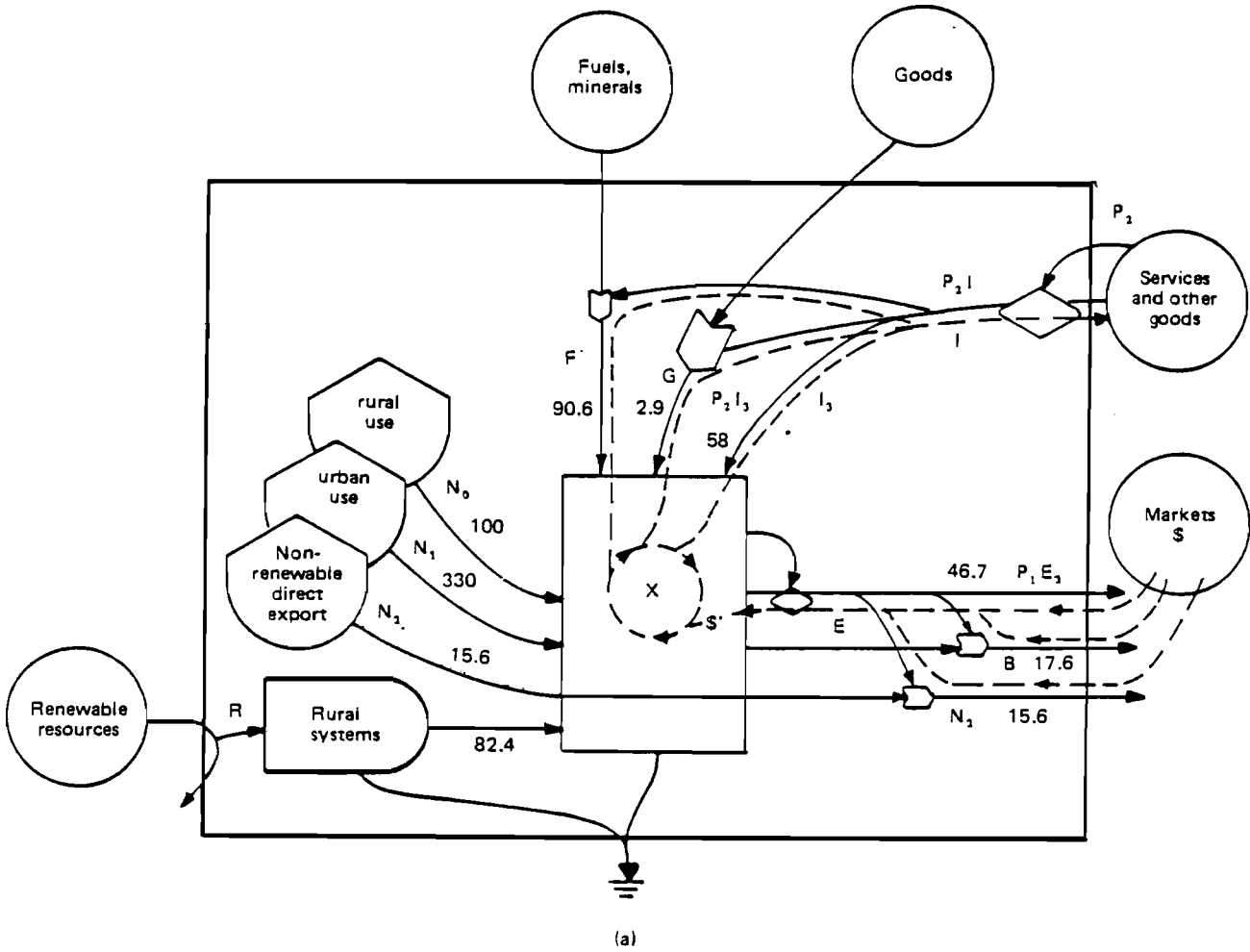

Figure 17.1. Summary embodied energy flows for the United States of America. See Tables 17.3 and 17.4.

Table 17.1 Energy flows in the United States of America.

Footnote	Type of energy	Actual Energy J	ETR SEJ/J or SEJ/T	Solar Embodied Energy E22 SEJ
1	Direct sun	4.48 E22	1	4.5
2	Wind kinetic energy	1.63 E20	663	10.8
3	Rain, chemical potential	4.17 E19	15,444	64.4
4	Rain, geopotential	6.33 E19	8.88 E3	56.2
5	Tide	7.63 E17	2.36 E4	18.0
6	Waves	1.09 E19	2.54 E4	27.7
7	Earth cycle	1.36 E19	2.9 E4	39.5
8	Earth loss, 5.87 E14 g/y	--	1.71 E9/g	100.0
9	Topsoil formation (net)	2.10 E18	6.25 E4	13.0
10	Wood consumption	4.72 E18	3.49 E4	16.4
11	Coal production	2.1 E19	3.98 E4	83.6
	consumption	1.8 E19	3.98 E4	73.5
12	Crude oil production	1.93 E19	5.3 E4	102.0
	consumption	1.87 E19	5.3 E4	98.5
13	Natural gas consumption	2.36 E19	4.8 E4	113.0
14	Electricity, total	8.27 E18	15.9 E4	132.0
	Nuclear	9.1 E17	15.9 E4	14.5
	Hydro	9.8 E17	15.9 E4	15.6
15	Phosphate production, rock, 5.0 E6 T	--	1.41 E16 SEJ/T	7.1
	fertilizer, 2.97 E6 T	--	2.0 E16 SEJ/T	5.9
16	Iron ore production, 69.6 E12 g	--	8.5 E8 SEJ/g	5.9
17	Bauxite production, 1.5 E12 g	--	8.5 E8 SEJ/g	0.13

Table 17.1 continued.

Footnote	Type of Energy	Actual Energy J	ETR SEJ/J or SEJ/T	Solar Embodied Energy E22 SEJ
<u>Imports</u>				
18	Oil import and use	1.55 E19	5.3 E4	82.0
19	Natural gas import and use	1.05 E18	4.8 E4	5.0
20	Goods and services	--	--	58.1
21	Iron and steel products, 16.26 E6 T	--	1.78 E15 SEJ/T	2.9
22	Iron ore import and use, 28.3 E12 g	--	8.5 E8 SEJ/g	2.4
23	Bauxite import and use, 13.9 E12g	--	8.5 E8 SEJ/g	1.2
<u>Exports</u>				
24	Coal	2.53 E18	3.98 E4	10.1
25	Grain	2.05 E18	6.8 E4	14.0
26	Wood	2.2 E17	3.49 E4	0.77
27	Phosphate, natural, 14.3 E6 T	--	1.41 E10 SEJ/gP	2.0
	Phosphate, fertilizers, 9.9 E5 T	--	2.0 E10 SEJ/gP	1.98
28	Petroleum and products	6.4 E17	5.4 E4	3.5
29	Iron and steel products, 4.5 E6 T	--	1.78 E15 SEJ/T	0.80
30	Goods and services	--	--	47.6

Footnotes for Table 17.1

1. Direct sun

Total area: $9.4 \text{ E}12 \text{ m}^2$, Alaska: $1.53 \text{ E}12 \text{ m}^2$
Continental shelf: total: $1.7 \text{ E}12 \text{ m}^2$, Alaska: $1.07 \text{ E}12 \text{ m}^2$
(est. Nat Geog. 1981)₂₄₈ states av. net absorbed solar
radiation $110 \text{ kcal/cm}^2/\text{y}$

$(8.5 \text{ E}12 \text{ m}^2 \text{ without Alaska}) (110 \text{ kcal/cm}^2/\text{y}) (1 \text{ E}4 \text{ cm}^2/\text{m}^2)$
 $(4186 \text{ J/kcal}) = 3.9 \text{ E}22 \text{ J/y}$

Alaska, 35% albedo; solar radiation absorbed 65% of
 $3.35 \text{ E}9 \text{ J/m}^2/\text{y}$ (Budyko 1963)

$(2.6 \text{ E}12 \text{ m}^2) (2.18 \text{ E}9 \text{ J/m}^2/\text{y}) = 0.57 \text{ E}22 \text{ J/y}$

Total: $4.48 \text{ E}22 \text{ J/y}$

2. Wind, kinetic energy

Mean of 25 stations in US (Swaney 1978)

eddy diffusion coefficients: m^2/s

January 22.3
July 3.6

velocity gradients: $\text{E}-3 \text{ m/s/m}$

January 6.08
July 1.78

Winter:

$(1 \text{ E}3 \text{ m}) (1.23 \text{ kg/m}^3) (22.3 \text{ m}^2/\text{s}) (1.577 \text{ E}7 \text{ s}/0.5\text{y})$

$(6.08 \text{ E}-3 \text{ m/s/m})^2 (9.4 \text{ E}12 \text{ m}^2) = 1.50 \text{ E}20 \text{ J}/0.5\text{y}$

Summer:

$(1 \text{ E}3 \text{ m}) (1.23 \text{ kg/m}^3) (23.6 \text{ m}^2/\text{s}) (1.577 \text{ E}7 \text{ s}/0.5\text{y})$

$(1.78 \text{ E}-3 \text{ m/s/m})^2 (9.4 \text{ E}12 \text{ m}^2) = 0.135 \text{ E}20 \text{ J}/0.5\text{y}$

Total: $(1.50 + 0.135) \text{ E}20 \text{ J/y} = 1.63 \text{ E}20 \text{ J/y}$

3. Rain, chemical potential

Average 35.4 in/yr from mean of 50 values each a median for
one of the 50 states

(area) (average rainfall) (G)

Footnotes for Table 17.1 continued.

$$(9.4 \text{ E}12 \text{ m}^2) (35.4 \text{ in}) (2.54 \text{ cm/in}) (1 \text{ E}-2 \text{ m/cm}) (1 \text{ E}6 \text{ g/m}^3) \\ (4.94 \text{ J/g}) = 4.17 \text{ E}19 \text{ J/y}$$

4. Rain geopotential

Mean elevation, 763 m; mean rainfall, 0.9 m
(volume) (density) (gravity) (elevation)
 $(9.4 \text{ E}12 \text{ m}^2) (0.9 \text{ m/y}) (1 \text{ E}3 \text{ kg/m}^3) (9.8 \text{ m/s}^2) (763 \text{ m})$
 $= 6.33 \text{ E}19 \text{ J/y}$

5. Tide

Continental USA cont. shelf: $6.38 \text{ E}11 \text{ m}^2$, Alaska cont. shelf: N + W, $9.3 \text{ E}17 \text{ m}^2$; S shelf: $1.29 \text{ E}17 \text{ m}^2$ (estimated from Nat. Geog. 1981)

Tide height, continental USA: 1.2 m (av. from US Coastal and Geodetic Survey 1956)

(area elevated) (0.5) (tides/y) (ht)² (9.8 m/s²) (density) (% abs.)
Continental: $(6.38 \text{ E}11 \text{ m}^2) (0.5) (706/\text{y}) (1.2 \text{ m})^2 (9.8 \text{ m/s}^2)$
 $(1.025 \text{ E}3 \text{ kg/m}^3) (0.1) = 3.26 \text{ E}17 \text{ J/y}$
S Alaska: $(1.29 \text{ E}11 \text{ m}^2) (0.5) (706/\text{y}) (4\text{m})^2 (9.8 \text{ m/s}^2)$
 $(1.025 \text{ E}3 \text{ kg/m}^3) (0.1) = 7.3 \text{ E}18 \text{ J/y}$

6. Waves

Continental straight coastline: 6.4 E6 m (est. Nat Geog. 1981); Alaska N + W: 1.97 E6 m; Alaska S + Aleutians: 1.07 E6 m

Wave power: av USA: 40.5 kw/m; N. Pacific for S Alaska: 81 kw/m

Cont. USA: $(40.5 \text{ kw/m}) (1 \text{ E}2 \text{ w/kw}) (1 \text{ J/s/w}) (3.15 \text{ E}7 \text{ s/y})$
 $(6.46 \text{ E}6 \text{ m facing shore}) = 8.18 \text{ E}18 \text{ J/y}$

South Alaska: $(81 \text{ kw/m}) (1 \text{ E}3 \text{ w/kw}) (1 \text{ J/s/w}) (3.154 \text{ E}7 \text{ s/y})$
 $(1.07 \text{ E}6 \text{ m}) = 2.7 \text{ E}18 \text{ J/y}$

Total waves: $(8.18 \text{ E}18 \text{ J/y}) + (2.7 \text{ E}18 \text{ J/y}) = 1.09 \text{ E}19 \text{ J/y}$

Footnotes for Table 17.1 continued.

7. Earth cycle

US surface area assigned heat flows based on ages, following method and data of Sclater et al. (1980)

20%, 2 E6 J/m²/y; 40%, 1.56 E6 J/m²; 25%, 1.2 E6 J/m²/y;
15%, 1 E6 J/m²/y.

$$(9.4 \text{ E12 m}^2) (1.45 \text{ E6 J/m}^2/\text{y}) = 1.36 \text{ E19 J/y}$$

8. Earth loss

Suspended load, mean of 12 rivers of US (Leopold et al. 1964): 93.6 g/m²/y; earth formation assumed equal to mean earth cycle, 31.2 g/m²/y

(erosion) minus (formation)

$$[(93.6 \text{ g/m}^2/\text{y}) - (31.2 \text{ g/m}^2/\text{y})] (9.4 \text{ E12 m}^2) = 5.87 \text{ E14 g/y}$$

9. Topsoil formation

Mean form erosion from Larson et al. (1983), 687 g/m²/y; US farm area, 1.042 E9 acres (US 1983); soil formation in forest area, 1260 g/m²/y (Appendix A18); US forest, wild-life and misc. area, 51% (US 1983)

(formation) - (erosion)

$$(0.51) (9.4 \text{ E12 m}^2 \text{ US}) (1260 \text{ g/m}^2/\text{y}) -$$

$$(687 \text{ g/m}^2/\text{y}) (4.22 \text{ E12 m}^2 \text{ farms}) = 3.1 \text{ E15 g/y}$$

$$(3.1 \text{ E15 g/y}) (0.03 \text{ org}) (5.4 \text{ kcal/g}) (4186 \text{ J/kcal})$$

$$= 2.10 \text{ E18 J/y}$$

10. Wood consumption

15695 E6 cu.ft./y roundwood equivalents (US 1983)

$$(1.569 \text{ E10 cu.ft.}) (2.7 \text{ E-2 m}^3) (0.7 \text{ E6 g/m}^3) (3.8 \text{ kcal/g})$$

$$(4186 \text{ J/kcal}) = 4.72 \text{ E18 J/y}$$

Footnotes for Table 17.1 continued.

11. Coal production

1980: 19.2 E15 BTU (US 1983) 1054 J/BTU
(19.2 E15 BTU) (1054 J/BTU) = 2.02 E19 J/y

12. Crude oil production

1980: 18.3 E15 BTU (US 1983)
(18.3 E15 BTU) (1054 J/BTU) = 1.93 E19 J/y

13. Natural gas production

1980: 22.4 E15 BTU (US 1983)
(22.4 E15 BTU) (1054 J/BTU) = 2.36 E19 J/y

14. Electricity, total

1980: 8.27 E18 J/y (US 1983)

Nuclear electricity

1980: 9.1 E17 J/y (US 1983)

Hydroelectricity

1980: 9.8 E17 J/y (US 1983)

15. Phosphate production

1978 phosphate rock: 5.0 E7 T; 1980 phosphate fertilizer:
9.0 E6 T (UN 1981); 10% of rock is P, 33% of fertilizer is P.

Rock: (5.0 E7 T) (0.1) = 5.0 E6 T/y

Fertilizer: (9.0 E6 T) (0.33) = 2.97 E6 T/y

16. Iron ore production

69.6 E6 T, 0.77 E9 \$ (US 1983)

17. Bauxite production

1980: 1.5 E6 T, 0.39 E9 \$ (US 1983)

Footnotes for Table 17.1 continued.

Imports

18. Crude and refined oil

1980: 11.2 E15 BTU + 3.5 E15 BTU (US 1983), 77.6 E9 \$
(14.7 E15 BTU) (1054 J/BTU) = 1.55 E19 J/y

19. Natural gas

1980: 1.0 E15 BTU (US 1983), 5.2 E9 \$
(1.0 E15 BTU) (1054 J/BTU) = 1.05 E18 J/y

20. Goods and services imported

(Goods not calculated separately plus services not already included in other imports. See Section 4.)

1980: 244.9 E9 \$ (US 1983); world energy/\$ ratio:
3.8 E12 SEJ/\$ (Appendix A4)

(244.9 E9 \$ total imp) - (77.6 E9 \$ oil) - (5.2 E9 \$ nat. gas)
- (7.7 E9 \$ iron and steel) - (0.77 E9 \$ iron ore)
- (0.39 E9 \$ bauxite) = 1.53 E11 \$
(1.53 E11 \$) (3.8 E12 SEJ/\$) = 5.81 E23 SEJ/y

21. Iron and steel products

16.2 E6 T, 7.7 E9 \$ (Un Trade 1981)

22. Iron ore import and use

25.1 E6 T, 773 E6 \$, 1980 (US 1983)

23. Bauxite import and use

(13.9 E6 T, 389 E6 \$, 1980 (US 1983)

Exports

24. Coal

1980: 2.4 E15 BTU (US 1983), 4.5 E9 \$

Footnotes for Table 17.1 continued.

$$(2.4 \text{ E15 BTU}) (1054 \text{ J/BTU}) = 2.53 \text{ E18 J/y}$$

25. Grain

1980: 122.7 E6 T wheat, corn, rice, soybeans; 22.3 E9 \$ (US 1983)

$$(122.7 \text{ E6 T}) (4 \text{ kcal/g}) (1 \text{ E6 g/T}) (4186 \text{ J/kcal}) = 2.05 \text{ E18 J/y}$$

26. Wood

Rough: 10.2 E6 T, \$1.45 E9; shaped 3.6 E6 T, 1.06 E9 \$

$$(13.8 \text{ E6 T}) (3.8 \text{ kcal/g}) (1 \text{ E6 g/T}) (4186 \text{ J/kcal}) = 2.2 \text{ E17 J/y}$$

27. Phosphate

Natural phosphates: 14.3 E6 T, 5.1 E8 \$; fertilizers: 3.0 E6 T (FAO 1978), 5.7 E8 \$ (World Bank 1982); 10% of phosphate is phosphorous; 33% of superphosphate is phosphorous (Appendix 6)

$$(14.3 \text{ E6 T}) (0.1) = 1.43 \text{ E6 T}; (3.0 \text{ E6 T}) (0.33) = 9.9 \text{ E5 T}$$

28. Petroleum and products

1980: petroleum 0.9 E9 \$, 5.1 E6 T; petro products: 2.1 E9 \$, 9.2 E6 T (UN Trade 1981); 45 E9 J/T (Slessor 1978), 1.43 E7 T, 3.0 E9 \$

$$(1.43 \text{ E7 T}) (45 \text{ E9 J/T}) = 6.4 \text{ E17 J/y}$$

29. Iron and steel products

3.5 E9 \$, 4.5 E6 T (UN Trade 1981)

30. Goods and services in exports

1980: 220.8 E9 \$ (US 1983)

$$(220.8 \text{ E9 \$ total exp}) - (4.5 \text{ E9 \$ coal}) - (22.3 \text{ E9 \$ grain})$$

$$- (2.5 \text{ E9 \$ wood}) - (1.9 \text{ E9 \$ phosphate}) - (3.0 \text{ E9 \$ oil})$$

$$- (3.5 \text{ E9 \$ iron and steel}) = 183.1 \text{ E9 \$}$$

$$(183.1 \text{ E9 \$}) (2.6 \text{ E12 SEJ/\$}) = 47.6 \text{ E22 SEJ/y}$$

Table 17.2 Energy storages in the United States of America.

Footnote	Type of Energy	Actual Energy J	ETR SEJ/J or SEJ/T	Embodied Solar Energy E24 SEJ
I	Phosphate rock, 1.8 E8 T	--	1.41 E10 SEJ/gP	2.5
2	Coal	1.17 E22	3.98 E4	466.0
3	Natural gas	2.95 E20	4.8 E4	14.1
4	Uranium	2.95 E20	1.79 E3	0.53
5	Crude petroleum	1.71 E20	5.3 E4	9.1
6	Topsoil	7.35 E20	6.3 E4	46.3
7	Wood biomass	4.72 E19	3.49 E4	1.65
8	Ground water	1.88 E20	4.1 E4	7.7

Footnotes for Table 17.2

1. Phosphate rock: 1.8 E9 T (US 1983); 10% P.
(1.8 E9 T) (0.1) = 0.18 E9 T
2. Coal: 3.7 E11 T, Brown coal and lignite: 0.3 E11 T (UN 1981)
(7 E6 kcal/T) (4186 J/kcal) (4.0 E11 T) = 1.18 E22 J
3. Natural gas: 5.7 E12 m³ at 9077 kcal/m³ (UN 1981)
(5.7 E12 m³) (9077 kcal/m³) (4186 J/kcal) = 2.17 E20 J
4. Uranium: 5.3 E5 T (UN 1981)
(Wt of uranium ore, T) (0.007) (1 E6 g/T) (7.95 E10 J/g U₂₃₅)
(5.3 E5 T) (0.007) (1 E6 g/T) (7.95 E10 J/g) = 2.95 E20 J
5. Crude petroleum: 3.8 E9 T (UN 1981); 45 E9 J/T (Slessor 1978)
(3.8 E9 T) (45 E9 J/T) = 1.71 E20 J

Footnotes for Table 17.2 continued.

6. Topsoil

farm area, $4.22 \text{ E}12 \text{ m}^2$, 11.4 T org./A (Brady 1974)

forest and miscellaneous area, $4.79 \text{ E}12 \text{ m}^2$, 17.5 T/A

organic matter:

$$(4.22 \text{ E}12 \text{ m}^2) (11.4 \text{ T/A}) (1 \text{ E}6 \text{ g/T}) + (4.79 \text{ E}12 \text{ m}^2)$$

$$(4.79 \text{ E}12 \text{ m}^2) (17.5 \text{ T/A}) (1 \text{ E}6 \text{ g/T}) = 3.25 \text{ E}16 \text{ g}$$

$$(3.25 \text{ E}16 \text{ g}) (5.4 \text{ kcal/g}) (4186 \text{ J/kcal}) = 7.35 \text{ E}20 \text{ J}$$

7. Wood biomass (US 1983)

8. Groundwater

$$(9.4 \text{ E}12 \text{ m}^2) (0.05 \text{ porosity}) (100 \text{ m}) (1 \text{ E}6 \text{ g/m}^3) (4 \text{ J/g})$$

$$= 1.88 \text{ E}20 \text{ J (US 1983)}$$

Table 17.3 Summary flows for USA in Figure 17.1.

Letter in Figure	Item	Embodied Solar Energy E22 SEJ/y	Dollars E12 \$/y
R	Renewable sources used, SEJ/yr (rain, tide)	82.4	
N	Nonrenewable sources flow within the country (SEJ/yr):	100.0	
	N ₀ Dispersed rural source (SEJ/yr)	100.0	
	N ₁ Concentrated use (SEJ/yr)	330.0	
	N ₂ Exported without use	15.6	
F	Imported minerals and fuels (SEJ/yr)	90.6	
G	Imported goods (SEJ/yr)	2.9	
P ₂ I ₃	Imported service (SEJ/yr)		
I	Dollars paid for imports (\$/yr)	--	0.24
I ₃	Dollars paid for imports minus goods	--	0.153
E	Dollars paid for exports (\$/yr)	--	0.22
E ₃	Dollars paid for exports minus goods	--	0.18
P ₁ E ₃	Exported services (SEJ/yr)	46.7	
B	Exported products, transformed within the country (SEJ/yr)	17.6	
X	Gross National Product (\$/yr)	--	2.6
P ₂	Ratio embodied energy to dollar of imports (SEJ/\$) (world)	3.8 E12 SEJ/\$	
P ₁	Ratio embodied energy to dollar of country and for its exports (SEJ/\$)	2.6 E12 SEJ/\$	

Footnotes for Table 17.3

R Renewables: rain, tide = 82.4 E22 SEJ/y

N Nonrenewable sources:

N₀ Dispersed rural: soil = 100 E22 SEJ/y

N₁ Concentrated: oil, coal, gas, nuc and hydro electricity,
phosphate, iron ore, bauxite = 330.13 E22 SEJ/y

N₂ Exported without use: oil, coal, phosphate =
15.6 E22 SEJ/y

F Imported minerals and fuels: oil, gas, iron ore, bauxite
= 90.6 E22 SEJ/y

G Imported goods: iron and steel = 2.9 E22 SEJ/y

P₂I₃ Imported services minus those in F and G: 58.1 E22 SEJ/y
(Table 17.1, Footnote 20)

I US Statistical Abstract

I₃ US Statistical Abstract

E US Statistical Abstract

E₃ US Statistical Abstract

P₁E₃ Exported services minus those in B and N₂: coal, grain,
wood, phosphate, oil, iron and steel:
(183.1 E9 \$)(2.6 E12 SEJ/\$, US energy/\$ ratio) =
4.67 E23 SEJ/y

B Exported products transformed within the country:
phosphate, grain, wood, iron and steel = 17.57 E22 SEJ/y

X Gross National Product
1980: 2.6 E12 \$ (US 1983)

P₂ See Appendix A4

P₁ See Item 19, Table 17.4

Table 17.4 Indices using embodied energy for overview of USA.

Item	Name of index and expression, see Figure 17.1		
1	Renewable embodied energy flow	R	82.4 E22 SEJ/y
2	Flow from indigenous non-renewable reserves	N	445.6 E22 SEJ/y
3	Flow of imported embodied energy	$F+G+P_2I_3$	152.0 E22 SEJ/y
4	Total embodied energy inflows	$R+N+F+G+P_2I_3$	680.0 E22 SEJ/y
5	Total embodied energy used, U	$U=N_0+N_1+R+F+G+P_2I_3$	664.0 E22 SEJ/y
6	Total exported embodied energy	$B+P_1E_3$	64.0 E22 SEJ/y
7	Fraction of embodied energy used derived from home sources	$(N_0+N_1+R)/U$	0.77
8	Imports minus exports	$(F+G+P_2I_3)-(N_2+B+P_1E_3)$	96.0 E22 SEJ/y
9	Ratio of exports to imports	$(N_2+B+P_1E_3)/(F+G+P_2I_3)$	0.45
10	Fraction used, locally renewable	R/U	0.12
11	Fraction of use purchased	$(F+G+P_2I_3)/U$	0.23
12	Fraction used that is imported service	P_2I/U	0.14
13	Fraction of use that is free	$(R+N_0)/U$	0.27
14	Ratio of concentrated to rural	$(F+G+P_2I_3+N_1)/(R+N_0)$	2.6
15	Use per unit area (9.4 E12 m ²)	U/(area)	7.0 E11 SEJ/m ²
16	Use per capita (227 E6 population)	U/(population)	2.9 E16 SEJ/person
17	Renewable carrying capacity at present living standard	(R/U) (population)	27.0 E16 people
18	Developed carrying capacity at same living standard	8(R/U) (population)	216.0 E6 people
19	Ratio of use to GNP (energy-dollar ratio)	$P_1 = U/(\text{GNP})$	2.6 E12 SEJ/\$
20	Ratio of electricity to use	(E1)/U	0.20
21	Fuel use per person (fuel, 3.865 E24 SEJ)	(fuel)/(population)	1.7 E16 SEJ/person

Discussion

Some indices of the US energy system in 1980 are compared with those of other countries in Tables 18.1-18.4.

The US had a relatively low energy/\$ ratio, because more of its resources were economically developed. This means that trading, based on dollar values, with most countries brought in up to 15 times more embodied energy than was exchanged.

Although the US had a negative dollar trade balance, it profited from about 2 times more imports than exports of embodied energy.

The high electrical use per person and the high fraction of electrical use in the economy indicated both the country's advanced technological development and its wastefulness.

The energy per person was among the highest, partly based on fuels and partly on environmental sources. The loss of earth by erosion was one of the largest non-renewable energy flows.

Although European countries like West Germany and the Netherlands have a lower fuel per person than in the US (Table 18.4), their large imports of primary products bring their total energy per person to a figure about equal to that of the US.

The US economy was 77% self-sufficient, dependent on indigenous sources like sun, rain, soil, and fossil fuels. But, its carrying capacity on renewable sources alone would be only 12% of the 1980 population, or that population at 12% of its energy use per person.

Howard T. Odum
*Environmental Engineering Sciences and
Center for Wetlands
University of Florida, Gainesville*

Elisabeth C. Odum
*Santa Fe Community College,
Gainesville, Florida*

18. COMPARISONS

The new data on national embodied energy given in Chapters 5 - 16 show large differences among nations. Extremes and limits show up for various nations suggesting ways that public policies might improve economies and develop better balances of resource use, better import - export balances, and better matching of indigenous resources with attracted resources from outside.

To facilitate comparisons, summary tables are given (Tables 18.1 - 18.4). Not all of the similarities and differences are yet understood. Perhaps, a full discussion should wait until analyses of more countries are completed. Quite a different picture of strength and opportunity emerges from use of total embodied energy than when fuels and dollars are used, as in the recent discussion of underdeveloped countries and energy by Dunkerley et al. (1982). Recommendations about export policy and devaluation may be the reverse from the ones practiced by underdeveloped countries which sell raw products.

Indigenous Energy

Table 18.1 compares the fraction of the total annual energy budget (in embodied solar equivalents) that comes from within a country. This ratio is a measure of self-sufficiency. It is also a measure of resources not yet matched by investments and economic development that bring in additional embodied energy from outside. The Soviet Union is the most self-sufficient, with West Germany the most dependent on imported energies. When easily-transported energies are less available in the future, the self-sufficient nations may have less cutting back to do.

Table 18.1. Fraction of national embodied energy that is indigenous.

	<u>Indigenous</u> <u>Total Use</u>
Spain	0.24
Liberia	0.92
New Zealand	0.60
Dominica	0.89
Netherlands	0.23
West Germany	0.104
Soviet Union	0.97
Brazil	0.91
Australia	0.92
India	0.88
Poland	0.66
U.S.A.	0.77

Ratio of Imports to Exports

Ratio of imports to exports are compared in Table 18.2. The countries with the highest figures greater than one had the greatest excess of imports. Their economies gained embodied energy from international trade. If this was a large part of its economy, such a country got a boost from this extra energy.

Table 18.2. Ratio of imports to exports expressed in embodied energy.

	SEJ/SEJ
Spain	2.3
Liberia	0.151
New Zealand	0.76
Dominica	0.84
Netherlands	4.3
West Germany	4.2
Soviet Union	0.23
Brazil	0.98
Australia	0.29
India	1.45
Poland	0.65
U.S.A.	2.2

The smaller the ratio number, the more embodied energy was exported from the country in relation to that imported. This exchange would have a depressing influence on the economy, in proportion to the importance of trade to the whole economy. The Netherlands, West Germany, and Spain have the high values. In contrast, Liberia and Australia with low values are sending out much of their potential.

Ratio of Embodied Energy Use to Dollar Flow

The embodied energy to dollar ratio in Table 18.3. is the ratio of total embodied energy to gross national product, the

Table 18.3. Ratio of embodied energy use of a nation to its dollar flow.

	E12 SEJ/\$
Spain	1.56
Liberia	34.5
New Zealand	3.0
Dominica	14.9
Netherlands	2.2
West Germany	2.5
Soviet Union	3.4
Brazil	0.9
Australia	12.1
India	6.4
Poland	6.0
U.S.A.	2.6
World (see Appendix A 4)	3.8

latter expressed in current U.S. dollars. Countries with large subsistence use, barter, and artificially devalued currencies have a large embodied energy per dollar. Such countries sell their products at a bargain. In a way this ratio predicts the consumer price index and should be compared with it. The ratio is also useful to show which of two trading countries profits when

prices are set on international dollar exchange rates. The larger the energy-dollar ratio, the more the economy is hurt by current trade practices, and the less the money can be used as an appropriate measure of ultimate economic value.

Energy per Person

Table 18.4. has embodied energy share per person obtained by dividing the national total by population. In the first column is the fuel use per person, an index already much used in the literature to present human demand on resources.

Table 18.4. Embodied Energy per person, E15 SEJ/person/year.

	Fuels	Electricity	All Sources
Spain	4.0	1.3	6.
Liberia	0.6	0.27	26.
New Zealand	4.8	3.8	26.
Dominica	0.2	0.00001	13.
Netherlands	11.6	2.5	26.
West Germany	8.2	2.9	28.
Soviet Union	10.9	2.9	15.
Brazil	1.6	0.8	10.
Australia	9.3	3.4	8.
India	0.3	0.10	1.
Poland	6.9	1.8	1.
U.S.A.	17.0	5.8	29.

However, when total embodied energy is used (last column) many of the countries change in their rank of per capita energy use. Large environmental resources of underdeveloped areas provide many free services, life support, low taxes and land costs, etc. that are more properly estimated with the embodied energy measure than with dollars or fuel energies. Where populations are excessive as in India, the energy per person is low. Some highly developed countries also have lower than expected energy per person ratios.

Electricity Use

Electricity as a moderately high quality form of energy may be used as an index of technological development. See electrical energy per person (in embodied solar equivalents) in Table 18.4. Liberia and Dominica are least and New Zealand, Australia, West Germany, and the Soviet Union are highest.

Summary

The comparative energy analysis of countries provides perspectives on the basis for economic vitality and relationships between countries not easily indicated with traditional indices. In this study, earlier efforts by Kemp, Boynton, and Limburg (1981) and by Zuchetto (1981) to use embodied energy of environmental resources to compare nations have been extended with new energy transformation ratios to include more of the energy signature. By these means a total energy systems basis for economics is used to appraise the state of nations and their futures.

REFERENCES

- Adams, C.E. 1978. Late Cenezoic Erosion in New Zealand. Thesis, Tussock Grasslands and Mountain Lands Institute, Canterbury University, New Zealand.
- AER: Algemene Energie Raad. 1982. Renewable Energy. The Hague: Staatsuitgery.
- Alexandersson, G. and B. Klevebring. 1978. World Resources. Berlin: Walter de Gruyter.
- Anderson, J.W. 1980. Bioenergetics of Autotrophs and Heterotrophs. London: Edward Arnold.
- Australian Bureau of Statistics. 1981a. Australian Yearbook, 65. Canberra, Australia.
- Australian Bureau of Statistics. 1981b. Victorian Yearbooks, 95. Melbourne, Australia: Commonwealth Banks Building, Flanders and Elizabeth Streets.
- Australia Department of Meteorology. 1977. Upper Air Stations. Canberra, Australia: Department of Meteorology.
- Australian Economic Statistics, 1949-1950 to 1980-1981: 1 Tables. Occasional Paper No. 8, W.F. Norton, P.M. Garniston, and M.W. Brodie, 1982. Sydney: Research Bank of Australia.
- Bailey, A.E. 1945. Industrial Oil and Fat Products. New York: Wiley-Interscience.
- Ballentyne, E.R. 1976. Solar Tables for Australia. Canberra: Commonwealth Scientific and Industrial Research Organization (CSIRO).

- Bañados, Maria C., ed. 1981. Energy Balance for Latin America. Olade Document Series No. 13. Quito, Ecuador: Latin America Energy Organization.
- Bartholomew, Warne. 1974. Atlas of Europe. Edinburgh: Warne Bartholomew.
- Bayley, S., J. Zuchetto, L. Shapiro, and J. Nessel. 1977. Energetics and Systems Modeling: A Framework Study for Energy Evaluation of Alternative Transport Models. Fort Belvoir, Virginia: U.S. Army Engineers Report, IWR Contract Report 77-10.
- Benson, Precious, ed. 1979. Liberia on the Move. London: Neralime, Ltd.
- Berry, R.S. and M.F. Fels. 1973. The Production and Consumption of Automobiles. Chicago: University of Chicago Press.
- Bochkov, A.P., A.I. Chebotarev, and K.P. Voskresenky. 1972. Water Resources and Water Balance of the USSR. Symposium on World Water Balance, Volume II. Geneva: UNESCO.
- Brady, Nyle C. 1974. The Nature and Properties of Soils. New York: MacMillan.
- Bray, J.R. 1979. Organic Matter in New Zealand. New Zealand Ecological Society Annual Meeting, unpublished circular, Wellington.
- Brown, M.T. 1980. Energy Basis in Urban and Regional Hierarchies. Ph.D. dissertation, University of Florida, Department of Environmental Engineering, College of Engineering, Gainesville, Florida.
- Brown, S. and A. Lugo. 1982. The Storage and Production of Organic Matter in Tropical Forests and Their Role in the Global Carbon Cycle. Biotropica: 14(3): 161-187.
- Budyko, M.I. 1974. Climate and Life. New York: Academic Press.
- Bundesanstalt für Wassergüte. 1982a. Hydrological Yearbook of Austria. Vienna, Austria: Bundesanstalt für Wassergüte.
- Bundesanstalt für Wassergüte. 1982b. Collection of the Results of the Monthly Analysis of the Danube in 1982. Vienna, Austria: Bundesanstalt für Wassergüte.
- Burnett, M.S. 1978. Energy Analysis of Intermediate Technology Agricultural Systems. Master's Thesis, University of Florida, Department of Environmental Engineering, College of Engineering, Gainesville, Florida.
- Cartographic Department of the Clarendon Press. 1972. Oxford Economic Atlas of the World, 4th Edition. London: Oxford University Press.

- Central Bureau of Statistics (CBS). 1978. Environmental Statistics. The Hague: Staatsuitgery.
- Central Bureau of Statistics (CBS). 1981. Statistical Yearbook of the Netherlands, 1980. The Hague: Staatsuitgery.
- Central Bureau of Statistics (CBS). 1982. Regionaal Statistisch Yearbook. The Hague: Staatsuitgery.
- Central Statistical Board of the USSR. 1981. The USSR in Figures for 1980. Moscow: Finansy i Statistika Pub.
- C.I.A. National Basic Intelligence Factbook. 1977. Washington, D.C.: Central Intelligence Agency, Office of Geographic and Cartographic Research.
- Clarke, R.A. and D. Matko. 1983. Soviet Economic Facts, 1917-1981. London: MacMillan Press, Ltd.
- Collier's Encyclopedia. 1982. New York: MacMillan Educational Company.
- Comecon Data 1981. 1982. Edited by the Vienna Institute for Comparative Economic Studies. London: MacMillan Press, Ltd.
- Comecon Foreign Trade Data 1980. 1981. Edited by the Vienna Institute for Comparative Economic Studies. London: MacMillan Press, Ltd.
- Commission of the Exports for Environmental Problems. 1974. Environmental Survey. Stuttgart: Kohlhammer W.
- Cook, E.F. 1976. The national energy future: problems and policy issues. In Middle and Long-Term Energy Policies and Alternatives. Hearings of the Subcommittee on Energy and Power of the Committee on Interstate and Foreign Commerce, U.S. House of Representatives, 94th Congress, Serial No. 94-63, Washington, D.C., pp. 1-59.
- Crabbe, D. and R. McBride. 1978. The World Energy Handbook. Great Britain: Koran Page, Ltd.
- CSIRO: Commonwealth Scientific and Industrial Research Organization. 1977. Upper Air Stations of Australia, Canberra, Australia.
- Dawson, S. March 1978. Energy Requirements of Inputs to Agriculture in New Zealand. Joint Centre for Environmental Sciences at Lincoln College, Canterbury, New Zealand, Occasional Paper No. 4, pp. 1-32.
- Department of National Development and Energy. 1980. Demand for Primary and Secondary Fuels. Australia 1960-1961 to 1979-1980. Canberra: Australian Government Publishing Service.

- Department of National Development and Energy. 1982. Australian Energy Statistics. Canberra: Australian Government Publishing Service.
- Der grosse Krueger Welt-Atlas. 1979. Munich: Krueger Verlag.
- Dewdney, J.C. 1971. A Geography of the Soviet Union. Oxford, England: Pergamon Press.
- Dewdney, J.C. 1982. USSR in Maps. London: Hodder and Stroughton.
- Dietrick, G. 1963. General Oceanography. New York: Wiley-Interscience.
- Dunkerley, J., W. Ramsey, L. Gordon, and E. Cecelski. 1982. Energy Strategies for Developing Nations. Washington, D.C.: Resources for the Future.
- Encyclopedia Britannica. 1973. Volume 13. Chicago: W. Benton.
- Erickson, K.P. 1981. Brazil. Pages 219-269, National Energy Profiles, edited by K.R. Stunkel. New York: Praegar.
- Espenshade, E., ed. 1979. Goode's World Atlas. Chicago: Rand Publishing Company.
- Ewel, K.A. and H.T. Odum. 1983. Cypress Swamps. Gainesville, Florida: University of Florida Press. Forthcoming.
- Facts and Figures on New Zealand Agriculture. 1978. Wellington, New Zealand: Ministry of Forestry, Information Services.
- F.A.O. 1979. FAO Fertilizer Year Book 1978. Rome: Food and Agriculture Organization of the United Nations.
- Fluck, R.C. and C.D. Baird. 1980. Agricultural Energetics. Westport, Connecticut: AVI Publishing Company.
- Forestry Council. 1978. Energy Requirements and Production by Forest Industries in New Zealand. Wellington: Forestry Council.
- Fundação Institute Brasileiro de Geografia e Estatística. 1980. Rio de Janeiro: Anuário Estatístico do Brazil.
- General Drafting Company, Inc. 1975. Man's Domain, a Thematic Atlas of the World. New York: McGraw-Hill.
- Gilliland, M.W. 1973. Man's Impact on the Phosphorus Cycle in Florida. Ph.D. dissertation, University of Florida, Environmental Engineering Sciences, Gainesville.
- Gilliland, M.W. 1976. A geochemical model for evaluating theories on the genesis of Florida's sedimentary phosphate deposits. Mathematical Geology, 8:219-242.
- Gilliland, M.W. 1981. Energy analysis and public policy. Science, 189:1051-1056.

- Gilliland, M.W. 1983. Embodied energy studies of metal and fuel minerals; rates of formation for ore metals; summary of coal formation rates. Appendices, pp. G1-G23, in Use of Embodied Energy Values to Price Environmental Factors: Examining the Embodied Energy/Dollar Relationship, by M.J. Lavine and T.J. Butler. Report to the National Science Foundation under grant #PRA-8003845. Ithaca, New York: Center for Environmental Research, Cornell University.
- Gilliland, M.W., L.B. Fenner, and M. Eastman. 1978. Energy measures of rocks as environmental resources. El Paso, Texas: Energy Policies Studies, Inc. (unpublished memorandum).
- Gilliland, M. and M. Eastman. 1981. Free energies for iron aluminum and copper ores. El Paso, Texas: subcontract report (unpublished memorandum).
- Glowny Urzad Statystyczny. 1979. Rocznik Statystyczny 1978. Warsaw: Ministerstwo Oswiaty i Wychowania (Main Bureau of Statistics 1979, Annual Statistics 1978).
- Goldemberg, J. 1982. Energy issues and policies in Brazil. Annual Review of Energy 7:139-174.
- Goldich, S.S. 1938. A study in rock weathering. Journal of Geology 46: 17-58.
- Goldman, M.I. 1979. The Changing Role of Raw Materials, Exports, and Soviet Foreign Trade in Soviet Economy in a Time of Change. Joint Economic Committee, Congress of the U.S., Volume I. Washington, D.C.: U.S. Government Printing Office.
- Goodes World Atlas. 1979. 16th Edition. Edited by Edward Espenshade. Chicago: Rand Publishing.
- Grilli, E., R. Hetlerline, and P. Pollak. 1979. An Econometric Model of the World Rubber Economy. Staff Commodity Paper No. 3. Washington, D.C.: World Bank.
- Gross, M. 1972. Oceanography - A View of the Earth. Englewood Cliffs, New Jersey: Prentice-Hall.
- Harris, G.S., M.J. Ellis, G.C. Scott, J.R. Wood, and P.H. Phillips. 1978. Energy scenarios for New Zealand. Energy 1:1-14.
- Houghton, H.G. 1954. On the annual heat balance of the northern hemisphere. Journal of Meteorology 11:1-9.
- Hughes, L.A. 1952. On the low level wind structure of tropical storms. Journal of Meteorology 9:422-428.
- International Bank for Reconstruction and Development, World Bank. 1981. World Bank Atlas: Gross National Product, Population and Growth Rates. Washington, D.C. World Bank.

- International Commission for the Protection of the Rhine Against Pollution. 1979. Tables of the physical-chemical analyses of the Rhine and Mosel. Koblenz: International Commission for the Protection of the Rhine against Pollution. (unpublished data).
- Jahrbuch für Bergbau, Energie, Mineralöl und Chemie (Yearbook for Mining, Energy, Crude Oil, and Chemistry). 1982-1983. Essen: Verlag Glückauf Gmbh.
- Jansen, M.L. 1977. Energy - New Zealand's Future. Methuen: New Zealand.
- Jenny, H. 1982. The Soil Resource: Origin and Behavior. New York: Springer-Verlag.
- Judson, S. 1968. Erosion of the land or what's happening to our continents. American Science 56:356-374.
- Keller, R. 1972. Water Balance in the FRG. Pages 300-313, Symposium on World Water Balance, Volume II, AIHS Publication No. 94. Paris: UNESCO.
- Kemp, W.M. 1981. The Influence of National Renewable Energies on National Economies of the World in Energy and Ecological Modeling. New York: Elsevier Scientific Publishing Company.
- Kemp, W.M., W.R. Boynton, and K. Limburg. 1981. The influence of natural resources and demographic factors in the economic production of nations. Pages 827-839 in Energy and Ecological Modelling, edited by W.J. Mitsch, R.W. Bosseman, and J.M. Klopatek. Amsterdam: Elsevier Scientific Publishing Company.
- Kinsman, D. 1965. Wind Waves. Englewood Cliffs, New Jersey: Prentice-Hall.
- KNMI: Koninklijk Nederlands Meteorologisch Instituut. 1980. Weather Statistics. DeBilt: KNMI.
- Krauskopf, K.B. 1967. Introduction to Geochemistry. New York: McGraw-Hill.
- Kylstrea, C. and Ki Han. 1975. Energy analysis of the U.S. nuclear power system. Pages 138-200, Energy Models for Environment, Power, and Society. Report to Energy Research and Development Administration, Contract E-(40-1)-4398. Gainesville, Florida: Environmental Engineering Sciences, University of Florida.
- Lackey, R., and L. Nielsen. 1980. Fisheries Management. New York: Halsted Press.
- Landsberg, H.E. 1977. World Survey of Climatology, Volume 6. College Park, Maryland: Elsevier Scientific Publishing Company.

- Larson, W.E., F.J. Pierce, and R.H. Dowdy. 1983. The threat of soil erosion to long-term crop production. *Science* 219: 458-465.
- Lavine, M.J. and T.J. Butter. 1982. Use of embodied energy values to price environmental factors. Report on National Science Foundation Project PRA-8003845. Ithaca, New York: Center for Environmental Research, Cornell University.
- Lawson, N.V. and C.L. Abernethy. 1977. Long-term wave statistics off Botany Bay. 3rd Australian Conference on Coastal and Ocean Engineering. Melbourne: Institute of Engineers of Australia.
- Lawson, N.V. and P.H. Youll. 1977. Storm duration and return interval for waves off the central N.S.W. coast. 3rd Australian Conference on Coastal and Ocean Engineering. Melbourne: Institute of Engineers of Australia.
- Leopold, L.B., M.G. Wolman, and J.P. Miller. 1964. *Fluvial Processes in Geomorphology*. San Francisco: W.H. Freeman and Company.
- Lieth, H. and R.H. Whittaker, eds. 1975. *Primary Production of the Biosphere*. Berlin: Springer-Verlag.
- Lisle, J.F. 1960. Mean daily insolation in New Zealand. *New Zealand Journal of Science* 9(4):992-105.
- Lockeretz, W. 1979. Energy inputs for nitrogen, phosphorus, and potash fertilizers. In *Energy in Agriculture*, D. Pimentel, editor. West Palm Beach, Florida: CRC Handbook Series, CRC Press.
- London Times. 1973. *The Times Atlas of the World*. Edinburgh: John Bartholomew & Sons, Ltd.
- Lugo, A. and S. Brown. 1981. Tropical forests of the Caribbean. *Ambio* 10(6): 318-325.
- Marie, J.M. 1979. Agricultural Diversification in a Small Economy-The Case for Dominica. Occasional Paper No. 10. Cave Hill, Barbados: Institute of Social and Economic Research, University of West Indies.
- Marlier, G. 1973. Limnology of the Congo and Amazon Rivers. *Equatorial Ecosystems in Africa and South America*, edited by B.J. Meggers, S.S. Agenshu, and D. Duckworth. Washington, D.C.: Smithsonian Institution.
- Mason, T.G. 1922. The Ecological Significance of Soil Shrinkage. *West Indian Bulletin* 19(1).
- McChesney, I.G., J.W. Bubb, and R.G. Pearson. 1978. Energy Use on Canterbury Mixed Cropping Farms: a Pilot Survey, Occasional papers No. 5. Christchurch, New Zealand: University of Canterbury, Joint Centre for Environmental Services.

- McDonald, H.F. 1938. Atlas of Climatic Charts of the Oceans. Washington, D.C.: U.S. Department of Agriculture, Weather Bureau.
- Merriam, M.F. 1978. Wind, waves, and tides. Annual Review of Energy, Volume 3, edited by J.M. Hollander. Palo Alto, California: Annual Review, Inc.
- Michelin. 1982. Dutschland. Ludwigsburg: Süddeutsche Verlagsanstalt.
- Ministerio de Industria y Energia. 1982. The Situation of Energy in Spain. Madrid: Ministerio de Industria y Energia.
- Ministry of Energy. 1978. Goals and Guidelines, an Energy Strategy for New Zealand. Wellington, New Zealand: Ministry of Energy.
- Ministry of Energy. 1981. Energy Planning. Wellington, New Zealand: Ministry of Energy.
- Ministry of Forestry. 1981. Forestry Circular. Wellington, New Zealand: Ministry of Forestry.
- Ministry of Information and Broadcasting, Government of India. 1981. India - A Reference Annual 1981. Faridabad: Government of India Press.
- Ministry of Information, Cultural Affairs, and Tourism. 1979a. Background to Liberia. Monrovia, Liberia: IMPADS.
- Ministry of Information, Cultural Affairs and Tourism. 1979b. Liberia. Lagos, Nigeria: Third Press International
- Mitchell, Rodger. 1979. The Analysis of Indian Agro-Ecosystems. New Delhi: Interprint.
- MIT Marine Industry Collegium. 1979. Wave Power Systems. MIT Sea Grant Program, Opportunity Brief #15. Cambridge, Massachusetts: MIT Sea Grant.
- Monin, A.S. 1972. Weather Forecasting as a Problem in Physics. Cambridge, Massachusetts: MIT Press.
- Monteith, D.B. 1983. Energy production and consumption in wood harvest. Pages 449-464, Handbook of Energy Utilization in Agriculture. Boca Raton, Florida: CRC Press.
- Mudahar, M.S. and T.P. Hignett. 1982. Energy and Fertilizer, Policy Issues and Options for Developing Countries. Muscle Shoals, Alabama: International Fertilizer Development Center.
- National Geographic. 1981. Atlas of the World, Fifth Edition. Washington, D.C.: National Geographic Society.

- National Oceanic and Atmospheric Administration. 1977. Climatic Atlas of the United States. Washington, D.C.: National Oceanographic and Atmospheric Administration.
- New Zealand Department of Statistics. 1978. New Zealand Official Yearbook. Wellington, New Zealand: Department of Statistics.
- New Zealand Department of Statistics. 1979. New Zealand Pocket Digest of Statistics. Wellington, New Zealand: Government Printing.
- New Zealand Department of Statistics. 1981. Wellington, New Zealand: New Zealand Official Yearbook.
- Newell, R.E., J.W. Kidson, D.G. Vincent, and G.J. Boer. 1972. The General Circulation of the Tropical Atmosphere, Volume 1. Cambridge, Massachusetts: MIT Press.
- Norton, W.E. P.M. Garniston, and M.W. Brodie. 1982. Australian Economic Statistics 1949-1950 to 1980-1981: 1 Table. Occasional Paper No. 8A. Sydney: Reserve Bank of Australia.
- Odum, E.C., Graeme Scott, and H.T. Odum. 1980. Energy and the New Zealand Environment. Christchurch, New Zealand: Joint Centre for Environmental Science, University of Canterbury.
- Odum, H.T. 1971. Environment, Power, and Society. New York: J. Wiley.
- Odum, H.T. 1972. An energy circuit language for ecological and social systems, its physical basis. Pages 139-211, Systems Analysis and Simulation in Ecology, Volume 2, edited by B. Patten. New York: Academic Press.
- Odum, H.T. 1977. Energy questions and alternatives. Pages 111-145, Energy and Society. Porto Alegre: Comissão de Obras, Publicas da Assembleia, Legislativa do Estado do Rio Grande de Sul.
- Odum, H.T. 1978. Energy analysis, energy quality, and environment. Pages 55-87, Energy Analysis: a New Public Policy Tool. AAAS selected Symposium, Volume 9, edited by M. Gilliland. Boulder, Colorado: Westview Press.
- Odum, H.T. 1981. Energy, economy, and environmental hierarchy. Proceedings of the 3rd International Conference on Environment, Volume 4. Paris: Ministry of Environment.
- Odum, H.T. 1983. Systems Ecology. New York: J. Wiley.
- Odum, H.T. 1984. Energy analysis of the environmental role in agriculture. Chapter in Energy Analysis in Agriculture, edited by I.G. Stanhill. Forthcoming.

- Odum, H.T., C. Kylstra, J. Alexander, N. Sipe, P. Lem, et al. 1976. Net energy analysis of alternatives for the United States. Pages 258-302, Middle and Long-term Energy Policies and Alternatives. Hearings of Subcommittee on Energy and Power. Ninety-fourth Congress. Serial Number 94-63. Washington, D.C.: U.S. Government Printing Office.
- Odum, H.T. and E.C. Odum. 1980. Energy system of New Zealand and the use of embodied energy for evaluating benefits of international trade. Proceedings of Energy Modelling Symposium, Technical Publishing No. 7. Wellington, New Zealand: Ministry of Energy.
- Odum, H.T., F.C. Wang, J. Alexander, and M. Gilliland. 1981. Energy Analysis of Environmental Values. Report to Nuclear Regulatory Commission. Published subsequently as Appendix of H.T. Odum, et al., A Manual for Using Energy Analysis, 1983, Washington, D.C.: Nuclear Regulatory Commission.
- Odum, H.T., M.J. Lavine, F.C. Wang, M.A. Miller, J.F. Alexander, and T. Butler. 1983. A Manual for Using Energy Analysis for Plant Siting. U.S. Nuclear Regulatory Commission, NUREG/CR-2443. Washington, D.C.: Nuclear Regulatory Commission.
- Odum, H.T. and R.F. Pigeon. 1970. A Tropical Rain Forest. U.S. Atomic Energy Commission, Division of Technical Information, TID 24270. Washington, D.C.: Federal Clearinghouse.
- Ollier, C.D. 1981. Tectonics and Landform. New York: Longman.
- Organisation for Economic Cooperation and Development. 1979. New Zealand OECD Economic Surveys, Director of Information. Paris: OECD.
- Pendse, D.R. 1982. Statistical Outline of India. Bombay, India: Tata Services, Ltd, Bombay House.
- Pimentel, D. 1979. Energy in Agriculture. Pages 73-106, Food Climate and Man, edited by M.R. Biswas and A.K. Biswas. New York: J. Wiley.
- Pimentel, D. 1980. Handbook of Energy Utilization in Agriculture. Boca Raton, Florida: CRC Press.
- Pimentel, D. and M. Pimentel. 1979. Food, Energy, and Society. New York: Halstead Press, Wiley.
- Rao, K.L. 1975. India's Water Wealth. New Delhi: Orient Longman, Ltd.
- Reserve Bank of Australia. 1982. Australian Economic Statistics. Sydney: Reserve Bank of Australia.

- Ricaud, R. 1980. Energy input and output for sugarcane in Louisiana. Pages 135-136, Handbook of Energy Utilization in Agriculture, edited by D. Pimentel. Boca Raton, Florida: CRC Press.
- Richey, J.E., J.T. Brock, R.J. Naiman, R.C. Wissmer, and R.F. Stallard. 1980. Organic carbon: oxidation and transport in the Amazon River. Science 207:1348-1350.
- Riehl, H. 1979. Climate and Weather in the Tropics. New York: Academic Press.
- Rocznik Statystyczny 1978. 1978. Stanislaw Kuzinski, ed. Warsaw: Główny Urząd Statystyczny (Annual Statistics 1978, Main Bureau of Statistics).
- Ryabchikov, A. 1975. The Changing Face of the Earth. Moscow: Progress Publications.
- Schiavone, Giuseppe. 1981. The Institutions of Comecon. London: The MacMillan Press, Ltd.
- Schipper, L. 1975. Explaining energy. Pages 470-613, Middle and Long-term Energy Policies and Alternatives. Hearings before Subcommittee on Energy and Power of the Committee on Interstate and Foreign Commerce, U.S. House of Representatives, 94th Congress, Serial No. 94-63, Washington, D.C.
- Sclater, J.G., G. Taupart, and I.D. Galson. 1980. The heat flow through the oceanic and continental crust and the heat loss of the earth. Rev. of Geophysics and Space Physics 18:269-311.
- Secretariat of the Economic Commission for Europe. 1978. Economic Bulletin for Europe, Vol. 30, No. 1. New York: United Nations.
- Sellars, H.D. 1965. Physical Climatology. Chicago: University of Chicago Press.
- Shillingford, J.D. 1972. The Major Agricultural Lands in Dominica, W.I. and Their Potential for Development. Ithaca, New York: Cornell University Press.
- Showers, V. 1973. The World in Figures. New York: John Wiley and Sons.
- Siegl, F.R. 1974. Applied Geochemistry. New York: John Wiley and Sons.
- Slessor, M. 1978. Energy in the Economy. New York: MacMillan.
- Slessor, M. and C. Lewis. 1979. Biological Energy Resources. New York: E. & F.N. SPON, Wiley.
- Snead, R. 1980. World Atlas of Geomorphic Features. Huntington, New York: Robert E. Krieser, Publisher.

- Snoeyink, V.L., and D. Jenkins. 1980. Water Chemistry. New York: John Wiley and Sons.
- Statistisches Jahrbuch 1981 for the Federal Republic of Germany. 1981. Statistisches Bundesamt. Stuttgart: W. Kohlhammer.
- STIBOKA: Public Soil Mapping Service. 1980. Soils in the Netherlands. Wageningen: Stiboka.
- Stichting Bodem Kartering. 1980. Soils of the Netherlands. Wageningen: Stiboka.
- Stiff, M.J. 1980. River Pollution Control. Chichester: Ellis Horwood Publishing.
- Statham, I. 1977. Earth Surface Sediment Transport. Oxford: Oxford University Press.
- Swaney, D.P. 1978. Energy Analysis of Climatic Inputs to Agriculture. M.S. Thesis, Environmental Sciences, University of Florida, Gainesville.
- Todd, D.K., ed. 1970. The Water Encyclopedia. Port Washington, New York: Water Information Center.
- Toebe, C. 1972. Surface Water Resources of New Zealand. Wellington, New Zealand: 12th New Zealand Science Congress.
- Uhl, C. 1983. You can keep a good forest down. Natural History 924:71-79.
- United Nations. 1975. Dominica National Structure Plan. New York: Technical Cooperation of the United Nations.
- United Nations. 1977. 1977 Statistical Yearbook. New York: Department of International Economic and Social Affairs, Statistical Office, United Nations.
- United Nations. 1981a. 1978/1980 Statistical Yearbook. New York: United Nations.
- United Nations. 1981b. 1980 Yearbook of International Trade Statistics, Volume I and II. New York: United Nations.
- United Nations. 1982. Yearbook of Labor Statistics. New York: United Nations.
- UNESCO. 1978. World Water Balance and Water Resources of the Earth. Leningrad: UNESCO Press.
- U.S. Bureau of Census. 1977. Census of Manufacturers. Washington, D.C.: U.S. Government Printing Office.
- U.S. Department of Commerce (1947-1980). Statistical Abstract of the United States. Washington, D.C.: U.S. Government Printing Office.

- USSR National Committee for the International Hydrological Decade. 1977. Atlas of World Water Balance. Paris: UNESCO Press.
- Van Chi-Bonnardel, R. 1973. The Atlas of Africa. New York: The Free Press.
- Van Moeseke, P. 1981. Aluminium and Power: The Second Smelter Report. Economics Discussion Papers. Dunedin, New Zealand: University of Otago.
- Vienna Institute for Comparative Economic Studies. 1981. Comecon Foreign Trade Data 1980. London: The MacMillan Press, Ltd.
- Von der Haar, T.H. and V.E. Suomi. 1969. Satellite observations of the earth's radiation budget. Science 169:657-669.
- Von Gnielinski, S., ed. 1972. Liberia in Maps. New York: Africana Publishing, Corp.
- Weast, R., ed. 1974. Handbook of Chemistry and Physics. Cleveland, Ohio: CRC Press.
- Weyl, P.K. 1970. Oceanography. New York: John Wiley and Sons.
- Whetten, J.T. 1962. Geology of St. Croix U.S. Virgin Islands. Ph.D. dissertation, Princeton University, Princeton, New Jersey.
- Whittaker, R.H. 1975a. Communities and Ecosystems. New York: MacMillan.
- Whittaker, R.H. 1975b. Primary Productivity of the Biosphere. New York: Springer Verlag.
- World Atlas of Agriculture, Volume 1. 1969. Novara, Italy: Instituto Geografico de Agostini.
- World Bank. 1981a. Economic Memorandum on Dominica, Report No. 3368-DOM., Latin America and Caribbean Regional Office. Washington, D.C.: World Bank.
- World Bank. 1981b. World Bank Atlas. Washington, D.C.: International Bank for Reconstruction and Development.
- World Bank. 1981c. World Development Report 1981. Oxford, England: University Press.
- Zuchetto, J. and R. Walker. 1981. Time-series analysis of international energy-economic relationships. Pages 767-771, Energy and Ecological Modelling, edited by W.J. Mitsch, R.W. Bosserman, and J.M. Klopatek. Amsterdam: Elsevier Scientific Publishing Company.
- Zuchetto, J., and S. Brown. 1977. Comparison of the fossil fuel energy requirements for solar, natural gas, and electrical water systems. Resource Recovery and Conservation 2:283-300.

APPENDIX: ENERGY ANALYSIS OF SUBSYSTEMS
AND CALCULATIONS OF ENERGY
TRANSFORMATION RATIOS

- A.1 Global Solar Energy Inflow
- A.2 Summary of Energy Operating the Biosphere
- A.3 Energy Sources to the Crustal System
- A.4 Energy-Dollar Ratio for Exports from Industrial Countries
- A.5 Solar Equivalents of Industrial Fuel Heat Sources; Wood Power Plant at Jari, Brazil
- A.6 Phosphate Deposits of Florida
- A.7 Embodied Energy in Minerals from Uplift Rate
- A.8 Earth Cycle and Uplift
- A.9a Low Energy Corn
- A.9b Industrial Corn
- A.10 New Zealand Plantation Wood
- A.11 Sheep Production in New Zealand
- A.12 Aluminum Manufacture
- A.13 Solar Equivalents of Raw and Refined Iron, Steel, and End Products
- A.14 Hurricane Winds

- A.15 Potassium-Chloride from the Dead Sea Works
- A.16 Ammonium-Nitrogen Fertilizer
- A.17 Sugar Cane
- A.18 Earth and Soil
- A.19 Cattle in India

Included in this appendix are subsystem energy analyses used to estimate energy transformation ratios for many flows and commodities. The resulting ratios were assembled in Table 3.1 (Section 3). In each of the following energy analyses in this appendix, an energy diagram is drawn of a process with the main inputs identified and evaluated in solar equivalent joules. This involved some of the previously determined energy transformation ratios (Table 3.1). Then the ratio of all the inputs to actual energy of the product under study was calculated. Care was used in evaluating the input energies to avoid counting the same energy twice. For example if wind and rain energy were an input to an agricultural process, only the largest of the two was counted since both by-products were from the same global process driven by sunlight.

The format used in each of the appendices that follows is:

- Introductory paragraph;
- Subsystem diagram with embodied energy flows written;
- Energy evaluation table where embodied energy flows in the figure were evaluated;
- Footnotes to the evaluation table;
- References.

APPENDIX A1: GLOBAL SOLAR ENERGY INFLOW

The solar energy driving the biosphere and secondarily part of the continental geological system is absorbed in part in the atmosphere, part by the land and part by the ocean, the rest reflected and diffracted out as albedo. These flows and their coupling are given in Figure A1.

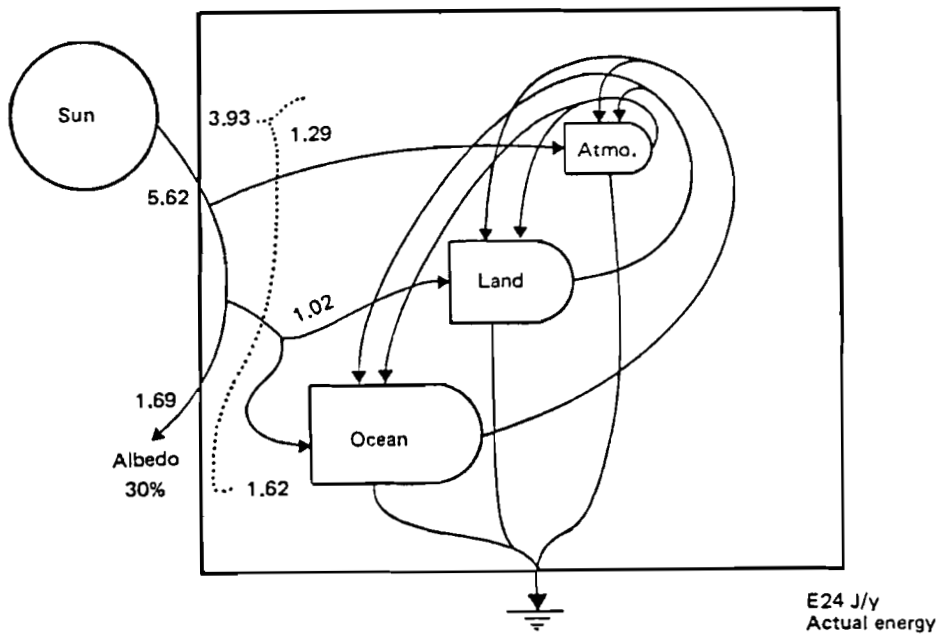

Figure A1. Inflows of global solar energy. See Table A1.

Table A1. Partition of global solar inflow, see Figure A1.

Footnote	Item	Actual energy flow E24/J/y
1	Solar insolation	5.62
2	Albedo	1.69
3	Absorbed by biosphere	3.39
4	Absorbed by atmosphere	1.29
5	Absorbed by ocean	1.62
6	Absorbed by land	1.02
7	Absorbed by ocean & atmosphere	2.91

Footnotes to Table A1

1. Incident energy, $2\text{gcal/cm}^2/\text{min}$ = solar constant.
 (solar constant) (earth cross sectional area facing sun)
 $(2 \text{ ly/min}) (1.27 \cdot 8\text{E}14 \text{ m}^2) (5.256 \text{ E}5 \text{ min/yr}) (1 \text{ kcal/m}^2/\text{ly})$
 $(4186 \text{ J/kcal}) = 5.623 \text{ E}24 \text{ J/y}$
2. Albedo from Von der Haar and Suomi (1969), 0.30.
 Energy reflected: $(.30) (5.263 \text{ E}24) = 1.69 \text{ E}24 \text{ J/yr}$
3. Energy absorbed: $(.70) (5.263 \text{ E}24) = 3.93 \text{ E}24 \text{ J/yr}$.
4. Energy absorbed by atmosphere, 23% (Houghton 1954):
 $(.23) (5.623 \text{ E}24) = 1.29 \text{ E}24 \text{ J/yr}$
5. Energy absorbed by ocean (Weyl 1970):
 $(3290-350) \text{ kcal/m}^2/\text{d} (0.71) (5.1 \text{ E}14 \text{ m}^2) (365\text{d})$
 $(4186 \text{ J/kcal}) = 1.62 \text{ E}24 \text{ J/yr}$

Footnotes to Table A1 continued

6. Energy absorbed by land:

$$(3.39 \text{ E24} - 1.29 \text{ E24} - 1.62 \text{ E18}) = 1.02 \text{ E24 J/yr}$$

7. Energy absorbed by ocean and atmosphere

$$1.29 \text{ E24} + 1.62 \text{ E24} = 2.91 \text{ E24 J/yr}$$

APPENDIX A2: SUMMARY OF THE ENERGY OPERATING THE
BIOSPHERE AND CRUST

Deep in the crust, heat is generated that develops high temperatures, that operate geological convection and other geochemical work processes. The heat developed there has three main sources: (a) heat diffusing up from the deeper level of the mantle (radioactive heat generation and residual heat from solar system formation time); (b) radioactive decay within the crust especially of radioactive substances concentrated in sedimentary cycle; and (c) energy transmitted down from the solar driven biosphere as pressure-volume work of sediment transported by hydrologic cycle and in the mix of oxidized and reduced substances stored in the sediments (see Figure A2).

Since solar equivalents can be identified for the fraction coming down from the biosphere, and since the heat at that depth is combined indistinguishably as a deep heat pool driving earth processes, all the heat there can be given the same energy transformation ratio from solar energy absorbed, 6055 SEJ/crustal J (Table A2, Footnote 2). The total energy driving earth crustal processes in solar equivalents is $8.0 \text{ E}24 \text{ SEJ/y}$ (Table A2).

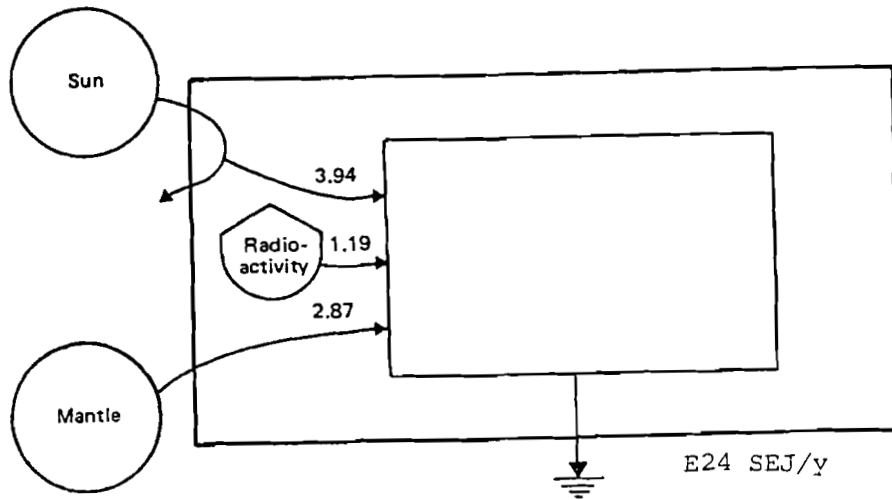

Figure A2. Energy sources of the combined biosphere crustal system expressed in solar equivalents (see Table A2).

Table A2. Energy sources for system of biosphere and crust.

Foot-note	Item	Actual Energy J/yr	Energy Transformation Ratio SEJ/J	Embodied Solar Energy E24 SEJ/yr
1	Solar component to crustal heat	3.93 E24	1	3.93
2	Crustal radioactivity	1.98 E20	6055	1.19
3	Mantle upflow	4.74 E20	6055	2.87
	Total			8.00

Footnotes to Table A2

1. See Appendix 1.
2. Actual energy from Appendix A3.
3. Energy transformation ratio, the ratio of solar energy used in biosphere to actual heat component in crust due to solar input (from Appendix A3)

$$\frac{(3.93 \text{ E24 SEJ/y})}{(6.49 \text{ E20 J/y})} = 6055 \text{ SEJ/crustal J}$$

4. Actual energy from Appendix A3; ETR from Footnote 2.

APPENDIX A3: ENERGY SOURCES TO THE CRUSTAL SYSTEM

Sclater et al. (1980) review available data and provide estimates of heat flows within the crust, from the mantle, and from radioactivity generation within the crust. The component of heat from the solar processes of the biosphere (hydrologic cycle, sedimentary transport, and redox potentials in these sediments) may be calculated by difference. Figure A3 provides the actual energy flows applied to a systems diagram of the coupling of biosphere and crustal system.

These data were the basis for assigning solar equivalents in Appendix A2. Energy transformation ratio between solar energy, $3.93 \text{ E}24 \text{ J/y}$ and the component of earth heat from the sun, $6.49 \text{ E}20 \text{ J/y}$ is 6055 SEJ/crustal J.

Mechanical Energy of Crustal Circulation

Mechanical energy of the earth movements may be calculated as half the product of the total heat flux and the Carnot ratio

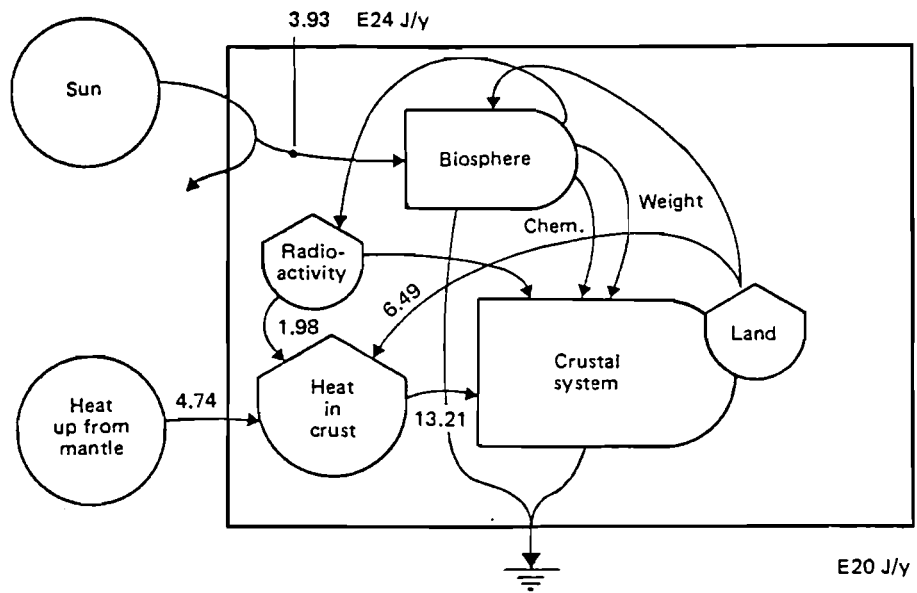

Figure A3. Actual energy driving crustal system.

(Temp.diff./Temp.):

$$(13.21 \text{ E20 J/y}) (.5) (1000^{\circ}\text{C}/1300^{\circ}\text{K}) = 5.08 \text{ E20 Mechanical J/y}$$

Energy transformation ratio for this quality work is the ratio of solar equivalents to mechanical work dispersed over crust.

$$\frac{(8.0 \text{ E24 SEJ/y})}{(5.08 \text{ E20 MEJ/y})} = 17,748 \text{ SEJ/MEJ}$$

Table A3. Actual energy flows driving crustal system, see Figure A3.

Footnote	Item	Actual Energy Flow E20 J/y
1	From mantle into crust	4.744
2	Total heat through crust	13.21
3	Radioactive generation	1.98
4	From solar biosphere	6.49

Footnotes to Table A3

Data on earth heat from Sclater et al. (1980)

1. From mantle into crust, heat flow:

$$(0.6 \text{ E-6 gcal/cm}^2\text{sec}) (3.154 \text{ E7 sec/yr}) (5.14 \text{ E14 m}^2\text{/earth}) \\ (1 \text{ E4 cm}^2\text{/m}^2) (4.186 \text{ J/gcal}) = 4.744 \text{ E20 J/yr}$$

2. From crust including 72.5% from ocean crust and 27.5 from shelves and continent:

$$(1002 \text{ E10 gcal/sec/earth}) (4.186 \text{ J/gcal}) (3.154 \text{ E7 sec/yr}) \\ = 13.21 \text{ E20 J/yr}$$

3. Radioactive contribution given as 15% (within crust):

$$(13.21 \text{ E20 J/yr}) (.15) = 1.98 \text{ E20 J/yr}$$

4. Remainder assumed as heat emitted as generated within the crust from various inputs of solar origin after mantle also subtracted:

$$(13.21 \text{ E20} - 1.98 \text{ E20} - 4.74 \text{ E20}) = 6.49 \text{ E20 J/yr}$$

APPENDIX A4: ENERGY DOLLAR RATIO FOR SERVICE
COMPONENT OF EXPORTS FROM
INDUSTRIALIZED COUNTRIES

When money is paid for exports coming from industrialized countries such as the United States, the energy embodied in the services accumulated in developing the export may be roughly figured from the price using the energy to dollar ratio of the U.S. The energy used by the U.S. may be estimated as the sum of the embodied energy of the fuels used and the embodied energy of the solar-driven renewable energies (see Figure A4). The largest of the solar driven inputs is the embodied energy of the global ocean and atmospheric solar absorption in Gibbs free energy of the rain relative to the salt water of the sea (where rivers reach the sea) and the salt water in transpiring leaves (water potential), here taken as osmotic pressure of sea water.

Fuel use was obtained from Department of Commerce statistics and rainfall by averaging a median point from each state off a map of U.S. rainfall (NOAA 1977). The calculation is illustrated for 1978 in Table A4a. The procedure is repeated for the years 1947-1980 in Table A4b. Gross National Products were from Department of Commerce Statistical Abstracts.

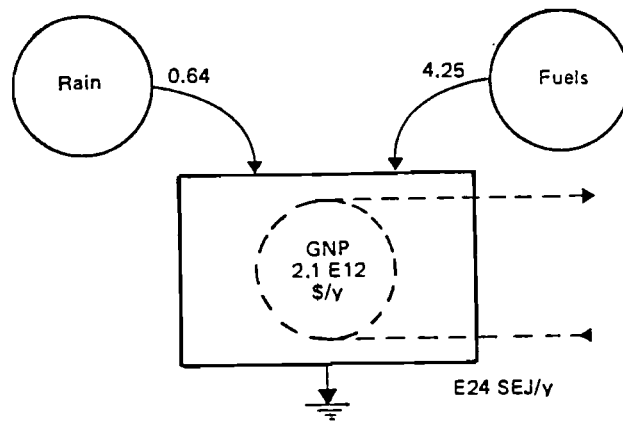

Figure A4. Summary diagram of driving energy sources and the GNP in the U.S.A.

Table A4a. Flows for evaluating U.S. energy/dollar ratio.

Foot-note	Item	Actual Energy J/yr	Energy Transformation Ratio SEJ/J	Embodied Solar Energy SEJ/yr
1	Rainfall	4.17 E19	1.54 E4	0.64
2	Fuels used	8.23 E19	5.3 E4	4.36
	Total			5.0
3	Energy/GNP =	2.31 E12 SEJ/\$		
		5.80 E7 Coal J/\$		

Footnotes to Table A4a

1. Rainfall energy used

Actual energy:

$$\begin{aligned}
 & (\text{Area of USA}) (\text{mean rainfall}) (\text{Gibbs free energy per unit rain}) \\
 & (1 \text{ E-2 m/cm}) (3.623 \text{ E6 sq.miles}) (640 \text{ acres/sq miles}) \\
 & (4.05 \text{ E3 m}^2/\text{acre}) (35.4 \text{ in/yr}) (2.54 \text{ cm/in}) (1 \text{ E6 g/m}^3) \\
 & = (8.44 \text{ E19 g/yr}) (4.94 \text{ J/g}) = 4.17 \text{ E19 J/yr}
 \end{aligned}$$

2. Fossil fuel use in USA in 1978

$$(19.66 \text{ E15 kcal/yr}) (4186 \text{ J/kcal}) = 8.23 \text{ E19 J/yr}$$

$$3. \text{ Energy/\$} = \frac{(489 \text{ E24 SEJ/yr})}{(2.108 \text{ E12 \$/yr})} = 2.31 \text{ E12 SEJ/\$}$$

$$\frac{(2.31 \text{ E12 SEJ/\$})}{(3.98 \text{ E4 SEJ/coalJ})} = 5.8 \text{ E7 coal J/\$}$$

Table A4b. Ratio of embodied energy to GNP for the USA.

Year	F Fossil fuel use E19 J/y	E Solar equiv. of fossil fuel use E24 SEJ/y	S Total embodied energy use E24 SEJ/y	GNP E9 \$/y	R Energy to dollar ratio E12 SEJ/\$
1947	3.47	1.84	2.48	231.3	10.7
1948	3.59	1.90	2.54	257.6	9.86
1949	3.33	1.76	2.41	256.5	9.35
1950	3.60	1.91	2.55	284.8	8.95
1951	3.89	2.06	2.70	328.4	8.22
1952	3.86	2.04	2.68	345.5	7.75
1953	3.97	2.11	2.75	364.6	7.54
1954	3.83	2.03	2.67	364.8	7.32
1955	4.22	2.23	2.87	398.0	7.21
1956	4.43	2.35	2.99	419.2	7.13
1957	4.42	2.34	2.98	441.1	6.76
1958	4.38	2.32	2.96	447.3	6.62
1959	4.58	2.43	3.07	483.7	6.35
1960	4.74	2.51	3.15	503.7	6.25
1961	4.82	2.56	3.20	520.1	6.15
1962	5.04	2.67	3.32	560.3	5.92
1963	5.24	2.78	3.42	590.5	5.79
1964	5.43	2.88	3.52	632.4	5.57
1965	5.69	3.02	3.66	684.9	5.34
1966	6.03	3.20	3.84	749.9	5.12
1967	6.14	3.26	3.89	793.9	4.89
1968	6.51	3.45	4.09	864.2	4.73
1969	6.85	3.63	4.27	930.3	4.58
1970	7.09	3.76	4.40	976.4	4.51

Table A4b continued

Year	F Fossil fuel use E19 J/y	E Solar equiv. of fossil fuel use E24 SEJ/y	S Total embodied energy use E24 SEJ/y	GNP E9 \$/y	R Energy to dollar ratio E12 SEJ/\$
1971	7.25	3.84	4.48	1050.4	4.27
1972	7.61	4.03	4.67	1151.8	4.05
1973	7.87	4.17	4.81	1306.6	3.68
1974	7.55	4.00	4.64	1412.9	3.28
1975	7.45	3.95	4.59	1328.8	3.45
1976	7.83	4.15	4.79	1700.1	2.82
1977	8.07	4.28	4.92	1887.2	2.60
1978	8.23	4.36	5.00	2107.6	2.37
1979	7.24	3.84	4.48	2417.8	1.85
1980	6.94	3.68	4.32	2633.1	1.64

Footnotes to Table A4b.

F Fossil fuel use from Department of Commerce (1982).

E Solar equivalents assigned with energy transformation ratio for oil from Table 3.1, 5.3 E4 SEJ/J oil .

S Total embodied energy was obtained by adding solar equivalents of oil from Column E to solar equivalents of rain, $.64 \text{ E24 SEJ/y}$ from Table A4a.

GNP Gross National Product from Department of Commerce Statistical Abstract (1982).

R Embodied Energy to Dollar Ratio for each year was calculated as the ratio of column S to GNP for that year.

Following work by Mark Brown an average energy to dollar ratio was calculated as the ratio of world energy flux (8.0 E24 SEJ/y), Appendix A2, renewable plus 10.8 E24 SEJ/y world fuel use) to world economic product ($\$5 \text{ E12/y U.S. 1979 } \$$).

$$(18.8 \text{ SEJ/y}) / (\$ 9 \text{ E12/y}) = 3.8 \text{ E12 SEJ/}\$$$

APPENDIX A5: SOLAR EQUIVALENTS OF INDUSTRIAL FUEL
HEAT SOURCES USING WOOD POWER PLANT
AT JARI, BRAZIL

Conversion of solar energy to boiler fuel and electricity was calculated from real power plant operations at Jari, Brazil, using performance figures supplied by the plant manager. Embodied energy in rainfall estimated used in rainforest growth was the main indirect solar energy contribution. A transformation ratio was calculated after subtracting feedbacks of fuels and services. Assuming 100 years as a growth period for the quantity and quality of wood being processed, a steady state diagram was evaluated as given in Figure A5b.

Appendix A5 Part 2, with Figure A5b, shows there is a moderate net energy and light loading of environment when land is operated on a 100 year rotation.

Appendix A5 Part 3 uses the conversion of solar energy to net electricity of the wood power plant to estimate other energy transformation ratios involving fuels and sunlight.

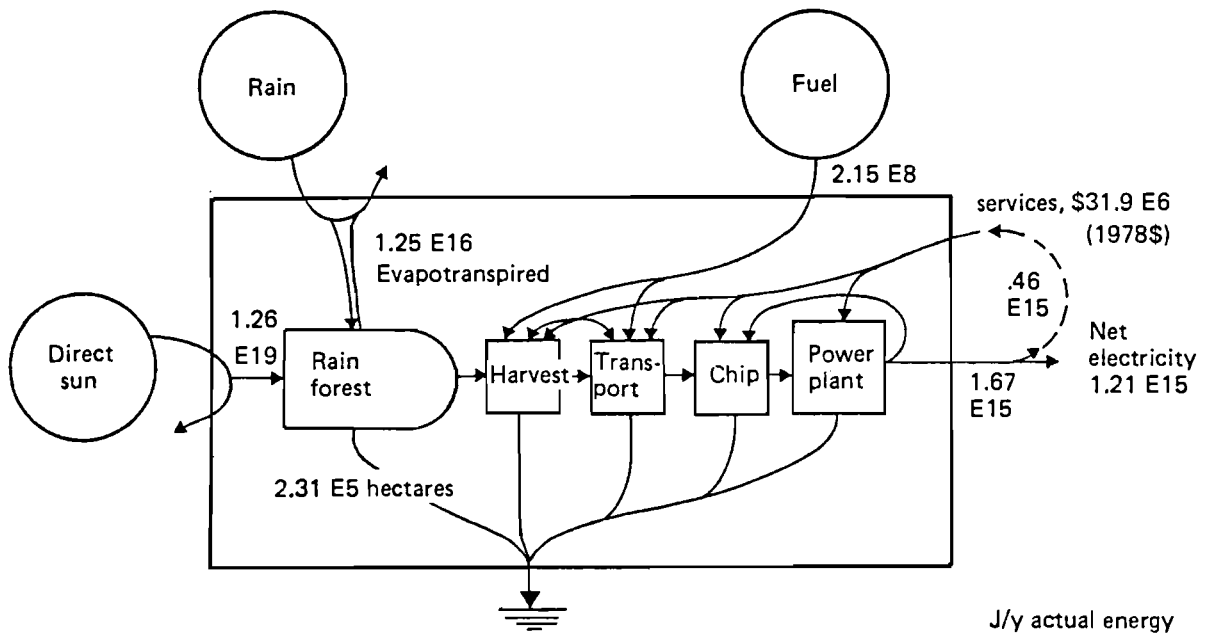

(a)

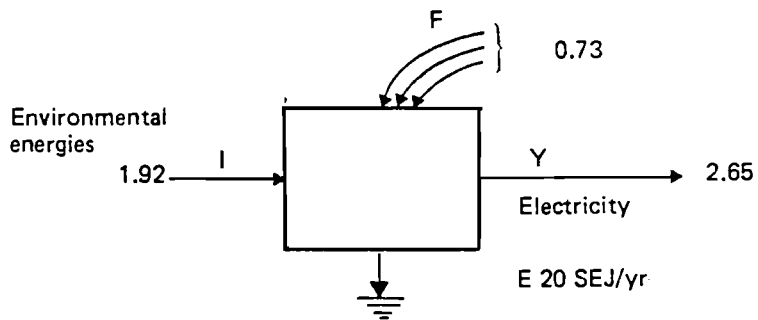

(b)

Figure A5. Energy diagrams of the power plant in Jaril, Brazil. (a) complex, (b) summary.

Table A5. Energy power plant at Jari, Brazil, see Figure A5, calculated as steady state requiring 2.31 E5 Ha.

Foot-note	Item	Actual Energy J/y	ETR SEJ/J	Embodied Solar Energy E20 SEJ/y
1	Direct sun	1.26 E19	1	0.126
2	Rainforest evapotranspiration	1.25 E16	1.54 E4	1.925
3	Rainforest wood burned	5.92 E15	3.49 E4	2.06
4	Fuel used in harvest	1.8 E14	5.17 E4	0.093
5	Services used in harvest	1.58 E14	5.17 E4	0.082
6	Electricity, debarking chipping	5.93 E13	5.17 E4	0.032
7	Electricity generated	1.67 E15	1.59 E5	2.66
8	Feedbacks to power plant	0.46 E15	1.59 E5	0.67
9	Net electrical output	1.21 E15	1.59 E5	1.92

Footnotes to Table A5.

1. Direct sunlight assumed

$$(1.29 \text{ E6 kcal/m}^2/\text{yr}) (4186 \text{ J/kcal}) (2.31 \text{ E9 m}^2) = 1.257 \text{ E19 J/yr}$$

2. Rainforest water used as evapotranspiration and Gibbs free energy relative to leaf salt (Footnote 6, Table 3.1, 4.94 J/g)

$$(3 \text{ mm/d}) (365 \text{ d/y}) (1 \text{ E-3 m/mm}) (1 \text{ m}^2) (1 \text{ E6 g/m}^2) (4.94 \text{ J/g})$$

$$(2.3 \text{ E9 m}^2) = 1.25 \text{ E16 J water/y}$$

3. Rainforest wood burned in power plant

6.05 E5 T/y wood used from 2314 Ha; 9.86 E9 J/T; to supply in steady state, 100 times this area is required, 2.314 E9 m²

$$(6.05 \text{ E5 T/y}) (9.86 \text{ E9 J/T}) = 5.92 \text{ E15 J/y}$$

Footnotes to Table A5 continued

4. Fuel used in harvest

Data from similar machine harvests of podocarp virgin forest in New Zealand: liquid fuel, logging 52 E6 J/m³ wood; loading: 33 E6 J/m³ wood; transport: 130 E6 J/m³ wood.

$$(215 \text{ E6 J/m}^3 \text{ wood}) (261.5 \text{ m}^3 \text{ wood/Ha}) (2,314 \text{ Ha/y}) \\ = 1.8 \text{ E14 J/y}$$

5. Services used in harvest

\$300/Ha in similar harvest in New Zealand, 1978.

$$(\$300/\text{Ha}) (2.28 \text{ E8 fuel J/\$}) (2314 \text{ Ha/y}) = 1/58 \text{ E14 fuel J/y}$$

6. Electricity used in debarking and chipping

Equivalent data used from New Zealand, 98 E6 fuel J/m³ wood

$$(98 \text{ E6 fuel J/m}^3) (261.5 \text{ m}^3/\text{Ha}) (2314 \text{ Ha/y}) = 5.93 \text{ E13 fuel J/y}$$

7. Electricity generated

53 megawatts

$$(53 \text{ E6 watts}) (1 \text{ J/sec/watt}) (3.154 \text{ E7 sec/y}) \\ = 1.67 \text{ E15 electric J/y}$$

8. Feedbacks of fuels and embodied energy of service from economy to power plant maintenance and operation assume 1/4 of electric output, Footnote 7.

$$(1.67 \text{ E15 Elec. J/y}) (.25) = 0.42 \text{ E15 electric J/y}$$

9. Net electrical output

Electricity minus feedbacks in Footnotes 4-7

$$(1.67 - .46) \text{ E15 J/y} = 1.21 \text{ E15 Elect J/y}$$

APPENDIX A5 PART 2: RATIOS FOR WOOD POWER PLANT AT JARI

Using the aggregated embodied energies for the wood power plant as diagrammed in Figure A5b, useful rates were calculated.

Table A5b. Ratios characterizing wood power plant at Jari, Brazil.

Foot-note	Name	Expression (Figure A5b)	Ratio
1	Net energy yield ratio	Y/F	2.63
2	Energy investment ratio	F/I	0.38

Footnotes for Table A5b

1. Quotient of Y and F both in solar equivalents

$$Y = \text{net electrical output from Table A5a in solar equivalents} \\ = (1.21 \text{ E15 elec J}) (1.59 \text{ E5 SEJ/elec J}) = 1.92 \text{ E20 SEJ/y}$$

$$F = \text{feedbacks from economy as fuel and services (see Table A5a)} \\ = (0.46 \text{ E15 elec J}) (1.59 \text{ E5 SEJ/elec J}) = 7.31 \text{ E19 SEJ/y}$$

2. Quotient of F (above) and I

$$I = \text{embodied solar energy in rain evapotranspired (Table A5a)} \\ = 1.925 \text{ SEJ/y}$$

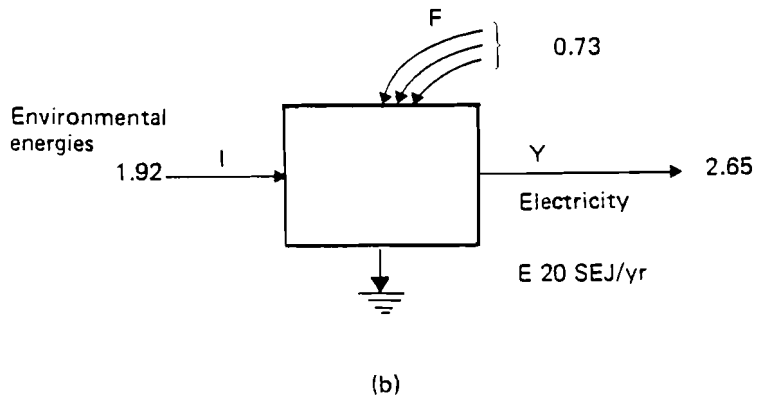
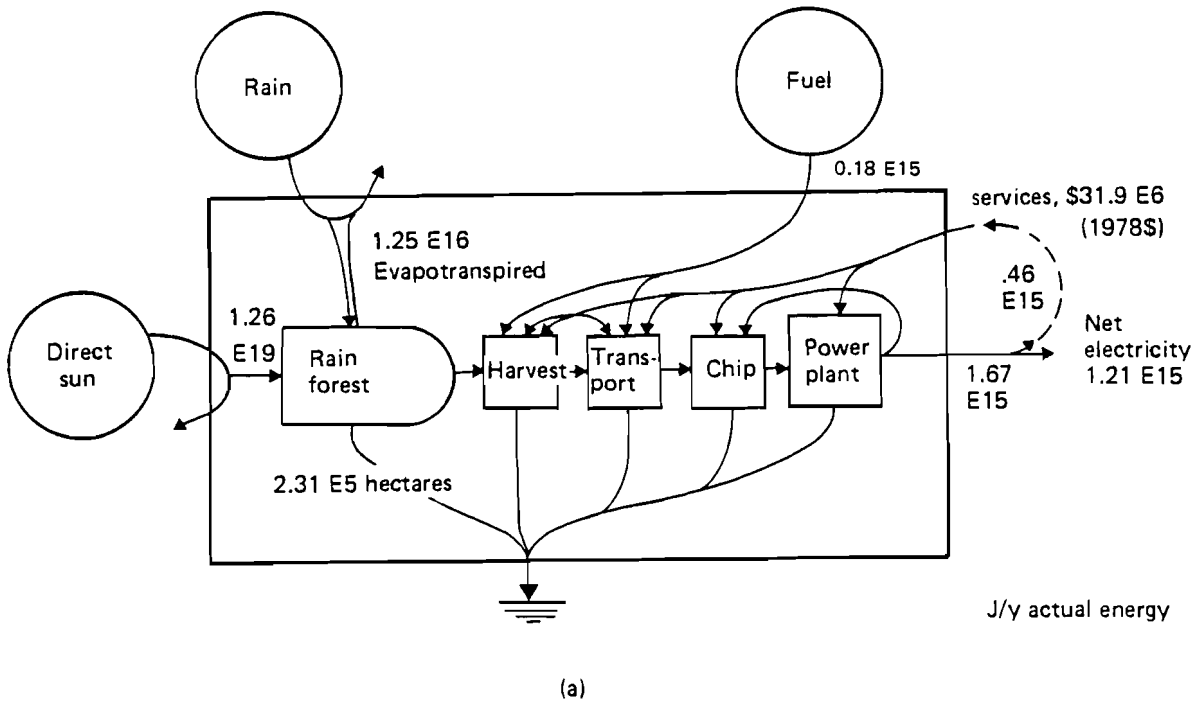

Figure A5. Energy system of the wood power plant at Jari, Brazil. (a) actual energy per year calculated as a steady state; (b) embodied solar equivalents. See Table A5.

APPENDIX A5 PART 3: ENERGY TRANSFORMATION RATIOS OF
FUELS

The conversion of solar energy to electricity in the wood power plant at Jari allows solar energy equivalents to be calculated for wood, electricity, and secondarily for coal, oil, natural gas, and liquid fuels by multiplying and dividing by other energy transformation ratios.

Table A5c.

Foot-note	Item	ETR
1	Solar equivalents of rainforest wood still standing in the forest	3.23 E4 SEJ/J wood
2	Solar equivalents of rainforest wood transported and chipped for burning	3.49 E4 SEJ/J chips
3	Solar equivalents of net electricity	1.59 E5 SEJ/J elect
4	Rainforest wood equivalents of net electricity	4.56 wood J/J elect
5	Solar equivalents of coal	3.98 E4 SEJ/J coal
6	Coal equivalents of motor fuel	1.65 coal J/M fuel J
7	Crude oil equivalent of motor fuel	1.23 oil J/M fuel J
8	Coal equivalents of crude oil	1.34 coal J/J oil
9	Solar equivalents of crude oil	5.33 E4 SEJ/J oil
10	Coal equivalents of natural gas	1.2 coal J/gas J
11	Solar equivalents of natural gas	4.78 E4 SEJ/gas J
12	Solar equivalents of liquid motor fuel	6.6 E4 SEJ/M fuel J

Footnotes to Table A5c

1. ETR for solar equivalents of standing rainforest wood.
Actual energy:

$$\frac{(2.615 \text{ E2 m}^3 \text{ wood/Ha/100 yrs}) (9.86 \text{ E9 J/m}^3 \text{ wood})}{(1 \text{ E4 m}^2/\text{Ha})}$$

$$= 2.57 \text{ E8 J/m}^2/100 \text{ yr}$$

embodied solar energy from evapotranspiration:

$$(3 \text{ mm/d}) (365 \text{ d/y}) (100 \text{ y}) (1000 \text{ g/m}^2/\text{mm}) (4.94 \text{ J/g})$$

$$(1.54 \text{ E4 SEJ/J}) = 8.3 \text{ E12 SEJ/m}^2/100 \text{ y}$$

Footnotes to Table A5c continued

ETR:

$$\frac{8.3 \text{ E12 SEJ/m}^2/100 \text{ yr}}{2.58 \text{ E6 J/m}^2/100 \text{ y}} = 3.23 \text{ E4 SEJ/J standing wood}$$

2. ETR for rainforest wood transported and chipped for burning

$$\frac{(1.59 \text{ E5 SEJ/elect J from Table 3.1})}{(4.56 \text{ wood J/elect J from Footnote 4})} = 3.49 \text{ E4 SEJ/J}$$

3. Solar equivalents of net electricity, flows in Table A5a

$$\frac{(1.25 \text{ E16 J evapotrans/y}) (1.54 \text{ E4 SEJ/J water})}{(1.21 \text{ E15 J/y electric.})}$$

$$= 1.59 \text{ E5 SEJ/Elec J}$$

4. Rainforest wood equivalents of net electricity, flows in Table A5a

$$\frac{(5.517 \text{ E15 wood J used})}{(1.21 \text{ E15 elect J/y})} = 4.56 \text{ rainforest wood J/elect J}$$

5. Solar equivalent of coal

$$(1.59 \text{ E5 SEJ/elec J}) (0.25 \text{ elect J/coal J})$$

$$= 3.98 \text{ E4 SEJ/coal J}$$

6. Coal equivalent of liquid fuel, estimated from conversion process from Slesser (1976): 1.65 coal J/liquid fuel J

7. Crude oil equivalent of liquid motor fuel from Cook (1976); 19% used in transport and refining

$$0.81 \text{ liquid fuel J/J crude oil}$$

$$1.23 \text{ J crude oil/J liquid fuel oil (reciprocal)}$$

8. Coal equivalent of crude oil

$$(1.65 \text{ coal J/J liquid fuel}) (0.81 \text{ J liquid fuel/J crude oil})$$

$$= 1.34 \text{ coal J/crude oil J}$$

Footnotes to Table A5c continued

9. Solar equivalents of crude oil

$$(1.34 \text{ coal J/oil J}) (3.98 \text{ E4 SEJ/coal J}) = 5.33 \text{ E4 SEJ/oil J}$$

10. Coal equivalents of natural gas

Natural gas 20% more efficient in boilers than coal (Cook 1976)

$$1.2 \text{ coal J/gas J}$$

11. Solar equivalents of natural gas

$$(1.2 \text{ coal J/gas J}) (3.98 \text{ E4 SEJ/coal J}) = 4.78 \text{ E4 SEJ/gas J}$$

12. Solar equivalents of liquid motor fuel

$$(1.65 \text{ coal J/liquid J}) (3.98 \text{ E4 SEJ/coal J})$$

$$= 6.6 \text{ E4 SEJ/liquid J}$$

APPENDIX 6: PHOSPHATE DEPOSITS OF FLORIDA

Data on water percolation from runoff into swamps and then dissolving and reprecipitating phosphorus over long geological periods was used to estimate embodied energy in phosphate rock. Additional energies become embodied in mining, processing and transport of phosphate fertilizer. See diagram of phosphate system in Figure A6. Many data on chemistry of water percolation in Florida perched cypress swamps were given in geochemical studies (Ewel and Odum, eds. 1983). Rates of phosphorus concentration were found consistent with geological data with modeling and simulation (Gilliland 1973, 1976).

With about 10% of the tableland landscape in swamps, calculations were made of energy embodied in photosynthesis of 10 m^2 being converged in organic matter in runoff to 1 m^2 of swamp, percolating through limestones under the swamp with molar conversion of organic carbon generating acid equivalents of carbon dioxide removing equivalents of calcium carbonate, leaving phosphate concentrated.

Calculations were made of the percolation required to concentrate a cubic meter of limestone marl to 1/10 its volume and a 10 fold increase in phosphorus concentration. Time for this was estimated to be 3,949 years.

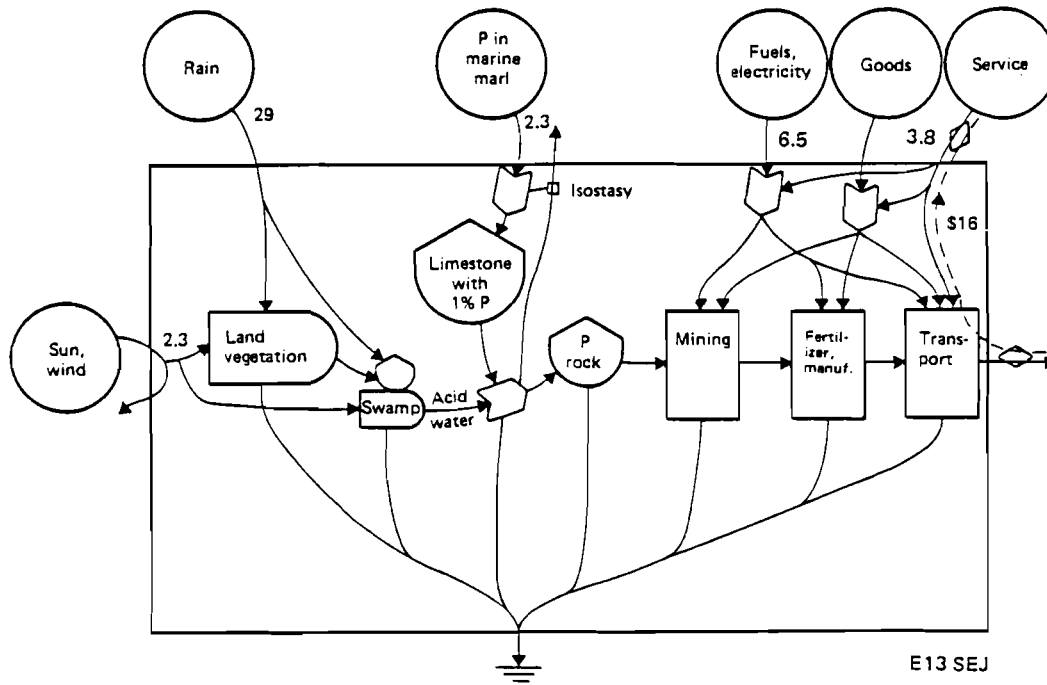

Figure A6. Energy diagram of phosphate system.

Table A6. Energy flows in phosphate formation and mining system for 200 kg 10% P rock developed by work from 10 m² land*.

Foot-note	Item	Actual Energy J	Energy Transformation Ratio SEJ/J	Embodied Solar Energy E12 SEJ/y
1	Direct sun, 10 m ² of land	2.31 E14	1	23.1
2	Direct sun, 10 ² m of estuary	2.31 E14	1	23.1
3	Indirect sun in rain converged to swamp	1,87 E10	1.54 E4	288
4	Gibbs free energy in phosphate	6.96 E6	4.14 E7	288
5	Service in mining, transport, \$16	—	2.3 E12 J/\$	38.
6	Fuel in mining, transport	9.78 E8	6.6 E4	65.

Footnotes to Table A6

*Time for development of phosphate deposit estimated from rate of percolation through Florida swamp. 10% of rain over 10 m² runs into swamp area of 1 m². 2.5 cm/week (130 cm/y) percolated down carrying 100 mg/l organic matter that oxidizes generating acid as it percolates dissolving limestone.

$$\frac{(1.3 \text{ m}^3/\text{m}^2/\text{y}) (100 \text{ g org}/\text{m}^3) (72/180 \text{ g carbon}/\text{g org})}{(12 \text{ g C}/\text{mole})}$$

$$= 4.33 \text{ mole}/\text{m}^2/\text{y}$$

To dissolve 90% of limestone of density 1.9 at 4.33 moles/m²/y:

$$\frac{(1 \text{ E6 cm}^3/\text{m}^3) (1.9 \text{ g}/\text{cm}^3) (.9)}{(100 \text{ g}/\text{mole CaCO}_3)} = 1.71 \text{ E4 moles CaCO}_3$$

$$\frac{(1.71 \text{ E4 moles CaCO}_3/\text{m}^3 \text{ rock})}{(4.33 \text{ moles acid}/\text{m}^3/\text{y})} = 3949 \text{ years}$$

$$1. \text{ Direct sun on } 10\text{m}^2 \text{ area from which waters converge to } 1 \text{ m}^2 \\ (10\text{m}^2) (1.4 \text{ E6 kcal}/\text{m}^2/\text{y}) (4186 \text{ J}/\text{kcal}) (3949 \text{ y}) \\ = 2.31 \text{ E13 SEJ}/10 \text{ m}^2$$

Footnotes to Table A6 continued

2. Direct solar energy on estuary operating ecosystem accumulating marl from shells one m³ in volume per 10 m². Same as in Footnote 1, 2.31 E14 SEJ/10 m².

3. Indirect solar energy in 10% rainwater converging to swamp and operating its vegetation during leaching period

$$(1.08 \text{ m/y rain used}) (10 \text{ m}^2) (1 \text{ E6 g/m}^3) (4.4 \text{ J/g})(0.10)$$

$$= 4.75 \text{ E6 J/y}$$

$$(4.75 \text{ E6 J/y}) (3949 \text{ y}) = 1.87 \text{ E10 rain water J/10 m}^2$$

4. Gibbs free energy in the phosphorus concentration relative to prevailing solutions from which phosphorus was first concentrated by shellfish system to 1% and further by swamp solution to 10%. Solution equilibrium with solid phosphate taken as 1 ppm.

$$\text{Free energy per gram} = \frac{(8.33 \text{ J/mole/deg}) (300^0)}{(33 \text{ g/mole})} \text{Log}_e \frac{(1.0)}{(.01)}$$

$$= 348 \text{ J/g}$$

Phosphorus content concentrated initially 1%, density 2g/cm³

$$(.01) (1 \text{ E6 cm}^3/\text{m}^3) (2\text{g/cm}^3) (348 \text{ J/g}) = 6.96 \text{ E6 J/10 m}^2$$

Energy transformation ratio using solar equivalents of rain used:

$$\frac{288 \text{ E12 SEJ})}{(6.96 \text{ E6 J phosphate})} = 4.14 \text{ E7 SEJ/J phosphate}$$

$$\text{Per gram: } \frac{288 \text{ E12 SEJ}}{2 \text{ E4 gP}} = 1.44 \text{ E10 SEJ/g}$$

5. Energy embodied in services of super phosphate from \$/energy ratio and 1978 prices in U.S. (FAO 1979)

$$(10\% \text{ of } 200 \text{ kg}) (146/66 \text{ P}_2\text{O}_5) = 44.2 \text{ kg P}_2\text{O}_5$$

$$(\$362/\text{T super phosphate P}_2\text{O}_5) (44.2 \text{ kg P}_2\text{O}_5) (1 \text{ E-3 T/kg})$$

$$= \$16.$$

$$2.37 \text{ E12 SEJ/\$ in U.S. 1978}$$

Footnotes to Table A6 continued

6. Fuel used in mining and processing super phosphate
22.1 E6 fuel J/kg P₂O₅ (Fluck and Baird 1980, quoting
Shaft 1975); P₂O₅ is 146/66 of P

$$(22.1 \text{ E6 fuel J/kg P}_2\text{O}_5) (200 \text{ kg}) (0.1 \text{ P}) (146/66)$$

$$= 9.78 \text{ E8 fuel J/y}$$

ETR for superphosphate (H₃P₀₄); 33% of superphosphate is P.

$$\frac{(28.8 + 3.8 + 6.5) \text{ E13 SEJ}}{6.96 \text{ E6 J}} = 5.62 \text{ E7 SEJ/J}$$

Per gram P in superphosphate

$$\frac{39.1 \text{ E13 SEJ}}{2 \text{ E4 g P}} = 2.0 \text{ E10 SEJ/g P in H}_3\text{P}_0_4$$

APPENDIX A7: MINERALS AS A FRACTION OF THE EARTH
CYCLE

Rocks forming on land may be visualized as the product of coupled sources converging from energy driving crust and deep earth together to build the land followed by parallel allocations of the land process to various mineral processes in proportion to their fraction of the continental cycle. See Figure A7.

Total earth cycle of the land used was 2.4 cm/1000 years which is $9.36 \text{ E}15 \text{ G/y}$ (based on density 2.61 g/cm^3 and $1.5 \text{ E}14 \text{ m}^2$ area). That this procedure generates for coal a similar ratio to that from analysis of a real wood power plant (Appendix A5), gives some creditability for this way of aggregating processes for those types of rock that form by general consolidation, pressure, percolation, heat, etc., of sediments over large areas. This procedure assigns earth heat to land matter on an equal energy per gram basis ($8.5 \text{ E}8 \text{ SEJ/g}$ in Table A7).

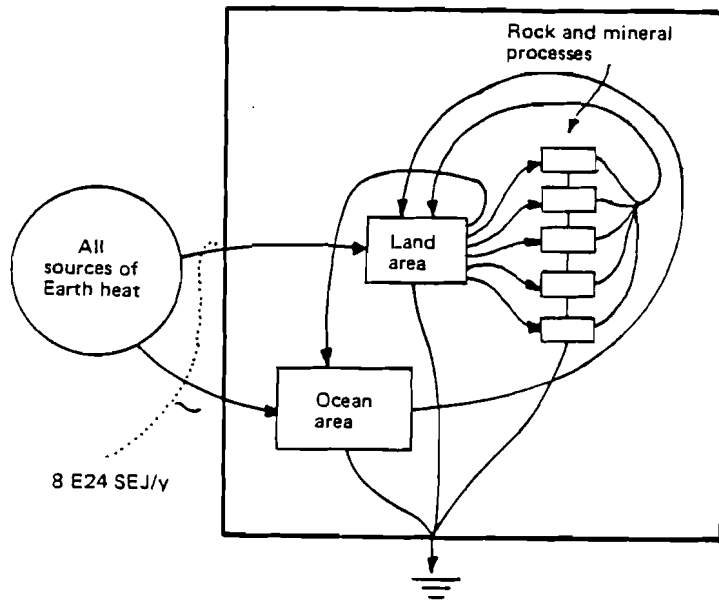

$$\text{ETR} = \frac{(\text{Mineral's fraction of total land uplift}) (8 \text{ E}24 \text{ SEJ/y})}{(\text{Annual Gibbs Free energy uplift of the mineral})}$$

Figure A7. Diagram of concept used to evaluate embodied energy of rocks and minerals. Undersea energy assumed necessary to land process, but each rock and mineral process parallel and not necessary to each other.

Table A7. Energy transformation ratios for rocks and minerals.

	Iron ore	Coal	Bauxite
A Reserve, T	2.035 E12	7.64 E12	3,519 E12
B Fraction of rock	5.18 E-6	1.96 E-5	8.95 E-6
C Flux, g/y	4.85 E10	1,84 E11	8.83 E10
D Gibbs energy, J/g	14.2	29302	65.3
E Energy flux J/y	6.9 E11	5,39 E15	5.42 E12
F Embodied energy SEJ/y	4.14 E19	1.56 E20	7.16 E19
G ETR, SEJ/J	6,0 E7	2.9 E4	1.32 E7
H SEJ/g	8.5 E8	8.5 E8	8.5 E8

Footnotes to Table A7

A Estimated reserves available for mining in upper kilometer,

B Fraction that item in row A is of total rock in upper kilometer of land:

$$(1.5 \text{ E14 m}^2 \text{ land}) (1 \text{ E3 m}^3 / \text{km}) (2.62 \text{ T/m}^3 \text{ density}) = 3.93 \text{ E17 T}$$

C Fraction in row B times world rock uplift flux, which was calculated:

$$(2.4 \text{ cm/1000 y}) (1.3 \text{ E14 m}^2 \text{ land}) (1 \text{ E4 cm}^2 / \text{m}^2) (2.62 \text{ g/cm}^3) \\ = 9.36 \text{ E15 g/y}$$

D Gibbs free energy from Gilliland et al. (1983).

E Flux of Gibbs free energy in the mineral formation per year was the product of mass flux in row C and Gibbs free energy per gram in row D.

F Embodied energy allocated to the particular mineral was calculated as the fraction of land rock from row B times world embodied energy of earth processes, 8.0 E24 SEJ/y (Appendix 3).

G Energy transformation ratio is ratio of embodied energy in row F to that for actual energy in row E.

H Embodied energy per gram calculated by multiplying ETR in row G by unit energy content in row D.

Since there are further processes of differentiation and energy convergence for many minerals as part of the hierarchy of geological processes, an additional factor needs to be multiplied in appropriate cases representing the ratio of additional concentration. For example, metamorphic minerals generated at a contact zone of energy release representing the convergence of pressures and materials from a ten times larger area would have ten times larger embodied energy of earth heat assigned.

Ultimately, to do minerals and rocks accurately will require an accurate "food chain" network diagram for the minerals, the same kind of network energy diagram for the earth that has been generated for most ecosystems in the last decade or so. Such data generally exist in geological literature already and opportunities for biogeochemical synthesis which includes "trophic aggregation" and accurate energy transformation ratios for rarer rocks and minerals are quite exciting.

APPENDIX A8: EARTH CYCLE AND UPLIFT

Energy flows that are driving the earth cycle and uplift of land to form continental structure and mountains are evaluated in two parts: net uplift and earth cycle in steady state.

Part I is the energy of work against gravity (geopotential energy) in generating new uplift that did not exist before. This is called net uplift. The total continental mass above sea level is considered as generated in the age of the earth as 5 billion years. Because of the square of height involved in this calculation it is very sensitive to rate of elevation. This energy can be calculated when there are data on net rate of uplift or subsidence (negative). See Figure A8a and item number 1 in Table A8. For storages of elevated land available to an economy, a depth of 10 meters was used as readily accessible and this layer of rock constitutes the geopotential driving landslides, etc.

For most of the earth cycle, the land is not being uplifted in net elevation, but is being rotated up by isostatic adjustment

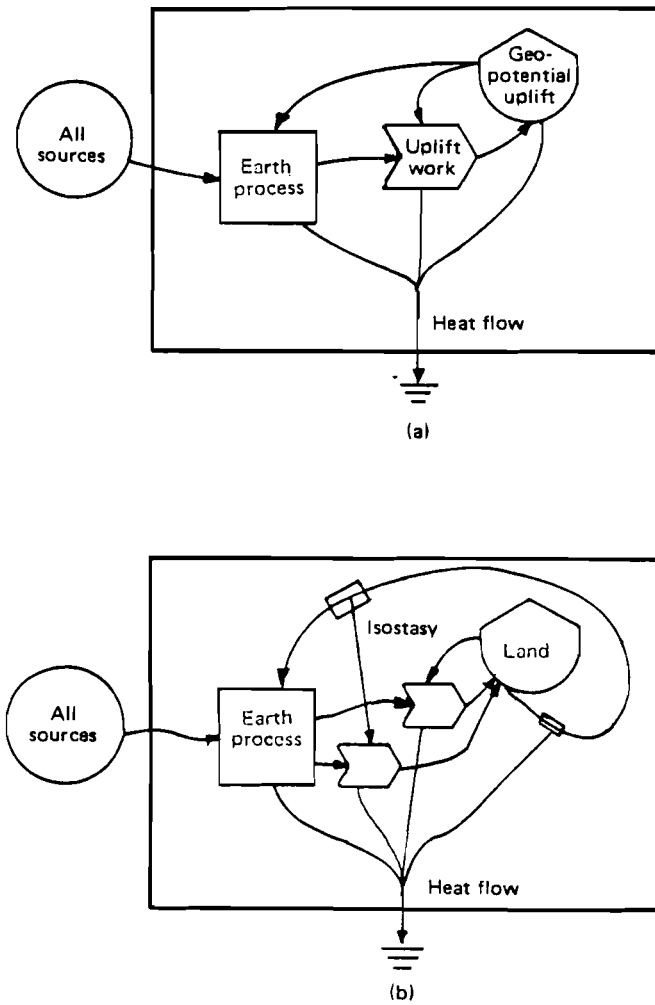

Figure A8. Energy diagrams of geological uplift. (a) net uplift; (b) earth cycle.

Table A8. Earth cycle and uplift.

Foot-note	Item	Actual energy J/y	ETR SEJ/J	Solar Energy Equivalents E24 SEJ/y
1	Net uplift of earth	2.93 E14	2.73 E10	8.0
2	Deep heat flow from continental earthcycle	2,746 E20	2.90 E4	8.0
3	Hydrological work in river transport part of earth cycle	3.39 E20	2.36 E4	8.0

Footnotes to Table A8.

1. Uplift in 1 billion years; mean elevation of continents 875 m; continental area, $1.5 \text{ E}15 \text{ m}^2$; density $2.6 \text{ E}3 \text{ ky/m}^3$
- $$\frac{(875\text{m}) (1.5 \text{ E}14 \text{ m}^2) (2.6 \text{ E}3 \text{ kg/m}^3) (9.8 \text{ m/sec}^2) (0.5 \times 875\text{m})}{5 \text{ E}18 \text{ y}}$$

$$= 2.93 \text{ E}14 \text{ J/y}$$

$$\text{ETR} = \frac{8 \text{ E}24 \text{ SEJ/y}}{1.46 \text{ E}6 \text{ geopotential J/y}} = 5.5 \text{ E}18$$

2. Earth cycle in steady state (not net uplift) continental heat flows from Sclater et al. (1980), $2.746 \text{ E}20 \text{ J/y}$.

$$\frac{8.0 \text{ E}24 \text{ SEJ/y}}{2.746 \text{ E}20 \text{ J/y}} = 2.90 \text{ E}4 \text{ SEJ/J}$$

3. Hydrological work in river transport of world sedimentary cycle ($9.63 \text{ E}15 \text{ g/y}$ from Appendix 7) by $39.6 \text{ E}12 \text{ m}^3/\text{y}$ from 875 m average elevation

$$(39.6 \text{ E}12 \text{ m}^3/\text{y}) (1 \text{ E}3 \text{ kg/m}^3) (9.8 \text{ m/sec}^2) (875\text{m})$$

$$= 3.39 \text{ E}20 \text{ J/y}$$

$$\text{ETR: } \frac{8.0 \text{ E}24 \text{ SEJ/y}}{3.39 \text{ E}20 \text{ J/y}} = 2.36 \text{ E}4 \text{ SEJ/transport J}$$

Actual energy per gram:

$$\frac{3.39 \text{ E}20 \text{ J/y}}{9.63 \text{ E}15 \text{ g/y}} = 3.526 \text{ E}4 \text{ J/g}$$

$$\text{ETR per gram: } \frac{8.0 \text{ E}24 \text{ SEJ/y}}{9.63 \text{ E}15 \text{ g/y}} = 1.21 \text{ E}9 \text{ J/g}$$

as erosion and solution remove land from the surface. This is not a storage of geopotential energy any more than turning a ferris wheel is work against gravity. There is only the energy of work of circulation and transport which ends up as friction and other dispersions emerging from the earth as heat flow. See Figure A8b and item 2 in Table A8. Therefore to evaluate the embodied energy in the earth cycle, the heat flow is used and related to the world embodied energy driving the world cycle. Data from Sclater et al (1980) are helpful in distinguishing between the heat flow of recent and rapid earth cycling and that in old, stable, little circulating areas. Much more refinement is needed in getting appropriate calculations for various local areas.

Whereas heat emerging from below is an indicator of the work of circulation being done by deeper processes, the work of transporting sediments at the surface of the earth in rivers and coastal currents can be estimated by the potential energy of hydrostatic water head dispersed in the process of a steady flow that carries a sediment load. See item 3 in Table A8.

APPENDIX A9a: LOW ENERGY CORN

Data on Mexican corn cultivated with hand labor were given by Pimentel (1979). Using evaluations in Table A9a and Figure A9a, energy transformation ratios are estimated for corn and primitive agricultural labor.

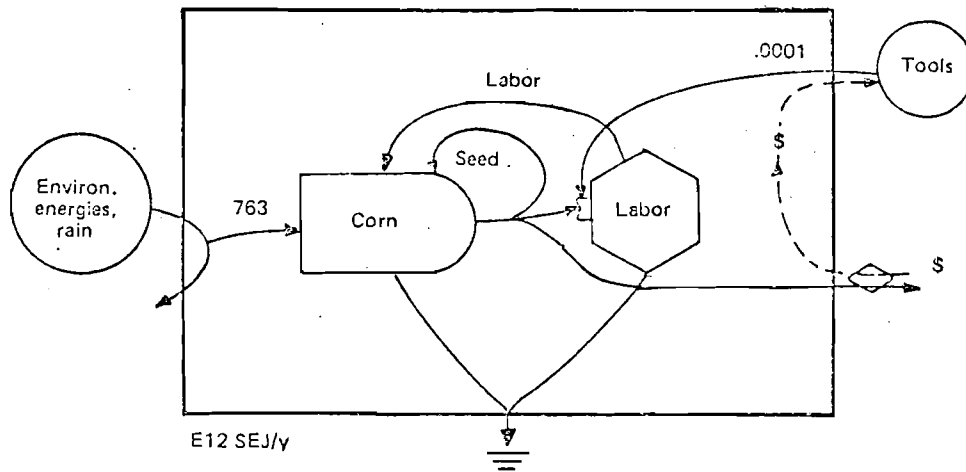

Figure A9. Energy diagram of primitive Mexican corn cultivation.

Table A9a. Energy flows in Mexican corn with hand labor for 1 hectare.

Foot-note	Item	Actual Energy J/y	ETR SEJ/J	Solar Energy Equivalents E12 SEJ/y
1	Rain	4.94 E10	1.54 E4	760.
2	Tools (coal equiv.)	7.0 E7	4 E4	3.
3	Labor	5.0 E8	1.52 E6	763.
4	Seeds	3.66 E4	-	763.
5	Corn yield	2.86 E10	2.67 E10	763.

Footnotes for Table A9

1. Rain representing biosphere components

$$(1 \text{ E4 m}^2/\text{ha}) (1 \text{ m}^3/\text{m}^2) (1 \text{ E6 g/m}^3) (4.94 \text{ J/g}) = 4.94 \text{ E10 J/ha/y}$$

See footnote 6, Table 3-1

2. Tools Pimentel quotes Berry and Fels (1973) 20,172 kcal/kg tools in coal equivalents; tools last 5 y; 4 kg tools used.

$$(20,172 \text{ kcal coal/kg}) (4186 \text{ J/kcal}) (4 \text{ kg/ha/5 y}) = 7.0 \text{ E7 CEJ/y}$$

3. Labor

$$(1144 \text{ hr/y/ha}) (2500 \text{ kcal/24 hr}) (4186 \text{ J/kcal}) = 5.0 \text{ E8 J/y/ha}$$

$$\text{Labor ETR} = \frac{7.63 \text{ E14 SEJ/y}}{5 \text{ E8 J/y}} = 1.52 \text{ E6}$$

4. Seeds are part of yield

5. Corn yield

$$(1944 \text{ kg/ha/y}) (1 \text{ E3 g/kg}) (3.52 \text{ kcal/g}) (4186 \text{ J/kcal})$$

$$= 2.86 \text{ E10 corn J/y/ha}$$

$$\text{Corn ETR} = \frac{7.63 \text{ E14 SEJ/y}}{2.86 \text{ E10 J/y}} = 2.67 \text{ E4}$$

APPENDIX A9b: INDUSTRIAL CORN

Using data supplied by Pimentel (1979) and adding environmental and service inflows, a more complete energy analysis was given. See Tables A9b and Figure A9b.

Table A9b. Energy flows in one ha of industrial corn.

Foot- note	Type of Energy	Actual Energy J/y	ETR SEJ/J	Embodied Solar Energy E13 SEJ/y
1.	Direct Sun	1.05 E13	1	1.05
2.	Indirect Sun, rain	3.0 E10	1.54 E4	46.0
3.	Soil used up	9.92 E8	6.3 E4	6.3
4.	Direct fuel	5.02 E9	6.6 E4	33.0
5.	Indirect fuel in machinery in coal equivalents	2.39 E9	4.0 E4	9.4
6.	Service, \$782/y	-	3.45 E12/\$	270.0
7.	Pesticide, oil equivalent	1.2 E9	6.6 E4	8.0
8.	Phosphate	2.51 E7	4.14 E7	104.0
9.	Nitrogen	2.78 E8	1.69 E6	47.0
10.	Potassium	5.62 E7	2.62 E6	14.7
11.	Seed (fuel equivalents)	2.20 E9	6.6 E4	14.5
12.	Corn yield	8.02 E4	6.8 E4	548.9
13.	Corn stalks	16.0 E4	3.4 E4	548.9

Footnotes for Table A9b.

* Many data from Pimentel (1979, p.69)

1. Direct Sun

$$(1 \text{ E6 kcal/m}^2/\text{y}) (1 \text{ E4 m}^2/\text{ha}) (0.25\text{y}) (4186 \text{ J/kcal})$$

$$= 1.05 \text{ E13 J/y}$$

2. Indirect sun in rain

$$5 \text{ J/g (Table 3.1, Footnote 6)}$$

$$\text{rain transpired by crop, } 0.6 \text{ m}^3/\text{m}^2/\text{y}$$

$$(1 \text{ E4 m}^2/\text{ha}) (0.6 \text{ m}^3/\text{m}^2/\text{y}) (1 \text{ E6 g/m}^3 \text{ density}) (5 \text{ J/g})$$

$$= 3 \text{ E10 J/y}$$

Footnotes to Table A9b continued

3. Soil used up

Organic matter in cornland soil, 12 T/acre in 45 cm.

$$\frac{(12 \text{ T/acre}) (1 \text{ E6 g/T})}{(4.05 \text{ E3 m}^2/\text{acre}) (0.45 \text{ m}^3/\text{m}^2)} = 6.58 \text{ E3 gorg./m}^3$$

Top soil loss in corn land, 10 T/ha/y
(Larson, Pierce and Dowdy 1983)

$$\frac{(10 \text{ T/ha/y}) (1 \text{ E6 g/T}) (6.58 \text{ E3 gorg./m}^3)}{(1.5 \text{ E6 g/m}^3 \text{ density})} = 4.39 \text{ E4 g/ha/y}$$

$$(4.39 \text{ E4 g/ha/y}) (5.4 \text{ kcal/g}) (4186 \text{ J/kcal}) = 9.92 \text{ E8 J/y}$$

4. Direct fuel

$$(1.2 \text{ E6 kcal/ha/y}) (4186 \text{ J/kcal}) = 5.02 \text{ E9 J/y}$$

5. Indirect fuel in machinery

5.58 E5 kcal coal equiv./ha/y based on 10 y depreciation
(Pimentel, 1979); $(5.58 \text{ E5 kcal/y}) (4186 \text{ J/kcal}) = 2.34 \text{ E9 J/y}$

6. Service

To avoid double counting of the service that the fuel embodied in goods (machinery) generated, the dollar equivalent of that fuel was subtracted; 1975 US Energy-dollar ratio from Appendix A4 is

3.45 E12 SEJ/\$.

$$\text{Correction: } \frac{(2.34 \text{ E9 J/y coal equiv. in machinery}) (4 \text{ E4 SEJ/J})}{3.45 \text{ E12 SEJ/\$}}$$

= \$27.1

$$(\$150/\text{T}) (5.39 \text{ T}) - (\$27.1) = \$782$$

To eliminate double counting in evaluating service due to corn contributing to US energy-dollar ratio, US corn energy(S) contributing to the total energy-dollar ratio (P_1) is subtracted. The corrected energy-dollar ratio for service is:

Footnotes to Table A9b continued

(P - S/X) where X is Gross National Product

$$\text{For 1975: } (3.4 \text{ E12 SEJ/\$}) - \frac{(1.40 \text{ E23 SEJ/y})}{(\$1.32 \text{ E12/y})} = 3.31 \text{ E12 SEJ/\$}$$

$$(\$782/\text{y}) (3.31 \text{ E12 SEJ/\$}) = 2.59 \text{ E15 SEJ/y}$$

7. Pesticide

Oil equivalents used in pesticide manufacture, 2.87 E5 kcal/ha Pimentel 1979).

$$(2.87 \text{ E5 kcal/y}) (4186 \text{ J/kcal}) = 1.20 \text{ E9 J/y}$$

8. Phosphate (7.2 E4 g/y) (348 J/g) = 2.51 E7 J/y

9. Nitrogen

2.17 E9 J/T from Appendix A16

$$(128 \text{ kg/y}) (2.17 \text{ E6 J/kg}) = 2.79 \text{ E8 J/y}$$

10. Potassium

702 J/g from Table A15, Footnote 8

$$(80 \text{ E3 g/y}) (702 \text{ J/g}) = 5.62 \text{ E7 J/y}$$

11. Seeds

Oil equivalents of seed production, 5.25 E5 kcal/ha (Pimentel 1979)

$$(5.25 \text{ E5 kcal/y}) (4186 \text{ J/kcal}) = 2.20 \text{ E9 J/y}$$

12. Corn yield

$$(19.5 \text{ E6 kcal/ha}) (4186 \text{ J/kcal}) = 8.02 \text{ E10 J/y}$$

$$\text{ETR: } \frac{\text{sum of inputs in SEJ}}{\text{output J}}$$

$$\text{ETR} = \frac{(549 \text{ E12 SEJ/y})}{(8.02 \text{ E10 J/y})} = 6.84 \text{ E4 J/y}$$

Footnotes to Table A9b continued

13. Corn stalks

2 times corn yield

$$\text{ETR} = \frac{(549 \text{ E13 SEJ/Y})}{(16. \text{ E10 J/Y})} = 3.43 \text{ E4 J/y}$$

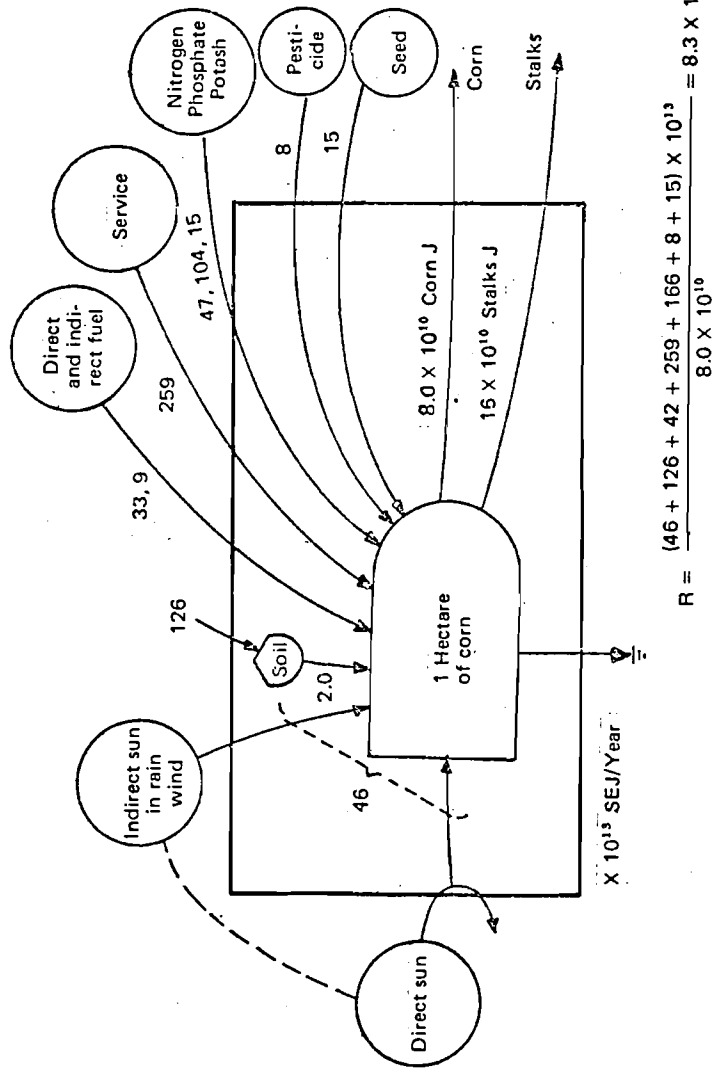

Figure A9b. Energy diagram of industrial corn production.

APPENDIX A10: NEW ZEALAND PLANTATION WOOD

With a favorable combination of rainfall and fohn winds augmented with fertilizer, monterrey pine (Pinus radiata) growing as an exotic in New Zealand plantations exhibits one of the fastest commercial timber growth rates. Table A10 and Figure A10 contain energy evaluations of inputs and yields.

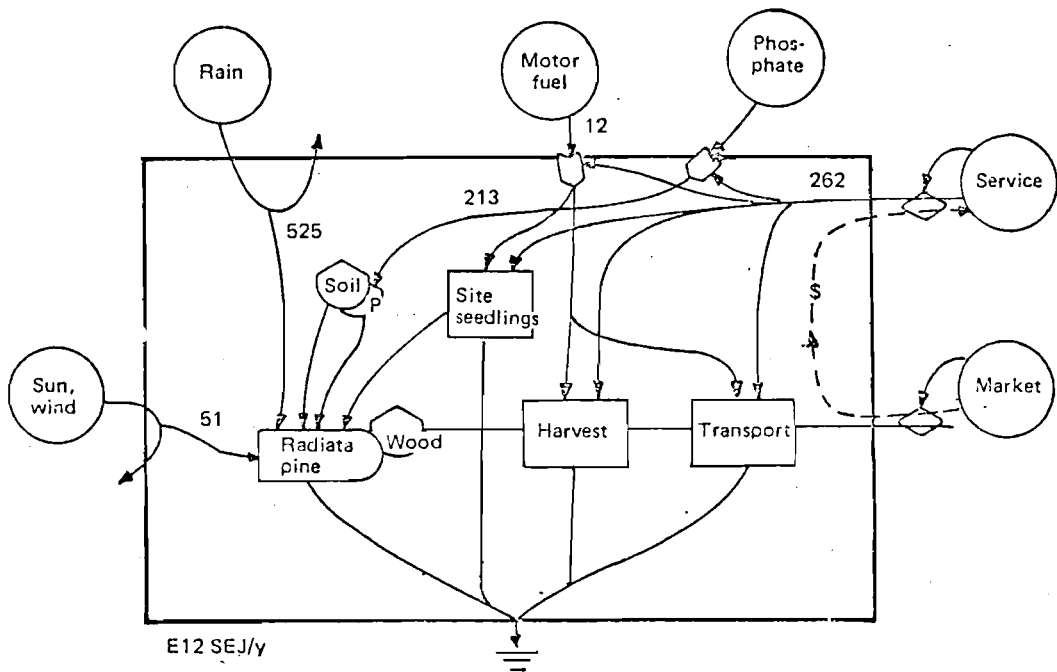

Figure A10. Energy diagram of monterrey pine cultivation in New Zealand.

Table A10. Radiata Pine plantations in New Zealand, 1 ha.

Foot-note	Item	Actual Energy J/y		Embodied Solar Energy E12 SEJ/y
1	Direct sun	5.14 E13	1	51.4
2	Rain used, evapotranspired	3.16 E10	1.61 E4	525.
3	Phosphate added	4.84 E6	4.4 E7	213.
4	Fuel in site preparation, seedlings harvest and transport	1.79 E8	6,6 E4	11.8
5	Services in 1978 \$57	-	4.6 E12/\$	262.
6	Yield prorated over 24 y	1.507 E11	6.7 E3	1012.

Footnotes for Table A10

- Costs for 1978 supplied by D.J. Mead; mean insolation 333.65 ly/d (Lisle 1960)
 $5.1 \text{ E9 J/m}^2/\text{y}$
 $(5.1 \text{ E9 J/m}^2/\text{y}) (1 \text{ E4 m}^2/\text{Ha}) = 5.1 \text{ E13}$
- Rain used, (2.06 m rain - 1.42 m runoff) Toebes (1972)
 $(0.64 \text{ m}^3/\text{m}^2) (1 \text{ E4 m}^2/\text{Ha}) (1 \text{ E6 g/m}^3) (4.9 \text{ J/g}) = 3.16 \text{ E10 J/Ha/y}$
- Phosphate, 2 T/Ha/24 y; ETR from Appendix 6;
 $(0,083 \text{ T/Ha/y}) (1 \text{ E6 g/T}) (58.3 \text{ J/g}) = 4.84 \text{ E6}$
- Liquid Fuels used; unit rates from New Zealand Ministry of Forestry (1981) per m³ wood; logging, 52 E6 J/m³; transport 130 E6 J/m³; loading, 33 E6 J/m³
 $(215 \text{ E6 J/m}^3) (20 \text{ m}^3/\text{Ha}/24 \text{ y}) = 1.79 \text{ E8 J/Ha/y}$
- Services in 1978 N2 \$; Data supplied by D.J. Mead for 1978 fertilizer, \$205; roads, \$73; land preparation, \$60; planting, \$60; stock, \$33; restock, \$20; first thinning, \$60; second thinning, \$45; administration, \$480; cutting and roads, \$334; total \$1364/Ha/24/yrs; \$57/ha/y.
 $(\$57/\text{Ha}/\text{yr}) (4.6 \text{ E12 SEJ}/\$) = 262 \text{ E12 SEJ/y}$

Footnotes to Table A10 continued

For planting and fertilizing only

$$(\$1036/24 \text{ y}) (4.6 \text{ E12 SEJ}/\$) = 199 \text{ E12 SEJ}/\text{y}$$

6. Yield 10 T dry/Ha/g when averaged over 24 years cutting cycle;
3.6 kcal/g dry

$$(10 \text{ T}/\text{Ha}/\text{y}) (1 \text{ E6 g}/\text{T}) (3.6 \text{ kcal}/\text{g}) (4186 \text{ J}/\text{kcal}) = 1.507 \text{ E11 J}/\text{y}$$

Harvested wood

$$\text{ETR} \quad \frac{(525 + 213 + 262 + 12) \text{ E12 SEJ}/\text{y}}{(1.506 \text{ E11 J wood}/\text{y})} = 6720 \text{ SEJ}/\text{J wood}$$

Wood still standing (not including harvest - see footnote 5)

$$\text{ETR} = \frac{(525 + 213 + 199) \text{ E12 SEJ}/\text{y}}{1.506 \text{ E11 J wood}} = 6221/\text{SEJ}/\text{J wood}$$

APPENDIX A11: SHEEP PRODUCTION IN NEW ZEALAND

Data from New Zealand sources were used to evaluate a typical hectare of intensive sheep production generating wool and meat products and utilizing phosphate fertilizer and direct and indirect fuels in machines. Some government subsidies were included. The system is summarized in Figure A11 and calculations are given in Table A11 including estimation of energy transformation ratios for wool and meat (Footnotes 8 and 9 to Table A11).

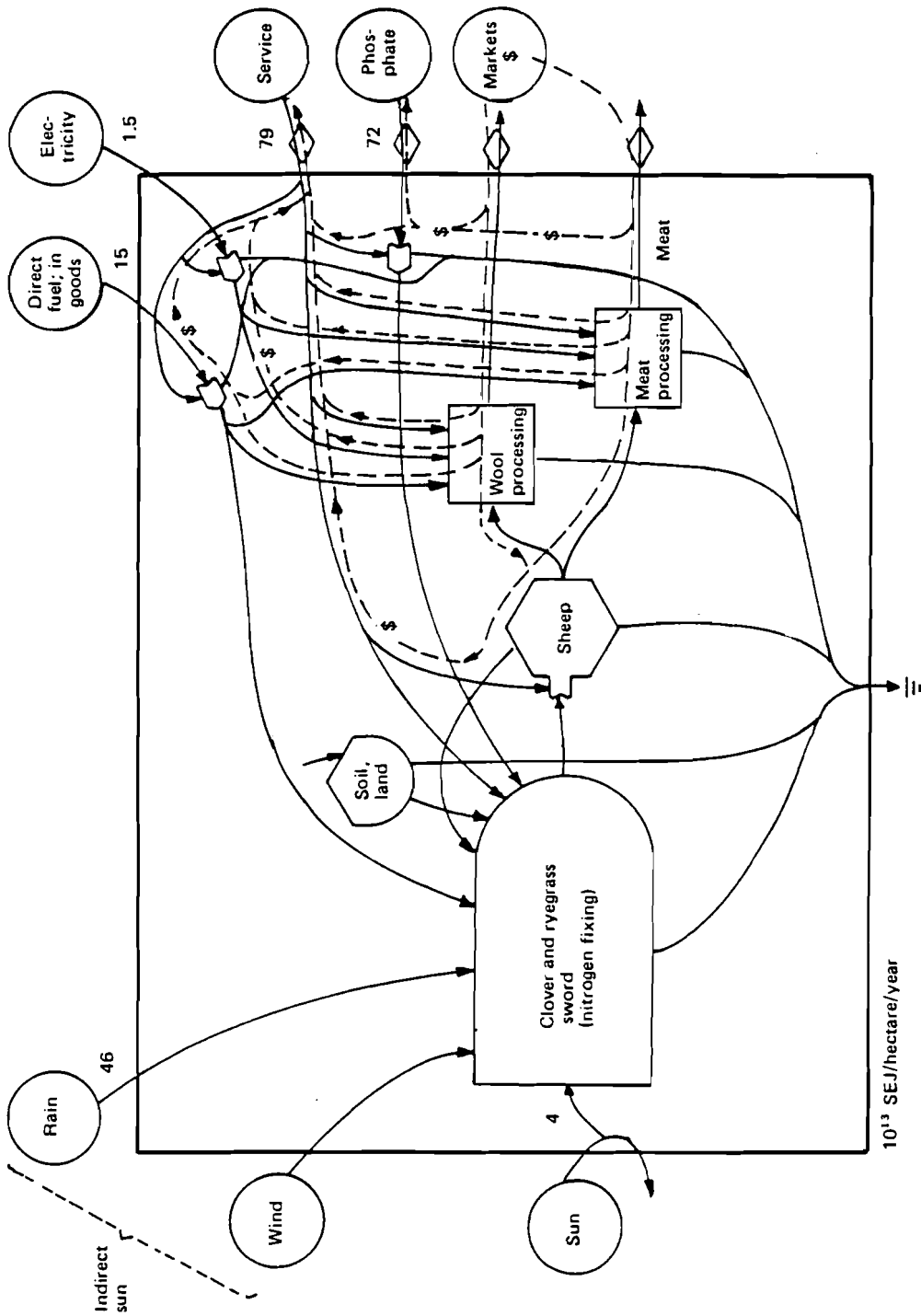

Figure A11. Energy diagram of sheep production in New Zealand.

Table A11. Energy flows in New Zealand sheep production per hectare.

Foot-note	Item	Actual Energy J/y	ETR SEJ/J	Embodied Solar Energy E13 SEJ/y
1	Direct solar energy	3.6 E13	1	3.7
2	Rain used, evapotranspired	3.0 E10	1.54 E4	46.2
3	Phosphate applied	1.67 E7	4.4 E7	72.2
4	Services in 1978 \$	\$334	2.37 E12/\$	79.1
5	Subsidy on fertilizer, 1978 \$	\$13	2.39 E12/\$	3.1
6	Fuel used	2.29 E9	6.6 E4	15.1
7	Electricity used	0.096 E9	1.59 E5	1.5
8	Wool produced	5.65 E8	3.84 E6	217.
9	Meat produced	1.27 E9	1.71 E6	217.

Footnotes to Table A11

1. Direct solar energy, Lisle (1960)

$$(4.6 \text{ E}9 \text{ J/m}^2/\text{y}) (1 \text{ E}4 \text{ m}^2/\text{Ha}) (0.80 \text{ absorbed})$$

$$= 36.8 \text{ E}12 \text{ SEJ/ha/y}$$

2. Rain

0.6 m of rain evapotranspired; Gibbs free energy in rain relative to salty leaf potentials, 5 J/g (Footnote 6 in Table 3.1).

$$(0.6 \text{ m}^3/\text{m}^2/\text{y}) (1 \text{ E}4 \text{ m}^2/\text{ha}) (1 \text{ E}6 \text{ g/m}^3) (5 \text{ J/g}) = 3 \text{ E}10 \text{ J/y}$$

3. Phosphate

Application, 5.0 E4 g/ha/g; aqueous concentration 1 mg/l relative to soil waters, 0.01/mg/l.

$$\text{Gibbs free energy/g} = \frac{8.33 (\text{J/mole/deg}) (300^0)}{(35 \text{ g/mole P})} \text{Log}_e \left(\frac{1}{.01} \right)$$

$$= 328 \text{ J/g}$$

$$(5.0 \text{ E}4 \text{ g/ha/y}) (328 \text{ J/g}) = 1.64 \text{ E}7$$

Footnotes to Table A11 continued

4. Services

Money spent plus subsidies, 1978 dollars

(5 sheep/ha) (5.4 kg wool/sheep) (\$2.20/kg wool)
= \$59.4/ha/y for wool

(5 sheep/ha) (55 kg meat/sheep) (\$1/kg meat)
= \$275/ha/y

\$275 + 59.4 = \$334.4

5. Fertilizer subsidies, N.Z. Yearbook (1981)

In 1980 \$63 E6 subsidy; 4.83 E6 ha fertilized

$$\frac{(\$63 \text{ E6/y})}{(4.83 \text{ E6 ha})} = 13.0 \text{ \$/Ha/y}$$

6. Fuel use

Transport and distribution of fertilizer (Pimentel and Pimentel 1979 quoting Lockeretz 1978) 1.5 E3 kcal/kg P.

$$(1.5 \text{ E3 kcal/kg P}) (50 \text{ kg/ha/y}) (4186 \text{ J/kcal}) = 3.2 \text{ E5}$$

6,7. Mean energy input to livestock production on 20 farms in New Zealand (McChesney, Bubb, and Pearson 1978)
.229 E9 J/Ha/y fuel use direct and indirect
5.5 E9 J elect./Ha/y electric use.

8. Wool Produced

$$(5 \text{ sheep/ha}) (5.4 \text{ kg wool/sheep}) = 27.0 \text{ kg wool}$$

$$(27.0 \text{ kg wool}) (5 \text{ kcal/g}) (1 \text{ E3 g/kg}) (4186 \text{ J/g}) = 5.65 \text{ E8 J/Ha/y}$$

$$\text{ETR} = \frac{(46.2 + 72.2 + 79.1 + 3.1 + 15.1 + 1.5) \text{ E13 J/y}}{5.65 \text{ E8 J/y}} =$$

$$= 3.84 \text{ E6 SEJ/J}$$

Foonotes to Table A11 continued

9. Meat produced

$$(5 \text{ sheep/ha/y}) (55 \text{ kg meat/sheep}) = 275 \text{ kg meat}$$

$$(275 \text{ kg meat}) (0.22 \text{ protein}) (5 \text{ kcal/g}) (1 \text{ E3 g/kg}) (4186 \text{ J/kcal})$$

$$= 1.27 \text{ E9 J/ha/g}$$

$$\text{ETR} = \frac{(42.6 + 72.2 + 79.1 + 3.1 + 15.1 + 1.5) \text{E13 J/y}}{1.27 \text{ E9 J/y}}$$

$$= 1.71 \text{ E6 SEJ/J}$$

APPENDIX A12: ALUMINUM MANUFACTURE

The Bluff Aluminum plant in southern New Zealand uses hydroelectric power of a mountain lake to convert imported bauxite into aluminum ingots that were sold abroad. An energy analysis of this system provides perspectives and transformation ratios on aluminum.

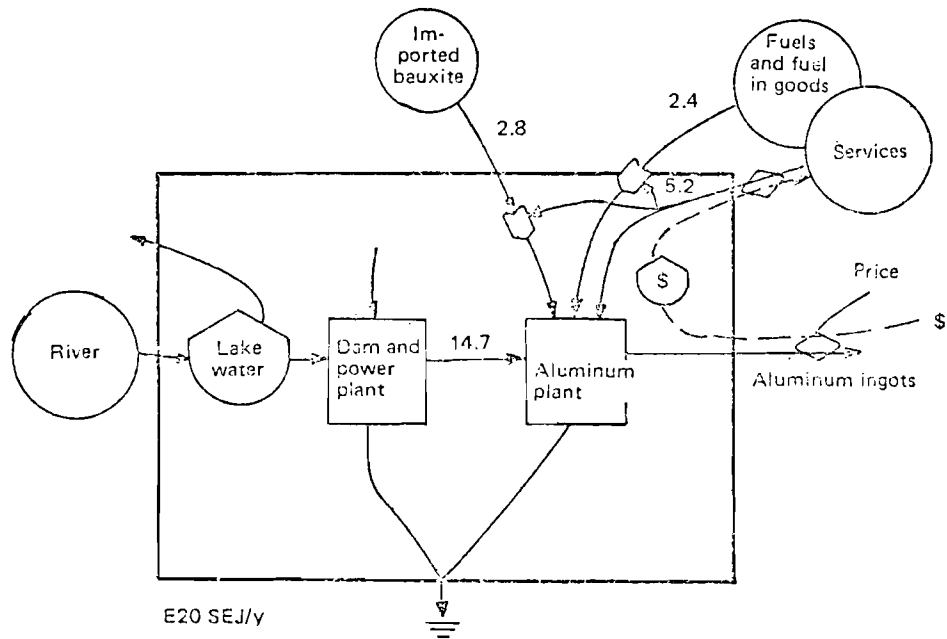

Figure A12. Energy flows for the Bluss aluminum smelter in Southern New Zealand.

Table A12. Energy flows in Aluminum manufacture.

Foot-note	Item	Actual Energy J/y	ETR SEJ/J	Embodied Solar Energy 20 SEJ/y
1	Electricity use	9.24 E15	1.59 E5	14.7
2	Bauxite use	2.10 E13	1.32 E7	2.8
3	Services in ore, \$5.0 E7/y	-	1.85 E12/\$	0.92
4	Services in plant \$2.31 E8/y	-	1.85 E12/\$	4.27
5	Fuel use	3.57 E15	6.6 E4	2.36
6	Aluminum produced 1.54 E11 g/y	-	1.63 E10/g	25.1

Footnotes for Table A12

Data from van Moeseke (1981) for 1979

1. Electricity use

2.781 E12 watt hours/y; load factor 0.923.

(2.781 E12 wh) (3600 see/h) (1 J/see/w) (0.923)

= 9.24 E15 J/y

2. Bauxite use

N.Z. Yearbook(1981), 3.21 E5 T/y in 1979.

(3.21 E5 T/y) (65.3 J/g) (1 E6 g/T) = 2.10 E13 J/y

3. Services in cost of ore

N.Z. Yearbook(1981)

(\$5.00 E7/y)/(3.21 E5 T/y) = \$156/T

4. Total costs of plant, debt, maintenance

(1.54 E5 T/y) (\$1500/T(1979 U.S.)) = \$2.31 E8/y

Footnotes to Table A12 continued

5. Fuel use

van Moeseke (1981), 0.5 T oil/T.

$$(0.5 \text{ T oil/T}) (1.54 \text{ E5 T/y}) (46.3 \text{ E9 J/T oil}) = 3.57 \text{ E15 J/y}$$

6. Aluminum produced (1979)

$$(1.54 \text{ E5 T/y}) (1 \text{ E6 g/T}) = 1.54 \text{ E11 g/y}$$

$$\begin{aligned} \text{ETR} \\ \text{per g} &= \frac{(14.7 + 2.8 + 2.4 + 5.2) \text{ E20 SEJ/y}}{1.54 \text{ E11 g Al/y}} \\ &= 1.63 \text{ E10 SEJ/g Al} \end{aligned}$$

Gisela Bosch
*International Institute for Applied
Systems Analysis, Laxenburg, Austria*

APPENDIX A13: SOLAR EQUIVALENTS OF RAW AND REFINED
IRON, STEEL, AND END-PRODUCTS

Iron is a very high quality resource because it was first concentrated by geological processes, and then it has to be mined and processed.

Data are assembled here for processing of iron-ore and manufacture of steel and machinery products in West Germany. For the calculation of the energy transformation ratios of the various iron products the embodied energy of iron-ore (Table 3.1) was combined with the inputs of transportation, fossil fuel and wages (Figure A13a and Table A13b).

As shown in Table A13 Footnote 9 and 10, in comparison to the embodied energy of the money paid, the embodied energies of 1) raw iron and steel, 2) refined iron and steel and 3) end products are 1.74, 3.0, 6.0 times higher respectively.

Figure A13c shows the actual energy flow and Figure A13d shows the tonnage flow. In both diagrams there is a big gap

between the input and output in raw iron and steel production. This means that there must be a feedback loop through which a significant amount of scrap iron is recycled. No data was found about such an internal feedback loop. The import and export of scrap iron, 1.6 E6 T and 3.0 E6 T respectively, neither of which is very significant, give an incomplete picture. Should scrap iron be included in any future revision, caution should be exercised to avoid double counting.

Table A13. Energy flow in the West German processing of iron, steel and end product subsystem (see Figure A13).

Foot-note	Item	Units per year (y)	Actual Energy J/y	ETR SEJ/Y	Embodied Solar Energy E22 SEJ/y
1	Iron-ore import	4.9 E7 t	1.65 E15	2.6 E7	4.3
2	Transportation	-	7.49 E16	5.3 E4	0.40
3	Fossil Fuel for raw iron & steel production	-	1.04 E18	-	5.36
4	Wages for the raw iron and steel production	4.9 E9 \$	-	3.0 E12 SEJ/\$	1.47
5	Fossil fuel for the iron & steel production	-	9.26 E16	-	0.65
6	Wages for the iron & steel refinement	4.5 E9 \$	-	3.0 E12 SEJ/\$	1.35
7	Fossil fuel for the production of the end-product	-	13.95 E16	-	1.27
8	Wages for the production of the end-product	35.67 E9 \$	-	3.0 E12 SEJ/\$	10.7
9	Payment total received for raw iron & steel	2.2 E10 \$	-	3.0 E12 SEJ/\$	1.65
	for refined iron & steel	1.4 E10 \$	-	" "	1.05
	for end-products	13.1 E10 \$	-	" "	9.82
10	Total production of raw iron & steel	12.6 E7 t	11.4 E15	1.01 E7	10.7
	refined iron & steel	7.6 E7 t	6.87 E15	1.84 E7	11.7
	end-products	3.8 E7 t	3.4 E15	6.94 E7	15.6

Footnotes to Table A13

1. Iron-ore imported

Iron-ore imported (1979) (Jahrbuch f. Bergbau 1982/83):

4.9 E7 T/y

Free energy (extrapolated from Gilliland 1978):

33.7 E6 J/T_{Fe-ore}

$$(4.9 \text{ E7 T/y}) (33.7 \text{ E6 J/T}_{\text{Fe-ore}}) = 1.65 \text{ E15 J/y}$$

Footnotes to Table A13 continued

2. Transportation

Weighted distance:

import %	continents	distance km	weighted distance km
21	EG	1000	210
12	rest of Europe	2000	240
65	America & Africa	9000	<u>5850</u>
			<u>6300</u>

Iron-ore imported (1979) (Jahrbuch f. Bergbau 1982/83)

Europe 1.62 E7 T/y

America and Africa 3.28 E7 T/y

Energy requirement for transportation (Fluck 1980)

- by railroad 0.54 E6 J/t/km

- by boat 0.37 E6 J/t/km

ETR (oil): 5.3 E4 SEJ/J (Table 3.1.)

(450 km) (1.62 E7 T/y) (0.54 E6 J/t/km) = 0.39 E16 J/y

(5850 km) (3.28 E7 T/y) (0.37 E6 J/t/km) = 7.10 E16 J/y
7.49 E16 J/y

(7.49 E16 J/y) (5.3 E4 SEJ/J) = 0.40 E22 SEJ/y

- T oil used by transportation

$\frac{7.49 \text{ E16 J/y}}{4.5 \text{ E10 J/T}} = 1.7 \text{ E6 T/y}$

3. Fossil fuel for raw iron and steel (1979) (Stat. Jahrbuch f. FRG 1981)

electricity used: 20580 E6 kwh/y

gas used: 6.9 E9 m³/y

coal used: 19674 E3 T/y

oil used: 2367 E3 T/y

Footnotes to Table A13 continued

Actual energy

electricity:	3.6	E6 J/kwh (Table 2.1.)
gas:	35.169	E3 J/m ³ (Stat. Jahrbuch f. FRG 1981)
coal:	3.18	E10 J/T (Table 2.1.)
oil:	4.5	E10 J/T (Table 2.1.)

ETR (Table 3.1.)

electricity:	15.9	E4 SEJ/J
gas:	4.8	E4 SEJ/J
coal:	3.98	E4 SEJ/J
oil:	5.3	E4 SEJ/J

Embodied energy

electricity:	20580 E6 kwh/y) (3.6 E6 J/kwh) (15.9 E4 SEJ/J)
	= 1.18 E22 SEJ/y
gas:	(6.9 E9 m ³ /y) (35169 E3 J/m ³) (4.8 E4 SEJ/J)
	= 1.15 E22 SEJ/y
coal:	(19674 E3 T/y) (3.18 E10 J/T) (3.98 E4 SEJ/J)
	= 2.47 E22 SEJ/y
oil:	(2367 E3 T/y) (4.5 E10 J/T) (5.3 E4 SEJ/J)
	= <u>0.56 E22 SEJ/y</u>
	5.36 E22 SEJ/y

4. Wages for the raw iron and steel production

Wages paid (1979) (Stat. Jahrbuch f. FRG 1981) 9.7 E9 DM
\$/DM - ratio (1980) (UN Stat. Yearbook 1979/80) 1.959 DM/\$

Wages paid (1979), 4.9 E9 \$/y

Footnotes to Table A13 continued.

Energy/\$-ratio for FRG (Table 11.3): 3.00 E12 SEJ/\$

embodied energy in wages:

(wages paid) (FRG energy/\$)

(4.9 E9 \$/y) (3.00 E12 SEJ/\$) = 1.47 E22 SEJ/y

5. Fossil Fuel for the iron and steel refinement

(1979) (Stat. Jahrbuch f. FRG 1981)

electricity used: 5449 E6 kwh/y

gas used: 688 E6 m³/y

coal used: 851 E3 T/y

oil used: 483 E3 T/y

Actual energy and ETR: Footnote 3

Embodied energy:

electricity: (5449 E6 kwh/y) (3.6 E6 J/kwh) (15.9 E4 SEJ/J)
= 3.12 E21 SEJ/y

gas: (688 E6 m³/y) (35169 E3 J/m³) (4.8 E4 SEJ/J)
= 1.16 E21 SEJ/y

coal: (851 E3 T/y) (3.18 E10 J/T) (3.98 E4 SEJ/J)
= 1.08 E21 SEJ/y

oil: (483 E3 T/y) (4.5 E10 J/T) (5.3 E4 SEJ/J)
= 1.12 E21 SEJ/y
6.48 E21 SEJ/y

6. Wages for the iron and steel refinement

wages paid (1979) (Stat. Jahrbuch f. FRG 1981) 8.9 E9 DM/y

DM/\$ ratio (1980) (UN Stat. Yearbook 1979/80) 1.959 DM/\$

Footnotes to Table A13 continued.

wages paid (1979)	4.5 E9 \$/y
energy/\$-ratio: Footnote 4	3.00 E12 SEJ/\$
embodied energy in wages: (wages paid) (FRG energy/\$ ratio): (4.5 E9 \$/y) (3.00 E12 SEJ/\$) = 1.35 E22 SEJ/y	

7. Fossil fuel for the production of the end-product (1979) (Stat. Jahrbuch f. FRG 1981)

electricity used:	14846 E6 kwh/y
gas used:	843 E6 m ³ /y
coal used:	206 E3 T/y
oil used:	1113 E3 T/y

Actual energy and ETR: Footnote 3

Embodied energy:

electricity:	(14846 E6 kwh/y) (3.6 E6 J/kwh) (15.9 E4 SEJ/J)
	= 8.5 E21 SEJ/y
gas:	(843 E6 m ³ /y) (35169 E3 J/m ³) (4.8 E4 SEJ/J)
	= 1.4 E21 SEJ/y
coal:	(206 E3 T/y) (3.18 E10 J/T) (3.98 E4 SEJ/J)
	= 0.3 E21 SEJ/y
oil:	(1113 E3 T/y) (4.5 E10 J/T) (5.3 E4 SEJ/J)
	= <u>2.5 E21 SEJ/y</u>
	12.7 E21 SEJ/y

8. Wages for the production of end-product

wages paid (1979) (Stat. Jahrbuch f. FRG 1981)	6.99 E10 DM/y
DM/\$ ratio (1980) (UN Yearbook 1979/80)	1.959 DM/\$

Footnotes to Table A13 continued

wages paid (1979) 3.57 E10 \$/y
energy/\$ ratio: Footnote 4 3.00 E12 SEJ/y/\$
embodied energy in wages:
(wages paid) (FRG energy/\$ ratio) =
(3.57 E10 \$/y) (3.00 E12 SEJ/\$) = 10.7 E22 SEJ/y

9. Figures: 1978, (Stat. Jahrbuch f. FRG 1981)

10. Final Figures for produced

raw iron and steel:

- actual energy

raw iron and steel production (1979) (Stat. Jahrbuch f. FRG
1981) 12.6 E7 T/y

Free energy (extrapolated from Gilliland 1978) 90.4 E6 J
(12.6 E7 T/y) (90.4 E6 J/T_{Fe}) = 1.14 E16 J/y

- Embodied energy of raw iron and steel (Footnotes 1,2,3,4)

embodied energy of iron ore : 4.3 E22 SEJ/y
embodied energy of transportation: 0.4 E22 SEJ/y
embodied energy of fossil fuel : 5.36 E22 SEJ/y
embodied energy in labor : 1.47 E22 SEJ/y
11.53 E22 SEJ/y

ETR of raw iron and steel

$\frac{\text{embodied energy}}{\text{actual energy}}$

$\frac{11.53 \text{ E22 SEJ/y}}{1.14 \text{ E16 J/y}} = 1.01 \text{ E7 SEJ/J}$

refined iron and steel

Footnotes to Table A13 continued

- actual energy

refined iron and steel production (1979) (Stat. Jahrbuch f. FRG 1981) 76 E6 T/y

Free energy (extrapolated f. Gilliland 1978) 90.4 E6 J (76 E6 T/y) (90.4 E6 J/T_{Fe}) = 6.87 E15 J/y

- embodied energy of refined iron and steel (Footnotes 5, 6)

embodied energy of raw iron and steel: 10.64 E22 SEJ/y

embodied energy of fossil fuel : 0.65 E22 SEJ/y

embodied energy in labor : 1.35 E22 SEJ/y

12.64 E22 SEJ/y

ETR of refined iron and steel

embodied energy
actual energy

$$\frac{12.64 \text{ E22 SEJ/y}}{6.87 \text{ E15 SEJ/y}} = 1.84 \text{ E7 SEJ/J}$$

end-products

- actual energy

end-product production(1979)(Stat. Jahrbuch f. FRG 1981) 38 E6 T/y

Free energy (extrapolated f. Gilliland 1978) 90.4 E6 J

(38 E6 T/y) (90.4 E6 J/T_{Fe}) = 3.4 E15 J/y

- Embodied energy of the end-products (Footnotes 7, 8)

embodied energy of refined iron and steel: 11.63 E22 SEJ/y

embodied energy of fossil fuel : 1.27 E22 SEJ/y

embodied energy in labor : 10.7 E22 SEJ/y

23.6 E22 SEJ/y

ETR of the end-product

embodied energy
actual energy

$$\frac{23.6 \text{ E22 SEJ/y}}{3.4 \text{ E15 J/y}} = 6.94 \text{ E7 SEJ/y}$$

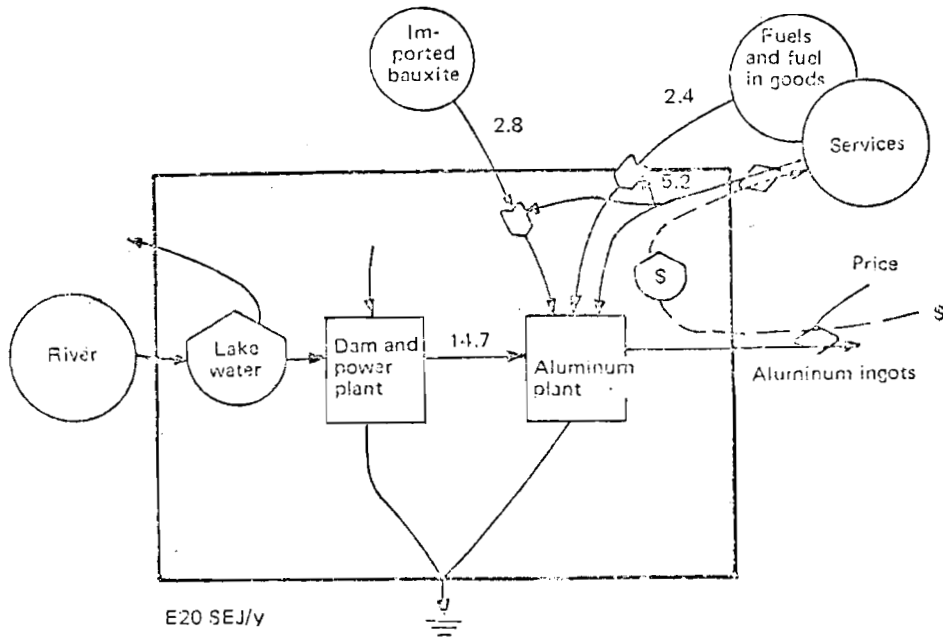

Figure A12. Energy diagram of aluminum production and export in New Zealand.

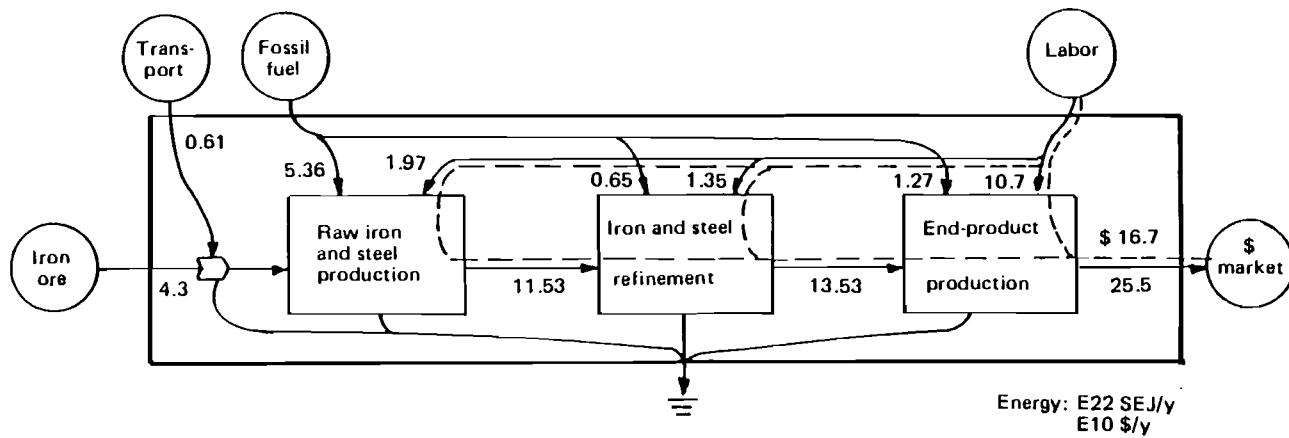

Figure A13a. Energy diagram of iron and steel production in West Germany.

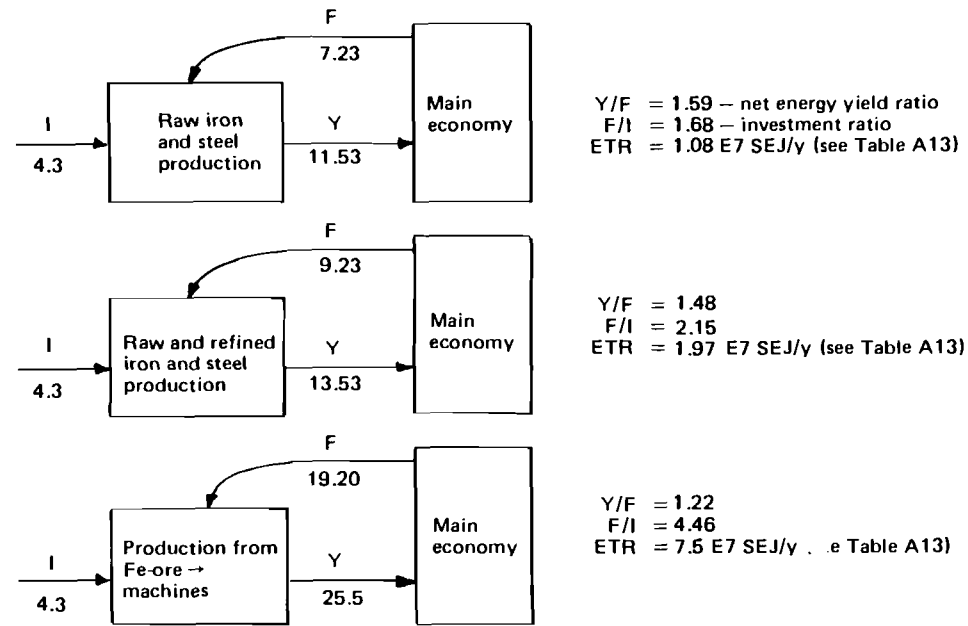

Figure A13b. Summary diagrams of ferrous industries of different levels of refinement.

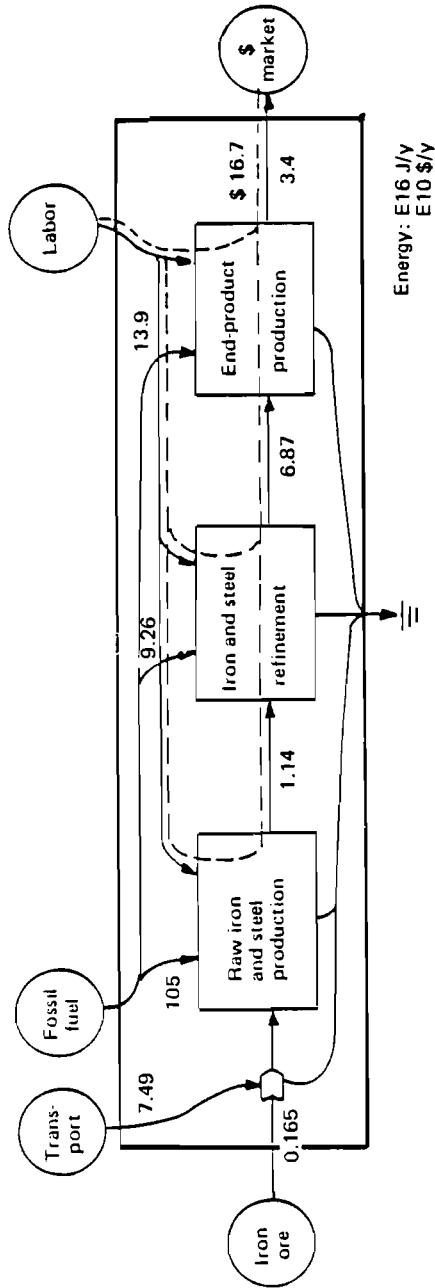

Figure A13c. Diagram of actual energy flows in iron and steel production in West Germany.

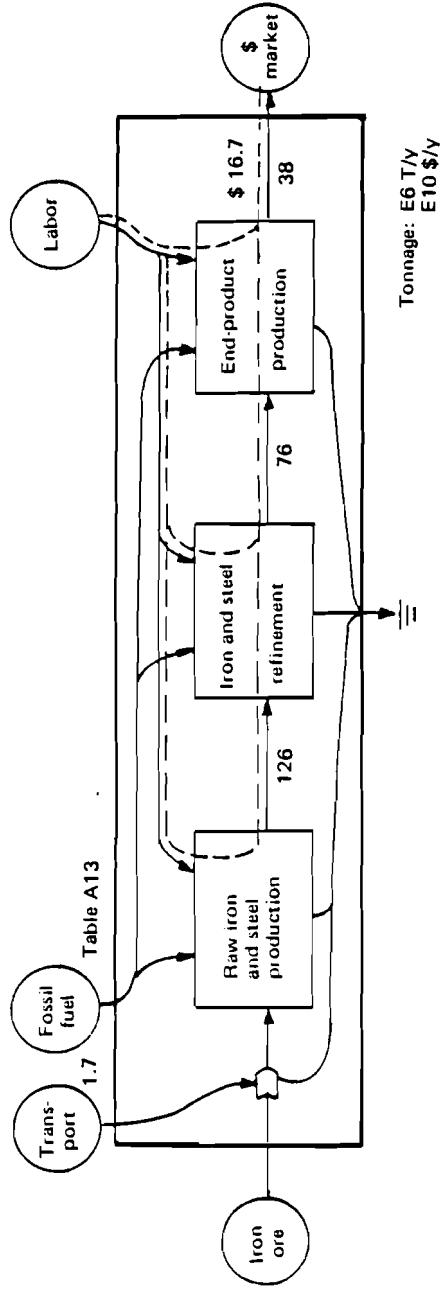

Figure A13d. Diagram of tonnage flows in iron and steel production in West Germany.

APPENDIX A14: HURRICANE WINDS

The passage of hurricanes over an area introduces a sharp impact of high quality, high velocity winds doing mechanical work on the vegetation and surface. An energy transformation ratio may be estimated from the fraction that hurricane wind energy is transferred to the surface. See Figure A14 and Table A14. Since land processes may not be necessary to hurricanes only solar fraction of global solar equivalents driving the biosphere and crust is used as input for energy transformation ratios.

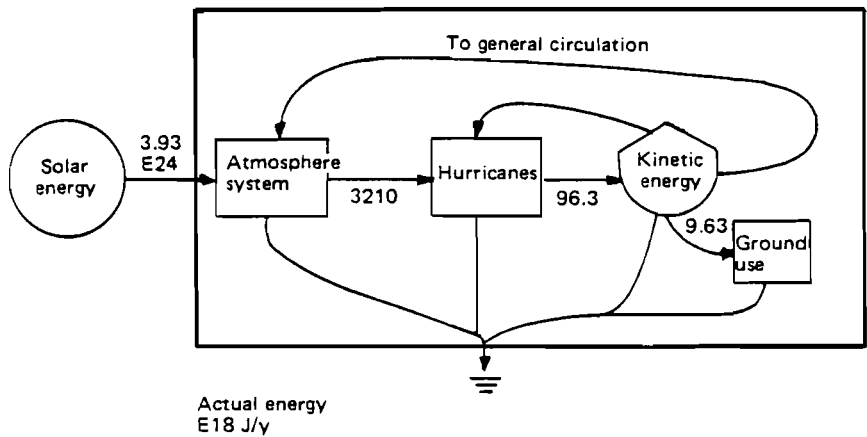

Figure A14. Energy diagram of hurricane production in meteorological systems.

Table A14. Energy transfers in hurricane wind work on the surface from one episode.

Foot-note	Item	Actual energy J/y	ETR SEJ/J	Embodied Solar Equivalents E24 SEJ
1	Energy flow through hurricanes	3.21 E21	1.224 E3	3.93
2	Kinetic energy in hurricanes	9.63 E19	4.08 E4	3.93
3	Kinetic energy used by surface system	9.63 E18	4.08 E4	0.39

Footnotes to Table A14

ETR's based on total solar energy, 3.93 E24 J/y operating biosphere (Appendix A1).

1. Energy flow through hurricanes

7.67 E17 kcal/y given by Riehl (1979) for global hurricanes
 (7.67 E17 kcal/y) (4186 J/kcal) = 3.21 E21 J/y

$$\text{ETR} = \frac{(3.93 \text{ E24 SEJ/y})}{(3.21 \text{ E21 hurricane J/y})} = 1.224 \text{ E3 SEJ/J hurricane energy}$$

2. Kinetic energy in hurricanes

Riehl (1979) gives 3% as fraction of hurricane energy as kinetic energy. 3% of 3.21 E21 J/y above = 9.63 E19 J/y

$$\text{ETR} = \frac{(3.93 \text{ E24 SEJ/y})}{(9.63 \text{ E19 J wind/y})} = 4.08 \text{ E4 SEJ/J}$$

3. Kinetic energy used by Surface system

10% of kinetic energy of hurricane dissipated in surface zone within system boundaries

$$(.10) (9.63 \text{ E19 J/y}) = 9.63 \text{ E18 J/y}$$

Energy quality (ETR) is the same since the wind category is the same, only being divided.

APPENDIX A15: POTASSIUM CHLORIDE FROM
THE DEAD SEA WORKS

Through the courtesy of Gerald Stanhill and H. Shekhter providing data on the potassium works on the Dead Sea in Israel, energy evaluations are included here to provide a solar energy transformation ratio for potash. Jordan River water passing through the northern Dead Sea and then into evaporation ponds, increases in salinity and finally is purified by industrial plants involving power, steam and fresh water.

Most of the energy is supplied by the sun. See Figure A15 and calculations in Table A15. The calculation was made for river water required for steady state potash production, although the situation at present is actually one of mining the stored salt in Dead Sea water faster than it is being replaced.

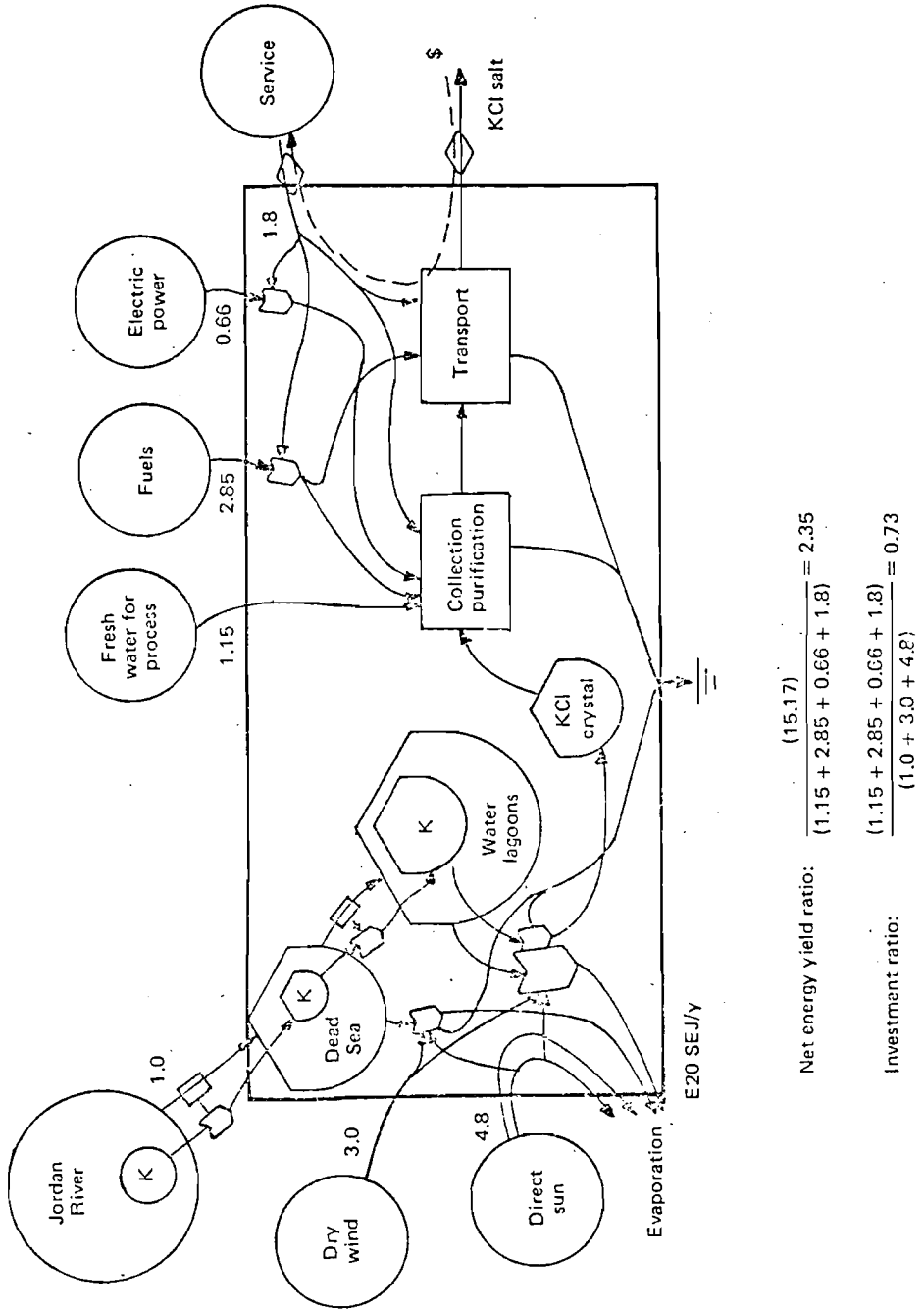

Figure A15. Energy diagram of potassium chloride production in Israel.

Table A15. Energy evaluation of potash production from the Dead Sea works, 1980-81.

Foot-note	Item	Actual Energy J/y	ETR SEJ/J	Embodied Solar Energy E20 SEJ/y
1	Solar energy evaporating water	4.78 E20	1.0	4.78
2.	Energy contribution from dry air	0.048 E20	61.5	2.95
3.	Fresh water used in works	7.66 E15	1.5 E4	1.15
4.	Fuel used	4.32 E15	6.6 E4	2.85
5.	Electricity used	4.41 E14	1.5 E5	0.66
6.	Services, finances, royalty 129 E6 US\$	-	1.38 E12 /\$US	1.8
7.	Water flow energy	4.07 E15	2.4 E4	0.98
8.	Energy in refined Potash	0.58 E15	2.62 E6	15.17

Footnotes for Table A15

1. Solar energy evaporating water

Water evaporation estimated for 0.83 E6 T K/y (0.52 of 1.6 T KCl/y where initial water with 10 g/m³ K.

$$\frac{(0.83 \text{ E6 T K/y}) (1 \text{ E6 g K/T})}{(10 \text{ g K/m}^3 \text{ river water})} = 0.83 \text{ E11 m}^3/\text{y river water}$$

evaporation in north basin, 1384 mm/y; sunlight absorbed (7.16-0.47 albedo) E9 J/m²/y; evaporation from ponds, 1000mm/y.

Solar energy per unit water:

$$\frac{(6.69 \text{ E9 J/m}^2/\text{y})}{(1.384 \text{ E6 g/m}^2/\text{y})} = 4834 \text{ solar J/g water evaporated}$$

$$\frac{(6.69 \text{ E9 J/m}^2/\text{y})}{(1.0 \text{ E6 g/m}^2/\text{y})} = 6690 \text{ solar J/g water evaporated}$$

mean: 5762 SJ/g water evaporated

$$(0.83 \text{ E11 m}^3 \text{ river water}) (1 \text{ E6 g/m}^3) (5762 \text{ SEJ/g}) = 4.78 \text{ E20 J/y}$$

Footnotes to Table A15 continued

2. Energy contribution from dry air

For a water vapor pressure of about 20 mb, measurements of vapor pressure difference were 14.8 mb
Gibbs free energy of water evaporated by this differential

$$= \frac{(8.33 \text{ J/Mole/deg}) (305 \text{ deg.C})}{(18 \text{ g/mole})} \text{Log} \frac{(20 + 14.8)}{(20)} = 54 \text{ J/g}$$

$$(0.83 \text{ E17 g water}) (54 \text{ J/g}) = 4.48 \text{ E18 J/y}$$

3. Fresh water used in works

$$(21.5 \text{ E6 m}^3/\text{y}) (1 \text{ E6 cm}^3/\text{m}^3) (1.1 \text{ g/cm}^3 \text{ brine}) (G)$$

$$= 7.66 \text{ E15 J/y} \quad \text{where}$$

$$G = \frac{(8.33 \text{ J/Mole/deg.}) (305 \text{ deg. C})}{(18 \text{ g/mole})} \text{Log}_e \frac{(999900)}{(100000)} =$$

$$= 7.66 \text{ E15 J/y}$$

4. Fuel use

$$(160 \text{ T steam/hr}) (70 \text{ kg fuel/T steam}) (44 \text{ E6 J/kg fuel})$$

$$= 4.32 \text{ E15 J/y}$$

5. Electricity use

1/3 of 42 MW used by potash, chlorine, and bromine plants

$$(14 \text{ E6 watt}) (1 \text{ J/watt/s}) (3.154 \text{ E7 s/y}) = 4.41 \text{ E14 J/y}$$

6. Services, labor, plant finance, government royalty

Exchange rate, second quarter, 1981, 1026 IS/\$US.

1.116 E9 IS/y sales for 1.333 E6 T KCl produced, 1980-81

$$\frac{(1.116 \text{ E9 IS/y})}{(1.333 \text{ E6 T KCl})} = 837 \text{ IS/T}$$

$$(1.6 \text{ E6 T/y}) (837 \text{ IS/T}) (0.097 \text{ \$US/IS}) = 1.29 \text{ E8 \$US/y}$$

7. Water flow energy

Elevation drop through Dead Sea system assumed 5 m

Footnotes to Table A15 continued

$$(0.83 \text{ E11 m}^3/\text{y}) (1 \text{ E3 kg/m}^3) (9.8 \text{ m/sec}^2) (5 \text{ m}) = 4.07 \text{ E15 J/y}$$

8. Energy in potash yield

$$\text{Free energy, G} = \frac{(8.33 \text{ J/mole/deg}) (305 \text{ deg})}{(39.1 \text{ g/mole})} \text{Log}_e \frac{(500000)}{(10 \text{ ppm})}$$

$$= 702 \text{ J/g K}$$

$$(0.84 \text{ E6 T K/y}) (1 \text{ E6 g/T}) (702 \text{ J/g}) = 0.58 \text{ E15 J/y}$$

ETR for natural concentration before entering purification plant

Embodied energy sum of sun, wind and river

$$\frac{(8.8 \text{ E20 SEJ/y})}{(0.58 \text{ E15 J/y})} = 1.52 \text{ E6 SEJ/J K in natural deposits}$$

ETR for refined KCl based on all inputs

$$\frac{(15.17 \text{ E20 SEJ/y})}{(0.58 \text{ E15 J/y})} = 2.62 \text{ E6 SEJ/J K}$$

$$\text{Per gram KCl} \frac{15.17 \text{ E20 SEJ/y}}{1.6 \text{ E12 g/y}} = 9.5 \text{ E8 SEJ/g KCl}$$

APPENDIX A16: AMMONIUM-NITROGEN FERTILIZER

Energy embodied in ammonia for fertilizer is estimated from its manufacture from nitrogen in the air using fuel. Embodied energy is calculated relative to the biosphere. Consequently, atmosphere nitrogen is taken as base line and given zero energy. See Figure A16 and Table A16.

Table A16. Embodied energy in one tonne of ammonia fertilizer.

Foot-note	Item	Actual Energy J/y	ETR SEJ/J	Embodied Solar Energy E13 SEJ/y
1	Fuel used	52.3 E9	6.6 E4	345.
2	Services \$128/T	-	1.64 E12 /\$	21.
3	Ammonia yield	2.17 E9	1.69 E6	366.

Footnotes to Table A16

1. Fuel used

52.3 E9 J coal/T (Mudahan 1982)

2. Services

\$128.T 1980 US\$ (Mohinder 1982);
Energy-dollar ratio from Appendix A4,

1.64 E12 SEJ/\$.

3. Ammonia yield

Gibbs free energy, 34.7 E3 J/mole (Anderson 1980)

$$\frac{(34.7 \text{ E3 J/mole})}{(16 \text{ g NH}_3/\text{mole})} = 2.168 \text{ E3 J/g NH}_3$$

$$(1 \text{ E6 g/T}) (2.168 \text{ E3 J/g}) = 2.17 \text{ E9 J/T}$$

$$\text{ETR: } \frac{(345 + 21) \text{ E13 SEJ/y}}{2.17 \text{ E9 J NH}_3} = 1.69 \text{ E6 SEJ/J}$$

per gram N,

$$\frac{(2.168 \text{ E3 J/g NH}_3)}{(14/16 \text{ g N/g NH}_3)} = 2.48 \text{ E3 J/g N}$$

$$(1.69 \text{ E6 SEJ/J}) (2.48 \text{ E3 J/g N})$$

$$= 4.19 \text{ E9 SEJ/g N}$$

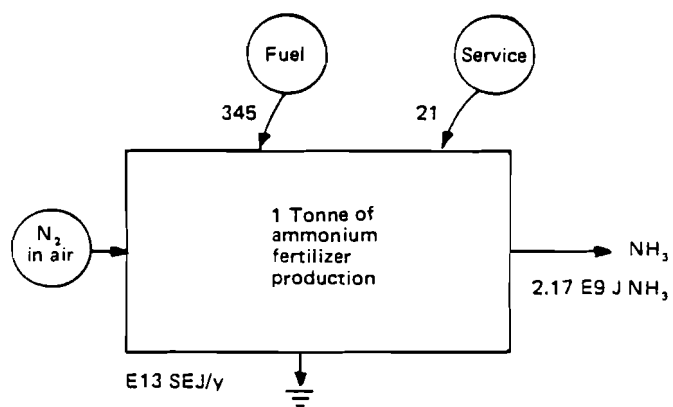

Figure A16. Energy diagram of ammonium fertilizer production.

APPENDIX A17: SUGAR CANE

Data from Ricaud (1980) on Louisiana sugar cane and net energy data on processing sugar to ethanol (Slesser and Lewis 1979) were diagrammed in Figure A17 and evaluated in Table A17. Energy transformation ratios were obtained.

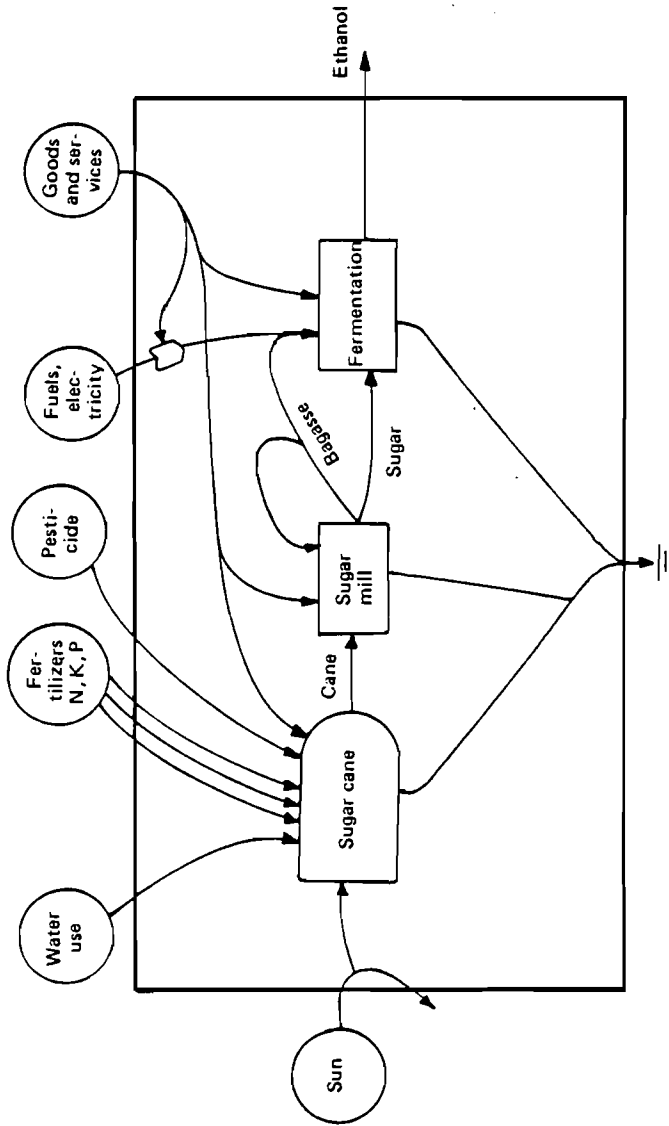

Figure A17. Sugar cane and sugar processing to ethanol.

Table A17. Energy flows in one hectare of sugar cane production in Louisiana using data from Ricaud (1980) and further processing to ethanol (Slesser and Lewis 1979).

Foot-note	Item	Actual energy J/y	ETR SEJ/J	Embodied solar energy E13 SEJ/y
1	Direct solar energy	6.5 E13	1	6.5
2	Water evapotranspired	9.16 E10	1.5 E4	138.0
3	Nitrogen	3.43 E8	1.69 E6	58.0
4	Potassium	5.25 E7	2.62 E6	14.0
5	Phosphorus	7.2 E6	4.14 E7	30.0
6	Pesticide	3.5 E9	6.6 E4	24.0
7	Direct fuels	2.15 E10	6.6 E4	142.0
8	Fuel in machinery	2.28 E9	6.6 E4	15.0
9	Services \$662/Ha (1976)	-	2.82 E12/\$	187.0
10	Sugar yield	7.33 E10	8.1 E4	593.0
11	Bagasse	9.7 E10	6.11 E4	593.0
12	Fuel use in sugar	1.36 E11	6.6 E4	897.0
13	Services	-	-	775.0
14	Electricity (oil equiv.)	1.19 E11 J/y	6.6 E4	785.0
15	Ethanol yield	5.05 E11	6.04 E4	3050.0

Footnotes for Table A17

1. Direct sun

$$(1.5 \text{ E6 kcal/m}^2/\text{y}) (1 \text{ E4 m}^2/\text{ha}) (4186 \text{ J/kcal}) = 6.5 \text{ E13 J/y}$$

2. Water evapotranspired

1870 mm, mean of 5 values given for India (Rao 1975)
(1400, 1500, 1750, 2200, 2500 mm/y)

$$(1.87 \text{ m}^3/\text{m}^2/\text{y}) (1 \text{ E4 m}^2/\text{ha}) (1 \text{ E6 g/m}^3) (4.9 \text{ J/g}) = 9.16 \text{ E10 J/y}$$

3. Nitrogen 158 kg N as ammonia; 2170 J/g

$$(158 \text{ E3 g N}) (2.17 \text{ E3 J/g}) = 3.43 \text{ E8 J/y}$$

4. 90 kg K₂O as 60% muriate

$$(78 \text{ 194 K}) (90 \text{ kg K}_2\text{O}) (702 \text{ J/g K}) (1 \text{ E3 g/kg}) = 5.25 \text{ E7 J/y}$$

Footnotes for Table A17 continued

5. 45 kg P₂O as 46% triple phosphate

$$(45 \text{ E3 g}) (0.46) (348 \text{ J/g}) = 7.20 \text{ E6 J/y}$$

6. Pesticide

$$(8.37 \text{ E5 kcal fuel /ha}) (4186 \text{ J}) = 3.5 \text{ E9 J/y}$$

7. Direct fuels

$$(5.14 \text{ E6 kcal motor fuels}) (4186 \text{ J/kcal}) \\ = 2.15 \text{ E10 J/y}$$

8. Fuels in machinery

5.46 E5 kcal fuel equivalent /ha

$$(5.46 \text{ E5 kcal/y}) (4186 \text{ J/kcal}) = 2.28 \text{ E9 J/y}$$

9. Services in cane production

1976: \$86 E6 on 1.3 E5 ha

$$\$86 \text{ E6} / 1.3 \text{ E5 ha} = \$662/\text{ha}$$

c, the correction for contribution of sugar to energy/dollar ratio is only 0.2%

$$c = \frac{\text{sugar use}}{\text{U.S. national energy use}} = \frac{(9.77 \text{ E12 g/y}) (4 \text{ kcal/g}) (4186 \text{ J/kcal})}{4.79 \text{ E24 SEJ/y}} \\ = \frac{1.64 \text{ E17 J/y}}{4.79 \text{ E24 SEJ/y}}$$

P = energy/\$ ratio, U.S., 1976 = 2.82 E12 J/\$

For sugar, use (P-C)

10. Sugar yield

$$(1.75 \text{ E7 kcal/y}) (4186 \text{ J/kcal}) = 7.33 \text{ E10 J/y}$$

$$\text{ETR} = \frac{615 \text{ E13 SEJ/y}}{7.33 \text{ E10 J/y}} = 8.39 \text{ E4 SEJ/J sugar}$$

Footnotes for Table A17 continued

11. Cane bagasse

$$(62.5 \text{ T/ha}) - (75 \text{ kg sugar/T}) (62.5 \text{ T/ha}) (1 \text{ E-3 T/kg}) \\ = 57.81 \text{ T}$$

$$(57.81 \text{ T}) (0.10 \text{ dry}) (4 \text{ E6 kcal/T}) (4186 \text{ J/kcal}) = 9.68 \text{ E10 J/y}$$

$$\text{ETR: } \frac{(138 + 58 + 14 + 30 + 24 + 142 + 186)\text{E13}}{9.7 \text{ E10 J/y}} = 6.11 \text{ E4 SEJ/J}$$

12. Fuel use in sugar and ethanol processing

$$8 \text{ E6 J oil/y/kg (Slesser and Lewis 1979)}$$

$$(8 \text{ E6 J oil/kg eth.}) (17 \text{ E3 Kg eth/y}) = 1.36 \text{ E11 J/y}$$

13. Service

Based on cost in excess of sugar cost (note #9) 1981 price of ethanol \$.27/liter (Goldemberg 1982); density, 0.85 g/cm³;

$$\frac{(\$0.27/\text{l}) (1 \text{ E3 l/m}^3)}{0.85 \text{ T/m}^3} = \$317 / \text{T}$$

1976 and 1981 prices for sugar similar (World Bank 1982)

$$(17 \text{ T eth/ha/y}) (317 \text{ \$/T eth. 1980}) - (\$662) = \$4727$$

$$(\$4727) (1.64 \text{ E12 SEJ/\$}) = 7.75 \text{ E15 SEJ/y}$$

14. Electricity

$$(7 \text{ E6 J oil equiv/kg}) (17 \text{ E3 kg/ha}) = 1.19 \text{ E11 J/y}$$

15. Ethanol yield

$$\text{(Slesser and Lewis 1979): } 17 \text{ E3 kg/ha/y}$$

$$(29.7 \text{ E6 J/kg eth.}) (17 \text{ E3 kg/ha/y}) = 5.05 \text{ E11 J/y}$$

$$\text{ETR: } \frac{(593 + 897 + 775 + 785)\text{E13}}{5.05 \text{ E11 J/y}} = 6.05 \text{ E4 SEJ/J}$$

APPENDIX A18: EARTH AND SOIL

As shown in Figure A18, the earth cycle brings up rock and other matter which is weathered into "earth"--the clays that go into soil. Then in a process that takes about 500 years--10 times faster (or more) than earth formation--a soil profile is developed ("Top soil"). When there is a steady state, there are contributions of rocks, of by products of weathering, of earth, and of topsoil passing down the rivers. Most of this does not leave the country, but goes into floodplains, deltas, etc. where new topsoil profiles form.

In evaluating the potential energy storages in this part of the earth cycle, the process is aggregated as in Figure A18 into two storages: earth and topsoil. For each of these there is an energy transformation ratio. Each is a valuable storage and if lost, valuable resource potential is lost. Evaluation of loss requires the outflow in excess of the formation rate of that material. See Table A18.

For purposes of a national analysis, earth erosion is not counted as a loss unless it leaves the country faster than it forms. For topsoil, however, erosion that destroys the profile is counted a loss if it is faster than the soil profile generation rate.

Note in the Figure that both formation processes are driven by the same embodied energy and some care may be required to avoid double counting for some purposes.

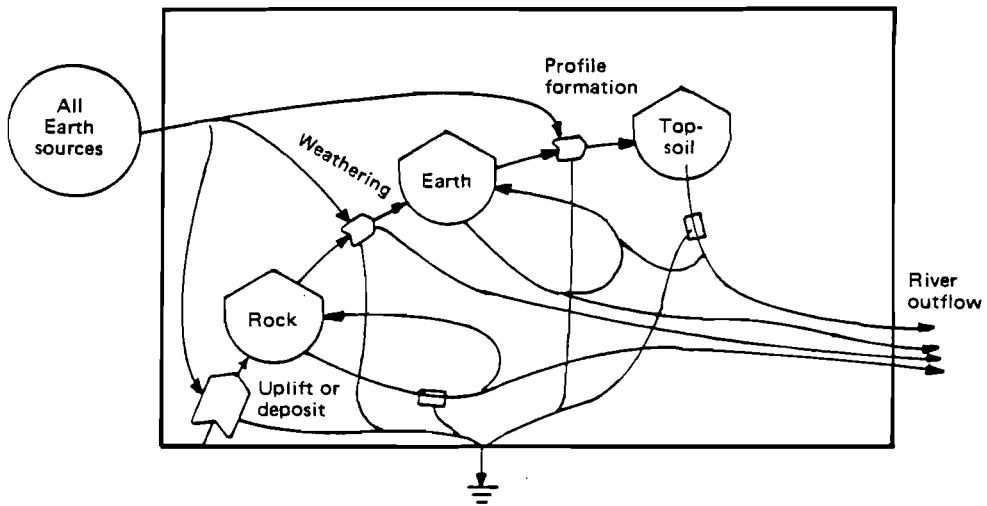

Figure A18. Diagram of earth and soil production and erosion.

Table A18. Evaluation of earth and topsoil process per square meter.

Foot-note	Item	Actual Energy J/y	ETR SEJ/g or SEJ/J	Embodied Solar Energy SEJ/y
1	"Earth" (clay products of weathering) 31.2 g/m ² /y	-	1.71 E9 /g	5.33 E10
2	Topsoil formation	8.54 E5	6.25 E4	5.34 E10

Footnotes for Table A18

1. "Earth" (clay products of weathering)

Average continental earth cycle rate, 2.4 cm/1000 y assumed in steady state with weathering and erosion. Following in Siegl (1874), after Krauskopf (1967), and Goldick (1938), about half of rock weight is lost during formation of the earth by-products.

Earth formation rate:

$$(2.4 \text{ E-5 m/y}) (2.6 \text{ E6 g/m}^3 \text{ density}) (0.5) = 31.2 \text{ g/m}^2/\text{y}$$

Energy transformation ratio per gram:

$$\frac{(8.0 \text{ E24 SEJ/y})}{(31.2 \text{ g/m}^2/\text{y}) (1.5 \text{ E14 m}^2 \text{ continent area})} = 1.71 \text{ E9 SEJ/g earth}$$

2. Topsoil formation

Organic mater used as index for actual organic matter; 3% organic matter for 45 cm profile (Brady 1974); time of formation: 500 years (Jenny 1980) when in natural vegetation.

Weight formed:

$$(.45 \text{ m}) (1.4 \text{ E6 g/m}^3) (0.03 \text{ organic}) (5.4 \text{ kcal/g}) (4186 \text{ J/kcal}) = 4.27 \text{ E8 J/m}^2$$

Actual energy flow in topsoil storage:

$$\frac{(4.27 \text{ E8 J/m}^2)}{(500 \text{ y})} = 8.54 \text{ E6 J/m}^2/\text{y}$$

$$\text{ETR: } \frac{(8.0 \text{ E}24 \text{ SEJ/Y})}{(8.54 \text{ E}5 \text{ J/m}^2/\text{Y}) (1.5 \text{ E}14 \text{ m}^2)} = 6.25 \text{ E}4 \text{ SEJ/J}$$

Elizabeth C. Odum
*Santa Fe Community College,
Gainesville, Florida*

Howard T. Odum
*Environmental Engineering Sciences
and Center for Wetlands
University of Florida,
Gainesville, Florida*

APPENDIX A19: CATTLE IN INDIA

With data given by Mitchell (1979) the system of cattle in India was evaluated including as products, dung, butter, milk, work of the bullocks, and calves (Table A19 and Figure A19). Labor was drawn from those being supported by the system and no net outside embodied energy of labor was assumed.

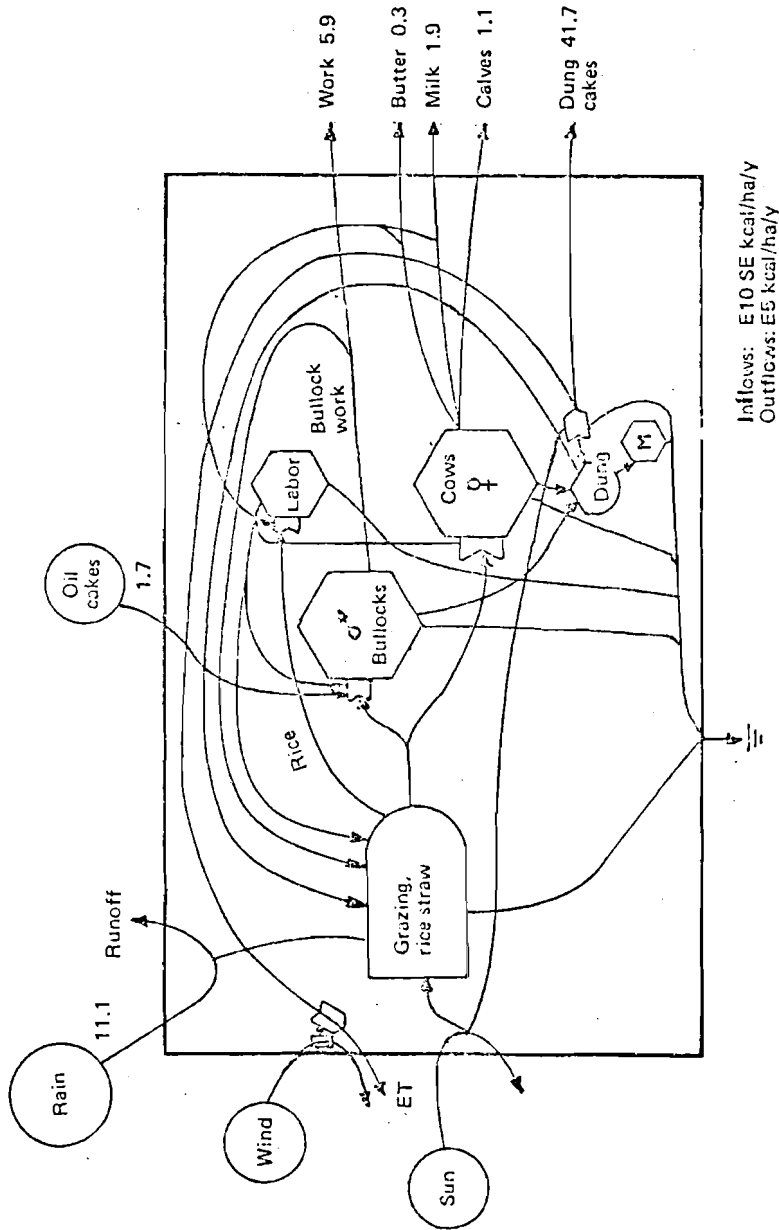

Figure A19. Energy flows in Indian cattle system per hectare.
M = microbes

Table A19. Energy flows in cattle-dung system in India on one hectare. See Figure A19. Data from Mitchell, 1979.

Foot-note	Item	Actual energy Kcal/y	ETR SE kcal/ kcal	Embodied Solar energy E10 SE kcal/y
1.	Direct sun	1.4 E10	1.0	1.4
2.	Water use: rain-runoff	7.4 E6	1.54 E4	11.1
3.	Straw, forage, grazing	2.57 E7	4.31 E3	11.1
4.	Bullock feed, vegetation	1.58 E7	4.31 E3	6.8
5.	Cow feed, vegetation	0.99 E7	4.31 E3	4.27
6.	Other food, mustard oil cake	6.36 E5	2.67 E4	1.7
7.	Bullock work produced	5.9 E5	1.46 E5	8.6
8.	Milk production	1.91 E5	2.2 E5	4.22
9.	Calf production	1.06 E4	4.0 E6	4.22
10.	Dung production	4.2 E6	3.0 E5	12.8
11.	Butter production	3.25 E4	1.29 E6	4.22
12.	Labor	-	-	-

Footnotes for Table A19

Data from Mitchell, 1979, unless indicated.

1. Sun

1.75 E10 kcal/ha/y, 0.20 albedo = 1.4 E10 kcal/ha/y.

2. Water use: rain - runoff

Rain: 1.05 m/y, runoff: 1.4 E12 m³/y (Rao 1975)

$$\frac{(1.05 - .43 \text{ m}^3/\text{m}^2)(1 \text{ E6 g/m}^3)(5 \text{ J/g})}{4186 \text{ J/kcal}} = 7.406 \text{ E6 kcal/ha/y}$$

Per hectare:

$$(740.6 \text{ kcal/m}^2/\text{y})(1 \text{ E4 m}^2/\text{ha}) = 7.406 \text{ E6 kcal/ha/y}$$

3. Straw, forage, grazing used by cattle

Grass production: 2.14 E7 kcal/ha/y; each cow ate 14.0 E3 kcal/day = 5.1 E6 kcal/y.
 $(5.1 \text{ E6 kcal/cow}) / (2.14 \text{ E7 kcal/ha/y}) = 0.24 \text{ ha for each cow} = 4 \text{ cattle/ha.}$

Sum of food used by 2 bullocks and 2 cows (Footnotes 4 and 5) = 2.57 E7 kcal/ha/y

Footnotes for Table A19 continued

$$\text{ETR: } \frac{11.1 \text{ E10 SE kcal/ha/y}}{2.57 \text{ E7 kcal/ha/y}} = 4319$$

4. Vegetation for 2 bullocks per hectare

$$(2)(2.17 \text{ E4 kcal/ind./d})(365 \text{ d}) = 1.58 \text{ E7 kcal/ha/y}$$

$$\text{Proportion of cattle food: } 1.58/2.57 = 0.62$$

5. Vegetation for 2 cows per hectare

$$(2)(1.36 \text{ E4 kcal/ind./d})(365 \text{ d}) = 0.99 \text{ E7 kcal/ha/y}$$

$$\text{Proportion of cattle food: } 0.99/2.57 = 0.38$$

6. Other food, mustard oil cake, mostly for bullocks

872 kcal/day/animal; 2 bullocks/ha

$$(872 \text{ kcal/day/bullock})(2)(365) = 6.36 \text{ E5 kcal/ha/y}$$

ETR for corn used.

7. Output of bullock work: 0.56×10^9 kcal/y for 3770 cattle.

$$[(0.56 \text{ E9})/(3770)](4) = 5.9 \text{ E5 kcal/ha/y}$$

Proportion of food used by bullocks: oil cake and 0.62 of vegetation.

$$(0.62)(11.1 \text{ E10 SE kcal}) + (1.7 \text{ E10 SE kcal})$$

$$= 8.6 \text{ E10 SE kcal/ha/y}$$

$$\text{ETR of bullock work: } \frac{8.6 \text{ E10 SE kcal/ha/y}}{5.9 \text{ E5 kcal}}$$

$$= 1.46 \text{ E5 SE kcal/kcal}$$

8. Production of milk: 0.18 E9 kcal/y for 3770 cattle.

$$[(0.18 \text{ E9})/(3770)](4) = 1.91 \text{ E5 kcal/ha/y}$$

food used 0.38 of total cattle vegetation

$$(0.38)(11.1 \text{ E10 SE kcal}) = 4.22 \text{ E10 SE kcal/ha/y}$$

ETR of milk production:

$$\frac{4.22 \text{ E10 SE kcal}}{1.91 \text{ E5 kcal}} = 2.21 \text{ E5 SE kcal/kcal milk production}$$

Footnotes for Table A19 continued

9. Production of calves: 0.01 E9 kcal/y for 3770 cattle.

$$[(0.01 \text{ E9}) / (3770)](4) = 1.06 \text{ E4 kcal/ha/y}$$

Food used 0.38 of total cattel vegetation;
4.22 E10 SE kcal/ha/y

ETR of calf production:

$$\frac{4.22 \text{ E10 SE kcal}}{1.06 \text{ E4 kcal}} = 3.98 \text{ E6 SE kcal/kcal calf production}$$

10. Production of dung: 3.93 E9 kcal/y for 3770 cattle

$$[(3.93 \text{ E9}) / (3770)](4) = 4.17 \text{ E6 kcal/ha/y}$$

ETR of dung production:

Total food: 12.8 E10 SE kcal/ha/y

$$\frac{12.8 \text{ E10 SE kcal}}{4.2 \text{ E6 kcal}} = 3.0 \text{ E5 SE kcal/kcal dung produced}$$

11. Butter production

4.5% butter fat in the milk; half removed to form butter;
9.4 kcal/g butter; 2.21 E5 kg milk per 1400 hectares.

$$\frac{(2.21 \text{ E8 g milk}) (0.047) (0.5) (9.4 \text{ kcal})}{1500 \text{ ha}} = 3.25 \text{ E4 kcal/ha/y}$$

ETR of butter:

$$\frac{4.22 \text{ E10 SE kcal}}{3.25 \text{ E4 kcal}} = 1.29 \text{ E6 SE kcal/kcal butter production}$$

12. Labor

Much of the labor is supported from within the system and is not a separate source of embodied energy.