

NOT FOR QUOTATION
WITHOUT PERMISSION
OF THE AUTHORS

ENERGY AND MINERAL RESOURCES DATA BASES

M. Grenon and A. Grüber, Editors

January 1983
CP-83-2

Papers presented at the Fourth IIASA Resources Conference,
co-sponsored by the Resource Systems Institute of the East-West
Center, July 9-14, 1979, Laxenburg, Austria

Collaborative Papers report work which has not been performed solely at the International Institute for Applied Systems Analysis and which has received only limited review. Views or opinions expressed herein do not necessarily represent those of the Institute, its National Member Organizations, or other organizations supporting the work.

INTERNATIONAL INSTITUTE FOR APPLIED SYSTEMS ANALYSIS
A-2361 Laxenburg, Austria

PREFACE

These proceedings contain a selection of papers dealing with energy and mineral resources data bases, given at the Fourth IIASA Resources Conference. This conference in fact was organized at the crossing of three different evolutions:

The first line of events was an IIASA series of Resources Conferences, aimed at a better understanding of world energy resources. The first conference, in 1975, was devoted to the Methods and Models for Assessing Energy Resources. The second one, in 1976, jointly organized with UNITAR, dealt with the Future Supply of Nature Made Petroleum and Gas; and the third, in 1977 in Moscow, covered Coal Resources (all of them published in the Pergamon Proceeding Series).

The second evolution was a growing concern at IIASA, and equally at many other institutions as expressed during these earlier Resources Conferences, about resource data collection, handling, processing and utilization. To build models is one thing; to feed them with the appropriate data is another.

Finally, it was clear that energy can be less and less isolated from other resources which are required for its development, such as water, land, human resources and, of course, mineral resources. Some new energy resources, such as solar, will be highly material intensive. This is just one example of the growing systems aspects between energy and minerals and/or materials.

All of these concerns led to the organization of this conference. In fact, it was organized as a two-part conference, the first (more technical) part on energy and mineral resources data bases, documented in this publication; the second* part on a related subject--the systems aspect of energy and mineral resources-- with the objective to provide a forum to discuss the increasing interdependencies and interrelations between energy and mineral resources, but equally to put the papers dealing with data bases in the right perspective: namely, that these data bases should not be considered isolated from each other, but rather from a perspective of integrative (or systems) studies of energy and mineral resources. This aspect and its resulting requirements for data base development is discussed in a number of papers contained in these proceedings.

Regarding these proceedings on Energy and Mineral Resources Data Bases, it is clear that the last years have seen a lot of interesting developments. Maybe the most important was that the first data bases were developed with their own software.

* Proceedings of the papers presented in the second part of the conference will not be published. Individual papers are available from IIASA on request.

It was, of course, suited to the special needs or concepts of the developer (not necessarily to those of the user), but very specific.

Today, many sophisticated Data Base Development Systems are commercially available, which permit us to concentrate more on the data itself than on their handling. Surprisingly, if we consider the enormous amount of studies which have been devoted during the last decade to the energy problem, only a few have dealt with energy resources--although these will shape any energy future--and still less to energy resource data bases. This apparent deficiency, as well as the time factor involved in design, development, implementation and continuous updating (i.e., the building and maintenance of such data bases is a long term activity), explains why we considered it useful to make the papers presented at this conference available to a broader public, despite a certain delay in the publication, which we sincerely regret. However, the data bases presented in these proceedings are practically all still actively pursued and accessible, and cover the most relevant developments in the field, so that the Editors hope that this publication constitutes a good contribution for assessing the state of development, and availability, of energy and mineral resources data bases. It should be considered less as an end point, than rather as a starting point.

Michel Grenon
Arnulf Grüber

Note: The Editors assume full responsibility for the selection of papers and for any editorial changes, which we hope did not change the substance of the papers presented.

ACKNOWLEDGEMENTS

We would like to thank Dr. Harrison Brown and Dr. Richard Sheldon of the Resource Systems Institute of the East-West Center, Hawaii, for their interest and support, and the co-sponsorship without which this joint conference would not have been possible.

Sincere thanks go equally to all contributors who helped in organizing all practical details without which no conference can be a success. They are too numerous to be mentioned here, but they can be sure that their assistance is greatly appreciated.



CONTENTS

	Page
PART 1: <u>GENERAL</u>	
Global Resource Assessment Methodologies <i>A.L. Clark, J.L. Cook and S.M. Cargill</i>	2
PART 2: <u>ENERGY AND NATURAL RESOURCES DATA BASES</u>	
Global Energy Resource Data Bases <i>A.L. Clark and J.L. Cook</i>	19
Enertree Data Base System <i>S. Medow</i>	36
The "Facility Data Base" a Process Information System on Energy Production and Conversion Facilities <i>A. Gräßler and M. Cellerier</i>	53
French Subsoil Data Bank. Objectives, Options and Facilities. State of Advancement of National Geo- logical Survey Product <i>P. Solety, J.P. Lepretre and L. Lheureux</i>	82
PART 3: <u>PETROLEUM DATA BASES</u>	
Oil Reserves in the Change of Politics, Technologies and Prices <i>M. Lorbach</i>	91
Some Questions about World Oil Resources and Data Bases <i>M. Grenon and S. Medow</i>	107
Petroleum Exploration Data Base of Petroconsultants <i>J.M. Lador</i>	125
Commercial Well and Production Systems in the United States: Implications for International Energy Data Bases <i>P. Stark</i>	141
STATSID: A Data Bank of Petroleum Statistics <i>M.S. Screeve</i>	159

PART 4: COAL AND URANIUM DATA BASES

- Recent Developments of IEA Research into World Coal Resources and Reserves 174
S.V. Duncan and G. Van Doorne
- A Data Base for Coal Mines 191
A. Astakhov, M. Grenon and A. Grüber
- A Description of the IAEA's Uranium Geology Information System 211
L. Trocki and M.V. Hansen

PART 5: MINERAL DATA BASES

- Global Mineral Resource Data Bases and National Mineral Resource Inventories 226
A.L. Clark and J.L. Cook
- The Production and Consumption of Non-Fuel Minerals to the Year 2000: Implementing a Global Input-Output Model and Data Base 242
S. Nasar-O'Brien
- The International Phosphate Resource Data Base, and its Role in Phosphate Resource Assessment 259
R.P. Sheldon and N.J. Bridges

PART 6: APPENDIXES

- Preparation of the IIASA-RSI Conference through Teleconferencing 276
A. Grüber and R. Sheldon
- List of Participants 282

PART 1

GENERAL

Global Resource Assessment Methodologies

Allen L. Clark, Jennifer L. Cook and
Simon M. Cargill

U.S. Geological Survey
Reston, Virginia 22092

The need to assess the present and potential adequacy of the global supply of energy and mineral resources has assumed critical importance both in developed and the developing countries. Because resource estimates are being used in critical decisions, it has become necessary to more clearly define the assessment methodologies, their data requirements, data dependencies, the quantitative accuracy of the resultant assessment, and to develop an interface between the assessments and economics. Six major assessment methodologies are commonly employed:

- 1) Areal value estimation: extrapolation of a representative estimated mean unit value to the region of interest.
- 2) Volumetric estimation: extrapolation from a representative estimated mean concentration of a unit volume to the volume of interest.
- 3) Abundance estimation: estimation of the amount of recoverable resource from a representative mean abundance through an empirical function.
- 4) Deposit modeling: estimation of resources in a specific geological environment based on the analysis of characteristics of known deposits in similar environments.
- 5) Delphi estimation: estimation of resources based on iterated collective opinion.
- 6) Integrated synthesis: a resource estimate based upon a combination of integration, or both, of some or all of the above methods.

The major assessment methodologies have been applied in several ongoing national programs or as part of pilot programs sponsored by International Geological Correlation Program project 98. Specific programs are: Areal value estimation (United States, South Africa, New Zealand, Canada, Australia, United Kingdom and Ireland, Mexico); volumetric estimation (United States, Mexico); abundance estimation (worldwide); deposit modeling (Canada, United States, Norway, Finland, Cyprus,

Turkey, Mexico); Delphi method (Mexico, United States, Canada); and integrated synthesis (Alaska, Canada).

To date resource estimates for both energy and minerals have been inadequate for use in national development planning, land-use planning, resource supply analysis, and particularly in econometric modeling.

The ultimate goal of a resource assessment is to provide a disaggregated estimate of resource potential in terms of quality, quantity, and location. The disaggregated results are critical if resource data are to be effectively utilized as input to models, such as the Clark-Drew Resource System Model, which attempts to integrate disaggregated data inputs into an occurrence model, a search model, and finally into an econometric model which produces an estimate of supply, through time, with various price assumptions.

INTRODUCTION

The ever increasing demand for a continuing supply of energy and mineral commodities to meet the world economies needs, for the short, intermediate and long term, has also resulted in an increasing demand for more and better reserve and resource information. This need for more information, with an attendant need for greater specificity with respect to the location, quality and quantity of reserves and resources, is necessitating the refining of old techniques and the development of new resource assessment methodologies.

At present a wide range of resource assessment methodologies are required because:

(a) Clear definitions of reserves and resources have been absent and as a result available estimates represent a mixture of the two. This mixture of reserve and resource data makes it's use difficult and of questionable value in most analyses.

(b) All resource assessment methodologies are highly data dependent and in the majority of cases insufficient data are available to support detailed resource assessments.

(c) The lack of adequate data and detailed resource assessments necessitates that resource estimates be highly aggregated. The highly aggregated nature of the estimates negates their use as basic inputs to econometric models.

(d) Insufficient data, on the tonnage, grade and size distribution of mineral and energy deposits, are available to apply resource assessment methodologies to frontier areas or areas of low geologic knowledge. As a

result resource assessments for large portions of the earth's surface are not possible.

Given all of the above problems, there still remains the need for the basic inputs of reserve and resource data to analyse short to long term mineral and energy supply. As a result of this need, six basic resource assessment methodologies, each of which gives a differing estimate because of the data used in the method, are commonly utilized and discussed in the subsequent portions of this paper.

RESERVE VS RESOURCE ASSESSMENT

Prior to the discussion of resource assessment methodologies, or resource estimates derived for the assessments, it is necessary to have a clear understanding of the concepts of reserves and resources. For the purpose of this discussion the authors use the reserve-resource definitions developed by the U.S. Geological Survey and the U.S. Bureau of Mines (U.S. Geological Survey and U.S. Bureau of Mines, 1976):

Resource - A concentration of naturally occurring solid, liquid or gaseous material, in or on the earth's crust in such a form that economic extraction of a commodity is currently or potentially feasible.

Reserve - That portion of the identified resource from which a useable mineral and energy commodity can be economically and legally extracted at the time of determination.

Within the general resource category two major subdivisions, based primarily on the level of geologic information, are defined:

Hypothetical Resources - Undiscovered resources that may reasonably be expected to exist in a known mining district under known geologic conditions.

Speculative Resources - Undiscovered resources that may occur either in known types of deposits in a favorable geologic setting where no discoveries have been made, or in unknown types of deposits that remain to be recognized.

An analysis of the definitions of reserves, and resources, (hypothetical and speculative) will clearly show that each category is highly data dependent and has a corresponding level of certainty which is a function of the data. These factors become of primary importance when reserve and resource estimates are used in analytical models which require reserve and resource data as a primary input. The relationship of the various reserve and resource categories and their relative economic and geologic certainty are shown in figure 1.

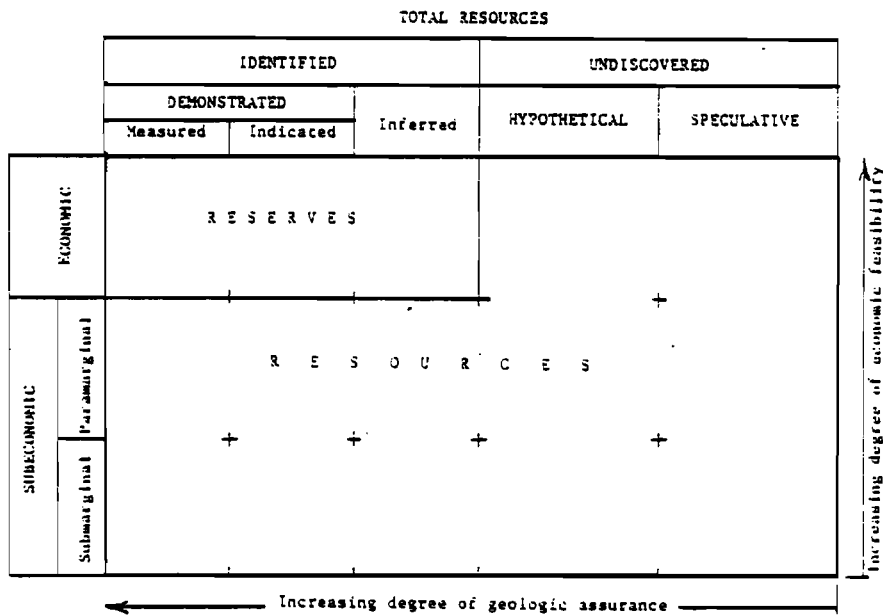

Figure 1. McKelvey classification diagram of reserves and resources.

The majority of economic models of mineral and energy supply have been based on reserve data as a basic input and only occasionally have analysts attempted to utilize resource estimates as a basic input. Events of the

1970's have, however, necessitated the analysis of long range resource supply in terms of geographic location, quality and quantity of the individual commodities. These analyses require both reserve and resource data as basic inputs; inputs which, particularly in the case of resources, were not available.

The need for more and better resource estimates resulted in the need to both better define and develop new resource assessment methodologies to provide the required estimates. The remainder of this paper deals with the most common resource assessment methodologies and attempts to show how the resultant resource estimates can be utilized in a resource supply system econometric analysis.

RESOURCE EVALUATION METHODOLOGIES

Recent times have seen a plethora of resource estimates which unfortunately have had one basic factor in common; the methodology by which they were made is normally unknown or poorly defined. In addition, the basic data used to arrive at the estimate are usually not available, for reasons of confidentiality, or were not maintained in an adequate data base. This lack of methodology definition and basic data utilized for the estimation is a major reason that resource estimates are not universally available either for specific areas or for individual commodities.

In an attempt to more clearly define the basic resource evaluation methodologies and the basic data elements required for each methodology the International Geological Correlation Program (IGCP) sponsored IGCP Project #98 "Standards for Computer Applications in Resource Studies." This program has resulted in two major publications (Cargill and Clark, 1977, 1978) which define the basic methodologies, data requirements and

and present several case histories and workshops on resource evaluations.

In a summary of resource assessment methodologies (Cargill and others, 1977, p. 211-220), six major methodologies were defined:

1. Areal Value Estimation - Extrapolation of a representative estimated mean unit value of a commodity, normally on the basis of mean unit value determined for a known region, to the region of interest.

2. Volumetric Estimation - Extrapolation from a representative estimated mean concentration of a unit volume to a corresponding volume of interest.

3. Abundance Estimation - The estimation of the tonnage of recoverable resource from a representative mean abundance through an empirical function.

4. Deposit Modeling - The estimation of resources in a specific geological environment based on the analysis of characteristics of known deposits in similar environments.

5. Delphi Estimation - Estimation of resources based on iterated collective opinion.

6. Integrated Synthesis - A resource estimate based upon a combination or integration, or both, of some or all of the above methods.

All of the above methodologies have been applied, and are still being used and modified to make resource evaluations. The choice of which method to use depends entirely upon the availability of data, manpower, and the reliability required of the estimate. Tables 1, 2 and 3 show these data requirements, manpower requirements and the relative reliability of the individual methodologies (numbered from 1-6 as above).

Table 1 - Data Requirements

<u>Data Elements</u>	<u>M E T H O D O L O G Y</u>					
	1	2	3	4	5	6
Resource Deposit Maps	D	-	D	E	D	E
Geologic Maps	D	D	D	E	D	E
Geochemical Maps	D	E	E	D	D	E
Geophysical Maps	D	D	D	D	D	E
Regional Resource Statistics	E	D	E	D	D	E
Scientific Background	D	D	D	E	E	E

E denotes essential item; D denotes desirable item (Cargill and Clark, 1977)

Table 2 - Manpower Requirements (Man years)

<u>Activity</u>	<u>M E T H O D O L O G Y</u>					
	1	2	3	4	5	6
Data Acquisition	0-1	1-5	1-5	20-100	1-5	20-100
Pre-processing	0-1	0-1	0-1	1-5	0-1	1-5
Analysis	0-1	0-1	0-1	5-20	1-5	5-20

(Cargill and Clark, 1977)

Table 3 - Relative Reliability

	<u>M E T H O D O L O G Y</u>					
	1	2	3	4	5	6
Relative Reliability	1	2	3	5	4	6

6 denotes most reliable; 1 denotes least reliable (Cargill and Clark, 1977)

Even the most casual review of tables 1, 2 and 3 will serve to demonstrate why it is so important, for anyone attempting to utilize resource estimates, to know the exact methodology utilized and the basic data used in the analysis. Table 4 is an attempt to summarize the strengths and weaknesses of the various methodologies; factors to be carefully weighed in evaluating the meaning and potential use of resource estimates. Although there are numerous weaknesses associated with all the resource estimation methodologies it must be emphasized that each method produces an estimate of resource endowment which, when used with the proper caution, provides at least part of the critical data required for analysis of long term resource availability. The present methodologies are rapidly evolving and more importantly the basic data are

Table 4 - Strengths and Weaknesses of Resource Estimation Methodologies

<u>METHODOLOGY</u>	<u>STRENGTH</u>	<u>WEAKNESS</u>
Areal Value Estimation	Methodology is simple to use for mineral resource planning, is applicable to any area of world, uniquely suitable for developed and developing countries, low cost with short time evaluation period.	Assumes that equal areas of the earth's crust are of equal value in resources, dependent on availability and accuracy of commodity data and requires the presence, and use of a reliable geologic map.
Volumetric Estimation	Methodology is simple to use and provides a useful guide with a minimum of data, is a standard method for gas and petroleum basin estimates, excellent for deposits with simple and uniform geometry.	Paucity of data used is not obvious to the uninitiated, assumes geologic similarity, indicates resource endowment similarity which may not be true.
Abundance Estimation	Method is quick, thorough, and gives a sufficiently reliable estimate for resource planning, method is easily updated with new data and relies on fairly accurate analytical inputs.	Technique only provides an estimate which can range up to 2-3 orders of magnitude times the expected value, extrapolation from small areas can compound errors and assumes a close genetic relationship between rock type and associated mineral deposits.
Deposit Modeling	Method incorporates all available data and includes geologic concepts, produces results reflecting the quality of the data and delineates exploration targets. Provides a disaggregated estimates.	Data for deposit models is limited and can cause the use of inappropriate deposit models, are highly data dependent and concentrates on well known deposit types.
Delphi Estimation	Method is quick and efficient and can be done at low cost. Universally applicable if experts are available, provides a disaggregated and commodity specific estimate.	Easy to introduce bias, tends to "pull" estimates toward a group mean, prone to manipulation and totally dependent on quality and experience of experts.
Integrated Synthesis	Incorporates all available data, concepts and experts; provides a disaggregated, commodity specific estimate, and normally useful in definition of exploration targets and resource policy analysis.	Expensive and time consuming, requires a large quantity of basic data, only locally applicable because of data requirements requires complex skill mix of personnel.

being compiled which will enlarge their applicability and increase their reliability. Examples of ongoing resource evaluation programs are summarized in the following section.

RESOURCE ESTIMATION PROGRAMS

During the last five years a large number of local or national resource assessment programs have been initiated and are either in progress or have been completed. The majority of the programs utilize one or more of the major methodologies previously described. Among the many programs underway or completed the most significant are: Areal Value Estimations of Alaska, South Africa, New Zealand, Mexico, Venezuela, and Israel; Volumetric Estimations of the United States, Canada, Mexico, and Venezuela; Abundance Estimations of Canada, United States, and on a global basis; Deposit Model Evaluations of Canada, Finland, Cyprus, and the Caledonian region; Delphi Estimations in Mexico, Canada and United States and Integrated Synthesis Analysis of Alaska.

Although the individual methodologies are equally applicable to mineral and energy deposits, the majority of published literature deals with the resource assessment of minerals. Nevertheless, major programs of resource estimating for oil and gas are either underway or planned in all the major oil producing areas of the world. All of these programs are producing vital data on resource endowment; however, the utility of the resource data is largely dependent on whether the resource estimation is given in an aggregated or disaggregated form.

AGGREGATED AND DISAGGREGATED RESOURCE EVALUATIONS

The use of a resource estimate is in large part determined by the form, aggregated or disaggregated, of the estimate. The majority of historical estimates are of the aggregated form, i.e., a statement of total resource

without any definition of location or number of deposits. Recent attempts at resource estimates have been directed toward the development of disaggregated estimates which define, normally within a probability range of .95 to .05, the number, location, quality and quantity of the resource being estimated.

Aggregated resource estimates have the advantage of being relatively easy to perform and do not require the high levels of basic data required by disaggregated estimates. In addition, they are also quite easy to update, as new data are acquired, because they normally do not require a change in the assessment methodology. The stability of the assessment methodology, with respect to new data inputs, also means that the aggregated assessment techniques are rather universally applicable.

The ease of analysis, minimum data requirements, relative data insensitivity and universal applicability accounts for the wide-spread use of aggregated resource estimation procedures. These factors; however, also limit the use of the resource estimates for many applications and has been largely responsible for the recent efforts to develop disaggregated resource estimates. It should be emphasized; however, that aggregated resource assessments are of great value in that they provide the basic framework, an estimate of the total resource, within which disaggregated estimates are applied. Therefore, aggregated estimates are of great value and can be utilized in the following analyses.

First, and perhaps most important, is that aggregated estimates can be effectively utilized to define the resource potential of a large region, or in some cases, a world-wide estimate which can be used for the analysis of long range global availability of mineral and energy resources. Although

such analysis clearly have a wide range of uncertainty, possibly several orders of magnitude, they are nevertheless exceedingly valuable in determining long range need for considering substituteability for certain commodities or for selection of large areas for exploration and development. In the latter case, an abundance estimate, when compared against known resources of an area, can define whether an area is effectively explored for certain commodities, when the known resources essentially equal the estimated resources, or whether more exploration is required because the known resources are considerably less than those estimated.

Secondly, aggregated estimates may in some cases be more applicable than disaggregated analyses. Specifically, many of the global resource models require highly aggregated estimates of resources in order for the resource estimate input to the model to be similar to other aggregated inputs of populations, environment, food and water.

Third is the fact, which is often overlooked by the scientific community, that for the majority of policy questions, pertaining to resource availability, the decision maker is best served by an aggregated estimate. Particularly if such an estimate is robust with respect to new data inputs and is easily and quickly produced with respect to multiple policy options.

Although aggregated estimates are valuable, and many times the only estimates available, the ideal situation is when aggregated estimates can be produced by the summation of disaggregated estimates. Disaggregated estimates normally require larger volumes of more accurate data, are time consuming and personnel intensive and the resultant analyses have a much broader spectrum of applicability. Because a disaggregated estimate attempts to define a commodity in terms of it's number, location, quality and quantity

the resultant estimation can be used in:

- (a) Local, regional, and national resource assessment programs.
- (b) For the development of short, intermediate and long range exploration and development programs.
- (c) Both regional, national or global resource models in an aggregated or disaggregated form.

Perhaps the most important attribute of a disaggregated resource estimate is that it is a defined, quantitatively defensible input, based upon fundamental geologic principles, observations, data and analyses, to an econometric model of a resource supply system.

CLARK-DREW RESOURCE MODEL

The integration of disaggregated resource estimates into an econometric model for resource supply is shown in the Clark-Drew Conceptual Model of a Resource Supply System (figure 2). The Clark-Drew model (Clark, 1977, p. 231-233) shows both the sequence of analysis for a disaggregated evaluation but also how the individual models (Occurrence, Search and Production) can be aggregated to produce a national estimate.

The preliminary phase of the Clark-Drew model requires an extensive and complete data base to support the resource estimate. This is necessary because the initial input to the model is an empirically-determined deposit model analysis to determine deposit size, quality and quantity, for a single commodity, for individual regions or areas. Following the initial deposit model estimation, normally from a known area, it is necessary to extrapolate the distribution of deposits in the known area to another lesser known or frontier area. This is normally done on the basis of the geologic anomalies which can hopefully be defined as the result of a prior assessment program.

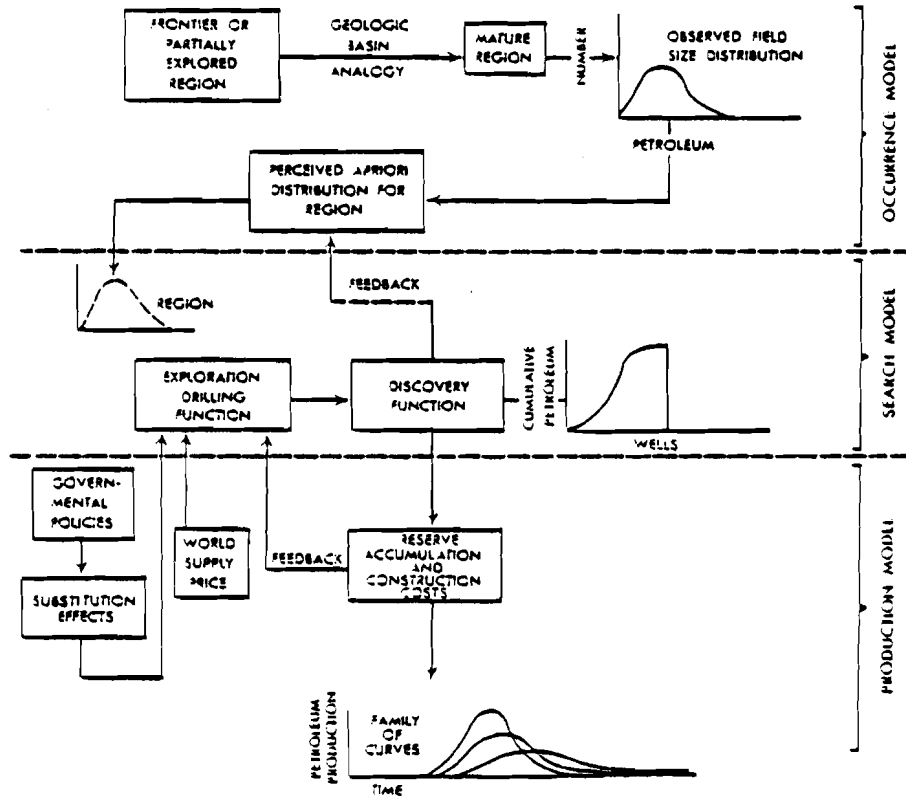

Fig. 2 : CLARK-DREW CONCEPTUAL MODEL OF PETROLEUM SUPPLY SYSTEM

The deposit model evaluation forms the basic input to the search model and specifically to the exploration submodel. These analyses in turn provide the fundamental inputs to the production model to determine the supply functions based on economics and time.

The Clark-Drew Model represents the present trend in resource evaluations, i.e., to produce an estimate which not only accurately evaluates the potential resource supply, in terms of location, quality and quantity, but also serves to integrate such estimates into econometric models of supply. It is this integration which optimizes the use of resource evaluations for policy analysis and national and international resource assessment and development.

CONCLUSIONS AND RECOMMENDATIONS

The field of resource assessment is rapidly evolving and resource estimates are being made with respect to geographic areas and specific mineral and energy commodities. However, because the resource assessment methodologies are highly data dependent, and in most cases basic data are not available, the resultant estimates are highly aggregated. The highly aggregated nature of the estimates seriously constrains their applicability in a wide range of economic analyses and in resource policy decision making.

Recent developments, primarily in the deposit modeling methodology, has allowed resource estimates to be utilized in resource supply studies such as those outlined in the Clark-Drew resource supply model. With an increasing specificity of resources, with respect to location, quality and quantity, and size distributions, the Clark-Drew resource supply model can be applied on an international basis and will be valuable in determining

long range supply based on resource estimates.

The development of disaggregated resource estimates, required by the Clark-Drew model, however, is a time consuming, data and personnel intensive activity. There is, however, an immediate need for resource estimates which can be used in global analyses on an aggregated basis. To meet this need the authors would recommend that an international program be undertaken to produce abundance and unit regional value resource estimates on a global scale. Although such a program appears to represent an enormous undertaking, indeed it is large, a great number of analyses are already available on a country by country, and in some cases, continent, basis. It is recommended that those studies be compiled and that estimates be made for areas where estimates are not available.

The development of global resource estimates, by the abundance and unit regional value methodologies, would provide an orders of magnitude estimate of ultimate resource availability; highly aggregated but valuable estimate to establish a framework of resource availability. Once these estimates have been made, and the basic data gathered, they will serve as the basis for more detailed and disaggregated estimates.

The need for more and better resource estimates is one of the most critical problems facing the geologic profession today. The short to long range supply of energy and mineral commodities is a major constraining factor for the development and well being of both the developed and developing nations. This shared need for resource estimates mandates that global resource assessments be undertaken for the good of all mankind.

REFERENCES

- Cargill, S.M. and Clark, A.L., eds., 1977, Standards for Computer Applications in Resource Studies, Jour. of the International Assoc. for Mathematical Geology, Vol. 9, No. 3, 337pp.
- Cargill, S.M. and Clark, A.L., 1978, Standards for Computer Applications in Resource Studies, Jour. of the International Assoc. for Mathematical Geology, Vol. 10, No. 5, 642pp.
- Clark, A.L., 1977, Guidelines for International Data Collection and Resource Assessment and Analyses, in "Standards for Computer Applications in Resource Studies" Cargill, S.M. and Clark, A.L., eds., Jour. of the International Assoc. for Mathematical Geology, Vol. 9, No. 3, p 221-233.
- McKelvey, V.E., 1972, Mineral Resource Estimates and Public Policy: American Scientist, Vol 60, No. 1, p 32-40.
- U.S. Geological Survey and U.S. Bureau of Mines, 1976, Principles of the Mineral Resource Classification System of the U.S. Bureau of Mines and U.S. Geological Survey, U.S. Geol. Survey Bull. 1450-A, p A-1-A-5.

PART 2

ENERGY AND NATURAL RESOURCES

DATA BASES

Global Energy Resource Data Bases

Allen L. Clark and Jennifer L. Cook

US Geological Survey
Reston, Virginia 22092

The assurance of a continuing source of energy, to meet the needs of the developed and developing countries, is one of the most critical problems facing the world today and in the future. This problem has led to a world-wide effort to compile available data on the reserves and resources of the energy materials (oil, gas, coal, uranium-thorium and geothermal). Major global compilations of energy data have been ongoing for several years, and many new activities have been initiated within the last five years. The most significant of these energy data bases are:

- Bibliographic - Petroleum Abstracts (USA), Georef (USA), GEODE (France), CISTI (Canada), and Geoarchive (UK).
- Geologic/Exploration - Well history control system, Petroleum Data System, International Offshore Drilling Activity, World Data Bank II, Volcano Data File, Heat Flow File, GEOTHERM (USA), Lexis Well File, Lexis International Field Record File, Lexis Concession File (Switzerland), World Coal Resources and Reserve Data Bank (UK), Uranium Information System (Austria).
- Production - Petroleum Data System, National Geothermal Information Resource, Geotherm, Dow Jones News/retrieval (USA), World Coal Resources and Reserve Data Bank (UK), Uranium Information System (Austria).

Vast majorities of energy resource data reside in the archives of private corporations or national energy agencies and are as a result not available for compilation into existing energy-related data bases.

Recent activities in southeast Asia are illustrative of the methodology employed to index, archive, and utilize oil and gas data in the development of an energy data base, in an area of relatively new oil and gas production. The single greatest problem is the preservation of the original data once the preliminary evaluation of resource and production potential has been determined. The second major problem is the preservation of physical samples, core, and well cuttings, which will be required at a later date for analysis and geologic correlations.

The capture of these two types of data represent a common problem both in the developed and developing countries and require immediate action by the nations concerned.

Major problems exist in correlating and utilizing energy data contained within the various global files, particularly in terms of oil and gas, because of a lack of standards in terms of reserve and resource definitions, unique geographic identifiers, basins, and other geologic factors, and ultimately there is a need for a standardized base map upon which resource data can be correlated. In addition to the basic problems of definitions and standardization, considerable care must be taken in the use of historical data that was compiled for a totally different purpose than use in today's resource assessment programs.

INTRODUCTION

The events of the 1970's, in particular the rapid price rise of crude oil and worldwide spot shortages of oil and gas, have clearly shown the need for more extensive and reliable energy information. The demand for energy information is not confined to the importing nations, who need data for analysis of supply, but is also required by the exporting nations who must plan their national economics on world demand and their potential resources to meet worldwide demand. Nor is the need for energy data confined to the conventional energy sources such as oil, gas and coal but also to a wide range of non-conventional resources such as geothermal, oil shale, uranium, solar, tidal and wind. It is now accepted that to meet the world's demand for energy that future energy supply must come from a mixture of both conventional and non-conventional energy sources. Therefore, there is both a large need and a large activity in the field of energy resource data to supply the basic information required for resource planning.

Because of the tremendous scope of energy related activities it is not possible to address all the areas as all the activities within even the areas to be described in this paper. Therefore, the authors will concentrate only on a description of the major computer based energy data files which are related to the conventional energy sources, i.e., oil and gas, coal, uranium and thorium, geothermal and oil shale.

ENERGY RESOURCE DATA DEFINITIONS

It is absolutely essential that a common language be used to identify all the various sources and kinds of energy commodities and the units by

which they are described. The basic definitions, pertaining to energy reserves and resources, have been set forth by the U.S. Bureau of Mines and the U.S. Geological Survey (1976) and have been incorporated in a classification intended for oil and gas (U.S. Federal Power Commission, 1976) and the two classifications have been modified and summarized by Meyer (1978). In particular, the definitions of resources and reserves are critical to this discussion and are as follows:

Resources - A concentration of naturally occurring solid or liquid petroleum or petroleum-like material, natural gas, or other energy commodity, in or on the earth's crust in such form that economic extraction is currently or potentially feasible. The resource includes all the material in place in a deposit.

Reserves - That portion of the identified resource from which a usable mineral or energy commodity can be economically extracted at the time of estimation. Such commodities include, but are not necessarily restricted to petroleum, condensate, natural gas, tar sands, oil shale, coal and naturally occurring asphalt, without regard to mode of occurrence.

Normally, an energy resource is described by its location, quality and quantity and in this paper data bases, defined as single files or a group of individual files, are emphasized that contain these three main descriptions.

STATUS OF ENERGY RESOURCE DATA BASES DEVELOPMENT

The need for more extensive and reliable energy resource information has led to an explosive growth of energy resource data bases. Unfortunately, this rapid growth has not been able to meet even the present need for data and certainly is not adequate to meet future needs. There are at least

five major reasons for the inadequacy of present data bases for energy information:

1. Although the present need is clearly recognized, past data acquisition and storage programs were inadequate to provide the historical data needed to support present data requirements.

2. Data base development has been sectionalized and institutionalized to the point that very few coordinated programs have been undertaken. This has greatly reduced the efficiency of data capture activities and has resulted in a large duplication of effort.

3. The total cost of developing adequate energy resource data bases was greatly underestimated in terms of effort, personnel required and money. In particular, the generation of new data has proven to be particularly costly.

4. Many present day programs and the majority of historical programs were not designed to provide the basic data that is presently required for energy studies. This is particularly true with respect to energy supply which was historically not regarded as a problem.

5. In addition to the four problems discussed previously, a major deterrent to the development of energy resource data bases that meet present data needs is the fact that there is very poor communication between the individuals that build the data base and those that use them. The former being physical scientists and the latter primarily economists and resource analysts. The result has been the collection of the wrong type of data for many present needs.

Because of the above reasons, and many others of equal or less importance, the majority of present energy resource data bases are inadequate to meet

present needs for the analysis of short, intermediate and long term energy supply, substitution and alternate energy alternatives. Regardless of the present inadequacies in energy resource data systems the majority of data bases are being rapidly improved.

INTERNATIONAL ENERGY RESOURCE DATA BASES

The following brief descriptions of the major energy resource data bases is not intended to be exhaustive but does present the spectrum of activities in the private, institutional and governmental agencies of the world.

International Field Records File - The International Field Records^{*} file is a commercial oil and gas fields file that was created as a result of a massive data collection effort by PETROCONSULTANTS, S.A. in 1978 on all the world's oil and gas fields outside of the United States and Canada. Each field includes reservoir data, character data, production data, reserves data, general data and a map and cross-section. New fields are added quarterly to update the file and keep it current. The intended applications for the file are: comparative basin research, investigations of productive areas previously considered marginal, and evaluation of specific exploration projects. The file is available in hard copy or computer tapes with updating and selection programs optional.

Petroleum Data System (PDS) - PDS, created and maintained by the University of Oklahoma, contains all field and pool information in the U.S.A. and Canada which is publically available (PDS,1979). Data on over 80,000 fields and reservoirs are contained in ten computerized PDS data bases:

TEXS: Data on all fields and reservoirs in Texas.

OILY: Data on all fields and reservoirs in the U.S. outside Texas.

CNDN: Data on most Canadian fields and reservoirs.

* This data base is presented in more detail in the paper by J.M. Lador in Part 3 of these proceedings [note by the Editors].

GANL: Natural gas analysis by field.
 COIL: Data on crude oil analysis by field.
 SECR: Data on Texas secondary recovery projects.
 FM15: Data on FPC Form 15 natural gas reserves.
 FEAR: Data on 60 largest U.S. oil and gas reserves.
 CHST: Data on Province Alberta production and injections for
 years 1962-1977.

Annual and cumulative production is identified within PDS by state, regulatory district, geologic basin or province, county, on-shore/offshore, and section, township and range. Other data elements include geologic age of reservoir, trap type, area, reservoir thickness, porosity, permeability, temperature, pressure, lithology, fluid analysis, field status, number and status of producing wells and field reserve data. PDS is now widely regarded as the general source for searching vast amounts of oil and gas data in North America and is commercially available on the General Electric Mark III computer network.

Well History Control System (WHCS) - WHCS^{*} is operated by the Technical Services Department of the Petroleum Information Corporation (PI, 1978). As of March, 1978, the WHCS file included data on more than 1,024,000 U.S. wells. All wells drilled since 1972 are included plus selected workover activity.

The WHCS contains seven major categories of data: heading information, tops and bases, initial potential and production tests, core data, drill-stem and wireline test information and miscellaneous data.

PI has divided the U.S. into ten geographic regional files, each of which includes some unique data characteristics but all follow uniform

* presented in detail in the paper by P. Stark in Part 3 of these proceedings [the Editors]

formats and useage.

Standard information searches can be made on the WHCS files to produce any logical combination of data required. The production of computer maps, e.g., contour, structure, show, initial potential, or penetration maps, is an advantageous method of well data display offered by PI.

International Uranium Geology Information System (INTURGEO)^{*} - The International Atomic Energy Agency (IAEA) has been acquiring a great amount of geologic and related uranium data in their current participation in the International Uranium Resources Evaluation Project (IUREP) and other of their activities. IAEA desired carefully designed computer files to easily handle, store and retrieve their uranium data so four files were created to make up the INTURGEO system (McCammon, et al, 1978):

1. Regional Reference File (RRF) - contains geologic, production and resource information for prescribed areas.
2. Exploration Activity File (EAF) - contains exploration information for survey areas.
3. Uranium Deposit and Occurrence File (DOF) - contains geologic, production and resource information of specific deposits and occurrences.
4. International Uranium Summary File (ISF) - contains resource production and demand information compiled at national levels.

Deposit models can be built by the integration of information selectively retrieved from the four files. The comparison of the deposit model characteristics with the characteristics contained in the regional reference file will provide the basis for more systematic resource appraisals.

* Presented in the paper by M. Hansen and L. Trocki in Part 4 of these proceedings [the Editors]

World Coal Resources and Reserves Data Bank Service (WCRRDBS)^{*} - the WCRRDBS (Gregory, 1977) has been created to maintain coal data for the International Energy Agency Coal Board for resource and reserve assessments of global and regional coal supplies. The computerized system consists of raw data storage in a data file and processing is done by three system modules:

1. "Exclusion module" - utilizes environmental and social constraints as data for recovering coal.
2. "Mining module" - utilizes operating costs and tonnages relative to different mining techniques.
3. "Marketing module" - utilizes "Mining module" output to provide pithead prices, operating costs and reserve selection by assessing the influence of different markets for the recovery of coal.

The overall aim in the inter and intra-variability of the modules is to accommodate regional factors and alternate mining, environmental and social assumptions in the extraction and marketing of coal and yet to provide a standard to compare coal reserves on an international basis.

WCRRDBS has been in the USGS PACER- GRASP (Bowen and Botbol, 1975 and Cargill, et al, 1976) system but is being partially moved to the Honeywell Multics Relational Data Store (MRDS) data base system (Honeywell, 1977) at the USGS to ease access, handling and updating.

Natural Resources Data Bases (RDB's) - the RDB's^{**} of the International Institute of Applied Systems Analysis (IIASA) Energy Resources Group regroup Data Bases on global conventional and unconventional oil and gas resources and Data Bases on natural resource requirements of energy resource production and conversion processes.

* further development of this data base is presented in the paper by S. Duncan and G. Van Doorne in Part 4 of these proceedings [the Editors]

**presented in detail in Part 2,3 and 4 of these proceedings [the Editors]

Geothermal Resource Data Base: GEOTHERM (Herr, et al, 1977)- The GEOTHERM file consists of approximately 4,000 records relating to the location, exploration, evaluation, and use of geothermal energy resources. Each record contains descriptive and numeric information on a set of attributes that describe and characterize the various aspects of geothermal energy and resources such as: location, surface thermal sample, well or drill hole, steam vapor sample, water sample, isotopic and engineering data.

Oil Shale Data Analysis Program - According to Meyer (1977) the oil shale data file of the US Geological Survey consists of approximately 300 drill cores, mainly from Colorado, USA. Each drill core is divided into intervals. The number and thickness of each interval varies with the lithology of the formations encountered and the total length of core. The total number of intervals ranges from one to about 2,5000. Each interval contains Fischer assays (oil, water, gas and spent shale). At present the file has approximately 1 million separate intervals in 80,000 entries.

Although the data bases described above represent the major international data bases, which are either being produced as a result of international cooperation or are privately produced but are available from private industry, of aggregated data on a specific subject the list is by no means all inclusive. Specific mention must be made of the bibliographic data files which contain the inventory of available reference sources which can be used to produce energy related data files. Within this category the most important are Petroleum Abstracts (USA), GEOREF (USA), GEODE (France), CISII (Canada) and GEOARCHIVE (UK).

In general, all of the bibliographic data bases mentioned above provide essentially the same services, i.e., selected retrievals of energy related data based on selected subjects. However, considerable variation exists in the level of search definition, quantity of indexing and cross-referencing, keywording and abstracting. Nevertheless, they all represent an excellent source of energy data and should not be overlooked, as they too often are, in the definition and development of energy data bases.

DATA BASE APPLICATIONS TO GLOBAL MODELING

Energy resource data represents a critical input to the majority of global models presently being used or developed. In general, there have been three major problem areas, with respect to energy data in its applicability to global models.

First, is the lack of accurate and complete knowledge of the world's energy reserves. This is true both with respect to oil and gas and the other alternate energy sources. This lack of basic reserve data has led, of necessity, to the use of highly subjective reserve estimates, or incomplete data sets, in global resource models. The result has been the inability to adequately predict the supply or energy mix available for short to intermediate analyses.

Secondly, is the lack of accurate and complete resource data for any of the energy sources which has resulted in the use of even more subjective data sets than those used with respect to reserves. In addition, the problems in resource estimation are much greater than in reserve estimation. The lack of complete and accurate reserve estimates is in large part resolvable with money, effort, and international cooperation. Resource estimates however, are dependent in most cases on first, an adequate knowledge of reserve data, and,

secondly, on data and analysis techniques which are not yet available to produce the basic information required for analysis.

Third, and perhaps most critical, is the fact that very few global models, which require energy data as inputs adequately account for the problems of economics, exploration process, lag times and infrastructure constraints on the availability of supply derived from reserves and resources.

SOURCES AND COMPILATION OF ENERGY DATA

That the development of a comprehensive and accurate energy data base is dependent on the availability of complete and accurate data is axiomatic and yet is a fact that is too often overlooked by those individuals that require data. It is a common assumption that the required data are available and all that is required is to compile it into a data base. Experience has shown that this is simply not the case for the following reasons:

1. A vast amount of data have been lost because of adequate historical archiving. This includes text, graphic and physical data such as core and chip samples.
2. Many of the data are "Confidential" for a host of reasons, some valid and many only the result of policy, and therefore not available to the data base compiler.
3. Much of the data needs yet to be derived from existing data, i.e., reserve and resource estimates from existing analytical and engineering data.
4. Peculiarly, a great amount of data are not available because they are too new, e.g., the reserves and resources of the oil discoveries in offshore Mexico, geothermal resource potential of Thailand and Indonesia and the uranium resource potential of uraniferous granites.

Regardless of the fact that a large amount of energy related information

is not available, for the reasons cited above, there are numerous other sources of energy data. The primary sources of such data, excluding the international data bases mentioned previously, are the numerous independent institutions and private industry. The problem, however, is how does this information find its way into energy data bases for use in global resource assessments and models. Two examples serve to illustrate the procedure for ultimately acquiring required energy data, i.e., oil and gas data storage and handling program of the CCOP countries and the alternate energy supply study of the United States and participating countries.

CCOP Program - The Committee on the Coordination of Offshore Mineral Prospecting in Southeast Asia (CCOP) serves as a coordinator of resource activities within the CCOP countries of Thailand, Malaysia, Indonesia, Papua New Guinea, Vietnam, Campuchea, Phillipines, Korea, Japan, Singapore and the Trust Territories where there is at present a great deal of oil and gas related activity.

The problem addressed by CCOP was one of storage, retrieval and utilization of petroleum data which was in response to a recognized set of problems almost identical to those described at the beginning of this section. Through a contract with COGEODATA (Committee on Storage, Retrieval and Processing of Geologic Data) an assessment of the size and scope of the problem was evaluated and a sequential program developed to ultimately create an integrated data base system which would provide the data and analyses required to define the location, quality and quantity of oil and gas, initially on a national basis, within the CCOP countries. The principle components of this system are:

1. Initial data archiving (including acquisition logs, indexing, key wording and abstracting) and storage.

2. Development of an integrated data base system beginning with a well file and the subsequent development of an oil and gas pool file and ultimately a basin file.

3. Implementation of hardware and software for analyses of data and development of oil and gas reserve and resource estimates.

The proposed program is based on mini- and micro computing capabilities and represents a much needed procedure for the majority of developing countries to begin the storage, retrieval, and analysis of oil and gas reserves and resources although such programs are initially for individual country use it is hoped that once the data are available it will be in the national interest to make at least a portion of the data available for the world communities use in resource modeling.

Another example of a major international energy resource program is the Department of Energy - US Geological Survey's program on Energy Assessments in Developing Countries. This program is pursuant to the Non-Proliferation Act of February, 1977 in which President Carter initiated a series of pilot programs aimed at assisting developing countries to meet their future energy needs. With indigineous energy resources and appropriate energy alternatives the program has as a primary component the development of national inventories of conventional and non-conventional resources. Pilot programs have been conducted in Indonesia, Pakistan, Turkey, Egypt, and Peru and follow-on studies are underway in the latter two nations.

These examples serve to demonstrate the national, regional and international scope of energy resource studies presently underway. However, these and many more programs will need to be undertaken before an adequate knowledge base is developed.

CONCLUSIONS

A clear need has been identified for more comprehensive energy and energy-related data to be sought, collected, standardized and compiled into computerized energy resource files and data bases on both a regional and global basis. Energy data that already exists in other forms need also to be gathered, carefully reviewed and sifted for pertinence to modern energy studies, standardized and added to data bases.

The number and size of the energy data bases currently being created are growing exponentially and the techniques for energy resource assessment are evolving just as rapidly. This calls for great care in coordinating the data need for resource assessment and supply analysis with the structure and content of the data bases. Currently many major problems exist in correlating and utilizing energy data contained within the various global files, particularly in terms of oil and gas, because of a lack of standards in terms of reserve and resource definitions, unique geographic identifiers, basins and other geologic factors. Ultimately, there is also a need for a standardized base map upon which resource data can be correlated. In addition to the basic problems of definitions and standardization, considerable care must be taken in the use of historical data that was compiled for a totally different purpose than that used in today's resource assessment programs.

In a time when information on energy reserves and resources is so very critical for the planning aspects of national and international economics, it seems imperative, and to the very best interest of the field of energy resources, to effectively orient and create these energy data bases and efficiently utilize the results to obtain important information to help find the answers to the problems of world energy supply.

REFERENCES

- Bowen, R.W. and Botbol, J.M., 1975, The Geologic Retrieval and Synopsis Program (GRASP). USGS Prof. Paper 966. 87 p.
- Cargill, S.M., Olson, A.C., Medelin, A.L., and Carter, M.D., 1976, PACER - Data Entry, Retrieval and Update for the National Coal Resources Data System (Phase I). USGS Prof. Paper 978. 107 p.
- Gregory, K., 1977, The Approach of IEA Coal Research to World Coal Resources and Reserves. Proc. 3rd IIASA Conference on Energy Resources, Moscow.
- Herr, J.J., Phillips, S.L., Schwartz, S.R., and Trippe, T.G., 1977, Standards of Multilateral and Worldwide Exchange of Geothermal Data. In Standards for Computer Applications in Resource Assessment, Cargill, S.M. and Clark, A.L., eds., Jour. of the International Assoc. of Math. Geology, Vol.9 No. 3, p 259-264.
- Honeywell, Inc., 1977, Multics Relational data Store (MRDS) Reference Manual: Honeywell Roder No. AW53: Revision O.
- McCannon, R., Picklyk, D., Shnabel, W., Sinding-Larsen, R., 1978, Computer Storage and Retrieval of Geologic Data. COGEODATA Consultants Report to IAEA. 9 pp.
- Meyer, R.F., 1977, Petroleum Resource Data Systems, in Standatds for Computer Applications in Resource Assessments, Cargill, S.M. and Clark, A.L., eds. Jour. of the International Assoc. for Math. Geology, Vol. 9, No. 3, p 281-299.
- Meyer, R.F., 1978, The volumetric method for Petroleum Resource Estimation, in Standards for Computer Applications in Resource Assessments, Cargill, S.M., and Clark, A.L., eds. Jour. of International Assoc. for Math. Geology, Vol. 10, No. 5, p 501-518.
- PDS, 1979, Petroleum Data System of North America User's Guide, Office of Information Systems Programs, University of Oklahoma. Univ. of Oklahoma Press.
- PETROCONSULTANTS, S.A., 1978, International Petroleum Consultants, Geneva, Switzerland.
- U.S. Bureau of Mines and U.S. Geological Survey, 1976, Principles of the Mineral Resources Classification System of the US Bureau of Mines and US Geological Survey: US Geol. Sutvey Bull. 1450-A, 5pp.
- U.S. Federal Power Commission, 1976, Reserves and Resources Classifications: National Gas Survey Report to the Federal Power Commission by the Supply Technical Advisory Committee Study Subgroup on Reserves and Resources Classification, 153pp.
- P.I., 1978, Well History Control System, Technical Services Dept, Petroleum Information Corporation, Denver, Colorado.

ENERTREE Data Base System

Serge Medow

International Institute for Applied
Systems Analysis,
A-2361 Laxenburg, Austria

The tree system was designed to simplify the process of interaction between the user and the computer, more specifically to help the user in the filtering and linkage of data with various types of models, both stored on computer. This is achieved first, by limiting the number of actions or decisions on the user's part in predefining access, filtering and display methods available to him and secondly by using a hierarchical tree as method of structurization and classification. At each of the nodes of the tree structure the user may access and filter data and link these to the particular model chosen.

The TREE program is constructed as a non-binary tree relying on linked lists and a special search algorithm, providing the user with a conversational form of access to the computer and serving as a "telescope" which can be directed to the parts of a larger structure, of interest to the user. The usage of the TREE program and it's benefits are discussed and an abstract example as well as a sample session of the ENERTREE program linking all WELMM data bases illustrate the potential applications.

THE PROBLEM OF LINKING DATA WITH MODELS OF VARIOUS TYPES

This procedure could be implicitly combined through several assumptions, into the model itself, or it could be a separate process, quite independent of the model depending upon the complexities involved.

The process of understanding, respecifying, correcting, and adding to the modeled systems is almost always a repetitive one, hence the use of interaction between computers, which in this case are used as aids and tools, should be on-line (ie. direct) to increase the efficiency, and in such a way that the general restrictions of the instruments and the expertise in handling it do not limit the non-expert user. It must be noted, however, that there exists an optimum efficiency level or rate, especially in man - machine interactions, which are also dependant upon the human element, of analysing the minimum results before continuing with more repetitive or massive reiterations of other and similar experiments.

Keeping this in mind the Tree system was designed as a common frame of reference and therefore a semi-rigidization between the vast capabilities of the computer and the user, to simplify the process of interaction.

This was achieved first by limiting the number of actions or decisions on the user's part on how to repeat a previous experiment with newly filtered data, or the decision of how the computer should present the results by predefining the methods available to him. Since he will have no use for the other capabilities of the machine, the corresponding space should be used for other informational processes.

Secondly a method of structurization and classification was selected to be one of a hierarchical tree, in which each node represents a set of prespecified explanations, as well as a selection of models and partially or totally prepared variations of input to, and output from, the chosen model (to be taken as the assumed, if not otherwise specified). The parent nodes could either process all of the information contained within their children, or could be of totally independant nature.

Using the predefined conceptual tree structure, and the information contained within the nodes, many experiments could be maintained possessing a similar internal structure, yet producing quite different interpretations from the users.

It should be noted that the mechanism of the tree structure itself is designed in such a way as to provide a secondary method of user control of the overall existing computer system. This allows for more direct interaction between the experimenter who has knowledge of the nature of the model with the computer system, without becoming dependant on the assistance of experts in other fields. That in turn conveys a feeling of the future potentials in both using the computer as a tool and in applications.

HOW THE TREE IS CONSTRUCTED

The programme TREE is constructed as a nonbinary tree relying on linked lists and a search algorithm based on a probabilistic distribution of pointers in accordance with the HASH-D method. Its main objective is to provide a conversational access to model users who may themselves not know any programming languages. The guiding principle relating to the use of such a programmes is that the person sitting before a screen should employ it as the equivalent of a telescope, and direct it to various sectors of

the larger structure that currently interest him. In such a context he may widen the scope of his observations as well as the degree of the detail in terms of which individual objects are examined. This makes it possible for the user to arrive at his own conception of processes occurring within the wider structure.

HOW TO USE THE TREE PROGRAM

The person at the screen (the expert) initially constructs a tree that corresponds to his own conceptual structure. In replying to questions that are displayed by the programme itself, he produces a multilevel hierarchical system that will subsequently be linked first to a data bank, and then with a model (or else a bank of models). The tree may be constructed on the basis of the most diverse principles of classification (just as in the case of a library, library books may be classified either by author, title, subject). When the tree is constructed the data that are needed for the model will first be sought within the data bank in accordance with the search algorithm, and their addresses will be entered into the corresponding nodes of the tree. When the same information will be needed a second time it may be easily found through the addresses that have been entered. In this way The information is organized by the expert himself in a form that is convenient to him and in terms of attributes that are essential for his own model conception. The use of the conversational mode permits him not only to construct such a tree himself but to alter its configuration during the very course of an experiment. In addition should data in the needed form not be available

within the bank, auxiliary programmes may be applied, would make it possible to obtain the missing data from existing ones through such operations as summation, extrapolation, etc. Should that method as well not produce the desired results it is possible to:

1. interrupt the programme and introduce data exogenously
2. restructure the model in such a way as to avoid the missing data.

This last step is executed through changes and additions to the mechanisms that link models of blocks. In such an event the programme is interrupted and the user is temporarily able to leave the TREE system and to alter existing linkages and also construct additional blocks with the help of editing operators. Subsequently the user returns to the TREE system and continues his experiment at the point at which it had been interrupted. In this way not only is the information adapted to the model but the model itself may be adapted to available information. By working in such a mode of operation the expert is able to move from one level to another, to move along different branches of a tree, and by observing the process under study at various levels and from various points of view to identify specific trends in the development of actual processes.

WHAT IS THE BENEFIT OF A TREE SYSTEM

The use of systems similar to TREE may be very productive in working with simulation models. In addition to the possibilities that have already been mentioned such trees may be applied for man-machine games in which a number of experts participate each of which employs the same tree. In addition, it is possible to

construct such trees based on different classification principles, yet linked to the same data packages. In such cases the same set of data may be employed for different aspects of the same phenomena.

The universal character of the TREE system should be emphasized. That program was constructed at the IIASA for studies with the ENERDYM energy model, and also for the WELMM data bank. But since the tree is merely a form of hierarchical linkage between any model and any data bank it may also be effectively employed for studies in such fields as biology, ecology, economics, politics, etc.

AN ABSTRACT EXAMPLE OF USING THE TREE PROGRAM

The following diagram demonstrates a tree structure which will be created in the following example where it would be possible to be able to descend or ascend, the tree, executing programs, listing data, "attached" to each of the nodes.

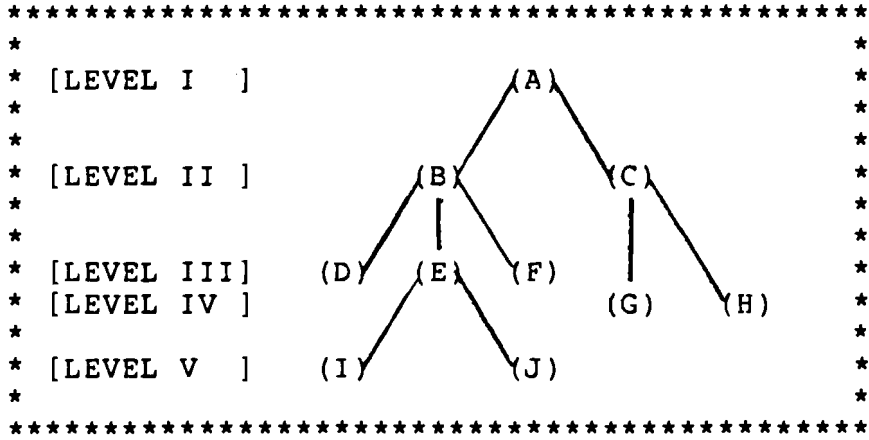

It is necessary to understand how the above tree is restructured, in order that movement, as well as appending, and deleting nodes, is possible. The diagram below shows the same tree restructured.

The levels of the tree are indicated by the square brackets "[]". Note that they all have an index of 0. The nodes of the tree are indicated by the round parenthesis "()". All of the nodes belong to the level which is directly to the left of them.

Initially when you first begin, you are always located at the top most level name [0:I]. From any node or level it is possible to make one of following movements; a.) Directly up to the parent node, if it exists. b.) Down to the level name below. c.) Left or right the the neighboring node in the current level.

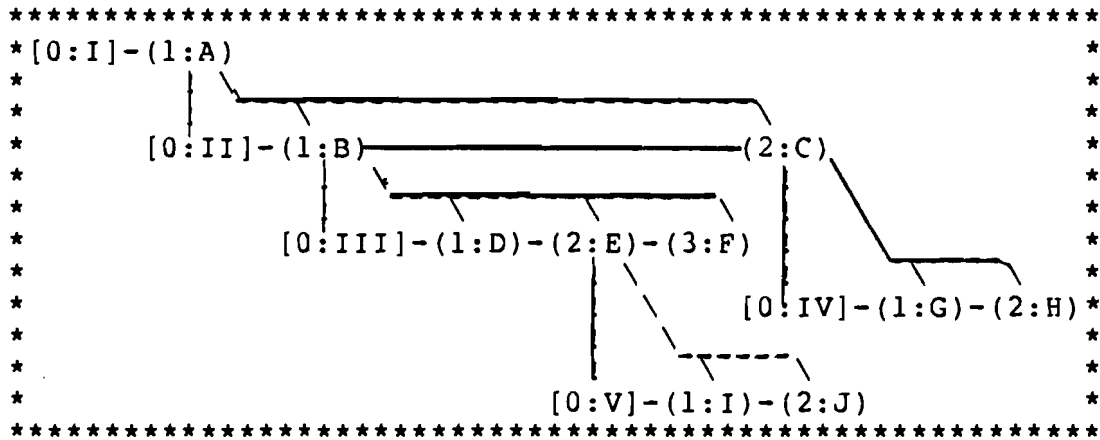

A SAMPLE SESSION

A sample session is given below using all of the commands possible both interactively and in abbreviated form with their defaults. Note the the Computer responds in capital letters, while the users in small letters.

LOGIN: name

% /mnt/medow/Tree/Tree

TREE VERSION 2

ENTER NAME OF TREE: Tree.example

NEW FILE? yes

ENTER NAME OF LEVEL 1: level I

CURRENT MODE IS : READ/WRITE
TREE NAME : Tree.example
NUMBER OF USERS :
TREE STATE : READ/WRITE
TOP LEVEL NAME : level I
PATH :/ 0/
CURRNT LEVEL NAME: level I
NO. OF QUESTIONS :

-> help

```

*****
*CMND*MD* ARGUMENT      *          DESCRIPTION          *
*****
*ADD *RW*LVL/NOD NME *  ADD A LEVEL/NODE NAME TO THE TREE *
*DELE*RW*CONFIRMATION* REMOVE A SUBTREE, STRTING FRM CRNT LOC*
*CHAN*RW*LVL/NOD NME *  CHANGE THE NAME OF CURRENT LEVEL/NODE *
*====*====*====*====*====*====*====*====*====*====*====*
*MOVE*R *><v^tb =.( ) * MOVE IN TREE ACCORDING TO ARGUMENT GO *
*JUMP*R *LVL/NOD NME#*  JUMP TO CLOSEST NAME #NAME          *
*====*====*====*====*====*====*====*====*====*====*====*
*LIST*R *ALL           *  LIST CURRENT/ALL LEVELS OF THE TREE *
*TREE*R *ALL           *  SHOW A TREE FOR CURRENT/TOP LEVEL  *
*STAT*R *ALL           *  GIVE THE STATUS OF CURRENT/ALL LOC *
*PATH*R *              *  GIVE THE PATH FOR THE CURRENT LOCATION*
*WAY *R *              *  GIVE THE PATH USING NODE NAMES     *
*NAME*R *              *  GIVE THE NAME OF THE CURENT LEVEL/NODE*
*====*====*====*====*====*====*====*====*====*====*====*
*KINE*RW*TREE COMMAND*  ADD A KINETIC COMMAND TO THE CURNT. LOC*
*POTE*RW*TREE COMMAND*  ADD A POTENTIAL COMMAND TO CURRENT LOC*
*RUN *R *              *  RUN ALL POTENTIAL COMMANDS IN CRNT LOC*
*====*====*====*====*====*====*====*====*====*====*====*
*TELL*RW*NEW QUESTION*  ADD A NEW GLOBAL QUESTION [# @# ^%] *
*ASK *R *QUESTION NO.*  ASK CERTAIN STORED QUESTION NUMBERS[#] *
*QUES*R *ONLY           *  LIST QUESTIONS ONLY/AND RESPONSES *
*====*====*====*====*====*====*====*====*====*====*====*
*CLEA*RW*POT/KIN/QUES*  REMOVE PCTEN/KINE/QUES FROM THE TREE *
*EDIT*RW*POT/KIN/QUES*  EDIT POTEN/KINE/QUES STORED IN TREE *
*====*====*====*====*====*====*====*====*====*====*====*
*HELP*R *              *  GIVES DESCRIPTION OF COMMANDS     *
*DESC*R *SYSTEM FILE *  LISTS AND SYSTEM FILE                *
*====*====*====*====*====*====*====*====*====*====*====*
*ECHO*R *ANYTHING      *  RETURNS ITS OWN ARGUMENT BACK     *
*! *R *SYS COMMAND     *  EXECUTES ANY SYSTEM COMMAND        *
*====*====*====*====*====*====*====*====*====*====*====*
*PERM*R *ACCES/WRITE   *  ENTERS NEW PASSWORD FOR CHANGING MODE *
*PASS*RW*PASSWORD     *  CHECK PASSOWRD TO CHANGE CURRENT MODE *
*MODE*R *              *  SHOWS YOU YOUR CURRENT MODE        *
*====*====*====*====*====*====*====*====*====*====*====*
*NEW *R *              *  RE-ENTERS TREE PROGRAM WITH A NEW FILE*
*ZAP *RW*CONFIRMATION*  DESTROYS THE CURRENT FILE, AND EXITS *
*STOP*R *              *  EXIT OUT OF TREE                    *
*****

```

-> describe /mnt/user/filename

this is the contents of filename

.
.
.

-> tree all

```

*****
* 0* 0* level I
* 0* 1* A
* 1* 0* level II
* 1* 1* B
* 2* 0* level III
* 2* 1* D
* 2* 2* E
* 3* 0* level IV
* 3* 1* I
* 3* 2* J
* 2* 1* F
* 1* 0* level V
* 2* 0* C
* 2* 1* G
* 2* 2* H
*****

```

-> move >

```

PATH          :/ 1/
CURRNT NODE   NAME: A

```

-> status

```

TREE NAME      : Tree.example
NUMBER OF USERS : 1
TREE STATE     : READ/WRITE
TOP LEVEL NAME : level I
PATH           :/ 1/
CURRNT NODE   NAME: A
LEVEL NAME BELOW : level II
NO. OF QUESTIONS : 0

```

-> echo this echos its argument back to the user

this echos its argument back to the user

-> name

```

CURRNT NODE   NAME: A

```

-> potential echo name of cur loc is:

-> potential name

TREE VERSION 7.0

CURRENT MODE IS : NO ACCESS
 ENTER PASSWORD TO ACCESS TREE SYSTEM:welmm

MODE CHANGED TO : READ ONLY
 TREE NAME : WELMM
 TREE STATE : READ ONLY
 TOP LEVEL NAME : WELMM
 PATH : / 0/
 CURRNT LEVEL NAME: WELMM
 NO. OF QUESTIONS : 73

WELCOME TO THE WELMM TREE
 (for info type run)

TO EXECUTE THE INTERACTIVE
 QUESTIONAIRE SESSION,
 TYPE: ask 1

-> tree all

```

*****
* 0* 0* WELMM
* 0* 1* world regions
* 1* 0* WORLD REGIONS
* 1* 1* world regions
* 2* 0* WORLD REGIONS
* 2* 1* T world total
* 3* 0* WORLD TOTAL
* 2* 0* R north america
* 3* 0* NORTH AMERICA
* 3* 1* canada
* 3* 2* mexico
* 3* 3* united states
* 2* 1* R west indies
* 3* 0* WEST INDIES
* 3* 1* bahamas
* 3* 2* barbados
* 3* 3* belize
* 3* 4* dominican rep
* 3* 5* cuba
* 3* 6* haiti
* 3* 7* jamaica
* 3* 8* puerto rico
* 3* 9* trinidad tobago
* 3* 10* others w indies
* 2* 2* R cent america
* 3* 0* CENT AMERICA
* 3* 1* costa rica
* 3* 2* guatemala
* 3* 3* honduras
* 3* 4* nicaragua
* 3* 5* panama
* 3* 6* others centr am
* 2* 3* R south america
* 3* 0* SOUTH AMERICA
* 3* 1* argentinia
* 3* 2* bolivia
* 3* 3* brazil
  
```

*	3*	4*	chile
*	3*	5*	columbia
*	3*	6*	ecuador
*	3*	7*	french guiana
*	3*	8*	guianas
*	3*	9*	paraguay
*	3*	10*	peru
*	3*	11*	surinam
*	3*	12*	uruguay
*	3*	13*	venezuela
*	3*	14*	others south am
*	2*	4*	R west europe
*	3*	0*	WEST EUROPE
*	3*	1*	austria
*	3*	2*	belgium
*	3*	3*	crete
*	3*	4*	denmark
*	3*	5*	finland
*	3*	6*	france
*	3*	7*	germany west
*	3*	8*	greece
*	3*	9*	greenland
*	3*	10*	iceland
*	3*	11*	ireland
*	3*	12*	italy
*	3*	13*	malta
*	3*	14*	netherlands
*	3*	15*	norway
*	3*	16*	portugal
*	3*	17*	san marino
*	3*	18*	sicily
*	3*	19*	spain
*	3*	20*	spitsbergen
*	3*	21*	sweden
*	3*	22*	switzerland
*	3*	23*	united kingdom
*	3*	24*	others west eur
*	2*	5*	R east europe
*	3*	0*	EAST EUROPE
*	3*	1*	albania
*	3*	2*	bulgaria
*	3*	3*	czechoslovakia
*	3*	4*	germany east
*	3*	5*	hungary
*	3*	6*	poland
*	3*	7*	rumania
*	3*	8*	ussr
*	3*	9*	yugoslavia
*	2*	6*	R africa north
*	3*	0*	AFRICA NORTH
*	3*	1*	algeria
*	3*	2*	egypt
*	3*	3*	libya
*	3*	4*	morocco
*	3*	5*	tunisia
*	2*	7*	R africa ce sou
*	3*	0*	AFRICA CE SOU
*	3*	1*	angola
*	3*	2*	cabinda
*	3*	3*	cameroun
*	3*	4*	central afr emp
*	3*	5*	chad
*	3*	6*	congo

*	3*	7*	dahomey
*	3*	8*	ethiopia
*	3*	9*	equat guinea
*	3*	10*	fernando poo
*	3*	11*	gabon
*	3*	12*	gambia
*	3*	13*	ghana
*	3*	14*	guinea
*	3*	15*	guinea-bissau
*	3*	16*	ivory coast
*	3*	17*	kenya
*	3*	18*	lesotho
*	3*	19*	liberia
*	3*	20*	mali
*	3*	21*	malagasy rep
*	3*	22*	mauritania
*	3*	23*	mozambique
*	3*	24*	namibia
*	3*	25*	niger
*	3*	26*	nigeria
*	3*	27*	rhodesia
*	3*	28*	senegal
*	3*	29*	sierra leone
*	3*	30*	somalia rep
*	3*	31*	south africa
*	3*	32*	spanish sahara
*	3*	33*	sudan
*	3*	34*	swaziland
*	3*	35*	tanzania
*	3*	36*	togo
*	3*	37*	upper volta
*	3*	38*	zaire
*	3*	39*	others c s afri
*	2*	8*	R middle east
*	3*	0*	MIDDLE EAST
*	3*	1*	abu dhabi
*	3*	2*	bahrain
*	3*	3*	dhofar
*	3*	4*	cyprus
*	3*	5*	dubai
*	3*	6*	iran
*	3*	7*	iraq
*	3*	8*	israel
*	3*	9*	jordan
*	3*	10*	kuwait
*	3*	11*	lebanon
*	3*	12*	neutral zone
*	3*	13*	oman
*	3*	14*	qatar
*	3*	15*	ras al khamah
*	3*	16*	saudi arabia
*	3*	17*	sharjah
*	3*	18*	sharjah unim
*	3*	19*	syria
*	3*	20*	trucial coast
*	3*	21*	turkey
*	3*	22*	yemen
*	3*	23*	others mid east
*	2*	9*	R asia far east
*	3*	0*	ASIA FAR EAST
*	3*	1*	afghanistan
*	3*	2*	bangladesh
*	3*	3*	bhutan
*	3*	4*	burma

```

* 3* 5* china
* 3* 5* india
* 3* 7* japan
* 3* 8* khmer rep
* 3* 9* laos
* 3* 10* nepal
* 3* 11* north korea
* 3* 12* pakistan
* 3* 13* philippines
* 3* 14* sakhalin
* 3* 15* south korea
* 3* 16* sri lanka
* 3* 17* sikkim
* 3* 18* taiwan
* 3* 19* thailand
* 3* 20* vietnam
* 3* 21* others asia
* 2* 10* R oceania
* 3* 0* OCEANIA
* 3* 1* australia
* 3* 2* borneo
* 3* 3* brunei
* 3* 4* indonesia
* 3* 5* malaysia
* 3* 6* new zealand
* 3* 7* papua
* 3* 8* sabah
* 3* 9* sarawak
* 3* 10* timor
* 3* 11* w new guinea
* 3* 12* others oceania
* 0* 0* oil
* 1* 0* OIL
* 1* 1* oil facilites
* 1* 2* tarsand
* 1* 3* oilshale
* 0* 1* gas
* 1* 0* GAS
* 1* 1* gas facilities
* 0* 2* atomic
* 1* 0* ATOMIC
* 1* 1* atomic facilities
* 0* 3* solar
* 1* 0* SOLAR
* 1* 1* solar facilities
*****

```

WELCOME TO THE WELMM TREE
(for info type run)

TO EXECUTE THE INTERACTIVE
QUESTIONNAIRE SESSION,
TYPE: ask 1

-> ask 1

interested in OIL? yes
 interested in a OIL info of a country? yes
 do you need a list of the available countries? no
 please enter name of country united states
 CURRNT NODE NAME: united states
 PATH :/ 1/ 1/ 2/ 3/
 was this country found? yes
 do you wish to see oil reserves? yes

RELATION: reserves ATTRIBUTE: oreserves

united states	1953	Crude reserves at year end	28945328	10E3bb1
united states	1954	Crude reserves at year end	30060600	10E3bb1
united states	1955	Crude reserves at year end	30250500	10E3bb1
united states	1956	Crude reserves at year end	30435150	10E3bb1
united states	1957	Crude reserves at year end	30358406	10E3bb1
united states	1958	Crude reserves at year end	30598000	10E3bb1
united states	1959	Crude reserves at year end	31719348	10E3bb1
united states	1960	Crude reserves at year end	31613212	10E3bb1
united states	1961	Crude reserves at year end	31758506	10E3bb1
united states	1962	Crude reserves at year end	31389224	10E3bb1
united states	1963	Crude reserves at year end	30969990	10E3bb1
united states	1964	Crude reserves at year end	30990510	10E3bb1
united states	1965	Crude reserves at year end	31352392	10E3bb1
united states	1966	Crude reserves at year end	31452128	10E3bb1
united states	1967	Crude reserves at year end	31376670	10E3bb1
united states	1968	Crude reserves at year end	30707118	10E3bb1
united states	1969	Crude reserves at year end	29631862	10E3bb1
united states	1970	Crude reserves at year end	39001336	10E3bb1
united states	1971	Crude reserves at year end	38062956	10E3bb1
united states	1972	Crude reserves at year end	36339408	10E3bb1
united states	1973	Crude reserves at year end	35299840	10E3bb1
united states	1974	Crude reserves at year end	34249956	10E3bb1
united states	1975	Crude reserves at year end	32682128	10E3bb1
united states	1976	Crude reserves at year end	30942166	10E3bb1
united states	1977	Crude reserves at year end	29486402	10E3bb1

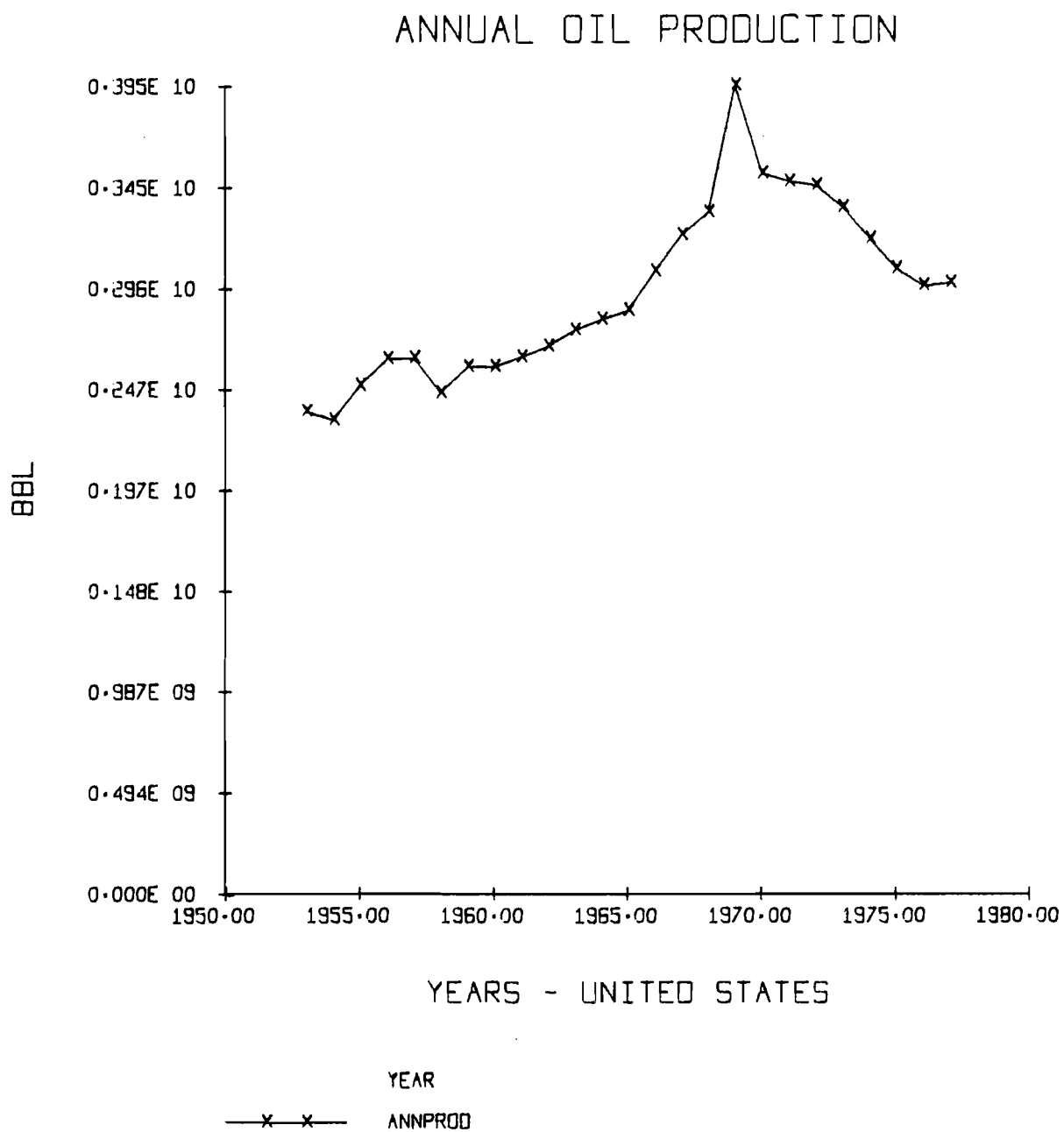

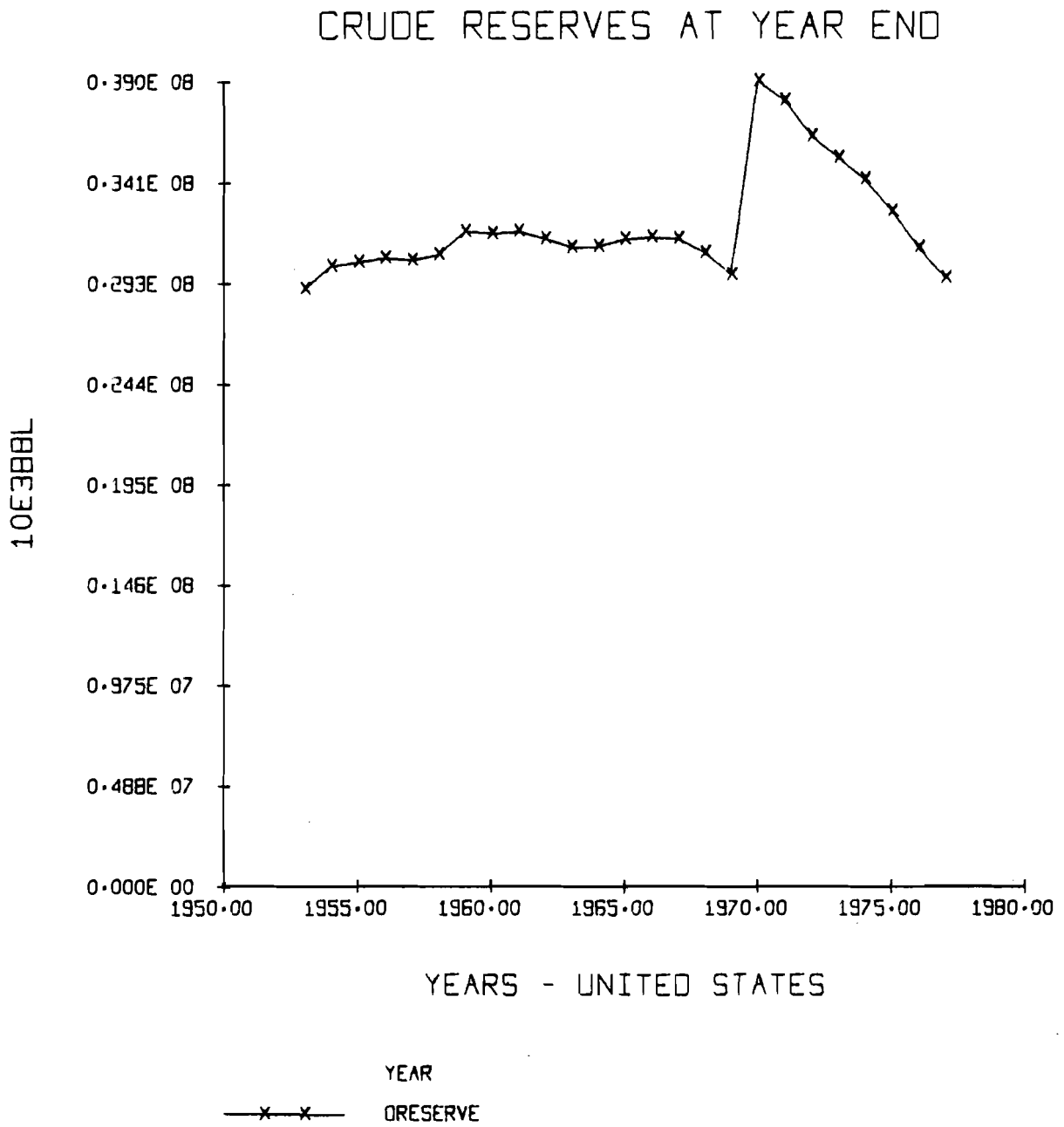

The "Facility Data Base" a Process Information
System on Energy Production and Conversion
Facilities

Arnulf Grübler and Martin Cellier

International Institute for Applied Systems
Analysis, A-2361 Laxenburg, Austria

and

Compagnie Française des Pétroles, rue
Erlanger, 75016 Paris, France

The Facility Data Base (FDB), being one of the two basic tools of the WELMM* approach is a process information system on industrial energy production and conversion facilities. The information recorded in the FDB is stored at the level of "typical" (in considering size and technology) energy facilities or plants and covers physical indicators (WELMM resources) as well as economic data. In addition to quantitative data the FDB contains also qualitative information on the particular data in form of quality indicators and text notes as a result of an extensive data analysis and synthesis prior to computerization. The FDB structure and contents cover the areas of process identification (name, location, capacity, etc.) and characterization (list of energy input-output flows) as well as the resource requirements (including cost data) for the construction and the operation of a particular facility. The data contents of the FDB are presented in detail along a sample listing of a nuclear facility. The data acquisition, analysis and computerization in a natural language relational data base management system are outlined. Finally, the possible applications of the FDB are discussed and conclusions on the relative advantage of process information systems like the FDB over other systems representing socio-economic activities (e.g. input-output tables) are drawn.

* for : Water, Energy, Land, Materials, Manpower

INTRODUCTION

In order to assess the natural resource requirements of resource development strategies (in particular energy strategies) an analytical approach called WELMM has been developed at IIASA [1]. The WELMM approach involves an assessment of the requirements and the availability of Water, Energy, Land, Materials and Manpower resources. For quantitative analysis, the WELMM approach is based on computerized data bases of primary resource availability at the global, national or regional level* and on data bases of resource requirements for industrial processes deployed in processing primary (energy) resources to the commodities required by the final consumer.

The concept of "process" has its theoretical roots in activity analysis [2] and its further elaboration by Georgescu-Roegen [3]. A process can be considered simply as a system, separated from its environment by an imaginary (definitional) boundary. Within the Facility Data Base (FDB) this boundary is drawn in such a way that a process corresponds to an industrial unit or facility associated with a step in the valorization of an energy resource, going from the primary resource through secondary and tertiary conversion, to the transportation and distribution of the final commodities to the end users. As the FDB is energy oriented the main input and output flows cover the range from the primary energy resource (coal, uranium,...) to final energy (electricity, hot water,...). Figure 1 summarizes the WELMM process analysis. The conversion efficiency of the process is defined as the ratio between

* see papers by S. Medow and M. Grenon in Part 2 and 3 of these proceedings [the Editors]

primary inputs and net outputs. Additional outputs of the process are physical losses and wastes and non-energy by-products. In addition to the primary input the process requires additional material and services inputs: water, energy, land, manpower and primary materials like steel, concrete etc., used directly on site (inside the FDB these inputs are called the "direct resource requirements"). In addition the FDB also records the capital goods requirements (boilers, heat exchangers, etc...) however, only in terms of their materials and energy* requirements forming thus the so-called "indirect requirements". These WELMM resource flows are recorded both for the construction period of the installation as well as for the (full stream) operation of the process. The WELMM resources include equally economic data. However, inside the WELMM approach, most attention has been devoted to the natural resource requirements and not to the question of costs, especially in view of the short term validity of economic data. The process analysis as presented in Figure 1 also determines the structure of the FDB organized in three main blocks: process characterization (general characteristics and list of input and output flows), resource requirements for construction and operation.

As the primary objective of the FDB is to characterize technological (energy) chains (see Figure 2) and with these chains whole energy systems in combining the processes associated with the various transformation steps of these chains,

* the indirect energy requirements include equally the energy embodied in the direct "field" materials required for the facility.

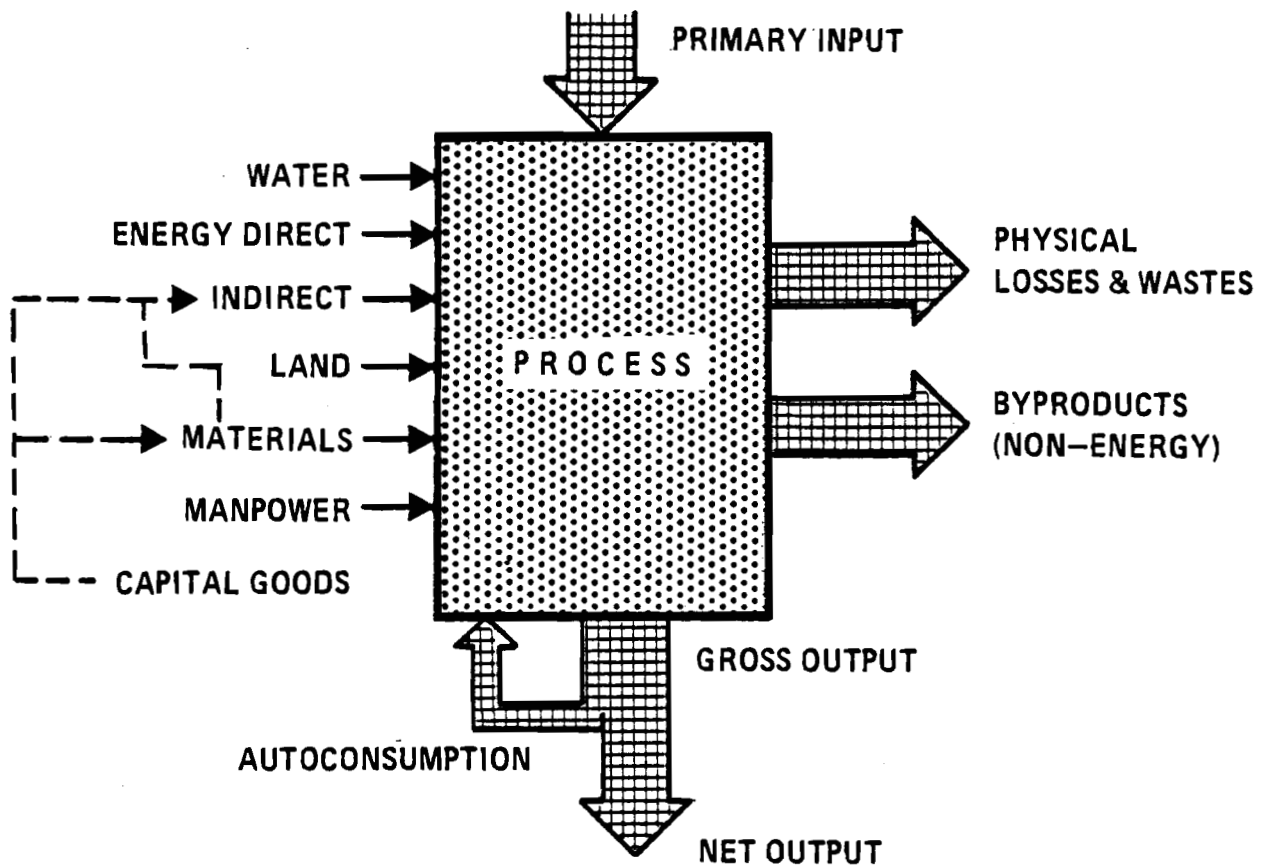

Figure 1. WELMM Process Analysis

the facilities in the FDB can be classified first according to their position in this conversion hierarchy: from extraction, transportation, conversion to distribution and storage. Another classification can be made according to the degree of maturity attained by the technology of a particular facility (mature, in developing stage, pilot or experimental). Finally, a classification can be made according to the kind of primary energy converted (oil, gas, coal, uranium, solar, etc...).

The definition of a process or facility to be stored in the FDB follows first the three classification schemes presented above. In addition the definition of a facility is done at a level that it represents a "typical" example of the technology deployed. There are two main factors enabling the definition of such "typical" facilities. First, for each industrial conversion step, only a limited number of technologies in the various maturity levels exist. The technological characteristics of any facility are independent from their location (at least to a very big extent) and the resulting facility description is applicable also outside the national context it was developed in. A good example for this is provided in the area of Light Water Reactors: a majority of the reactors built are Pressurized Water Reactors using the same (Westinghouse) license, these reactors are not significantly different, whether they are constructed in the USA, in France or for instance exported to a developing country.

Secondly, there is an increasing trend towards standard size classes for energy facilities (e.g. the above mentioned Westinghouse license PWR with a capacity of around 1000 or

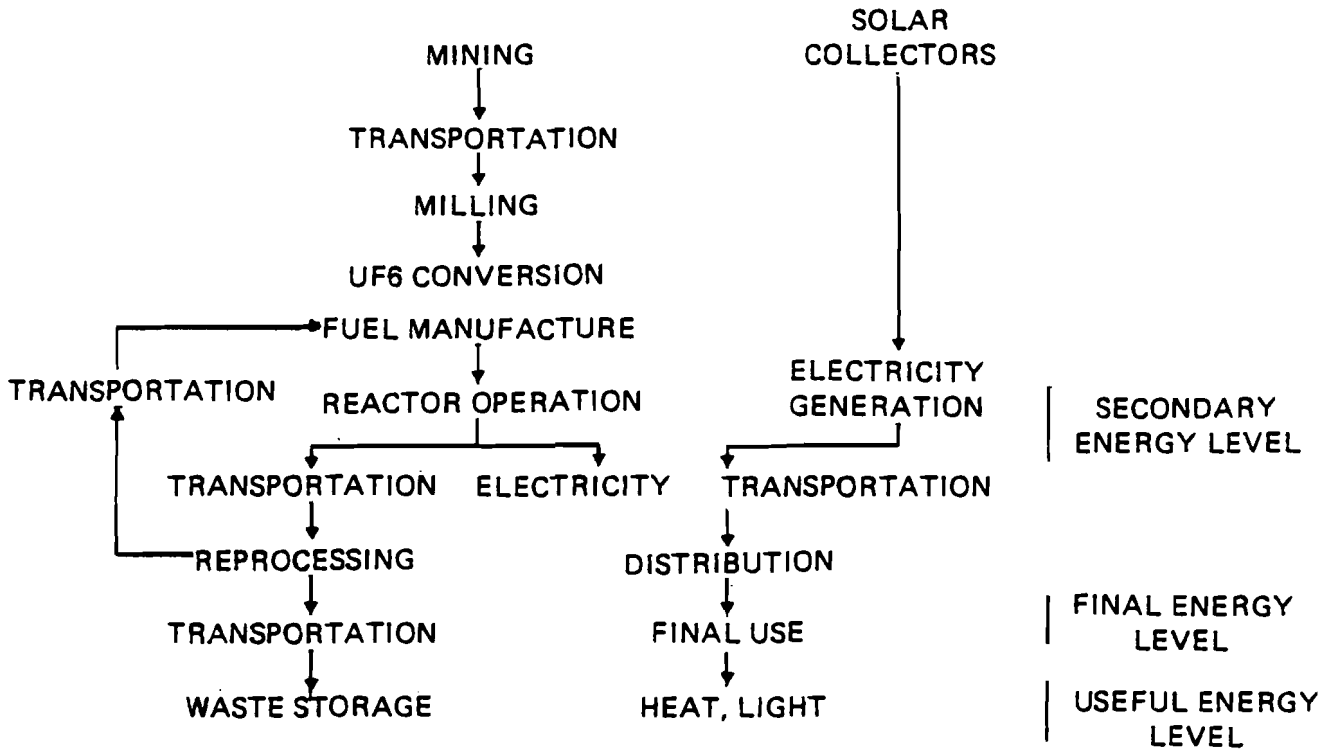

Figure 2. Example of Nuclear and Solar Thermal Electricity Generating Chains

1300 MWe, or crude oil tankers of 250 000 or 300 000 DWT or a 10 million tons/year oil refinery). Both factors facilitate the definition of a limited number of facilities, characterizing a particular energy system.

Finally, it should be mentioned, that the process boundary defined for the FDB (i.e. corresponding to an industrial facility) is flexible - at a conceptual level and from the point of view of the actual data base structure and management system. So in case a further disaggregation of a facility into various sub-processes (e.g. the disaggregation of a power plant into steam production, electricity generation, cooling and environmental control processes) appears necessary this can be done within the present concepts and structure of the FDB.

Data contained in the FDB and DBMS

For each facility the FDB contains both quantitative as well as qualitative information. The latter reflects the fact that prior to computerization the data are analyzed and their quality assessed. This assessment is documented both numerically (through a quality indicator) as well as textually (through footnotes recording the original data references, data conversions carried out, etc...) inside the FDB. The presentation of the data always follows the same pattern, whatever the facility. The FDB consists of the following files (a detailed example printout of a FDB facility is presented in the appendix):

- process identification: code of facility, name, location, primary capacity^{*}, secondary capacity^{*}, (energy) efficiency, planning and construction duration, operating (load) factor, technical lifetime and two text files describing the project/facility, data sources etc. and the technology or process characteristics
- process characterization (list of input and output flows): code of facility, input/output characterization (primary, secondary, etc...), flow quantity and code number of resource flow^{*}
- resource requirements for construction and operation (two separate files): code of facility, code number of resource flow^{*}, resource quantity, data quality indicator (from 1 to 5) code for footnote referring to text file containing background information on data source, validity, etc...

The process characterization file contains for each facility a different number of input/output flows. As only the energy flows are recorded in this file (all other flows are recorded in the construction or operation file) they can be classified easily in one of the following categories:

* all resource flows are coded and defined in a resource flow denomination file providing for each code number the name, unit and definition of the particular resource flow

PI	PRIMARY INPUT
PIE	PRIMARY INPUT EQUIVALENT
SI	SECONDARY INPUT
SIE	SECONDARY INPUT EQUIVALENT
PO	PRIMARY OUTPUT
POE	PRIMARY OUTPUT EQUIVALENT
SO	SECONDARY OUTPUT
SOE	SECONDARY OUTPUT EQUIVALENT

The energy equivalents are normally based on the calorific equivalent values calculated for the particular input/output and expressed in a common unit (e.g. ton oil equivalent) for all facilities along a particular technological chain, this in order to ease the linkage of the various processes to go from the primary resource till the final product.

The files containing the resource requirements for construction and operation record the requirements as totals for the whole construction period (all requirements prior to start up of full stream operation) and as totals for one year of full stream operation. Each individual data is accompanied by a quality indicator and a text footnote.

The quality indicator as an appreciation of the data quality is of course subjective, but tries to take into account: the credibility of the origin of data, the viability, the homogeneity with other sources and the range of uncertainty as defined in Table 1.

Table 1. Quality value associated with each data parameter.

Note	Quality and precision of the information
1	very good \pm 10%
2	good \pm 25%
3	fair \pm 50%
4	poor \pm 100%
5	validity unknown and/or questionable

The text footnote contains additional explanation on the particular data: on it's quality assessment, it's origin and transformation/conversion carried out and it's variation depending on the geographical, technical and temporal context it can be considered.

Another characteristic of the data is that they are stored at various aggregation levels. For instance, manpower requirements are given as a total of man-hours or man-years, but one finds also a breakdown of that total into four categories of manpower: manual technical (technicians, qualified workers), manual non-technical (non-qualified manpower), non-manual technical (engineers) and non-manual non-technical (lawyers, doctors, etc.). Or for instance the total steel requirements are first differentiated into the total direct (field) requirements and the indirect requirements and then (depending on the data availability) further disaggregated on basis of their quality (e.g. carbon steel, stainless steel, etc...) and their utilization (e.g. as structural steel, pipes, plates,

in equipment etc...). The level of detail the data are recorded in the FDB is thus flexible and can follow the structure and detail in which data become available, for instance, from industry.

Numerical data as well as short non-numerical information (e.g. facility name, location, etc...) are stored in a relational, natural language data base management system called INGRES ([4], [5]), developed at the University of California, Berkely. INGRES operates on top of the UNIX system on a PDP 11/70. The text information of the footnotes is stored outside INGRES in normal UNIX files. The use of a relational, natural language DBMS allows the user to retrieve, analyze or manipulate the data of the FDB in a very simple way through a few natural language commands. An example of the query language used inside INGRES is provided in the appendix in retrieving certain facility characteristics (code, name, location and primary capacity) from two INGRES relations (facility identification and resource flow denomination file). Yet in many cases a potential user might equally require to look at all the information relative to a particular facility at once, including equally the footnotes and in hard copy format. For this a special program (called FACOUT) has been developed, which accesses all relevant information on a facility stored in INGRES and UNIX and after editing produces a complete printout of all data of the FDB on a particular facility (to be precised by the user to the interactive program). This printout is stored in a special file, which can then be printed by a line printer. Parts of such a complete printout (in excluding some of the

voluminous footnotes) is reproduced in the appendix in the sample listing of a nuclear facility.

Data acquisition and technologies covered by FDB

It is evident that the value of any particular data base stems from the value of the data collected and computerized. For the FDB two main types of data sources have been used: published literature and existing energy data bases (e.g. the one developed by the Bechtel Corporation, [6]) and direct contacts with industry. There are many problems associated with data collection from literature or existing data bases: the two main ones relate to the fact that they have been developed for specific purposes only, and in practically all cases, the data cannot be verified or understood how they were arrived at. This is why in the FDB special attention was given to careful data analysis and synthesis prior to computerization and to the documentation of this analysis. The best data can be obtained by direct contacts with industry. For the FDB, this was done either by field trips or through specially designed questionnaires. Finally, it should be emphasized that the data collection and analysis for any process information system like the FDB is a very time (and money) consuming task and has, therefore, to be restricted in certain application-oriented areas. However, once the data have been assembled and analyzed (e.g. through statistical analysis, checks on consistency with other sources, contacts with industry, etc...), they can be easily transferred and used in applications for which they have not been originally designed.

Areas covered by the FDB

In the initial development phase of the FDB data on a wide range of technologies and energy resources have been collected, analyzed and computerized. This in order to check the validity and flexibility of the concepts and design of the FDB. The conclusion from this exercise was that the FDB is flexible enough to cover a wide range of technologies and energy (or other material) resources: from small-scale solar photovoltaics to large nuclear power plant parks, from transportation to storage facilities etc... The only area where the FDB concept had to be reconsidered was for primary extraction processes as the deposit geology determines first of all the size and technology of a particular facility. A sample listing of this variety of technologies covered in the FDB ranging from conventional and unconventional oil, coal, solar and nuclear to hydrogen and electricity production, transport and storage, is presented in the sample facilities listing presented in the appendix. Further areas of extension of the FDB are application-oriented concentrating in the areas of solar and nuclear energy scenarios as well as in the area of centralized versus decentralized solar energy. The total number of around 70 facilities computerized does not appear large but should not be judged on a quantitative* viewpoint alone but rather on a qualitative in considering the extensive data analysis, synthesis and documentation it involves.

* in fact even the earlier mentioned data base by the Bechtel [6] Corporation, one of the world's largest company in design, construction and operation engineering of energy installations is limited to around 100 facilities.

Possible Applications of FDB

The FDB can serve not only analysis of energy systems but can be equally used in the analysis of any resource processing system, which purpose is to transform natural resources to a higher degree of utility. Inside IIASA the FDB serves mainly for applications in the areas of comparison of energy chains for the production of specific final energy carriers (e.g. electricity) or of energy services (i.e. at the useful energy level like heating, lighting etc...) [7], [8]; or in the comparison of whole energy systems (or "scenarios") within a specific country context [9]. At the regional level applications concentrate in the areas of evaluation of the maximum potential of renewable energy resources (e.g. biomass) or the study of centralized versus decentralized energy systems*. In all these studies the FDB enables one to consider a wide range of study topics and analysis techniques: quantitative and qualitative scenario analysis, study of resource constraints of (energy) development strategies at the international, national or regional level, impact assessment of development of alternative energy sources, choice of technologies and systems optimization using also economic criteria and linear programming techniques, etc.. Still the FDB is not entirely model (or application) independent, as for instance, data on air or water pollution have not been included thus far. However, from the viewpoint of the FDB structure and it's actual implementation these additional components could be easily integrated.

* The results of this study are documented in: F. Emard-Katsonis and D. Gourmelon, (forthcoming 1983), Resources and Economic Assessment of Centralized and Decentralized Solar Electric Systems, Electric Power Research Institute, Palo Alto, California [the Editors]

Conclusions

As a conclusion we would like to summarize briefly the main advantages of a data base system like the FDB: The first main advantage deals with the application of the concept of process in an information system. Data Bases like the FDB assemble information on a higher level (i.e. they are information rich) than any other type of information systems to represent socio-economic activities (eg. input-output tables). The data are derived from "engineering" type of information and in addition to economic data utilize mainly physical indicators, thus the information is not time or country specific and may thus also be used outside the country context they have been developed for. The use of physical (WELMM type) indicators and engineering data result in data validity over long time periods, easing thus a more long-term data base build-up. Essential for the FDB is the careful data analysis and extensive documentation. The value of the FDB comes mainly from the quality of the data, the wide range of information they cover and their international nature and the easy to use natural language DBMS, whereas we feel the quantitative aspect (number of facilities recorded and/or the sheer amount of data) of secondary importance. The FDB can support a wide range of possible applications, a number of them have been performed at IIASA demonstrating the feasibility and flexibility of the FDB. Nevertheless the FDB should not be considered as entirely model or application independent, as the detailed data analysis involved makes the development of process descriptions and data for the FDB feasible only in areas where concrete applications are performed. Nevertheless

the flexibility of the FDB concepts and structure allow to extend the FDB in areas required by further applications (e.g. in adding detailed environmental data) enlarging thus further the usefulness of such a tool.

REFERENCES

- [1] Grenon, M., and B. Lapillonne, 1976, The WELMM Approach to Energy Strategies and Options. RR-76-19, IIASA, Laxenburg, Austria
- [2] Koopmans, T.C. ed., 1951, Activity Analysis of Production and Allocation, Cowles Foundation Monograph 13, Yale University Press, New Haven
- [3] Georgescu-Roegen, 1970, The Economics of Production, American Economic Association, Volume LX, May 1970, No. 2
- [4] Held, G.D., et al., INGRES - A Relational Data Base System, AFIPS Conference Proceedings Vol. 44, Montreal, N.J., U.S.A.
- [5] Woodfill, J., et al., 1979, INGRES Version 6.2 Reference Manual, Memorandum UCB/ERL M79/43, University of California, Berkely, U.S.A.
- [6] John K. Hogle, et al., 1976, Manpower, Materials, and Capital Costs for Energy-related Facilities, Bechtel Corporation, San Francisco
and
Bechtel Corporation, 1978, Energy Supply Planning Model: Computer On-Line Data Base, unpublished report
- [7] Grübler, A., and M. Cellerier, 1979, Comparaison de chaînes énergétiques, Revue de l'énergie No. 316, June-July 1979, Les éditions techniques et économiques, Paris, France
- [8] Grübler, A., 1980, Resource Requirements for Industrial Processes : A WELMM Comparison of Energy Chains, WP-80-50 IIASA, Laxenburg, Austria

[9] Groupe Ressources de l'IIASA, 1979, Comparaison de scénarios énergétiques, Revue de l'énergie No. 316, June-July 1979, Les éditions techniques et économiques, Paris, France

Appendix :

- Example of INGRES DBMS query language in retrieving list of facilities

- Sample printout of FDB for nuclear light water reactor facility with examples for footnotes (note: the value of -1 denotes data not available)

```

go
• range of a is facilities
• range of b is resource
• retrieve (a.code,a.name,a.loc,a.capp,b.unit,b.name)
• where a.capr=b.num
• \g

• Executing . . .

```

```
• Executing . . .
```

code	name	loc	capp	unit	name
BATST002	Electrical Lead-Acid Battery Storage	france	0.100	10e6 kwh	electricity
COALELE1	coal fired power plant 330 MWe	austria	330.000	megawatt	electric capacity
COALGAS1	El Paso coal gasification complex	united states	2.703e+09	cubic meters	SNG
ELECTDPI1	Electricity distribution for 1GWe (PI)	united states	1000.000	megawatt	electric capacity
ELECTRPI1	Electricity transmission for 1 GWe (PI)	united states	1000.000	megawatt	electric capacity
ELTRANS1	transmission line >230 kV	france	805.000	km	length transp/dist-system
ELTRANS2	transmission line >345 kV	france	805.000	km	length transp/dist-system
ELTRANS3	Transmission Line of 400 kV	france	500.000	km	length transp/dist-system
FUELCEL1	Fuel Cells	united states	25.000	megawatt	electric capacity
GASTUR01	4-200MW units-Simple Cycle Gas Turbines	united states	800.000	megawatt	electric capacity
H-2DIST2	hydrogen distribution network	france	3.120e+08	m3	hydrogen
H-2PROD4	Electrolytic Hydrogen Production	germany	5.600e+06	m3	hydrogen
H-2TRAN2	hydrogen pipeline	france	1.205e+07	ton	hydrogen
OILREFF1	low gasoline refinery	united states	200000.000	bpsd	topping capacity
OILREFF2	fuel refinery	united states	200000.000	bpod	topping capacity
OILREFF3	fuel refinery	austria	200000.000	bpod	topping capacity
OILREFH1	high gasoline refinery	united states	200000.000	bpsd	topping capacity
OILREFH2	gasoline refinery	united states	200000.000	bpod	topping capacity
PHOTVOL1	Photocells under Concn. JPL Estimate	united states	100.000	megawatt	electric capacity
SOLTEC01	STEC (Mitro) intern.demand 6hrs storage	united states	100.000	megawatt	electric capacity
SOLTEC02	Themis	france	2.000	megawatt	electric capacity
SOFACL1d	Photocells under Concntr. 1.25 kW	france	1.250	kilowatt	electric peak capacity
SOFACL2d	Photocells under Concntr. 2.5 kW	france	2.500	kilowatt	electric peak capacity
SOFACL5d	Photocells under Concntr. 5 kW	france	5.000	kilowatt	electric peak capacity
SOFACL1d	Photocells u. Concntr. 1.25 kW, Decentr.	france	1.250	kilowatt	electric peak capacity
SOFACL2d	Photocells u. Concntr. 2.5 kW, Decentr.	france	2.500	kilowatt	electric peak capacity
SOFACL5d	Photocells u. Concntr. 1.25 kW, Centr.	france	5.000	kilowatt	electric peak capacity
STOBAT02	Electrical Lead-Acid Battery Storage	france	0.100	10e6 kwh	electricity
STOPUM01	Pumped Storage	france	1000.000	megawatt	electric capacity
TASAMEX1	grat canadian oil sands	canada	45000.000	bbl/oalday	capacity upgrading
STOPUM05	Pumped Storage	france	500.000	megawatt	electric capacity
WOODELE1	wood fired electric plant	united states	55.000	megawatt	electric capacity
coalpip1	coal slurry preparation & dewatering	united states	2.267e+07	metric tons	clean coal
elidist1	electricity distribution	france	1000.000	megawatt	electric capacity
fbract2	LMFBR heterogen core	france	1200.000	megawatt	electric capacity
fbrffab2	FBR fuel fabrication	france	500.000	metric tons	heavy metal (u + pu)
fbrfrep2	FBR fuel reprocessing	france	950.000	metric tons	heavy metal (u + pu)
h-2prod3	electrolytic hydrogen production	france	7.500e+09	m3	hydrogen
hlvsto4	high level waste storage	france	120000.000	canisters	high level waste
lowsto2	low level waste storage	france	400000.000	m3	packaged low level waste
lwreact1	LWR with draft cooling tower	united states	1000.000	megawatt	electric capacity
lwreact4	PWR (Westinghouse licence)	france	925.000	megawatt	electric capacity
lwreact5	PWR (Westinghouse licence)	france	905.000	megawatt	electric capacity
lwrfab2	LWR fuel fabrication w/o pu recycling	france	600.000	metric tons	uranium enriched
lwrfrep2	LWR fuel reprocessing (pu separation)	france	1500.000	metric tons	heavy metal (u + pu)
surumin3	surface uranium mine (800 ppmU ore)	U exporter	275000.000	metric tons	uranium ore 800ppm
uocover2	uranium conversion u3o8 to uF6	france	9070.000	metric tons	yellow cake (75%u308)
uearich2	uranium enrichment gaseous diffusion	france	8.750	10e6 swu	separative work unit
undumin2	underground uranium shale mine (60 ppmU)	united states	6.000e+06	metric tons	uranium shale 60ppm
undumin3	underground uranium mine (800 ppmU ore)	U exporter	115000.000	metric tons	uranium ore 800ppm
uramill2	uranium shale mill (60 ppmU ore)	united states	6.000e+06	metric tons	uranium shale 60ppm
uramill3	uranium mill (800 ppmU ore)	U exporter	300000.000	metric tons	uranium ore 800ppm

```
continue
```

facility code: lwreaot4
 facility name: PWR (westinghouse licence)
 country: france
 primary capacity: electric capacity 0.93e 03 megawatt
 primary capacity equivalent: electricity 0.57e 04 10e6 kwh
 secondary capacity: none -1.0 zero
 direct efficiency: 0.33
 planning duration: 3.00 years.
 construction duration: 6.00 years.
 load factor: 0.71
 reference year: 1982
 life time: 20 years.

primary inputs

pi	uo2	27.2000	metric tons
pie	uo2	0.780000	metric tons U235

secondary inputs

si	none	0.000000	zero
----	------	----------	------

primary outputs

po	electricity	5735.00	10e6 kwh
----	-------------	---------	----------

secondary outputs

sol	heavy metal (u + pu)	23.0560	metric tons
sole	depleted fuel	0.202000	metric tons U235
so2	(fissile) plutonium	0.156000	metric tons
so2e	pu equivalent	0.147000	metric tons

construction footnote: NL.1500

The 900 MW PWR unit is part of a 4 unit complex presently being built in France by Framatome under Westinghouse licence. Construction is assumed to have started in 1976 and the facility should be in operation in 1982. At present (1979) two of these units (with slightly smaller capacity) are already in operation (Fessenheim I and II) and 23 are under construction or ordered - a further 7 are on option.

The reference facility has once-through cooling, is situated on the side of the river and has the following characteristics:

Thermal capacity:	2785	MWth
Electric capacity gross:	957	MW
Electric capacity net:	925	MW
Electric capacity net:	905	MW
Thermal efficiency:	33.2	%
Thermal efficiency:	32.5	%

once-through cooling
cooling towers
once-through cooling
cooling towers

COOLANT: Water

Coolant pressure: 155 bars
Coolant inlet temperature: 286 degrees Cent.
Coolant outlet temperature: 323 degrees Cent.
Coolant throughput: 47680t/h
Cooling water throughput in the 3 condensers: 35 cu. m/S

STEAM:

Steam production: 5500t/h
Steam temperature: 270 degrees Cent.
Steam pressure: 55 bars

GENERATOR:

1500 rounds/minute
Capacity: 1120 MVA
Voltage: 24 kV
Voltage after transformer: 380 kV
Dimension: 57 m
Weight: 4200 tons

FUEL:

Number of assemblies: 157
Number of fuel pins/assembly: 264
Fuel pin diameter: 9.5 mm
Fuel pin active length: 3.66 m

After the year 1985 new PWRs will consist mainly of 1300 MWe units. Whenever data were available the data for these units were also given; but no general sealing factors for all the powerplant can be obtained.

PLANNING AND CONSTRUCTION DURATION:

Recent experience (e.g. the Bugey 2 unit) shows an increase in the initially estimated 5-year construction period of 18 months. This increase is expected to range between 10 and 14 months for the next units on the same site due to the following factors:

Engineering studies:	5-6 months extra
Equipment fabrication:	5-6 months (not extra)

Works on site: 6 months extra
 Fueling and putting into service: 6 months extra

Therefore 6 years construction time is a more realistic estimate than the present 5-year estimation. The planning duration (time between declaration of public utility and start of construction) of 3 years should be considered as a minimum value.

The total period of 9 years between the declaration of the public utility and the commercial operation is much shorter than the one considered now in the United States which is about 12 years (Construction Status Report, NRC, 1977).

MAIN REFERENCES:

Reference A:

Faradji, Outrequin: Cout energetique pour la construction et le fonctionnement d'une Centrale PWR et consequences pour une politique de l'energie, Institut National des Sciences et Techniques Nucleaires. Saclay 1975.

Reference B:

EDF (Electricite de France), Direction de l'equipement-service central, dossiers techniques des besoins centrale type PWR 900 MW and summary, Paris 1976.

Reference C:

CEA (Commissariat a l'Energie Atomique), l'Industrie Nucleaire Francaise, Paris 1977. CEA, Notes d'Information 7-8, Paris 1978.

Reference D:

Ministere de l'Industrie, Rapports de la Commission Consultative pour la Production d'Electricite d'Origine Nucleaire (Peon) Paris, 1973, 1976, 1978.

Reference E:

EDF, Direction de l'Equipement, Document No. IV, Besoins en Main d'Oeuvre pour des Sites Types. Draft. Paris 1976.

Reference F:

A. Faure (EDF) Superficies occupees par EDF pour la Production et le Transport de l'Electricite. Paris 1976.

In addition supplementary information was obtained by direct contacts with CEA and EdF and various French publications in addition to U.S. references (like Oak Ridge National Laboratory, Net Energy from Nuclear Power, 1976) which served mainly as a basis for comparisons.

operational footnote: NL1506

The fuel requirements are as follows (data given by Framatome, France)

	First load		Replacement loading at equilibrium (after 4 years)	
	900 MW	1300 MW	900 MW	1300 MW
Number of Assemblies	157	193	52	64
Enrichment	2.1/2.6/3.1	2.1/2.6/3.1	3.25	3.15
Tons enriched uranium	72.5	104	24	34.5
Tons enriched UO ₂	82.2	118	27.2	39.1

As seen from the above figures, the uranium requirements are almost linearly dependent on the size; the initial core requires 1.8 tons less than the simple linear extrapolation of the 900 MW unit requirements. For the replacement loading this difference is 500 kg enriched uranium.

The 24 tons of enriched uranium (3.25%) give 780 kg U235 shown in the input/output table.

The discharged fuel contains 22.9 t Uranium at 0.88% (or 201.5 kg U235) and 156 kg fissile plutonium.

Operation factor:

From the Peon Commission report (1978).

1st year	4400 hrs	(50%)
2nd & 3rd year	5300 hrs	(60%)
4th (& foll.) years	6200 hrs	(70%)
Global operating factor for stationary reactor park	6020 hrs	(69%)

Based on the 6200 hrs per year, the electricity production of the 925 MW unit would be 5735 10⁶ kwh.

W E L M M R E Q U I R E M E N T S F O R C O N S T R U C T I O N

R E S O U R C E	Q U A N T I T Y	U N I T	Q U A L	F O O T N O T E
(low) alloy steel	2486.000	metric tons	1	NL1505
(ready mixed) concrete	207975.000	metric tons	1	NL1505
aluminum	68.000	metric tons	2	NL1505
aluminum castings	-1.000	metric tons	0	NL1505
antimony	2.000	metric tons	1	NL1505
brass	522.000	metric tons	1	NL1505
bronze	19.000	metric tons	1	NL1505
capital cost	1797.275	10e6 FF76	1	NL1512
carbon steel	9030.000	metric tons	1	NL1505
carbon total	4.230	metric tons	1	NL1505
cast iron	-1.000	metric tons	0	NL1505
cement	33022.000	metric tons	1	NL1505
chromium	301.540	metric tons	1	NL1505
concrete admixture	625.000	metric tons	1	NL1505
const cost	1361.970	10e6 FF76	2	NL1505
copper	747.900	metric tons	1	NL1505
earth and spoil used	96250.000	m3	1	NL1505
earth moved total	307500.000	m3	1	NL1505
electricity	8.500	10e6 kwh	2	NL1505
electricity indirect	555.970	10e6 kwh	2	NL1502
fuels indirect	5436.200	10e9 kcal	4	NL1502
glass	0.000	metric tons	2	NL1505
inoconel tubes	155.000	metric tons	1	NL1505
insulation	0.000	metric tons	2	NL1505
iron	30.600	metric tons	2	NL1505
iron and steel forgings	-1.000	metric tons	0	NL1505
iron galvanized	-1.000	metric tons	0	NL1505
land total	0.380	km2	2	NL1503
lead	28.300	metric tons	1	NL1505
manganese	253.410	metric tons	1	NL1505
manpower total	2278.500	man-years	1	NL1504
molybdene	22.470	metric tons	1	NL1505
motor fuel total	468.200	10e9 kcal	3	NL1502
nickel	326.610	metric tons	1	NL1505
pig iron	115.000	metric tons	1	NL1505
plastics	0.000	metric tons	2	NL1505
process heat fuel total	0.000	10e9 kcal	2	NL1502
sand	8235.000	metric tons	2	NL1505
silicon	27.250	metric tons	1	NL1505
stainless steel	1428.000	metric tons	1	NL1505
steel castings	108.800	metric tons	2	NL1505
steel field mat. total	26676.300	metric tons	2	NL1505
steel pipes and tubes	344.000	metric tons	3	NL1505
steel plates (magnetic)	700.000	metric tons	1	NL1505
steel reinforcing bar	16350.000	metric tons	2	NL1505
steel structural	9982.300	metric tons	3	NL1505
structural steel shapes	-1.000	metric tons	0	NL1505
tin	7.700	metric tons	1	NL1505
total steel (sum of all kinds)	40590.300	metric tons	1	NL1505
total weight of equipment	-1.000	metric tons	2	NL1505
water intake total	0.000	10e6 m3	0	NL1505
wood	3361.200	metric tons	2	NL1501
zinc	170.800	metric tons	1	NL1505

F O O T N O T E S

footnote: NL1501

WATER:

Water requirements are considered as being negligible. Water consumption during the construction period would consist of:

about 25000 cu.m water for concrete (see footnote NL1505)
and 45500 cu.m water for sanitary and human uses (based on 20 cu.m per man-year or about 65 liters per man-day). See footnote NL1504.
(Manpower requirements = 2278.5 man-years. See footnote NL1504).

Additional water is required for road sprinkling etc.
The total water requirements would therefore be below 100000 cu.m for the whole construction period of 6 years. This quantity is negligible.

footnote: NL1502

ENERGY:

Direct Energy Requirements:

Electricity:

19.2 10e6 kwh (source EDF based on transformer of 630 KVA over 6 years and 5160 hrs/year with an efficiency of 98.5%).

8.5 10e6 kwh (based on the construction of the 2 Fessenheim units)

8.65 10e6 kwh (source: Oak Ridge for a model 1000 MW PWR).

The value of 8.5 10e6 kwh per 900 MW units has been adopted as based on real construction site experience.

Fuels: 468.2 10e9 kcal (based on Oak Ridge model 1000 MW PWR = 1.858 10e12 BTU).

As no detailed quantities were given, but the electricity requirements were estimated quite accurately, we consider this data also to be a fair estimate for a 900 MWe unit.

Indirect energy requirements (Energy contained in construction materials):

Indirect electricity:

515.1 10e6 kwh
40.87 10e6 kwh (depreciation)

555.97 10e6 kwh (source: ref.A)

196.3 10e6 kwh (source: Oak Ridge for model 1000 MWe PWR)

Indirect Fuels:

4491.3 10e9 kcal
444.9 10e9 kcal (depreciation)

WELMM REQUIREMENTS FOR OPERATION

RESOURCE	QUANTITY	UNIT	QUAL	FOOTNOTE
electricity	0.000	10e6 kwh	1	NL1508
land permanent	0.030	km2	5	NL1509
land temporary exclusive	0.380	km2	2	NL1503
land total	0.380	km2	2	NL1509
manpower op.cost	29.130	10e6 FF78	3	NL1513
manpower total	150.000	man-years	3	NL1510
materials (non specified)	-1.000	metric tons	0	NL1511
motor fuel total	3.177	10e9 kcal	3	NL1508
op.cost no manpower	87.390	10e6 FF78	3	NL1513
total op.cost	116.520	10e6 FF78	3	NL1513
water consumption cooling	5.400	10e6 m3	3	NL1507
water consumption process	0.000	10e6 m3	1	NL1507
water consumption total	5.400	10e6 m3	3	NL1507
water discharge cooling	641.900	10e6 m3	3	NL1507
water discharge process	0.000	10e6 m3	1	NL1507
water discharge total	641.900	10e6 m3	3	NL1507
water intake cooling	647.300	10e6 m3	3	NL1507
water intake process	0.000	10e6 m3	1	NL1507
water intake total	647.300	10e6 m3	3	NL1507

F O O T N O T E S

footnote: NL1507

WATER:

The reference has once-through cooling. The water requirements would be as follows (based on various references).

	Water intake	Water consumed	Reference
m3/second	10e6 m3/yr	10e6 m3/yr	
29 (44 for 1300 MW unit)	647.3	-	Gras/Jacquet CEA/EdF, 1975
-	580-895*	4.14-8.95*	Harte/EI Gasseir: Science Vol 199, 1978
40-50	826-1030*	-	Technical University, Hanover, 1976
-	1240*	0	Energy Alternatives, U.S. 1975.
-	-	9.8*	University of Wisconsin, U.S. 1975.
-	-	5.4*	Project Independence, U.S. 1974.

* Values which have been normalized to the reference facility size. The values for France - of 29 m3/second have been used, but are considered as minimum value which would vary by up to a 50% increase. Water consumption (evaporation) was estimated as 5.4 10e6 m3 (based on U.S. data). The temperature increase of the discharged river water would be 15 degrees Celsius. If the powerplant were equipped with natural draft wet cooling towers, this would result in:

- a) an increase of construction cost (about 6%)
- b) small additional land requirements (4 to 8 ha for the cooling towers).
- c) additional material requirements (additional concrete: 31500 m3 or 74025 tons).
- d) an increase in water intake but a decrease in water consumption.

The water requirements when using cooling towers are summarized below.

Water requirements for cooling with cooling towers (*values have been normalized according to the size of the reference facility).

Water intake/yr	Water consumed/yr	Water discharged/yr	Reference
-	11.16 10e6 m3(*) (minimum value)	4 10e6 m3(*)	Gras/Jacquet CEA/EdF 1975
12.3 10e6 m3(*)	5 10e6 m3(*)	7.3 10e6 m3(*)	Ministry of Industry, France, 1972
16.8 10e6 m3	12 10e6 m3	4.4 10e6 m3	Institute for Reactor Research Switzerland 1974
20.2 10e6 m3(*)	-	-	Technical University Hanover, 1976
16.7-24 10e6 m3 (*)	11-18 10e6 m3(*)	-	Harte/EI Gasseir: Science Vol 199, 1978
24.2 10e6 m3(*)	15.1 10e6 m3(*)	9.1 10e6 m3(*)	Energy Alterna- tives, U.S. 1975.
-	13 10e6 m3(*)	-	University of Wisconsin U.S.A., 1975

Values from the Swiss Institute, based on one natural draft wet cooling tower, are shown. However this value must be considered as a minimum (as stated in the CEA/EdF paper) and a deviation of up to 50% is possible. As the water consumption and discharge are not included in the intake figure, the consumption figure was increased slightly to 12.4 10e6 m3.

footnote: NL1508

ENERGY:

Electricity requirements are regarded as auto-consumption of the powerplant in the efficiency and therefore as WELMM value 0

FUELS:

Reference Oak Ridge (Net Energy from Nuclear Power) 1976 indicates a consumption of 90000 gal diesel (= 340690 liters) with an energy content of 3.177 10e9kcal; we used this estimate for a 1000 MW model LMR for our 900 MW facility.

footnote: NL1509

LAND: See footnote NL1503

The permanent land use was assumed to be 3 ha (corresponding to the main reactor buildings).

U.S. references like the USAEC indicate permanent commitment of the order of 10% of the site (which would be, using U.S. data, from 26 to 30 ha for a 1000 MW power plant). For the french sites the value would therefore range

French Subsoil Data Bank
Objectives, Options and Facilities.
State of Advancement of National Geological
Survey Product

P. Solety, J.P. Lepretre and L. Lheureux

Bureau de Recherche Geologiques et Minieres,
BP 6009 45018 Orleans, France

The BRGM data bank is a governmental data bank established for public service purposes. It collects all data concerning prospection and reconnaissance work in the fields of geology, mineral deposits, hydrogeology, geotechnics and administrative data.

The data to be stored are raw data and preprinted natural language data forms are used for input. All these data are ordered hierarchically in a tree structure form. A management system for consultation by insertion of instructions was specially developed and is called GEISHA (abbreviation for data management and extraction from tree-type hierarchical structure).

At the present time there are 85,000 computerized files.

The data can be consulted as follows:

- through the computer system either at Orleans or at the Consultation Center at Paris by terminal;
- manually at all regional geological services by means of printed data forms.

Data consultation is now being developed on a regional basis at several regional services through the installation of subject files containing bank data extracts which are periodically updated. These files can be utilized locally by means of simple programs adaptable to all types of computer.

1. HISTORICAL BACKGROUND

The preliminary work for the establishment of a computerized subsoil data bank was begun by the B.R.G.M. about 12 years ago.

Since 1941 the B.R.G.M. has had the mission under the Mineral Code Law of collecting, managing and making available to the public all geological data concerning the subsoil of France. It was primarily the continuously growing volume of this information which led to the decision to use computerized data processing for these three functions.

A data bank means use of the computer, systematic data collection and standardized methods and languages. The need for technical language and the operational constraints should not, however, be allowed to mask the real objective of a data bank which is to aid individuals in their various functions i. e. design, decision making, construction operations and management.

The creation of a data bank means :

- That a corpus of data is made available to all users. It thus preserves a body of information derived from various sources and guarantees savings of time and expenditure in the future ;
- That specific contributions will be made towards problem solving of problems since the user will have available selected and sorted data .

The B.R.G.M. geological data bank is the result of studies carried out in close collaboration by specialists in documentation, geology and computerized data processing.

a) Documentation :

Whether data collection is computerized or not the documentation system is determined by the following two factors :

a 1) Localization : The information may be either :

- . stored regionally which has the advantages that a smaller volume is handled, operations are simpler and there is easy access because the documentation management is closer to the user ;
- . stored centrally which the advantages of uniformity and coherence in data organization and consultation while an additional positive factor is that access is possible from several locations.

a 2) Type_of_use :

Design of the data bank is conditioned basically by whether or not the use to be made of the stored material, is known in advance.

. If the use is unknown beforehand the bank is organized in terms of a single objective i.e. data storage and retrieval. This organization

implies the following :

- . the data bank is a public service and the original raw data must be conserved. Since all the data cannot be stored the bank must be integrated into a documentation center which can handle the entire body of data in manual form ;

- . estimated or calculated data can also be input in this type of bank but the measurement conditions must be indicated ;

- . data quality cannot be carefully checked at input but verification will take place at the time of data retrieval before processing. Data updating must be possible at all times and at all levels ;

- . since there are many data items of many different types the bank's structure must be carefully designed so as to minimize the time necessary for data access. A hierarchical tree-type structure is the most adequate for this kind of organization.

- . if the later uses of the data are known when the bank is designed the organization will be oriented towards this end. This type of organization will involve the following :

- . any kind of data whether raw or estimated can be stored. However there must be strict verification of data quality and this must be carried out at the various input levels ;

- . the volume of data to be stored will be smaller than in the preceding cases and all parameters which do not enter the quality control or processing programs can be eliminated. The bank can have a simpler design of the chained sequential files type.

b) Geology :

At the present time the B.R.G.M. data bank collects subsoil data of the following types :

- technical and administrative (localization, type, etc...) ;
- geological ;
- geotechnical ;
- hydrological (piezometry, water chemistry).

There have been no special problems connected with the storage, management and computerized retrieval of the technical and administrative, geotechnical and hydrological methods but difficulties were encountered in the case of the purely geological data.

Geological material is processed at the B.R.G.M. data base like all other types of data. An attempt was made to enter raw lithological and stratigraphic data. In order to do this a special syntax was created for the formalization of subsoil or outcrop descriptions with the following elements : depth of roof, stratigraphic name, rock type, one or several adjectives i. e.

- 124,00 m - Middle Muschelkalk-Sandstone, Fine, Porous, Banded.

A section is described by means of a dictionary containing the usual words. The user thus has access to a body of information which can be presented in natural language. The geologist can make use of all the various possibilities of the system in the prospection field.

b 1) Lithology :

The data is processed semantically.

For example : The word sand is analyzed semantically and the implications of the word are stored i. e. the following words : sedimentary, arenite, loose, sandy, etc...

When this word is searched the geologist can go on to all possible further selections which may be simple or quite complex. He can for example retrieve :

- all carbonate rocks and will then obtain : limestones, dolomites, molasses, marls and rocks associated with the adjective calcareous, etc... ;
- the set of consolidated limestones i. e. non-argillaceous, non-dolomitic, non chalky, etc... ;
- all possible intermediate sets or combinations.

b 2) Stratigraphy :

The coding system allows retrieval of the following :

- all stratigraphic levels ;
- the layers on either side of the level and either ending or beginning at this point ;
- the layers which may be associated with the level and undated levels on either side.

For example : The layers associated with the Albian are requested and the following data will be produced :

- The thinner layers : Middle Albian ;
- The thicker layers : Lower Cretaceous ;
- The layers which are likely to be associated : Post Primary or Pre-Tertiary.

In the field of geology the data bank continues to have the basic characteristics of a raw data corpus. This data is available to the geologist and he can search this data but the interpretation in each case is his responsibility.

c) Data Processing :

The following three points must be considered for all data base management :

- the structuring of the data as concerns the essential logical relations rather than possible uses. Hierarchical tree-type structure was chosen for the subsoil data ;
- creation and management of the data base i. e. definition of input, correction, storage and classification procedures ;
- extraction of data i. e. selection, extraction and presentation processes following search procedures.

The main functions of the system are as follows :

- processing of "transaction" files in order to add new data or modify existing data ;
- processing of updating messages for spot corrections or changes in position of hierarchical sub-groups ;
- processing for confirmed modifications ;
- recording of all operations carried out at data base ;
- selection of recordings satisfying criteria of varying degrees of complexity ;
- print-outs of lists and tables in the required make-ups ;
- extraction of files in required formats.

The main facilities available to the manager and users are as follows :

- the possibility of adding to the existing files without it being necessary to rewrite the programs which created the files ;
- existing data is protected against unverified changes ;
- the possibility of modifying or changing the position of a data item or a data branch by message ;
- dynamic management of the real physical disk space without it being necessary to fix the limits in advance. This allows large data volumes to be managed ;
- a powerful search language making very complex questions possible in relatively simple formulations ;
- the possibility of extracting files in required formats

which can be directly used in preexisting processing programs or of obtaining print-cuts of lists or tables of values. The recordings used are selected once only for the same criteria ;

- certain data or structured data subgroups can be kept secret ;
- the data base is protected against accidental destruction ;
- there is integrated management of all system functions and of a group of services so that the manager can follow the development of the base.

2. PRESENT STATE OF THE PROJECT

The B.R.G.M. subsoil data bank is a public service facility which is to a great extent centralized and has been partially computerized. It began to operate 3 years ago and has been running regularly for 2 years. The total data stock amounts 300,000 files describing various kinds of works and operations (petroleum or mining drillings, quarries, water drillings, geotechnical explorations, etc...). The stock grows at the rate of 10-12,000 files per year from regional surveys which are responsible for data collection and coding. The data stock may be consulted by all individuals and companies.

Data processing (coding and storage) is centralized at Orleans and the bank memory contains 100,000 files with 10-12,000 files being added annually.

The computer software known as GEISHA (abbreviation for computerized data management and extraction with hierarchical tree-type structure) * is set on an IBM 370/135 computer with 512 K bits of real memory functioning with the DOS/VS system. The disk volume amounts to 800,000 kilobits of which 200,000 are on-line.

The creation, updating and consultation operations are carried out by batch processing at the computer site.

The output may be printed lists or tables, maps produced by curve plotter or files on magnetic tape.

In 1978 there were two important developments in data bank consultation.

* This software was developed by Yves PETIT of the Information Processing Department of B.R.G.M.

The first concerned magnetic tape files located at certain regional geological surveys. The most important data concerning the regions was assembled and a relatively simple processing program was applied making it possible for nonspecialists to search this material without passing through the central bank.

The second concerned remote consultation of the central data bank. This is now possible from Paris for the main Orleans computer by means of a Sems Solar minicomputer acting as interface between the terminal and the main computer.

3. FUTURE PROSPECTS

The centralized management structure will be maintained and at the same time an effort will be made to regionalize and diversify the bank data.

a) Regionalization :

This means that each regional service will define its own data collection priorities in fields other than work of national interest such as deep drilling. It is impossible to collect all data for the different branches of geology. For this reason themes of general interest such as hydrogeology, geotechnics and materials are chosen for data collection in each region.

The locally selected information is then input into the central bank and added to the general stock. Files are extracted from the central bank on standard media (magnetic tape) which can be searched by simple programs. Most questions can be answered in this way and the rest are treated by the central bank. The files and software designed for these purposes are turned over to the regional surveys which may use them as they wish and can also orient data collection activities in terms of the requests which they receive.

If the present tests are successful remote shared time consultation could be further developed. At the present time this activity is carried out by a Sems Solar minicomputer, a satellite of the main IBM 370 computer, but in the future this function will probably be performed by a more powerful computer with display terminal and printer. Conversation type searching is not yet possible.

b) Diversification :

The data bank was originally created in order to satisfy legally defined needs as a public service but it must now cope with the requests of research workers or planners concerned with specific fields of interest.

The planned developments concern the following :

- Geological material especially in the field of geotechnics, is being integrated into urban data banks. This integration is necessary because of the increasing complexity of large-scale works in cities and urban areas. Three projects are now in the predevelopment phase in three large French cities ;

- A marine geology data bank is being established. This will be independent from the subsoil data bank although it will be designed on the basis of very similar principles and will be managed by the same computer system. The bank will contain geological data from the continental shelf and the seabed.

Diversification and regionalization mean the modification of certain options which were initially selected as concerns computerization in relation to both software and equipment. These two orientations are, however, essential in order to facilitate use of geological data banks by environmental and planning specialists.

- o O o -

o

PART 3

PETROLEUM DATA BASES

Oil Reserves in the Change of Politics,
Technologies and Prices

M. Lorbach

Montan-Universität,
A 8700 Leoben, Austria

The procedure of oil reserves estimation has in general no parallels to reserves estimation of other natural resources. There are so many specialities that no one except the oil experts themselves can evaluate the procedure and compare it with the estimation or calculation of other resources. By this reason there are many misunderstandings and mininterpretations of the published oil reserves.

The various possibilities for additions to the hydrocarbon reserves are discussed as well as the reasons why in the past estimates of oil reserves always have been (and will continue to be) underestimated.

MEANING OF RESERVE-DATA

In 1973 at least it was proved, that mankind is willing to pay far higher prices for hydrocarbons as in the past. With reference to the limited reservoirs it will be clear to everyone to save oil and gas and to take care for alternative energies. The ideas for those alternative energies bear in mind, that hydrocarbons are available only for a short time and that a practical unlimited price dictation of the producers will functionate and that those alternative energies will be equivalent in prices and usefulness.

But as long as the price for hydrocarbons will be raised and people pay it the oil industry will get more possibilities to improve all technologies to raise the reserves and to supply the market. One has on the other side to bear in mind that those prices are not calculated prices and mean an anticipation of more expensive exploration and production possibilities in the future.

The very low indicated reserves on one side will give a big push for alternative energies - and that's good so - and on the other side they let rise the prices - and that not only will strengthen the improvement of alternative energies rather than much more the until now, due to low prices, unused procedures for better exploration, recovery and production of oil and gas particularly in remote

areas and very deep horizons.

It should be no question that higher revenues of the oil industry will be the only way to enlarge future reserves and future supply of oil and gas. All money earned with oil and spent for other purposes will lower the chance of using as much hydrocarbons of the earth crust as possible, we otherwise would never be able to produce by the lack of sufficient capital.

Possibilities of enlarging the hydrocarbon reserves are:

- Intensifying of exploration in known areas,
- Exploration and production of deep horizons,
- Exploration and production of until now unexplored and remote areas particularly in deepwater-offshore and permafrost areas,
- Improvements of oil recovery of known reservoirs.

Some of these possibilities will be discussed here. Unconsidered will stay the huge reserves of tarsands and oilshales, which probably will become biggest competitors to alternative energies.

CLASSIFICATION OF RESERVES

World reserves of oil are rising inspite of strongly-increasing consumption since more than 20 years (Fig. 1).

Right now we have about $90 \cdot 10^9$ tons reserves and

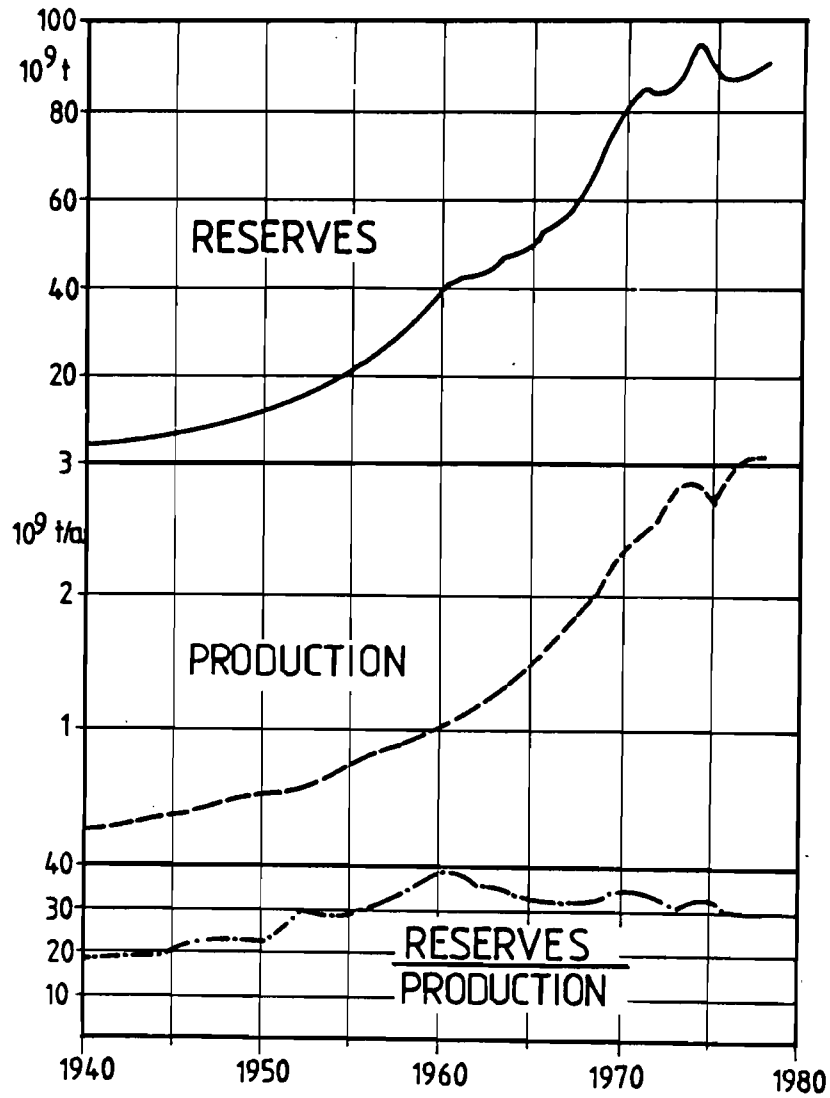

World Oil Reserves - Production
 Reserves / Production - Ratio
 Source: Int. Petr. Encycl. 1978 Stahmer

OK
 183 / 185

Figure 1. World Oil Reserves and Production and Reserves to Production Ratio

therefore at the consumption rate of about $3 \cdot 10^9$ tons per year a reserve-consumption ratio of 30 years. That has not been changed since 20 years either. Also the world gas reserves of $6,5 \cdot 10^{14}$ Nm³ at the climbing trend.

Figure 2 wants making clear how differentiated it is to classify the reserves of oil and gas as of no mineral else. Therefore the comparison of reserves is so difficult and unknown to most people even if they talk about them.

Figure 3 shows the distribution of world oil reserves onshore and offshore for the year 1976 (amounting to about $90 \cdot 10^9$ tons).

Possible oil reserves onshore are estimated at $100 \cdot 10^9$ tons, offshore down to 300 m at $150 \cdot 10^9$ tons. As soon as we will have explored the not yet explored sedimentary basins mentioned here we will have available rather more than $300 \cdot 10^9$ tons of oil instead of $90 \cdot 10^9$ tons.

By this it should be mentioned, that the recovery factor of 25% on an average for oil fields was estimated by the World Energy Conference 1978. And in the figures above the recovery factor is as low as 25%, too.

NEW PROSPECTIVE AREAS

The world has to overcome the situation, that in few countries only we have most of the reserves. Therefore we have to develop new areas. These possibilities have proved to be good recently on results in the North-Sea, in Mexico, Alaska and other areas.

Energy Source	Degree of proof	Development status	Producing status	
Primary Reserves	proved	developed	producing	
		developed	nonproducing	
	probable	undeveloped		
Secondary Reserves (Stimulation, Secondary Recovery, Enhanced Recovery)	proved	developed	producing	
		developed	nonproducing	
	probable	undeveloped		

Figure 2. Classification of Petroleum Reserves.

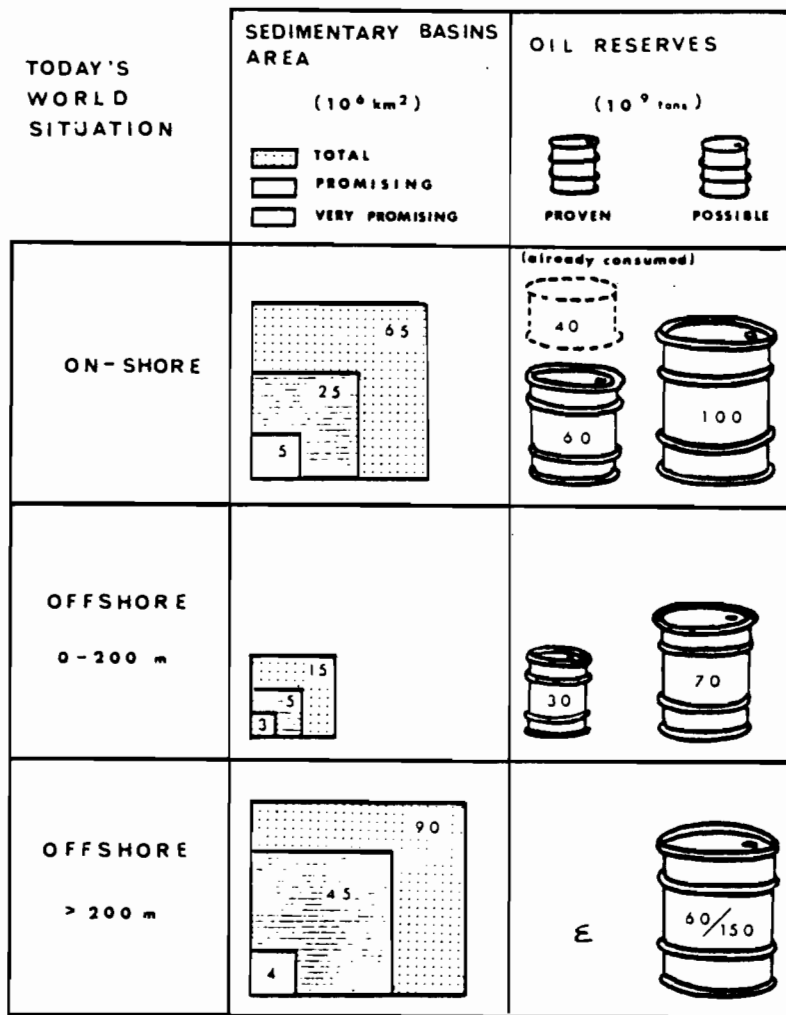

Distribution of World Oil Reserves
Oil 185.1
 Source: Comtet, UNITAR / IIASA 1976

Figure 3. Distribution of World Oil Reserves

Chance No. 1 to improve world situation is going into greater depth. Many new gasfields are indicators for this. Better stimulation jobs to improve permeability also have proven to be successful. The trend drilling depths being ahead of production depths in a distance of about 2000 m. Technical improvement of geophysical surveys, of drilling technologies and of stimulation procedures can be expected. Additional exploration prospects will come into the scenario.

OFFSHORE-TECHNOLOGY

Until up to 1973 we could handle water depths of 150 m. At the time being the world reserves are estimated for 200 m of water, but as shown here 1973 a big technological jump occurred. We are capable of producing oil in 300 m water depth now, and pretty soon we will be able of producing in 1500 m.

Therefore vast areas in addition of today's areas we are able to explore and take into production. The price-increase in the past and in the future does mean new technologies and more reserves and higher production.

The water depth capabilities of offshore drilling operations, depending on use of divers, submarines and other technologies.

The huge concrete or steel production platforms are capable of 150 m of water. Guided towers, vertically fixed by lines, stand up in 300 m of water. But in the future underwater-completion will be the answer in production in practically unlimited water depths. Here the single well will not be extended to the surface but instead of this a manifold station is installed on the bottom of the sea from where production will reach the floating platform. At least 1500 m depth of water

can expected to be surpassed.

PERMAFROST-AREAS

In the last years it became possible to drill wells in permafrost-areas. Therefore large additional prospective areas have been circled in for oil exploration. 75% of Alaska, 63% of Canada and 47% of USSR are covered by permafrost. In these areas permafrost goes down for instance in Alaska and Canada to 600 m and in Sibiria to 2200 m. All difficulties arising in these areas have been overcome.

ADDITIONAL PROSPECTIVE AREAS

In Figure 4* one can see all prospective areas of the world. Every new technology will enlarge these areas, will raise the prospective amount of hydrocarbon reserves. There is no technical limit any more in deepsea-areas just as little as in permafrost countries in north or south.

RESERVOIR-ENGINEERING

By the use of entirely new concepts of enhanced recovery we already know now that it will be possible to raise the recovery factor from an average of 25% to 50% and more.

FUTURE RESERVES

Anyone who has watched the development in the last 50 years got used to the fact that all prognoses of

* Figure 4 ,originally a color slide proved to be not reproducible, it was therefore replaced by a similar graphic [Note by the Editors]

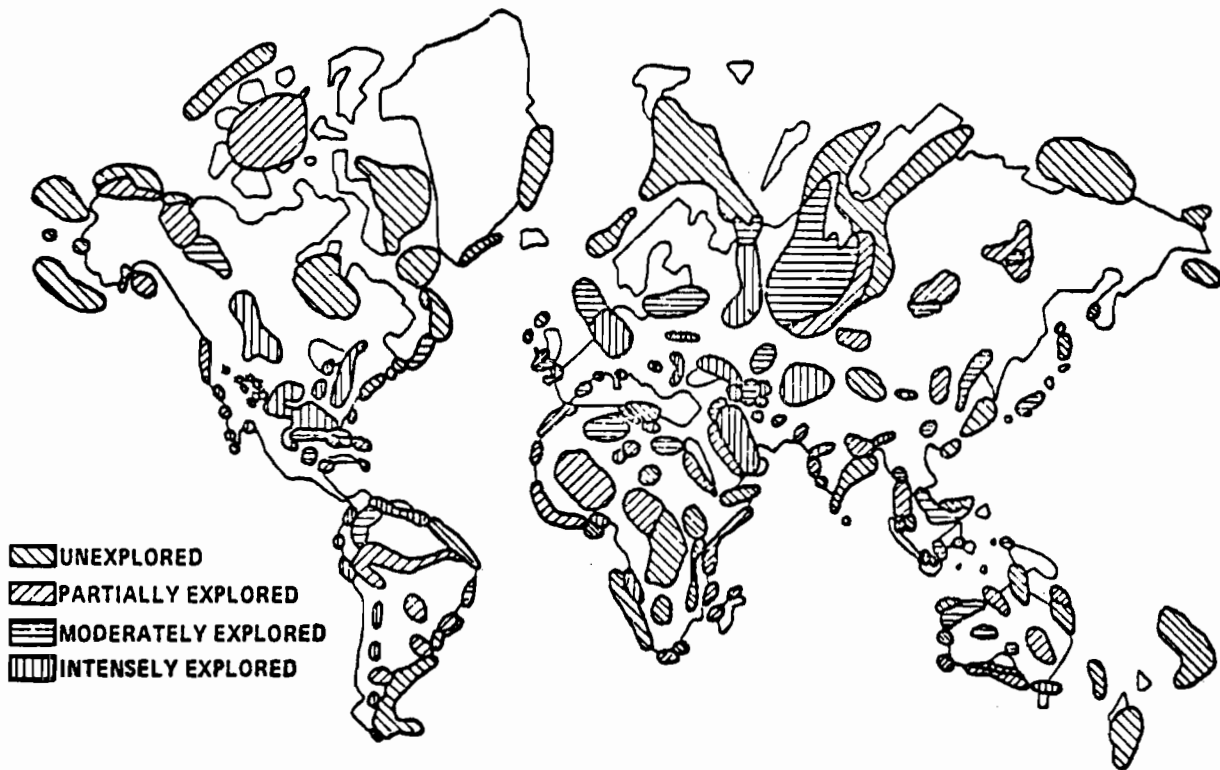

Figure 4. World Oil Basins and Prospective Areas and Exploratory Status

future reserves of oil and gas always and to any time had been wrong. For this fact there are several reasons:

- 1.) Always only the proved reserves that means in all sense the developed and most of the time already producible reserves have been declared. Nobody even thought about the fact that with the rhythm of exploration and production permanent new factors are to be created.
- 2.) In all these prognoses it was neglected, that new technologies always cover new prospective areas. At that time these lie in depth, in intensified exploration particularly in remote areas like deserts, jungles or more recently offshore, in deep sea and in arctic areas.
- 3.) Prognoses of proved reserves in no field of resources are so difficult and complex as with hydrocarbons. Therefore no one should compare figures of these to other resources without knowing the differences as it always has been done.
- 4.) In all hydrocarbon prognoses in the past until now it was neglected, if we used enhanced recovery methods in one field or not. Also in the future there will probably be no change on that.
- 5.) Always it has been realized, that for mentioning reserves only those reserves can be called reserves, if they are explored and can be economically and technically produced with proven techniques.

6.) The changes in prices, availability and politics in no field are as important, powerful and flexible as in the field of oil and gas. Each change in these factors results in the necessity of raising or lowering the figures of reserves, but nobody can afford to do it. Therefore again estimations of oil and gas have to follow the most conservative lines.

Here it should be declared in respect to the way of reserve estimates and consequences thereof that also in future the prognoses of oil and gas reserves will always be far too low again.

By Figure 5 on the x-y-axis you will find out that as soon as a hole is gone to be a successful wildcat estimations will start. Up to the moment the boundaries of the field are known - this sometimes means years of exploitation - we don't know the reserves. They may still lie in a wide range between maximum and minimum. The first better chance we will see, if we can start with dynamical calculations, but that is not before a fairly high amount of the reservoir has been produced. Only from here on the scissors start to close. Because it's always better to be on the safe side any reservoir engineer will follow the lower line, in most cases being wrong.

This calculation is based only on the knowledge of primary recovery.

As soon as we start thinking on secondary or tertiary recovery reserves evaluations until now are even more sophisticated (Figure 5). By stimulations, secondary

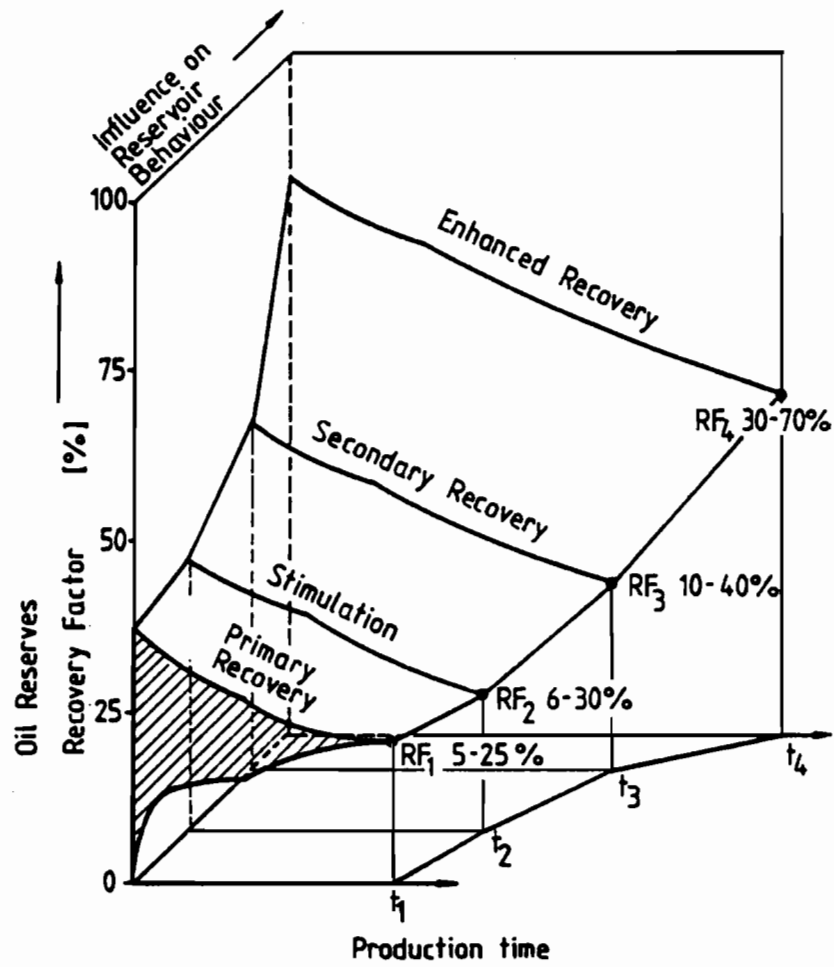

Figure 5. Oil Reserves (Recovery) Dependant on Different Recovery Mechanisms

and enhanced recovery methods, chances are given to increase recovery to 40, 50, 60 or 70%.

But it is easy to understand why results of these applied methods will not be declared before the results are on hand. As soon as we would do it we would come to a conclusion be shown in figure 6.

Herewith the abscissa shows the time interval between 1977 and 2000. This is the estimated time for application of all enhanced recovery methods to increase recovery from 25-30% to 50-60%. Now we have $88 \cdot 10^9$ tons of reserves. If we assume by additional exploration we will only earn a very low rate of $1,4 \cdot 10^9$ tons/year and the raise of consumption will amount to additional $50 \cdot 10^6$ ton/year. By these assumptions the proved reserves from now to the year 2000 will be raised from $88 \cdot 10^9$ tons to $155 \cdot 10^9$ tons. Then the consumption will be on a level of $4 \cdot 10^9$ tons/year.

If somebody can agree with these thoughts, we can, we have to double the reserves of Figure 3. That means, the reserves onshore are at least $200 \cdot 10^9$ tons and offshore - only down to 300 m - are $440 \cdot 10^9$ tons. Totally that means $650 \cdot 10^9$ tons reserves what we frankly can call "proved" reserves.

As soon as we are able to stabilize consumption of $4 \cdot 10^9$ ton/year from the year 2000 on we can estimate having enough "proved" reserves for more than 100 years already now. But we all know that this again is a far too pessimistic - a known wrong - assumption. Only the future will tell us how much more oil and gas the crust of earth will deliver to us.

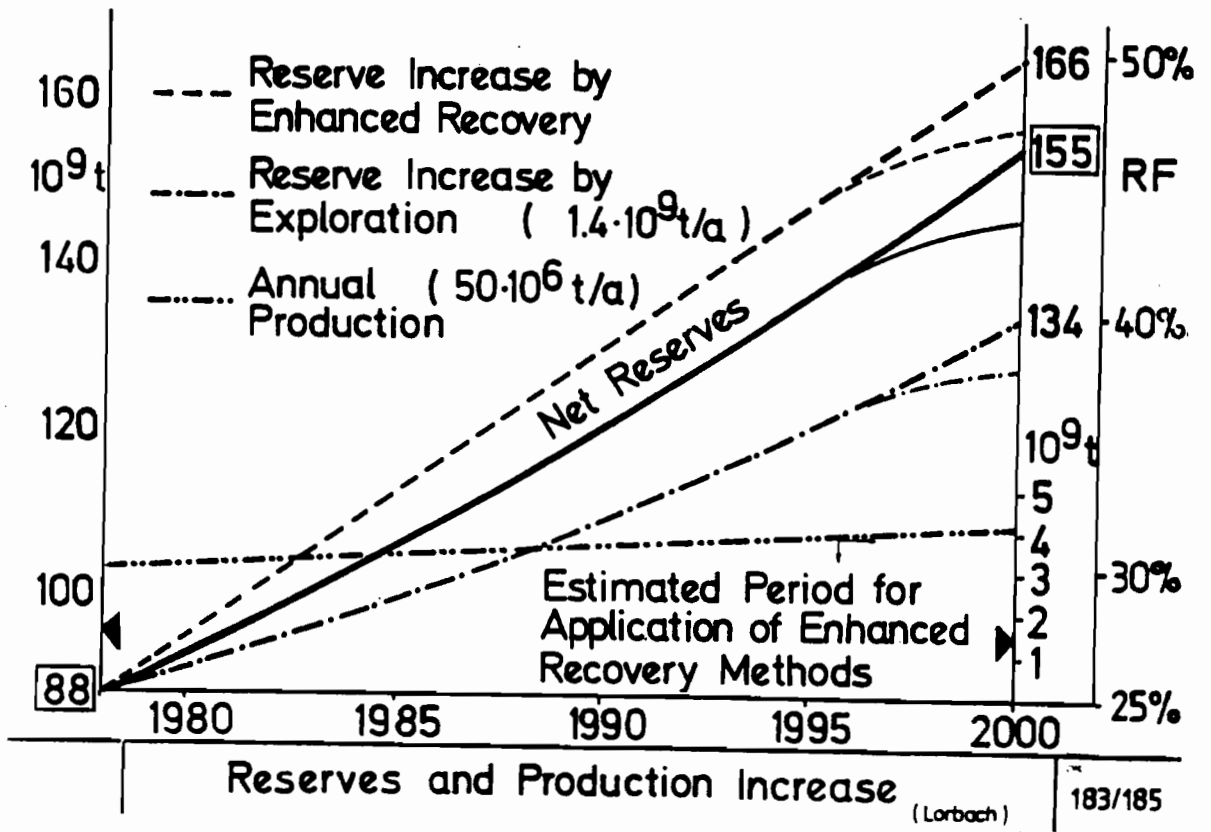

Figure 6. Reserves and Production Increase

LITERATURE

D. Meadows et. al., 1972, The Limits to Growth, New York:
Universe Books

World Energy Conference, 1978, World Energy Resources 1985-2020
Executive Summaries of Reports on Resources, Conservation and
Demand to the Conservation Commission of the World Energy
Conference, Guildford, UK: IPC Science and Technology Press

M. Comtet, 1977, An R&D Effort for Oil Production in Deep Water,
in: R.F. Meyer, Editor, The Future Supply of Nature-made
Petroleum and Gas, UNITAR/IIASA Conference July 1976,
Oxford: Pergamon Press

Some Questions about World Oil Resources
and Data Bases

M. Grenon and S. Medow

International Institute for Applied Systems Analysis,
A 2361 Laxenburg, Austria

Long term energy policies must be based on energy resources and not on reserves, both of them profoundly different in their methods for estimation and the resulting data requirements. The methods for assessing world oil resources as well as the main estimates in the last 30 years are discussed. For the purpose of a better understanding and an independent assessment of world oil resources at IIASA an Oil Resources Data Base has been developed. Two main categories of data are included, such as prospective areas, basins and/or fields characteristics, and historical statistical series on drilling, reserves, production, etc., for a great number of countries. The system of access as well as the contents of the Data Base and its Data Base Management System are briefly presented.

Long term energy policies must be based on energy resources, and not on reserves. Unfortunately, resources are very poorly known. This situation may be understood from the "political" point of view, but is much harder to understand from the "scientific" point of view.

One of the biggest difficulties faced when trying to improve or reverse this dangerous situation is the availability of data.

In connection with our work at IIASA on the problem of world oil resources and future potential of world oil production, we have confronted the difficult problem of oil data and are developing our own Oil Reserves Data Base.

OIL RESOURCES VERSUS OIL RESERVES

It is convenient, although not always easy, to use the McKelvey diagram for mineral resources, with its two perpendicular axes of growing (or decreasing) geological knowledge and growing (or decreasing) economic interest.

We have supplemented this diagram by a table of comments applying to the two categories of reserves and resources (Figure 1). It may be concluded from this table that there is probably more

FIGURE 1
COMPARISON OF RESERVES VERSUS RESOURCES

	RESERVES	RESOURCES
INTEREST IN ...	GREAT	NONE IN THE PAST, NOW EMERGING
TIME HORIZON	10 - 30 YEARS	LONG, OR VERY LONG TERM
ECONOMIC ASPECT	MUST BE PROFITABLE	NON-PROFITABLE TODAY, "SCIENCE FICTION" TECHNOLOGY
ESTIMATED BY	INDUSTRY	MEMBER OF INDUSTRY, OR GOVERNMENTS (INSTITUTIONS)
DATA	MORE OR LESS RELIABLE, CONSERVATIVE, AND "PROPRIETARY", AND EXPLOITATION-ORIENTED	UNCERTAIN OR SPECULATIVE, BUT SCIENTIFICALLY ORIENTED
METHODS	INDUSTRIAL WORK (EXPENSIVE): EXPLORATION, DRILLING, AND MEASUREMENTS	PAPER OR COMPUTER WORK: "GEOLOGICAL", "HISTORICAL"

of a difference between reserves and resources than a simple border line; there may almost be a difference not of degree, but of nature.

Of special importance for our purpose are the differences concerning the data. First, most of the data for estimating the reserves are proprietary (at the field level) and exploitation-oriented. They are more or less reliable, and generally conservative. They result from expensive industrial work, especially from drilling. Passing from field reserves to published basin or country reserves, and then to global estimates (as required by the kind of work we are doing at IIASA!) is a courageous but highly mysterious process, performed either by official persons or by some alchemists known as "journalists" of the professional technical press. This is the well-known problem of the published estimates of "World Oil" and "Oil and Gas Journal", with their unshakeable differences.

Let us remember, however, that there is no similar data for resources. There is, in fact, only some indirect data on resources, highly speculative, and derived by various empirical or pseudo-scientific methods.

These methods are generally a mixture of two different basic approaches (Figure 2): historical statistics, which have been so brilliantly used by King Hubbert for the US, and geological analogy, the most broadly employed, but with different variations (surface, volume, basins, plays, etc.). These methods are already difficult to use in a country very rich in oil statistics, like the US. King Hubbert has, over the last 12 years, often given a more or less constant value of around 170 billion barrels as the ultimate oil wealth of the US, but users of the geological analogy variations gave estimates varying from 150 to 500 - or even more - billion barrels. In most of the other countries (apart from a very few exceptions like Canada), the data base is simply missing. For instance, apart from the giant fields, it is extremely difficult, if not impossible, to estimate the annual additions and attribute them back to the year of discovery (as done for the US by

FIGURE 2
COMPARISON OF METHODS FOR ASSESSING OIL RESOURCES

HISTORICAL STATISTICS **GEOLOGICAL ANALOGY**

PRINCIPLES

- | | |
|--|---|
| <p>1. CHOICE OF REPRESENTATIVE STATISTICS,
 e.g. DISCOVERY RATE $\frac{\Delta R}{\Delta X}$</p> <p>2. EXTRAPOLATION TO THE FUTURE</p> | <p>1. DEFINITION OF SEDIMENTARY REGIONS OR BASINS</p> <p>2. COMPARISON* WITH SOME REFERENCE REGIONS OR BASINS:
 a. SUBJECTIVE (CURRENT METHOD)
 b. SCIENTIFIC (BEING DEVELOPED)</p> |
|--|---|

DISADVANTAGES

- | | |
|--|--|
| <p>— REQUIRES LONG STATISTICAL HISTORY (ONLY A VERY FEW COUNTRIES)</p> <p>— BIASED BY POLITICAL, ECONOMIC, AND TECHNOLOGICAL FACTORS</p> | <p>— POOR (AND INSUFFICIENT) KNOWLEDGE OF UNEXPLORED OR LITTLE EXPLORED BASINS</p> <p>— NO PRECISE EXPERIENCE OF ULTIMATE RECOVERY IN A REFERENCE BASIN (EVEN IN THE US)</p> |
|--|--|

*using historical statistics

King Hubbert), so that historical statistics, if available, are hardly usable for our purpose.

Regarding the method of geological analogy, most of the data and the information are in the hands of the petroleum companies. But independently of this a priori difficulty, let us also mention that there is no consensus on the ultimate potential of a given sedimentary basin. This is partly due to the possible role of deeper formations, which have been insufficiently explored up to now. It is not yet clear when exploration has really exhausted the potential discoveries of a basin.

Figures 3 and 4 illustrate the main estimates of world oil resources over about the last 30 years. These estimates are not independent, in fact, and can be reduced to about half a dozen independent estimates (excluding the Delphi study of 1977)*. Some landmarks are shown in Figure 5. It is worth pointing out that only in 1978, for the first time, did the estimator, R. Nehring, not give his estimate alone, but also explained the method and gave the data which he used!

THE IIASA OIL RESOURCES DATA BASE

A. The Data

The objective of this Oil Resources Data Base is to assemble data which can essentially contribute to the better understanding and to our own elaboration of world oil resources estimates and potential future world oil production, from the basin level (sometimes called the disaggregated level) through the country (aggregated) level to the regional and global levels.

One general comment is that the accuracy - although we hesitate to use this word - or reliability of the data is considered more important for scientific work than its being up-to-date. This attitude is probably different for oil

* Communication by the author to the AAPG Symposium, April 1 - 4, 1979. Houston (Texas, USA).

FIGURE 3
LIST OF WORLD OIL RESOURCES ESTIMATES IN THE LAST 30 YEARS

YEAR	NAME	COMPANY	ESTIMATE x 10 ⁹ bbl	US x 10 ⁹ bbl	%
1946	DUCE	ARAMCO	500	100	20
1946	POGUE		615		
1948	WEEKS	JERSEY	617		
1949	LEVORSEN	STANFORD	1635		
1949	WEEKS	JERSEY	1015		
1958	WEEKS	JERSEY	1500/3000	240	16
1959	WEEKS		2000/3500	270/460	14
1965	HENDRICKS	USGS	1984/2480	320/400	16
1968	WEEKS	WEEKS	2200/3350		
1969	HUBBERT	USGS	(1350-2000)		
1970	MOODY	MOBIL	1800		
1971	WARMAN	B.P.	(1200-2000)		
1971	WEEKS	WEEKS	2290/3490		
1972	JODRY	SUN	1952	190	10
1973	ODELL	UNIV.	4000		
1974	KIRKBY, ADAMS	B.P.	(1600-2000)		
1975	MOODY	MOODY	(1705-2030-2505) 95% 5%	242	12
1976	GROSSLING	USGS	(1960-2200-3000-5600)	182-250	8
1976	KLEMME	WEEKS	1600		
1977	PARENT, LINDEN	IGT	2000		
1977	D E L P H I	IFP	2200/2500		
1978	MOODY	MOODY	2030	300	15
1978	NEHRING	RAND (CIA)	(1700-2300)		

FIGURE 4
EVOLUTION OF ULTIMATE WORLD OIL RESOURCES ESTIMATES

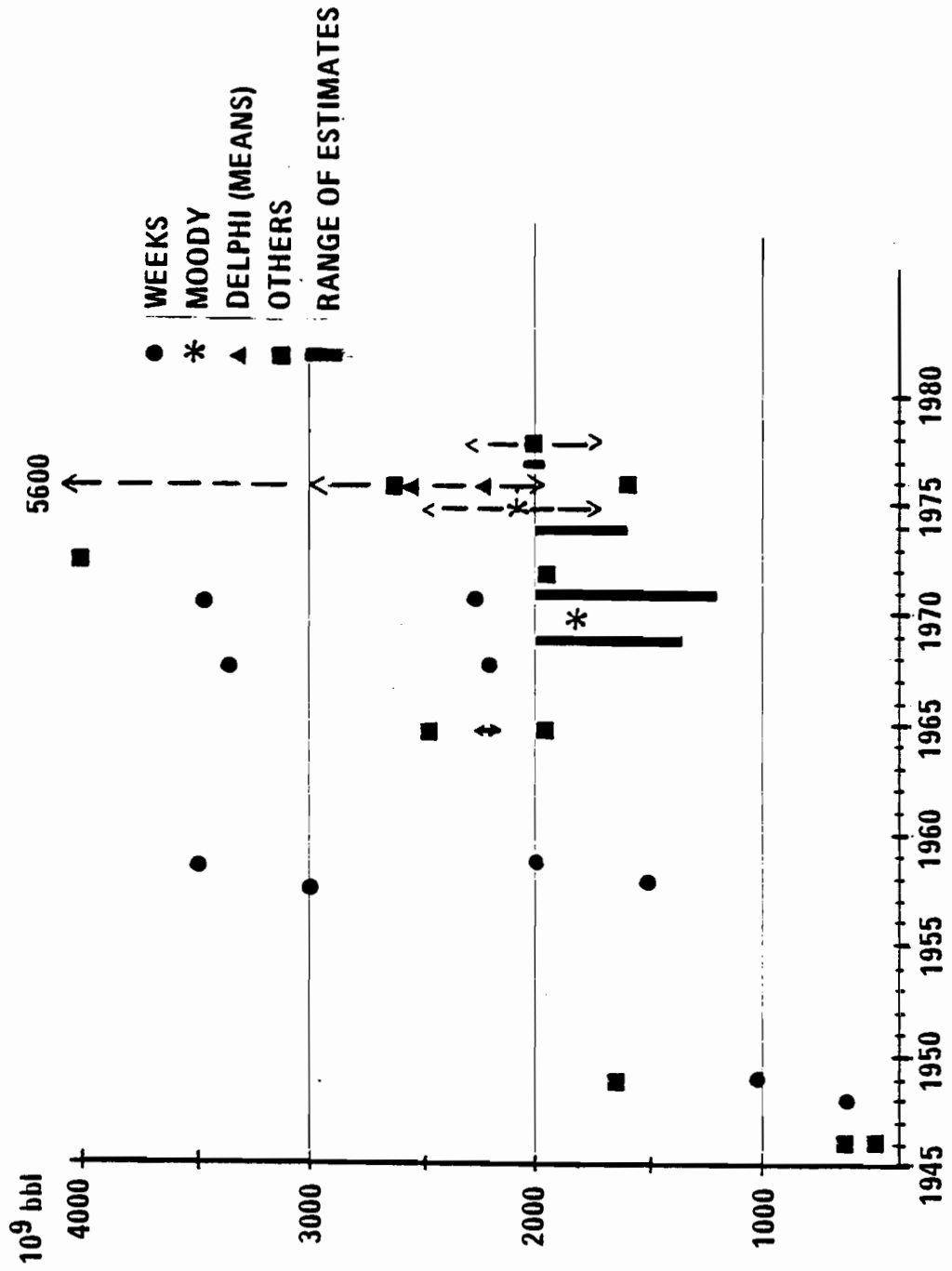

FIGURE 5
SOME LANDMARKS IN WORLD OIL RESOURCES ESTIMATES

1949	INTRODUCTION OF OFF-SHORE	LEVORSEN (PRATT)
1959	REGIONAL DISTRIBUTION	WEEKS
1965	OIL IN PLACE, AND DISCOVERABLE	HENDRICKS
1969	ESTIMATE OF ESTIMATES FIRST "CONSENSUS" 1800-2000 109 bbl	HUBBERT
1970	IMPORTANCE OF GIANT FIELDS	MOODY
1975	PROBABILITY DISTRIBUTION	MOODY
1977	D E L P H I	DESPRAIRES
1978	DISCLOSURE OF METHOD AND DATA	NEHRING

companies, who need the latest information to take urgent and risky decisions and rely on specialized Data Bases developed especially for this purpose.

In the first phase, we have collected and entered data on world oil reserves, production, exploration and development drilling, major fields (giants and supergiants), producing wells, etc., and also on prospective areas and some data on producing formations. We tentatively cover 150 countries (half of them being significant from the petroleum point of view) and statistics from 1952 until today. The main sources of data are technical publications, the most important of which being the AAPG Bulletins, World Oil, Oil and Gas Journal, and the International Petroleum Encyclopedia (1973 to 1978), etc.

For instance, an important effort of validation has been made - and is continuing - for giant or major oil fields, using Halbouty's "AAPG Memoir 14", Nehring's "Giant Oil Fields and World Oil Resources", the International Petroleum Encyclopedia and Oil and Gas Journal (data on production). As a partial result, let us mention that 254 oil fields out of 433 Nehring giants and 604 IPE 1976 oil fields could be compared and nevertheless exhibited large discrepancies among estimated reserve data.

In the second phase, data files have been prepared - and will be computerized later - on producing and prospective petroleum basins. One problem is to select appropriate geological data for known and unknown (from the petroleum point of view) sedimentary basins, plus the appropriate petroleum data for known basins. It is a difficult compromise to make between taking only a few parameters, leading to a simplified classification, such as that of Klemme (based on tectonics) or taking a large or very large number of parameters, such as the French Petroleum Institute's study on petroleum zones (almost 200 parameters, including tectonics, structure, sediments, maturity of components, etc.).

It is clear that some regions are very well documented whilst others are much more difficult to handle, although they may be promising in the future. The North Sea is a good example of the first category and this explains, independently of its economic and political interest, why many studies and models are devoted to the North Sea....

B. The Data Base

This Data Base consists of the relations described in Appendix 1, which are stored via the Ingres Data Base System, developed at the University of California, Berkeley. It consists of a data manipulation language and of a data storage system, which run on the Unix time-sharing system. At IIASA, it is used with the PDP 11/70 computer.

Ingres permits easy manipulation of all the data, allowing the creation of new relations, based on old data, through user specified filters, in clear English language. For example:

```
range of a is reserves
retrieve (a. all) where country = "mexico"
```

will retrieve and show on the terminal screen data on reserves for all years for the country of Mexico.

This data manipulation system also allows us to make calculation. If we wish to see the average oil production for the last five years, it can be specified as follows:

```
range of a is oil prod
retrieve (avg (ann prod)) where
  a. country = "mexico" and
  a. year > 1972 and a. year < 1978
```

or we can compute discovery rates for a given year through the difference of reserves at year end plus production divided by exploratory footage, etc.

To supplement this system, the oil and gas statistical data for a field, country, region or global level are also accessible through a hierarchical data structure system with interactive commands, referred to as the "Tree System"* which uses Ingres as a retrieval tool. This Tree System is implemented to simplify the computer interactions even further for the non-computer oriented user, by making the retrieval process dependant upon answers supplied by the retrieval process, mainly of the yes/no type, to a prespecified subset of possibly needed retrieval filter commands (Appendix 2).

CONCLUSION

How long the oil era can last is probably one of the most crucial questions we face today. Only a very intensive and comprehensive world drilling program, at best, could possibly provide an answer to this question. But partial or tentative answers could also be obtained through more and more studies on oil resources. Basic to these studies are the data: an enormous international effort remains to be made in this field, and IIASA hopes to contribute to it.

* see paper by S. Medow in Part 2 of these proceedings (note by the Editors)

reserves: Data (Source: World Oil)

- country (country, region or world total)
- country code
- year (of data)
- oil reserves (of that year)
- revised oil reserves (from the following year's publication)
- gas reserves (of that year)
- revised gas reserves (from the following year's publication)

oilprod: Oil production statistics (source: World Oil)

- country (country, region of world total)
- country code
- year (of data)
- annual production (of that year)
- revised annual production (from the following year's production)
- daily average production (of that year)
- revised daily average production (from the following year's publication)

drillwells: Drilling statistics (Source: World Oil)

- country (country, region or world total)
- country code
- year (of data)
- forecast of wells drilled (of that year)
- total wells drilled (of that year)
- revised total of wells drilled (from the following year's publication, revised figure)
- total footage drilled (of that year)
- revised total footage drilled (from the following year's publication)

drillresults: Drilling and well statistics (Source: World Oil)

- country (country, region or world total)
- country code
- year (of data)
- number of oil wells (of that year)
- number of gas wells (of that year)
- number of dry wells (of that year)
- number of service wells (of that year)
- number of suspended wells (of that year)

prospareres: Prospective areas, oil statistics (Source: Grossling, Window on Oil)

- country (country, region or world total)
- country code
- area of country
- prospective onshore area
- prospective offshore area
- number of wells drilled (end 1974)
- producing wells (end 1974)
- accumulated production and proven reserves: oil (to 1975)
- accumulated production and proven reserves: gas (to 1975)

Giant oil field data (these fields represent about 80% of world production) derived from International Petroleum Encyclopedia 1974, the following data are stored per field in:

ipefields 1:

- country
- country code
- year (of data)
- number of giant field
- type of field (oil or gas)
- production in year
- accumulated production
- estimated reserves
- number of wells

ipefields 2:

- country
- country of code
- year (of data)
- number of giant field
- type of field (oil or gas)
- name of field
- pay
- depth
- api gravity
- sulfur in wt%
- year of discovery of field

APPENDIX 2

```
% cd Tree
% Tree WELMM
```

TREE VERSION 7.0

```
CURRENT MODE IS : NO ACCESS
ENTER PASSWORD TO ACCESS TREE SYSTEM:welmm
```

```
MODE CHANGED TO : READ ONLY
TREE NAME       : WELMM
TREE STATE      : READ ONLY
TOP LEVEL NAME  : WELMM
PATH            : / 0/
CURRNT LEVEL NAME: WELMM
NO. OF QUESTIONS : 73
```

```
WELCOME TO THE WELMM TREE
(for info type run)
```

```
TO EXECUTE THE INTERACTIVE
QUESTIONNAIRE SESSION,
TYPE: ask 1
```

-> ask 1

```
interested in OIL?                yes
interested in a OIL info of a country?  yes
do you need a list of the available countries? no
please enter name of country        mexico
CURRNT NODE NAME: mexico
PATH                               :/ 1/ 1/ 2/ 2/
was this country found?            yes
do you wish to see oil reserves?   yes
```

RELATION: reserves ATTRIBUTE: oreserves

mexico	1953	Crude reserves at year end	1400000	10E3bb1
mexico	1954	Crude reserves at year end	2000000	10E3bb1
mexico	1955	Crude reserves at year end	2500000	10E3bb1
mexico	1956	Crude reserves at year end	1750000	10E3bb1
mexico	1957	Crude reserves at year end	2065760	10E3bb1
mexico	1958	Crude reserves at year end	2511904	10E3bb1
mexico	1959	Crude reserves at year end	2458252	10E3bb1
mexico	1960	Crude reserves at year end	2458000	10E3bb1
mexico	1961	Crude reserves at year end	2455400	10E3bb1
mexico	1962	Crude reserves at year end	2455000	10E3bb1
mexico	1963	Crude reserves at year end	2603800	10E3bb1
mexico	1964	Crude reserves at year end	2581000	10E3bb1
mexico	1965	Crude reserves at year end	2493948	10E3bb1
mexico	1966	Crude reserves at year end	2650349	10E3bb1
mexico	1967	Crude reserves at year end	2708409	10E3bb1
mexico	1968	Crude reserves at year end	5530000	10E3bb1
mexico	1969	Crude reserves at year end	5570000	10E3bb1
mexico	1970	Crude reserves at year end	5568000	10E3bb1
mexico	1971	Crude reserves at year end	2837062	10E3bb1
mexico	1972	Crude reserves at year end	2833000	10E3bb1
mexico	1973	Crude reserves at year end	2846838	10E3bb1
mexico	1974	Crude reserves at year end	3086893	10E3bb1
mexico	1975	Crude reserves at year end	3431144	10E3bb1
mexico	1976	Crude reserves at year end	8000000	10E3bb1
mexico	1977	Crude reserves at year end	10427977	10E3bb1

RELATION: reserves ATTRIBUTE: revoreserves

mexico	1954	Rev. crude reserves year end	2000000	10E3bb1
mexico	1955	Rev. crude reserves year end	1500000	10E3bb1
mexico	1956	Rev. crude reserves year end	1750000	10E3bb1
mexico	1957	Rev. crude reserves year end	2065760	10E3bb1
mexico	1958	Rev. crude reserves year end	2260000	10E3bb1
mexico	1959	Rev. crude reserves year end	2458252	10E3bb1
mexico	1960	Rev. crude reserves year end	2458000	10E3bb1
mexico	1961	Rev. crude reserves year end	2455400	10E3bb1
mexico	1962	Rev. crude reserves year end	2455000	10E3bb1
mexico	1963	Rev. crude reserves year end	2603800	10E3bb1
mexico	1964	Rev. crude reserves year end	2581000	10E3bb1
mexico	1965	Rev. crude reserves year end	2493948	10E3bb1
mexico	1966	Rev. crude reserves year end	2650349	10E3bb1
mexico	1967	Rev. crude reserves year end	5486000	10E3bb1
mexico	1968	Rev. crude reserves year end	2744122	10E3bb1
mexico	1969	Rev. crude reserves year end	5570000	10E3bb1
mexico	1970	Rev. crude reserves year end	2879652	10E3bb1
mexico	1971	Rev. crude reserves year end	2837000	10E3bb1
mexico	1972	Rev. crude reserves year end	2832719	10E3bb1
mexico	1973	Rev. crude reserves year end	2846838	10E3bb1
mexico	1974	Rev. crude reserves year end	3086893	10E3bb1
mexico	1975	Rev. crude reserves year end	3431144	10E3bb1
mexico	1976	Rev. crude reserves year end	7278913	10E3bb1
mexico	1977	Rev. crude reserves year end	0	10E3bb1

REVISED ANNUAL OIL PRODUCTION

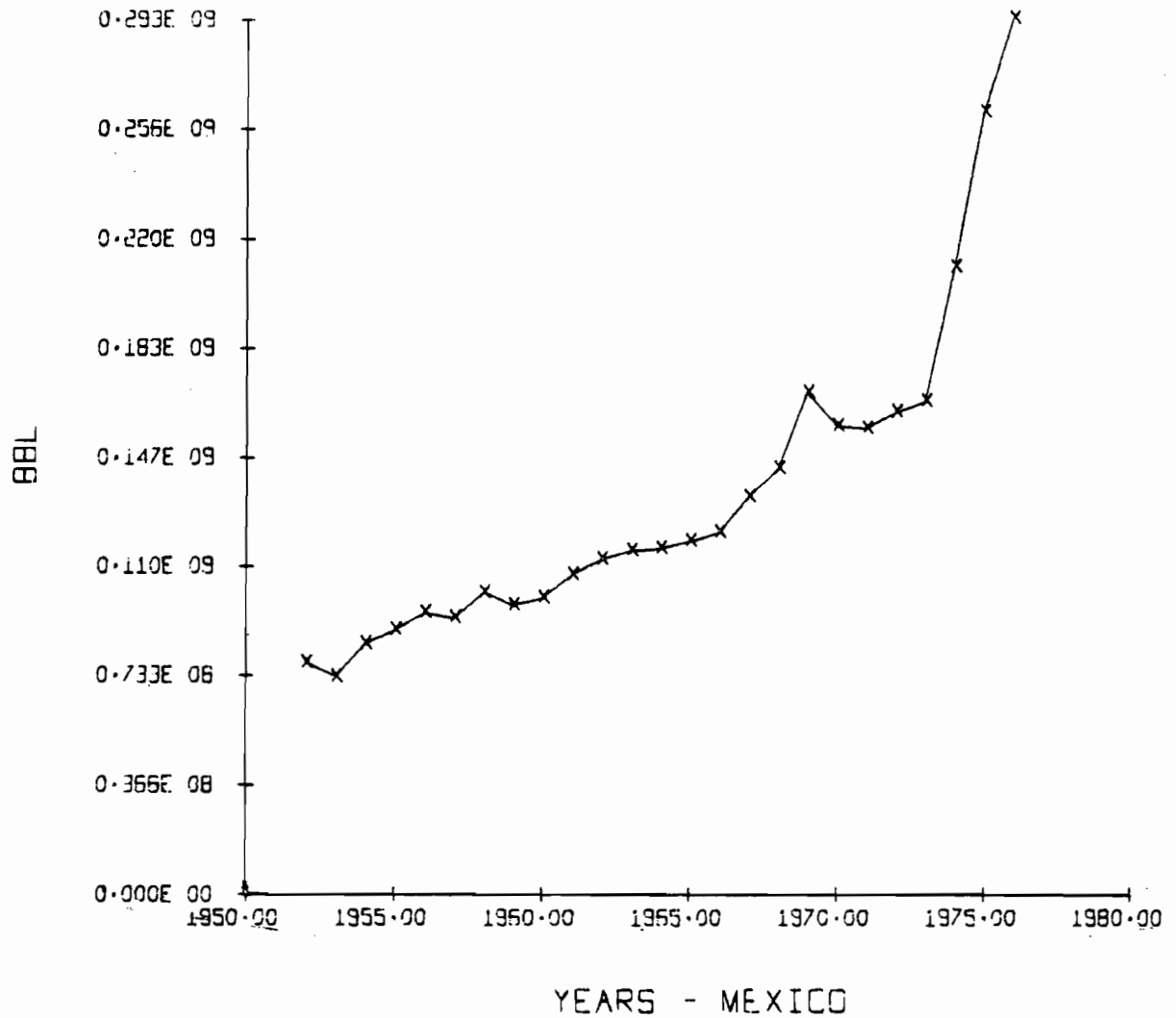

YEAR
REVANNPR

OIL DRILLED WELLS

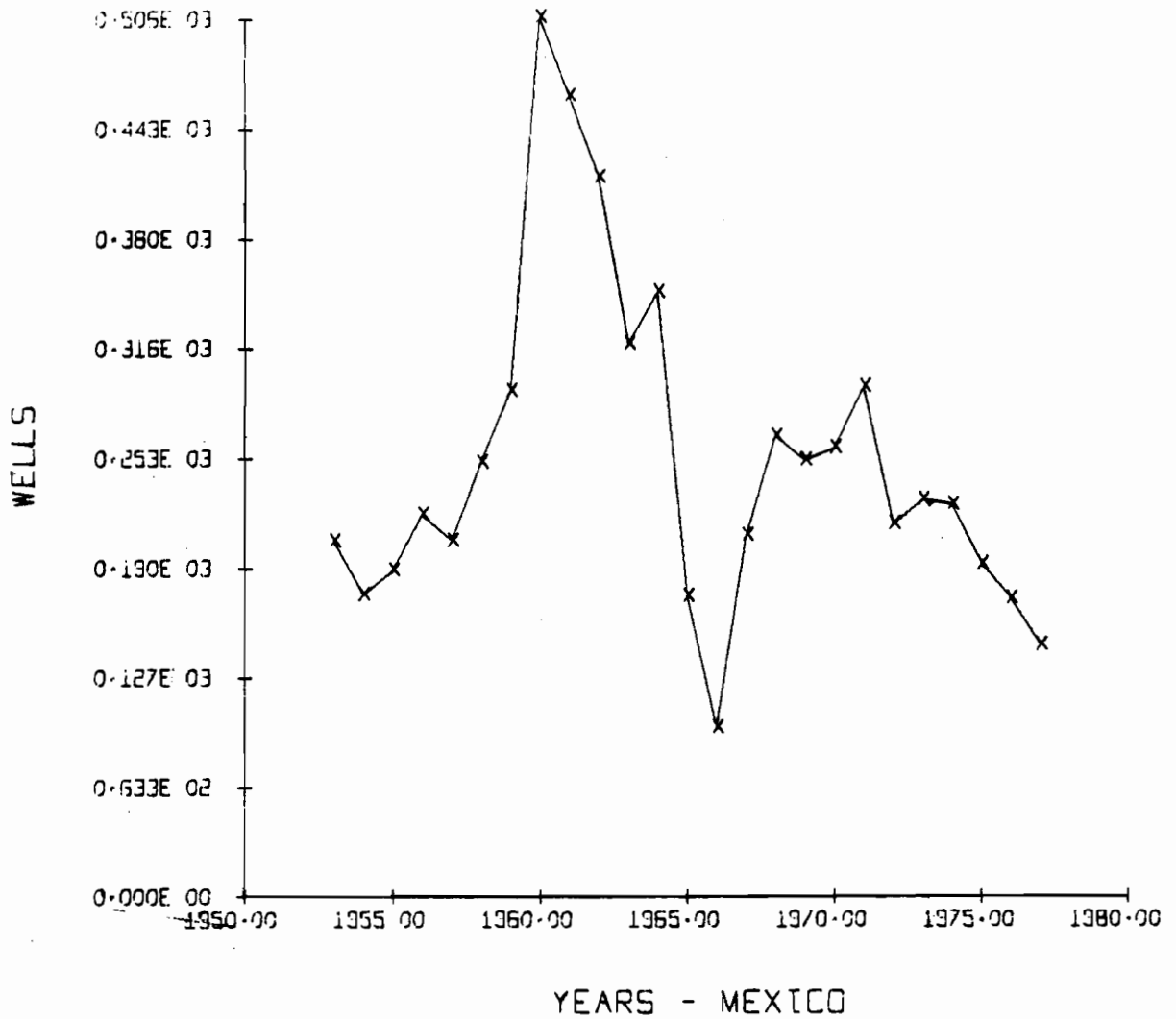

YEAR

— x — OILWELLS

Petroleum Exploration Data Base of Petroconsultants

J. Marc Lador

Petroconsultants S.A.,
P.O. Box 319, 1211 Geneva, Switzerland

Petroconsultants SA is a Swiss enterprise engaged in consulting for the oil industry, primarily for worldwide exploration. One of the major products of the company is a news bulletin describing exploration and production activity in the world except the USA: the Foreign Scouting Service which is supplemented by the Review of Sino-Soviet Oil for the communist countries.

In the frame of the Foreign Scouting Service monthly reports, maps and summaries, annual reviews and well history records for completed exploratory wells are published. All reports are divided in five major sections covering respectively the concessions (all petroleum exploration or production rights), the surface exploration activity (field geology, gravity, seismic or other geophysical surveys), wildcat drilling (usually new-field wildcats only), development and extension drilling and oil or gas production. In average, about 1,200 wildcats are drilled yearly in the countries covered by the Foreign Scouting Service. With nearly 20 years of activity, it is clear that traditional manual files start to be too bulky for practical handling. On the other hand, there are about 3,500 concessions or licences currently valid in the world with about 30% of them being modified every year so a constant maintenance service is needed.

The original LEXIS data base (C and W files) was initiated in late 1975. The scope was to include all current concessions and all wildcats drilled since World War II. This was achieved in most cases, even better for a few countries. This original data base includes some 3,300 concessions and over 17,000 wildcats.

Although not usually released, a large number of formation tops have been included in the original collection, more than 25,000, principally in the following countries: Australia, Pakistan, France, Spain, Turkey, Algeria, Colombia, and Argentina.

The format and contents of the individual data files as well as an overview of the amount of records they contain are presented.

INTRODUCTION

Petroconsultants is a Swiss energy consulting firm with primary experience in international oil exploration. For the last twenty years, its major product has been the Foreign Scouting Service, a monthly bulletin describing developments in the international oil exploration and production industry. Including an affiliate company in Dublin, Ireland, Petroconsultants employs about 100 people, of which more than 30 are geologists or engineers.

An average of 1,200 exploratory wells are drilled every year in the countries covered by the Foreign Scouting Service, i. e., the world except for North America, Eastern Europe, the USSR and China. Some 3,200 licences or contracts are in force in these countries of which 30 percent are modified or replaced every year. After 20 years of operations, our manual files became difficult to maintain and computerization became necessary.

We currently have five files in operation which cover oil companies and groups of companies, concessions, exploratory wells, oil and gas fields and periodical statistics by company and country. The concession and exploratory well files are used in the preparation of the Foreign Scouting Service. The oil and gas field file is being implemented as a special and separate service. All files are used for different surveys or reports, whether exclusive or non-exclusive. The company file may be considered as an auxiliary file used as a look-up for all other files.

We also have three files in preparation for respectively development wells, monthly production data (per field whenever available) and exploration/development costs.

ORGANIZATION AND INTER-RELATIONS

Although our files are maintained on-line as disk files by our own management software, they are provided to clients as 80 byte, EBCDIC, sequential records. The lay-outs of these sequential files dictate disk file organization and consequently is worth looking at closely. The identifying key of the records in all our files is composed of three elements:

- 1/ The card code in the first four columns which identifies the type of data found in the record. The first letter of the card code indicates the file type (Table 1).
- 2/ The unique code number (UCN) which differentiates each element of the file (well, company, etc.). It always starts with a country code in columns 5 to 8 and extends to column 20 or less depending on the file.
- 3/ Sequential parameters to differentiate repeating records within the same element.

Whenever possible, meaningful data have been used to form unique code numbers and sequential parameters. Table 1 summarizes the way these have been formed for the five files. Taking the example of the company file (A file), whose format is shown in figure 2, we can see that its UCN is composed of four meaningful elements (country code, international company code of operator, company type indicator and date of formation of the group), thus using only one arbitrary element. One sequential parameter is used in this file. This is the first eleven columns of the partner UCN from that file (columns 11 to 21 in AC01 records).

For practical reasons, our five files are not fully transparent to each other but there exists a number of inter-relations as indicated on figure 1. All files are related to the company file. The well file may refer to the concession file to obtain the concession in which any well was drilled. The oil and gas field file may refer to the concession file to see in which concession the field is situated and to the well file for detailed information on the discovery well. Additional file linkages are planned for the future, particularly from the well file to the field and statistical files and from the concession file to the statistical file.

FILE FORMAT

The various data which can be entered into the system are described briefly in figures 2 to 6. Table 2 indicates for each file the positions of the unique code number, sequential parameters and data within the 80 column format. This table also shows the number of fields and records in each file, including those which may repeat.

In order to describe a licence through all the steps of its life, this file has four levels of hierarchy:

- 1/ Permanent data such as bonus, general commitments and conditions.
- 2/ General data valid for a specific period such as area, ownership or expiry date.
- 3/ Geographical entity (block) as more than one may be valid during the period.
- 4/ Geographical coordinates defining the various corners of each block.

The most recent of these files, the statistical file (S file) is a summary of the rightholding situation and activity of each company and group in every country apart from North America and the communist countries. This includes the number of wells spudded and completed (classified per status), footage and rig-months for exploratory and development wells, party-months of surface exploration work, mileage of seismic surveying, oil and gas production. Reserves data are also contemplated for the future. The file exists for 1977 and 1978 whereas historical data as of 1972 are under preparation.

ENTRY AND VALIDATION

Data entry is now divided between Geneva and Dublin. Geneva enters current data related to the Foreign Scouting Service bulletins while Dublin maintains historical information for which a special research system has been organized. In both locations, maintenance is interactively carried out by geologists. The Geneva computer is a DEC PDP 11/60 with 96 kwords capacity and two 14 megabyte disks with an additional 28 megabytes disk planned. A comparable system is used in Dublin.

Everybody is aware that the quality of a database directly depends on the quality of the data entered in the files. For this reason, two types of validation are conducted on our data. First, machine validation by various programs and secondly, manual validation. The machine validation system is composed of three steps: interactive checks, batch validation runs and graphic control. Interactive checks are automatic and prevent any duplicate keys, sorting errors and structural problems in general. Simple logical controls, such as spud date before completion date, are performed at input time. The batch validation programs check a large number of data for possible logical errors, a number of which are specific to individual countries. The resulting error listings are then used for interactive correction. Coordinates control, particularly concession corners, is performed by computer plots. They are made at appropriate scales and projections for visual comparison with existing maps.

Once the machine validation procedure is completed, all data are printed in plain-language formatted report forms for final visual control by geologists. Any errors detected at that stage are corrected interactively.

Data quality indicators are attached to many fields to indicate their accuracy as some data are estimates or approximately reported to us. For instance, it is worth reporting that a well's total depth is about 10,000 feet rather than nothing. In that case, however, it is imperative to indicate within which range this value is correct.

ENTRY AND VALIDATION Cont'd

The number of fields in each file which is thus qualified is as follows:

Company (A)	1
Statistics (S)	13
Concession (C)	3
Oil and gas fields (R)	32
Wells (W)	13

FILE CONTENT

As a rule, we have tried to enter all data available into the database but we have been limited for various reasons. For concessions, the scope was to enter all concessions valid as of the creation date of the file (between 1974 and 1976 depending on the country). This was achieved, except for Venezuela, Germany onshore and Japan onshore where complete data are not available. For wells, we endeavoured to include all new-field wildcats drilled after World War II. This could not be done in some countries but even older new-field wildcats have been entered in many other countries, on the other hand. All oil and gas fields for which a minimum of geologic information was available are being entered into the Field file. Table 3 indicates per area the number of elements and records found in each file.

Much of the data which could be entered in our files are considered confidential by companies or governments, at least for a certain period. In each file, there are a number of particularly important parameters which are being constantly researched for improvement. Table 4 indicates some of these interesting parameters. For those corresponding to repeating records, such as formation tops, the number of elements in which they occur is also shown.

TABLE 1

ELEMENTS OF IDENTIFYING KEY AND SEQUENTIAL PARAMETERS

- U C N -			- Sequential Parameters -	
<u>File/Figure</u>	<u>Parameter</u>	<u>Columns</u>	<u>Parameter</u>	<u>Columns</u>
A (company)	a/country code	5-8	a/partner UCN	21-31
2	b/code of optr	9-12		
	c/type of company	13		
	d/arbitrary number	14-15		
	e/formation date	16-19		
S (statistics)	a/country code	5-8	a/period	20-25
3	b/company UCN	9-19	b/situation	26
C (concession)	a/country code	5-8	a/period(arbitr.)	14-17
4	b/situation code	9	b/block(arbitr.)	18-19
	c/arbitrary number	10-13	c/point(arbitr.)	21-22
R (field)	a/country code	5-8	a/test N°(arbitr.)	22-23
5	b/situation	9	b/pay top	17-22
	c/field type	10	c/reservoir(arbitr.)	23
	d/discovery year	11-14	d/year of data	18-21
	e/arbitrary number	15-16		
W (wells)	a/country code	5-8	a/test N°(arbitr.)	22-23
6	b/situation	9	b/depth top	22-26
	c/quadrant	10	c/drlg seq. (arbitr.)	21-22
	d/degrees long.	11-13		
	e/degrees lat.	14-15		
	f/minutes long.	16-17		
	g/minutes lat.	18-19		
	h/arbitrary number	20		

TABLE 2

SUMMARY OF FILES LAY-OUT AND FORMAT

<u>File</u>	<u>Figure</u>	<u>Columns</u>		<u>- N° of records-</u>		<u>- N° of fields-</u>		
		<u>U C N</u>	<u>parameters</u>	<u>Data</u>	<u>Total</u>	<u>Repeating</u>	<u>Total</u>	<u>Repeating</u>
A (company)	2	5-19	21-31	32-39	3	1	10	3
S (statistics)	3	5-19	20-26	34-78	5	5	52	52
C (concessions)	4	5-13	14-22	24-80	10	7	101	74
R (field)	5	5-16	17-23	24-80	22	13	264	147
W (well)	6	5-20	21-26	27-80	14	5	151	44

TABLE 3
NUMBER OF ELEMENTS IN THE FILES

<u>Area</u>	Valid				
	<u>Companies</u> <u>(records)</u>	<u>Statistics*</u> <u>(records)</u>	<u>Concessions</u> <u>(records)</u>	<u>Fields</u> <u>(records)</u>	<u>Wells</u> <u>(records)</u>
Latin America	665 (2,557)	212 (427)	279 (6,124)	1,105 (20,359)	4,323 (36,986)
Europe	1,436 (8,179)	761 (1,106)	1,740 (26,654)	903 (16,112)	6,709 (63,048)
Near East	244 (1,317)	98 (214)	82 (2,950)	251 (4,763)	1,021 (10,223)
Africa	783 (4,183)	329 (600)	630 (12,289)	659 (10,283)	4,465 (49,268)
Far East	960 (4,683)	425 (687)	494 (14,965)	709 (11,969)	3,405 (40,354)
Communist countries	---	---	---	1,089 (20,804)	---
TOTAL	4,088 (20,919)	1,825 (3,034)	3,225 (62,982)	4,716 (84,290)	19,923 (199,879)

* Values for one period only (year 1978).

TABLE 4
OCCURRENCE OF SPECIAL DATA

	Well File		Test Data*	Oil & Gas Fields	
	BH formation	Formation tops*		Oil reserves	Prod Data
Latin America	2,459	4,867 (794)	1,019 (750)	262	769
Europe	2,562	9,786 (1,532)	861 (626)	203	557
Near East	337	404 (52)	226 (111)	131	109
Africa	1,056	1,582 (357)	901 (449)	244	334
Far East	1,571	5,636 (721)	1,254 (623)	80	316
Communist countries	---	---	---	144	560
TOTAL	7,648	22,275 (3,456)	4,261 (2,559)	1,064	2,645

* These being repeating records, the number of wells is given between brackets.

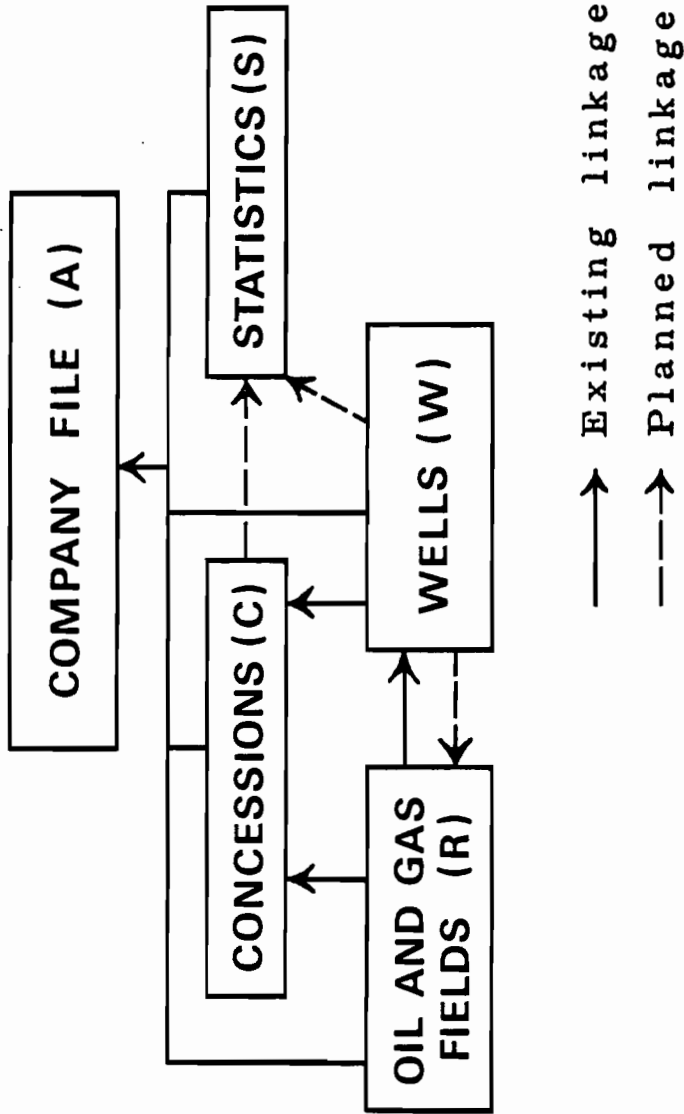

FIG. 1 - INTER-RELATIONS BETWEEN THE FIVE FILES

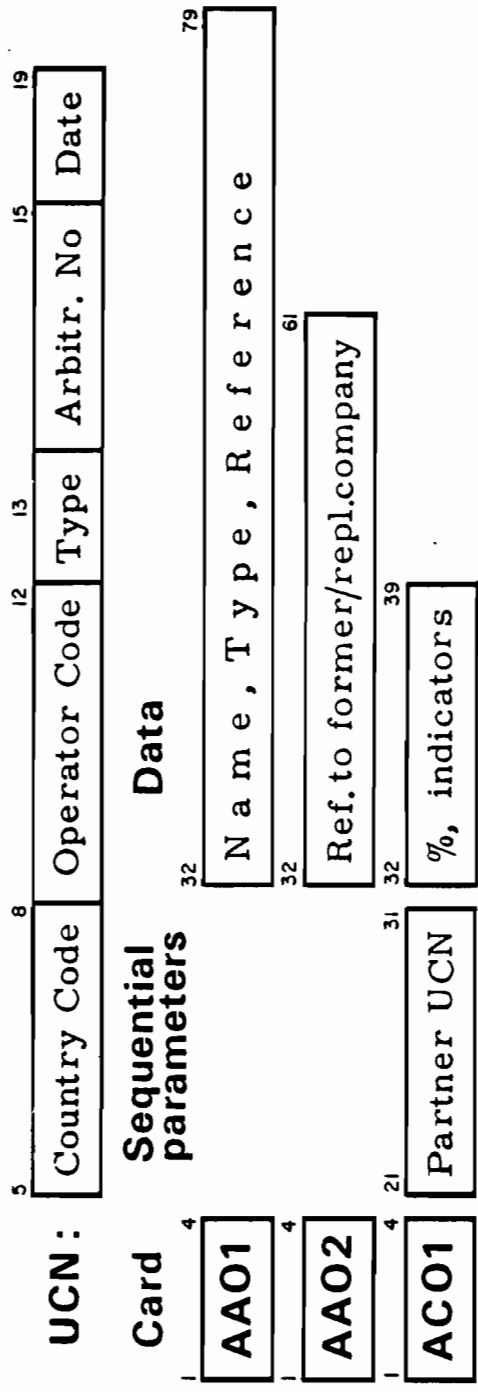

FIG. 2 - COMPANY FILE FORMAT

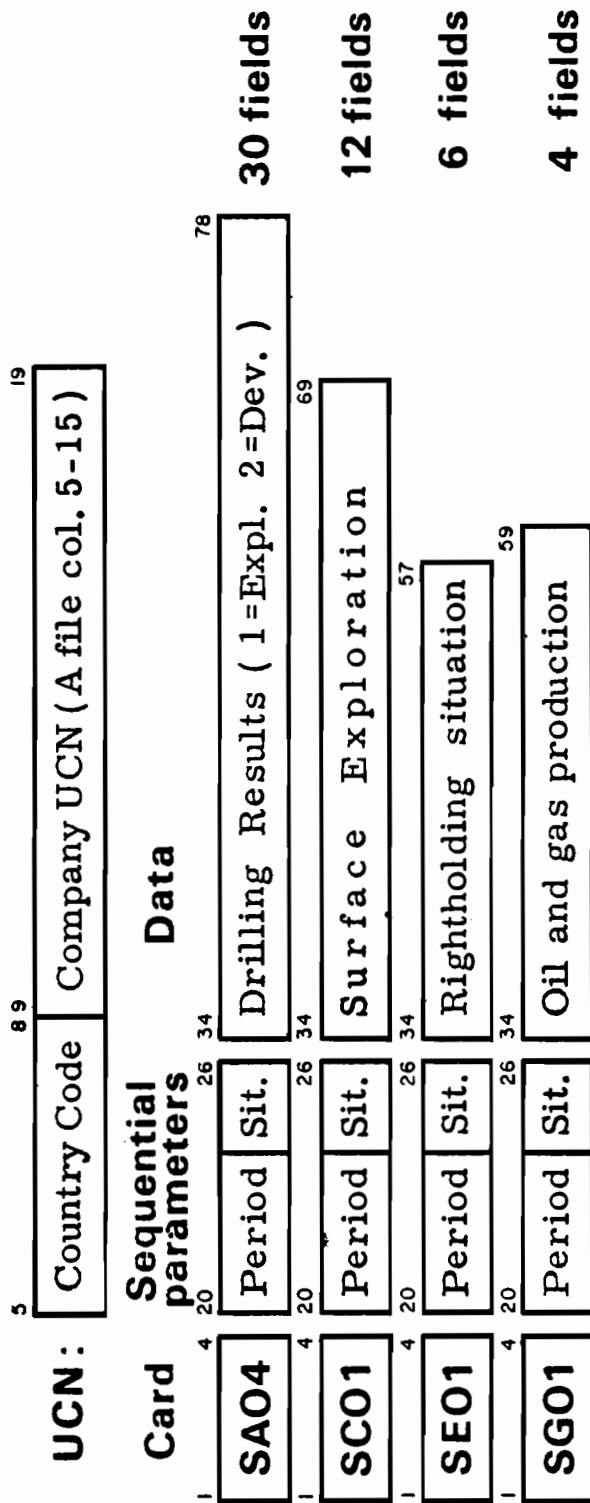

FIG. 3 - STATISTICAL FILE FORMAT

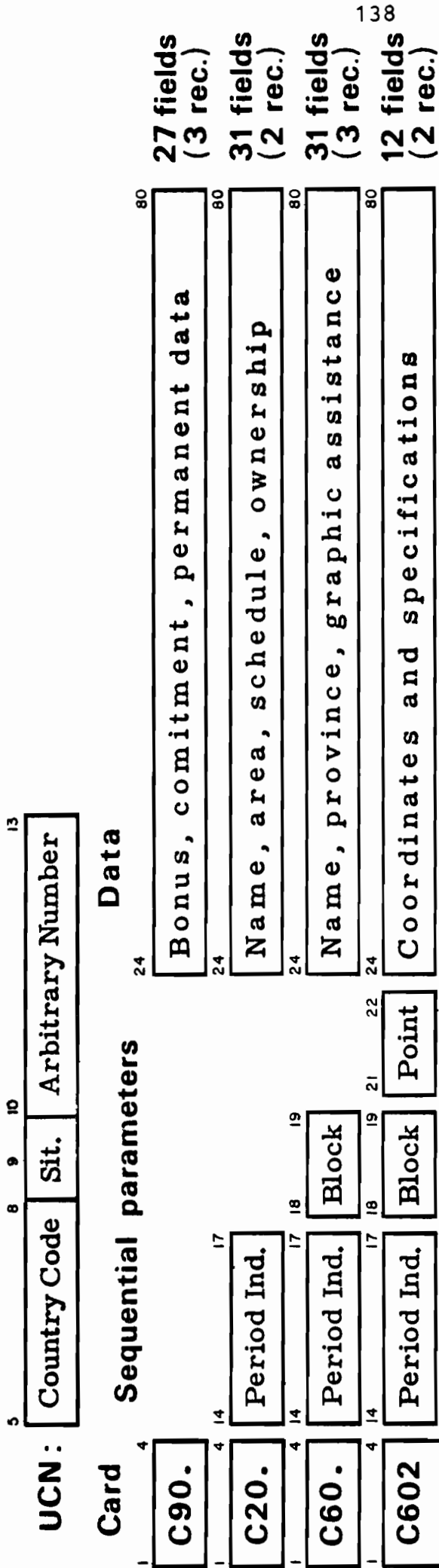

FIG. 4 - CONCESSION FILE FORMAT

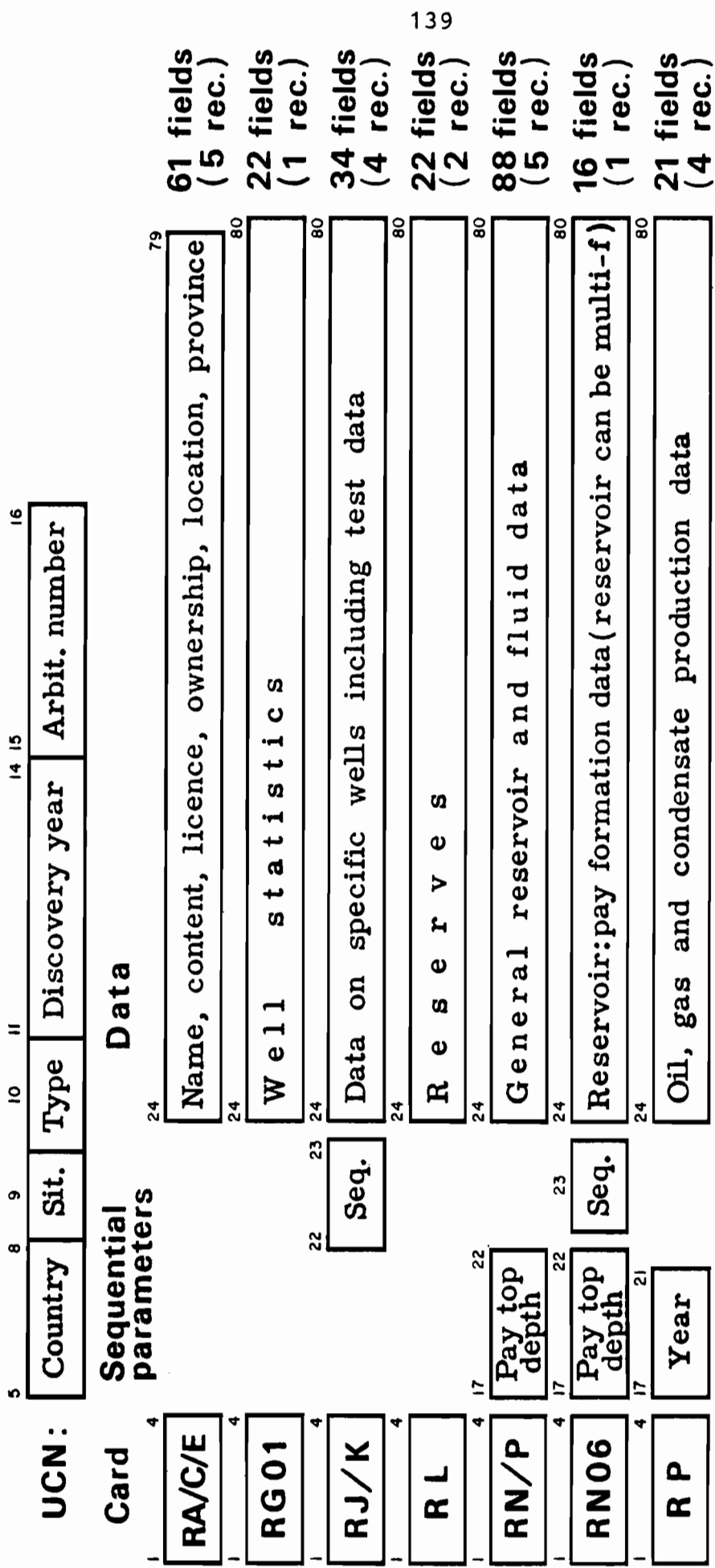

FIG. 5 - OIL AND GAS FIELD FILE FORMAT

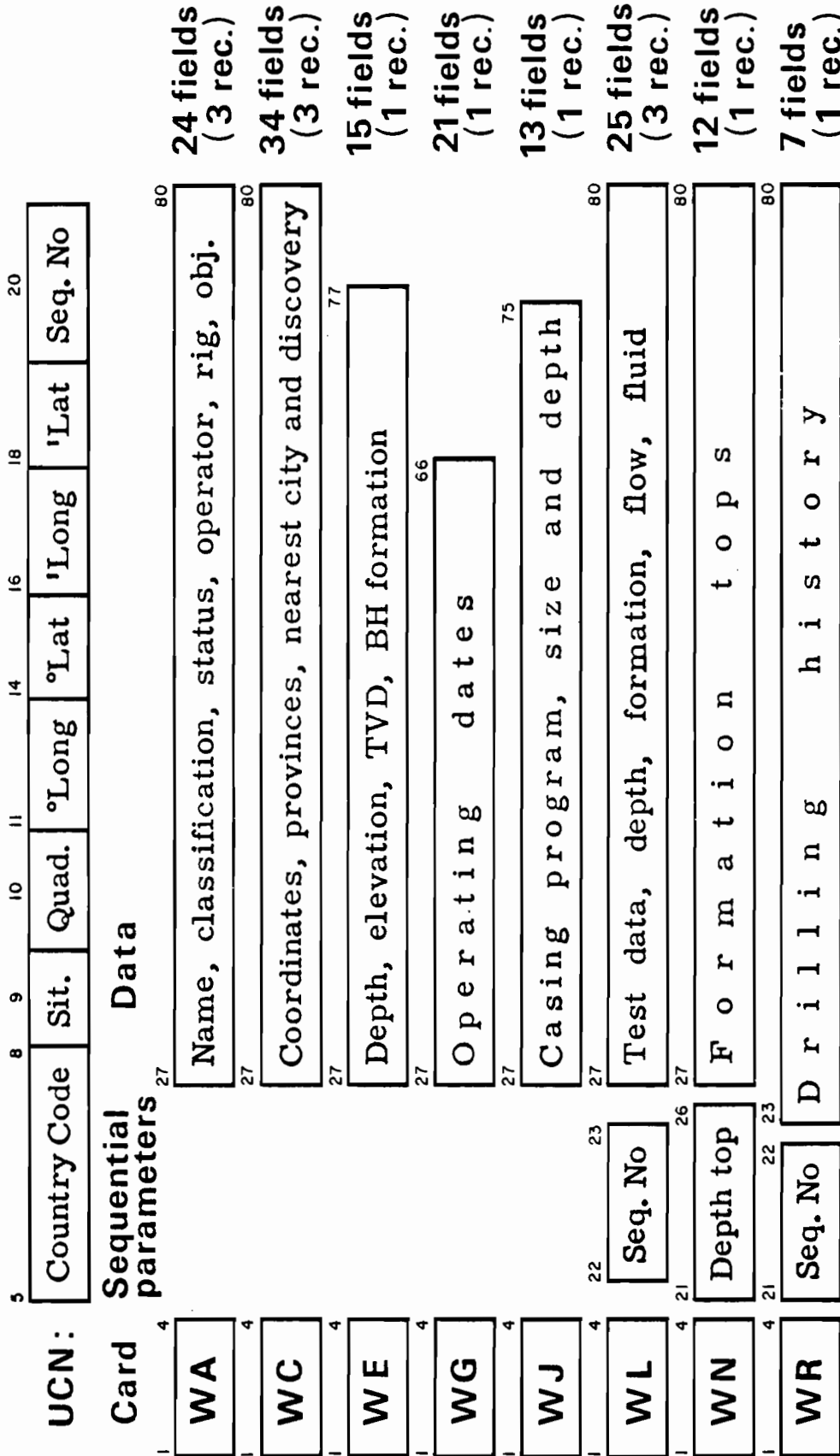

FIG. 6 - WELL FILE FORMAT

Commercial Well and Production Systems in the United States:
Implications for International Energy Data Bases

Philip H. Stark

Petroleum Information Corporation
1375 Delaware Street, Denver, Colorado 80201 U.S.A.

The US petroleum industry has created large computerized data files to support the exploration and management of domestic oil and gas resources. The two major petroleum data bases are the Well History Control System (WHCS) and the Production Data System.

The WHCS developed by the Petroleum Information Corporation contains records on more than one million wells. The file includes general information such as operator, location, depth and dates, initial potential and production tests, drillstem tests, cores, formation tops and information on logs and casing. Interpretive data such as lithology, paleontology, geochemistry and drillstem test analyses are added to the commercial WHCS file on a proprietary basis. The data content and the file structure of the WHCS are presented in more detail.

The main objective for the development of the Production Data System was to create a standard national production format as opposed to the diverging formats and reporting requirements developed by each producing state. The major data components include identification records, monthly production values and well production tests. Secondary recovery data are also reported.

The well and production data files are the primary source of information for resource analysis. Their possible applications in the area of petroleum resource evaluation are discussed and examples for data base applications presented.

INTRODUCTION

The world's energy problems provide ample evidence of the need for comprehensive international energy data bases. Planners and policy decision makers in government and industry require accurate information on resources, exploration and production activity and productive capacities. Consuming nations also desire information on transportation, refining, marketing, economics and alternate energy supplies. As a starting point, it is important for each nation to manage its own energy resources. This is especially true for nations that have large resources and productive capacities that affect world energy supplies. Sound resource management requires adequate information systems and supportive technology.

Because of its importance as today's prime energy resource, petroleum data bases are critical to successful resolution of the problem. The U.S. petroleum industry has created large computerized data files to support the exploration and management of domestic oil and gas resources. Major petroleum data bases and their associations are diagrammed in Figure 1. The combination of several data bases is required to solve increasingly complex problems in the petroleum industry. Geological data are being associated with geophysics through synthetic seismograms generated from digital well logs. Production accounting systems link detail production and well tests for each reservoir

with financial controls and reserve analysis systems. Production systems also link with transportation, refining and marketing systems at the pipeline delivery point. Well data systems are linked with production systems to provide a comprehensive exploration and production data base.

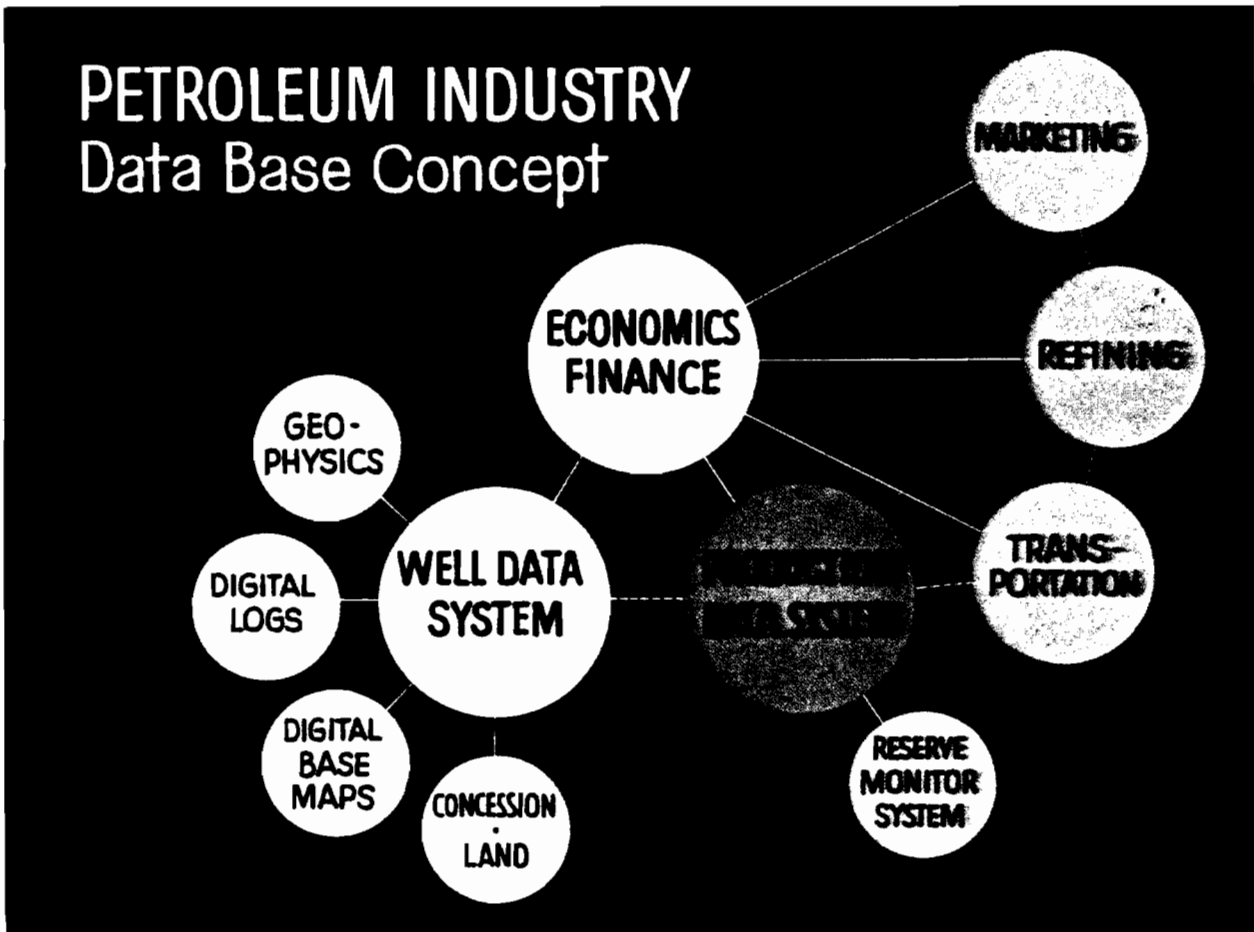

Figure 1. Petroleum industry data base concept. Well and production data files are the primary source of information for resource analysis.

The experience in developing these petroleum data bases has yielded several fundamentals that are applicable to development of international energy systems. Noteworthy are:

1. Apply comprehensive data management principles. Hard copy records must be properly organized and managed before they can be successfully compiled into a computer data base. A successful information system will utilize hard copy, micro-forms and computer data bases as appropriate.
2. Data should be compiled to the smallest common level of detail. The U.S. government still does not have adequate energy data systems because policy makers tend to fund acquisition of summary or bottom line data.
3. Standard record identity and control codes are required.
4. Important data codes should be standardized.
5. Data elements and their format requirements should be defined.
6. Mechanisms to exchange data between countries must be determined.

This paper illucidates these fundamentals through a discussion of the design, construction and application of well and production data files by the U.S. petroleum industry.

WELL DATA SYSTEMS

The computerized Well History Control System (WHCS) in the United States has been developed and maintained by Petroleum Information Corporation with the cooperation of major oil companies. The file contains records on more than 1,000,000 wells including historic wildcat wells and selected development wells. Development wells in old shallow producing fields have been selectively omitted at the request of industry. All wells drilled 1972 to date have been included. New wells, workovers and data corrections are added on a monthly basis.

Data Content

Data content is diagrammed on the illustration of well data system components (Figure 2). Components shown in block letters are accumulated from U.S. oil companies and are encoded, edited, entered and maintained in the commercial WHCS file. Included are general information such as operator, location, depth and dates, initial potential and production tests, drillstem tests, cores, formation tops and miscellaneous information such as logs and casing. Interpretive data such as lithology, paleontology, geochemistry and drillstem test analyses are added to the file on a proprietary basis.

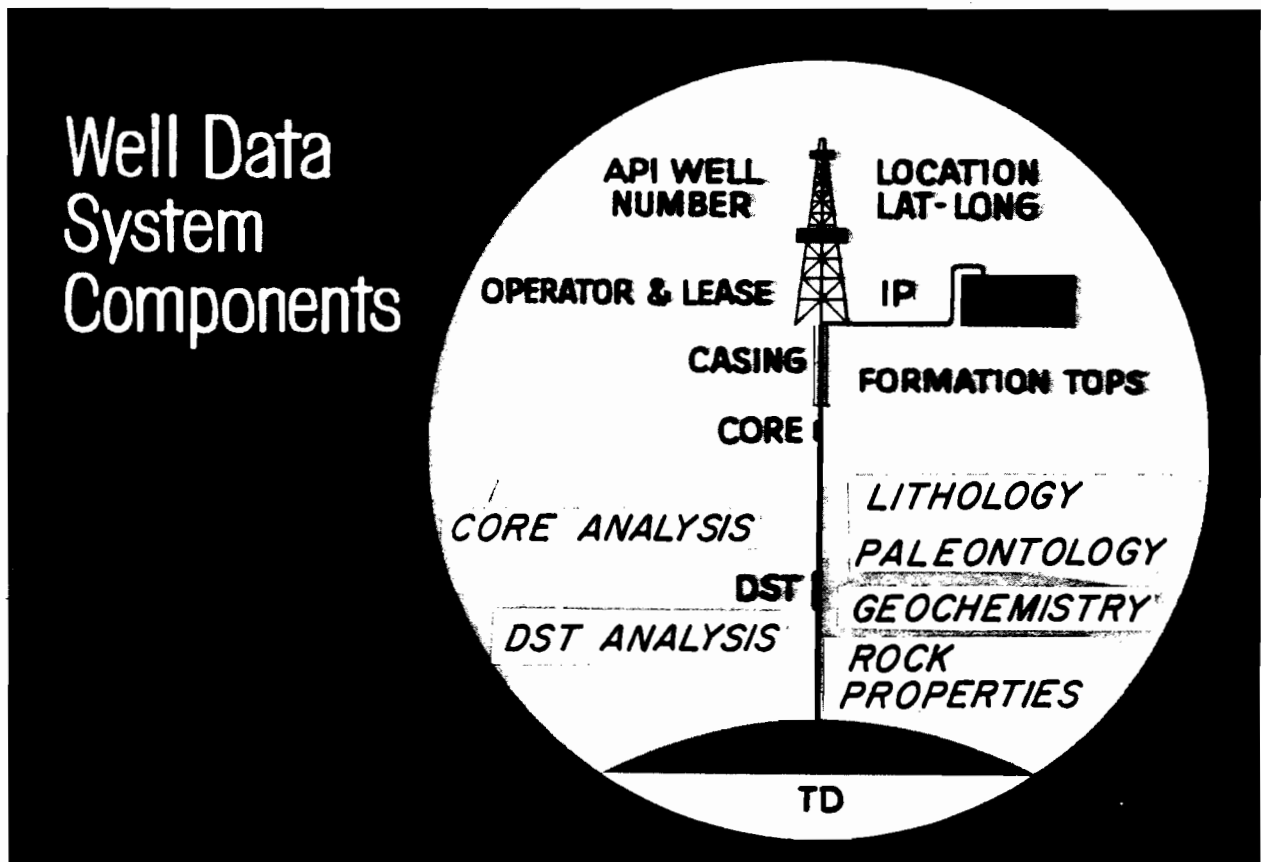

Figure 2. Well data system components are illustrated. Data related to well drilling and completion plus data derived from laboratory analysis are included.

The success of this system resulted from definition of data standards, formats and codes in cooperative industry committees. Committees continue to advise the contractor on data quality, service requirements such as timing and specifications for delivery of update tapes and format requirements to accommodate changes in technology and awareness of information utility. In the U.S. the American Petroleum Institute (API) established well data definitions and standards based on commonly used data and codes in existing systems and prompted governmental agencies and industry to utilize these standards for all well data records. It will be important for a recognized advisory committee to define similar standards for international energy data bases. The committee also must pursue their adoption in order to maximize exchange and utilization of international energy information.

Unique Well Number

The API unique well number is the most important standard for U.S. well data. The number is assigned by regulatory agencies that issue permits for drilling and is used as master well control in the WHCS file. The Department of Energy also has specified that reports of well data (such as for natural gas pricing) will be identified by the unique well number. The API well control code is a twelve digit number with the following components:

<u>State</u>	<u>County</u>	<u>Well Number</u>	<u>Sidetrack</u>
XX	XXX	XXXXX	XX

The WHCS record control also uses an additional two digit subnumber to identify that the associated data are related to rework or recompletion operations that take place after the original well completion (Figure 3).

For an international unique well number, one should consider including identifiers for continent and country. A single digit continent and two

digit country code prefix to the API number would provide a satisfactory international unique well number scheme. In addition to determining format, a responsible agency also must select and publish the recommended codes that are to be employed in each country. The objective is critical. However, it may be impossible to effect an acceptable standard due to the proliferation of country codes already used by various government agencies. If all else fails, translation tables could be used to exchange information with the standard code.

Other location criteria such as latitude-longitude have been used for well record control but experience shows several draw backs when compared to an arbitrary but recognized unique number. In the first place, it may be necessary to change an incorrect latitude-longitude. This would require change of all records using latitude-longitude as the master control code and destroy the concept of a permanent identifier. In addition, a single geographic location description may translate to different latitude-longitude values when associated with base maps that were not constructed with the same mathematical formulas or corrections.

The U.S. industry also has standardized and codified other data elements that provide important links to other data bases. Included are geological formation names, producing field names and operator and producer names. Formation codes consist of a three digit numeric prefix for the geologic age and a five digit alpha formation name abbreviation. The Ordovician Ellenberger Formation is coded 169ELBG. The American Association of Petroleum Geologists¹ Committee on Statistics of Drilling has a similar code that could be referenced for international use.

¹ AAPG, P.O. Box 979, Tulsa, Oklahoma 74101

WELL		ST. CO. NO. ST. HC		ORIGINAL WELL UNIT	HC=00
25	003	05205	00	00	
00000	250030520500000	5001E03506457821074501	110159CMBR	680829	
00001	255001E0350611109200				
10002	006	0457805910745973	0457825710745085		
10010	006	003005205191 77100 9999961	110159CMBR 404TSLP	6808052	LOCATION, CLASSIFICATION, IDENTIFICATION
10021	006	TWP S 1 RGE E 35 SEC 6	28MONTANA		
101	006	MONT BIG HORN 300 S/W 400 E/W	MU MU MU D DU		
102	006	GREER GEORGE TRUSTEE	J KENDRICK		
103	006	3340 KB 3329 GR	SNYDER		
104	006	3336 ES 3329 GR	P LSE NO 1779 API 25-003-05205 00		
105	006	SPUD 10/09/1952 COMP 01/25/1953	ROTARY OIL		
107	006	DTD 6808	PB 4638	FM/TO 159CMBR	
110	001	CSG 10 3/4 92 W/ 60 7	4620 W/ 200		
20101	002	IPP 5080PD	1008W		INITIAL POTENTIAL
20102	002	404TSLP OPENHOLE	4620- 4638		
25001	002	LOC 604EGLE	685 602PURY 2740 602KROT 3290		
25002	002	LOC 602KOTM	3519 553SMT 3798 553RROD 4012		
25003	002	LOC 552P1PR	4188 503CGR 4910 404TSLP 4626		FORMATION TOPS
25004	002	LOC 402APSD	4728 353CRLS 4989 352MSAC 5474		
25009	002	LOC 351LDGP	6060 309DVM 6268 2090DVC 6510		
25006	002	LOC 159CMBR	8779		
40101	003	DST 01	4620- 4656 404TSLP	S	
40120	003	REC 720FT	086CMB 108FT WCOIL	540FT FWTR	DRILL STEM TEST NO. 1
40130	003	INIT OP 1H	FFP 200 FFP 1425		
40132	003		FSIP 2150 30M		
40140	003	GTU 20.0			
40201	004	DST 02	5361- 5390 353CRLS		
40220	004	REC 436FT	FWTR		DRILL STEM TEST NO. 2
40230	004	INIT OP 1H	FFP 1600		
40232	004		FSIP 2060 0M15H		
40301	005	DST 03	6529- 6559 2090DVC		
40320	005	REC 130FT	PCM		DRILL STEM TEST NO. 3
40330	005	INIT OP 1H			
40332	005		15H		
50101	006	PTS 10080PD			PRODUCTION TEST NO. 1
50102	006	404TSLP OPENHOLE	4620- 4638		
25	003	05205	00	01	WORKOVER WELL UNIT
00000	250030520500018	5001E03506457821074501110351PDSN	680829		
00001	255001E0350611109201				
10002	013	0457805910745973	0457825710745085		
10010	013	003005205191 77100 99999611110351PDSN	404TSLP	6808856	
10021	013	TWP S 1 RGE E 35 SEC 6	28MONTANA		
101	013	MONT BIG HORN 300 S/W 325 E/W	MU MU D X DU		
102	013	GREER GEORGE J	J KENDRICK		
103	013	3336 DF 3329 GR	SNYDER		
104	013	3329 GR	P LSE NO 1779 API 25-003-05205-00		
105	013	SPUD 07/09/1956 COMP 08/02/1956	ROTARY RECOMPL OIL-WO		WORKOVER COMPLETION DATE
106	013	PRDJ DEPTH 6850	351PDSN CONTR KIRBY DRG		WORKOVER TOTAL DEPTH AND FORMATION AT TOTAL DEPTH
107	013	UTD 6808	PB 4638 UTD 6808 FM/TO 351PDSN		
110	007	CSG 10 3/4 92 W/ 60	4628- 4950 W/ 60		
120	007	LWR 4 1/2		24HRS	
20101	008	IPP 2380PD			INITIAL POTENTIAL
20102	008	404TSLP PERF	W/ 6/FT 4622- 4636		
20151	008	GTU 20.0			
25201	008	SPL 404TSLP	4616 402APSD 4722 353CRLS 4991		
25202	008	SPL 351PDSN	5499		
50101	009	PTS OBO	OPCFD		PRODUCTION TEST NO. 1
50102	009	402APSD PERF	W/ 6/FT 4854- 4859		
50170	009	SQZD 4854- 5859			
50201	010	PTS OBO	OPCFD		PRODUCTION TEST NO. 2
50202	010	402APSD PERF	W/ 6/FT 4826- 4836		
50230	010	ACID 4826- 4836	1000GALS		
50301	011	PTS OBO	OPCFD		PRODUCTION TEST NO. 3
50302	011	402APSD PERF	W/ 6/FT 4794- 4798		
50401	012	PTS OBO	OPCFD		PRODUCTION TEST NO. 4
50402	012	404TSLP PERF	W/ 6/FT 4622- 4636		
50470	012	SQZD 4622- 4694			
50490	012	W/500 GALS MUD ACID			

WHCS File Structure

Figure 3. WHCS file structure is illustrated by an original completion and a workover to the Greer No. 3 Kendrick.

File Structure

The data content and structure of the WHCS file are illustrated in Figure 3. An original 1953 completion record and a 1956 workover are related on the file through the hole change (HC) sequence associated with the unique well number. New data such as four production tests and an initial potential are stated in the workover. WHCS is maintained as a sequential tape file with data sets and record types identified by line and operation sequence numbers on the left side of each line. Data base designs must accommodate the fact that many retrievals compare all tests and cores to output the most significant result.

Processing Requirements

A comprehensive well information system requires substantial investment in software and staff to provide adequate maintenance, retrieval and applications. Because of their size and complexity, U.S. well data files have evolved slowly from batch tape processing to data base management systems. On-line data entry systems have been implemented to provide more effective editing and quality control. It appears that new generations of relational data management systems must be developed to satisfy all well data processing requirements including on-line relationship to other energy data bases such as production files.

PRODUCTION DATA FILES

Major oil companies are supporting the development of a National Production System in the U.S. Original production systems were designed to report production by lease--the smallest legal producing property description--in order to interface with revenue, tax and royalty payments in accounting systems. Each producing state developed its own reporting requirements and formats and there

was no provision to satisfy engineers' need for production and test data from each reservoir. These deficiencies are being rectified at considerable cost through the National Production System.

The objectives of the National Production System are:

1. Create a standard nationwide production format.
2. Integrate API unique well numbers.
3. Implement standard industry codes for fields, operators and geologic formations.
4. Report all data to each reservoir completion.
5. Expand data content to include:
 - a. All fluid volumes.
 - b. Well production tests (monthly).
 - c. Secondary recovery information.
 - d. Abandonment records.

This expensive system revision reinforces the value of designing energy data bases to capture information at the most detailed reporting level and to effect common control codes and standard codes with other energy files.

Data Content

The major data components for a production system are outlined in Figure 4. Data are classified by field, lease, reservoir and well completion. Identification records, monthly production values and well production tests are the main components. Secondary recovery data and the gatherer also are reported. Pressure tests, fluid analyses, facilities costs and PVT data can be added to support proprietary reservoir engineering studies. Lease production is allocated to each producing reservoir on the basis of well production tests. The allocated reservoir production and test data are the master data for production planning

and reservoir engineering. Common identifiers such as API well numbers and codes for operator, field and reservoir (geological formation) names link production data to well data. Well latitude-longitude is used to generate computer maps of production and test data.

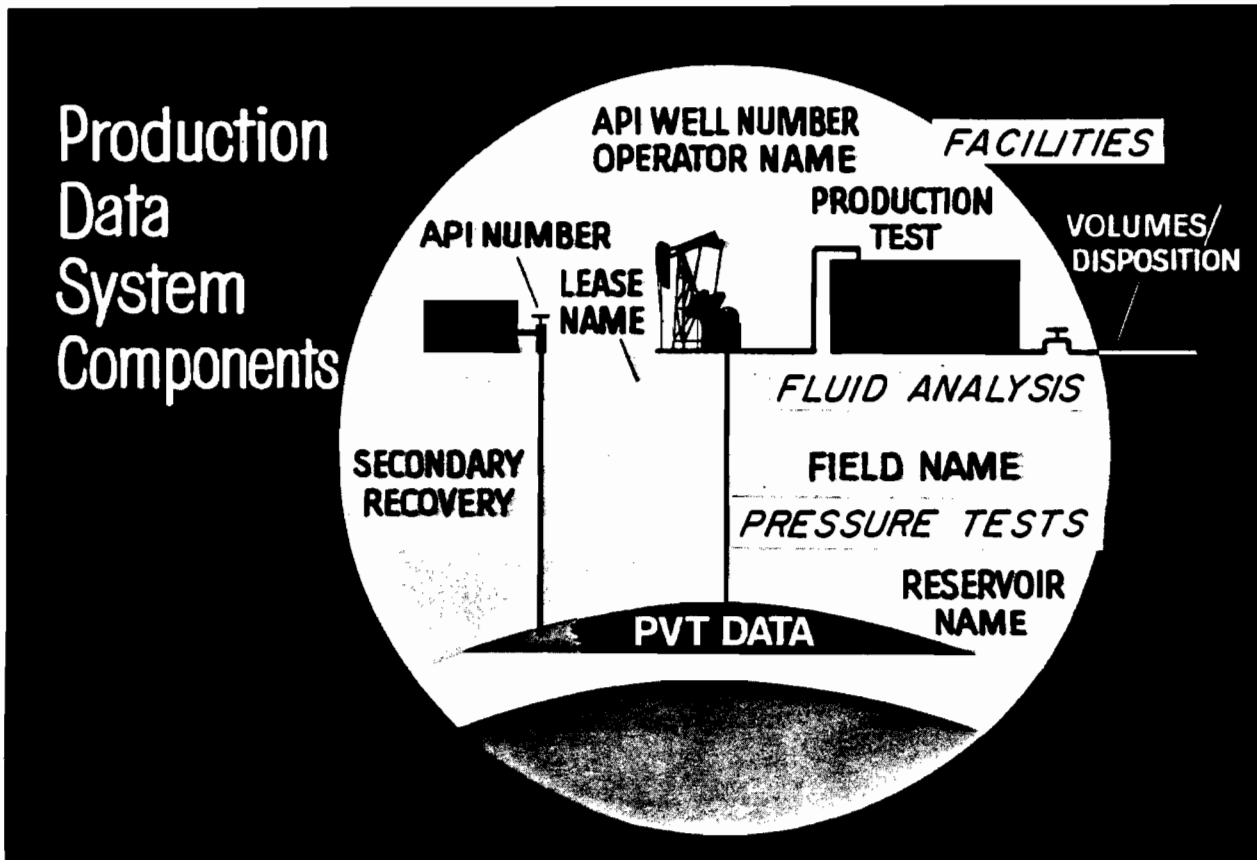

Figure 4. Monthly production of all fluids and production tests are reported for each unit of production.

Reserve Monitor System

Petroleum reserves are critical for effective resource analysis, exploration economics and public energy planning and policy decisions. Reliable reserves also are difficult to compute in complex reservoirs and generally are retained as proprietary information. As a result, important reserve data usually are not available for use in energy analyses. In the U.S., industry has pro-

posed the development of a reserve monitor system that can be built and maintained in conjunction with the National Production System. Standard record controls and data codes plus annual production volumes, cumulatives and number of wells provide the basis for reserve computations by decline plots. Detail reservoir parameters such as porosity, pressure, temperature and oil saturation are required to compute reserves by material balance and volumetric computation (Stout 1972). To update the system, new producing wells plus the most recent annual and cumulative production are entered from the National Production File. Reserves are updated by subtracting current production from prior reserves and adding current to cumulative production. Edits are used to flag significant changes in production and reserves that should be checked and corrected. New producing reservoirs, change of more than two years in productive life and cumulative in excess of reserve are edit examples.

Governments should recognize the value of data base information systems and avoid inclination to demand data to satisfy only political or regulatory aims. In the U.S., for instance, Congress has passed laws that require each company to submit reserves. Unfortunately, there are no provisions to systematically relate company ownership to reservoirs and fields and there are no raw production data to check or recompute reserves. At great cost to the industry and the public, the government demands reserve data to be submitted as a means to regulate or monitor company activity. The resulting data are of little use for technical research and appear to be inadequate to compute future production capacity and reserve analyses. Energy resource planning and analysis requires a dynamic reserve monitor system that is derived from a production data base such as the National Production System.

APPLICATIONS

The combination of well and production data provides a tremendous information base for resource analysis. Forgotson and Stark (1972) summarized well data file applications for exploration. Some applications that can be made of an integrated system are illustrated on Figure 5. For this paper, reserve computation, analysis of resource potential, production forecasting and preparation of government reports are most important. In the petroleum industry, the use of well data and production histories is maximized in exploitation projects such as secondary recovery and reservoir engineering and modeling.

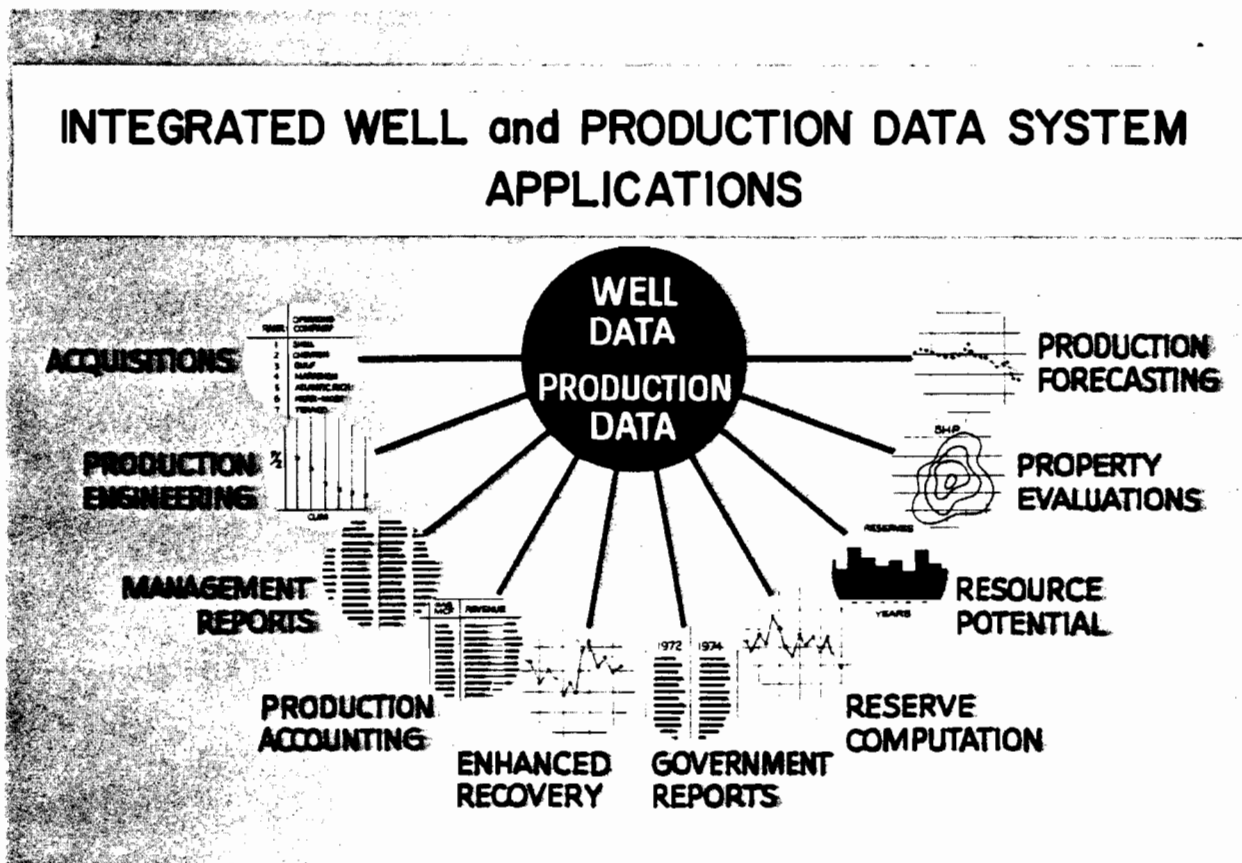

Figure 5. Integrated well and production data systems support a variety of applications illustrated in the diagram.

Resource Evaluation

In resource evaluation, reserves computed from production histories must be combined with drilling histories to forecast future potential. Energy resource studies are vital to the formulation of effective planning and policy decisions regarding the large economic, social and political adjustments that we face in response to the current energy situation.

In frontier provinces, the amount, type and configuration of sediments from surface geology and geophysics plus indications of hydrocarbons from seeps or geochemistry are used to define the hydrocarbon habitat. A mature producing province with analogous geologic conditions is used as a model to forecast probable reserve potential in the frontier basin.

In making petroleum resource assessments in producing provinces, past drilling rates, success and resulting reserves are used to estimate future resources. In provinces with abundant drilling and production history, the following data base applications can be applied:

1. Measure the amount of drilling, success rates, hydrocarbon distribution and geological configuration for key reservoirs. In Figure 6, for example, wildcat wells that penetrate the Cretaceous Dakota Sandstone in the Green River Basin of southwest Wyoming are posted with producing fields, hydrocarbon shows and Dakota structure. The structure has been computer contoured. The drilling density and success ratios also are quantified on statistical reports. Geologists use maps and statistics to define prospective areas and their likelihood of success.

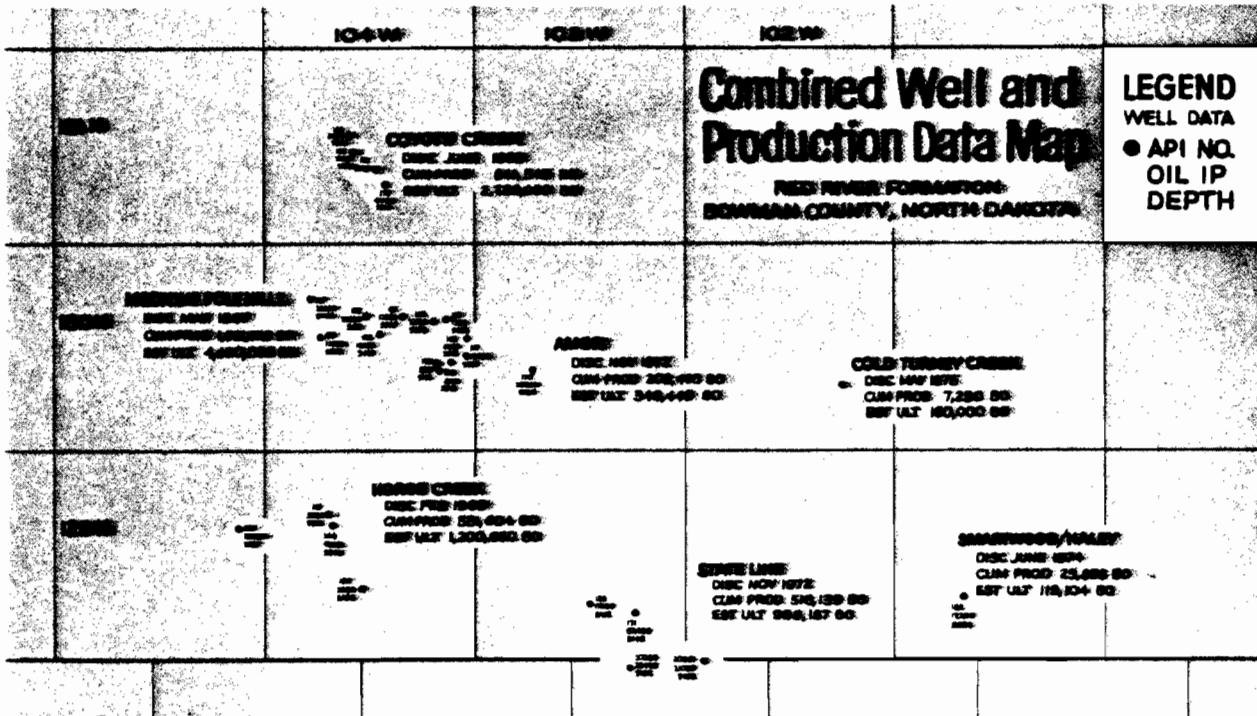

Figure 7. Initial potential producing rates for wells in the Ordovician Red River Formation are posted with cumulative field production and reserves. This type of map which displays proved resources can be computer generated from combined well and production data base systems.

3. Reserves are merged with the discovery well for each reservoir. The reserves thereby are related to the amount and success of drilling that led to each discovery. The complete exploratory drilling chronology can then be computer analyzed to predict future resource potential on the basis of probability distributions. Geo-

logical constraints can be imposed by applying maximum and minimum limits to future resource expectations. Analysts also should attempt to account for the affect of price and changes in technology. Papers by Miller (1975) and Borg (1975) provide an excellent review of data and methods used in resource appraisals.

SUMMARY

Better information is critical to effect satisfactory world energy planning and policies. Information is not free. Governments and industry must realize the need for information. They must develop methods to gather and exchange data. They must cooperate in defining data standards so that information can be easily combined and assimilated into existing systems. They must finance development of new data management systems to process complex combinations of energy data bases. They must develop organizations of competent people to analyze the data.

Conferences should be convened to define requirements and data standards for international energy data systems. We must stimulate cooperation among nations to exchange sensitive data. The experience of the U.S. petroleum industry with large data base systems can provide meaningful guidance to the development and application of international energy data bases.

Bibliography

- Borg, I.Y., 1975, Appraisal of Current Methods of Evaluating Crude Oil Reserves, Livermore, California: Lawrence Livermore Laboratory.
- Forgotson, James M., Jr., and Stark, Philip H., 1972, Well Data Files and the Computer, A Case History from Northern Rocky Mountains, Bull. Am. Assoc. Petroleum Geologists, v. 56, pp. 1114-1127.
- Miller, Betty M., 1975, Geological Estimates of Undiscovered Recoverable Oil and Gas Resources in the United States, Reston, Virginia, Geological Survey Circular 725.
- Stout, John L., 1972, Reservoir Volume Determination, Dallas, Texas, Society of Petroleum Engineers of AIME, SPE 4126.

STATSID: A Data Bank of Petroleum Statistics

M.S. Screve

Société Nationale Elf Aquitaine,
7 Rue Nelaton, 75015 Paris, France

The STATSID data base, updated yearly by a group of French Petroleum Companies contains meaningful quantified data series showing the annual oil and gas exploration activities in 250 countries, states or particular zones.

Designed to meet the constant demand for historical petroleum statistics, it became first a reliable in-house numeric data base system providing access to chosen data and able to perform various computations on them.

Now, STATSID is accessible on line to users in all countries, on General Electric Mark III teleprocessing network, and it constitutes the structured information base of data bank systems. Through a general purpose interrogation program, input data can be easily retrieved, and then processed, through Mark III other systems, in order to obtain sophisticated statistical analysis, as well as plots, graphs or tables.

In an appendix to the paper the data contained in the data base and examples for data retrieval and analysis are presented.

The STATSID data base was designed to meet the constantly arising demand for historical petroleum statistics, relating both to France and many foreign countries, in the areas of exploration and production.

In 1965, the "Service Information Documentation" (SID) of the Elf Aquitaine Group undertook to gather informative data about the means implemented and the results obtained in oil and gas exploration in most countries in which it took place, for recording in a single file on magnetic tape.

This meant compiling a homogeneous, evaluated inventory of numeric data hitherto scattered among a large number of sources, some of them old and rare. Through the use of suitable programs, it also meant making these data directly accessible, by organizing them within an automated file in order to retrieve any data element on demand, or use it for statistical computation.

The project for this undertaking - information base and processing programs - was baptized STATSID (by contraction of the word STATISTICS and the initials of the service which designed it).

I THE CREATION OF STATSID

Like most currently known data banks, STATSID was created in two phases. In the first phase, from 1966 to 1967, a trial base was created, with limited objectives. This was followed, from 1968 to 1970, by establishing the data bank with its final structures and objectives.

I-1 The trial period

To pinpoint and define the content of the data base, it was first necessary to make a selection, among the many petroleum statistics, of the data routinely required for research, in the area of exploration and production, and also in other departments (economics, public relations), and which appeared to be really available on a regular basis. This selection was carried out more rapidly than anticipated. As a matter of fact, it sufficed to gather, and then to examine and compare the different manual files which had hitherto been compiled simultaneously in many departments of our Group.

I-1.1. Forms

Once the data were selected, the biggest job was designing the forms for data acquisition, which indeed required not only close reflection, but also many searches into the documentary base.

For each category (main subject heading) it was necessary to define all the numeric series (or sub-categories) to be grouped under a single topic. For instance, in geophysical activities, to identify the methods to be examined, among all the methods employed (seismics, gravimetry, etc...).

Within the categories :

- . The space (in characters) required to insert the data into each series was measured, in accordance with the extent of the meaningful figures. (The number of oil wells in production ranges on the average from 10 to 400 in many countries, reaching 20,000 in Canada, but amounts to about 500,000 in the U.S.A.).

- . Determination was made of the power to be used so that the largest possible meaningful figure would enter into minimum space. Thus oil production is input in thousands of units and gas production in millions.
- . Finally, an inventory was made of all the types of units used in official documents to make evaluations of certain quantities, and those in most widespread use were adopted. Depending on the country, oil production is expressed in tons, barrels, m³, and even liters and kiloliters. We chose to eliminate the latter.

I-1.2. Others tools

It also proved necessary to create a few indexing instruments. In the absence of a standardized geographic code at the time, a consistent numeric code, designed on the basis of a document issued by the French Association for Petroleum Exploration (Chambre Syndicale Française de la Recherche Pétrolière) was drawn up, for the different countries in the world. This numeric code, corresponds to sovereign States and to their official subdivisions.

This code was enclosed in a report establishing the conventions relative to the characteristics of the data to be inventoried, and which also listed the standards imposed by the computer program logic at the time of filling the forms, particularly in case of error, correction or deletion of data.

The objective of the trial base was to list the results of exploration and production in fifty representative countries, over a ten-year period (1955 to 1965). The programs written at this stage were only aimed at data retrieval (lists and tables).

I-2 Creation of the data bank

At the end of 1967, the results of the work accomplished and their processing on computers were evaluated. A thorough examination was carried out by three departments of two companies of our Group (Erap and SNPA at the time). A number of conclusions were drawn from this analysis.

The final objective became :

- . To create a base containing annual series to gather, from 1946 onward, data relative to all countries in which known petroleum activity occurred,
- . To incorporate for these countries, and for the same data, series of data elements indicating the cumulative results obtained before 1946, namely, from inception to 1945 inclusive, and, in these cumulative series, to introduce a new data element specially calculated for STATSID by experts : the estimated area of the useful sedimentary zone.

I-2.1. Value of the data

Each data element (see list of these data in annex 1) taken from official and internal sources had to be checked and validated before recording in the base. For the sake of accuracy, a zone was reserved for the insertion of special characters, to enter, when necessary, indication of the value of some data elements (for example, reappraised data). As a corollary, the gathering of data which were uncertain or difficult to find was abandoned, such as the assessment of additional oil or gas reserves obtained following the discovery of a new field.

I-2.2. The tools

The geographic code was improved to specify the identity (onshore, offshore, State of a confederation) of the countries examined, whenever the available statistics were clearly detailed (see one example in annex 2). These new rules naturally gave rise to the drafting of another indexing manual, which also included all instructions for management and interrogation of the base.

I-2.3 The programs

At this stage, different programs were written in close collaboration with the engineers of the data processing centre. First to ensure all logic checks of the data retained and their possible correction at input and also at subsequent data updates (or revisions); also thanks to the experience gained, to meet the users' requests, by providing them with the following services:

- . retrieval of the basic numeric data, converted at input and stored in metric units (if required by the unit of the figures gathered), both in their original form and in metric data,
- . partial or complete printing, on paper, in tables, of all the data, by country and by year (see annex 3),
- . execution of computations designed to answer questions from specialists of an oil company (geologists, producers or economists) : for example from those wishing to check the intensity of drilling efforts in a particular country (see annex 4), their relationship to reported discoveries ; or from those making a comparative study of the characteristics of the production and reserves of several countries.

At the end of 1969, the results of more than twenty years of petroleum operations conducted in 130 countries and States were recorded and STATSID was henceforth a valuable data base of petroleum statistics.

II STATSID: A COMMON DATA BASE

This data base, which had been created by and for the companies of the Elf Aquitaine Group, actually represented an original computerized tool lending itself to use as such by other companies. This is why it was decided, in 1970, to offer access to this data base, generated in magnetic tape form, to companies participating in petroleum activities worldwide. Several international companies and foreign

national companies acquired this access, by sharing in the setting up expenses. But STATSID also aroused the interest of certain French companies, which asked to take part in the undertaking.

Hence after 1970, STATSID became a data base common to ELF, CFP (Compagnie Française des Pétroles) and IFP (Institut Français du Pétrole, the French Petroleum Institute). Since then all three organizations use and update it jointly. This cooperation was of twofold benefit. The sharing of tasks and countries to be analyzed among several research centres accelerated data gathering and allowed more intensive checks by the specialists of each company.

Furthermore, from year to year, the number of countries and zones covered increased considerably.

As already stated, each country is by definition a sovereign State defined by its political boundaries, and is assigned a standard 3 figure code number (411 = France, 701 = Canada). The first digit indicates the continent, the next two the position of the country in the list of nations on the continent.

The code was further refined by using three optional digits :

- . to index a State in a federation, for example :
70104 Canada = State of New Brunswick,
- . to specify (using the sixth digit) the particular zone examined. Example : 701041 Canada = State of New Brunswick, Onshore,
- . or the separate recording (a recent addition) of any information available about Deep Offshore Zones.
Example : 701134 Canada = East Coast-Deep Offshore

The data base has been improved throughout all these years. Since 1974, the chief task consists of adding, each year, the reliable historical data of the previous year. At present, the data for 1978 are being collected.

But the SID (SNEA), which handles updating on a central computer, and the managers of the other centres, CFP, IFP and SNEA (P) (subsidiary of SNEA) also review matters many times each year. In the course of meetings, they examine the problems and criticisms raised after each annual update. Investigations made among users and managers of geographic sectors bring back proposals which give rise to data corrections.

And it is jointly, after discussion, that decisions are made to introduce new countries or zones, or sometimes to abandon data gathering for certain countries whose official statistics are grouped differently. However, this abandonment often corresponds to the creation of a new country with other data series, corresponding to more specific geographic zones.

While the base is small (27 annual and 27 cumulative series per country), it is important to note that, thanks to the choice of an open structure, supplementary information series can be added easily, and especially that the filling rate of the current series is generally 70 %.

III A NEW STEP

Until 1977, the STATSID data bank - apart from providing access to other companies to the magnetic tape on which the statistical information was recorded - was only used as such exclusively by the companies which shared in producing it.

Actually, despite the arrival on the market of other highly specialized petroleum data banks, mainly concerned with the USA, this numeric data base remains the only one which currently groups, over a period spanning more than thirty years, meaningful quantified data about the petroleum activity of 250 countries, States or particular geographic zones of a country.

Therefore, the Group of French companies which created STATSID decided to make their data base available to users in all countries. To do this, they agreed to entrust STATSID to GE Information Services, thus making it accessible on-line on General Electric's Mark III teleprocessing network.

This network, open round the clock, every day of the week, covers four continents and features more than 500 access point worldwide (including ten in France). Thus, wherever he is, a subscriber to this network can consult STATSID by simply dialing up the system. A user's manual has been compiled in collaboration with GEIS to guide the search and to advise the subscriber of the instructions and geographic code of the countries and also of the usable categories and sub-categories. This guide has been recorded and can be generated on the printer (or screen) of the terminal employed.

Searching STATSID remains simple and practical. Data series within a major category or special sub-categories can be retrieved easily and on-line interrogations permit conversational interaction between the user and the computer at any time.

Furthermore, a set of computer programs called STATSYSTEM makes it possible, within the framework of a working file, to process the basic information, and to print the tables and graphs corresponding to the computations made. The basic data of STATSID can also be combined with data from other bases loaded on the same system, or with data (drilling costs, capital expenditures, etc...) that the user may possess and which he can enter into the working file whenever he wishes to.

Used in this manner, STATSID is a true on-line data bank, and while it is a source of historical petroleum information and a base for computations useful to members of the petroleum industry, it also provides help in making decisions to many specialists in other areas.

BIBLIOGRAPHY

=====

- PERRODON, A. (1965) : La recherche pétrolière. Statistiques et Perspectives. Annales de la Société Belge pour l'Etude du pétrole 20 : 33-48
- COUSTAU, H. (1977) : Exemple de données statistiques à la disposition de l'exploration. Revue de l'Institut Français du Pétrole 1 : 3-21
- SCREVE, M. (1978) : Une banque de données de statistiques pétrolières sur Mark III (STATSID). HBNIS BC 30 : 3-7
- : Le système "STATSID", une banque de données numériques pétrolières. Bulletin Mensuel Informations ELF 7/8 : 4-15

ANNEX 1

List of data contained in STATSID

ANNUAL SERIES

Data indicating the total exploration effort made in a country during one year

- . total lease area in force,
- . length of seismic profiles, offshore and onshore,
- . number of seismic crew-months (offshore, onshore, total), and crew-months spent in various other methods,
- . number - by category (New-field wildcats, exploration wells) -of completed wells with indication of oil and gas shows,
- . depths drilled (total per category and overall total, including development wells).

Production results (oil and gas)

- . number of producing wells,
- . quantities produced during the year,
- . proved reserves remaining at year end.

CUMULATIVE SERIES

Same type of data concerning exploration, with indication of:

- . sedimentary area,
- . cumulative production of oil and gas.

These cumulative totals represent the activities in their specific units, from inception to the year in which the annual series of the country begins (in general from inception to 1945 inclusive, but certain cumulative series are of later date, if related to countries in which petroleum activity began more recently).

ANNEX 2

Geographic Code

4 EUROPE

<u>Basic Code</u>		<u>Code of Country Examined</u>	
401	Albania	401	Albania
402	West Germany	402	West Germany except North Sea
		402--3	West Germany (onshore - offshore)
403	East Germany	403	East Germany
404	Andorra		
405	Austria	405--1	Austria (onshore)
406	Belgium	406	Belgium
407	Bulgaria	407	Bulgaria
408	Denmark	408--3	Denmark (onshore - offshore)
409	Spain	409--3	Spain (onshore - offshore)
		409--4	Spain Deep Offshore
410	Finland		
411	France	411--3	France (onshore - offshore)

6th digit = 1 onshore part

2 offshore part

3 both onshore and offshore (including deep offshore)

4 deep offshore zone

Blank undetermined.

CODE GÉOGRAPHIQUE = 702 PAYS = ETATS UNIS ANNEX 3 DATE = 01/09/78 PAGE 11
 SURFACE SEDIM. (K:12) = 5690000

		H U I L E										G A Z									
ANN	HUILE	PRODUCTION			RESERVES			HUILE			PRODUCTION			RESERVES							
		3 10 TON	3 10 BAR	3 10 TON	6 10 BAR	6 10 TON	6 10 BAR	6 10 TON	6 10 BAR	6 10 TON	6 10 BAR	6 10 TON	6 10 BAR	6 10 TON	6 10 BAR	6 10 TON					
146	421460IR	237081	1733938	27567618	2854	20874	3319	62740	139200	4215774	4522	159704									
147	426280IR	253906	1856987	22523018	2938	21488	3416	63676	158554	5592230	4673	165027									
148	437880IR	276220	2020105	32118618	5183	23280	3701	64212	169194	5975001	4897	172925									
149	440680IR	251848	1841940	25284718	3370	24649	3919	63346	175800	6211124	5080	179402									
150	465870IR	269847	1973574	31377518	3455	25268	4017	64200	194120	6355244	5227	164585									
151	474990IR	307329	2247711	35736018	3756	27468	4367	65100	224375	7923673	5458	192750									
152	480520IR	313089	2289836	36405718	3823	27961	4445	65450	243320	8592710	5625	190637									
153	498940IR	322284	2357082	37474818	3958	28945	4602	68223	260187	9188365	5955	210290									
154	511200IR	316528	2314988	36805618	4042	29561	4700	70192	265481	9375314	5962	210561									
155	524010IR	339696	2484428	39499518	4104	30012	4772	71475	284959	10063167	6360	222487									
156	551170IR	357861	2617283	41611718	4161	30435	4839	74261	307202	10848685	6696	236487									
157	569273IR	357809	2616901	41605618	4143	30300	4817	77041	323944	11439890	6964	245230									
158	574205IR	334850	2448987	38936018	4175	30536	4855	80400	323455	11422651	7157	252762									
159	583141IR	352023	2574590	40933018	4337	31719	5043	83225	350363	12373062	7396	261170									
160	591158IR	352070	2574933	40930418	4322	31613	5026	90761	368669	13012350	7428	262326									
161	594917IR	358473	2621750	41682018	4342	31759	5049	91200	379843	13378449	7560	266276									
162	580280IR	365914	2676185	42548218	4292	31389	4990	102545	386167	13637973	7710	272270									
163	595462IR	376379	2752723	43765118	4235	30970	4924	102266	411900	14546025	7820	276151									
164	588225IR	381042	2786822	44307218	4237	30991	4927	112699	434532	15347020	7964	281251									
165	579875IR	389477	2848514	45288018	4287	31352	4985	115334	460216	16252293	8112	286460									
166	570930IR	413986	3027763	48137918	4300	31452	5001	124092	495295	17491073	8193	289337									
167	566869IR	439647	3215445	51121818	4290	31377	4909	121758	520490	18300838	8294	292901									
168	548331IR	432191	3160968	50254718	4199	30707	4882	119520	553721	19683280	8137	287350									

* = VALEUR CALCULEE, A = ABOUCHE, B = SOURCE, C = SOURCE, D = SOURCE, E = SOURCE, F = SOURCE, G = SOURCE, H = SOURCE, I = SOURCE, J = SOURCE, K = SOURCE, L = SOURCE, M = SOURCE, N = SOURCE, O = SOURCE, P = SOURCE, Q = SOURCE, R = SOURCE, S = SOURCE, T = SOURCE, U = SOURCE, V = SOURCE, W = SOURCE, X = SOURCE, Y = SOURCE, Z = SOURCE, AA = SOURCE, AB = SOURCE, AC = SOURCE, AD = SOURCE, AE = SOURCE, AF = SOURCE, AG = SOURCE, AH = SOURCE, AI = SOURCE, AJ = SOURCE, AK = SOURCE, AL = SOURCE, AM = SOURCE, AN = SOURCE, AO = SOURCE, AP = SOURCE, AQ = SOURCE, AR = SOURCE, AS = SOURCE, AT = SOURCE, AU = SOURCE, AV = SOURCE, AW = SOURCE, AX = SOURCE, AY = SOURCE, AZ = SOURCE, BA = SOURCE, BB = SOURCE, BC = SOURCE, BD = SOURCE, BE = SOURCE, BF = SOURCE, BG = SOURCE, BH = SOURCE, BI = SOURCE, BJ = SOURCE, BK = SOURCE, BL = SOURCE, BM = SOURCE, BN = SOURCE, BO = SOURCE, BP = SOURCE, BQ = SOURCE, BR = SOURCE, BS = SOURCE, BT = SOURCE, BU = SOURCE, BV = SOURCE, BW = SOURCE, BX = SOURCE, BY = SOURCE, BZ = SOURCE, CA = SOURCE, CB = SOURCE, CC = SOURCE, CD = SOURCE, CE = SOURCE, CF = SOURCE, CG = SOURCE, CH = SOURCE, CI = SOURCE, CJ = SOURCE, CK = SOURCE, CL = SOURCE, CM = SOURCE, CN = SOURCE, CO = SOURCE, CP = SOURCE, CQ = SOURCE, CR = SOURCE, CS = SOURCE, CT = SOURCE, CU = SOURCE, CV = SOURCE, CW = SOURCE, CX = SOURCE, CY = SOURCE, CZ = SOURCE, DA = SOURCE, DB = SOURCE, DC = SOURCE, DD = SOURCE, DE = SOURCE, DF = SOURCE, DG = SOURCE, DH = SOURCE, DI = SOURCE, DJ = SOURCE, DK = SOURCE, DL = SOURCE, DM = SOURCE, DN = SOURCE, DO = SOURCE, DP = SOURCE, DQ = SOURCE, DR = SOURCE, DS = SOURCE, DT = SOURCE, DU = SOURCE, DV = SOURCE, DW = SOURCE, DX = SOURCE, DY = SOURCE, DZ = SOURCE, EA = SOURCE, EB = SOURCE, EC = SOURCE, ED = SOURCE, EE = SOURCE, EF = SOURCE, EG = SOURCE, EH = SOURCE, EI = SOURCE, EJ = SOURCE, EK = SOURCE, EL = SOURCE, EM = SOURCE, EN = SOURCE, EO = SOURCE, EP = SOURCE, EQ = SOURCE, ER = SOURCE, ES = SOURCE, ET = SOURCE, EU = SOURCE, EV = SOURCE, EW = SOURCE, EX = SOURCE, EY = SOURCE, EZ = SOURCE, FA = SOURCE, FB = SOURCE, FC = SOURCE, FD = SOURCE, FE = SOURCE, FF = SOURCE, FG = SOURCE, FH = SOURCE, FI = SOURCE, FJ = SOURCE, FK = SOURCE, FL = SOURCE, FM = SOURCE, FN = SOURCE, FO = SOURCE, FP = SOURCE, FQ = SOURCE, FR = SOURCE, FS = SOURCE, FT = SOURCE, FU = SOURCE, FV = SOURCE, FW = SOURCE, FX = SOURCE, FY = SOURCE, FZ = SOURCE, GA = SOURCE, GB = SOURCE, GC = SOURCE, GD = SOURCE, GE = SOURCE, GF = SOURCE, GG = SOURCE, GH = SOURCE, GI = SOURCE, GJ = SOURCE, GK = SOURCE, GL = SOURCE, GM = SOURCE, GN = SOURCE, GO = SOURCE, GP = SOURCE, GQ = SOURCE, GR = SOURCE, GS = SOURCE, GT = SOURCE, GU = SOURCE, GV = SOURCE, GW = SOURCE, GX = SOURCE, GY = SOURCE, GZ = SOURCE, HA = SOURCE, HB = SOURCE, HC = SOURCE, HD = SOURCE, HE = SOURCE, HF = SOURCE, HG = SOURCE, HH = SOURCE, HI = SOURCE, HJ = SOURCE, HK = SOURCE, HL = SOURCE, HM = SOURCE, HN = SOURCE, HO = SOURCE, HP = SOURCE, HQ = SOURCE, HR = SOURCE, HS = SOURCE, HT = SOURCE, HU = SOURCE, HV = SOURCE, HW = SOURCE, HX = SOURCE, HY = SOURCE, HZ = SOURCE, IA = SOURCE, IB = SOURCE, IC = SOURCE, ID = SOURCE, IE = SOURCE, IF = SOURCE, IG = SOURCE, IH = SOURCE, II = SOURCE, IJ = SOURCE, IK = SOURCE, IL = SOURCE, IM = SOURCE, IN = SOURCE, IO = SOURCE, IP = SOURCE, IQ = SOURCE, IR = SOURCE, IS = SOURCE, IT = SOURCE, IU = SOURCE, IV = SOURCE, IW = SOURCE, IX = SOURCE, IY = SOURCE, IZ = SOURCE, JA = SOURCE, JB = SOURCE, JC = SOURCE, JD = SOURCE, JE = SOURCE, JF = SOURCE, JG = SOURCE, JH = SOURCE, JI = SOURCE, JJ = SOURCE, JK = SOURCE, JL = SOURCE, JM = SOURCE, JN = SOURCE, JO = SOURCE, JP = SOURCE, JQ = SOURCE, JR = SOURCE, JS = SOURCE, JT = SOURCE, JU = SOURCE, JV = SOURCE, JW = SOURCE, JX = SOURCE, JY = SOURCE, JZ = SOURCE, KA = SOURCE, KB = SOURCE, KC = SOURCE, KD = SOURCE, KE = SOURCE, KF = SOURCE, KG = SOURCE, KH = SOURCE, KI = SOURCE, KJ = SOURCE, KK = SOURCE, KL = SOURCE, KM = SOURCE, KN = SOURCE, KO = SOURCE, KP = SOURCE, KQ = SOURCE, KR = SOURCE, KS = SOURCE, KT = SOURCE, KU = SOURCE, KV = SOURCE, KW = SOURCE, KX = SOURCE, KY = SOURCE, KZ = SOURCE, LA = SOURCE, LB = SOURCE, LC = SOURCE, LD = SOURCE, LE = SOURCE, LF = SOURCE, LG = SOURCE, LH = SOURCE, LI = SOURCE, LJ = SOURCE, LK = SOURCE, LL = SOURCE, LM = SOURCE, LN = SOURCE, LO = SOURCE, LP = SOURCE, LQ = SOURCE, LR = SOURCE, LS = SOURCE, LT = SOURCE, LU = SOURCE, LV = SOURCE, LW = SOURCE, LX = SOURCE, LY = SOURCE, LZ = SOURCE, MA = SOURCE, MB = SOURCE, MC = SOURCE, MD = SOURCE, ME = SOURCE, MF = SOURCE, MG = SOURCE, MH = SOURCE, MI = SOURCE, MJ = SOURCE, MK = SOURCE, ML = SOURCE, MM = SOURCE, MN = SOURCE, MO = SOURCE, MP = SOURCE, MQ = SOURCE, MR = SOURCE, MS = SOURCE, MT = SOURCE, MU = SOURCE, MV = SOURCE, MW = SOURCE, MX = SOURCE, MY = SOURCE, MZ = SOURCE, NA = SOURCE, NB = SOURCE, NC = SOURCE, ND = SOURCE, NE = SOURCE, NF = SOURCE, NG = SOURCE, NH = SOURCE, NI = SOURCE, NJ = SOURCE, NK = SOURCE, NL = SOURCE, NM = SOURCE, NN = SOURCE, NO = SOURCE, NP = SOURCE, NQ = SOURCE, NR = SOURCE, NS = SOURCE, NT = SOURCE, NU = SOURCE, NV = SOURCE, NW = SOURCE, NX = SOURCE, NY = SOURCE, NZ = SOURCE, OA = SOURCE, OB = SOURCE, OC = SOURCE, OD = SOURCE, OE = SOURCE, OF = SOURCE, OG = SOURCE, OH = SOURCE, OI = SOURCE, OJ = SOURCE, OK = SOURCE, OL = SOURCE, OM = SOURCE, ON = SOURCE, OO = SOURCE, OP = SOURCE, OQ = SOURCE, OR = SOURCE, OS = SOURCE, OT = SOURCE, OU = SOURCE, OV = SOURCE, OW = SOURCE, OX = SOURCE, OY = SOURCE, OZ = SOURCE, PA = SOURCE, PB = SOURCE, PC = SOURCE, PD = SOURCE, PE = SOURCE, PF = SOURCE, PG = SOURCE, PH = SOURCE, PI = SOURCE, PJ = SOURCE, PK = SOURCE, PL = SOURCE, PM = SOURCE, PN = SOURCE, PO = SOURCE, PP = SOURCE, PQ = SOURCE, PR = SOURCE, PS = SOURCE, PT = SOURCE, PU = SOURCE, PV = SOURCE, PW = SOURCE, PX = SOURCE, PY = SOURCE, PZ = SOURCE, QA = SOURCE, QB = SOURCE, QC = SOURCE, QD = SOURCE, QE = SOURCE, QF = SOURCE, QG = SOURCE, QH = SOURCE, QI = SOURCE, QJ = SOURCE, QK = SOURCE, QL = SOURCE, QM = SOURCE, QN = SOURCE, QO = SOURCE, QP = SOURCE, QQ = SOURCE, QR = SOURCE, QS = SOURCE, QT = SOURCE, QU = SOURCE, QV = SOURCE, QW = SOURCE, QX = SOURCE, QY = SOURCE, QZ = SOURCE, RA = SOURCE, RB = SOURCE, RC = SOURCE, RD = SOURCE, RE = SOURCE, RF = SOURCE, RG = SOURCE, RH = SOURCE, RI = SOURCE, RJ = SOURCE, RK = SOURCE, RL = SOURCE, RM = SOURCE, RN = SOURCE, RO = SOURCE, RP = SOURCE, RQ = SOURCE, RR = SOURCE, RS = SOURCE, RT = SOURCE, RU = SOURCE, RV = SOURCE, RW = SOURCE, RX = SOURCE, RY = SOURCE, RZ = SOURCE, SA = SOURCE, SB = SOURCE, SC = SOURCE, SD = SOURCE, SE = SOURCE, SF = SOURCE, SG = SOURCE, SH = SOURCE, SI = SOURCE, SJ = SOURCE, SK = SOURCE, SL = SOURCE, SM = SOURCE, SN = SOURCE, SO = SOURCE, SP = SOURCE, SQ = SOURCE, SR = SOURCE, SS = SOURCE, ST = SOURCE, SU = SOURCE, SV = SOURCE, SW = SOURCE, SX = SOURCE, SY = SOURCE, SZ = SOURCE, TA = SOURCE, TB = SOURCE, TC = SOURCE, TD = SOURCE, TE = SOURCE, TF = SOURCE, TG = SOURCE, TH = SOURCE, TI = SOURCE, TJ = SOURCE, TK = SOURCE, TL = SOURCE, TM = SOURCE, TN = SOURCE, TO = SOURCE, TP = SOURCE, TQ = SOURCE, TR = SOURCE, TS = SOURCE, TT = SOURCE, TU = SOURCE, TV = SOURCE, TW = SOURCE, TX = SOURCE, TY = SOURCE, TZ = SOURCE, UA = SOURCE, UB = SOURCE, UC = SOURCE, UD = SOURCE, UE = SOURCE, UF = SOURCE, UG = SOURCE, UH = SOURCE, UI = SOURCE, UJ = SOURCE, UK = SOURCE, UL = SOURCE, UM = SOURCE, UN = SOURCE, UO = SOURCE, UP = SOURCE, UQ = SOURCE, UR = SOURCE, US = SOURCE, UT = SOURCE, UV = SOURCE, UW = SOURCE, UX = SOURCE, UY = SOURCE, UZ = SOURCE, VA = SOURCE, VB = SOURCE, VC = SOURCE, VD = SOURCE, VE = SOURCE, VF = SOURCE, VG = SOURCE, VH = SOURCE, VI = SOURCE, VJ = SOURCE, VK = SOURCE, VL = SOURCE, VM = SOURCE, VN = SOURCE, VO = SOURCE, VP = SOURCE, VQ = SOURCE, VR = SOURCE, VS = SOURCE, VT = SOURCE, VU = SOURCE, VV = SOURCE, VW = SOURCE, VX = SOURCE, VY = SOURCE, VZ = SOURCE, WA = SOURCE, WB = SOURCE, WC = SOURCE, WD = SOURCE, WE = SOURCE, WF = SOURCE, WG = SOURCE, WH = SOURCE, WI = SOURCE, WJ = SOURCE, WK = SOURCE, WL = SOURCE, WM = SOURCE, WN = SOURCE, WO = SOURCE, WP = SOURCE, WQ = SOURCE, WR = SOURCE, WS = SOURCE, WT = SOURCE, WU = SOURCE, WV = SOURCE, WW = SOURCE, WX = SOURCE, WY = SOURCE, WZ = SOURCE, XA = SOURCE, XB = SOURCE, XC = SOURCE, XD = SOURCE, XE = SOURCE, XF = SOURCE, XG = SOURCE, XH = SOURCE, XI = SOURCE, XJ = SOURCE, XK = SOURCE, XL = SOURCE, XM = SOURCE, XN = SOURCE, XO = SOURCE, XP = SOURCE, XQ = SOURCE, XR = SOURCE, XS = SOURCE, XT = SOURCE, XU = SOURCE, XV = SOURCE, XW = SOURCE, XX = SOURCE, XY = SOURCE, XZ = SOURCE, YA = SOURCE, YB = SOURCE, YC = SOURCE, YD = SOURCE, YE = SOURCE, YF = SOURCE, YG = SOURCE, YH = SOURCE, YI = SOURCE, YJ = SOURCE, YK = SOURCE, YL = SOURCE, YM = SOURCE, YN = SOURCE, YO = SOURCE, YP = SOURCE, YQ = SOURCE, YR = SOURCE, YS = SOURCE, YT = SOURCE, YU = SOURCE, YV = SOURCE, YW = SOURCE, YX = SOURCE, YY = SOURCE, YZ = SOURCE, ZA = SOURCE, ZB = SOURCE, ZC = SOURCE, ZD = SOURCE, ZE = SOURCE, ZF = SOURCE, ZG = SOURCE, ZH = SOURCE, ZI = SOURCE, ZJ = SOURCE, ZK = SOURCE, ZL = SOURCE, ZM = SOURCE, ZN = SOURCE, ZO = SOURCE, ZP = SOURCE, ZQ = SOURCE, ZR = SOURCE, ZS = SOURCE, ZT = SOURCE, ZU = SOURCE, ZV = SOURCE, ZW = SOURCE, ZX = SOURCE, ZY = SOURCE, ZZ = SOURCE

A N N E X 4

DRILLING ACTIVITIES
SAMPLE COMPUTATION COMPARING CUMULATIVE RESULTS
FROM INCEPTION AND SINCE 1974 TO THE END OF 1975
WITH 1975 ANNUAL RESULTS

COUNTRY : UNITED STATES
 COUNTRY CODE : 702
 SEDIMENTARY AREA : 5,600,000 km²

WELLS COMPLETED	CUMULATIVE NUMBER SINCE START OF ACTIVITIES (IDEM PER 10,000 km ²)				CUMULATIVE NUMBER SINCE 1974 (IDEM PER 10,000 km ²)				1975 ANNUAL RESULTS			
	TOTAL		OIL		TOTAL		OIL		% SUCCESS	TOTAL	CHANGE FROM 1974 (%)	
	GAS	OIL	GAS	OIL	GAS	OIL	% SUCCESS	G+S			CIL	
EXPLORATORY WELLS	342,882 (612,289)	20,896 (37,314)	43,371 (77,448)	1,786 (3,189)	17,833 (31,945)	2,366 (4,225)	23.26	6.90	- 2.01	19.41		
NEW-FIELD WILDCATS	208,923 (373,077)	7,784 (13,900)	15,329 (27,373)	787 (1,405)	11,756 (20,993)	894 (1,596)	14.35	8.00	0.00	19.83		
	SUCCESSFUL WELLS (OIL AND GAS)	% SUCCESS	SUCCESSFUL WELLS (OIL AND GAS)	% SUCCESS	SUCCESSFUL WELLS (OIL AND GAS)	% SUCCESS						
EXPLORATORY WELLS	64,267	18.743	4,152	23.283								
NEW-FIELD WILDCATS	23,113	11.063	1,681	14.299								

DEPTH DRILLED (1 000 Meters)	CUMULATIVE DEPTH DRILLED SINCE 1974				1975 ANNUAL RESULTS			
	CUMULATIVE DEPTH DRILLED SINCE START OF ACTIVITIES		AVERAGE DEPTH		DEPTH DRILLED (1,000 Meters)	AVERAGE DEPTH		PER COMPLETED WELL SUCCESSFUL WELL
	CUMULATIVE TOTAL	CUMULATIVE PER COMPLETED WELL TOTAL	CUMULATIVE TOTAL	CUMULATIVE PER COMPLETED WELL TOTAL		PER COMPLETED WELL	PER SUCCESSFUL WELL	
EXPLORATORY WELLS	502,029	1.46	7.8	31,732	1.78	7.6	1.78	7.7
N.F.V.	313,096	1.50	13.5	21,534	1.83	12.8	1.85	12.9

PART 4

COAL AND URANIUM

DATA BASES

Recent Developments of IEA Research into World
Coal Resources and Reserves

Stuart V. Duncan and Glenn Van Doorne

World Coal Resources and Reserves Data Bank Service,
International Energy Agency Coal Research,
14, Lower Grosvenor Place,
London SW1W OEX, U.K.

The status, from a systems point of view, of IEA research into world coal resources and reserves was described by Gregory (1977) to the third IIASA Conference on Energy Resources. The three module approach, then described, remains essentially unchanged. However, it is now recognised that the longevity of data on the spatial configuration of the coal-in-place in resources can, when the resources in a deposit are large in relation to the projected rates of depletion, greatly exceed the longevity of the associated data in the economic domain. This paper outlines modifications to two of the modules of the original system, namely the mining and marketing modules, coupled with a change of computer database management system from the USGS PACER - GRASP System to the Honeywell Multics Relational Data Store. The modifications made aim to distinguish, through the use of new indices of mineability and marketability of coal-in-place, resources likely to be exploited in the near term and those likely to be deferred into the far term for which no valid economic data indicative of demand is likely to be available. The resulting system is now undergoing preliminary trials.

Introduction

In order to meet one of the objectives of the International Energy Programme of the Organisation for Economic Co-operation and Development (OECD), the International Energy Agency (IEA) established in 1975, a World Coal Resources and Reserves Data Bank Service (WCRRDBS) based in London. The Service aims to provide better assessments of global coal resources and reserves by gathering any available data, both published and solicited, and reducing it to a form which makes meaningful aggregation possible. Such reduction involves a translation of data from national to an international standard followed by reserve assessments which is able to take economic factors into account. At a time when energy (and, in particular, oil) crises are occurring with alarming regularity and doubts are being cast about the safety aspects of some alternative energy sources, the role of the Service is seen as being increasingly more relevant to the world energy picture.

The IEA Approach

Gregory (1977), in his presentation to the third IIASA Conference on Energy Resources, described the approach being taken by WCRRDBS to achieve its aims. He described the three component parts of the operation : data collection, data translation and reserve assessment.

Data is gathered from both available published sources and, where co-operation is needed, from direct enquiry in the form of a suite of questionnaires, requesting various degrees of detail, sent to the country under investigation. Data includes both spatial data on coalfields or parts of coalfields and point data from boreholes, underground samples etc., Data is translated in respect of direct unit conversions (e.g. imperial to metric), validated inasmuch as this is possible and banked on the Service's database on US Geological Survey (USGS) facilities accessed via telecommunications.

Data is thus stored in raw and unmodified form excepting direct unit conversion. More complex and interpretive and qualitative conversions are carried out in the second stage of the operation where the results of such translations are retained on the database physically separate from the raw data which thus remains undegraded. The simplest of these conversions relate to bracketed data: in one country data may be classified by depth brackets 0 - 100, 100 - 300 and 300 - 1200 metres, whilst in a second the breakdown may be on ranges of 0 - 200, 200 - 500 and 500 - 1500 metres. This translation involves some interpolation. Other translations involve comparison of coal ranking systems and reserves and resource classification systems from different countries and here differing degrees of success are achieved depending upon the degree of sophistication of the system involved and the presence or absence of supportive data. The converted data is qualified with a flag indicating the reliability ascribed.

In the final part of the operation, data stored on the database is subjected to reserve analysis. The IEA approach aims to be able to take into account all of the factors of location, geological setting, mining technology, recoverability, productivity, production costs, local availability of manpower, capital and services, relative influence of environmental and social constraints, coal quality, utilisation technology, demand, price and transportation cost to existing or potential markets. Figure 1 shows a simplified flow diagram of the steps involved in this part of the operation. As can be seen, an assessment commences with the retrieval of resource data from the database which is then passed through three processing modules.

The 'exclusion module' takes into account resources that are not extractable for environmental or other reasons. The 'mining module' uses whatever data components are present in the input matrix in a number of expressions which give relative operating costs for a variety of mining techniques together with recoverable tonnages. The 'marketing module' uses output from the mining module to calculate potential pithead prices for different markets and to relate these to operating costs so leading to reserve selection.

The system as a whole aims to provide a basis for comparing reserves on an international basis whilst accounting for local factors and providing for the utilisation of alternative assumptions. Gregory (1977) recognised that the system would also have

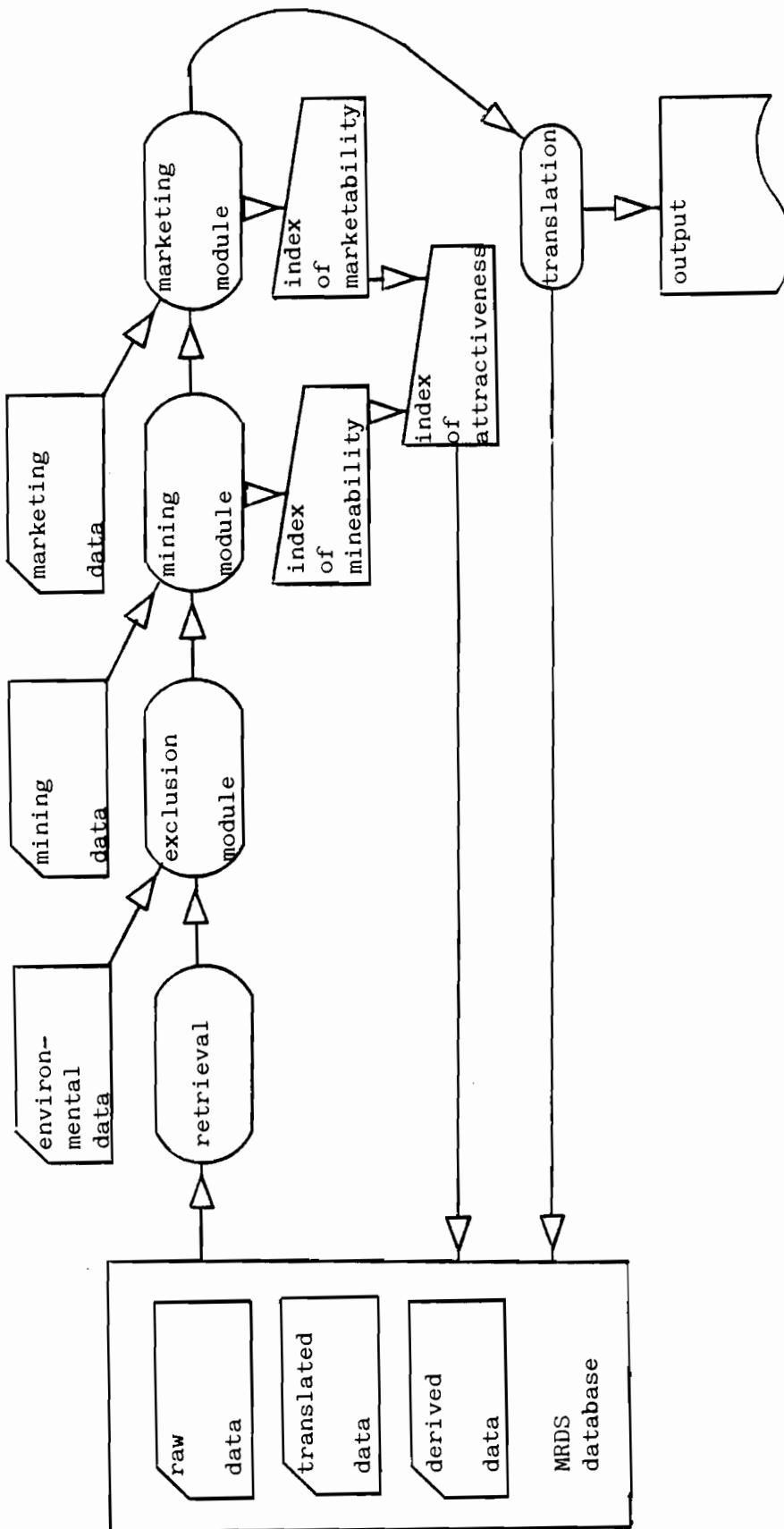

Figure 1 : Simplified flow diagram of the IEA method of coal reserve assessment.

to take account of the changes of relative market attractiveness of coal and of alternative fuels in the bulk energy supply market. Further consideration of this latter factor has led to some modification of the mining and marketing modules of the assessment system.

Development of the IEA approach

Changes in reserve figures for a particular coal deposit may be due to any one or more of the following factors:

- (i) extraction of coal
- (ii) addition to the stock of identified coal-in-place by extrapolation or extension
- (iii) change of local or national reserve assessment conventions
- or (iv) change in the fraction of coal resources comprising reserves within a fixed convention.

The IEA method now attempts to account for each of these changes. Extraction and addition require an update of the raw data on the database, convention changes require modification of the translation tables, but the reserve/resource ratio changes require additional input to and processing by the marketing and mining modules of the reserve assessment system. This processing takes into account, what may be termed, 'relative attractiveness' of the coal deposit, and places this within a time framework in relation to reserves.

Relative attractiveness of an energy resource is seen to be a function of ease of extraction (or mineability) and ease of disposal (or marketability) of the coal-in-place in the coalfield. This has been discussed by Grenon (1978) in terms of the WELMM method where the Resource Database includes geological, geometrical and geographical data on the deposit itself as well as data on exploitation potential and the associated resources of land and water required.

An immediately apparent problem in quantifying ease of extraction is that the essential geological data on extractability is usually in a very disaggregated form and that the component parts are themselves complexes of spatial elements. Thus, if rapid methods of indexing attractiveness are to be derived, there is a clear need for generalised and more aggregated forms of the raw data. Research carried out in the WCRRDBS has shown that the generalised contributing factors of extractability of coal are geologic dip, disturbance and stratigraphic concentration. Similarly, disposability of coal may be approximated as a function of coal rank, purity and equivalent distance to market.

Fettweis and Stangl (1975) have drawn attention to the long run changes in coal reserves by an historical study of the Ruhr coalfield. It is apparent that when long run reserves are considered, the rate of change of reserves with time are much greater in the less attractive (that is, more costly and/or less valuable at market) mature coalfields than in the more attractive coalfields. In a situation of long run falling demand for coal, capacity is reduced

and concentrated in those mines with the better reserves. This process increases the ratio of deferred reserves to reserves still in virgin coal.

It is reasonable to believe that the reverse of this process will be obtained in a future situation of long run rising demand for coal and thus it is important to be able to distinguish between those resources likely to be exploited in the near future and those which will be deferred to the longer term beyond the currently reasonable extrapolation of economic considerations. The index of attractiveness being developed by the WCRRDBS is seen as a rapid and simple method of providing this distinction.

Indexing 'Relative Attractiveness' of Coal Deposits

The WCRRDBS method utilises two new indices of relative attractiveness in a coalfield or part deposit. The mineability index is utilised in the mining module of the assessment system and the marketability index is utilised in the marketing module. The methods used to derive these indices are required to be rapid, easily understood and scientifically repeatable and have been developed by the WCRRDBS with these requirements foremost.

Mineability Index or Ease of Extraction

The degree of ease of extraction of coal from a coalfield is considered to be a function of the three geologic factors of dip, coal concentration and disturbance of the coalfield. Whilst these are obviously not the only factors which control mineability, it is evident that many of the other parameters will influence the chosen factors. Ease of extraction has been evaluated by quantification of the related factors as a dip index, coal concentration index and disturbance index. Figure 2a shows how a coalfield may be plotted as a vector in a three dimensional graph with these component indices as axes. Given that the axes are scaled correctly, the length of the vector is clearly related to the ease of extraction and this is termed the mineability index. The indices controlling the mineability index are discussed in the following paragraphs.

Dip: a rapid study of the most important coalfields in the world has led to the conclusion that the geologic dip of the coal bed is one of the most important single factors influencing the ease of extraction of the coal. The values used for the ranking of a coal deposit by dip are limited by technical factors such as maximum dip for efficient transport (underground or opencast, trackless or by rail), maximum dip limiting efficient longwall mining etc. A numerically integrated dip as an average for the whole area studied, is the determining factor for the ranking of coal deposits

by dip and the dip index is synthesised in this way (the lower the dip index, the more attractive the coalfield).

Coal Concentration: the next important factor influencing ease of extraction is the concentration of the coal within the stratigraphic sequence. This factor is a combination of the average thickness of the various coal seams and their spatial distribution in a vertical section. An index of coal concentration derived from the spatial seam thickness distribution is plotted along the y axis of the three-dimensional graph of ease of extraction.

Disturbance: the final factor contributing to ease of extraction is geologic disturbance. As a disturbance is termed any geological feature that interrupts the continuity of the coal seam (such as a fault, dyke or washout). All geological information about disturbances are taken into account whether they have been discovered in the course of exploration or of exploitation or whether they are inferred (i.e. geophysically undetectable but expected). The index of disturbance is an indirect measure of the expected production losses due to disturbances and is plotted on the z-axis of the three-dimensional representation of ease of extraction.

The vector resulting from the combination of the dip, concentration and disturbance indices is the comparative value for a ranking of coal deposits in order of ease of extraction and is termed the mineability index.

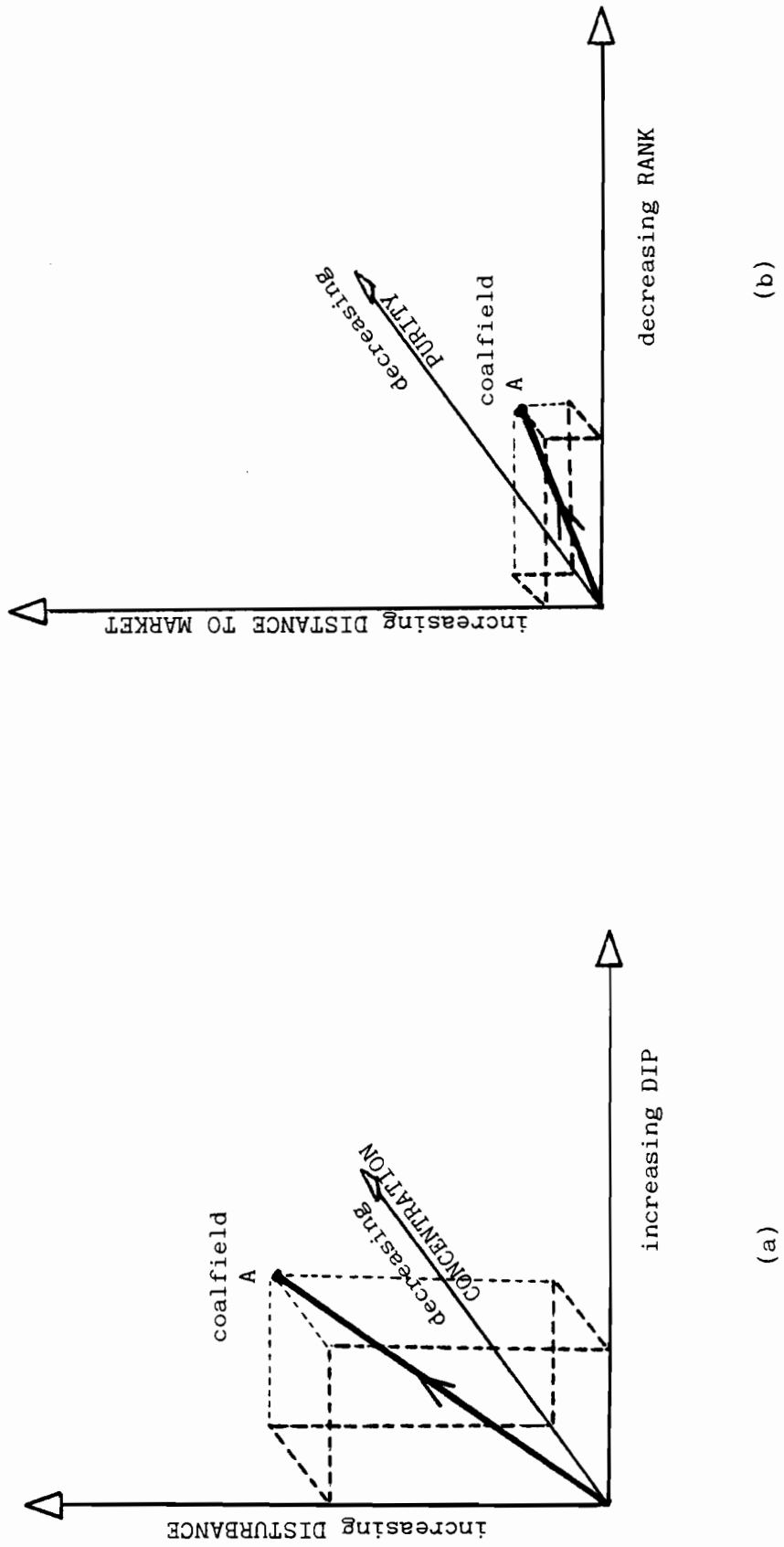

Figure 2 : Three-dimensional graphical representations of the indices of (a) mineability, and (b) marketability defining the attractiveness of a coalfield.

Marketability Index

The ease of disposal of coal from a coalfield is considered to be a function of coal rank, coal purity and distance to market. Again, many other factors are evidently involved but most will control the chosen factors to some extent. Just as the mineability index synthesised in a three-dimensional graphical relationship, so the marketability index is derived from a plot with appropriately scaled axes of rank index, purity index and market distance index, as shown in figure 2b. The following paragraphs discuss these indices.

Coal rank: the rank of a coal deposit controls the ultimate price of the coal in a particular market. It is not possible to adequately measure rank by one simple method and the IEA approach is to equate rank to degree of volatility over one part of the range and calorific value in the remainder. There is some degree of overlap and, additionally, other methods of determination (such as reflectance) can be used where this data is available. The index of rank thus derived is plotted on the x-axis of the ease of disposal three-dimensional graph.

Purity: the price fetched from the sale of coal is also dependent on the purity of the coal. The index of purity aims to quantify the degree to which the coal has been affected by both diluents and contaminants. The index is plotted on the y-axis of the ease of disposal graph.

Equivalent distance to market: transport costs affect the proceeds from the sale of the coal in an appropriate market. The equivalent distance to market index attempts to involve a variety of factors which contribute to the cost of transporting coal to its market. This index is used as the z-axis of the marketability representation.

As with the ease of extraction vector, the resulting ease of disposal vector is a combination of the coal rank purity and market distance indices. This vector is the basis for a ranking of the coal deposits in order of ease of disposal, and is termed the index of marketability.

The attractiveness of a coal deposit, finally, is defined by its ease of extraction and its ease of disposal. A multiplicative function of the mineability index by the marketability index, results in an attractiveness index that can be used for a relative ranking of coal deposits. The most attractive coal deposits will be those that are the easiest to mine and have the least problems in disposing of their coal and these will be represented by shorter attractiveness vectors.

Preliminary trials of the application of the attractiveness index and its component indices to British and Belgian coalfields have produced results which compare favourably with actual exploitation. Further trials which will concentrate on refining the all important relationships between the six indices (that is the scaling factors

on the axes of the three-dimensional plots and the factors to be included in the final attractiveness calculation) will be carried out when the WCRRDBS schedule permits.

Database Management

In order to obtain the high degree of flexibility and interaction required of the database to accommodate re-estimating and repeated updating of raw data, data derived from translation processes and data derived from the modified mining and marketing modules, the PACER (Cargill et al 1976) extension of the GRASP (Bowen & Botbol 1975) database management system, written especially for the USGS National Coal Resources Data System has been linked to and partially replaced by the Honeywell Multics Relational Data Store (MRDS) (Honeywell 1977) also available on the Multics computer system in the USGS. MRDS, being a relational database system, allows for geologically oriented relationships to be defined and redefined within the data at will, whilst retaining a high degree of data independence and consequent application program common interfacing.

The MRDS package includes LINUS, an inquiry and update system using simple non-procedural commands capable of being utilised by the non-computer oriented users to easily interrogate the database and a comprehensive report generator capable of producing camera ready output.

Conclusions

An index of attractiveness has been defined which is able to indicate some ranking of the order of attractiveness of coalfields. The index is quantitative but based on empirical relationships between indices of geologic dip, concentration and disturbance (synthesising a mineability index) and of coal rank, coal purity and equivalent distance to market (synthesising a marketability index). Index of attractiveness can be incorporated in the modified IEA method of coal resource/reserve assessment. At present, whilst the WCCRDBS effort is concentrated on data capture, the index of attractiveness has been calculated on a trial basis only on a limited number of coalfields but preliminary results have been encouraging. It is believed that it has a potentially useful role to play in the planning of the exploitation of virgin fields and of the coal resources of less well developed mining industries.

The index of attractiveness is considered to be a useful element of the assessment of coalfields in a situation where the longevity of the resource exceeds reasonable economic forecasting. As market situations and mining technologies develop, so the index of attractiveness can be recalculated and the ranking of the coalfield for exploitative purposes can be re-assessed.

Attractiveness estimations of coalfields allow exploitation potential to be studied within a macro-economic environment; developments in neighbouring coalfields will affect the attractiveness of the coalfield in question. As such external elements in the environment change, so will the attractiveness index.

Acknowledgements

The authors wish to acknowledge the contribution made by other members of the WCCRDBS of the IEA Coal Research to the ideas presented in this paper. In particular, they are indebted to Mr. A.M. Clarke for his ceaseless stimulation, to Mr. W.S. Foster for critically reading the manuscript and to Mrs. Maureen Keylock for preparation of the typescript.

The views expressed in this paper are those of the authors and not necessarily of the WCCRDBS as a whole.

References

- Bowen, R.W. and Botbol, J.M. (1975) 'The Geologic Retrieval and Synopsis Program (GRASP)' USGS Prof. Paper 966: 87 pp.
- Cargill, D.M., Olson, A.C., Medelin, A.L. and Carter, M.D. (1976) 'PACER - Data Entry, Retrieval and Update for the National Coal Resources Data System (Phase I)' USGS Prof. Paper 978: 107pp.
- Fettweis, G.B. and Stangl, P. (1975) 'Opening and Utilization of coal reserves in the Ruhr until 1970' Glückauf III: 101-107 (in German).
- Gregory, K. (1977) 'The Approach of IEA Coal Research to World Coal Resources and Reserves' in: M. Grenon, Editor, Future Coal Supply for the World Energy Balance. Proc. 3rd IIASA Conf. on Energy Resources, Moscow. Pergamon Press. Oxford.
- Grenon, M. (1978) 'WELMM, A Systems Approach to Energy Resources' Nat. Res. Forum, 2 (2): 121-132.
- Honeywell Inc. (1977) 'Multics Relational Data Store (MRDS) Reference Manual : Honeywell Order Number AW53 : Revision 0'.

A Data Base for Coal Mines

A. Astakhov*
M. Grenon
A. Grüber

International Institute for Applied Systems
Analysis, A - 2361 Laxenburg, Austria
*and Academy of National Economy
Aviamotornaya St. 26/5 111024 Moscow, USSR

Contrary to processes upstream the coal chain (conversion, transportation, etc...) which are technology and size specific, and therefore can be easily represented as "standard" types of energy facilities, coal mining (as well as any other extractive) activities are first of all site specific (i.e. the deposit geology primarily determines the technology employed and the size of a mine). The Coal Mines Data Base (CMDB) developed at IIASA is therefore at the intersection of the concepts underlying the industrial processes (Facility) data base and data bases on primary resource availability (Resource Data Bases) of the WELMM approach. The CMDB records data on mines, chosen to represent typical conditions at the level of coal basins and covers a wide range of information from the areas of technology, geology, environmental and regional data to the natural resource (WELMM) requirements and economics for the construction of an operation of a particular mine. The structure and contents of the CMDB, follow closely a questionnaire developed for the purpose of data collection; the main areas in which data are recorded are summarized and examples given. The organization as well as the implementation of the CMDB in a relational natural language data base management system (INGRES) as well as additional software, developed to improve the user-data base interface are outlined. Finally the status of the CMDB as well as an overview of its possible application are discussed and examples are given.

INTRODUCTION

The studies performed within IIASA's Energy Program have shown the increasing importance that large-scale extraction processes will assume in the transition away from natural petroleum. Recognizing the important role coal resources will have within this context, a case study in applying the WELMM (Water, Energy, Land, Materials, Manpower) Approach ([1], [2]) to large scale coal mining operations was performed at IIASA.

The WELMM approach is drawing (both at the conceptual as the practical level) from two main data bases. The first one is the so-called "Facility Data Base"*, a process information system on the natural resource (WELMM) and economic requirements and impacts of energy production and conversion facilities. The boundary drawn to define a process is generally in such a form that a "facility" is corresponding to a "standard" type of industrial plant, both from the technology utilized and the size of the installation. It is relatively easy to define standard types of facilities at the top end of the coal chain (conversion and transportation) - for example, coal unit trains of 10000 tons, gasification complexes of two billion m³ per year or coal-fired power plants in the 600 to 1000 MWe range - especially when one considers the increasing trend of standardization of the size of energy installations. On the other hand, it is practically impossible to reduce the great number of coal mines, opencast or underground to a few representative examples. In fact, coal mining operations are not so much technology or size specific

* this data base is described in detail in Part 2 of these proceedings. [the Editors]

but first of all site specific; i.e. the local deposit geology determines primarily the technology employed and the size of a particular mine. The description of a coal mining process has therefore to incorporate equally this deposit component, which in the Welmm Approach is normally represented in the form of a "Resource Data Base" on primary resource availability independantly from the technological process (Facility) data base.

The Coal Mines Data Base (CMDB) developed at IIASA can therefore be seen at the intersection of the data bases on industrial processes and primary resource availability. For the CMDB a decision was made to select representative mines from the point of view of technology and geology (depth, number and thickness of seams, coal quality etc...) on the level of major coal basins.* Naturally, the greatest attention has been attributed to those basins which are capable of making a considerable contribution to a potential world coal market (e.g. basins in Australia, USA and USSR). The information on individual mines contained in the CMDB is then further analyzed to obtain relational type of information in order to compare mines between individual basins and/or to extrapolate from the examples stored in the CMDB for similar or different conditions in the same (or in other) basin(s). This will be discussed further in the section on applications of the CMDB in this paper.

* the number of mines for a given basin stored in the CMDB can therefore vary depending on the variations of the conditions inside the basin.

STRUCTURE AND CONTENTS OF THE CMDB

For the purpose of data collection a special questionnaire was developed at IIASA. The actual structure and contents of the CMDB follow closely the organization of this questionnaire. The general characteristics of the coal deposit, of the mine and environmental data are stored in 14 files, totalling 115 different parameters. Additional non-numerical information (e.g. on geology, genetics, etc...) is provided in a text footnote. These files contain information on the following areas:

- a) general data on mine(type of technology; location; data origin, etc...)
- b) geological conditions (area extension of seams; number, thickness and depth (average and maximum) of seams; mining depth, etc...)
- c) stratigraphic sequence of seams (a stratigraphic table listing the individual seams in increasing depth order, their thickness; depth; dip and upper ash content)
- d) coal resources and reserves (coal resources of field, and in seams to be mined; reserves; operational coal losses; recovery rates; etc...)
- e) geotechnical conditions (tectonics; coal and rock density; gas and spontaneous combustion tendency; water inflow; etc...)
- f) coal quality: (grade; moisture; ash; calorific content etc...;
- g) lower, upper and average values of the coal characteristics)
- h) local and regional characteristics (landscape; existing and future planned land uses; hydrology etc...)
- i) climatic and population data (average temperatures; precipitation; degree of development of region; population density etc...)

- j) general technological characteristics of mine (capacity and output in raw and saleable coal; lifetime; date of construction, etc...)
- k) evolution of coal output over lifetime of mine (in raw and saleable coal tonnages)
- l) technical mine parameters for surface mines only: (number of operating units, production organization; method of mining; overburden to coal ratio; etc...)
- m) technical mine parameters for underground mines only: (number of operating units; production organization; system of seam opening and number of shafts/drifts etc...; method of mining)
- n) list of main equipment (number, item, manufacturer, working weight, etc...)

This of course, is only a summary of the individual parameters recorded, their exact definition is documented in the questionnaire used for data collection and equally in it's computerized form used for the interactive data entry program (for an example see Appendix 1).

Following these files describing the mine and its geologic and natural environment the data base contains two files recording the WELMM requirements and economic parameters for the construction and operation of the mine. Appendix 2 presents a sample listing of these data for an opencast mine in Austria. The data are stored as specific values per ton raw or saleable coal produced (or per ton annual mine capacity for the construction period). This is to facilitate comparisons between mines with different output and further statistical analysis of the data in the CMDB. However, the original values for the mine as a whole

can be easily recalculated using the data base management system, in which the data files are stored.

ORGANIZATION AND DATA BASE MANAGEMENT SYSTEM

The files of the CMDB mentioned above are stored using a relational data base management system, called INGRES (developed at the University of Berkely [3]) implemented on the UNIX operating system running on a PDP 11/70. The individual (or any combination of) data parameters stored in INGRES are accessible using a simple natural query language. However, as the number of parameters stored is quite large (around 140 in 16 different files) it requires a certain amount of user experience to work on the data base without some preparation. This preparation is in fact quite simple: inside INGRES, all necessary information (name of files and attribute names (i.e. names of the data parameters in INGRES), formats, etc.) can be retrieved with a simple "help" command, which is accessing special systems files (relations) containing all this information. In addition the computerized version of the questionnaire (see Appendix 1) can be accessed outside INGRES and all necessary information can be obtained. Still in order to ease further the user-data base interface, additional interactive programs for data entry, retrieval and statistical data analysis have been developed. Figure 1 shows a schematic diagram of the various data files and subprograms of the CMDB. These subprograms include:

- an automatic interactive data entering program; in an interactive session the user answers to the questions of the questionnaire, his answers are checked by the program for consistency, required format and allowed value range and in case an

Fig. 1. Organization of Files and Programs of CMDB

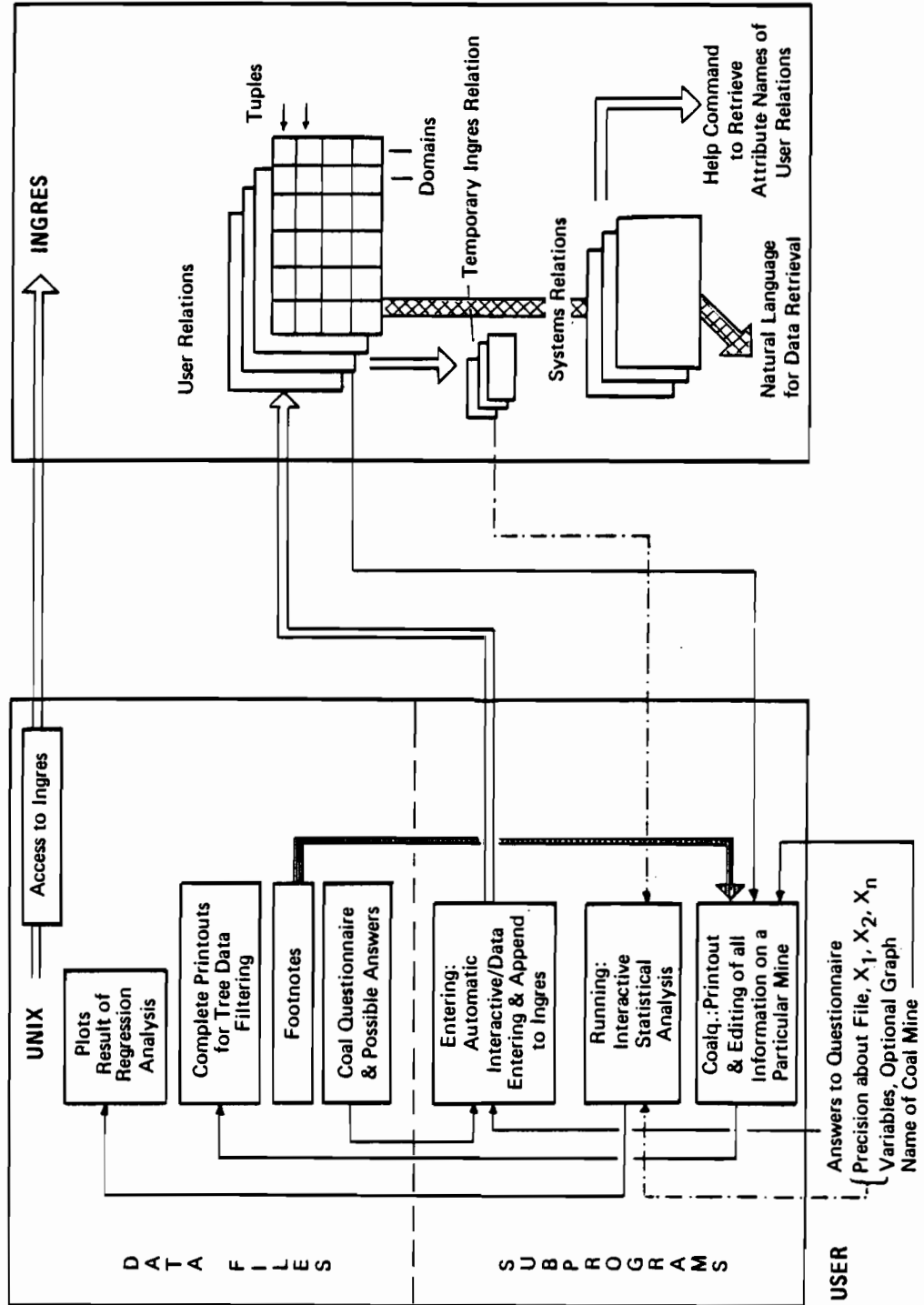

error is detected the question is posed again with the precision about the required format (integer, floating or character) and the range of possible answers. After the session the program copies the entered data automatically into the various relations in INGRES.

- complete printouts: this program accesses for any particular mine, precised by the user, all relevant data stored in INGRES as well as the text footnote stored in UNIX, edits the data and stores the result, a complete listing of all data of the CMDB on a particular mine, in a file which can then be sent to a line printer
- interactive statistical analysis: the use of this program requires first the preparation of a temporary relation inside INGRES containing the data to be analyzed. In an interactive session the user then precises the name of the (temporary) relation and the y and the various x variables. The program then performs a regression analysis (either polynomial or multiple linear depending on the type of program chosen), the results are stored in a file which is (together with optional plots) printed.

All the data base organization and data base management system in use for the CMDB have been developed with the objective to achieve maximum ease and simplicity for the data base user. However in considering that the data base is implemented on a rather small computer, these advantages are compensated at times of heavy systems load by slower response times.

Status of CMDB and (possible) Applications

At present the CMDB contains data on around 70 coal mines (opencast and underground) from around 25 major coal basins. Additionally it contains data on mines estimated for hypothetical mining conditions as well as information on a whole coal basin (the Lorraine basin in France). The countries covered by the CMDB are the USA and the USSR (represented by 35 and 21 mines), Australia, Austria, Bulgaria, the FRG, France and the United Kingdom.

As the number of data parameters for the CMDB is already quite large, containing an important amount of information dealing with regional, environmental, climatic aspects, and aiming to contribute to a more comprehensive study of the problems related with coal exploitation, it is evident that the data base cannot be complete in all cases. It should rather be interpreted as a structure containing first of all a certain number of "hard" technological, resource requirements and economic data, allowing to record supplementary information on other systems aspects of coal mining as they become available or necessary in course of a particular study. However, it is particularly the area of the requirements during the construction period of a mine where we feel the data availability to be unsatisfactory. Finally it is worth mentioning that a data base system like the CMDB can only be implemented and data collected, in direct contact with industry. Available information in literature, particularly abundant in the case of the USA (e.g. in form of Environmental Impact Statements) are

in most cases* only of limited value, whereas experience has shown that the required data can be obtained at a nearly 100 percent rate within a few hours in working directly with the mine manager or his staff.

The possible type of applications of the CMDB especially in relation with the Facility Data Base developed within the WELMM project are manifold and summarized in Figure 2.

First of all, the data stored in the Coal Mines Data Base (CMDB) have already been used in analyzing the extraction part of coal energy chains [5].

Other examples of application consist of correlations between geological/technological parameters and the consumption of natural resources or economic impacts. This study allows a better assessment of which natural and human resources have to be mobilized in order to extract coal under given conditions and to obtain a first evaluation of the impacts of development of a coal field when detailed project studies are not yet available. This analysis (e.g. through the earlier mentioned statistical analysis programs) aims to achieve a better understanding and modelling of questions like:

- Consumption of natural resources (WELMM) for coal exploitation under various deposit conditions.
- Relations between geological/technological parameters and the costs of investment and operation.
- Scale effects of mining operations.
- Relations between extraction technology and coal resources and reserves. (i.e. their recoverability)

* as an exception we note in particular the excellent studies performed by the Flour Utah Corporation [4]

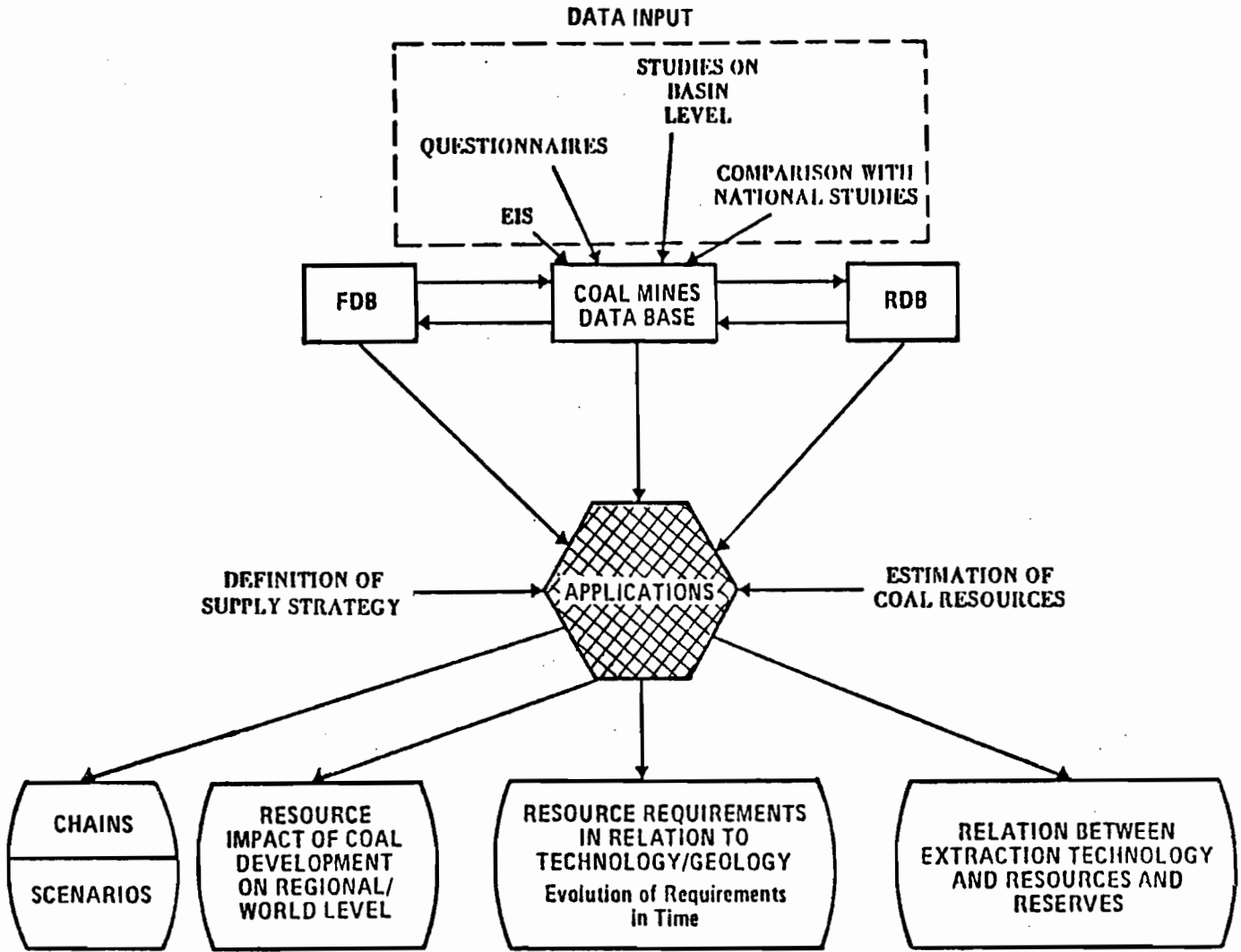

Figure 2. Interconnections Between the WELMM Data Bases and Possible Applications to the Study of Coal Resources

For examples of this type of analysis, see figures 3 and 4. Based on the results of such an analysis the question of the evolution of mining technology in time, as reflected for instance in the labor productivity, size of mines etc., can be studied. In combination with the Facility Data Base (recording data on technologies upstream the coal chain) the CMDB enables scenario analysis of the impacts of a particular supply strategy or of the impacts of a large-scale development of coal production and transformation in a given region.

As a conclusion, it is hoped that the CMDB at IIASA will also serve outside users and will provide an incentive to compare the data and the results* with national studies.

* a detailed research report entitled: Resource Requirements and Economics of Coal Mining in Selected Coal Producing Countries, is in the course of publication at IIASA [the Editors].

Figure 3. Relationship between average/total seam thickness mined and specific land requirements for opencast mines (all systems of technology)

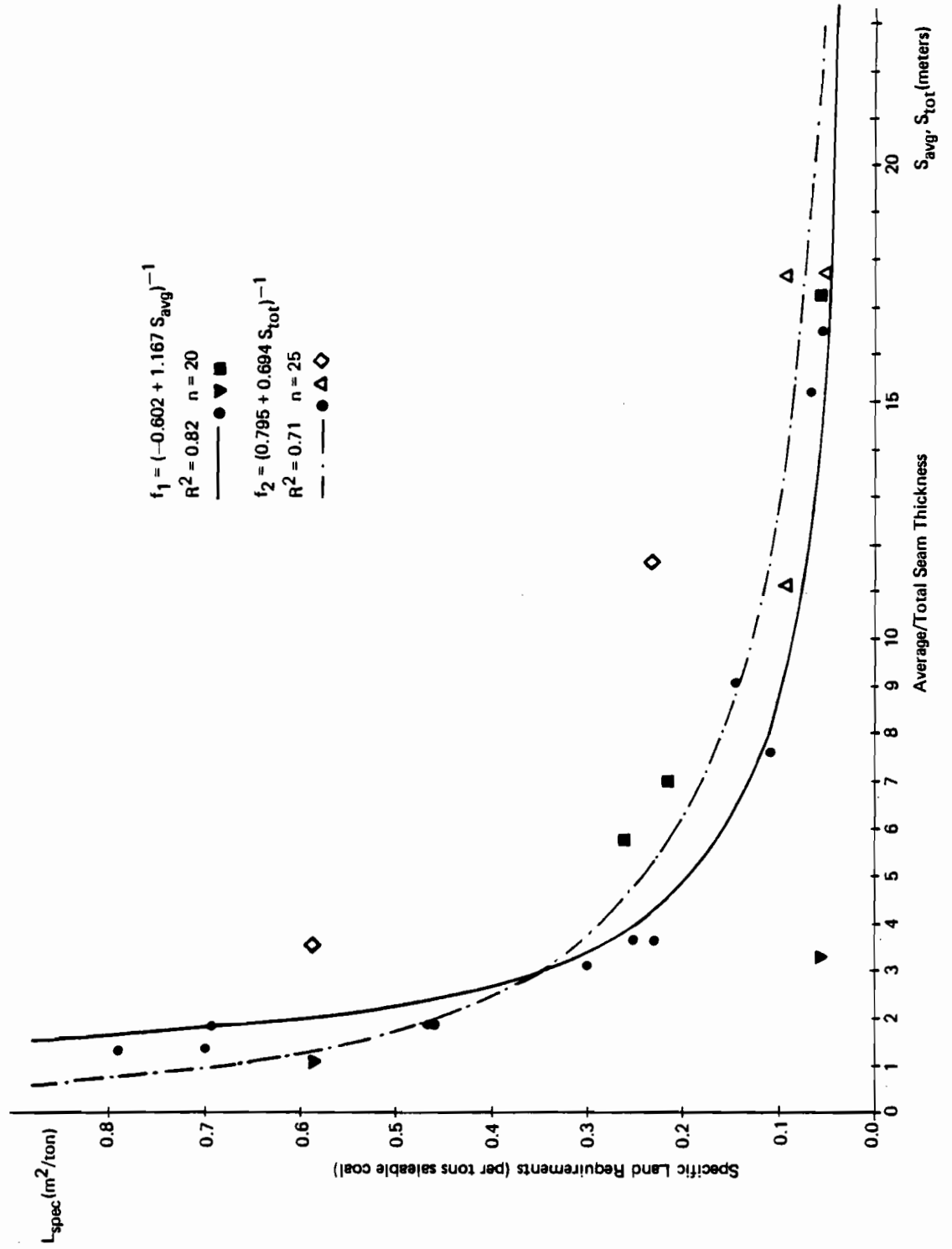
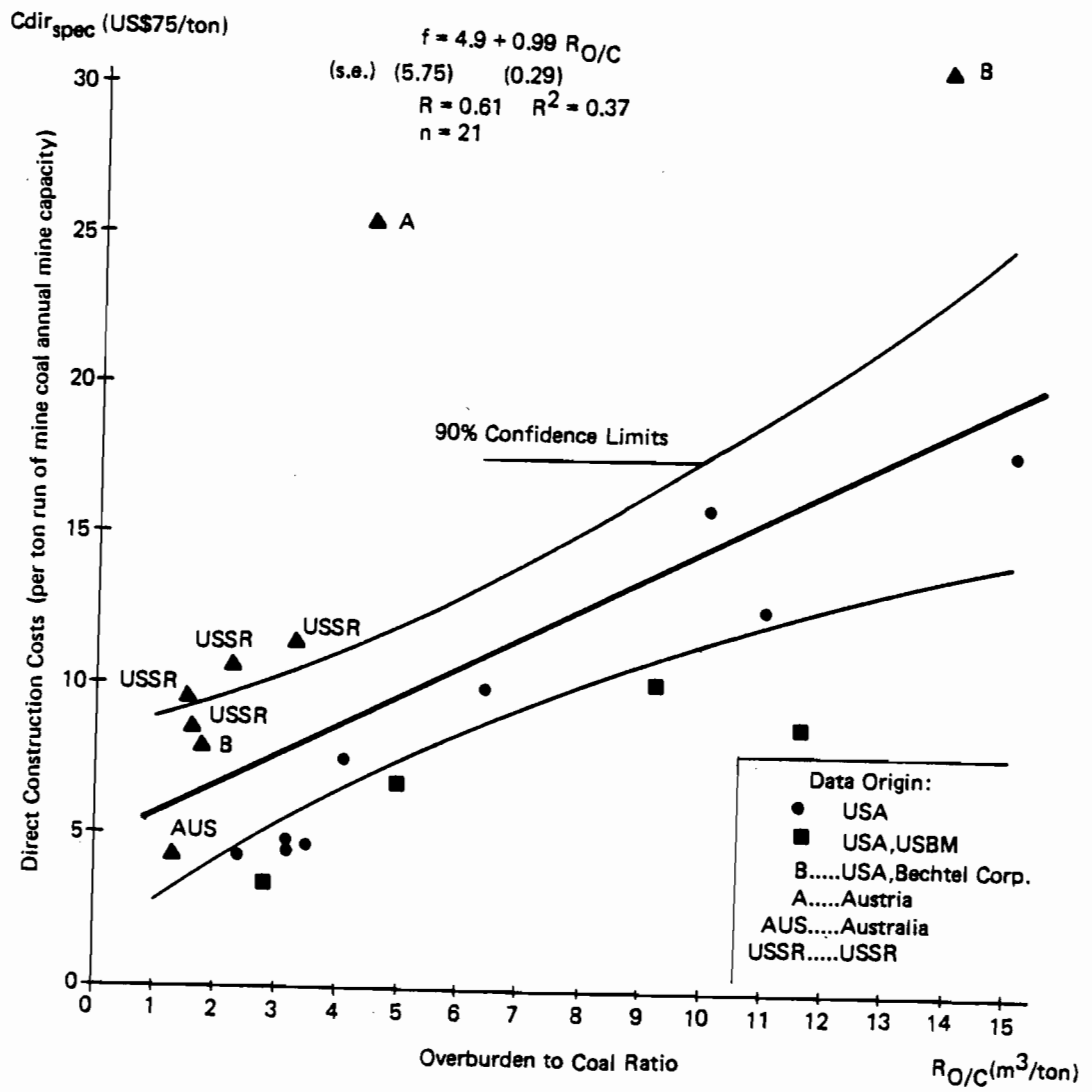

Figure 4. Specific Direct Construction Costs versus Overburden to Coal Ratio for Opencast mines (all systems of technology)



REFERENCES

- [1] M. Grenon, B. Lapillonne, 1976, The Welmm Approach to Energy Strategies and Options, IIASA RR-76-19, Laxenburg, Austria.
- [2] Grenon, M., A Systems Approach to Resources Management in Resource Management and Optimization. An International Journal. Volume 1, Number 2 1980. Eds. M. Lévy and J.R. Pfafflin, Harwood Academic Publishers, New York.
- [3] Woodfill, J., et.al. 1979, INGRES Version 6.2 Reference Manual. Memorandum UCB/ERL M79/43, University of California, Berkeley.
- [4] Flour Utah Inc., 1977, Economics of Large-Scale Surface Coal Mining Using Simulation Models, Vols. 1 to 16, NTIS FE-1520-101 to 116
- [5] A. Grübler, 1980, Resource Requirements for Industrial Processes: A Welmm Comparison of Energy Chains, IIASA WP-80-50, Laxenburg, Austria.

APPENDIX 1

Example of a part of the computerized
questionnaire of the CMDB

DATABASE NAME: welmm
RELATION NAME: omimesa
FILE FUNCTION: append

QUESTION TO BE ASKED	DOMAIN NAME	FRNT	RANGE OF ANSWER	RESPONSE	NAME OF UNITS OF MEASUREMENT	BUFFER
code of mine	code	c10	s- u-			sto a sto a rel a
process	proo	c4	-1 n* m mp m+p	-1 -1 m m+p m+p	data not available data not available mining mining and preparation mining and preparation	
type of technology	techno	c6	-1 n* s* u*	-1 -1 surf und	data not available data not available open cut underground	
data origin	origia	c6	-1 n* ac* es* pr*	-1 -1 actual estima proj	data not available data not available existing, operating mine estimated (for a given field) projected (for typical cond.)	
reference year	rfyear	i2	n* -1 > 2050 > 1900	-1 -1 -	data not available data not available reference year reference year	
country	country	c16	n* -1	-1 -1	data not available data not available	
country code (Tree)	coode	c2	-1	-1	data not available	
region	region	c16	-1	-1	data not available	
state	state	c16	-1	-1	data not available	
basin	basin	c16	-1	-1	data not available	
basin code	boode	c3	-1	-1	data not available	
field, mine	minename	c24	-1	-1	data not available	

APPENDIX 2

Example listing of construction and operational
data recorded in the CMDB for an
opencast mine in Austria.

specific wellmm requirements for construction

perrom = specific wellmm requirements per metric ton run of mine coal
 persale = specific wellmm requirements per metric ton saleable coal

note : if no coal preparation perrom = persale

name	perrom	persale	unit
water inflow during construction	0.505	0.505	m3 per t ann capacity
water used during construction	0.000	0.000	m3 per t ann capacity
electricity	40.000	40.000	kwh per t ann capacity
motor fuel	1.228	1.228	liters per t ann capacity
land affected by construction	0.080	0.080	ha per 10e3 t ann capacity
total land leased incl waste rock piles	0.160	0.160	ha per 10e3 t ann capacity
land occupied by mine buildings	0.160	0.160	ha per 10e3 t ann capacity
land for railways & worker villages	-1.000	-1.000	ha per 10e3 t ann capacity
manual technical manpower	292.000	292.000	manyears per 10e6 t ann cap.
workers with mining qualifications	-1.000	-1.000	manyears per 10e6 t ann cap.
manual non technical manpower	452.000	452.000	manyears per 10e6 t ann cap.
non manual technical manpower	104.000	104.000	manyears per 10e6 t ann cap.
foremen	84.000	84.000	manyears per 10e6 t ann cap.
engineers	20.000	20.000	manyears per 10e6 t ann cap.
non manual non technical manpower	12.000	12.000	manyears per 10e6 t ann cap.
total manpower	876.000	876.000	manyears per 10e6 t ann cap.
underground manpower	0.000	0.000	manyears per 10e6 t ann cap.
manpower in preparation plant	-1.000	-1.000	manyears per 10e6 t ann cap.
wood	-1.000	-1.000	m3 per 10e3 t ann capacity
field metals	-1.000	-1.000	t per 10e3 t ann capacity
concrete	-1.000	-1.000	m3 per 10e3 t ann capacity
cement	-1.000	-1.000	m3 per 10e3 t ann capacity
ferro concrete	-1.000	-1.000	m3 per 10e3 t ann capacity
soft roof materials	-1.000	-1.000	m3 per 10e3 t ann capacity
oil bitumen	-1.000	-1.000	t per 10e3 t ann capacity
bricks	-1.000	-1.000	m3 per 10e3 t ann capacity
glass	-1.000	-1.000	m2 per 10e3 t ann capacity
sand	-1.000	-1.000	m3 per 10e3 t ann capacity
ceramic plates	-1.000	-1.000	m3 per 10e3 t ann capacity
gravel stone	-1.000	-1.000	m3 per 10e3 t ann capacity
explosives	-1.000	-1.000	m3 per 10e3 t ann capacity
metals in buildings and equipment	-1.000	-1.000	t per 10e3 t ann capacity
waste rock mined & stored during constr.	9600.000	9600.000	m3 per 10e3 t ann capacity
waste rock mined & stored during constr.	18720.000	18720.000	t per 10e3 t ann capacity
total working weight of equipment	4.997	4.997	t per 10e3 t ann capacity
specific capital investment	-1.000	-1.000	us \$ 1975 per t ann capacity
investment during construction	26.641	26.641	us \$ 1975 per t ann capacity
infrastructure investment	1.675	1.675	us \$ 1975 per t ann capacity
indirect investment incl interests	1.066	1.066	us \$ 1975 per t ann capacity
direct investment total	23.900	23.900	us \$ 1975 per t ann capacity
mine buildings a o facilities	10.999	10.999	us \$ 1975 per t ann capacity
mine equipment	12.902	12.902	us \$ 1975 per t ann capacity
preparation facility	-1.000	-1.000	us \$ 1975 per t ann capacity
mine opening and development	9.629	9.629	us \$ 1975 per t ann capacity
mine surface facilities	-1.000	-1.000	us \$ 1975 per t ann capacity

specific wellmm requirements for operation

perrom = specific wellmm requirements per metric ton run of mine coal
 persale = specific wellmm requirements per metric ton saleable coal

note : if no coal preparation perrom = persale

name	perrom	persale	unit
water inflow during operation	0.252	0.252	m3 per t produced
additional water supply	0.000	0.000	m3 per t produced
water used by the mine (total)	0.000	0.000	m3 per t produced
water used by the preparation	0.000	0.000	m3 per t ann output
water pumped out total	0.252	0.252	m3 per t produced
water inflow per year	315360.000	315360.000	m3 per year
electricity	21.356	21.356	kwh per t produced
motor fuel	0.534	0.534	liters per t produced
process heat fuel	-1.000	-1.000	lce per 10e3 t produced
land undermined (underground mining)	0.000	0.000	m2 per t ann output
land disturbed by mining	0.057	0.057	m2 per t ann output
height of topsoil	0.300	0.300	meters
land area reclaimed	0.057	0.057	m2 per t of output
reclamation cost	30.000	30.000	us \$ 1975 per t produced
disturbance duration	-1.000	-1.000	years
land area disturbed over lifetime	-1.000	-1.000	km2
land area reclaimed over lifetime	-1.000	-1.000	km2
manual technical manpower	0.039	0.039	manshifts per t produced
workers with mining qualifications	-1.000	-1.000	manshifts per t produced
manual non technical manpower	0.016	0.016	manshifts per t produced
non manual technical manpower	0.007	0.006	manshifts per t produced
foremen	0.005	0.005	manshifts per t produced
engineers	0.001	0.001	manshifts per t produced
non manual non technical manpower	0.002	0.002	manshifts per t produced
total manpower	0.088	0.088	manshifts per t produced
underground manpower	0.000	0.000	manshifts per t produced
personnel of mine on books	318.000	318.000	men
manual technical manpower	156.000	156.000	manyears per 10e6 t produced
workers with mining qualifications	-1.000	-1.000	manyears per 10e6 t produced
non manual technical manpower	64.800	64.800	manyears per 10e6 t produced
foremen	25.600	25.600	manyears per 10e6 t produced
engineers	21.600	21.600	manyears per 10e6 t produced
non manual non technical manpower	4.000	4.000	manyears per 10e6 t produced
total manpower	8.000	8.000	manyears per 10e6 t produced
underground manpower	254.400	254.400	manyears per 10e6 t produced
auxiliary manp. of other companies	0.000	0.000	manyears per 10e6 t produced
labour productivity	21.600	21.600	manyears per 10e6 t produced
productivity: coalface	-1.000	-1.000	t per manshift
productivity: mine	0.056	0.056	t per manshift
productivity: mine complex	0.006	0.006	t per manshift
shift losses	-1.000	-1.000	manshifts per t produced
shift losses	20.000	20.000	percent
manpower in preparation plant	0.008	0.008	manshifts per t produced
manpower in preparation plant	33.600	33.600	manyears per 10e6 t produced
wood	0.000	0.000	m3 per t produced
explosives	-1.000	-1.000	kg per t produced
metal(supports wo hydraulic)	0.011	0.011	t per t produced

other metals	-1.000	t per t produced
other materials	-1.000	us \$ 1975 per t produced
total materials excl. fuel	-1.000	us \$ 1975 per t produced
solid waste to be disposed at surface	2.035	t per t produced
solid waste from the preparation plant	-1.000	t per t produced
solid waste used as stowing material	0.000	t per t produced
total operational costs of mining	-1.000	us \$ 1975 per t produced
wages and salaries	-1.000	us \$ 1975 per t produced
social costs	-1.000	us \$ 1975 per t produced
depreciation	-1.000	us \$ 1975 per t produced
other costs	-1.000	us \$ 1975 per t produced

A Description of the IAEA'S Uranium
Geology Information System

Linda Trocki and Maurice V. Hansen

International Atomic Energy Agency,
A-1011 Vienna, Austria

The International Atomic Energy Agency (IAEA) has acquired a large amount of geologic data on world uranium resources as a result of its diverse activities in this field. Four special consultants designed a computerized information system to store this large quantity of data. The resulting International Uranium Geology Information System (INTURGEO) reflects the IAEA's five-fold approach to uranium resource analysis, comprising: 1. The Regional Reference File, 2. The Exploration Activity File; 3. The Ore Deposit/Occurrence File, 4. The Ore Processing File (presently being developed), and, 5. The International Summary File. The system is serviced by a commercially available data management system. INTURGEO has been operational since February 1979, and contains approximately 350 records of an anticipated total of more than 1000 records.

I. INTRODUCTION AND BACKGROUND

Adequate world uranium resources are imperative to a stable energy supply for the future, making it a vital issue for government, industry and the public. Presently known uranium resources total approximately 2.2 million tonnes of uranium (OECD/IAEA 1977). More than 80% of these resources occur in only four countries: the USA, South Africa, Australia and Canada. Does this represent the naturally occurring distribution of uranium in the earth's crust? No, it is most probably a reflection of the great amount of data collected during extensive uranium exploration in these countries. As more data become known about presently unexplored but favourable areas estimated uranium resources will increase. As a result, areas in Africa, South America or Asia where little exploration has been done, may become important uranium producing areas in the future. This illustrates the need for systematic data collection and analysis, one of the main themes of this conference.

The International Atomic Energy Agency (IAEA) of the United Nations is committed to increase the world's knowledge of uranium as part of its goal "to accelerate and enlarge the contribution of atomic energy to peace, health and prosperity throughout the world". One of the main tasks of the IAEA is the dissemination of information through publication of the proceedings of meetings organized along specific subject lines. Within the framework of uranium resources, meetings have been held on ore processing, uranium exploration, uranium geology, evaluation of uranium resources and the evaluation and identification of uraniferous areas. Also, the IAEA administers technical assistance projects, funded by either the IAEA or the UN Development Programme, for developing countries. Collaboration with the Nuclear Energy Agency (part of the Organization for Economic Co-operation and Development) produces the biannual "Red Book" of Uranium Resources, Production and Demand. More recently, the IAEA participated with the Nuclear Energy Agency on the first phase of the International Uranium Resources Evaluation Project (IUREP) during which a large amount of data was amassed on uranium resources. Data were compiled on 185 countries covering general geography, geology in relation to potentially favourable uranium-bearing areas, past exploration, uranium occurrences and past production, present status of exploration and the potential for new discoveries.

As a result of its participation in uranium resource activities, the IAEA acquired a large collection of maps, technical papers and news clippings on a global scale. This large body of information mandated that we build a computer data base to store the essence of this information in a systematic fashion. No such data base on uranium resources was in existence. In addition to data storage, it was anticipated that the data base would also serve many other functions. The scope of the data base was required to cover more than a simple ore deposit file because our approach to world uranium resource assessment is five-fold:

1. Geologic study and comparison of regions favourable to uranium mineralization
2. Analysis of exploration results
3. Detailed description of individual deposits and occurrences
4. Description of individual ore processing plants
5. National statistics and policies toward developing uranium resources

To ensure compatibility with existing natural resource data bases, ease of use, and efficiency, four mathematical geologists involved with COGEODATA (the International Committee on Storage, Automatic Processing and Retrieval of Geologic Data) were consulted to design the data base. The resulting design included files for four of the five topics in our approach to uranium resource assessment: 1. regional geology; 2. exploration; 3. deposit descriptions; 4. national statistics. (The fifth file on ore processing plants is planned for the future.) We named the data base INTURGEO (INTERNATIONAL URANIUM GEOLOGY INFORMATION System).

II. DATA STORAGE SYSTEM

The data base was designed in April 1978 and was implemented by February 1979, requiring 38 person-weeks of work which included 15 weeks of data acquisition.

Data acquisition and entry and system demonstration are ongoing tasks. Another four weeks of software preparation is anticipated for writing update routines. As the system grows and we become more experienced with it, periodic changes involving software, data definition and form preparation will occur.

The data base is housed on discs of an IBM Model 3032 computer. Data is managed by ADABAS, a commercially developed data management system with the following features: 1. data definition language, 2. a retrieval capability utilizing inverted lists, 3. data manipulation capabilities, 4. a series of data base utility routines that enable the user to create, maintain and control the data base.

A file in ADABAS consists of data field definitions, data records, and inverted lists for descriptors (data items for which a search can easily be made). The types of fields and grouping of data permitted are: 1. Elementary Field: a field with a maximum of one value in each record, 2. Multiple Field: a field that may contain a variable number of values; 3. Group Field: a series of one or more contiguous fields that are considered as a group; and 4. Repeatable Group Field: a group field which

may occur more than once. ADABAS does not allow "nesting" of repeatable group fields, which makes hierarchical data associations difficult in some cases.

III. DESCRIPTION OF FILES

The files are defined on a geographical basis, each record describing a particular location, or reference area. In the Regional Reference File (RRF) a record covers a prescribed area, which can be political, geological, physiographic, or any other appropriate selection. In the Exploration Activity File (EAF), the reference area is the specific area covered by an individual survey. A record in the Deposit/Occurrence File (DOF) describes a specific deposit, occurrence or anomaly. The reference area of the International Summary File (ISF) is defined by national or international boundaries.

Data sets in the four files may intersect, and ADABAS allows for easy communication between the files. For example, the geology of the Colorado Plateau in the southwest United States may be the subject of a record in the RRF; a record or several records in the EAF could describe all of the exploration surveys performed over the Colorado Plateau; and records in the DOF would describe the individual deposits of the plateau. Connection to the ISF, in this case, would be minor because the Colorado Plateau comprises only a small, though important, area of the United States.

The main components of the files are shown in Figure 1. Five items occur in all files: 1. Record Identification Number, which is unique to each record in the file. This defines the record to which data in the file belong; 2. Centroid or nearest practical reference point stored as latitude and longitude; 3. Administrative Jurisdiction, stored as continent and country coded by number, and state and county, or other appropriate political subdivision; 4. Bibliographical References, as a repeatable group with separate data items for the author, year of publication, and the title and publication information; and 5. Recorder or Updater, a repeatable group with data items for the name of the compiler, the date and any comments the person wishes to make on the data. All weights and measures are entered in the data base in standard metric units. Amounts of uranium are entered as "tonnes uranium", not tonnes U_3O_8 .

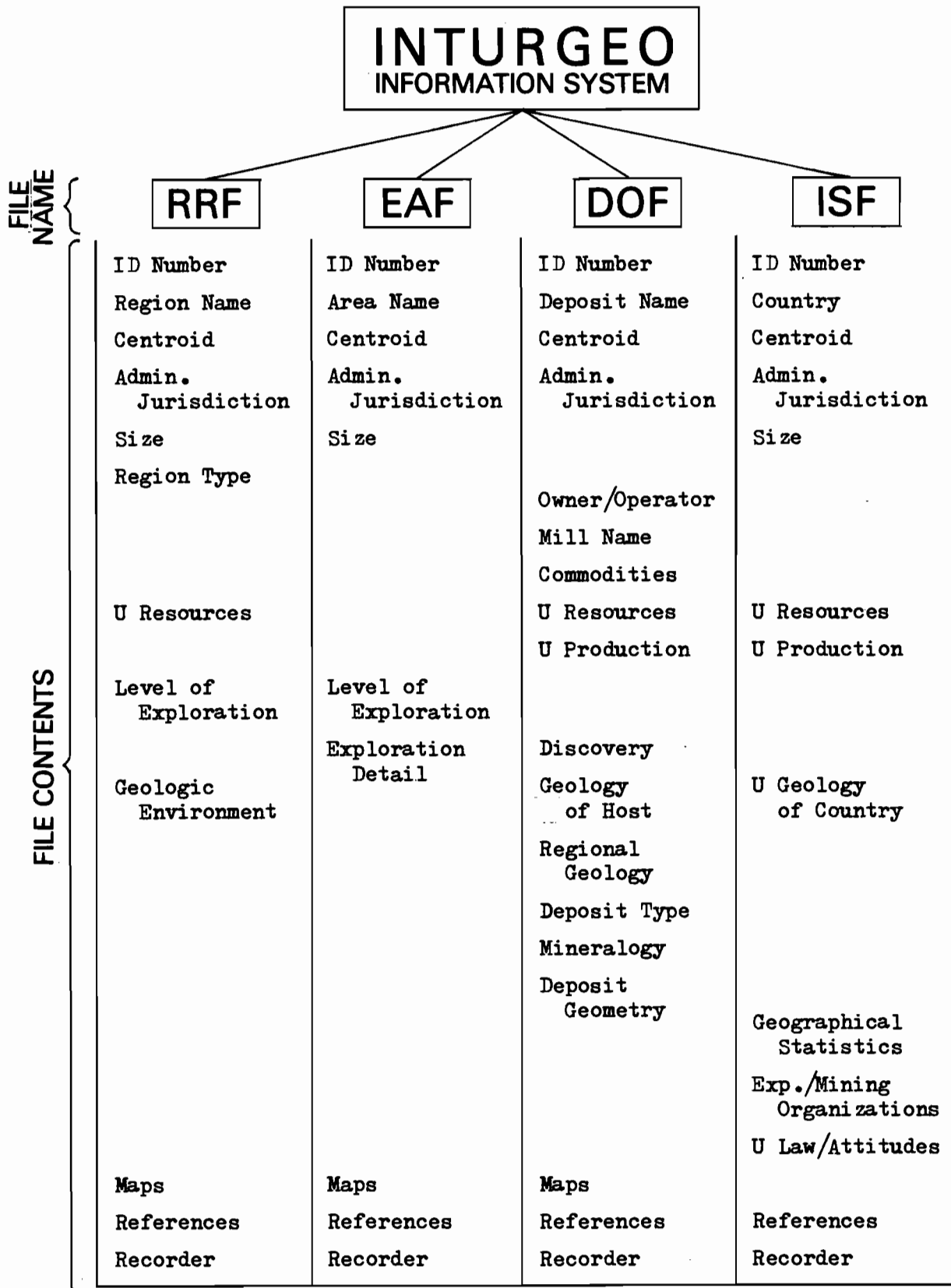

Figure 1. Contents of INTURGEO showing similarities of files, i.e., those items occurring on the same line have similar structures.

A. Regional Reference File (RRF)

The RRF systematically stores information on the geology of a region so that the characteristics favourable to uranium mineralization can be determined. Other pertinent data on the region also occur in the file.

The region is identified by a name, or duplicate names and a centroid location. The region type can be geologic, tectonic, political, etc. Size of the region is entered next.

Uranium statistics of the region are characterized by three repeatable groups of data. The first group contains the uranium deposit type, the number of deposits and the number of occurrences of that type in the region. The second group accommodates tonnes uranium produced from the region and production dates. The third group contains uranium resource data according to category of resource, amount of uranium, cost of recovery and year of estimate. An example of an entry in this field would be 1000 tonnes of "reasonably assured uranium resources" recoverable at 80 - 130 US \$/kg U in 1977.

The exploration of a region is described simply by past level of activity with encompassing dates, past exploration expenditure with dates and present level of activity.

The geologic environment of a region is described in terms of the areal percentages of each unit of a geological map. A group of data fields are repeated to describe each geologic unit of the map. The three most important elements of the group are the name of the unit, its areal percent and its geologic age coded by number. The numeric coding system is the same as that recommended by the Canada Centre for Geoscience Data (1978). Space is provided for multiple listings of lithologic type (with colour and modifier), depositional environment, structure, tectonic setting, igneous activity and elements enriched in the unit.

Maps of the region are catalogued in a repeatable group by type, scale and number of the type and scale available for the region.

B. Exploration Activity File (EAF)

The EAF characterizes the uranium exploration for a specific region, so that the uranium favourability of the region and need for further exploration can be assessed. The exploration region is identified by a name, any alternate names, as well as a centroid and size. The exploration level of the region is stored in the same way as in the RRF, i.e., groups for past exploration level and expenditure, and present level of exploration in the region. The main part of the record comprises a repeatable group describing how a survey was performed and the results. It contains fields for the survey operator, the joint operators or members of the entity performing the exploration, the date of the survey, the size of the survey region and the geographic coordinates of the centroid. The survey platform is specified as satellite, airplane, helicopter, ground or subsurface. Space is provided for a variable number of methods, number of samples and sample medium used with the platform indicated. An example of a ground survey entry would be "Geochemical, 1000 stream sediment samples". Comments on the survey techniques follow, such as size of the sampling grid, line spacing of an air survey, etc. The end of the repeatable group comprises fields for the success of the survey, indicated by the Number of Targets Identified, and Summary Results. Survey costs (1000's US \$) are also included. Maps available for the region are stored in the same manner as in the RRF.

C. Deposit/Occurrence File (DOF)

The DOF was designed to store geological data that characterize uranium ore deposits or occurrences so that deposits can be compared and classified. The CRIB file of the US Geological Survey [Information Systems Programs (1977)] and guidelines of the Canada Centre for Geoscience Data (1978) served as models for this file.

A specific deposit is identified by a name and alternate names, and a location. A field for the owner or operator follows. Mining status is indicated by classifying the property as an anomaly, occurrence, prospect, potential producer, producer or past producer. If the deposit has ever been mined, the mining method and ore processing plant is specified. The plant name will provide a link with an ore processing file being developed.

Resources statistics comprise five data groups. The first is repeatable and lists all commodities present, and their status (e.g. Au, byproduct). The next two repeatable groups define uranium production (amount of uranium produced with production dates) and production capacity (tonnes uranium per year with a date). A non-repeatable group describes the grade of the deposit in terms of cutoff, maximum and average percent uranium and date of estimate. Data on the uranium resources of the deposit are handled in the same way as the uranium resources of a region in the RRF: A repeatable group describing category (e.g. "reasonably assured") tonnes uranium, cost of recovery and date of estimate.

The discovery method for the deposit is described by the same repeatable group used in the EAF for the exploration details.

A large repeatable group describes the host and related rocks. A multiple field contains the geologic unit name and alternate names. In the case of multiple hosts, a field is provided for volume percent of the host. If the geologic unit being described is not the host, its relationship to the host is specified. The geologic age, or range of ages, is coded by number for easy sorting by age, as well as for easy file searches. The numeric codes are the same as those recommended by the Canada Centre for Geoscience Data (1978). A multiple field for lithology, with modifier and colour, describes the rock type. The organic content is specified as rich, moderate or poor. Multiple fields follow for depositional environment, structure, tectonic environment during deposition, post-depositional events with their age, alteration, and igneous activity. A comment field at the end of this repeatable group on host and related rocks allows for remarks by the recorder.

The next items in the file are multiple fields for major structures and the tectonic environment of the regional geology. Deposit type and subtype are chosen from a classification system used by the IUREP Steering Committee (Wright 1979). In addition, a deposit classification system is used that was recently produced for the US National Uranium Resource Evaluation programme (Bendix 1978). Other classification systems will also be incorporated to provide for international differences in ideas.

Mineralogy of the deposit is described in repeatable groups for age of mineralization (in millions of years), ore minerals and abundance (in volume percent), gangue minerals and qualitative abundance, and minor elements associated with mineralization and abundance (in ppm).

Deposit geometry is described by maxima of length, width and thickness, overburden thickness, and strike and dip of the ore body if applicable. Maps available for the deposit are listed in the same manner as in the RRF and EAF.

D. International Summary File (ISF)

The ISF summarizes uranium information on a country, or political region. This includes the country's uranium resources, and attitude toward uranium resource development.

A record in the ISF is identified by continent and country, coded by number. Size and centroid occur next. The repeatable group field for uranium resources of the country is the same structure as used in the RRF and DOF: Category, tonnes uranium, cost of recovery and date of estimate. Quantity of reserves are further classified by geologic type. Following the reserve classification, a repeatable group field describes annual uranium production.

The country's potential for the discovery of additional uranium resources, as determined by the IUREP is classified qualitatively on a relative scale. A verbal summary of the country's geology favourable to uranium mineralization follows.

Geographical statistics are described by group fields for population with date of census, capital city with population and date of census, and data on transportation characterized by total road, railroad and navigable river length. While this information may seem irrelevant for a large, developed nation, it is necessary information for mining concerns in some of the small developing countries. Average and maximum elevation, rainfall and temperature are reported also on a regional basis. A verbal description of geography follows these statistics.

A repeatable group field is provided for government organizations that control or are involved in uranium exploration or mining. The group comprises individual fields for organizational title and address. A similar repeatable group field contains all of the private companies active in uranium exploration or development in the country, with their addresses.

Laws regulating participation in uranium exploration or mining are described in three groups. The first states whether foreign investment is allowed. The second and third groups state who may conduct exploration and mining, i.e. the state only, the state jointly with private companies, the state and private companies independently or just private companies with the date of this information. Additional uranium law information is then briefly summarized in a comment field.

IV STATUS OF INTURGEO

The system is fully operating, although with a limited amount of data. As stated previously, the files were loaded in February and are currently being built. Information in the RRF and ISF covers fifteen developing countries. There are approximately 50 records in the EAF. Virginia Byers of the US Geological Survey, consultant to the IAEA during April, incorporated the data that she has collected over the last several years on the principal uranium deposits of the world (Byers 1978). As a result, the DOF now contains about 325 records. The records in the file are, however, oftentimes incomplete. We anticipate that INTURGEO will be approximately one million characters in size (more than 1000 records) covering world uranium geology, exploration, reserves and production. The consultants engaged

to carry out the International Uranium Evaluation Project, which starts again soon, will provide data for entry in the system and will require information from it that is at present only partially available. Further revision of the files will occur this month before the questionnaires are printed for distribution.

This project has been solely supported by IUREP, not by regular IAEA funding. But it will require a steady source of funding, such as contributions from Member States, to ensure stability and maintenance. Financial assistance could be used immediately for data coding and keypunching, and system development. We at present have a pledge from the USGS but more funding will be required. Besides financial support, the scientific support of Member States would be of great help in coding and verifying data on their country.

V. SUMMARY AND APPLICATIONS

Applications will be as diverse as the users. The first and most obvious application of INTURGEO is, simply, storage and retrieval of geologic data. Data searches, formerly requiring a week, can be accomplished in a few minutes at the computer terminal. Previously time consuming topics such as: "What is the total world uranium production capacity on a continent by continent basis?" or, "Which exploration method has been most successful in the discovery of major uranium deposits?" can be resolved in minutes. A resource inventory would be a straightforward application of the data base, once all of the data has been entered. ADABAS retrieval capabilities provide neatly-formatted tables suitable for inclusion in a publication in a matter of minutes. The dependence on bulky files in which material is often misplaced will be eliminated.

Worldwide dissemination of uranium resource information is an application of high priority in the IAEA. This is most readily accomplished by having a copy of the data base reside on each continent and by publication of the updated contents at appropriate intervals. The inexperienced geologist may then query the data base on regional geology, deposit descriptions, etc., depending on his specific needs. By having such information easily at hand, his lack of experience may be alleviated to a large extent.

INTURGEO will also provide a basis for intelligent resource appraisal. The combined data on deposits, regional geology, exploration and the political situation present a more complete picture of resources than the more commonly used resource file. Expansion of the data base may be considered to allow for a total systems analysis approach. The IAEA is also highly interested in testing ore deposit models with its data (Hansen et al. 1978). One example is "characteristic analysis", an interesting tool for resource analysis that not only compares the various characteristics of mineral deposits, but also quantifies the comparison (Botbol et al. 1977). Ore deposit modelling with our data could remove the subjective nature and some of the uncertainty inherent in resource estimation and provide a clearer view of world uranium supply.

In summary, the five-fold INTURGEO approach to world uranium resources data is unique and the possibility for applications are unlimited. With the support of its Member States, the IAEA will maintain the most complete uranium geology file in existence, available to participants for the cost of a time-sharing terminal and a telephone call.

VI. ACKNOWLEDGEMENTS

Work discussed in this paper was supported by funds from the International Uranium Resource Evaluation Project (IUREP). The authors wish to thank Richard McGammon, Donald Picklyk, Wolfgang Schnabel and Richard Sinding-Larsen of COGEO DATA for design of the files, and Katalin Goettler, John Russel and Sally Micka of the IAEA for computer programming assistance. Special thanks are due to James Cameron of the IAEA and IUREP Steering Committee for his support of the project.

REFERENCES

Bendix Field Engineering Corporation (1978) A preliminary classification of uranium deposits. GJBX-63(78). Grand Junction, Colorado : Bendix Field Engineering Corporation.

- Botbol, J.M., R. Sinding-Larsen, R.B. McCammon and G.B. Gött (1977)
Weighted characteristic analysis of spatially dependent mineral
deposit data. Journal of the International Association for Mathe-
matical Geology 9(3):309-312.
- Byers, V.P. (1978) Principal uranium deposits of the world. US Geological
Survey Open-File Report 78-1008.
- Canada Centre for Geoscience Data (1978) Computer-based files on mineral
deposits: Guidelines and recommended standards for data content.
Geological Survey of Canada Paper 78-26. Quebec Printing and Publish-
ing Supply and Services Canada
- Hansen, M.V., J.M. Botbol, O.R. Eckstrand, G. Gaál, M. Maignan, Th. Pantazis,
and R. Sinding-Larsen (1978) Workshop on deposit modeling. Journal for
the International Association for Mathematical Geology 10(5): 519-532
- Informations Systems Programs, University of Oklahoma, Office of Research
Administration (1977) The Mineral Resources Data Bank of the US
Geological Survey CRIB. University of Oklahoma
- OECD/IAEA (1977) Uranium Resources, Production and Demand, December 1977.
Paris: Organization for Economic Co-operation and Development Publi-
cations.
- Wright, R.J. (1979) Ore models and classifications - uranium. Society
of Mining Engineers of AIME. Preprint Number 79-29. Littleton,
Colorado: Society of Mining Engineers.

PART 5

MINERAL DATA BASES

Global Mineral Resource Data Bases and National
Mineral Resource Inventories

Allen L. Clark and Jennifer L. Cook

U.S. Geological Survey,
Reston, Virginia 22092, USA

Short, intermediate, and long-term adequacy of mineral resource supply is rapidly becoming of critical concern both to the developed and developing countries of the world. At the present time, although data exists and has been collected, global mineral resource data bases are inadequate to allow for an analysis of global mineral supply. The inadequacy of data is particularly striking in the case of (hypothetical and speculative) resource estimates critical to intermediate and long-range analysis, and is only slightly improved with respect to reserve estimates, initial to short-term analysis.

Mineral resource data base development is underway, on both a national and international basis; however, only a few can be considered global in coverage. National mineral resource data bases are being developed in: Argentina, Bolivia, Botswana-land, Brazil, Bulgaria, Canada, Columbia, Egypt, Finland, India, Israel, Japan, Mexico, Peru, Philippines, S. Africa, Thailand, and Turkey. Regional mineral resource data base compilations are being undertaken as part of the activities of the Regional Mineral Resource development centers of ESCAP (Economic and Social Commission for Asia and Pacific), ECA (Economic Commission of Africa), CCOP (Coordinating Committee on Offshore Prospecting).

Mineral resource data bases which are truly global, or proposed to be global in coverage are being compiled primarily by governmental agencies in France (Bureau of Research of Geology and Minerals), Federal Republic of Germany (Bundesanstalt für Geowissenschaften und Rohstoffe), Japan (Japanese Geological Survey), Canada (University of Manitoba), United States (U.S. Geological Survey, U.S. Bureau of Mines), Austria (International Atomic Energy Agency) and through various projects of the International Geologic Correlations Program (IGCP) of which the International Phosphate Data Base Program is the best example. To date none of these data bases have sufficient coverage, or are in a suitable form for retrieval and analysis, to be used effectively in short-term, intermediate or long-term supply analysis.

For the development of global mineral resource data bases to be truly effective, there is a growing need to (a) develop and

adapt a series of international guidelines for mineral resource data base construction, and (b) develop a means of coordinating data collection and dissemination to reduce needless duplication of effort. The programs of COGEO DATA, IGCP Project 98, and the Canada Center for Geoscience Data could be used to develop international guidelines for data base construction and content to meet the needs of supply models. The coordination of international mineral resource data collection and dissemination should be undertaken by an international institute for resource data coordination, either newly founded or part of an existing institute. The first activity of such an institute would be to compile an index of existing mineral resource data bases, their form and content, and then to coordinate international data collection to develop a Global Mineral Resource Data Base. A potential starting point for coordinating the development of such a file would be the 1052 major mines of the world.

INTRODUCTION

Short, intermediate and long-term adequacy of mineral commodities supply is rapidly emerging as a critical concern for both the developed and developing countries. This concern was caused by a large number of factors, particularly during the late 1960's and early 1970's, of which four were perhaps the most significant:

First was the publication of "Limits to Growth" (Meadows, D. et al, 1972) which for the first time clearly showed the interaction of natural resources, food, environment, population and technology and the limiting aspect of each factor on the other. Specifically, the analyses shown in "Limits to Growth" presented the problem of defining the limits of mineral and energy resources to ascertain if the long range assumption of resource availability were valid. An activity which requires a large amount of basic data.

Second was the overall emerging concern for the environment, with attendant environmental legislation, which had a pronounced impact on mineral and energy resource exploration, development and exploitation. Although the impact of environmental concerns had only a limited impact on the short term supply of minerals, it lead to a rather extensive re-evaluation of intermediate and long range areas of supply; an activity which requires a large volume of international reserve and resource data.

Third was the formation of the Oil Exporting and Producing Countries (OPEC) Cartel; an action which was a clear demonstration of the vulnerability of resource supply to monopoly control.

Fourth, the events of 1972-1974 in the oil industry resulted in two concerns, that in turn created a demand for more and better mineral resource

data. The first concern was that, using the OPEC cartel as a model, that similar cartels might be formed with respect to specific mineral commodities. Secondly, the economic dislocations caused by the increase in price of the world supply of petroleum resulted in a marked decrease in investment in the mineral industry. An action which could profoundly effect intermediate and long range supply of mineral resources.

As a result of these four factors, and numerous others of equal or less importance, there has been and continues to be a major international effort to increase the level of knowledge with respect to present and future mineral supply. Specifically, to determine the location, quality and quantity of individual mineral commodities on both a national and international basis.

In many countries there has been the implementation of a wide range of programs to develop mineral resource data bases and to develop the data required to support the data base activity. The purpose of this paper is to describe some of the more successful data base programs, to discuss their problems and applications and finally to propose some coordinated efforts to create international mineral resource data bases.

MAJOR NATIONAL AND INTERNATIONAL MINERAL RESOURCE DATA BASE ACTIVITY

Although many proposed or implemented mineral resource data bases (MRDB) are planned to be international in scope, there are few, if any, which actually achieve this goal. In general, existing MRDB's can be classified into three main categories:

- (a) Those that are anticipated to be global in coverage both with respect to geography and commodities. Such files may or may not be machine processable.
- (b) Those that are geographically global in coverage but are restricted

to defined subsets of commodities or to individual commodities. Such files may or may not be machine processable.

(c) Those that are not now anticipated to extend beyond national boundaries but may ultimately be expanded to types a or b above.

Regardless of the intent of existing MRDB's, at present none are sufficiently complete in terms of coverage or data to be considered useful in global mineral resource assessments. However, several MRDB are sufficiently complete to be used in commodity or regional specific studies. Among the most complete are the following:

Computerized Resource Data Base (CRIB) (Calkins, 1973) - The mineral resource data base of the U.S. Geological Survey which contains approximately 40,000 domestic and 6,000 international records on individual deposits or mineral occurrences.

The CRIB data file deals primarily with detailed geology, reserve, resource and production statistics and bibliographic references.

Minerals Availability System (MAS) (Kingston, 1977) - The mineral data base program of the U.S. Bureau of Mines which contains 137,425 domestic and 4,627 international records on individual producing mines. Although still incomplete, the MAS system is totally functional with respect to four commodities (copper, aluminium, chromium and tin) and partially complete with respect to ten other commodities. Ultimately, the program is designed to include 35 commodities.

Individual records provide detailed information on mineral properties and operations, environmental factors, land use data and reserves, resources and production.

Canadian Mineral Occurrence Index (CANMINDEX) (Picklyk et al, 1978) -

The mineral deposit data base program of the Canadian Geological Survey is presently composed of approximately 350 records, which constitute a test file, of mineral occurrences in the Bathurst area of New Brunswick, Canada. Present plans (Picklyk, et al, 1978) are to expand the CANMINDEX file to a total coverage of Canada.

The present form of the CANMINDEX file requires information in six categories, unique identifiers, location, geologic data, bibliography, remarks and cross references. The ultimate intent of the file is as a national inventory of mineral resources.

Circum-Pacific Mineral Deposit File - (Guild, P.A., personal communication, 1979) An international program of cooperation to gather both mineral and energy resource data of the Circum-Pacific region. The present file contains approximately 3,000 records with the major coverage being provided from the Southeast Asia areas.

Individual records are intended to provide primary input to the development of metallogenic maps of the Circum-Pacific area. Therefore, the data items are primarily geological, reserve, resource and production data which are highly aggregated.

MANIFILE (Laznika, P., 1975) - A thorough compilation on the major nonferrous metal mines and mineral deposit districts of the world. The present file is composed of approximately 4800 deposits and represents perhaps the most complete coverage of mineral resources data yet available in a single file.

The World Mineral Resource Data Base provides data on location, major and minor commodities produced, production and reserves. General geologic data are provided with respect to host rock and age of individual deposits.

Mineral Deposit Data Bank (MDDB) (Gabert, 1978, p. 429) - The mineral

resource data base of the Institute for Geoscience and Natural Resources (BGR) of the Republic of West Germany. The present system operates on a test file of approximately 2,000 forms (Glashoff, P., personal communication, 1976).

The MDDB is intended to serve as a global inventory data base with information on location, mining activities, primary and secondary minerals, reserves, production and general geology.

In addition to the data files already discussed there are numerous other major data collection efforts underway, on an international basis, within the individual Geological Surveys, Bureaus of Mines or private industry. In particular, the activities of the Geological Survey of Japan, the South African Bureau of Mines, the Bureau of Research of Geology and Mines (BRGM) of France and England all have active mineral resource data base activities. The majority of these efforts are directed toward the creation of manual archives. However, in every case programs are either planned or underway to computerize the files.

These files are of importance in that they not only contain the normal information on mineral deposits but also contain a large amount of associated data on environmental, political and development factors; data elements that are of particular value in global resource modeling efforts. Unfortunately, unlike these manual archives, the majority of MRDB's do not contain these ancillary data elements. A notable exception to this tendency is the MAS system of the U.S. Bureau of Mines which pays particular attention to environmental and developmental factors.

NATIONAL MINERAL RESOURCE INVENTORY PROGRAMS

There is a world wide recognition of the need for each nation to have

an inventory of its mineral resource endowment. The value and uses of national inventories (Clark, A., 1977 and Gabert, G., 1978) are:

1. The national mineral resource inventory is the starting point for mineral resource appraisal and mineral based economic development.
2. Provides a basis of quantitative resource estimation, for defining mineral exploration potential and for mineral resource supply analysis.
3. Provides basic inputs to land use development and national mineral policy.
4. Provides a basis for regional metallogenic studies involving integrated mineral commodity and regional geological studies.
5. Finally, by combining the mineral resource inventory with regional scientific data and the application of an appropriate resource assessment methodology (Cargill and Clark, 1977, 1978), the location, quantity and quality of undiscovered resources can be predicted and areas of mineral potential delineated.

Because of the above factors a large number of national mineral resource inventory programs are presently underway or have been completed. Among the most successful are the following:

Bolivia - An inventory of approximately 8,000 small mines (Clark, A. and Cook, J., 1979) was undertaken and completed in Bolivia from 1976 to 1978. As a direct outgrowth of this program the Fondo Nacional de Exploracion Minera (FONDO) was founded and U.S.\$25 million has been committed to the small mining sector in Bolivia. The existing inventory is being updated to include data on the approximately 250 medium and large scale mines in Bolivia. When completed in 1980 the inventory will represent coverage of all the major mineral occurrences in Bolivia.

In addition to data on the mineral deposits the inventory includes data

on transportation, power availability, regional demography and development potential. At present, the Bolivian inventory is the most complete and comprehensive study that has been done on a national basis.

Mexico - The mineral resource inventory of Mexico represents one of the largest inventory efforts presently underway anywhere in the world. At present data have been compiled on approximately 30,000 mineral occurrences (Lee-Moreno, Personal Communication, 1978) and the data file is expected to exceed 100,000 entries when completed.

The mineral inventory of Mexico closely follows the format for data collection utilized in the Bolivia inventory and by the U.S. Geological Survey CRIB system. This adoption allows the resultant file to be used both for geologic analyses and for mineral resource exploration, development, and resource development.

Mineral resource inventories of Bolivia and Mexico are perhaps the best examples of broad based mineral resource inventory programs and serve as models for other national programs. However, both programs require large amounts of capital and manpower and a comprehensive information base to build upon, factors that limit this adoption in many developed and developing countries. There are nevertheless several other national inventory programs that are underway to support a wide range of national needs. Representative of these programs are:

Colombia - A national mineral inventory program (Rosas, H. et al, 1980) has been developed and implemented for Colombia which attempts to integrate a wide range of geoscientific data with the mineral inventory. Specifically, the program is being developed in conjunction with the development of a digital geographic file, for the plotting and analysis of mineral data, and data files on geochemistry, geophysics and basic field geology.

The primary purpose of the Colombia mineral inventory activity is to support exploration and development of mineral resources. At present data are compiled on two main areas and the program is expanding to acquire a total national coverage by 1985.

Finland - In 1973 a project was initiated to create a mineral resource inventory of Northern Finland (Gaal, G., et al, 1977) which has now been expanded to include approximately 1,000 mineral deposits which are significant economically in terms of mineral exploration and geologic research.

The main objective of the file is to supply necessary data for deposit modeling and resource assessments of the mineral potential of Finland. The inventory is of particular interest as it is within a data-rich developed nation, unlike the previous examples, and serves to demonstrate the wide range of uses for national mineral resource inventories.

Additional national mineral resource inventory programs are presently underway in : Japan, Korea, Peru, Turkey, Kenya, Cyprus, Venezuela, Egypt, Indonesia, Malaysia, Israel and Newfoundland, Canada, all of which are similar to, or represent combinations of the programs described above.

All of these programs, and many soon to be initiated, are providing a wealth of valuable data on the worlds present and potential sources of mineral resources.

PROBLEMS OF MINERAL RESOURCE DATA

Although present global mineral resource data base programs and national mineral resource inventory programs are providing a large amount of data, potentially of great use in global mineral resource modeling activity, there are also a large number of problems associated with their use. Among the most serious of these problems are the following:

First, it is generally accepted that mineral resource data bases should

be developed and constructed by geologists and mining engineers. This is at one and the same time both the greatest strengths of MRDB's and one of their greatest weaknesses for use in global resource modeling. Because MRDB's are developed and constructed by geologists and mining engineers, the resultant data has a high level of accuracy and credibility but are also very narrow with respect to the subject areas covered. Therefore, MRDB's rarely contain critical data in associated fields such as economics, engineering, productive capacity, regional demography, etc. This lack of ancillary data limits the use of MRDB's and national inventories in global resource models which deal with integrated systems of food, population, economics and environmental impact.

Second, is the lack of comparable reserve and resource estimates, in many cases the lack of such estimates in any form, between MRDB's. The lack of standard estimation methodologies makes it difficult, if not impossible, to develop aggregated estimates of global reserves and resources. In particular, the majority of resource estimates tend to be independent of economics and reserve estimates, which are defined by economics and are not usually given with the economic assumptions upon which the reserve estimates were made. These factors preclude the use of the reserve and resource estimates, either in an aggregated or disaggregated form, in global mineral resource supply models.

Third, there is an overall lack of common objectives with respect to the use of MRDB's and national resource inventory programs. The lack of common objectives result in incomplete coverage of many data areas and an omission of many others in most activities. These problems, when coupled with the two mentioned previously, makes it virtually impossible to develop

a global mineral resource data base which can be used to support a wide variety of applications.

Although the three major problems discussed are potentially resolvable with the validation of data and the capture of additional data such efforts would be both costly and time consuming. It is perhaps more advisable to recommend a program of international resource data collection which will insure that in the future such problems are minimized and that future programs will acquire the needed data. With sufficient time and effort, it can, therefore, be hoped that the deficiencies of existing MRDB's and national resource inventories can be overcome.

1052 DEPOSIT FILE

Because of the great need both on a national and international basis, for mineral resource data that can serve as basic inputs to global mineral resource models, it is critical to undertake an international program to compile such data. Clearly, such a program cannot be all inclusive and must have limited objectives, at least at the start, if it is to be accomplished. Given this need for global mineral resource data and the restriction of limited scope and objectives the authors propose an international program be undertaken to gather critical resource data on the 1052 major mines of the world as defined by Mining Magazine (1978). These 1052 mines represent 90 percent of all mineral production (excluding coal and mineral production from the Eastern Bloc Nations). As such, they are the primary determinants, with respect to the short and intermediate supply of mineral resources. Data compiled on these mines would provide a major input into existing global models and expansion of the file would ultimately provide the basic inputs for long range supply analysis.

To accomplish the development of the "1052 DEPOSIT FILE" the authors

are undertaking the following activities:

First, with the support of the East-West Center, the International Institute for Applied Systems Analysis (IIASA) and the U.S. Geological Survey, the authors are developing a detailed data capture format and standards for data reporting.

Secondly, a special task force is being developed, composed of individuals of the sponsoring agencies and individuals from various geologic agencies, which will be responsible for regional data collection and compilation activities.

The primary objective of the "1052 DEPOSIT FILE" activity will be to provide standardized data, on a broad spectrum of areas, with respect to the major suppliers of mineral resources at the present time. The 1052 DEPOSIT FILE will be publicly available and provisions are being made for access both by machine and through hard copy methods.

CONCLUSIONS AND RECOMMENDATIONS

Although it is universally recognized that there is a critical need for more and better mineral resource data and the MRDB programs and national mineral resource inventory programs are being implemented, the effort is poorly coordinated, rarely international in scope and data are difficult to obtain. It is therefore imperative that we begin immediately to provide the mineral resource data so badly needed.

Global mineral resource analyses and assessments are no better than the data upon which they are based and at present those data are inadequate. The challenge for both the global resource models and the resource analysis is therefore to develop a truly international mineral resource data base. Development of the 1052 DEPOSIT FILE is a recommended first step in providing

both the standards, which will insure data comparability and the basic data that are needed, and most important - a mineral resource data base available to all.

REFERENCES

- Calkins, J.A., Kays, O., and Keefer, E.K., 1973, CRIB - The mineral resources data bank of the US Geological Survey, U.S. Geol. Survey Circ. 681, 39p.
- Cargill, S.M., and Clark, A.L., eds., 1977, "Standards for Computer Applications to Resource Assessments - Loen Conference, Jour. of the International Association for Mathematical Geology, Vol. 9, No. 3, 337 p.
- Cargill, S.M. and Clark, A.L., ed., 1978, "Standards for Computer Applications to Resource Assessments - Taita Hills Conference, Journal of the Inter. Assoc. for Mathematical Geology, Vol. 10, No. 5, 642 p.
- Clark, A.L., 1977, Guidelines for International Data Collection and resource Assessments and analyses in Standards for Computer Applications to Resource Assessments - Loen Conference, Jour. of the Inter. Assoc. for Mathematical Geology, Vol. 9, No. 3, p 221-233.
- Clark, A.L., and Cook, J.L., (In Press) Small Mines as precursors of major deposits in UNITAR Conference on Future and Potential of Small Mines, Meyer, R.F., ed. UNITAR Special Publication.
- Gaal, G., Tontti, M., Autio, H., and Lehtonen, M., 1977, Establishing a national ore data file in Finland, in Standars for Computer Applications in Resource Studies, Cargill, S.M. and Clark, A.L., eds, Jour. of Inter. Assoc. of Mathematical Geology, Vol. 9, No. 3. p 319-326.
- Gabert, G., 1978, The importance of mineral and energy inventories, in Standards for Computer Applications in Resource Studies, Cargill, S.M., and Clark, A.L., eds, Jour. of Inter. Assoc. of Mathematical Geology, Vol. 10, No. 5, p 425-432.
- Kingston, G., 1977, Reserve classification of identified nonfuel mineral resources by the Bureau of Mines Minerals Availability System in Standards for Computer Applications in Resource Studies, Cargill, S.M. and Clark, A.L., eds., Jour. of Inter. Assoc. of Mathematical Geology, Vol. 9, No. 3, p 273-279.
- Laznika, P., MANIFILE: The University of Manitoba Computer-based file of the worlds nonferrous metallic deposits. Canada Geologic Survey Paper 75-20.
- Meadows, D., et al., 1972, Limits to Growth: A report for the Club of Romes Project on the Predicament of Mankind, Potomac Associates Book, Universe Press, New York, pp 205.
- Picklyk, D.D., Rose, D.G. and Laramee, R.M., 1978, Canadian mineral occurrence index (CANMINDEX) of the Geological Survey of Canada, Can. Geol. Survey Paper 78-8 29p.
- Rosas, H., Cook, J.L., Clark, A.L., Ellsworth, T. and Duque-Caro, H., 1980, Development of a Mineral Deposit Inventory: Resource Data System for Colombia, Ixtapa Conference on Computer Applications to Resource

Assessment, in Standards for Computer Applications to Resource Assessment, Cargill, S.M. and Clark, A.L., eds., Jour. of International Assoc. of Mathematical Geology.

The Production and Consumption of Non-Fuel Minerals
to the Year 2000:
Implementing a Global Input-Output Model and Data Base

S. Nasar O'Brien

Institute for Economic Analysis,
New York University,
251 Mercer Street,
New York, N.Y. 10012, USA

This paper demonstrates the use of a fifteen-region input-output model of the world economy, described in The Future of the World Economy by Leontief, Carter and Petri, to study a variety of critical questions regarding the future production and consumption of non-fuel minerals. The paper reports, taking as examples copper, nickel and phosphate rock, work in progress undertaken by the Institute for Economic Analysis at New York University and sponsored by the National Science Foundation and the Bureau of Mines. In this new research effort, a data base comprising an expansion of the 85-sector input-output table for the United States to include mining processing and consumption of twenty-six non-fuel minerals (and also the new input-output table for Canada) will be placed within the framework of the existing model of the world economy; the U.S. and Canada matrices will be projected forward to 1980, 1990 and 2000 and, in each period, will be linked to other regions through trade.

By considering copper, nickel and phosphate rock, the paper shows in what ways the world model data base is being expanded and improved, new methods for using data to represent technological change, capital requirements, pollution and, finally, the design of scenarios which permit quantitative analysis of the effects on outputs of minerals sectors resulting in changes elsewhere in the economic system and environment, as well as analysis of effects on the entire system of changes in the input-output structure of minerals producing and consuming sectors. For each of the three materials, a different critical question is selected as a focus: capital requirements and the contribution of recycling for copper, substitution between nickel and other alloying elements for steel, and alternative technologies in the production of phosphate rock.

Each step of data base construction and methodology will be discussed. The paper will focus chiefly on the data base and uses of the data but will also display some of the results of work to date.

STATEMENT OF PURPOSE

The demand for comprehensive, internally consistent, and yet detailed data bases, concerning physical as well as economic aspects of minerals production and consumption, far exceeds available supply. Events--from the "energy crisis" to Three Mile Island-- prove that economic policy cannot be intelligently framed without considering technological, natural resource, or environmental constraints. While advances in designing large, disaggregated models to forecast long-term mineral supply and demand have been little short of dazzling, the shortage of appropriately processed data still constitutes a profound limitation of the possible scope and reliability of analyses.

The data base constructed for the United Nations model of the world economy (Leontief, Carter and Petri 1977) is both a valuable contribution and a useful starting point. Besides giving an abbreviated overview of the world model data base, this paper shows how the data base is being expanded and improved to permit the analysis of the future production and consumption of twenty-six non-fuel minerals to the year 2000. To illustrate the contents of the extended data base, the steps in its construction, and some of the uses of the data, examples involving copper are given. The work described here is being done at the Institute for Economic Analysis by Professor Wassily Leontief and a team of input-output economists. The study of non-fuel minerals, in particular, is being supported by the National Science Foundation, the Bureau of Mines, and New York University.

THE WORLD MODEL AND DATA BASE

The input-output model depicts the world economy, which is divided into fifteen regions, in 1970, and (through the use of hypothetical pictures) in 1980, 1990, and 2000. At the start of each decade, the economy of each region is represented by a set of 175 linear equations, in 276 variables, which describe the production and consumption of particular goods and services, in particular, natural resources, including iron, bauxite, copper, lead, zinc and nickel.

The global model, completed in 1977, was originally used to study the inter-relationship, and possible conflict, between goals for economic development and policies for reducing environmental degradation and conserving natural resources. However, the model proved equally useful for examining the process of structural change in the world economy and permits in-depth analysis of the position of natural resources. Because of the tremendous detail it incorporates, without, however, requiring great specification of behavioral assumptions, the model is extremely data dependent.

The data base consists of four main parts. (1) Production and interindustry consumption are described by a 45-sector matrix of input-output coefficients which trace the physical and dollar flows of mining, agricultural, manufacturing and service outputs. The 1970 coefficients--based on actual interindustry transactions in that year--are projected to 1980, 1990 and 2000 to reflect major expected developments in materials substitution, technological change, recycling and resource depletion. Pollution emissions are described by coefficients which specify the amount of each of eight pollutants generated per unit of output by each producing sector. Emissions are partially abated using five different abatement techniques which are treated as a special kind of industrial activity. (2) The matrix of final demand coefficients shows what proportion of total regional income is delivered by each producing sector and how the bill of goods and services is allocated

among final uses, including personal consumption, investment, government spending, and exports. (3) The data base also describes certain stocks. Alternative estimates of mineral endowments, for instance, are specified for each mineral and each region. Capital stocks required to produce each period's total output are described by a set of capital-to-output ratios for four types of capital stocks. (4) Finally, international trade--which links together the fifteen regions of the world--is represented by two sets of coefficients. Export shares specify what proportion of the world trade pool for each of the forty traded commodities is contributed by each region in each decade. Import-to-output coefficients show the requirements for imports for every producing sector and final demand category.

The data are used in computer simulations of alternative scenarios. Scenarios can be specified by fixing exogenously the values of some combination of the number of variables which exceed the number of equations in the model. By using exogenous estimates of future world income levels, for instance, the input and output requirements for each sector, deliveries to final demand, and cumulative resource use can be computed.

EXPANDING AND IMPROVING THE DATA BASE

As part of the study of non-fuel minerals, two major changes in the data base have been initiated. The United States is being introduced as a separate region (previously, it was part of North America-High Income) and the number of non-fuel minerals represented are being increased to twenty-six. These include iron and ferroalloys (iron, chromium, manganese, molybdenum, nickel, tin and tungsten), non-ferrous metals (copper, aluminium, lead, zinc, mercury, vanadium, titanium, magnesium, platinum, gold, and silver), and chemical and fertilizer minerals (silicon, flourspar, potash, soda ash, borates, phosphate rock, sulfur and chlorine). A new 200-sector inter-industry matrix of input-output coefficients is being constructed. It is based upon

an augmented and specially tailored 1972, commodity-by-commodity input-output table for the United States (Bureau of Economic Analysis 1979). In the new sectoral classification scheme, the 85 sectors of the official table are being disaggregated by mineral, and, where appropriate, by process, to show extraction, primary and secondary smelting and refining (or chemical processing), fabrication, and recycling of scrap.

As is true for any data base which concerns input-output structure and structural change, classification is crucial. As Anne Carter points out, "Industrial classification is the lens through which all change is observed and measured. Since we cannot see at all without the lens, we cannot say where it "distorts" the "true picture" (Carter 1970). In this case, the finely defined commodities and processes permit examination of technologies hitherto not visible, the position of small but strategic materials, and the easier tracing of changes in one sector to specific developments in another. On the other hand, the requirements for data and for processing of data increase dramatically. In particular, the task of projection becomes more difficult and requires greater care, since relative price changes, substitution, and by-products are likely, among other things, to have a greater impact on narrowly defined sectors than on large aggregates.

Using Process and Cost Analyses to Derive Input-Output Coefficients

Demand for minerals is derived from the demand for products which require minerals for their production. Changes in the demand for minerals result from technological changes in extraction and processing, substitution between materials as a result of relative price changes, and technological changes in the sectors which consume minerals. The matrix of input-output coefficients permits the tracing of demand for final goods and services to demands for minerals. Input-output coefficients in official tables are always calculated by observing actual transactions between different sectors in a particular year, balancing all purchases of inputs with

sales of outputs, and dividing the amount of each sector's inputs by the sector's output. Each column vector of the matrix, therefore, is a sort of "cooking recipe" and represents, if only implicitly, the technology of production. The expansion of the 1972 input-output table for the United States involves the disaggregation of those sectors pertaining to minerals. Sector Six, "Nonferrous Metal Ores Mining," for example, will be split into copper mining, lead and zinc mining, bauxite mining, and so on. Disaggregation of a row in the matrix requires information regarding the consumption of, say, copper ore, by each of the 200 sectors as well as final demand. Consumption data are generally available from the Bureau of Mines or the Bureau of Census, in either physical or dollar amounts, but not usually at the required level of detail. They must, therefore, be augmented by special studies (often produced for critical or strategic materials) and conjecture. Derivation of columns of input-output coefficients is more difficult and subject to even greater uncertainty, a reason why this step is often avoided even in input-output analyses of minerals. Since little or no statistical information exists for interindustry transactions at this level of commodity detail, it is necessary to rely almost entirely on "engineering" information.

Until very recently, the only sources of input information, about most of the twenty-six minerals included in the study, were relatively esoteric (engineering texts and articles) or difficult of access (producers). In the last few years, however, a large number of process analyses and cost studies pertaining to minerals extraction, processing and recycling activities have been published, stimulated chiefly by government and industry concern about pollution emissions and abatement costs, energy consumption, and raw materials shortages (Arthur D. Little 1976, Battelle Columbus Laboratories, 1975, Kusick and Kenehan 1978).

For example, one study provides detailed data on the dollar costs of all inputs required per ton of copper, smelted by conventional techniques in a facility

with an annual capacity of 100,000 tons of copper (Arthur D. Little, Inc. 1976). Costs are shown separately for materials (including silica flux, limestone, fuel oil, natural gas, electricity, water, refractories and maintenance materials, labor (for production and maintenance workers, and supervisors), and capital and taxes (local taxes, insurance, depreciation and capital recovery). In this particular study, emissions of water and air pollutants and solid wastes are reported per ton of output. Abatement costs are also calculated for each type of pollutant per ton of copper produced.

Deriving input-output coefficients from cost data is fairly straightforward. Each input is assigned to the appropriate producing sector or value-added category (e.g., limestone and silica to Stone and Clay Mining and Quarrying, fuel oil to Petroleum Refining and Related Industries, electricity to Electric, Gas and Sanitary Services, etc.). By convention, inputs are shown as being purchased directly from manufacturers rather than from the wholesale and retail trade sector. Therefore, a part of the purchaser's value of each input is allocated (based on trade and transportation "margins" estimated by the Bureau of Economic Analysis) to Wholesale and Retail Trade, and Transportation and Warehousing. The resulting vector of input-output coefficients is valued in producers' prices and, in this particular case, needs only to be deflated from 1976 to 1972 dollars.

The usefulness of engineering data for disaggregating input-output sectors is conceptual as well as practical. In comparison to coefficients derived from transactions data, coefficients derived from engineering data are explicit representations of the technology used to produce a particular commodity. Also, of course, engineering data permit inclusion in the matrix of relatively finely defined commodities for which little statistical data exist or for commodities, such as pollution emissions, for which the concept of transactions does not apply. However, cost studies as comprehensive as the one cited are hardly typical. Process analyses, which are now

available for most minerals, describe only materials inputs (which, in the case of copper smelting, equal only one-fourth of all inputs) and do so in physical units, so that the researcher must hunt for prices to convert physical quantities into values and must also estimate other inputs from information about other commodities and processes judged to be "similar." Further, even when a complete set of input-output coefficients can be derived, care must be taken that the process which has been described is, in fact, typical of the way the particular commodity is produced. A vector of input-output coefficients is usually interpreted as a weighted average of processes--some efficient, some not--actually employed at one point in time.

Using Engineering Data to Project Input-Output Coefficients

Projections to 1980, 1990 and 2000 from 1972 base-year coefficients attempt to take into account major, expected changes in coefficients which may result from substitution and technological change. Cost and process analyses which describe alternative, as well as conventional, processes can provide the necessary information for one simple technique for projecting column vectors of input-output coefficients. This technique is valid to the extent that the following two suppositions hold in a particular case: First, technologies which could replace current techniques over the next two decades are already being used at least experimentally. Second, the superior technology (among several alternatives), from an economic point of view, is the one which yields the lowest future cost for the commodity in question. In an input-output framework, this is the equivalent of yielding the lowest relative price. To compare relative prices in future decades, each alternative technology is inserted into the whole matrix of coefficients for which most of the other columns have already been projected forward. The inter-industry portion of the matrix is inverted and, based on an exogenous of value added, the dual system of process is solved for each alternative technology. The one which results in the lowest relative price is chosen for the projection.

Information regarding alternative technologies is naturally even more scarce than information regarding current techniques. However, in the study of copper smelting already cited, complete descriptions are given of four alternative techniques developed and used experimentally in Japan and Finland. The relevance and potential usefulness of the descriptions becomes apparent when it is pointed out that the new techniques came onstream after the increase in world energy prices and after the imposition of stringent restrictions on sulfur dioxide emissions and other pollutants, since energy and pollution abatement costs will probably continue to be major determinants of technology.

Mineral Reserves and Resources

The world supply of any mineral is a function of the availability of mineral reserves and resources, by-product production, recycling and the costs of extracting and processing ores. Since resources which have already been identified will be expanded by new discoveries, estimates of total stocks of minerals are highly uncertain. The original world model data base therefore includes alternative estimates, conservative and optimistic, of endowments of each mineral available in each region. The conservative estimates of identified resources are those of the Bureau of Mines (Bureau of Mines 1979) while optimistic estimates are based on additional resources classified as hypothetical and speculative by the United States Geological Survey (United States Geological Survey 1973). The latter do not include undersea deposits which, for technical, economic and legal reasons, may not be mined commercially before the year 2000. Alternative estimates of the twenty non-fuel minerals which are being added to the data base are being compiled from the same sources.

As higher grade ores are exhausted, requirements per unit of output for all inputs, including capital, tend to increase, although this tendency may be offset by improvements in productivity and methods of extraction and recovery. In copper

mining and processing, for example, the price of refined copper has remained nearly constant in real terms from 1910, when the average grade of ore mined in the United States was almost two percent copper, to 1977 when the grade had fallen to 0.5% (Bureau of Mines 1979). In this case, significant scale economies and improvements in capital equipment were particularly important. Extraction costs, related to resource estimates, influence not only the relative prices of minerals, but also of products which incorporate minerals, directly or indirectly. Continuing the approach employed for the world model, "step-cost" functions, which indicate how much of the various mineral reserves are likely to be available in each region, at three levels of extraction costs, will be constructed on the basis of resource estimates. Projections of input and capital coefficients will be scaled up according to the step-cost functions and cumulative resource use in each region. Available resources also help determine the future export-shares of each region for minerals. In addition they influence the expected rate of substitution between materials, as well as setting upper limits on the use of particular minerals.

By-Product Production

In special cases, the supply of a particular mineral may be a function of the output of another mineral. For example, by-product production of sulfur and sulfuric acid from smelting of sulfide ores (e.g., copper and zinc), petroleum refining, and desulfurization of natural gas and coal is expected to eliminate the domestic sulfur ore mining industry in the United States over the next few decades. As fluorspar deposits are depleted (possibly by the year 2000), by-product fluosilic acid from phosphate rock will reduce the need for recovery of fluorine from ores. Vanadium is currently recovered mainly as a by-product of uranium and phosphate rock mining and processing and may, in the future, be recovered largely from shales and oil (Bureau of Mines (1975)). By-products can be thought of analogously to pollution emissions. By-product coefficients which specify the amount of the by-product

produced per unit of output of another mineral, can be treated as negative entries in the input-output coefficients matrix. The amount of the by-product mineral which is demanded of the industry which produces the mineral as its primary output (e.g., sulfur ore mining, vanadium mining, fluorspar mining) is treated as a residual of total demand minus by-product production. It follows, of course, in the framework of input-output methodology, that if by-product production satisfies the entire demand for the mineral in question, the primary industry simply vanishes. In the extension of the data base, by-product coefficients are being estimated for all commodities for which by-product production is currently a major source of supply.

Recycling

The supply of any mineral which must be produced by sectors engaged in extraction to meet the total demand is reduced by the amount of that mineral which is recycled from scrap. Of the twenty-six minerals included in the current study, fifteen are recycled in the United States. These are aluminum, chromium, copper, gold, iron and steel, lead, magnesium, mercury, nickel, platinum, silver, tin, titanium, tungsten and zinc (Bureau of Mines 1979). In the original data base, recycling was treated by scaling down input requirements for minerals to reflect recycling which was expected to reach maximum recovery levels by the year 2000. In the new study, however, for selected minerals, recycling would be treated explicitly to show scrap generation, on the one hand, and secondary recovery (treated as any other productive sector) on the other. The combination of information regarding recycling technologies with data on related pollution emissions and capital requirements, would permit the analysis of the effects of recycling on the supply and price of metals, on the rate of depletion of natural resources, and on savings in processing, energy, capital and abatement costs. It would also allow preparation of forecasts of the supply and demand for recycled materials.

New scrap is a by-product of smelting and refining, and also of manufacturing

operations and can therefore be treated in the same way as other by-products. Old scrap is a function of past production of consumer durables and capital equipment which, depending on product lives, are added to a stock of old scrap (analogous to ore resources) which can be tapped when needed. Progressively higher costs for collection, transportation and processing are incurred as recovery from old scrap is intensified.

As concern over energy consumption, pollution, and possible materials shortages has grown, detailed process analyses have been conducted of scrap preparation and secondary smelting and refining technologies (Kusick and Kenehan 1978). Process data, for example, show inputs of truck and rail transportation, electrical energy and fuel oil into two types of copper scrap preparation, per ton of prepared scrap output, and inputs of transportation, electrical energy, natural gas, coke, and fluxes into three types of secondary smelting and refining, per ton of copper ingot. From the standpoint of complete input-output structure, the information which is now available is incomplete, but, combined with data which we will receive directly from industry sources, will suffice for a first approximation.

Requirements for Capital Stocks

The amount and composition of capital stock required to produce each period's output is particularly important for this study. Future demand for minerals determines how much new capacity, above replacement of existing stocks, will be needed in extraction and processing sectors. Requirements for capital are, of course, also influenced by the availability of resources at different levels of extraction costs. Resource extraction and processing sectors are extremely capital-intensive and account for (especially if energy production is also included) a major share of the total capital stock.

A new matrix of capital-to-output ratios is being constructed for the United

States based upon an expansion of a projected capital matrix for 1970-75 (Fisher et al.1971). The Battelle matrix shows the requirements, per unit of output, for forty-five types of capital stocks by 83 sectors. We are currently increasing the number of capital-using sectors to 200 in order to detail the capital requirements of minerals extraction and processing industries. This disaggregation is based on data which we have obtained from major producers of iron and steel, aluminum, copper, nickel, lead and zinc. This data is being used to construct column vectors of capital-to-output coefficients based on the latest facilities to come onstream for these minerals. For minerals sectors for which it has not been possible to obtain information from producers (the only source of information at this level of detail), vectors will be borrowed from other sectors, adjusting for ore grade being mined and main mining technology (e.g., open pit, underground, or lakebed).

For copper mining and processing, capital intensity is increasing significantly at the present time due to inflation, pollution control requirements, and economies of scale which make smelter operations, for example, under 100,000 annual tons uneconomical. Forecasts of copper demand are particularly important to producers because of increasing lead times required to bring new production facilities onstream. This is a result of the same forces which are leading to greater capital intensity. Currently, the lag between the decision to add new capacity and the time the new facility begins production is six or seven years; if exploration time is included, three or four additional years may be necessary.

We have received data, from several producers, concerning capital requirements for copper mining, beneficiation, smelting and refining, including total costs, costs of specific types of equipment and materials, and estimates of pollution abatement costs. In the case of recently built copper smelters in the United States, firms have made available to us actual purchase requisitions which gave the name of each item, its quantity, unit and total price. This information was taken directly from the purchase orders and each item assigned to a 4-digit SIC industry

in which it was manufactured. The 4-digit SIC categories will now be aggregated into the classification scheme of the capital matrix. A proportion of the purchasers costs for each group of item will be reassigned to the trade and transportation sectors in the capital matrix and labor, profits and overhead are excluded. Of the \$300 million required to build one smelter, for example, about \$150 million represented purchases of materials and equipment. Managers at the plant estimated that of the total cost, roughly \$80 million was attributable to pollution abatement.

The facilities being constructed now are indicative of the average capital stock requirements of two decades ahead. Lifetimes of such facilities are normally at least thirty years; copper smelters built at the turn of the century are still in operation and incremental additions and renovations of existing plants has in fact been typical of this industry although pollution abatement requirements may affect this pattern. Thus, the new data are even more useful for describing future capital needs which, considering lead times, require investment five to ten years before capacity output is achieved. Alternative projections may be used, if data are available, for scenarios envisioning more rapid introduction of deep sea mining of ocean floor nodules.

CONCLUSION: THE NEED FOR DATA DEVELOPMENT

If the impression has been given that the input-output data base described here is being constructed after the fashion of a patchwork quilt, this is very much the case. The most laborious and frustrating task of quilting is cutting out, with micro-precision, the thousands of geometric shapes which are required so that they will fit together perfectly to form the desired pattern. This appears to be quite an accurate description of the task of preparing a data base from data that are inconsistent, far from complete, classified according to a mix of schemes, measured in different units, and of various vintages. The problems are greatly compounded by the lack of detailed documentation and standard procedures.

While the effort of preparing data originally produced for other purposes (especially the data contained in the new cost and process studies) is challenging and instructive, it is also tedious and wasteful. Difficulty of locating data of any kind discourages analysis at appropriate levels of disaggregation. Efforts that might be applied to gathering new information are instead absorbed in reconciling base-year data. Input-output studies suffer when the inordinate amount of time required to prepare available data cuts short the time allocated for analysis of the contents of the data base and scenario results. Finally, when the data base is rough or unreliable, a certain cynicism toward structural models which are data dependent is promoted along with a nostalgia for extrapolation and curve-fitting.

The conclusion which can be clearly drawn from the present state of economic and physical data regarding minerals production and consumption is that the users of disaggregated, empirical models must recognize that data organization and development is a critical task which deserves attention and financial support quite apart from model building and analytical studies. Many specific suggestions for this type of work could be made: disaggregation of crucial sectors such as iron and steel or industrial inorganic chemicals, descriptions of recycling, precise specification of pollution emissions and abatement, estimation of mineral contents of final use categories of products, estimation of cost-step functions related to resources, and so on.

Some positive developments are already underway. For example, mineral consumption data bases, for input-output purposes, have been prepared at the Institut für Wirtschaftsforschung in Berlin and the United States Federal Preparedness Agency. An encyclopedia of industrial processes^{*} is being compiled by the research group which

*

the feasibility study for the Process Encyclopedia was completed in 1981, extensive documentation can be obtained from the Structural Analysis Division of Statistics Canada, Ottawa, Canada K1A 0T6. Although an independent development there are nevertheless many similarities to the IIASA Facility Data Base (presented in Part 2 of these proceedings) which has led to the development of a "mapping" between the two systems (Grübler, Hoffman and McInnis 1982). In this publication the advantages of process type information systems over Input-Output approaches (in the viewpoint of the authors) are also discussed. [Note by the Editors.]

prepares the Canadian input-output tables. Finally, an exciting proposal for a global materials-energy balance system has been proposed for the United Nations. For the advance of input-output studies of minerals resources generally, this type of research should be pursued.

REFERENCES

- Arthur D. Little, Inc. (1976) Environmental Considerations of Selected Energy Conserving Manufacturing Process Options: Volume XIV. Primary Copper Industry Report, Cincinnati, Ohio: Environmental Protection Agency.
- Battelle Columbus Laboratories (1975) Energy Use Patterns in Metallurgical and Non-metallic Mineral Processing, Washington, D. C.: United States Department of the Interior.
- Bureau of Economic Analysis (1979) The Input-Output Structure of the U.S. Economy: 1972, Washington, D. C.: United States Department of Commerce.
- Bureau of Mines (1975) Minerals Facts and Problems, Washington, D. C.: United States Department of the Interior.
- Bureau of Mines (1979) Mineral Trends and Forecasts, Washington, D. C.: United States Department of the Interior.
- Carter, Anne P. (1970) Structural Change in the American Economy, Cambridge, Massachusetts: Harvard University Press.
- Fischer, W. Halder and Chilton, Cecil H. (1971), An Ex Ante Capital Matrix for the United States, 1970-1975, Columbus, Ohio: Battelle Memorial Institute.
- Kusick, Charles L. and Kenehan, Charles B. (1978) Energy Use Patterns for Metal Recycling, United States Department of the Interior: Washington, D. C.
- Leontief, Wassily, Carter, Anne P., and Petri, Peter (1977) The Future of the World Economy, New York: Oxford University Press.
- United States Geological Survey (1973) Professional Paper 820, Washington, D.C.: United States Geological Survey.
- Grübler, A., Hoffmann, R., and B. McInnis, 1982, Process Information Systems: A Synthesis of two Independent Approaches, IIASA CP-82-24, Laxenburg, Austria. [Note by the Editors.]

The International Phosphate Resource
Data Base, and its Role in Phosphate
Resource Assessment

Richard P. Sheldon

U.S. Geological Survey and
Resource Systems Institute
East West Center
Honolulu, Hawaii 96848, USA

and

Nancy J. Bridges

U.S. Geological Survey
Denver, Colorado, USA

Data relating to global phosphate rock resources at the present time are diffused, unstandardized, poorly available, and in a general state of unfitness for assessing global phosphate resources. A plan for collecting, collating and standardizing these data for input into a computerized data base was prepared by an international group of geologists at a workshop of the Resource Systems Institute of the East-West Center in Honolulu, Hawaii, in February, 1978.

The purpose of this International Phosphate Resource Data Base (IPRDB) is 1) to allow better scientific analyses of phosphate deposits in space, time, depositional environment and geologic history, 2) to allow the assessment of geologic knowledge to direct future research and 3) to allow development of analogue models for predicting areal, size and quality distribution of phosphate deposits in unexplored areas.

The prime users of the data base will be research geologists and geochemists investigating geologic processes, and resource and exploration geologists who will delineate areal targets for assessment or exploration by combining the analogue models with an assessment or exploration methodology. Secondary users will be engineers and mineral scientists concerned with exploration and exploitation of phosphate rocks. Economists and national planners will be indirect users in that they will be concerned with phosphate availability estimates generated from the data base by the prime users.

The unit of entry of IPRDB is the phosphate rock occurrence. This allows geologic information on deposits of all levels of economic development to be considered, from a non-economic mineral occurrence to a fully studied, large, commercial deposit. The data are broken into geographic, objective geologic, interpretive geologic, resource assessment and economic categories.

Introduction

Data on global phosphate deposits have been collected at a steadily increasing rate since late in the 19th century. At the present time, these data are diffused throughout the published literature of the world as well as in the unpublished or open-filed reports of government and industrial organizations and universities. These data are unstandardized in that no generally accepted mineral resource classification system exists and many classifications of scientific parameters remain to be refined and generally accepted. Because these data are poorly known and not available to the scientists who need them, much data, in ignorance or frustration, must be regenerated or, even worse, done without. However, some data cannot be regenerated, as the opportunity for acquisition has disappeared through mining, mine flooding or loss of drill cores. Thus phosphate deposit data are in a generally unfit state for assessing global phosphate resources.

In 1978 a small, international group of phosphate geologists under the initiative of Guerry McClellan got together at the International Fertilizer Development Center in Muscle Shoals, Alabama for a preliminary discussion of the problem. Later in April 1978 an expanded group met at the Resource Systems Institute (RSI) of the East-West Center in Honolulu and held the International Phosphate Resource Data Base (IPRDB) Workshop. This workshop was sponsored jointly by the International Geological Correlation Program (IGCP) Projects 98 and 156, the U.S. Geological Survey and the East-West Resource Systems Institute. It reviewed the purpose and potential user group of the data base, discussed the kind of data that should be entered into the data base and prepared a preliminary data format. Finally, the workshop participants agreed on the strategy of development and implementation of the data base.

Many of the participants of the IPRDB workshop met again at the field workshop/seminar of IGCP Project 156 in Australia and reviewed the data format (Cook and Shergold, 1979). The development of IPRDB is being continued by an international group of phosphate geologists under the sponsorship of IGCP Project 156. These geologists are from various national and international research organizations representing government, industry and academia. This paper summarizes this effort and describes the role of IPRDB in the larger task for assessing global phosphate resources.

Purpose of IPRDB

The purpose of the International Phosphate Resource Data Base is to:

1. Collect and organize geologic knowledge of phosphate deposits in order to allow better scientific analyses of phosphate deposits. These analyses would deal with 1) the extent of phosphogenic provinces in space and time, 2) models of deposition of phosphate, 3) epochs of phosphate deposition, and 4) relationship between paleo-oceanographic (plate tectonic) history and phosphate deposition.
2. Allow the assessment of our knowledge of phosphate geology in order to direct future research.
3. Collect and organize the data on phosphate that, combined with regional geologic information, are basic to the assessment of undiscovered phosphate resources in unexplored or underexplored parts of the globe. This includes analogue analysis to estimate size distribution of undiscovered deposits.
4. Enable the development of computerized resource assessment and exploration strategies based on the various depositional models developed in item 1 above.
5. With a combination of items 3 and 4, develop possible phosphate resource assessment and exploration programs in developing countries.

Users of IPRDB

The prime users of the data base will be geologists undertaking

- 1) research on phosphate deposits, including both basic research and resource assessment, and 2) the prospecting stage of exploration.

Secondary users will be engineers and mineral scientists concerned with the development stage of exploration and exploitation.

Economists and national planners will be indirect users in that they will be concerned with phosphate availability estimates generated from the data base. It is unlikely that they would be direct users.

Description of IPRDB

Unit of entry. IPRDB is a collection of data related to phosphate occurrences. An occurrence could be any deposit of phosphate rock, from a mineral curiosity to a large, well-defined commercial rock body. Ideally, after the phosphate-bearing rocks have been thoroughly studied, the occurrence would be defined as the genetically related sequence of phosphatic beds contained within the stratigraphic unit over its full original extent.

Thus, in countries using group-formation-member rock-stratigraphic nomenclature, the formation would be the name of the occurrence. An example of this is the Phosphoria Formation of the Permian Sublett Paleobasin of Utah, Montana, Idaho, Wyoming and Nevada in the United States. In countries that map time-rock units, the map unit name plus a lithologic or geographic name would probably be used to designate the phosphate occurrence. The purpose of this is to define natural, phosphate-bearing, geologic units that have been deposited more or less continuously throughout an interval of geologic time in one general paleogeographic region.

Most phosphate occurrences are not well enough known to achieve this ideal. To take into account the variation of level of information about the occurrence, four hierarchic occurrence categories have been established. These are, in decreasing order of synthesis: 1) paleogeologic province, 2) geographic region, 3) formation outcrop belts and 4) single-localities.

1) The paleogeologic province in which phosphorite was deposited, as discussed above.

2) The geographic region is the individual, geographic region where phosphate-bearing rock units crop out. The geographic region usually would be smaller than the paleogeographic province of the phosphate-bearing unit. For example, the Peale Mountains of southeastern Idaho contain many of the outcrops of the Phosphoria Formation and most of the thicker and richer beds, but the Peale Mountains cover a much smaller area than the Permian Sublett Paleobasin. If only these outcrops were known and the formation named, the occurrence would be called the Phosphoria Formation of the Peale Mountains.

3) The linear outcrop of a phosphate-bearing formation is the next lower category of phosphate occurrence. At an early stage in knowledge about a phosphate occurrence, it might be known to exist only in a linear outcrop, for example, the Phosphoria Formation crops out in a belt along McCarthy Mountains in Montana. Were that the only known outcrop belt of the formation, it would be called the Phosphoria Formation of McCarthy Mountain, or perhaps the McCarthy Mountain phosphate occurrence.

4) Finally, if a deposit is known from only one locality, the geographic name of that locality would identify the deposit. After the discovery of a bed of phosphorite near the village of Turayf in Saudi Arabia and before its regional extent had been defined, it was known as the Turayf phosphate occurrence.

Generally speaking, the geologist reporting on a phosphate occurrence will have selected the highest level of occurrence category that he feels confident about, and then will have used that level in selecting a name for the occurrence. It is essential that the highest level of occurrence category be used and that occurrences not overlap each other, in order that no redundancy exists in the data base.

Data. The question of which data to record in a data base is difficult to answer and depends on the purpose of the data base. As IPRDB is primarily a geologic data base, the emphasis of data selection is geologic. However, much geologic data are also useful for resource assessment and economic purposes. For example, the total mass and phosphate content of the phosphate occurrence is important for 1) geochemical considerations, 2) for use in establishing grade and size distributions of known deposits to serve as analogues for estimating quantity and quality of undiscovered resources, and 3) for economic analysis of phosphate supply. The data are the same but the uses and users are different.

The kinds of data recorded in the format of IPRDB are four kinds: geographic, geologic, resource and economic. However, as stated above, it is hard to draw strict boundaries between these categories.

Geographic data include location information: continent, country, state or province, mining district, latitude and longitude of the middle of the deposit and the corners of a superimposed rectangle approximating the areal distribution of the deposit and the depth of water if the occurrence is an offshore deposit.

Geologic data are of two kinds: objective and interpretive. Objective data include deposit /, phosphate rock chemical, petrographic and mineralogic

/ The determination of the deposit type is of course interpretive, but is such an elementary interpretation that for practical purposes it is objective. Information relating to the occurrence category is entered here.

data, stratigraphic and local structural data, paleontologic data and sedimentary structural data. Interpretive data include geologic age, metamorphic grade, depositional process, depositional environment, paleogeography.

stage of basin development, plate tectonic setting, paleotectonic setting and regional structural setting. Because more than one scientific interpretation of a phenomenon is possible, references to the authors making the interpretations are recorded.

Resource assessment data include thickness and grade of phosphate beds, detailed chemical character of the phosphate rock, estimates of quantity and quality of identified or discovered resources, estimates of quantity and quality of hypothetical undiscovered resources and estimates of quantity of speculative undiscovered resources.

Economic data includes reserve estimates, chemical characteristics of run-of-mine ore, beneficiation processes, chemical characteristics of commercial concentrate, by-products, production data, production capacity and number of mines.

Bibliographic references. An essential part of IPRDB is the bibliographic sub-file. Much of the data, particularly the interpretive scientific data, are referenced to the authors and publication sources. This is done by a number that identifies the full reference in the phosphate bibliography sub-file (phosbib). All references are or will be keyworded according to whether or not they include data elements of IPRDB, including the occurrence name. The keywording normally used for geologic articles are also included. In addition to references to occurrence information, phosbib includes references on phosphate geology not specific to phosphate occurrences. This includes general publications of phosphate mineralogy, geochemistry, petrology, sedimentology, oceanography, limnology and pedology, with emphasis on the first four. Thus phosbib is an attempt to organize the geologic literature on phosphate rock. About 1200 references are presently in phosbib and an additional 3000 have been collected on cards for inclusion.

Phosbib used the format of GEOREF, the computerized bibliographic file of the American Geological Institute, and in fact the 1200 references now in phosbib were obtained from GEOREF and specially keyworded for IPRDB. Eventually, the other phosphate references of phosbib will be added to GEOREF for general availability.

Compiler of data form. The compiler and date of compilation of the IPRDB data form will be entered for each occurrence.

Computer Aspects of IPRDB

Hardware. IPRDB is being developed and disk stored on the Honeywell MULTICS computer of the USGS in Denver, Colorado. This is a time-share computer that is accessible by remote entry using the Tymnet telecommunications network.

Storage and retrieval. IPRDB uses PLI language and is stored in a format that is a variation of the CRIB (Computerized Resource Information Bank) format (Calkins and others, 1978; Keefer and Calkins, 1978). CRIB is in fact a collection of compatible data sets using deposits as the collection unit. IPRDB including phosbib, is retrievable using GRASP, which is written in FORTRAN (Bowen and Botbol, 1975). The retrieval output can be in the form of interactive remote terminal access, magnetic tape, batch computer printout or (eventually) publication.

Nancy J. Bridges has adapted the IPRDB format for storage and retrieval in the computer during the research phase, and is generally supervising the computer aspects of the development of IPRDB.

Development Strategy of IPRDB

The development of IPRDB has been deliberate and has progressed through the following sequential steps:

- 1) development of rationale and identification of user groups for data base,
- 2) development of format of data base,
- 3) development of bibliographic reference data subset, and
- 4) writing program to accept the data entry.

These four steps are complete, or nearly so. The next step, which is just beginning, is the pilot stage. About ten phosphate geologists from various countries will fill out formats for several occurrences with which they are familiar. These occurrences will be selected so that a range of problems will be faced. Specifically, examples of all different occurrence categories and occurrence types will be entered for the pilot stage. After entry of these occurrence data sets, analysis of this pilot IPRDB will be carried out by the geologists and final corrections of format and computer program made. The program will be documented and final instruction manuals will be prepared.

The operational stage can then proceed. It is planned to request phosphate geologists of the various organizations throughout the world to fill out the formats for the deposits with which they are familiar. These organizations are primarily the national geologic, mineral resource and mining organizations, but will also include universities and private organizations. Every attempt will be made to have the geologists most familiar with the deposits serve as compilers.

There is no question that much uncertainty regarding interpretive data exists, and IPRDB is designed to allow expression of this uncertainty. It is not being set up as an instrument of judgement on the correctness of interpretation, as that would make its construction impossible. Those questions must be faced in the scientific forums of the world.

The operational stage of IPRDB will have to include a mechanism for updating and improving the data. However, the planning for that process has not been undertaken.

Availability of IPRDB

IPRDB will be available with unlimited access to all users from every nation. The only factor limiting the use of IPRDB will be the actual cost of retrieval, which will be minimal. A more difficult problem than cost will be the mechanism of access. For those users who can access IPRDB via a remote terminal, the problem will be minimal. An institution that wishes to put IPRDB on its own computer for its own use can order a duplicate tape and documentation of the file. It is planned that a retrieval request from a user received by mail can be filled by a batch computer printout and returned by mail. Finally, publication of the indexed bibliography and syntheses of the occurrence data will be published and made available to users who do not have ready access to the computer or whose needs are more efficiently met by hard-copy data.

System for Assessing Global Phosphate Resources

IPRDB is an element in the system for assessing phosphate resources (Sheldon, 1979), which includes five necessary steps: 1) basic research in geologic processes, 2) synthesis to give models of phosphate deposition, 3) development of resource assessment methodology, 4) organization of geologic data and 5) assessment of phosphate resources. The general relationship of these steps is shown in figure 1.

Basic research. Basic research on the geology of phosphate deposits generates the knowledge needed to improve our understanding of the various processes of origin of phosphate deposits. Without continued basic research, the world phosphate supply system would be eventually slowed because fewer

Figure 1. Steps in Assessment of Phosphate Resources

	<u>Activity</u>	<u>to give</u> →	<u>Product</u>
I	Basic Research	→	Knowledge of Geologic Processes
II	Synthesis of Knowledge of Geologic Processes	→	Models of Phosphate Deposition
III	Analysis of Depositional Models in Relation to Assessment Utility	→	Resource Assessment Methodology
IV	Collection, Standardization and Collation of Existing Data	→	Geologic Data Bases (including IPRDB)
V	Application of Assessment Methodology to Geologic Data	→	Estimates of Identified and Undiscovered Phosphate Resources (quantity, quality, location)

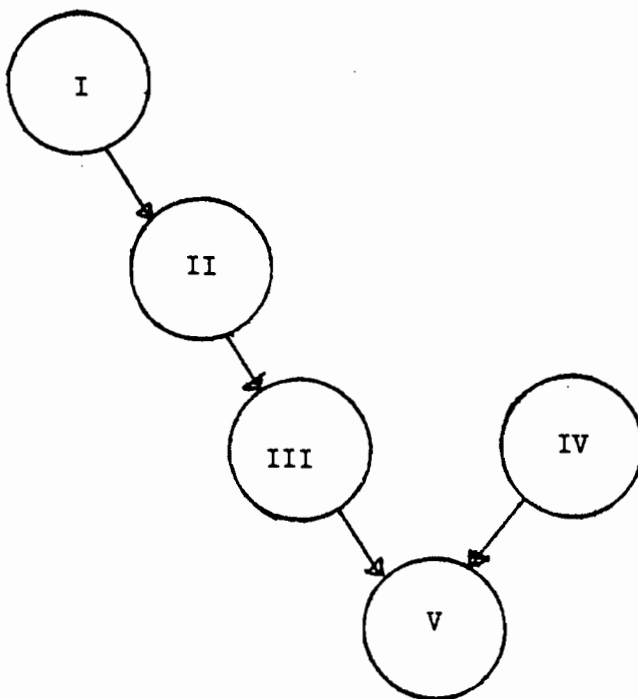

development opportunities would be identified. Basic research is the sine qua non of the world phosphate supply system.

Knowledge of processes of deposition of phosphate and of the geologic history of the earth is in a state of great change. Recent research has made enormous advances in the geology of phosphate, but enormous gaps remain, particularly in the poorly known but rapidly developing fields of paleo-climatology and paleo-oceanography.

Models of phosphate deposition. The basic research on phosphate deposits gives data that are synthesized into models of deposition (Burnett and Sheldon, 1979). A major use for these models is for understanding the distribution of ancient phosphorites. In this sense, a model of phosphate sedimentation is simply an hypothesis explaining one or more aspects of the deposition of ancient phosphorites. These give the conceptual basis for both assessment of phosphate resources and exploration for undiscovered deposits.

Resource assessment methodology. Assessment of identified phosphate resources is a relatively straightforward though difficult and expensive geologic-engineering process, but the methodology to assess undiscovered phosphate resources has not been developed fully.

The assessment process requires the sequential application of concepts of origin and occurrence of phosphate deposits to the area under consideration. Some geologic knowledge of the area is necessary, and commonly includes the broad geodynamic (plate tectonic) history, age and lithology of sedimentary rocks, and the regional and basin tectonic setting. The sequential use of geologic models in areal resource assessment would be the same in any area, and the hierarchy of models developed by the Marine Phosphatic Sediments Workshop (Burnett and Sheldon, 1979) is given below:

1. Definition of models of interest. The type of phosphate deposit being assessed must be selected.
2. Paleolatitude and paleogeographic models.
3. Geologic age models.
4. Regional tectonic models.
5. Lithologic models.

This methodology would not give a quantitative assessment of phosphate resources. At the present time no such methodology for quantitative assessment exists, although one is in the early research stage. This is a methodology utilizing the computer-based consultation system for mineral resource assessment and exploration called PROSPECTOR (Hart and others, 1978).

Organization of geologic data. The assessment of undiscovered phosphate resources in regions requires data on known phosphate occurrences and on the structure and geologic history of regions being assessed.

For the purpose of phosphate resource assessment, the availability of regional geologic data is assumed, but without it, no phosphate assessment is possible. The quality of the phosphate resource assessment is a direct function of the quantity and quality of the knowledge of the geology of the region. Phosphate resources are no different from other mineral resources in this regard.

IPRDB is being developed to organize the data on known phosphate occurrences. Thus IPRDB is a necessary element in the program for global assessment of phosphate resources, but it is important to realize that IPRDB is not in itself the global assessment of phosphate resources.

Resource Assessment. The systematic assessment of undiscovered phosphate resources can proceed on the completion of assessment methodology and IPRDB. There is of course no reason why local assessment and exploration activities need wait for this point, but the completed methodology and

IPRDB will enhance their effectiveness. It is expected that the information required for this resource assessment will be entered into IPRDB and a dynamic system for phosphate development will ensue.

References

- Bowen, Roger W. and Joseph Moses Botbol, 1975. The geologic retrieval and synopsis program (GRASP): U.S. Geol. Survey Prof. Paper 966, 87 p.
- Burnett, Wm. C. and Richard P. Sheldon, 1979, Report on the marine phosphatic sediments workshop: Proceedings of a workshop held in February, 1979 at Resource Systems Institute, East-West Center, Honolulu, Hawaii, in press.
- Calkins, James A., Keefer, Eleanor K., Ofsharich, Regina A., Mason, George T., Tracey, Patricia and Mary Atkins, 1978, Description of CRIB, the GIPSY Retrieval Mechanism, and the Interface to the General Electric Mark III Service: U.S. Geol. Survey Circ. 755-A, 49 p.
- Cook, P.J. and J. H. Shergold, 1979, Proterozoic-Cambrian Phosphorites: Papers given at a UNESCO sponsored conference held in Australia in 1978. Australian National University Press, Canberra, Australia, 106p.
- Hart, P.E., et al. 1978, PROSPECTOR - A Computer-based consultation system for mineral exploration: Journal of Mathematical Geology. Vol. 10. no. 5., p. 598-610.
- Keefer, Eleanor K. and James A. Calkins, 1978. Description of Data Items and Codes in CRIB: U.S. Geol. Survey Circ. 755-B. 32 p.
- Sheldon, Richard P., in press, Global Assessment of Phosphate Resources. The Present State of Disorder and a Program for Improvement: given at the Conference of Project 98 of the International Geological Correlations Program held at Ixtapa, Mexico, April, 1979, to be published in the Journal of Mathematical Geology.

PART 6

APPENDIXES

PREPARATION OF THE IIASA - RSI CONFERENCE THROUGH TELECONFERENCING

A. Gruebler (IIASA)

R. Sheldon (EWRSI)

1. Introduction

Communication between scientists from different organizations and in different countries plays an ever increasing role in multidisciplinary and multinational research. This calls for increased traveling for face-to-face meetings and telephone and mail communication. The difficulties of this system of communication are well-known. The problem of improving the efficiency of communication has found a partial solution that is as yet very little known (especially in Europe), namely teleconferencing via computer.

The main advantage of teleconferencing for any research institute lies in the extension of the scientific capacity by being in permanent contact with those scientists who are unable to visit the institute regularly and those who went back to their home institution or to another organization.

2. Technical background of teleconferencing

A computer conferencing system consists of electronic links between individuals who use a remote terminal (similar to an electric typewriter) and an ordinary telephone line to connect their location with a central computer. These electronic links are fairly complex. The individual connects his terminal by a normal telephone call to a small computer, called a node, in his

city. Most of the major cities in the United States, Canada and western Europe have nodes, and an increasing number of major cities in the other parts of the world are having them installed.

The nodes are connected by the international telephone network to a computer that serves as a network processor, which for the IIASA-RSI teleconference is in Los Angeles. The network processor in turn links with the host computer (in our case the U. S. Geological Survey in Denver, Colorado), which receives, classifies, stores and transmits both the teleconference messages between individuals and the data bases that may be used as a part of the teleconference.

Institutionally, these links are controlled as follows:

1. The terminal-node link is the local telephone company.
2. The node-network processor-entry port of the host computer is controlled by a network company using the international telecommunication network.
3. The host computer is controlled by the owner, which in our case is the U. S. Geological Survey. Charges for these links are made by the local telephone company, the network company and the USGS. The international telecommunication charges are recovered by either the local telephone company or the network company depending on the country.

As a result of all this, the individuals linked together can either interact in a simultaneous "electronic meeting" or dialogue at their own convenience, reviewing each other's messages and

responding to them at any hour of day or night, from almost anywhere in the world.

3. Preparation of the IIASA-RSI Conference by teleconferencing

During initial discussions about the preparation of this conference it was decided that IIASA should join already existing teleconferences from the U. S. Geological Survey via the newly implemented TYMNET/TELENET connection to the United States, and by this means facilitate the preparation of the conference and enable continuous and quick communication.

The first link-up took place on 14th of December, 1978 and has evolved since then to a continuous communication.

One of the prerequisites on the side of IIASA's computer was to install the necessary software to:

- * Access the TELENET line from every terminal in the institute
- * having the possibility of interacting with IIASA's PDP11 during teleconferencing and thereby :
- * send prepared messages or data through the line or storing incoming messages or data directly on computer file in order to work directly on the received data.

This software has now been established enabling any potential user (even the non-computer expert) to use teleconferencing efficiently with simple commands.

EXPERIENCES IN TELECONFERENCING

a) Exchange of messages

These telex substitutes combine quicker answers - only influenced by the time difference between the two partners (generally within 12 hours from desk to desk) with lower costs in comparison with ordinary telexes or telephone calls, the latter being practically impossible, for example, between Hawaii and Laxenburg due to the eleven hour time difference.

b) Simultaneous Teleconferencing.

Two or more participants can communicate at the same time. Experiences in this are less encouraging due to the fact that after two or three messages, one gets mixed up in switching from the listening (receiving) to the whispering (talking (sending) mode. These problems are inherent to teleconferencing due to the time lag between sending a message and receiving an answer. For example person A sends a message to person B ; while waiting for an answer he thinks of something else to say and sends that: person B answers the first question and sends it. Then Person A answers that question while person B is answering the second question of person A. Both of these answers are sent simultaneously, and soon the sequence is out of order. To wait for messages in sequence means that each person must spend half his time waiting for the other person to type out messages, a procedure not conducive to sparkling interaction. If three or more people are involved in the teleconference, the sequence of messages becomes

hopelessly mixed up and takes much time on the part of participants to unscramble, further adding time to the live teleconferencing.

c) Exchange of Information

Access to computer data bases has been practised for a long time, but teleconferencing adds a new dimension to it, by providing not only assistance to the potential user who might not be familiar with the software running on the computer he wants to use, but also a forum in which to discuss data validity or to get information about the data base being accessed.

d) Writing Papers

This paper by Gruebler in Laxenburg and Sheldon in Honolulu was jointly written, discussed and edited in about two weeks, a process that would have been impossible without the teleconference. Furthermore, papers can then be edited with special programs and printed directly so that additional typing is not necessary.

After outlining our experience, let us consider the question of the costs involved. The following table summarizes Austrian and US costs for teleconferencing:

APPROXIMATE COSTS OF TELECONFERENCING

IN 1979 US DOLLARS

	Austria	US	Hawaii
fixed costs/month per host	\$7.3 (AS 100)	none	none
line costs/hour	\$13.20 (AS 180)	\$0.75	\$2.40
costs per 1000 characters transmitted	\$0.75 (AS 10)	\$0.02	\$0.03

The cost of using the USGS computer cannot be calculated, but would be negligible. The amount of information exchanged amounts to about 150 printed pages up to now, so that the total costs were about \$1000. By comparison, ten pages of telex message to Hawaii cost about \$1000, so there is an economy factor of 15 between the two means of communication. Of course this factor is a little misleading as we are dealing with a new and additional form of communication, but this shows that the costs involved are not prohibitive.

INTERNATIONAL INSTITUTE FOR APPLIED SYSTEMS ANALYSIS
Laxenburg, Austria

IIASA-RSI CONFERENCE ON

Systems Aspects of Energy and Mineral Resources
9-14 July 1979

Seminar Room

FINAL LIST OF PARTICIPANTS

Dipl.Ing. Sebastian ALBER
Institute for Technology
University of Economics
Franz Kleingasse 1
1190 Vienna, Austria

Dr. John ALBERS
Branch of Western Mineral Resources
U.S. Geological Survey
345 Middlefield Road
Menlo Park, Ca. 94025, USA

Mr. Xavier ALVAREZ-VARA
Organisation for Economic Co-operation
and Development (OECD)
2, rue Andre Pascal
75775 Paris, France

Dr. A. ARBATOV
All-Union Research Institute for
Systems Studies
29, Ryleyev St.
119034 Moscow, USSR

Mr. Joseph BARNEA
UNITAR
801, United Nations Plaza
New York, N.Y. 10017, USA

Prof. Harold J. BARNETT
Department of Economics
Washington University
207 Eliot Hall
St. Louis, Missouri 63130, USA

Mr. Ken BAYLIS
Rio Tinto Zinc Corporation Ltd.
6, St. James's Square
London SW1Y 4LD, United Kingdom

Dr. E. CAMPOS-LOPEZ
Research Center of Applied Chemistry
Aldama Ote. No. 351
Saltillo, Coahuila, Mexico

Mr. Martin CELLERIER
French Petroleum Company
24, rue Erlanger
75016 Paris Cedex, France

Dr. Allen L. CLARK
U.S. Geological Survey
12201, Sunrise Valley Drive
Reston, Virginia 22092, USA
presently with: International
Institute for Resource Develop-
ment, Belvederegasse 2,
Vienna, Austria

Prof. Robert H. DAVIS
Department of Physics
Florida State University
Tallahassee, Florida 32306, USA

Mr. van DOORNE
IEA - Coal Research
14, Lower Grosvenor Place
London SW1W OEX, United Kingdom

Mr. William DREWS
Communications and Computer
Sciences Department
EXXON Corporation
P.O.B. 153
Florham Park, N.J. 07932, USA

Mr. Stuart DUNCAN
IEA - Coal Research
14, Lower Grosvenor Place
London SW1W OEX, United Kingdom

Mr. A. DUPAS
 Interdisciplinary Program for
 Research and Development of
 Solar Energy
 Laboratory of the National Centre
 for Scientific Research (CNRS)
 15, Quai Anatole France
 75007 Paris, France

Mr. Frank EDWARDS
 Inter-University Association for
 Computer Assisted Global Systems
 Studies
 York University
 4700 Keele St., Downsview
 Toronto, Ontario M3J 1P3, Canada

Dr. Zygmunt FALECKI
 Scientific and Development Center
 for Energy Problems (OBR-GPE)
 ul. Owcowa 6a
 Katowice, Poland

Dr. Günter B. FETTWEIS
 University of Mining and Metallurgy
 Franz-Josef-Str. 18
 8700 Leoben, Austria

Eng. Philippe GENTILHOMME
 Bureau of Geological and Mining
 Research (BRGM)
 P.O.B. 6009
 45018 Orleans, France

Dr. Gotthard GERISCH
 Institute for Energetics
 Central Office for Rational Energy
 Applications
 Torgauer Str. 114
 Leipzig 7024, GDR

Prof. Werner GOCHT
 Free University of Berlin
 Department of Geology
 Altensteinstr. 34a
 D-1000 Berlin (West) 33

Mr. M.V. HANSEN
 IAEA
 Kärntnerring 11-13
 1011 Vienna, Austria

Dr. John HARTE
 Energy and Environment Division
 Lawrence Berkeley Laboratory
 University of California
 East End of Hearst Ave.
 Berkeley, Ca. 94720, USA

Prof. John M. HERNANDEZ
 College of Engineering
 New Mexico State University
 P.O.B. 3449
 Las Cruces, New Mexico 88003, USA

Prof. Dr. Josef HOELZL
 Institute of Technology
 University of Economics
 Franz Kleingasse 1
 1190 Vienna, Austria

Dr. M. King HUBBERT
 5208 Westwood Drive
 Washington, D.C. 20016, USA

Dr. Erwin HUETTNER
 Federal Experimentation and Research
 Establishment
 Franz-Grill Strasse 3
 1030 Vienna, Austria

Mr. Robert M. JIMESON
 Consultant
 1501 Gingerwood Court
 Vienna, Virginia 22180, USA

Dr. Peter KAKELA
 Department of Resource Development
 Natural Resources Bldg.
 Michigan State University
 East Lansing, Michigan 48824, USA

Prof. John KATILI
 Department of Mines and Energy
 Jalan Merdeka Selatan 18
 Jakarta, Indonesia

Dr. Gordon KAUFMAN
 Alfred P. Sloan School of Management
 Massachusetts Institute of Technology
 50, Memorial Drive
 Cambridge, Mass. 02139, USA

Prof. Harry C. KENT
 Potential Gas Agency
 Colorado School of Mines
 Golden, Colorado 80401, USA

Dr. Allen V. KNEESE
Resources for the Future, Inc.
1755, Massachusetts Ave, N.W.
Washington, D.C. 20036, USA

Dr. N. KOUROCHKIN
UNIDO
Lerchenfelderstrasse 1
1070 Vienna, Austria

Mag. Wilhelm KRONER
Institute for Applied Statistics
Gregor Mendelstrasse 33
1180 Vienna, Austria

Mr. Jean-Marc LADOR
Petroconsultants S.A.
P.O.B. 319
1211 Geneva 11, Switzerland

Dr. Bruno LAPILLONE
Institute of Energy Economics
and Law (IEJE)
P.O.B. 47 Centre de Tri
38040 Grenoble, Cedex, France

Dr. Laszlo LENGYEL
Energy Department
Central Mining Development Institute
Varsanyi u. 44
1027 Budapest, Hungary

Eng. Jean-Pierre LEPRETRE
Bureau of Geological and Mining
Research (BRGM)
P.O.B. 6009, Avenue de Concyr
45018 Orleans, Cedex, France

Mr. LE THUILLIER
The Elf Aquitaine Company
Rue Nelaton 7
75739 Paris Cedex 15, France

Dr. Detlev LEYTHAEUSER
Institute for Petroleum and Organic
Geochemistry (ICH-5)
Nuclear Research Installation
P.O.B. 1913
D-5170 Jülich, FRG

Prof. Manfred LORBACH
University of Mining and Metallurgy
8700 Leoben, Austria

Mr. Eleodoro MAYORGA-ALBA
ECE
Avenue de la Paix
1211 Geneva 10, Switzerland

Prof. Paul MEDOW
York University
4700 Keele St., Downsview
Toronto, Ontario M3J 1P3, Canada

Dr. Eilif V. MILLER
U.S. Department of Agriculture,
Science and Education
Washington, D.C. 20250, USA

Dr. Vincent McKELVEY
U.S. Geological Survey
12201 Sunrise Valley Drive
Reston, Virginia 22092, USA

Dr. E. NADEZDIN
State Committee for Science and
Technology
Moscow, USSR

Mr. F. NARAGHI
OPEC
Obere Donaustrasse 93
1020 Vienna, Austria

Dr. Sylvia NASAR-O'BRIEN
Institute for Economic Analysis
New York University
251, Mercer Street
New York, N.Y. 10012, USA

Mr. Frederic OLDS
Power Engineering Magazine
1301, South Grove Ave.
Barrington, Ill. 60010, USA

Dr. Ilona PAPP
Energy Department
Central Mining Development Institute
Varsanyi u. 44
1027 Budapest, Hungary

Eng. Bernard PAULY
Electricity of France
2, rue Louis Murat
Paris Cedex 8, France

Prof. W.E. PETRASCHKE
Dionysius Andrassy Str.16
1190 Vienna, Austria

Dr. Lubomir PETRAS
Federal Ministry of Fuel and
Power
Vinohradska 8
Prague, CSSR

Dr. A. PETROV
Economic Research and Systems
Planning Group
Department of Economics
York University
4700 Keele St., Downsview
Toronto, Ontario M3J 1P3, Canada

Eng. B. PLOTON
The Elf Aquitaine Company
Rue Nelaton 7
75739 Paris Cedex 15, France

Dr. Kenneth ROSING
Erasmus University
P.O.B. 1738
Rotterdam, Netherlands

Dr. Erik RIFKIN
Environmental Planning/Research
Institute
2000 Century Plaza, Suite 310
Columbia, Maryland 21044, USA

Mr. Dietmar RUDARI
OPEC
Obere Donaustrasse 93
1020 Vienna, Austria

Prof. Walter J. SCHMIDT
Institute for Prospecting,
Exploration and Mineral Economics
University of Mining and Metallurgy
8700 Leoben, Austria

Prof. Dr. Erich SCHROLL
Federal Experimentation and Research
Establishment
Franz-Grill Strasse 3
1030 Vienna, Austria

Dr. Gerhard SCHWACH
Austrian Atomic Energy Research Ltd.
Lenaugasse 10
1082 Vienna, Austria

Dr. A. SHAKAY
All-Union Research Institute for
Systems Studies
Moscow, USSR

Dr. Richard SHELDON
U.S. Geological Survey and
East-West Resource Systems Institute
1777 East-West Road
Honolulu, Hawaii 96848, USA
presently: International Consultant,
3816 T Street, N.W.
Washington D.C. 20007, USA

Dr. Toufiq SIDDIQI
Environment and Policy Institute
East-West Center
1777 East-West Road
Honolulu, Hawaii 96848, USA

Dr. Peter P. SINT
Austrian Academy of Sciences
Fleischmarkt 20/1/3
1010 Vienna, Austria

Dr. Malcolm SLESSER
EURATOM
21020 Ispra, Italy

Dr. Kirk R. SMITH
Resource Systems Institute
East-West Center
1777 East-West Road
Honolulu, Hawaii 96848, USA

Mr. M.F. SMITH
Petroconsultants S.A.
P.O.B. 319
1211 Geneva 11, Switzerland

Dr. Z. SOKOLOVA
All-Union Research Institute for
Systems Studies
Moscow, USSR

Eng. Pierre SOLETY
Bureau of Geological and Mining
Research (BRGM)
P.O.B. 6009, Avenue de Concyr
45018 Orleans Cedex, France

Dr. Philip STARK
Petroleum Information Corp.
P.O.B. 2612
Denver, Colorado 80201, USA

Dr. Wolfgang SUESS
Federal Office for Geo-Sciences
and Raw Materials
Stilleweg 2
D-3000 Hanover 51, FRG

Prof. M. SURGUCHEV
All-Union Research Institute
for Systems Studies
Moscow, USSR

Dr. Uno SVEDIN
Committee for Future-Oriented
Research
Swedish Council for Planning and
Co-ordination of Research.
BOX 6710
S-11385 Stockholm, Sweden

Ms. Linda TROCKI
IAEA
Kärntnerring 11-13
1011 Vienna, Austria

Dr. P. TSVETANOV
Institute for Nuclear Research
and Nuclear Energy
Bulgarian Academy of Sciences
Sofia, Bulgaria

Dr. Dietmar UFER
Institute for Energetics
Central Office for Rational Energy
Applications
Torgauer Str. 114
Leipzig 7024, GDR

Prof. Willem UYTENBOGAARDT
Department of Mining and Engineering
Delft Technical University
Mijnbouwstraat 120
2628 RX Delft, Netherlands

Prof. T. VASKO
The Committee for IIASA of the
Czechoslovak Socialist Republic
Prague, CSSR

Mr. Alfred H. VOELKER
Oak Ridge National Laboratory
Bldg. 4500N
Oak Ridge, Tennessee 37830, USA

Dr. Ingrid WAGNER
Institute of Technology
University of Economics
Franz Kleingasse 1
1190 Vienna, Austria

Prof. Siegfried v. WAHL
Technical University
Erzstrasse 20
D-3392 Clausthal, FRG

Mr. Georg WOITE
IAEA
Kärntnerring 11-13
1010 Vienna, Austria

Dr. J.C. van WYNEN
Shell International Petroleum
Shell Center
London SE1 7NA, United Kingdom

Dr. Oliver YU
Electric Power Research Institute
Palo Alto, California 94304, USA

Prof. M.T. ZEN
Assistant Minister of State
for Research and Technology and
Bandung Institute of Technology
Jakarta, Indonesia

IIASA Participants

R. Levien, Director
O. Vasiliev, Deputy Director (REN)

A. Astakhov, REN	F. Katsonis, ENP
T. Balabanov, ENP	E. Medova, REN
A. Butrimenko, SDS	S. Medow, REN
D. Gourmelon, ENP	J. Merzeau, REN
M. Grenon, REN	F. Seo, SDS
A. Gruebler, REN	N. Vorontsov, REN