

WORKING PAPER

THE IMPACT OF NEW TECHNOLOGIES ON THE ENVIRONMENT

*Aude Joly
Marc Bandelier*

May 1988
WP-88-043

**THE IMPACT OF NEW TECHNOLOGIES
ON THE ENVIRONMENT**

Aude Joly
Marc Bandelier

May 1988
WP-88-043

Participants in the 1987 YSSP. Current affiliations are Institut National Agronomique de Paris Grignon and Ecole Nationale Genie Rural Eaux et Foret, respectively.

Working Papers are interim reports on work of the International Institute for Applied Systems Analysis and have received only limited review. Views or opinions expressed herein do not necessarily represent those of the Institute or of its National Member Organizations.

INTERNATIONAL INSTITUTE FOR APPLIED SYSTEMS ANALYSIS
A-2361 Laxenburg, Austria

PREFACE

One of the objectives of IIASA's Study *Future Environments for Europe: Some Implications of Alternative Development Paths* is to characterize the large-scale and long-term environmental transformations that could be associated with plausible scenarios of Europe's socio-economic development over the next century. The purpose of this task is to help foresee potentially serious environmental problems before they actually occur. This Working Paper is an important contribution toward that goal.

It is becoming increasingly clear that the linkages between technologies and their long-term effects on the environment require more careful attention and forethought than has been the case in the past. The socio-economic benefits of technologies are usually proportional to their scale of application, and the rewards are reaped almost instantaneously. The problem, however, is that the "disbenefits", in terms of ecological degradation, often very nonlinearly with the scale of application, and are manifested on relatively slow time scales. The danger of this syndrome is that the technology may tend to become entrenched over time, making it difficult for adjustment or change by the time the disbenefits become manifest.

Therefore, this timely paper should be of interest to all those who ponder the long-term trade-offs between technological development and environmental degradation.

W.M. Stigliani
Study Manager
Future Environments for Europe

TABLE OF CONTENTS

	Page
1. Introduction	2
2. Technical Summary of New Technologies and their Possible Impacts on Environment	2
2.1 Ecotechnologies.....	2
2.1.1 Types of ecotechnologies	3
2.1.2 Choice of ecotechnologies for a sustainable development	4
2.2 Biotechnologies (other than those conceived specifically to treat the environment)	5
2.3 Energy Technologies	7
2.4 New Materials.....	7
2.5 Information Technologies	8
3. Environmental Risk Classification	10
4. Inter-relations amongst Technologies.....	14
5. A Proposed Scenario for the Future	17
5.1 Introduction	17
5.2 The Third Wave Scenario: A Healthy Society in a Healthy Environment	17
5.2.1 A new energy order (1990-2010).....	17
5.2.2 Subsequent energy developments (2010-2030)	19
5.2.3 A recycling society	21
5.2.4 Society: 1990-2030	22
5.2.5 The environmental turning points	24
5.3 Concluding Remarks about Scenario Construction	25
6. Biotechnologies and Agriculture:	26
6.1 Possible Impacts of Atmospheric Nitrogen Fixation	26
6.1.1 Description of the biological transformation	26
6.1.2 Utilization of biological nitrogen fixation in agriculture	26
6.1.3 Nitrogen fertilizer and environmental concern.....	27
6.1.4 Future trends and biotechnological applications	27
6.1.5 Creation of new symbiosis - state of the art and controversies over future prospects	27
6.1.6 Direct fixation of nitrogen - current state of the art and controversies over future development.....	28
6.1.7 Further remarks.....	29
6.2 Structural Analysis of the Factors Influencing	

the Future Evolution of Biotechnology Applied to Agriculture	31
6.2.1 The General Approach	31
6.2.2 The Important Variables	32
6.2.3 Methodology	39
6.3 Interpretation	43
6.3.1 Variables and their degree of "determinance"	43
6.3.2 Variables and their degree of "receptiveness"	44
6.3.3 Crossed classifications: determinance - receptiveness	48
6.4 The Current Debate over Biotechnologies and the Role of the Actors	51
6.4.1 Farmers as receptors of change	51
6.4.2 The role of the different actors and risk perception	52
7. Conclusions	54
Appendix A: Technical Description of Particular Ecotechnologies	56
Appendix B: Technical Description of Particular Biotechnologies	69
Appendix C: Technical Description of Particular Technologies	75
Appendix D: Technical Description of Developments in Plastics and Ceramics	83
Appendix E: Interactions of Future Possible Biotechnological Applications with Variables Describing Their Political, Economic, Social, Environmental and Scientific Context	86
8. References	91

**THE IMPACT OF NEW TECHNOLOGIES
ON THE ENVIRONMENT**

Aude Joly and Marc Bandelier

1. INTRODUCTION

Our industrialized civilization faces major environmental degradation, which has already occurred locally and which may in the future jeopardize sustainable development of the biosphere on the regional and global scales. Many of the current environmental problems, including greenhouse gas warming of the atmosphere, acid rain and water pollution, are linked to technology via industrialization. In fact, technology is a major determinant of environmental evolution, environment being here considered as the complex of climatic, edaphic, and biotic factors that act upon an organism or an ecological community and ultimately determine its form and survival.

For this reason, attempts to understand environmental evolution must take technologies and their impacts into account. This means considering the future evolution not only of current technologies, but also of new ones. It is these future technologies and their impacts on the environment which are the subject of this report.

Future technologies constitute a vast field of study and in order to clarify ideas and to delimit our study, we shall present in Section 2 a technical summary of the different technologies which may develop and affect future environments. *These technologies, grouped into five categories, do not constitute an exhaustive list.* Nevertheless, our goal is to describe the possibly most important technological breakthroughs from the environmental point of view.

Next in Section 3 we shall present a classification of the environmental risks that new technologies may imply and an analysis of the interactions that may occur amongst and between the technological groups defined earlier (Section 4). Then in Section 5, we shall present a scenario for the future, which is to be viewed more as a vehicle for expressing certain ideas than as a probable future condition.

Finally, the environmental impacts of biotechnologies as applied to agriculture, will be developed in Section 6 which is specifically devoted to a deeper analysis of one technological group. We shall first analyze the effects that new biotechnological applications may have on the nitrogen cycle. We shall then place biotechnologies in a global context in order to determine which factors are most likely to cause biotechnological evolutions. Finally we shall consider biotechnology's positive and negative impacts on land use and the environment. We thus consider for a specific technological group, the political, economic and social factors that influence its evolution, and that determine, ultimately, its impacts on the environment.

2. TECHNICAL SUMMARY OF NEW TECHNOLOGIES AND THEIR POSSIBLE IMPACT ON ENVIRONMENT

2.1 Ecotechnologies

We define an ecotechnology as one which directly improves the environment. We have decided to focus first on these technologies because they symbolize a novel relation between technological development and the environment. For this reason, ecotechnologies have been defined in our work as a specific technological group, although it consists in technologies belonging to the other groups defined: biotechnologies, technologies utilizing new materials, energy technologies, or information technologies.

2.1.1 Types of Ecotechnologies

- **Cleaning technologies:**

"Cleaning technologies" are technologies which transform wastes and emissions to reduce pollution. We can identify two subgroups:

1. The first one includes all technologies which treat outputs. They are traditional ecotechnologies, such as catalysators in cars, or scrubbers in thermal power plants. The case of degradation technologies for highly contaminated sites is another example.
2. The second subgroup includes all technologies which treat inputs. A good example is the desulfurization of coal before combustion.

As Dr. E. Tommila (Confederation of Finnish Industries) has noted, that cleaning technologies do not diminish the total mass flow of substances ultimately released back into the environment. On the contrary, the total flow is often increased slightly by the purification chemicals used and thus, the cleaning technologies somewhat increase the consumption of natural resources.

- **Clean technologies:**

A "clean technology" is one which substitutes a less polluting process for a polluting one. These technologies are also called "substitution technologies". We can identify two subgroups:

1. Technologies which allow for the substitution of an input in a polluting industrial process by a new input. The substitution of chlorofluorocarbons (CFC) by another product is an example.
2. Technologies which produce less pollution than a traditional one. The fluidized-bed technology for thermal power plants is an example.

The aim of these technologies is to create lesser polluting industrial processes. The example of the novel integrated energy system (NIES) given by W. Häfele et al. (1986), illustrates this idea.

- **Recycling technologies:**

Recycling technologies treat the output of industrial processes. We can distinguish two types of systems.

1. Internal recycling of an industrial process, i.e., reintegration of a polluting output into the process. An example of this type of technology is the recovery of trace amounts of heavy metals by industry. Therefore, most energy saving technologies are recycling technologies.
2. External recycling, i.e., recovery of the output of a technology by another one. Plastic recycling is an example.

Contrary to cleaning technologies, the recycling technologies limit and decrease the consumption of raw materials and thus primary natural resources (Dr. E. Tommila).

We also distinguish between short- and long-term recoveries, linked to the process of consumption. A good example is given by Billen et al. (1984) concerning glass production. The consignment of returnable glass bottles is a short-term recovery process, and the recovery of glass in general as a raw material for industry exemplifies long-term recovery.

The environmental advantages of short-term recovery are greater energy savings, and substitution of a large waste management system for a simple one. However, the advantages of long-term recovery for the glass industry are currently controversial, and appropriate decisive strategies are not yet forthcoming.

Ecotechnologies involve a wide range of biotechnologies:

- *(a) Utilization of indigenous micro-organisms*
 - Acclimated bacteria: taking a sample of bacteria acclimated on wastes, developing the population (in laboratories) and reintroducing it on the waste sites to obtain greater and more rapid biodegradation.
 - Mutant bacteria: adapting bacteria to increasing concentrations of pollutants and then introducing the adapted bacteria in waste treatment sites.
 - "Bio-augmentation": introducing oxygen and nutritive elements in the wastes in order to allow the development of the total population of biodegrading micro-organisms.

(b) Mutations

Micro-organisms obtained by classical chemical mutations (UV or chemical mutagens).

(c) Recombined micro-organisms: Genetic engineering

Generally easier and less expensive than mutation, but presenting more risk to the environment. The ability to transform a selected bacterium to an adapted one.

(d) Metabolites

Conserving the micro-organisms in pilot laboratories and introducing only their products (enzymes, surfactants, and other metabolites) on waste sites.

• **Biotransformations are achieved through:**

(a) Aerobic processes (bacterial respiration)

The bacteria use atmospheric oxygen and decompose carbon-containing compounds to produce carbon dioxide. This process is used in all sewage treatment plants, for instance.

(b) Anaerobic processes

In the absence of oxygen, bacteria reduce carbon-containing compounds anaerobically. The process of fermentation is a familiar example, in which the bacteria produce a mix of methane and carbon dioxide. Anaerobic transformation is also called methanization. The materials may be degraded in a digester which produces energy. This process requires less space and energy, and produces less refuse than the aerobic process. This technology is beginning to be used for methane production as an energy technology.

The biggest problem with biotreatment is the need for a homogenous substrate. Some toxics, like antibiotics, or even plastics can stop the transformation.

2.1.2. Choice of ecotechnologies for a sustainable environment:

According to an OECD report in 1984 concerning the economics of environmental protection, ecotechnologies will play an increasingly important role. With the arrival of a post-industrial society, the importance of ecotechnologies will certainly increase, particularly recycling technologies.

European society suffers from many inertias. In the field of energy production, for example, large institutions block the development of small-scale energy production, that is more interesting from many points of view (profitability, adaptation, etc.). As Bongaerst and Kramer say, the dominant technology is always perceived as the best, and in this context, currently, a cleaning technology associated with traditional processes is often preferred to a clean substitution technology although the cost of the former is higher, and the system more complicated. A good example cited by Bongaerst and Kramer to illustrate their idea is the financial incentives to German research institutes, by which funding is always less for engineering studies of clean technologies than of cleaning technologies.

Analysis of technological impacts on the environment usually focuses on the output, rather than on the the entire system. Thus, the focus of public attention on environmental risks posed by new technologies, such as the biotechnologies, is skewed narrowly by downstream concerns.

Technical descriptions of particular ecotechnologies are given in Appendix A, which includes:

- Improvement of incineration technologies for treatment of toxic materials
- New chemical technologies for waste and toxic treatment
- Catalytic and non-catalytic processes of denitrification in thermal power plants
- Improvement of traditional water treatment systems for immobilization of micro-organisms
- Substitutes for chlorofluorocarbons
- Improvement of thermal power plant technologies: improved fluidized beds
- Plastics recycling and new plastic technologies
- Membrane processes: improvement of recycling technology
- Development of integrated systems: applications in ecotechnologies
- Advanced instrumentation
- Biodegradation of chlorinated organic compounds
- Improvement of traditional water treatment methods: adapted cultures
- Anaerobic treatment of industrial effluents: methanization
- Coal biodesulfurization
- Anaerobic upgrading of urban wastes: methanization

2.2 Biotechnologies (other than those conceived specifically to treat the environment)

Biotechnological methods and bioindustrial products find their use in diverse domains; health care and pharmacy; industry (mostly chemicals); agriculture and the food industry; production of energy; and environmental control and conservation. Although the new developments in each of these fields will have considerable social impacts, they are not so important in terms of environmental impacts.

The risks linked to biotechnological developments in the health care and pharmaceutical industries are essentially dangers linked to problems of confinement. It is the responsibility of the industries to ensure safe, well-controlled R & D testing of new, biotechnological products. Aside from that, the environmental impacts are minor, rela-

* Internationales Institut für Umwelt und Gesellschaft, Wissenschaftszentrum, Berlin

tive to those of other domains.

Biotechnological developments in the food industry present risks similar to those of the pharmaceutical industries, which are very well controlled. But they may also present second and third degree risks, typically implying subsequent agricultural and environmental change. The best example to illustrate this fact is the current micro-organism-derived proteins, which now compete directly with animal proteins (e.g. ICI in the U.K.). This evolution could imply a decrease in animal production of meat in the future. However, according to B. Schmitz (E.C. FAST program), qualitative factors have to be taken into account in future food production, whose orientation will become increasingly based on food quality.

Biotechnological developments in industry (mostly the chemical industry) have applications in other branches as well (energy, agriculture, waste treatment, new materials and even information). The biotechnological applications which may have an environmental impact will therefore be described in the presentation of these branches.

Biotechnologies are only part of the contribution to the development of new energy forms, which may have important environmental consequences because energy is related to every economic sector. Therefore New Energies and their possible impacts on the environment will be presented separately.

Similarly, technologies related to the improvement of the environment and to the treatment of wastes ("ecotechnologies") have been presented separately because they not only profit from biotechnological innovations, but also they represent a special category in the sense that, unlike other technologies, their purpose is directly related to environmental concerns.

Therefore, in this subsection *we shall develop exclusive technologies related to agriculture*, which are likely to bring great technological change in the future.

In agriculture, biotechnologies may apply in the future to plants as well as to animal production, in developed countries as well as in less developed countries.

These biotechnologies have different implications:

- First, application of genetically engineered crops may alter the agricultural focus in certain geographical regions. It may affect cultures by the development of normally cold-sensitive crops to colder areas, and may foster increase in yields and surface areas conducive to agriculture in Third World countries. Aside from the environmental consequences, biotechnologies applied to agriculture may result in considerable economic and social changes.
- Secondly, biotechnologies applied to agriculture may have an effect on the environmental release of pollutants. They may affect considerably the nitrogen cycle and the reduction of nitrate pollution. On the other hand, they may lead to an increase of ground-water pollution by pesticides.

Finally, biotechnologies present risks for the environment in the sense that the application of recombinant organisms may have uncontrollable consequences. For this reason, lobbyists in the U.S. are fighting against the release of engineered organisms (cf. Jeremy Rifkin in the U.S.). These protests will probably result in slower progression from the experimental to the application stage, but perhaps also, a greater awareness of the potential dangers and consequences, and a strategy to solve these problems.

Biotechnologies applied to agriculture involve

- utilization of indigenous micro-organisms;
- utilization of recombinant micro-organisms: genetic engineering;
- utilization of recombinant insects as well;

- incorporation of new genes in superior plants.

Technical descriptions of some of the main future biotechnologies applied to agriculture and of their possible impacts on environment are given in Appendix B. The technologies described include:

- Atmospheric Nitrogen Fixation
- Pest Biodegradation
- Herbicide Resistance
- Growth on Salinated Soils
- Anti-Freeze Bacteria
- Forestry Clonal Selection
- Animal Production

2.3 Energy Technologies

Novel energy systems are among the most controversial of the new technologies. This is mainly due to the effect of competition amongst new energy technologies which cannot easily be predicted.

Using historical analogies, it is clear that future energy technologies may benefit from important breakthroughs. Current technologies are bound to be replaced by others. As an example, many authors seem to agree that nuclear energy will not have its expected development. Oil may similarly lose its importance, although no consensus currently exists regarding which energy systems will replace it. According to R. Ayres of IIASA (personal communication) photovoltaics or methane (in the case of the discovery of more economically exploitable deposits) are strong candidates.

Energy technologies are often inter-dependent, thus limiting the number of possible scenarios for the future. The development of methane, for instance would very probably imply the development of methanol as a fuel. Similarly, photovoltaics could be coupled with superconductivity.

Technical descriptions of some of the main energy technologies are given in Appendix C. The technologies described include:

- Superconductivity
- New hydrogen uses
- Controlled fusion
- Improvement of drilling technologies: application to natural gas prospects
- Technologies of methanol conversion
- Utilization of nuclear energy for process heat: application to coal conversion
- Coal integrated gasification combined cycle
- Novel biological routes to biomass utilization

2.4 New Materials

Collaborative studies involving several scientific disciplines and technologies have transformed material science. The result is a greatly increased potential for materials substitution. Ceramics, plastics and metal alloys will play an important role in future materials in all industrial sectors: transport, construction, packaging, electronics, computers,

business equipment, medical supplies, etc.

Although the field of industrial applications is very diversified, those having direct or subsequent implications for the environment are more restricted. However, material substitution may have an impact on acid deposition (i.e. the reduction of SO_x and NO_x) mainly through the evolution of:

- road transportation
- electricity generation.

Moreover, road transportation and electricity generation are greatly related to energy consumption. New materials may therefore affect the energy balance of these sectors, and in this way, affect the environment.

Other substitution materials may also affect energy consumption in these sectors. This is the case for superconductors made from certain metal alloys, as well as ceramics and plastics. Although they represent a very important breakthrough for future energy consumption, we shall limit our discussion to a brief description of probable material substitutions in the automobile industry and in electricity generation.

However, it is important to keep in mind that all kinds of new materials (composite materials, electronic material, polymers, ceramics, carbon fibers, selenium, beryllium, phosgene) applied in very different fields can have environmental implications in the sense that they are usually highly sophisticated materials that will be difficult to recycle or to degrade.

Historically, material substitutions have been driven by economic and resource pressures. The rapid advances in this field of research are due mainly to the efforts of private firms. Environmental pressures have been secondary. Environmental policy analysis on material substitution lacks data and is therefore at a substantial disadvantage. The following questions merit quantitative analysis:

- How will the recycling processes be affected?
- What waste products will be produced by the replacement materials?
- How will nitrogen and sulfur oxide air pollutants be affected?

These questions will not however be discussed here, since we have chosen to develop mainly biotechnologies related to agriculture and ecotechnologies related to pollution and the degradation of wastes.

Technical descriptions of some developments in plastics and ceramics are given in Appendix D, which includes:

- High engineering plastics
- Engineering ceramics

2.5 Information Technologies

Microelectronics have already undergone rapid development and have led to the improvement of a great range of other technologies. Progress will continue, providing ever diminishing costs per computation, and thus allowing the use of computations at every step of industrial processing and technological applications (including new technologies as well).

Up to the last decade, the environment and micro-electronics were not closely related in comparison to other fields. However, the next stage of miniaturization, VLSI (very-large-scale-integration), is likely to affect greatly ecotechnologies and thus the environ-

ment. VLSI sensors will facilitate pollution control and thus improve the treatment of output wastes or recycling processes. Expert systems will more and more be coupled to these sensors to control and correct emission streams virtually instantaneously, even though the control may imply complex decisions.

Thus information technologies are likely to play an important environmental role in the coming decades. As stated at the O.E.C.D. International Conference on Environment and Economics in June 1984, "government action will be necessary to overcome industry's unwillingness and/or inability to develop and apply innovations in general - and environmentally related innovations in particular".

3. ENVIRONMENTAL RISK CLASSIFICATION

Based on the overview in Section 2 of environmentally-relevant new technologies, we now present a classification of the different types of environmental risks that these technologies imply. We shall try to classify risks according to:

- the potential importance of the environmental impact of the considered risk. By *importance*, we mean the capacity for greatly affecting the environment on a large scale.
- the ability to "control" risk. In our definition of this factor, we shall take into account the technical capacity to control technology in order to limit the risk. However, we shall also take into account the relative perception of environmental risks implied by the considered technology (the perception of scientists, politicians, and/or the public); this factor is at least as important as the insufficiency of the technical capacity. As an example, the risk involved in nitrogen fixation is typically a matter of public perception. Nitrogen fixation as a whole is rather favorable to a decrease in pollution of ground waters by nitrates. Only the case of contamination of straw by bacteria may imply the contrary (however to a lesser extent than chemical fertilizers). Since nitrogen fixation techniques have been considered altogether, little attention has been paid to the potential danger of contamination of bacteria by straw, although this may be one of the first techniques to develop because it is easier to realize scientifically. Also, nitrogen fixation may have uncontrolled impacts on crop migration. It is therefore important to capture the opinions of the different actors on the consequences of some biotechnical applications.

We shall propose the following subdivision of new technologies:

1. New technologies implying no or little environmental risk.
2. New technologies implying controlled risks - either technically controlled or likely to be taken into account in the development of specific legislation in order to limit their negative consequences. This category can be subdivided according to the importance of environmental risk:
 - 2.a important
 - 2.b relatively less important
3. New technologies which may cause subsequent uncontrolled environmental change. Again we can distinguish two types of risk:
 - 3.a important
 - 3.b less important

We shall give special attention to category 3.a., which has the highest priority for the environment. For these technologies it is important to develop a consciousness of the problem either in the political sphere or the scientific or public sphere if the problem implies long-term consequences (politicians may tend to concentrate on short-and middle-term problems). Nevertheless, categories 2.a. 2.b. and 3.b. will still have to be kept in mind in order to limit environmental risks linked to their development. Our qualitative assessment of the risks is given in Table 3-1.

Table 3-1: Risks associated with various technologies

TECHNOLOGIES	1.	2.a	2.b	3.a	3.b	RISKS
Nitrogen fixation	+				+	Risk of pollution of ground waters in the case of contamination of wheat straw by nitrogen-fixing bacteria.
Pest bio-degradation					+	Perturbation of biotope by pathogenicity for other insects as well
Herbicide resistance			+		+	Increased pollution of groundwaters; however limitation of the use of herbicides by legislation is likely.
Growth on salty soils		+				Little risk of expansion of salt tolerance to weeds.
Anti-freeze bacteria				+		Climatic and agricultural changes by uncontrolled bacteria released into the environment
Forestry clonal selection			+		+	Decrease of genetic diversity but over relatively small areas.
Animal production				+	+	Increase of soil compaction by larger animals. More manure implying water pollution by nitrate; however, environmentalists are already seeking solutions.
High quality engineered plastics					+	Increased pollution by plastic wastes. The importance of this environmental risk is linked to the development of degradation treatment, and recycling of highly sophisticated plastics.
Engineering ceramics	+					No risk.
Other new materials				+		Increased pollution by wastes. Incapacity of ecotechnologies in treating and recycling highly sophisticated materials.

Table 3-1: Risks associated with various technologies

TECHNOLOGIES	1.	2.a	2.b	3.a	3.b	RISKS
Information VLSI and expert systems	+					No risks; only benefits
Conversion of methanol into hydrocarbons					+	Risk smaller than for coal
Nuclear heat process for coal conversion					+	Risk smaller than for coal
Coal gasification					+	Risk smaller than for coal
Fusion			+			Risks linked to the utilization of hydrogen, however risk is less than with nuclear fission.
Hydrogen utilization		+				Explosion risk, but controlled.
Photo-voltaics					+	Massive solar reflection may imply climatic changes.
Biodegradation of chlorinated organic compounds				+		Uncontrolled release of bacteria in environment.
CFC substitutes			+			Risk of developing unstable, flammable or toxic substitutes.
Development of adapted cultures in effluent waters	+			+		No risks (if completely controlled in vitro); risks linked to the uncontrolled release of bacteria in vivo.
Stabilization of toxic wastes					+	The stabilization of toxic wastes may not be a proper environmental issue, since toxics are not degraded but only stabilized. Environmental danger could reappear later.
Other eco technologies		+				No or little environmental risk.

In conclusion, the new technologies which merit greatest attention in the future are summarized in Table 3-2. These technologies imply uncontrolled risks which may greatly affect the environment.

Table 3-2: New technologies with the greatest environmental risks

TECHNOLOGY	RISKS
Frost protecting bacteria	Climatic and agricultural changes by uncontrolled environmental release of recombined bacteria
High-quality engineering plastics	Increased pollution by plastic wastes.
Other new materials	Increased pollution by nondegradable wastes
Biodegradation of chlorinated organic compounds	Uncontrolled release of degrading bacteria released in the environment, and therefore possible degradation of substances other than wastes
Development of adapted cultures for the treatment of effluent waters	As above
Stabilization of toxic wastes.	As above

It is interesting to notice in Table 3-2 that only new materials and biotechnologies (applied to agriculture or to waste treatment) appear to have potentially uncontrolled risks with high environmental consequences. Information techniques are safe, and new energy technologies imply a reduction in current risks. Photovoltaics imply no major risks, superconductivity is a safe technology, and the risks of explosion and radioactivity linked to fusion are not comparable with the risks linked to current nuclear energy uses.

New materials are associated with risks for which no or little public perception has developed. Ecotechnologies have concentrated on the problem of degrading current pollution or wastes, with no anticipation of future problems.

As for the biotechnologies, public perception of the possible risks exists, but there is no technical capacity to control them. This is very understandable, since biotechnologies extend into a completely new domain.

Finally, it is important to consider *the type* of risks that biotechnologies imply. Environmentalists are most concerned about applications in which micro-organisms are released to the environment. The risk of indiscriminate spread is real, although researchers have tried very hard to limit this possibility. The goal is to develop micro-organisms that die once their substratum has disappeared. Monsanto Corp. has applied to the US

Environmental Protection Agency for permission to field test a system to track the distribution and survival of genetically engineered micro-organisms in soil (by insertion of a gene making them fluoresce under ultra-violet light). This technique does not resolve the problem, but it certainly permits a deeper understanding of the migration patterns of bacteria.

Meanwhile, risks exist not only with acclimated and mutant bacteria but also with recombined micro-organisms (e.g., adapted cultures for the treatment of wastes, or some techniques of degradation of chlorinated organic compounds). In this connection, mutant micro-organisms are less understood (and thus less controlled), than genetically recombined organisms for which only one specific gene has been deleted or introduced. Similarly, for crop production, variatal selection consists of inducing mutations which are not controlled, whereas genetic engineering treats only one gene of the whole genome of the plant. This difference is not understood by the Green lobbies (Jeremy Rifkins in the U.S.; the Green group in the European parliament etc.), which are fighting against recombined micro-organisms and plants. Genetic engineering will allow fantastic progress in the development of new varieties or strains. Such knowledge is not threatening. Rather, attention must be focused on the way that new varieties of plants and new strains of bacteria are released in the environment, and the way tests are conducted, for acclimated bacteria as well as for recombined organisms. If Green lobbyists focussed on these concern, they could contribute significantly to developing legislation to limit the real risks.

4. INTER-RELATIONSHIPS AMONGST TECHNOLOGIES

In Sections 2 and 3, we considered groups of new technologies as being rather independent from one another and we have related their evolution mostly to scientific advances and to the implied environmental consequences.

Of course many other factors influence the evolution of these technological groups. We can distinguish two types of relations:

- internal relations: influence of technologies on other technologies. These factors constitute what we call technology inter-relationships.
- external relations: these include the many factors which may orient, speed up or slow down, or, on the other hand, may be influenced by the application of new technologies. We have already mentioned environmental factors, either as a contribution to the development of these new technologies (example: growing public consciousness of environmental risk), or as a receptor of technological change (example: water pollution). There are of course many other factors: economic, social, political, etc.

We shall not consider external relations here. This is indeed a huge task, and in a subsequent Section, we shall cover only a small part of the field. viz., biotechnologies applied to agriculture. Here we shall focus on technology inter-relationships. The conclusion is that technologies need a systemic approach, and should not be considered individually in forecasting future prospects, even though they may relate to different fields.

The links between technologies are of two types: positive and negative, in the sense that the development of a technology (or group of technologies) may imply the development of other technologies (or a group of technologies); on the other hand, primary technologies may limit the development of other technologies. Examples:

- cleaning technologies may inhibit partly, the development of clean technologies if they are less expensive.

- VLSI systems and expert systems will certainly contribute to the development of the efficiency of ecotechnologies.

Inter-relations can also be at different levels. Based on our classification of new technologies having future impacts on the environment, we can distinguish between first and second level relations.

First-level relations are those that link directly one technological application to another. They can be due to several factors (incentives; technologic break-throughs in one field having application in another; competition) and they can link technologies of the same technological group or of two different groups.

Second-level relations are those that link one of the groups of technologies as a whole to a specific application of another technological group. Most of these relations deal with energy, which will affect a specific technology, no matter which energy system is employed. Information technologies may act in the same way, generally affecting a specific technology. The following examples illustrate these second-level relations. Ceramics in cars reduce energy consumption (no matter what fuel is used) leading to the development of alternate energy systems. Changes in energy costs (no matter what energy form is used) affect the fertilizer industry competing with nitrogen fixation technologies, and have an impact on biotechnology R and D in nitrogen fixation.

Table 4-1 illustrates the interrelations existing amongst technological groups. The table does not consider all of the individual relations. Rather it attempts to present a broad, general view, within which individual relations could be located.

	Ecotech. -Cleaning tech. -Clean tech.	Biotech. Applied to Agriculture	New Materials	Energy	Information
Ecotech.	+Internal influence ++Clean techs are in fact competing with cleaning technologies. Clean techs are the best ecological solution. Unfortunately, cleaning techs are often preferred for economic reasons (lower investment, over short term).				
Biotech Applied to Agriculture	++Greater development of biotech may imply less agricultural pollution (nitrates and pesticides in groundwater) and therefore agriculture may require less cleaning technology for pollution of groundwaters	++Internal influence		++Utilization of agricultural wast for production of renewable energy (biogas).	
New Materials	++Some new materials may also be considered in their application as clean technologies, since they may represent a substitution for a polluting technology (cf. ceramics in cars). On the other hand, new materials may also imply new sources of pollution requiring further development of ecotechnologies for the treatment and cycling of wastes		+Internal influence	++New material play an important role in decreasing consumption	
Energy	+Energy substitution may favor clean technology. A good example is methane and CO_2 emissions.	++New forms of energy or improvement of current energy systems may cause traditional agricultural fertilizers, pesticides and herbicides to compete with biotech (less energy consumption implying reduced costs)	+New forms of energy may favor specific new materials	+Internal influence	
Information	++VLSI and expert systems will improve cleaning technologies and efficiency	+Information will be applied all industrial processes (to a lesser extent).			+Internal relation

Table 4-1 Inter-relations amongst technological groups:
 + = strong influence
 ++ = very strong influence

5. PROPOSED SCENARIO FOR THE FUTURE

5.1 Introduction

On the basis of the considerations outlined in Sections 1 – 4 and having read the studies of numerous authors, we shall now draw up a possible future for Europe in general, and of the environmental context in particular, in the XXIst century. Because of the complexity of the question, our results will be qualitative, and will focus essentially on the environment.

Our scenario will not be a prediction; nor is it to be considered in terms of probability. It is only a description of one possible future among others, which we think interesting to elaborate.

We must note that the energy part of our scenario is inspired by Long Wave Theory (Marchetti, 1981) and by the work of Häfele et al (1986). We are aware of the controversies generated by these authors.

Here we should mention that even though current perceptions of environmental problems and efforts to cope with them have been developing at every level (from research to industry or even to society as a whole), and even though prognostic studies have been developing during the second half of this century, society is interested, not in trying to anticipate environmental problems, but rather in resolving current problems and projecting these results into the future. This is of course a necessary approach, but anticipation may be a key to longer-term environmental solutions.

5.2 The Third Wave Scenario: A Healthy Society in a Healthy Environment

5.2.1 A New Energy Order (1990 – 2010)

The scenario hypothesizes that by 1990 to 2000 a new energy order will have been established in Europe as a consequence of technological changes.

OIL: Oil consumption will have stabilized at between 30 and 40 % of global energy consumption. In 2010, oil will represent less than 30 % of primary world energy use. The oil will be used mainly in the transport sector essentially for the production of gasoline, which will remain the most widely used fuel for car engines.

COAL: As a result of strong environmental policies relative to pollutant emissions, coal-derived thermal power plants will have been transformed into coal gasification plants. Due to the implementation of European environmental laws, the development of new boilers and fluidized-beds will have preceded the establishment of large coal gasification systems. After 1995, the production of synthesis gas from coal will be associated with the heat producing nuclear process. In Europe, especially northern Europe, this transformation is assumed to be a great success until 2025. However, the market share of coal will have decreased because of the increase in the mining costs for coal. (The quality of European coal is low and the European trade balance does not allow massive import of coal.) After 2010 the use of coal is assumed to decline representing less than 12% of the world consumption.

NUCLEAR: During the 1990's, nuclear energy will have stabilized at under 3% of world consumption, because of a strong antinuclear sentiment among Europeans due to Chernobyl. Also Europe will have experienced a saturation of energy production because of the development of energy-saving technologies and renewable energies in the context of oil

price stabilization. Two important changes will then take place.

- First, the association of the nuclear heat process with coal conversion will allow development of a second generation of nuclear reactors in 1995.
- Secondly, numerous problems with the first experimental French supergenerator "Super phoenix " will have delayed construction of a nuclear fuel reprocessing plant. By year 2000, in spite of ecologists' protests, the first commercial plant will be functioning. Consequently, the share of nuclear energy will increase reaching 7% of global world consumption at the end of the century.

METHANE: Up to 2000, methane consumption in Europe will increase, due to the utilization of Soviet and Algerian methane, and the improvement of political relations between the two blocks in Europe. After 1990, the development of mining technologies will allow deep drilling. The large Swedish layer will be exploited and, in 2002, the discovery of an Alpine layer will make possible a methane revolution in Europe. Consequently, by 2010, methane will represent 42% of global energy consumption.

Biogas Development:

The production of good quality gas (80% CH_4 and 20% CO_2) will lead to its utilization in various domains:

1. By the beginning of the 1990s, production of methane by adaptation of landfill technologies will have developed. However, landfilling is associated with numerous environmental problems:
 - Pollution of ground and surface waters,
 - Occupation of large spaces in the town suburbsBy year 2000, urban wastes will be treated by large bioreactors, which produce biogas and steam for heating.
2. Many "micro-energy" centers will also develop in the countryside. Depending on farmers' activities, these bioreactors will transform: forestry wastes, starch, pig manure, and other by-products of agriculture. These technologies will be highly developed not only in southern European countries but also in Ireland and Denmark.
3. The treatment of industrial effluents, especially in the agrofood industry will be largely developed and will also produce biogas as a by-product.

These three uses of bioreactors applied to waste disposal will have been induced by the development of biotechnologies designed for other applications. First, the development of microorganism immobilization will allow the improvement of yield in biotransformation. Secondly, the applications of microelectronics and measuring instruments to the monitoring of bioreactors will play an important role.

As a consequence of the development of biogas production, a new market will have been created, and prices will be linked to the prices of other energy sources. Although, these prices will be insufficient to meet the cost of production, they will reduce the cost of waste treatment which will have become an environmental necessity. A new economic term will be used: "cost of wastes", and a market for wastes will have been created (as a raw material market), although obviously the "prices" are negative, corresponding to the cost of treatment. A waste market will be created by the E.E.C. Commission: "Environment, Public Health and Consumer Protection".

The development of biogas production will allow the use of energy instead of waste production. However, the quality of Biogas will not be sufficient for large-scale applications. During the same period (1990 - 2010), biofuel will be produced in Europe from agricultural surpluses. In Ireland, Sweden and France, lignin transformation will allow production of important quantities of methanol, from wood refuses. A Franco-Italian

cooperative effort will have begun fabrication of ethanol from sugarbeets and grapes. However, the area of land dedicated to biomass production will not yet be large. The production costs will still be too high, in comparison with the prices of other energy resources. This explains why energy production will be applied only to refuse (principally agricultural refuse).

Solar Development

Due to an increase in industrial production, the price of amorphous silicon solar cells will have decreased during the decade preceding 2000. This will foster the development of cost-competitive solar-energy systems. In spite of a low yield of transformation of solar energy (15%), the utilization of the cells will become feasible for European householders. However, the hopes developed at the beginning of the 1970s will not be realized at the beginning of the XXIst century.

With the introduction of these new technologies, energy systems will evolve, and renewable energies will represent a market share of 7% of the global energy system.

In conclusion, these two evolutionary decades will be characterized by:

- *The development of energy saving technologies:*

The development of the new technologies will allow a noticeable decrease of energy consumed per GNP. The main technologies are:

- Development of recycling technologies, which implies a change in the energy consumption of industries (steel, glass, paper and plastics.)
- Application of sophisticated micro-electronics for control and monitoring of energy consumption .
- The new car technologies: each car will consume half as much fuel as in 1990. The improvement of car construction (utilization of plastics) will lead to a decrease of weight. The utilization of new materials (ceramics) will permit high combustion temperatures.

- *A novel integrated energy system*

As Häfele et al (1986) had foreseen in 1986 in the book "Sustainable Development of the Biosphere", a " Novel Integrated Energy System" will have been established very close to the model he had proposed, except for methane for which the consumption will have increased much more than they expected. The primary fossil energy inputs will be purified before combustion, especially in the case of coal. However, due to the increase in methane production, and renewable energies development, other conversions of energy will now be possible. We can represent the system in 2010, with an adaptation of the Häfele et al model shown in Figure 5-1.

The energy independence of Europe will become higher than in the 1970s. The development of a large variety of energy sources for the European market will have improved the independency of Europe from a strategic point of view. However, the increase in methane consumption could increase dependence on the biggest suppliers.

5.2.2. Subsequent energy developments (2010 – 2030)

The trends established during 1990 - 2010 will not change significantly in the years 2010 - 2030. Oil and coal consumption will decrease while methane will become increasingly important, and the methane industry will diversify. Nuclear and renewable energies will develop very slowly.

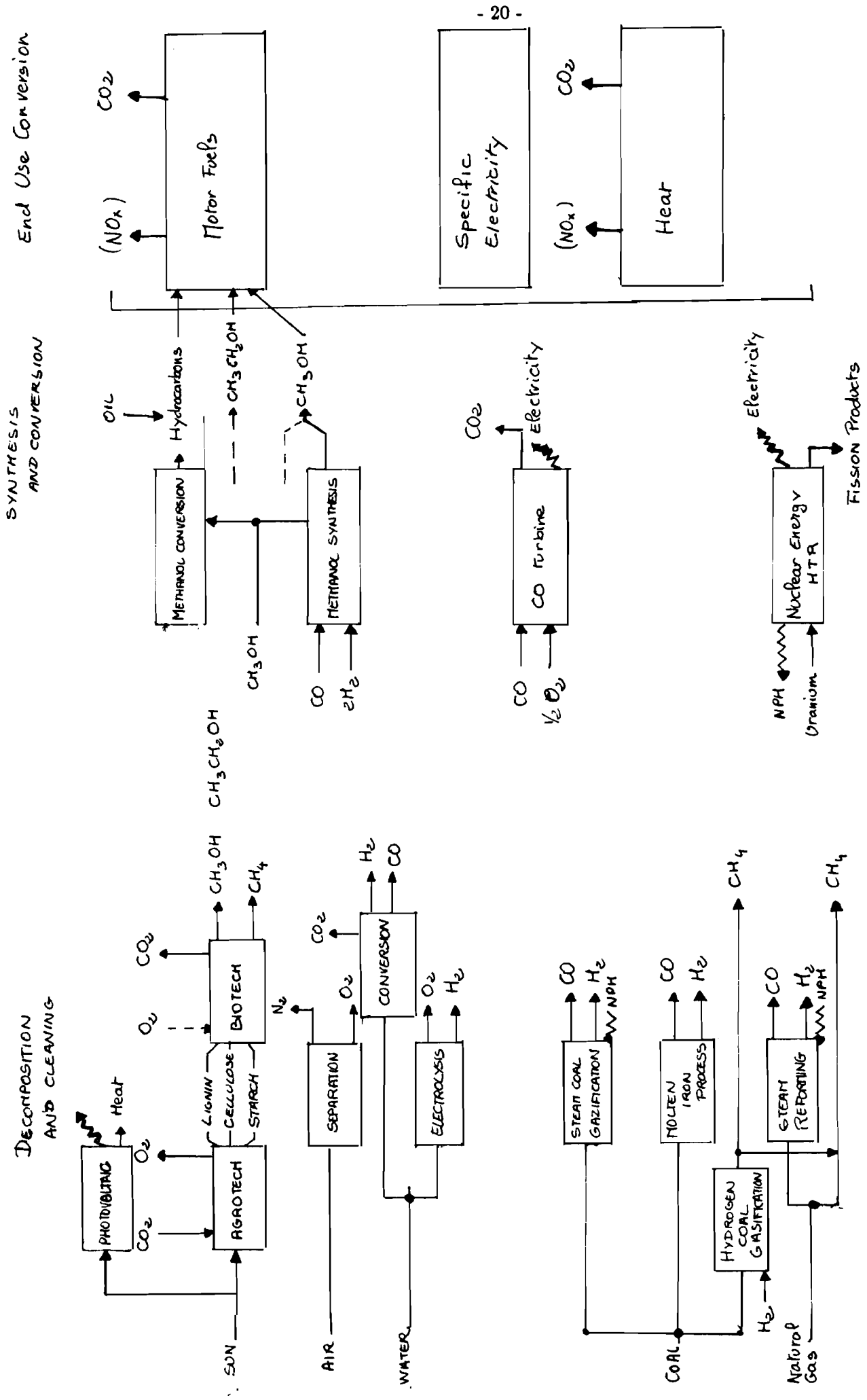

Figure 5-1: The New Energetic System.

The development of a new secondary fuel: Hydrogen.

One of the most important changes, after 2010, will be the development of engines fueled by hydrogen. In the forefront will be high-speed aircraft, which will utilize hydrogen as an engine fuel. By 2030, ships and trucks will also use hydrogen, although automobiles will still depend on gasoline. Methanol and ethanol fuels will not yet replace oil in automobiles, as some had forecast at the end of the 20th century. (Hydrogen will be produced from methane, which is the most economic source.)

Development of electricity production.

Electricity will become more and more important, as a secondary energy source in Europe. Various technologies will be developed after 2010. One of the most interesting will be superconductivity, which allows transportation of electricity over long distances (beyond 1000 km). Hydrogen transport is also an indirect way of electrical transmission. Some competition for electric storage is to be expected; storage by superconductivity will be very expensive, while hydrogen storage will be subject to dangerous explosions.

5.2.3 A Recycling Society

At the end of the 1980's, the situation regarding accumulation of wastes in Europe is not critical, but is worsening. Year by year, the quantity of refuse produced per person steadily increases (5% per year). During the 1990's, the scenario suggests that in the context of "ending the crisis", rather than "changing consumption patterns", efforts will be concentrated on treating municipal and industrial wastes. Other factors will also hasten the arrival of a "recycling society":

- The necessity of conserving energy.
- Scarcity of space for landfills, especially in the Netherlands and West Germany, and the necessity of a new system to diminish the wastes.
- A greatly increased awareness of the importance of the European forests (probably a consequence of the environmental lobby)
- A large diversity in the material choice for packaging and development of plastics.

The birth of the recycling technologies.

On the basis of a Japanese model, the Netherlands will become the first in Europe to adopt a system of household waste separation at the consumer level. In addition to traditional glass and paper recovery, plastics will also be separated from other refuse for recycling. All plastic bags will be replaced by biodegradable paper bags. Due to the rapid development of fast food restaurants in the second part of the 20th century, a "Fast Food Act" will be imposed in 1995 on the use of specific recyclable materials for food packaging in the fast restaurants and supermarket chains. This regulation will foster the development of new materials for packaging, and a new biodegradable plastic will be invented. The development of research in biodegradation of plastic components will be coupled to utilization of specific bacterium to treat specific kinds of plastics.

Economic importance

Between 1990 and 2010, ecotechnologies will become very important in economic terms. New firms, specializing in water treatment, will develop their own subsidiaries in the field of the biotechnologies applied to environmental improvement. The transformation of wastes (urban, agricultural and industrial) into large quantities of biogas will play an important role in energy systems. Also, waste transformations will reinforce the

influence of local communities, and will foster energy autonomy in these communities.

The development in biotechnologies will allow development of large-scale environmental technologies. Bacteria utilization will be associated with high incineration technologies (used only in special cases). The main strains will come from numerous North American firms. The high specificity of bacterium to degrade particular chemical components (usually PCB or hydrocarbons) will allow rapid treatment of heavily contaminated sites. The utilization of bioreactors will preclude the spreading of bacterium. Therefore by 2010, after the elimination of the chemical substratum, bacteria will not be able to survive.

5.2.4 Society: 1990 – 2030

At the international level, the scenario suggests the emergence of an economic pole in the Pacific Zone (Japan, China, South East Asia, California, India). However, this does not imply a decline of Europe and of the U.S., but rather an autonomous coexistence of the different poles.

Large-scale cooperation between the economic powers will be directed at fostering environmental sustainability in developing countries, although the economies of these countries will remain weak. In fact, developing countries, and especially Africa as a whole, will have "skipped" the Industrial Revolution. They will still be dependent on international aid, although the food deficit situation will become greatly mitigated because:

- birth rates, although still high, will decrease.
- new agricultural techniques will be introduced by technology transfer from developed countries (DCs) to less developed countries (LDCs.) Crops will grow in salinized soils where vegetation is possible, and, most important, nitrogen fixation will not only permit increased crop production, but also lead to soil structure improvements. Moreover, nitrogen fixing trees will have limited, although not stopped, the rate of erosion.

The economic situation in LDCs will nevertheless remain critical, even though food autonomy will have increased.

In Europe the collective perception of environmental degradation in the late XXth century will not only lead to a greatly increased recycling effort with a large decrease in the quantity of wastes, but also to a general revitalization of highly industrialized areas.

According to the scenario, human migrations from LDCs to DCs in the 21st century will diminish due to less demand for workers owing to increased computation and robotization.

The population of the large European cities will decline. One reason is the fact that factories will become smaller and decentralized, their production processes being suited to rapid changes in the product line. The concentration of large industrial plants in particular regions will be less. These units can adopt new technologies fairly rapidly, contain costs better, and also respond with more flexibility to the numerous environmental standards which will have been imposed.

Living conditions in cities are expected to improve greatly in the next 50 years. The scenario suggests that in 2010, cars will be prohibited in urban centers by an European Automobile Convention. Thus pollution and noise will decrease, and urban parks will be greatly expanded. Due to the improvement of information networks, many people will work at home. This, plus the fact that the industrial network will be more diffused, will lead to a large reduction in commuter traffic.

Information technologies will penetrate agriculture as well, impacting both agricultural production, and possibilities for part-time employment opportunities. In fact, the average rural agricultural population will stop decreasing in the late 1990's, and may even increase slightly, agricultural workers stabilizing at 4%. In agriculture as well as in industry the tendency towards bigger units will have reversed. There will be in fact two types of farms: large farms, in existence since the 20th century, that have managed to adapt to the changing economic realities; and small-scale farms, that have thrived and are sustaining the agricultural population. This will be possible by the increased economic yield of crops and animals due to biotechnological innovations, and by the systematization of home employment with the development of information technologies. Most of these agricultural units will stand separately or in small clusters and will be energy independent because of the recycling of wastes. The problem of agricultural surpluses in Europe will have been largely solved, although the saturation of the international market will have led to decreased exports from Europe. This will be due to:

- a reduction in productivity to some extent, due to the reduction in farm scale, and to agricultural innovations which have reduced the productivity of some crops without affecting farmers' revenue.
- migrations of cereal-growing areas from the north of Europe to the south (nitrogen fixing wheat is more sensitive to northern climates). Fruits and vegetables, very well adapted to small-scale farms, will have partially replaced cereals, since they are no longer vulnerable to spring frosts due to the use of frost-preventing bacteria.
- and mainly, a reduction of the total area of agricultural production. The areas that have gone out of production will be partly rehabilitated by natural parks, and partly abandoned.

This important evolution of agriculture will be brought about by implementation of effective policies at the farm level. These policies will enable small units to prosper, thus avoiding a drastic decrease in the total agricultural population, which will be socially unacceptable. Moreover, technological evolution will make possible the reduction of total agricultural area and productivity, while at the same time increasing farmers' incomes by decreases of costly inputs.

Moreover, agriculture will no longer cause drinking water pollution by pesticides and nitrates, and ecotechnologies will be commonly developed and very well controlled, even in natural sites.

With the increasing substitution of traditional fossil energy sources (coal and oil) by natural gas and non-fossil energy sources (methane, nuclear and renewable energies), the hydrogen-to-carbon (H/C) ratio will increase and the CO_2 emissions per unit of energy consumed will decrease. (See Table 5-1). This explains how the energy infrastructure will have resulted in a decrease in CO_2 emissions to the atmosphere.

Table 5-1: The hydrogen-to-carbon ratios for different fossil energy sources

Primary Fossil Energy	H/C Ratio
Wood	0.1
Coal	1
Oil	2
Gas	4

Another improvement of the energy system, as suggested by Häfele et al, will be SO_x emissions will have been eliminated, because of the substitution of traditional coal burning by coal gasification. A decrease in NO_x emissions will also be a consequence of this technological substitution.

The decrease in NO_x emissions will also be related to the discovery of new automobile engines, without catalytic converters. The increase in the ratio GNP/energy consumption will also favor decreased pollutant emissions.

Information technology and generalized robotization will result in a decrease in jobs in the industrial sector. On the other hand, Europe's stable economic growth in the first quarter of the 21st century will permit the development of a very diversified service industry. Culture and cultural activities will be emphasized in the new society, as well as quality of life. On almost all levels, the period 2010- 2030 will be an optimistic one in Europe, although a rising proportion of the population will not profit from the economic growth.

5.2.5 The Environmental Turning Points

Europe is expected to enter the second half of the 21st century in a very optimistic setting. In the framework of a greatly improved environment, environmental protection will become less and less a political issue, and the Greens will disappear as a political force. However, this de-emphasis of environmental concern will mask new, coming problems.

The rate of greenhouse gas accumulation in the atmosphere will continue to increase due to the increasing use of methane. While the rate of increase will be less than in the 20th century, the impact on climate will certainly be the same. Thus, the societal dilemma of adapting to climate change will continue.

The scenario projects that alternatives to CFCs will be developed in the 1990's, but methane emissions will become a major threat to stratospheric ozone depletion in the 21st century.

Finally, unsolved problems relating to new wastes are expected to appear. Ecotechnologies will reveal themselves incapable of degrading highly-durable engineering materials, and the accumulated wastes will contribute to new forms of land and water pollution.

5.3 Concluding Remarks about Scenario Construction

In conclusion, we may highlight some general ideas concerning the role of technologies in constructing scenarios:

- Firstly, the inclusion of a technological dimension is essential when considering long-term evolution. New technologies will be a major factor in determining tomorrow's world, especially in relation to the environment.
- Secondly, long-term evolution is not linear; breakthroughs will undoubtedly emerge as they have in the past. Scenarios have to integrate these breakthroughs, not only up to the end of this century, but also into the next.

6. BIOTECHNOLOGIES AND AGRICULTURE:

6.1 Possible Impacts of Atmospheric Nitrogen Fixation

6.1.1 Description of the biological transformation:

Plant metabolism involves the essential nutrient *nitrogen*. Plants can assimilate nitrogen in the form of nitrate or ammonia, but cannot directly absorb and use the nitrogen gas that constitutes 80% of the atmosphere. However, some bacteria are able to oxidize nitrogen to nitrate, called nitrogen fixation. Nitrogen reduction is activated by nitrogenous enzymes, which are synthesized by nitrogen fixing organisms as illustrated in Figure 6-1.

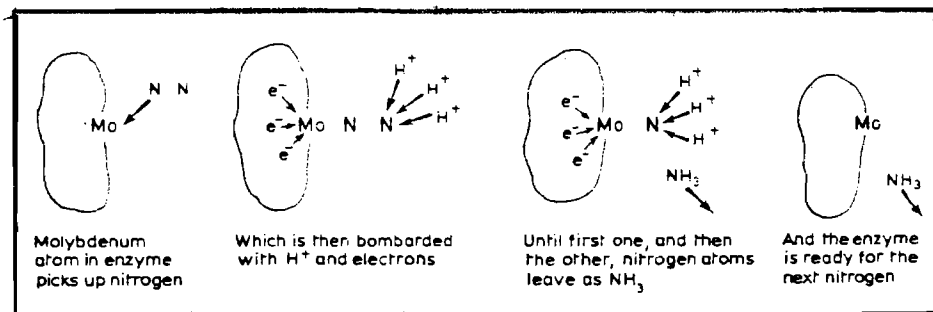

Figure 6-1: The role of enzymes in nitrogen fixation

Nitrogen fixing organisms can be symbiotic (e.g., rhizobium-legume association), or free (e.g., cyanobacteria). The high energy requirement is the reason for the predominance of symbiotic and photosynthetic systems. In specific plants such as the legumes, symbiotic nitrogen fixation occurs in plant nodules. Bacteria benefit from the plants' glucides and the plants benefit from a supply of assimilable nitrogen. The non-legume fixation used in agriculture is mainly fixation by cyanobacteria in rice paddy fields, either free or in association with *Azolla*.

6.1.2 Utilization of biological nitrogen fixation in agriculture

Nitrogen fixation has been exploited in agriculture since antiquity. The Romans rotated legumes and non-legumes in their agricultural system. In China and India, blue algae were added in rice paddies in order to stimulate nitrate production by cyanobacteria. Increasing knowledge of the nitrogen fixation mechanism, and discoveries of existing symbiosis continue to lead to agricultural innovations, especially in the Third World where farmers cannot afford chemical fertilizers. Finally, varietal selection will lead in the future to an improvement of the existing symbiosis.

6.1.3 Nitrogen fertilizer and environmental concern

Nitrogen is lost from soils due to the processes of nitrification, denitrification and leaching. In natural ecosystems, fixed nitrogen supplied by bacteria and rainwater balances losses. But the development of high yielding crop species has imposed a large increase in fixed nitrogen. The problems linked to the utilization of nitrogen fertilizer are the following:

- The industrial Haber-Bosch process used to reduce nitrogen to ammonia ($N_2+3H_2\rightarrow 2NH_3$), is highly energy consuming; the increasing demand for nitrogen fertilizer will increase the rate at which costly non-renewable sources of energy are depleted.
- The industrial process of nitrogen reduction produces large quantities of air pollutants.
- The nitrogen contained in fertilizers is in the form of mineral compounds directly assimilable by the plant. Excess amounts, however, leach rapidly from soils, causing serious concern in different parts of Europe because of the increasing concentrations of toxic nitrates in drinking water supplies, and the eutrophication of lakes and rivers.

6.1.4. Future trends and biotechnological applications

Biotechnology firms and research institutes have been working on the improvement of the existing symbiosis using several methods, such as novel inoculation procedures. Considerable effort has been devoted to the identification of strains of rhizobia with broad host plant specificity (e.g., *Rhizobium Lupini/Lupin*), and to improving legume inoculants to ensure survival of rhizobia after introduction into the soil.

Further prospects relate to the possibility of transferring the benefit of nitrogen fixation to other plants such as cereals. This would imply a considerable change in agriculture, through lesser use of nitrogen fertilizer, and great benefits from the environmental point of view. Research teams are studying two different possibilities:

- Creation of new symbiosis with higher plants.
- Direct fixation of nitrogen by agricultural plants; i.e., introduction of the nitrogen fixation capacity into plants' genomes.

Other prospects concern the development of specific strains of nitrogen fixing micro-organisms on straw as a carbon source. Research is being undertaken with *Cellulomanas* sp. and *Azospirillum brasilens*. Developments of such methods would contribute to fertilizing the soil without chemicals. But it would not resolve environmental problems, since the liberated nitrogen would be in an easily leachable mineral form.

6.1.5 Creation of new symbiosis - state of the art and controversies over future prospects

The creation of new symbiosis between superior plants and nitrogen fixing organisms is a delicate operation which implies the resolution of many problems still unsolved. The development of efficient nitrogen fixing micro-organisms is a multistep process requiring the genetic input from both the legume host and the bacterial symbiant. According to C.A. Parker (1986), proposals to put nodules on cereals are naive. The root cortex of

cereals is ephemeral, so nodules cannot be produced there. According to him, only dicots might be persuaded to nodulate once the processes of infection, nodule formation, and compatibility are understood. Other researchers are more optimistic about the idea of nitrogen fixation by crop plants such as cereals. Embrapa, Brazil's agricultural research center, has isolated micro-organisms in soil that allow grasses such as maize, sugar cane and wheat to fix nitrogen. A strain of bacterium known as Azospirillum has been found to infect roots of wheat and sorghum and increase nitrogen fixation when there is little nitrogen or few other strains of bacteria in the soil. Of course the nitrogen fixation rate is far lower than with legumes, but Embrapa's research is aiming at making the bacteria more efficient. According to M. Redford (New Scientist, 2 Aug. 1985) research teams are studying other soil bacteria that tend to stick to plant roots. Perhaps these sticking bacteria could be given Rhizobium's fixation genes. S. Long (Stanford University) considers that research programs may be developed for cereals as well. Most optimistic of all, scientists at Monsanto predict that nitrogen fixation bacteria will be routinely incorporated into crop plants within 10 years (New Scientist, Feb. 1987).

6.1.6 Direct fixation of nitrogen - current state of the art and controversies over future development

Many difficulties need to be overcome to attain this objective. The major problems linked to the incorporation of a nitrogen-fixing capacity into the plant's genome are the following:

1. the demand of the nitrogen fixing system for anaerobicity
2. the demand of the nitrogen fixing system for low potential electron donors
3. the high energy requirements, which would have to be fueled by the metabolism of plant carbohydrates, resulting in yield loss.

For M. Redford, C.A. Parker (1986), and Z. Harsanyi (Porton International); these obstacles rule out genetically engineered nitrogen fixation into plants. According to Dixon and Wheeler (1986), it would be foolhardy to attempt to predict what will be possible or impossible in a few years. However, new research paths are opening in response to the problems mentioned above:

- engineering a nitrogen-fixing mitochondrial system, since mitochondria do have the respiratory activity necessary to maintain their interior in an aerobic state. Of course this hypothesis brings up new problems of transferring DNA into the mitochondrial genome, which has not yet been achieved. The transfer would involve *nif* genes, and also genes for electron transfer for metabolites.
- another possible research path may be creation of enzyme structures that are less sensitive to oxygen.

As for the high energy requirement, B. Sikyta, E. Avlosova, and E. Stejskalova (1986) remark that bacteria of the genus *Rhizobium* produce hydrogen as a byproduct in the fixation of atmospheric nitrogen. Since these bacteria do not synthesize deshydrogenase, they lose 30-40% of the total energy. Recombinant techniques make it possible to introduce gene coding into these bacteria for the synthesis of deshydrogenase (*hup* genes) which enables these organisms to utilize the produced hydrogen partially and increase the efficiency of nitrogen fixation.

Thus further research paths are open, making some researchers optimistic. The European Community's FAST program estimates that the application of direct nitrogen fixation by cereals will take place within 10 to 15 years. According to T. Lavoux (1987),

INRA (France's national agricultural research center) expects a rather longer delay before the application stage.

6.1.7 Further remarks

The future of nitrogen fixation is controversial (the most controversial of all biotechnologies applied to agriculture), especially for cereals which have proved hard to manipulate genetically. Meanwhile, researchers come up with new results, and a broader and deeper understanding of nitrogen fixation. Genetically engineered nitrogen fixing microorganisms are being tested for association with alfalfa. The Japanese National Institute of Genetics in association with the University of Tokyo's Institute for Applied Microbiology have been able to raise the nitrogen fixing capacity of bacteria and have used this to achieve substantial improvements in rice plant growth. There is no doubt that further research will result in more progress. Cereals will probably be the last to benefit from this technology. Our aim is not to quantify the chances that cereals will fix nitrogen in the future, nor to forecast a date at which this might occur. Scientists have developed no consensus over this matter, so it would make no sense to do so.

What we can do, however, based on the fact* that many scientists do expect that nitrogen-fixing cereals will be a reality in the future is to construct a scenario describing possible effects that nitrogen-fixing agricultural crops would have on the nitrogen cycle. This work has been conducted in association with another IIASA 1987 YSSP study focusing on the future evolution of the flow of nitrogen (Souchu and Etchanchu, 1987).

Figure 6-2 displays the nitrogen cycle in the agricultural ecosystem in 1984 as an average for Europe. Figure 6-3 is a projection of this cycle for the year 2010, based on current trends of input, consumption, and productivity in agriculture, but modified by the hypothesis of generalized nitrogen fixation by agricultural crops (no more synthetic fertilizer input).

We thus obtain a scenario for nitrogen fluxes in the case of generalized nitrogen fixation by agricultural plants. Of course, it is an extreme scenario, perhaps too optimistic in terms of the relatively short period of time for penetration of this technology into the agricultural sector. Nevertheless, it may serve as a limiting case for what is possible in the year 2010.

Given the hypothetical nitrogen cycle presented in Figure 6-3, we may discuss the various societal implications:

- firstly, there will be energy and economic implications because of the high energy requirements for synthetic fertilizer production, and the impact on firms producing chemical fertilizers
- secondly, there may be ecological implications because of the great problem of overuse of synthetic nitrogen fertilizers and their leaching into groundwaters on a continental scale.

The second implication, however, must be tempered by two remarks. The first is that we have considered only a large-scale approach. Locally, manure may be responsible for the greatest part of the leaching (e.g. cattle breed-lots in the Netherlands). However, according to D. Etchanchu and P. Souchu, there is a linear relation between the input of chemical nitrogen fertilizer and total leaching. Hence, we may infer that in most parts of

* In a DELPHI study undertaken in 1981 by the School of Urban and Public Affairs at the Carnegie Mellon University, USA, the most frequently mentioned breakthrough in the agricultural sector was the nitrogen fixing process.

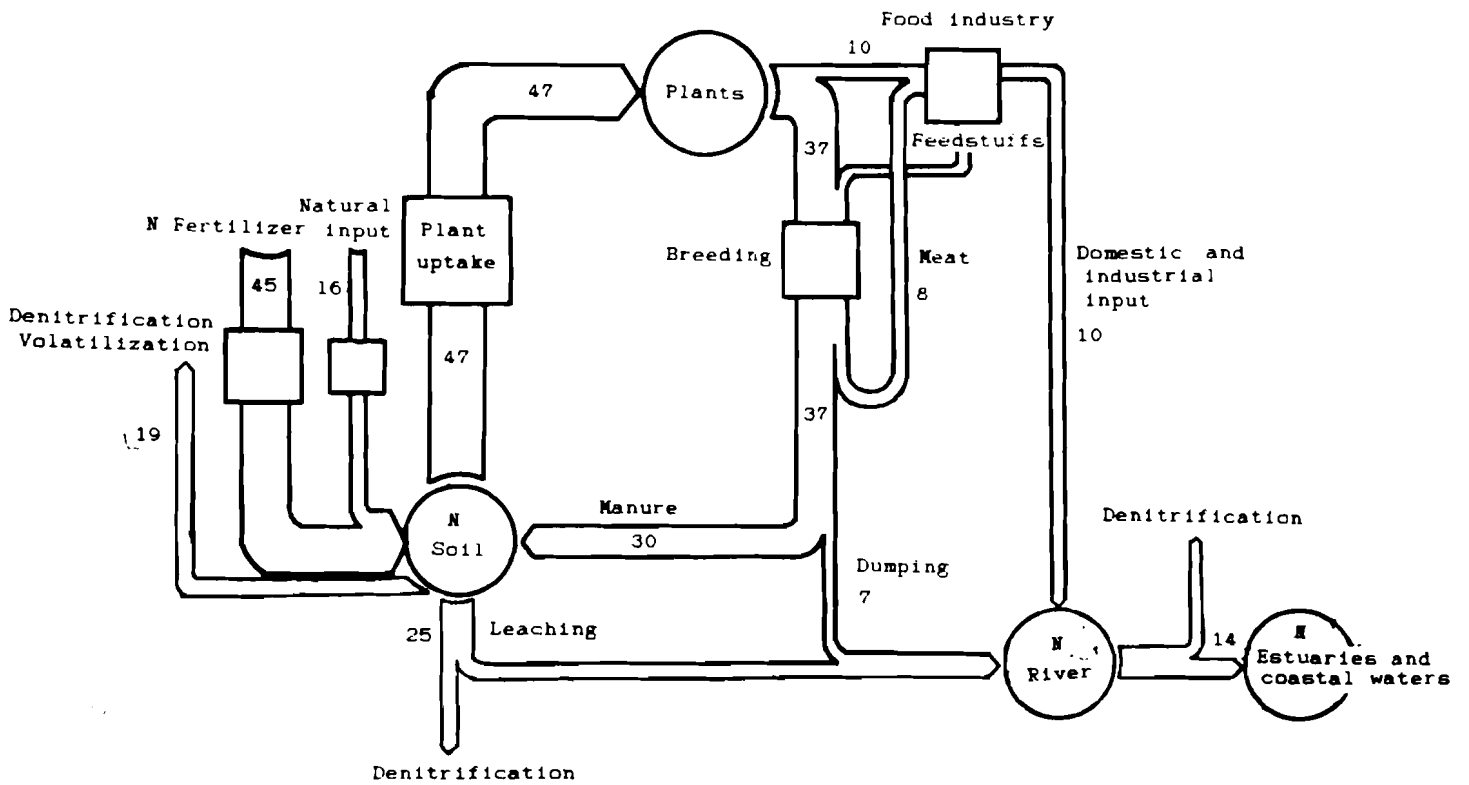

Figure 6-2: Nitrogen cycle in Europe in 1984 in $\text{kg yr}^{-1} \text{ha}^{-1}$ (of total area).

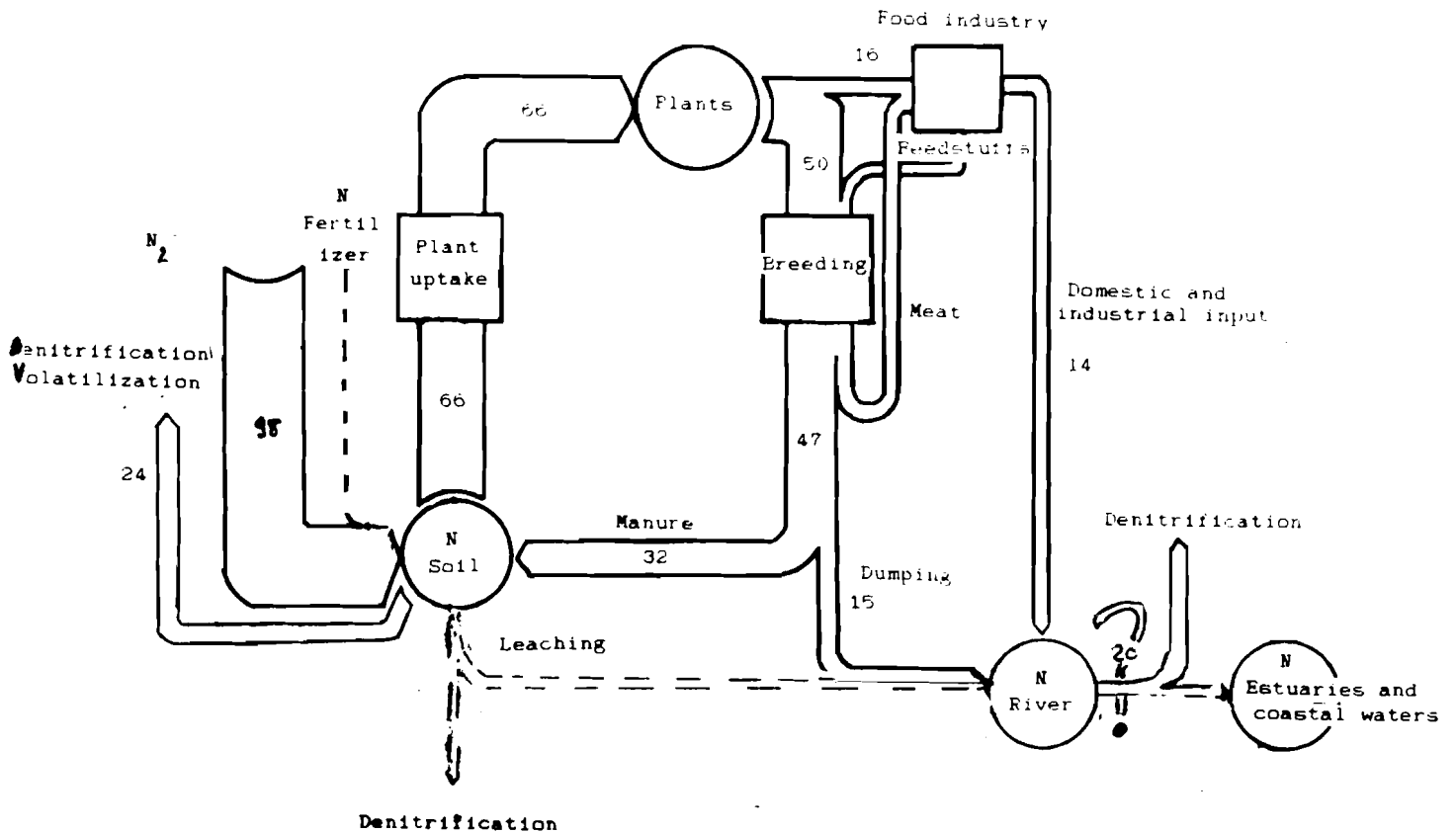

Figure 6-3: Projected nitrogen cycle in Europe for 2010 in $\text{kg yr}^{-1} \text{ha}^{-1}$ (of total area).

Europe, nitrogen fertilizers are almost exclusively responsible for nitrate leaching in groundwaters. Secondly, the nitrogen-fixing process by plants would also generate nitrogen in the soil, but mostly in organic form (transformed by the plant). An added step of mineralization would be required before leaching. However, the mineral form of nitrogen, resulting either directly from N-fixing micro-organisms (some authors indicate that adaptation of micro-organism activity to the plant's needs is not evident), or from the transformation of the organic form of nitrogen, would be released slowly. Thus, unlike chemical fertilizer application, the plant could absorb it over a prolonged period during the growing season, thus precluding the problem of leaching of excessive (unabsorbed) doses.

In conclusion, the emergence of biotechnological nitrogen fixation for agricultural production would probably result in greatly diminished leaching of nitrates to groundwater and drinking water.

This scenario for the nitrogen cycle in agriculture has several interesting features: At the soil level, the new nitrogen cycle would be closer to the nitrogen cycle in a traditional agricultural ecosystem before the Industrial Revolution in the sense of low rates of nitrogen leaching and the potential for a closer balance between soil inputs and outputs. This expresses the interesting and more general idea of historical "returns" although the comparison with the past situation has its limits since the proportion of inputs and outputs will be different. Nevertheless, the increased perception of risk of soil degradation may lead to adding loops to the cycle in order to reutilize the outputs and to allow the original cycle to function in a different context. The generalized treatment of manures by denitrification would be one example (e.g. see Etchanchu and Souchu (1987)).

Another remark is that any modification in leaching affects other fluxes in turn since outputs for some systems (soil here) constitute inputs for others (rivers), everything being interrelated through ecological chains. What impacts would decreased leaching have on rivers, estuaries and coastal waters? According to P. Souchu (personal communication), the impact of a decrease in nitrogen in coastal waters is uncertain, but less nitrogen would surely affect the entire marine ecosystem since nitrogen is an essential nutrient at the beginning of the marine food web. Could nitrogen fixation affect the total fish population in coastal sea waters? The question is left unanswered, but it leads to another important question: What are the second-level consequences (impacts of impacts) of new technologies on the environment? An answer to this question could define anticipation (of risks), and perhaps avoidance of ecological catastrophies. This enlightened attitude is certainly to be encouraged.

6.2 Structural Analysis of the Factors Influencing Future Evolution of Biotechnology Applied to Agriculture

6.2.1 The General Approach

In Section 6-1, we discussed a specific possible future application of biotechnology (nitrogen fixation), and the way it might possibly affect material flows (nitrogen cycle).

This section examines the possible evolution of biotechnological applications to agriculture in a broader context. In doing so, we shall focus on our principal concern, the environmental impacts of technology; but the fact that biotechnology may be related to the environment via other factors justifies our approach.

Consideration of the global context of biotechnological development is complex because of the numerous relations relating the different factors to biotechnology. For this reason, we have tried to be systematic, using a precise methodology.

According to the French School of Prospective, the structural analysis that we shall present is an appropriate basis for the elaboration of scenarios. It consists of identifying the key variables of the analyzed system (here biotechnology applied to agriculture). The method we shall use is in fact an application of mathematical graph theory, relative to the study of interconnections or paths between different variables. The method is called MICMAC.

The first step consists of replacing the specific biotechnological applications we have described earlier by a more general framework, and asking which factors can determine its evolution? (See Figure 6-4.)

A list of variables connected with biotechnological developments in agriculture has been prepared based on the work of specialists in the fields of biotechnology and the social sciences, and from our previous analysis of the impact of biotechnology on the environment in Section 2.2. These variables appear in Figure 6-5.

6.2.2 The Important Variables

The internal variables are:

- a. Nitrogen fixation by symbiosis plant/micro-organism.
- b. Direct nitrogen fixation by plants (plant genetic engineering).
- c. Pest degradation by micro-organisms.
- d. Direct pest degradation by plants (Plant genetic engineering).
- e. Herbicide resistance.
- f. Growth on salinized soils.
- g. Forestry clonal selection.
- h. Animal production.

These variables were described in Section 2.1; nitrogen fixation and pest degradation have been subdivided according to the technique applied (utilization of micro-organisms; gene transfer to the plant).

The external variables are:

- i. Basic research.
Basic research in biotechnology is mostly from public funds although this trend may change. Its goal is to achieve fundamental understanding of the biochemical mechanisms of plants, micro-organisms, and animals, and the linkages between them. Biotechnology's basic research may serve other biotechnical applications as well.
- j. Applied research
Applied research is essentially being conducted by the private sector. Nearer to application, it may influence environmental and economic variables as well.
- k. Cooperation between basic/applied research.
This can be also viewed as private/public cooperation.
- l. International cooperation in research.

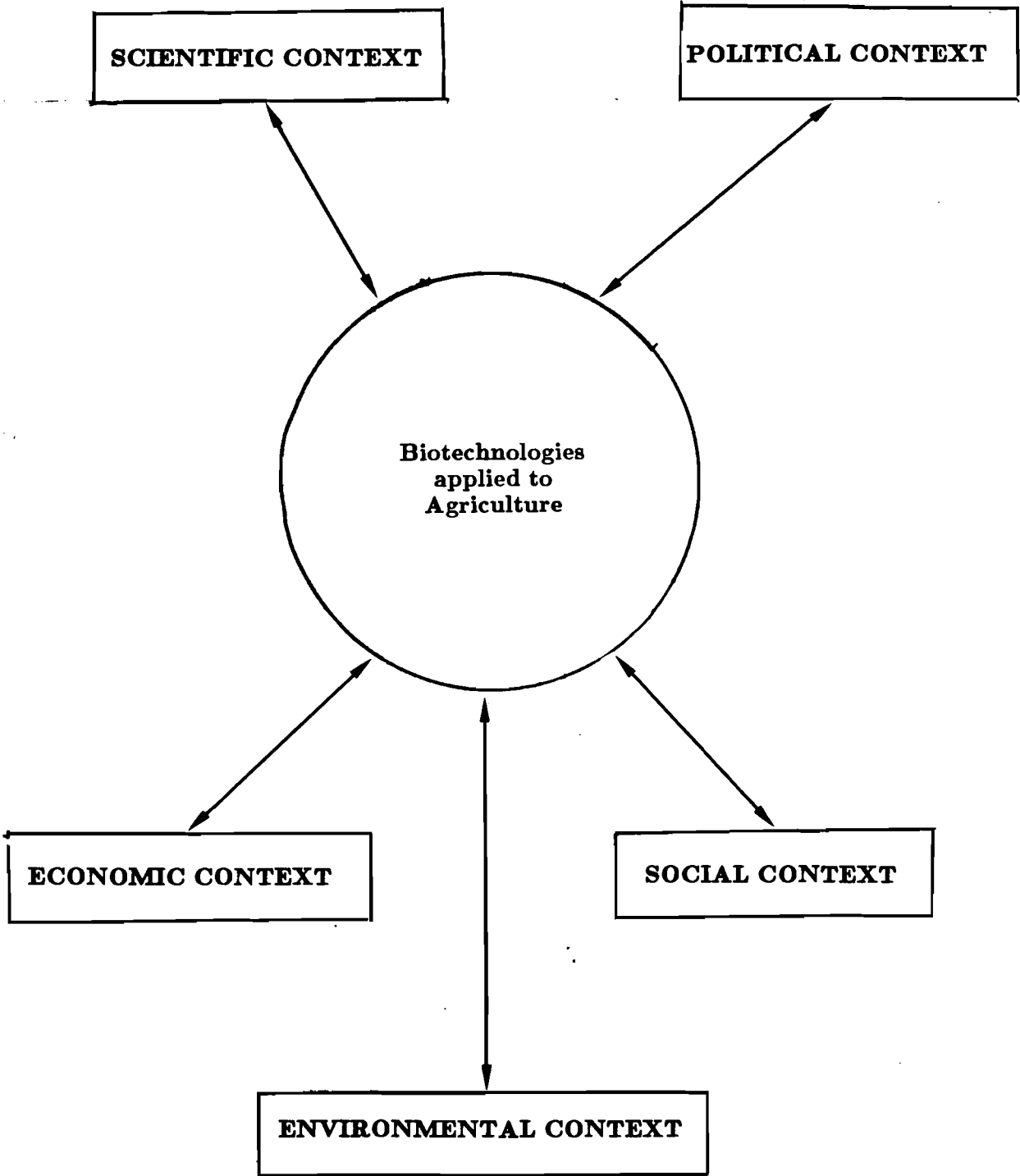

Figure 6-4:

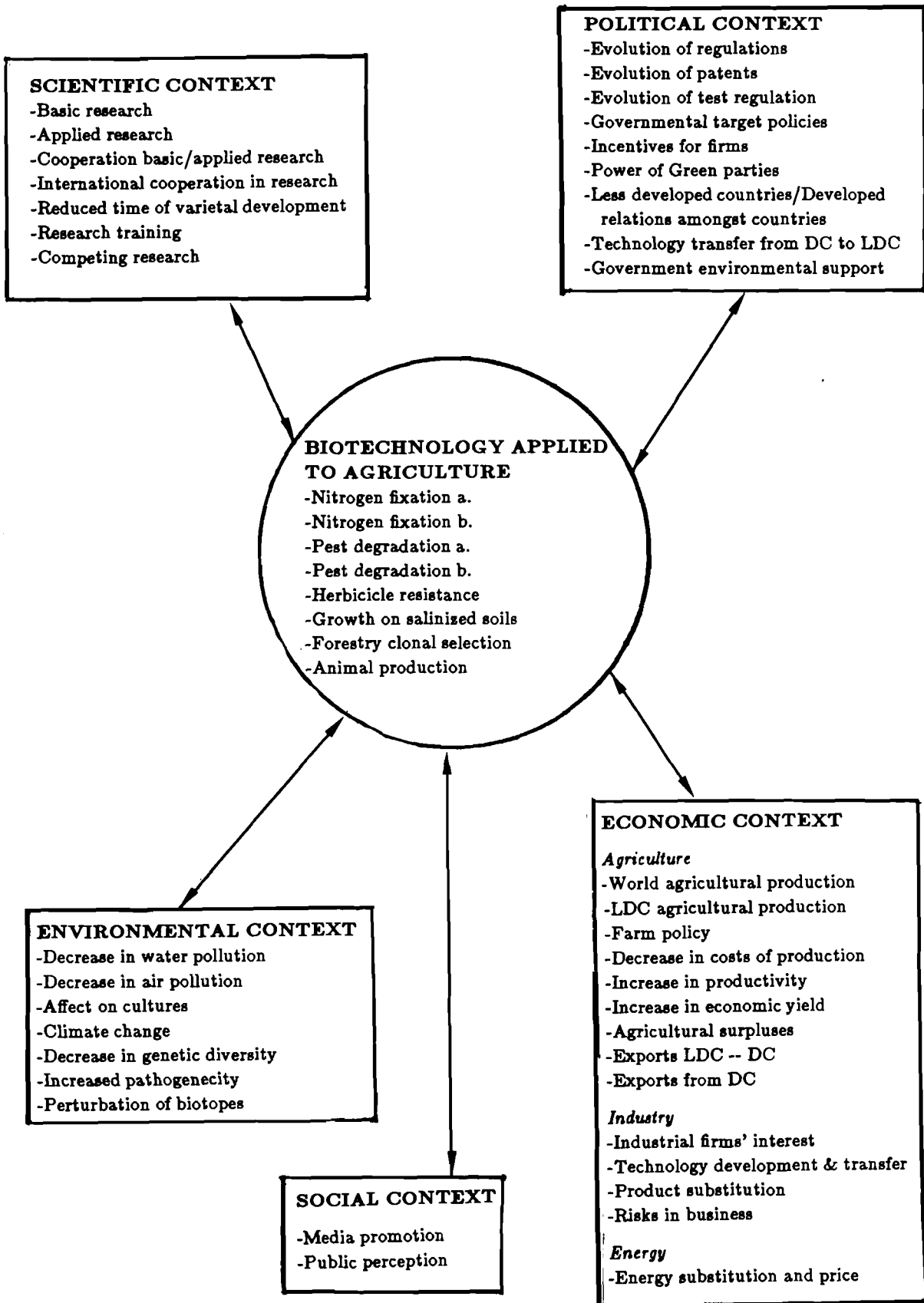

Figure 6-5:

International cooperation can be promoted by international research programs favoring collaboration between research centers. This is the case of B.A.P. in Europe, involving 100 European research laboratories covering middle- and long-term biotechnical applications.

m. Reduced time of varietal development.

Culture and genetic engineering potentially allow access to a greater range of mutations in a short time or the desired transformation without intermediary steps, thereby reducing varietal development time. This encourages industrial development at the applied research level, and may also interest the consumer (farmer) by allowing a reduction in costs. According to Hansen et al., public sector breeding programs are declining partly because of the emphasis placed on biotechnology.

n. Research training.

Adequately trained scientific and technical personnel are a vital prerequisite for research excellence in biotechnology. The U.S. Office of Technology Assessment's (OTA's) international analysis of industrial competitiveness in biotechnology places this factor as one of the most important.

o. Competing research.

Other research programs may compete with biotechnology. The best example is the research done on chemical fertilizers, in order to diminish energy consumption in the industrial process, and to develop slow-release chemical fertilizers, avoiding the leaching for which current products are responsible. Such fertilizers may compete with nitrogen fixation.

p. Decrease in water pollution.

Current fertilizers, pesticides, and herbicides are responsible for pollution of ground waters, rivers and coastal waters. Biotechnological applications may improve the situation.

q. Decrease in air pollution.

Current industrial processes for the fabrication of fertilizers cause air pollution, and substitution technologies such as biotechnologies could mitigate this pollution.

r. Areal impact

In this factor we include large-scale migrations, decreases, or increases of total areas of growth of specific agricultural plants.

s. Climatic change.

Climate influences plant growth, but the reciprocal is also true. Biotechnology may contribute through the uncontrolled release of frost-protecting bacteria and on a large scale through climate change.

t. Decrease of genetic diversity.

Biotechnology may contribute to the abandonment of some crop species, as has already occurred due to traditional plant breeding. A reduced gene pool represents a potential danger of diminished resistance to altered growth conditions or systemic changes in agricultural ecosystems.

- u. Increase in pathogenicity.
Modification of ecosystems and increased nutrient inputs (nitrogen) may cause increased plant pathogenicity.
- v. Perturbation of biotopes.
New agricultural practices may affect natural micro-organisms and other natural living organisms, thus creating perturbations in ecological chains that can then be harmful to the crops themselves.
- w. Evolution of regulations.
The very first biotechnological applications in agriculture have recently appeared on the market, and others are now technically possible, needing only legal authorization. This is typically the case of somatotrophin hormone, obtained by genetic manipulation of micro-organisms, which could be implanted behind the ear of cows so as to increase milk production. Regulators must decide whether this application will be permitted or not (in Europe).
- x. Evolution of patents.
In no other field of technology do national laws vary on so many points and diverge so widely as they do in biotechnology. United States and Japanese laws are on the whole more open and flexible towards new developments in biotechnology than are the laws of many other OECD countries. This is especially true with respect to the protection of micro-organisms, and for grace periods of patent deposition. Conditions which are more favorable to the inventor would make it more attractive for scientists to use the patent route. This is especially true for micro-organisms, since plants are covered by the international UPOV convention.
- y. Regulation of tests.
New biotechnological applications must be tested before they are commercialized. The procedure of authorization for field testing varies from country to country and is somewhat on a case by case basis. In the United States, E.P.A. has suspended authorization to field test the products of some firms. Field testing may be dangerous owing to the potential for release of micro-organisms into the environment. No doubt better regulations that diminish environmental risk while at the same time allow more frequent testing with less delays would encourage innovation.
- aa. Government's target policies.
This variable refers to policies intended to encourage general biotechnological applications, or specific agricultural applications of biotechnology. Currently, Japan has a strong target policy for biotechnology.
- ab. Government funding of research.
Here we include basic or applied research, for either private or public laboratories.
- ac. Incentives for firms.
These may be tax incentives or investment aids designed to encourage research and development programs.

- ad. Green party's power.
This variable designates not only the Greens as a political party, but more generally all lobbies against biotechnology linked to the potential release of micro-organisms in the environment. In some specific cases, these lobbying groups have been very influential in retarding biotechnological applications.
- ae. Less developed countries (LDCs)/developed countries' (DCs) relations.
This is meant to cover political and commercial relations as well. It is a particularly important factor to take into account in the domain of agriculture.
- af. Technology transfer from DC to LDC.
Most (not all) LDC's do not have sophisticated research programs in biotechnology, and therefore biotechnological applications have been introduced via DCs. The way this transfer occurs is very important for the evolution of biotechnological applications, and affects directly the world agricultural economy.
- ag. Government environmental support.
The degree to which governments support environmental policies is very diversified. In Europe, West Germany and the Netherlands are leaders, whereas France and southern countries have been less involved. The degree of government intervention is however increasing.
- ah. World agricultural production.
This variable essentially designates specific crops for which the international market is well established, and for which biotechnological innovation might imply breakthroughs in the structuring of these markets (eg. cereals and tropical products).
- ai. LDC agricultural production.
Since LDCs have an important role to play in the evolution of agricultural economics, we have decided to take their production into account specifically. In this way, differences between this variable and the preceding one characterize DC agricultural production.
- aj. Farm policy.
This variable is related to agricultural economics and politics. It defines agricultural policy, but only in its structural aspects, thus directly concerning farmers.
- ak. Decrease in cost of production.
We mean here the cost of production at the farm level, but, of course, this is often linked to the cost of production at the industrial level.
- al. Increase in productivity.
Agricultural innovations are most often responsible for increases in productivity, with some exceptions (e.g., nitrogen fixation by plants might imply a smaller yield).
- am. Increase in economic yield.
As noted by the U.S. National Research Council (1987), and in relation to the agricultural surplus situation, "technologies should emphasize maximizing economic yield rather than total production. That is, they should increase the efficiency of

production by reducing the costs of production".

an. Agricultural surplus.

The agricultural surplus situation must of course be taken into account for the role it plays in market structure. However, the effect that biotechnological applications might have on agricultural surplus must also be considered.

ao. Exports from LDC to DC.

Since biotechnological applications may allow production conditions to be subsequently modified, agricultural crop distribution might be affected and in turn might affect export/import fluxes.

ap. Exports from DCs.

We have distinguished this variable from the preceding because products and quantities are not the same.

aq. Industrial firms' interest.

This variable represents industry's economic advantage, either as an actor or as a receptor. Industry's interest is essential to the promotion of an innovative technique.

ar. Technology development and transfer.

This factor is meant to designate knowledge and know-how exchanges at the industrial level. Such exchanges foster a more rapid development of biotechnological applications.

as. Product substitution.

Industrial interests arise either out of the potential of a new market (e.g., growth on salinized soil), or out of a possibility of product substitution in an existing market (e.g., N fixation). Product substitution, however, can either foster or inhibit biotechnological applications.

at. Industrial interconnection.

Here we mean interconnection of subsidiaries concerned about different branches of production. This factor is important because it affects competition greatly. The fact that the big chemical firms which have been involved in agriculture are also the ones focusing on biotechnological application in agriculture certainly promotes the possibility of product substitution.

au. Energy substitution and price.

We have introduced this variable in relation to our discussion in Section 2.3.

av. Media promotion.

Media have an influence on public perception of innovation, and also play an educational role.

aw. Public perception.

Public perception may have a role in policy, especially when there is strong public opinion regarding a particular issue.

ax. Risk-taking in business.

Some innovations are long-term prospects, therefore more uncertain to firms.

6.2.3 Methodology

Having thus defined our variables, we have identified all the direct relations which may link them, and evaluated their importance as follows: very negative influence(--), negative influence(-), negative or positive depending on the context (+/-), positive (+), and very positive influence (++). We have added parentheses when the influence is either controversial, or negligible. This ranking is necessarily qualitative, based on our literature reviews and reflections, about potential future relations. This analysis is presented in part in Table 6-1. (The rest of the analysis is available in tabular form in Appendix E)

In principle, this Table should include 2500 couplings of variables. As a first pass, couplings were considered to be zero when linkages between them were not immediately obvious. A large number of indirect influences may however be determined from one variable's evolution. The goal of the MICMAC method is to render these relations obvious and to quantify them. This has been done by multiplying, several times, the matrix resulting from Table 6-1 by itself. (Table 6-1 was converted to matrix form by assigning a "1" to the coupled relations, and a "0" in the absence of relations or those with moderating influences in parentheses). The square multiplication makes second degree relations appear, and so on. We have worked with the comparison of the initial matrix M and its elevation to the fifth order (M^5).

Using the notation M^n , the sums of the columns indicate the number of "n degree or less relations" that affect each variable, and conversely, the sum of the rows indicate the number of "n degree or less" relations that affect each variable influenced. Thus it is possible to define a classification of the different variables according to their degree of influence or "determinance" vis-a-vis the whole system, and another classification according to their degree of "receptiveness". We have constructed this classification for M^1 (direct classification taking only direct relations into account), and for M^5 (MICMAC, or indirect classification involving all the relations that link the different variables up to the fifth degree). Our decision to stop at the fifth degree was arbitrary. Comparison of the two classifications, shown in Figure 6-6 for variable receptiveness and Figure 6-7 for variable determinance serves as the basis for determining which variables have been promoted or, on the contrary, demoted by the higher order classification. Furthermore, the MICMAC classification helps to determine the key variables responsible for the evolution of biotechnology applied to agricultural production, or, on the contrary, the variables most affected by the evolution. This determination needs of course to be enriched by a more quantitative analysis, since the classification is made according to only the qualitative importance of each variable (number of relations). However, the methodology serves as a useful first step in an objective approach that underscores the system's complexity and focuses on the different interconnections between the components.

	Biotechnological Applications								
impact or influence over	a	b	c	d	e	f	g	h	i
N fix 1		++							
N fix 2	+								
pest degrad 1				++					
pest degrad 2			+						
herb resis									
salin soils									
anti freeze									
forestry									
anim prod									
basic res	++	++	+	+	+	+	+	+	+
applied res	++	++	++	++	++	++	++	++	++
coop basic/app	+	+	+	+	+	+	+	+	+
interncoop	+	+	+	+		+	+	+	+
time var dev	+	+	+	+	+	+		+	
res training									
compet res	--	--	-	-					
water poll									
air poll									
affect cult									
clim change	(+)	(+)	(+)	(+)	(+)	(+)	(+)		
gen divers									
pathogen									
perturb biotope									
reglementation	+	(+)	+	(+)	+	(+)	+	(+)	++
patents	+	(+)	+	(+)	+	(+)	+	(+)	+
regul tests									
gov target pol	+	+	+	+	(+)	+	+	+	+
gov funding res	+	+	+	+		+	+	+	+
incentives firms									
greens									
LDC/DC rel									
tech transf DC/LDC									
gov sup envir									
world prod									
LDC agric prod									
farm pol									
cost prod									
productivity									
econ yield									
agric surplus									
export LDC/DC									
export from DC									
indus interest	++	++	++	++	++	++	++	++	++
tech transfer	+	+	+	+	+	+	+	+	+
prod substit	++	++							
indus interconnex	+	+	+	+	+				+
energy	+	+	+	+	+				
risk business	+	+							
media	+/-		+/-		+/-		+/-		+/-
public percep	+/-		+/-		+/-		+/-		+/-

Table 6-1: Interactions of future possible biotechnical applications with variables describing their political, economic, social, environmental and scientific context. See Appendix E for additional information.

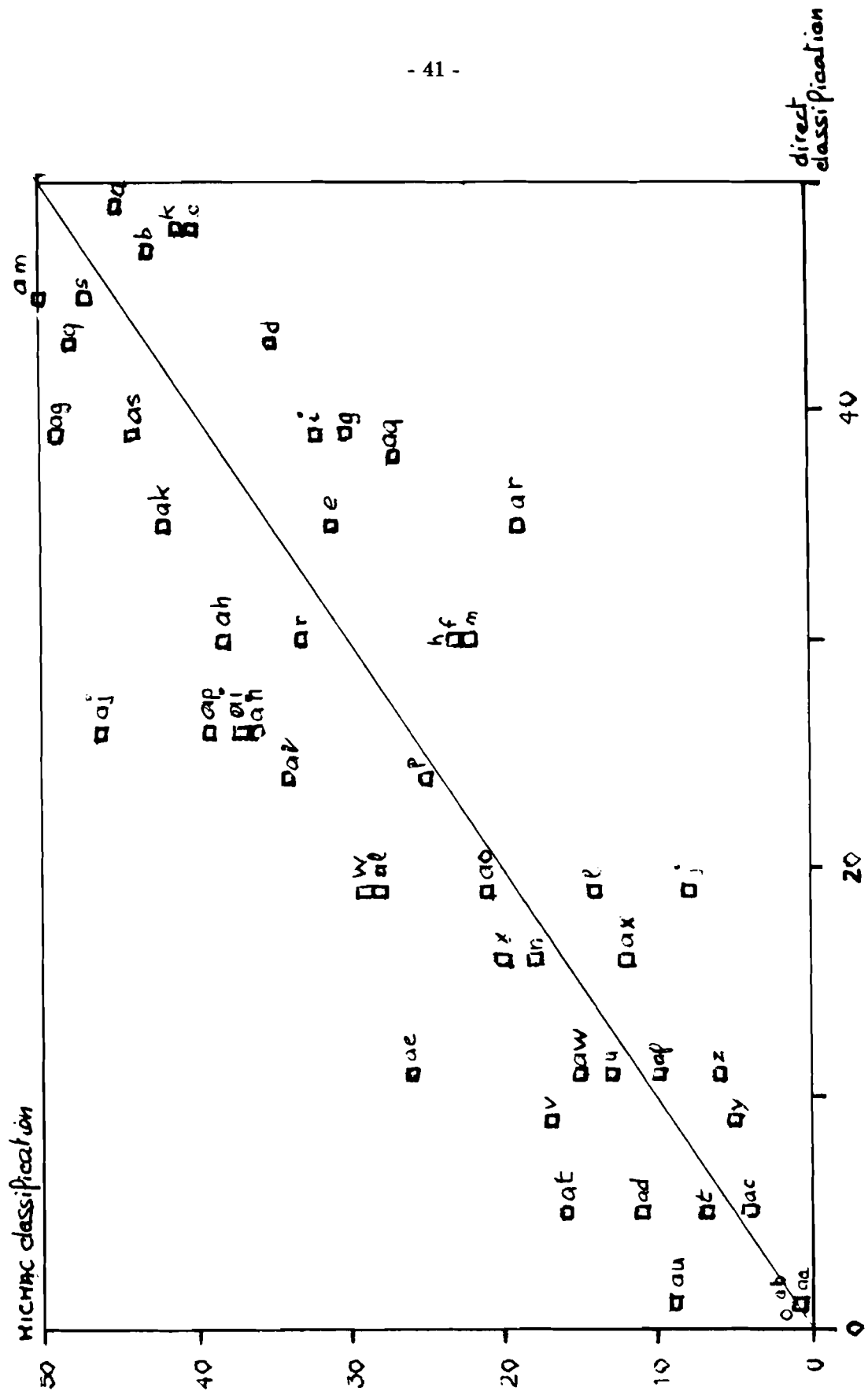

Figure 6-6: Comparison of the direct and the MICMAC classification of variables considering their receptiveness to external influences.

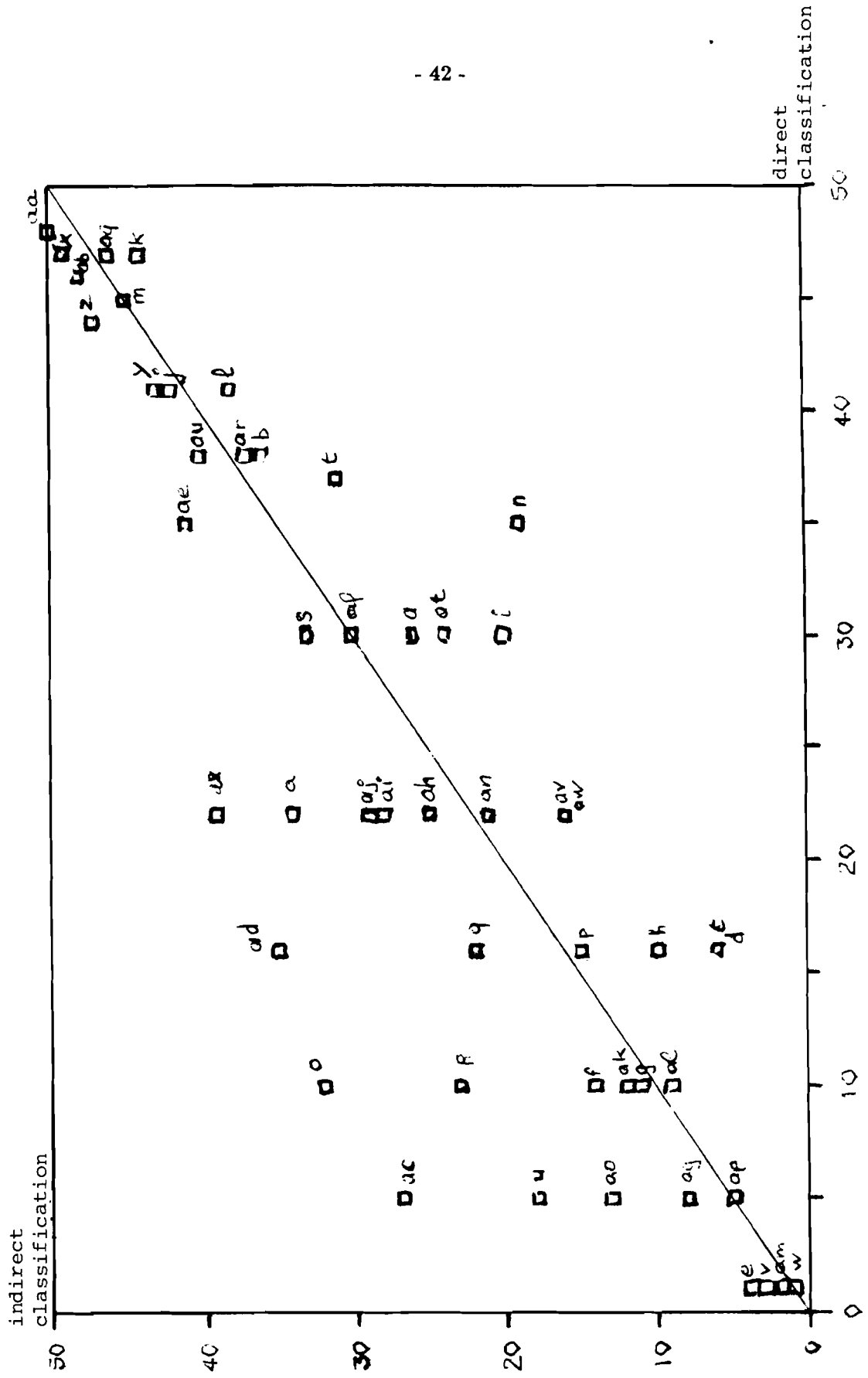

Figure 6-7: Comparison of the direct and the MICMAC classification for variable considered for their determinant effect.

6.3 Interpretation

6.3.1 Variables and their degree of "determinance"

Political Context:

The importance of the political context in which biotechnological applications evolve is immediate and predominant. This importance has in fact already been confirmed by the Japanese, partially attributable to the fact that the Japanese government has made the commercialization of biotechnology a national priority. According to the USA OTA report on commercial biotechnology, "Japan will be the most serious competitor of the U.S. in the commercialization of biotechnology in the future". We must also note that among the political factors, government environmental support comes last and is not a strong determinant for the evolution of the whole system. This only confirms the fact that environmental policy is somewhat disconnected from the rest of the political context, though the gap may hopefully be reduced in the future.

Industrial Context:

Industrial economic factors also appear as a major consideration in biotechnology's evolution. The self interest of industrial firms is one of the first factors to intervene, because changes in our society have an economic basis, generally speaking.

Scientific Context:

Basic and applied research are also fundamental for technological innovation. Basic and applied research are directly related to the two precited actors. The classification gives relatively little importance to other factors in the scientific context, and competing research does not seem determinant. One exception to be noted regarding competition is the potential development of more economic, non-biotechnological fertilizers that release nitrogen slowly over time.

Agriculture:

Unlike the industrial economy, the agricultural economy does not as a whole have major effects on biotechnological innovations. The exceptions are farm policies that mediate between political and agricultural factors, and to a lesser extent, LDC agricultural production and world production which are also evidently related to politics. We must also note that agricultural surpluses are not very determinant. This is understandable since the biotechnological applications we have studied imply increased productivity, and the link with increased production is easy to make. However understandable it may be, it is currently an aberration from the economic point of view, which would argue for a solution to the problem. Finally, and most surprisingly, the micro-economic variables (economic yield, productivity, cost production), which interest the farmer the most, appear to influence biotechnological innovations very little, even though such factors do interest industries as a means for increased competitiveness. This leads us to the fact that, though the biotechnological applications that we have studied principally affect the farmers, the latter are not a very strong factor in the evolution of the whole system. Only government, through farm policy, works in their favor.

Internal Variables:

Finally, biotechnological applications themselves and environmental variables do not appear as major factors in the evolution of the system. This is logical; they are at the end of the chain of influences and they are affected by other factors rather than affecting themselves. But it also means that the feedback from environment to technology is weak, although not non-existent, because there are some exceptions. International trade has an important effect on agricultural economics and on politics through LDC/DC relations. Similarly, nitrogen fixation is perceived as a determining factor because of the implications of its applications to the Third World. Water and air pollution concerns appear significant as well; they are not linked to LDCs, but rather to environmental groups like the Greens.

Factors perceived as "determinant" based on the MICMAC classification (See Figure 6-8):

- Business risk seems to be very determinant. Upon reflection, this is not surprising, since most of the agricultural applications are long term. Therefore, industries must consider the risk of large investments for research and development against uncertain results.
- The power of the Green party is also important; The Greens are a determinant though secondary actor.
- Finally, the "inclusion" of incentives for firms and training of researchers only confirms the importance of the two major actors: governments and industries.

Factors perceived as less determinant based on the MICMAC classification:

- Reduction in time of varietal development appears as a minor determinant which is understandable, since most of the technologies have middle to long term applications.
- Pest degradation becomes less important along with the other biotechnological applications.

6.3.2 Variables and their degree of "receptiveness"

Environmental context

Particularly for environmental variables, the factors that influence them are very diversified. Water pollution is the most receptive. This is explained by the fact that it is currently most affected by fertilizers, pesticides, and herbicides as well as animal production. Effects on cultures, as well, will be influenced by several technologies, and by other variables such as climatic change. Air pollution and perturbation of biotopes are also largely determined by other variables. On the other hand, pathogenicity does not seem very receptive to changes in the other variables, which is explained by the fact that only two technological applications may affect pathogenicity for crop plants. In addition, pathogenicity is completely disconnected from environmental concerns. We must also note that climatic change is placed by the MICMAC classification in its real position, as a determinant factor, although it has been introduced in our system as a receptive factor; i.e., a third degree consequence of frost-protecting bacteria.

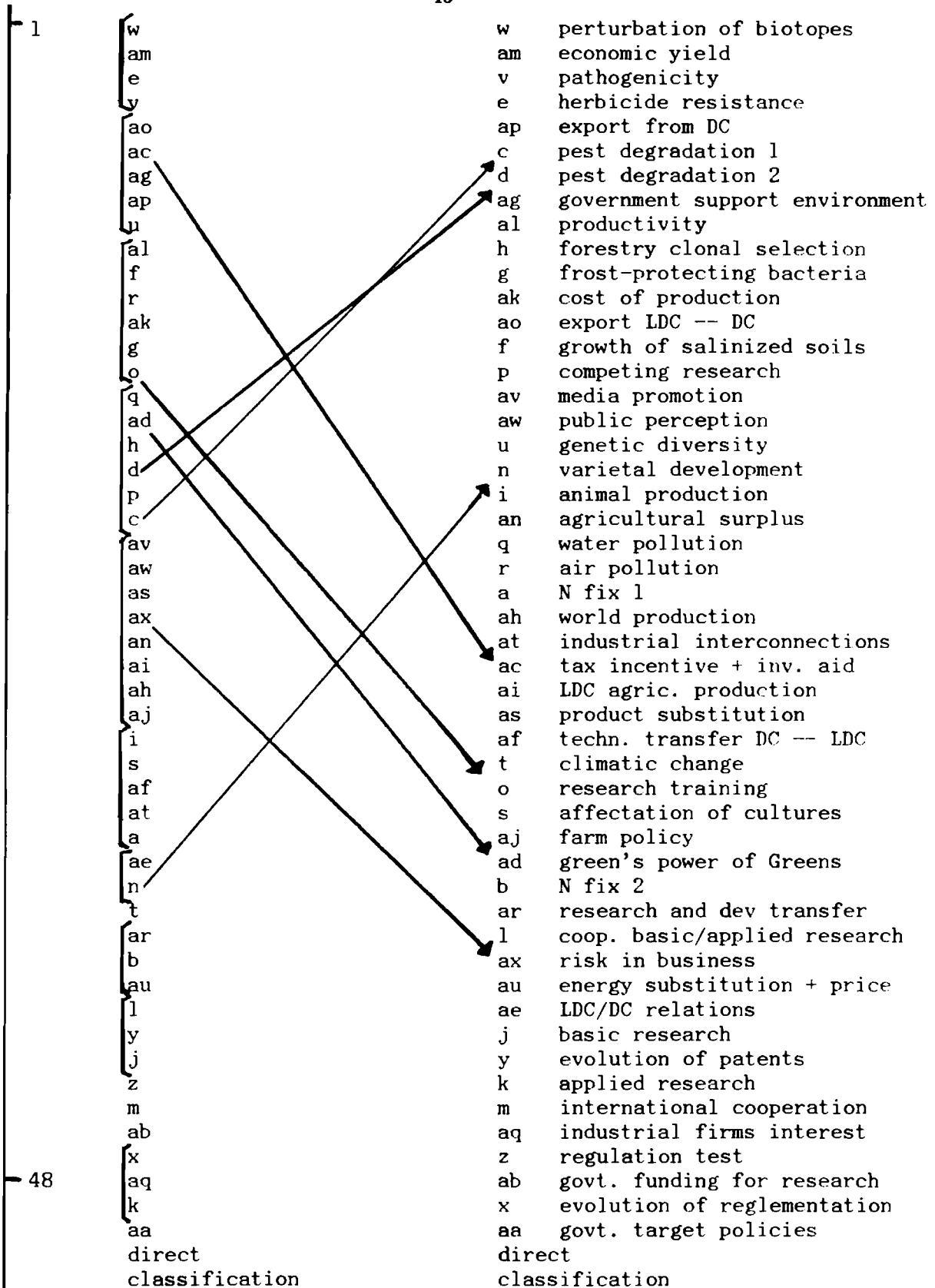

Figure 6-8: Direct and indirect classification of the factors involved in the development of biotechnology applied to agriculture, considered as "determinant" factors.

Agriculture

The variables related to agriculture are among the most receptive. This is not surprising, since our focus is on *biotechnology applied to agriculture*. The most important variable according to the MICMAC classification is the increase of economic yield, which is also one of the main variables of interest to the farmer. Thus, we confirm the idea that the farmer is the receptor of the technical evolution, not the actor. The variables related to production volume are also highly receptive. This means that we may evolve towards an agricultural production system very different from the current one. Since the Industrial Revolution agriculture has witnessed many changes, and it seems that further changes are to be expected. As a consequence, farmers will still be among the most important societal receptors, and have to adapt or disappear.

Biotechnologies

Last of all, receptor groups are the biotechnologies themselves. The global system we have defined emphasizes some applications more than others, so the latter are consequently less receptive to the whole system. The international influences and more specifically LDC/DC relations concern indeed some biotechnological applications more precisely (N fixation, pest degradation). The variables that appear most receptive to external influences are the ones that are related to environmental concern, LDC countries and, last but not least, industrial interest. The potential for production on salinized soils may have subsequent political and environmental impacts (affecting cultures linked to increased area of production in Third World countries); its lack of receptiveness is however due to the lack of interest from firms (LDC markets being not so attractive for financial reasons), and this is a handicap to development of this technology.

Other categories of variables are not very receptive to the system's evolution. These variables correspond to the two most important actors: industries and governments.

We should however note the status of the following:

- Product substitution: considered as a determinant, product substitution represents competition for biotechnology. But production substitution is a very receptive variable as well: biotechnologies are candidates as substitutes.
- Applied research is also greatly influenced by other variables. It is thus typically an intermediary factor, representing the transition to industrial applications.
- Finally, media promotion is also characterized by a certain degree of receptiveness, more so the public itself which voices its opinions through the media. However, we have seen that the media's role as determinant is rather limited. This seems to indicate that the media are not a strong intermediary between biotechnology and the public, reconfirming the statement of OTA (1984), that the public should become more educated about biotechnology in order to comprehend the perceived changes in a rational way.

Variables favored by the MICMAC classification (See Figure 6-9)

- LDC/DC relations: Although these relations may have a determinant role in the evolution of agricultural economics and global exchanges, they also constitute a receptive variable because LDCs are passive, depending greatly on technological transfer from the DCs. Hence, LDCs may be viewed as weak actors.
- Farm policy: Farm policy adapts to external evolution, and is more effective in doing so than in creating changes itself. This can be verified by reference to the past and current policies in Europe, which are typically responses to the surplus situation

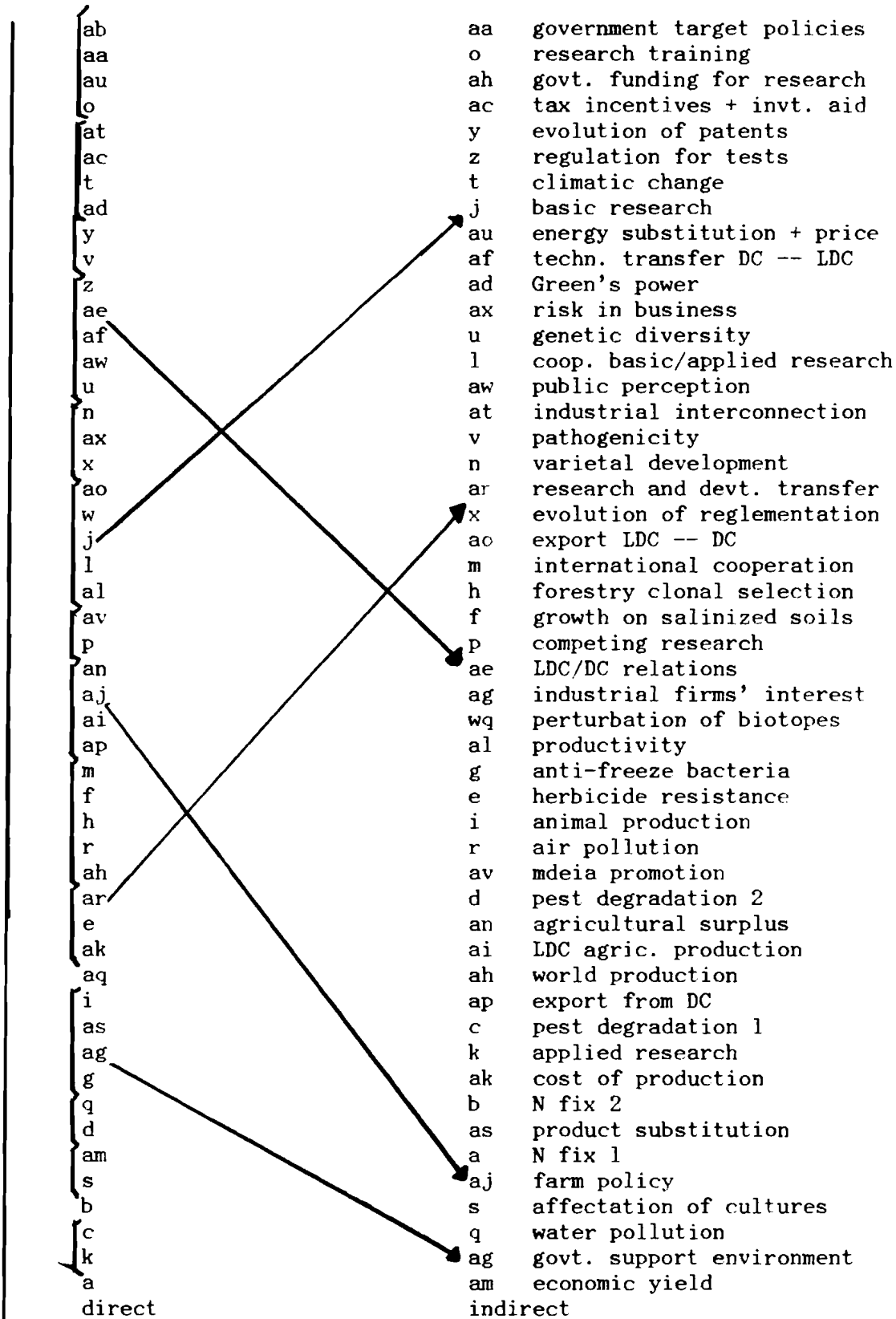

Figure 6-9: Direct and indirect classification of factors considered as "receptive" factors.

and to the decrease of total agricultural population. However, we have seen that farm policy also has a determinant position, which should be emphasized in the future.

- Government environmental support is very receptive to external changes. This is very logical since, in fact, this system is formulated from the environmental point of view. However, this variable is not so influential in return.

Factors downgraded by the MICMAC classification:

Basic research has lost importance. This is desirable since basic research has to preserve its independence.

6.3.3 Crossed classifications: determinance - receptiveness

In Figure 6-10, we have crossed the two classifications showing the importance of the influence affecting or being affected by each variable. This representation permits us to identify four categories of variables as shown in Figure 6-11. These categories deliberately overlap with no sharp transitions.

Category A defines the receptive variables, which have no influence on biotechnological evolution and its context in return. This category is, for the most part characterized by variables related to AGRICULTURE and AGRICULTURAL TECHNOLOGY. In our industrial society, agriculture is viewed only as a receptor.

Category B defines variables which, on the other hand, are responsible for the system's evolution, and are relatively autonomous in the sense that they are themselves less sensitive to changes in other factors. These variables are predominantly related to POLITICS and INDUSTRY. Some variables related to research also appear in this group, because research is very directly dependent on government policy. We must however note the presence of one environmental variable: climatic change, whose receptive character as a consequence of technology is minor with respect to its determinant character.

Category C defines transfer variables, or variables that are affected by others but in turn are responsible for changes in others. They are consequently key variables in the mobility of the whole system. They do not belong to one specific group of variables. We can distinguish:

- Applied research.
- Nitrogen fixation by plants, which is, as for all biotechnological applications, influenced by the evolution of research and development. Nitrogen fixation can however, imply consequent evolution of crop areas (and thus agricultural economics) as well as environmental pollution. We must also note that it might affect productivity in an -up to now- uncommon way, viz., by diminishing it; this may be a solution for the future with respect to agricultural surpluses.
- Cultural effects, which represent a feedback to economics and politics:

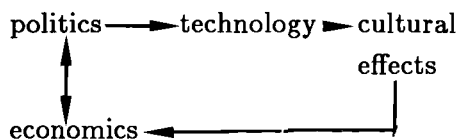

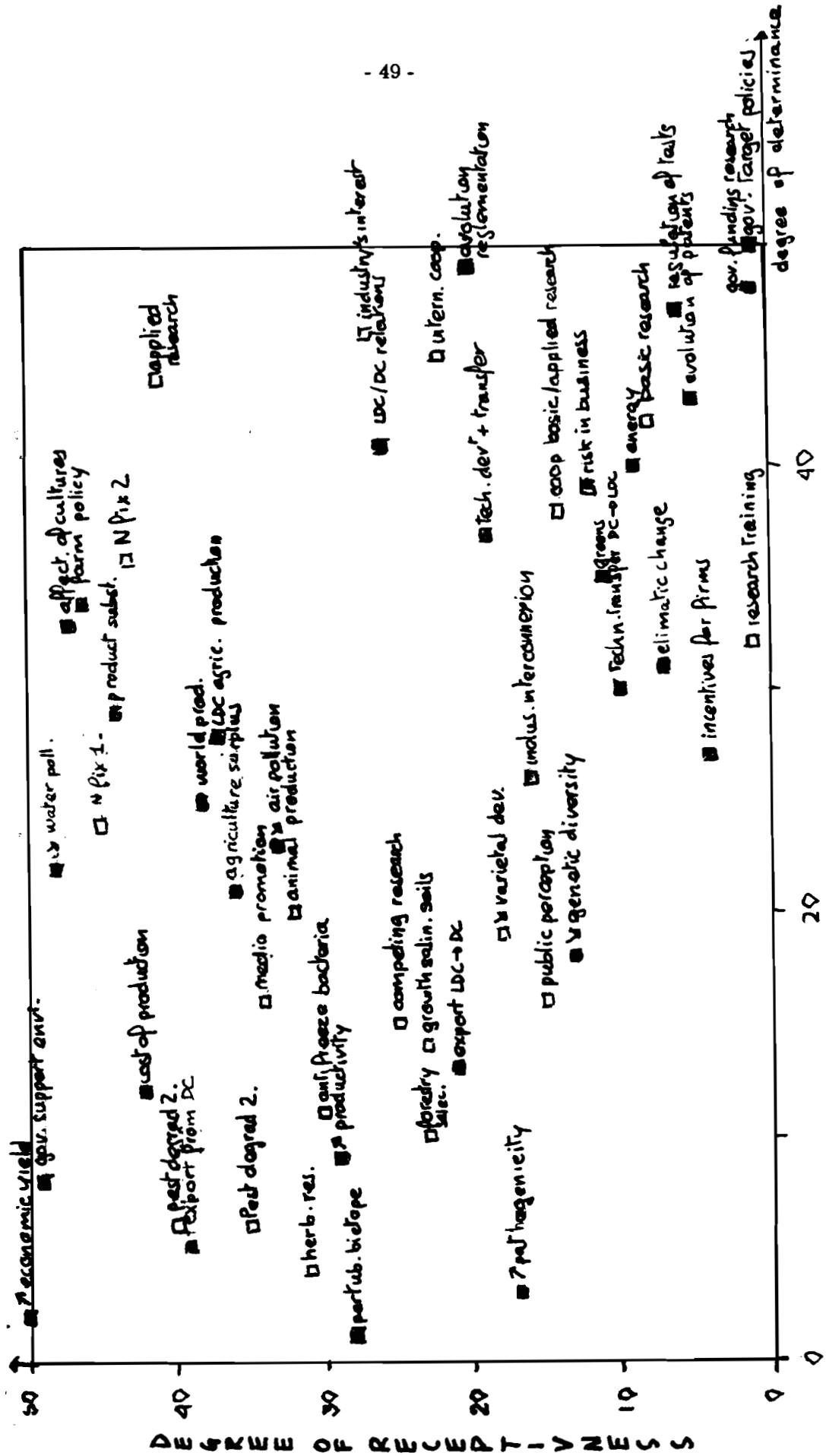

Figure 6-10: Crossed Classification Determinance - Receptiveness.

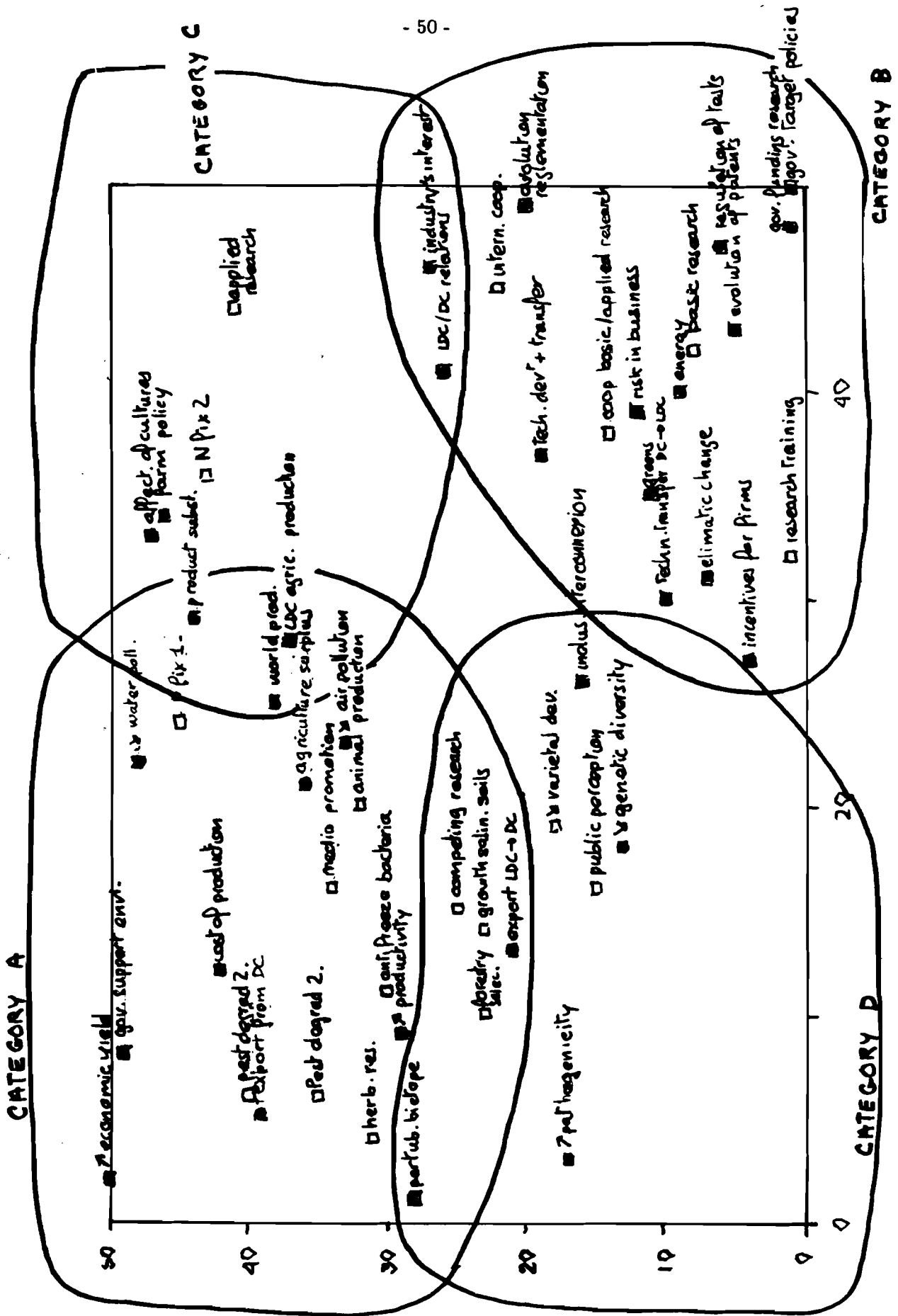

Figure 6-11: Definition of new Categories of Variables

Technology may continue to force changes in the agricultural landscape.

Finally, *Category D* defines the variables which do not contribute much to the system's evolution. They comprise environmental variables, public perception (as we have seen, the importance of this factor could and should increase), and eventually, variables linked to research, and exports from LDCs (which confirms the passive role of LDCs even though they may have to support the consequences of biotechnology). In addition, there are two technological applications: forestry clonal selection, and productivity in salinized soils, neither of which influences powerful industries. This is regrettable, since forestry and salinization of soils are major environmental concerns.

In conclusion, environmental variables do not react similarly within the framework of this classification, since they form the only group which enriches the four other categories. What does this mean? Certainly, that the environment is not considered currently as a whole, and that only some of its components appear to attract society's attention, viz., water and air pollution (eventually perturbation of biotopes), variables linked to a generalized environmental concern. Category B includes variables directly linked to agricultural production (crop effects), and Category C, the variables linked to the conditions of agricultural production (climate). Category D contains the remaining variables. Taking environmental problems into account more efficiently would imply a transfer of the environmental variables to category B, promoting them to determinant variables. This could be achieved by stronger governmental support for the environment, and an increased public perception of the current evolution. Thus, "greens" would not be the only actor concerned with the environment.

6.4 The current debate concerning biotechnology applied to agricultural production

6.4.1 Farmers as receptors of changes

Considering the current agricultural surplus in Western Europe, the first question that comes to mind is whether an increase in productivity would not in fact be harmful to both European agriculture and the environment. Technologies should emphasize maximizing economic yield rather than total production. However, biotechnologies often appear to maximize effective and economic yield simultaneously (e.g., growth hormone). Considering this, as well as the financial difficulties with which farmers must cope and the stiffening of world competition, diminishing the cost of production appears as a top priority for farmers.

Biotechnologies can help in this cost reduction and thus improve profits for farmers. But this does not solve the agricultural economic problems linked to structural surpluses. Agricultural policy makers have been considering a reduction of productivity as a solution. But this new form of thinking has not yet affected research, which under these conditions should develop new varieties so as to reduce productivity and to increase economic yield at the same time, thus making the solution acceptable to policy makers and farmers.

It has been argued that biotechnologies would only profit the most competitive (and biggest) farmers. This was the conclusion of a Delphi study conducted by O.P.A. in the United States. However, W. Floyd (EC Commission) argues that this is not true in Europe. According to him, small farmers will benefit from biotechnology sometimes even more than big farmers. Floyd illustrates his hypothesis by the results of a model developed by Buckwell in the U.K., integrating the average characteristics of 8 farms representative of the total milk production in the U.K., and the effect that generalized

application of B. Somatotrophin would have on the net revenue per cow. The results he obtained are given in Figure 6-12.

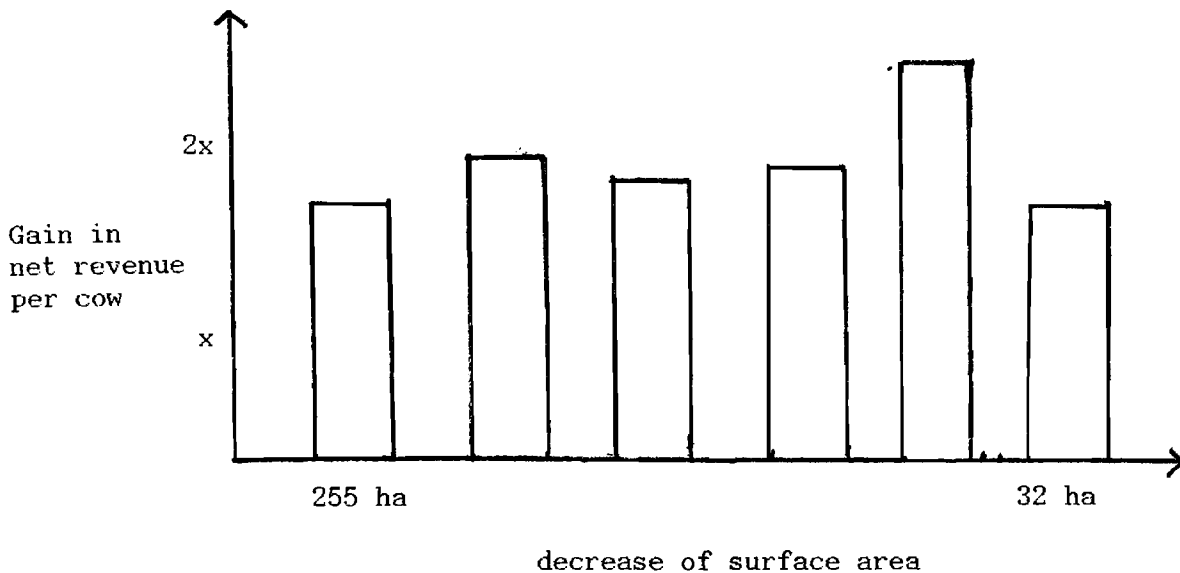

Figure 6-12: Gain in net revenue from milk production per cow as a function of farm area in the UK.

This is the basis of the argument that incentives to adopt biotechnologies are important for small farmers as well as big ones in Europe.

6.4.2 The role of the different actors and risk perception

The structural analysis we have conducted has permitted determination of the different actors involved in the evolution of biotechnological applications to agriculture, and a first evaluation to their importance, which is summarized in Figure 6-13.

We must note that in our analysis, we have considered industries and governments as a whole, and that getting further into detail would necessarily imply individualization. Thus, new important effects of competition would appear at the industrial level. And under "government", both national as well as international organizations (such as the European Parliament) would appear.

The influence of industries and of governments in favoring biotechnology allows K. Sargeant (EC Commission, C.U.B.E.) to state that the biotechnological wave will come, no matter what the current resistances are. But presently, risk factors complicate the system determining the evolution of biotechnologies. This is due to an environmental awareness which did not exist half a century ago.

As a result, the appreciation of risks linked to biotechnological developments can be subdivided as follows:

- scientific consideration and evaluation. That is what we attempted to provide in Section 2.
- an emotional reaction which is particularly acute, since technology has not yet dealt with living organisms, and since the last two decades have seen the occurrence of a series of environmental catastrophies. This emotional reaction is expressed by many actors. According to K. Sargeant, the European Parliament has, for emotional

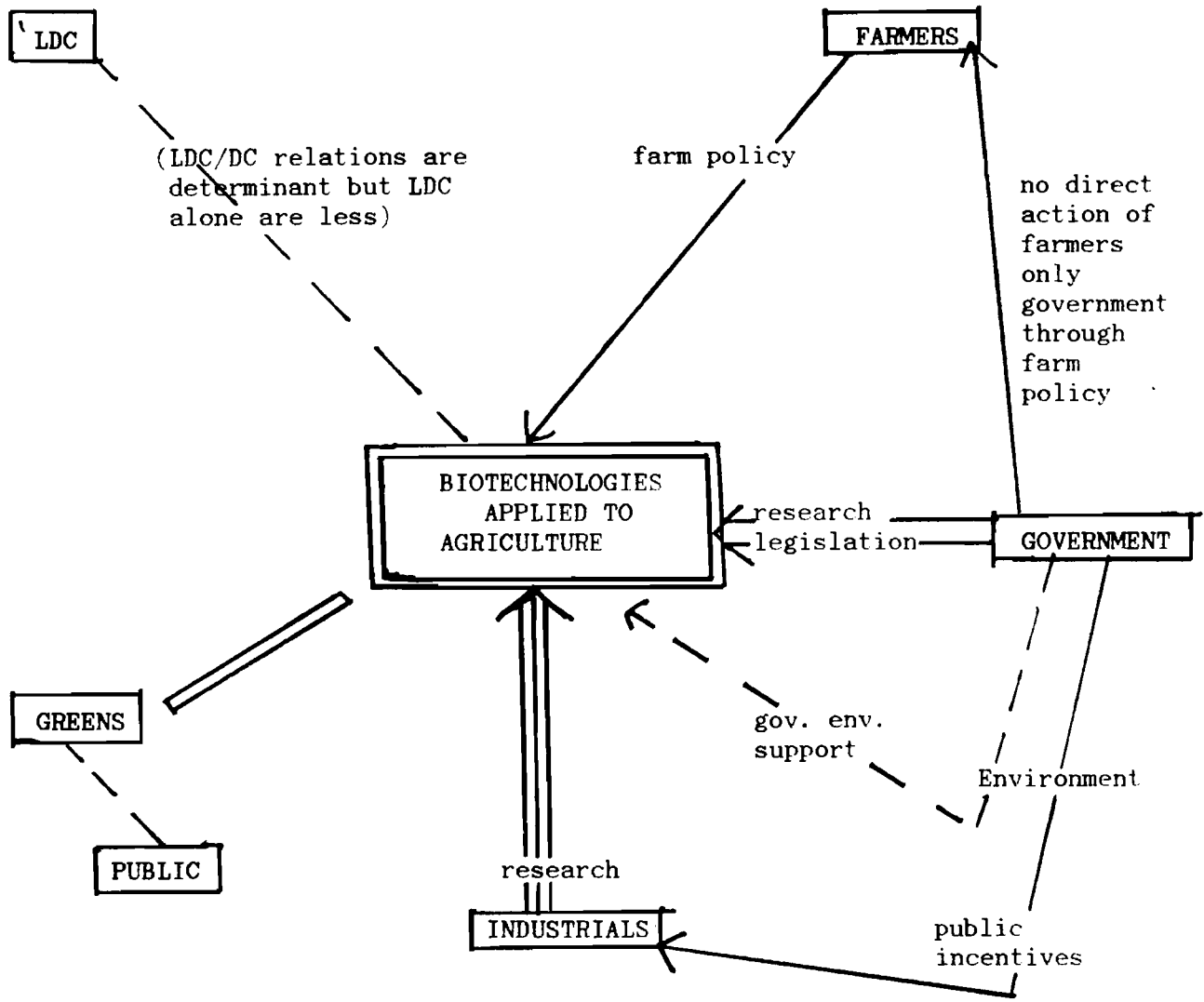

Figure 6-13: Schematic representation of the relations amongst "actors" in the development of agricultural uses of biotechnology.

reasons, voted against the introduction of steroid growth hormones for fattening cattle. According to him, the word "hormone" provokes passionate reactions, and methyl bovin somatotrophin has been deliberately branded as a hormone.

These two elements of risk perception work against the application of biotechnology in agriculture, partly for justifiable reasons but also for irrational reasons. Society pays for the excessive opposition in the sense that it does not profit as early as it could from technological applications capable of improving the economic situation of agriculture.

In fact the debate is often structured as if the trade-off between innovation and the environment is either ecological catastrophe or retardation in technological application. A middle ground is difficult to find, and for this reason the Green movements can be considered as beneficial in the sense that excessive appreciation of risk is preferable to ecological degradation.

However, as noted in the general recommendations of the National Research Council (Agriculture and Biotechnology, 1987), the public must be educated about biotechnology, so as to appreciate both the benefits and the possible risks involved, i.e., the reaction against biotechnological applications should be less emotional. These considerations were highlighted by a group of experts designated by the O.E.C.D. council in July 1983. The next step may be international regulations based on these recommendations.

7. CONCLUSIONS

After having defined technological groups and presented new technologies that may have implications for the environment of the future, we have developed several themes:

- analysis of the risks involved;
- interrelations between technologies;
- consequences on ecology and material flows;
- relations between technologies and political, economic, and social factors;
- construction of a scenario promoting specific ideas on the consideration of the relationship between technology and environment.

We have developed these themes at different levels:

- analysis of a specific technological application, and its implication on one specific variable (e.g., nitrogen fixation and material flow);
- analysis of one technological group and of the way it interacts within a more global context (structural analysis, biotechnology applied to agriculture);
- analysis of several technological groups, but omitting the interactions within the more general context (interrelations between technological groups);
- analysis of several technological groups and of their interactions with one aspect of the general context: environment (risk evaluation);
- analysis of several technological groups in relation to their global context; however, in a "one direction" approach, chosen among others (scenario).

Furthermore, we have consistently approached technology from the point of view of its future evolution or implications, but we have in fact worked on different time frames:

- middle and long term for risk evaluation and for the scenario on material flows. (Long term being considered as 100 years);

- middle term for the interrelations between technological groups and structural analysis, because the different political, economic or social actors or factors may act over a time frame shorter than that of environmental transformations; their long-term role is very hypothetical.

The general ideas emerging from this study are the following:

- The potential risks of these technologies for the environment seem essentially linked to biotechnologies (i.e., release of living micro-organisms in the environment) and to new materials (treatment or recycling of wastes).
- Some technologies are very dependent on others for their future evolution (ecotechnologies), whereas others are determinant (energy). Finally, some are rather independent (new materials).
- In any case, a technological dimension is essential when considering long term environmental transformations, which may be recurring and non-linear.
- Risk anticipation consists not only of projecting the current environmental problems to the future, but also the more difficult task of approaching new problems that may arise.
- Finally, many factors are interrelated, and the analysis of the relationships between technology and environment must take into account other factors as well. For the evolution of biotechnological applications to agriculture, *industries* and *governments* are major determinant factors. This can be generalized to other technologies; hence, the importance of industrial policy in studying environmental evolution.

Our approach to this vast problem has been voluntarily multi-directional. However, there are still other directions to explore and much more to do in the directions we have considered. We shall conclude by proposing other possible approaches to studying technology-environmental interactions.

This type of study emphasizes the importance of bibliographical work, in order to evaluate the controversies existing at the research level, and to provide a context for the construction of possible futures. Furthermore, there is much to learn from bibliographies and data banks. We have seen that research, basic and applied, is a strong determinant of long-term technological evolution. Thus, a global study of research centers working on a given technology, taking into account geographical situation, their private or public nature, their interest in environmental implications, their political weight, their interrelations, and their opinions concerning the future, can stimulate the current state of reflection, and enrich contrasting scenarios for environmental evolution. This can be realized fairly rapidly and exhaustively by use of comprehensive data banks such as that of the Institute of Scientific Information, U.S.

Imaginative scenarios – not necessarily probable ones – are also very interesting, because they may lead more directly to anticipation of currently unforeseen risks than would pure scientific approaches. They imply the use of methodologies from the social sciences and other methods for stimulating the imagination; this multiplicity of inputs seems very important. Of course scenarios must be anchored solidly to ongoing work in the new technologies at the research level, so that imagination is strongly linked to logical implications.

In conclusion, it seems to us that the combination of these approaches would enrich considerably the debate about technological impacts on the environment, especially for those technological fields which to date are almost unexplored with respect to their potential environmental impacts.

APPENDIX A: TECHNICAL DESCRIPTION OF PARTICULAR ECOTECHNOLOGIES

A.1. IMPROVEMENT OF INCINERATION TECHNOLOGIES FOR TREATMENT OF TOXIC MATERIALS

DESCRIPTION:

Traditional ovens for the degradation of toxics are widely used in Europe and Japan, the emergence of environmental legislation against toxic materials having speeded up the R & D effort in the USA and Japan. The various technologies are:

- Rotary ovens
- Fluidized-beds for air treatment
- Pyrolysis
- Plasmic arc
- Laser.

APPLICATION STAGE:

Mostly for industrial use.

IMPACT ON THE ENVIRONMENT:

The two main applications are:

1. The treatment of highly polluted wastes by means other than biodegradation.
2. The purification of specific industrial effluents.

INDUSTRIAL CONTEXT:

- Pyrolysis of organic muds: WANSAN (UK), and MIDLAND ROSS (U.S.) are developing a new pyrolysis system for organic muds which produce biogas. The utilization of a rotary oven improves the transformation.
- Incineration of wastes from the cement industry: SCORI, a subsidiary of LAFARGE COPEE and CIMENTS FRANCAIS (F), is carrying out research on substitutions for traditional fuels. Energy-saving recycling technologies are being introduced into their industrial processes.
- Incineration "in situ" of toxics at contaminated sites: O'CONNOR (WESTINGHOUSE subsidiary) has adapted a traditional incineration process of household refuse to treat PCBs. After authorization by the state of Indiana (USA), decontamination of soils in Bloomington has begun.
- Plasmic arcs: LOOCKEED, in collaboration with E.P.A., WESTINGHOUSE, J.M. HUBER CORP. (U.S.) are now evaluating pilot phase systems. New portable systems, functioning at high temperatures, are now available. The advanced electric reactor (A.E.R.) of Huber Corp is also highly developed. It treats Dioxin, PCBs, and other chlorinated organics. It costs between 300 - 600 dollars per ton.

- AKZO BV (NL) and RHONE POULENC (F) have included a common "laser project" in the "EUREKA" program.

A.2. NEW CHEMICAL TECHNOLOGIES FOR WASTE AND TOXIC TREATMENT

DESCRIPTION:

Development of new technologies for destruction of chemicals and wastes stabilization include:

- Catalytic methods for halogen-component destruction,
- Improvement of the vitrification of radioactive materials,
- Encapsulation of toxics by inorganic polymers,
- Absorption of dioxin by clay,
- Development of active carbon technology to improve fibre capabilities of adsorption and desorption,
- Development of the use of chitin in the filter technologies for the fixation of heavy metals,
- Development of the use of peroxides for the purification of groundwaters.

APPLICATION STAGE:

Very diversified from experimental to applied.

IMPACT ON THE ENVIRONMENT:

These technologies will be useful for improved isolation and storage of specific toxics; few of them chemically transform the toxic components. However, isolation of the toxics does not necessarily solve the problem. Thus the development of these technologies could mask a real environmental problem, if the toxic materials are remobilized in the environment over the long term.

FIRMS AND INDUSTRIAL CONTEXT:

These technologies are applicable to specific toxic materials. They have been developed by various American and Japanese small firms.

A.3. CATALYTIC AND NONCATALYTIC PROCESSES OF DENITRIFICATION IN THERMAL POWER PLANTS

DESCRIPTION:

The problem of NO_x emissions has spurred the development of selective catalytic reduction (SCR) devices that reduce NO_x to NH_4^+ . After early concentration of research on automobiles, the emphasis is shifting towards power plants. Some noncatalytic systems are also being developed.

APPLICATION STAGE:

Commercial and industrial development.

IMPACT ON ENVIRONMENT:

The applications of these technologies to power plants imply a decrease in NO_x emissions. These technologies could improve the yield of denitrification, relative to more traditional devices.

FIRMS AND INDUSTRIAL CONTEXT:

Several new catalyst technologies are emerging from a consortium of large Japanese boiler industry firms. In Europe SHELL (NL) is developing a catalyst using CuO . LINDE (FRG) is also working on this subject. In the United States, NOXSO is developing a catalyst using sodium, and Berkeley University is working on aminoacid catalysts.

German firms are leaders in the new uncatalytic denitrification. In this system, ozone is responsible for the transformation. The system achieves not only denitrification but also desulfurization. A new system using electronic beams is also being developed by German firms.

A.4 IMPROVEMENT OF TRADITIONAL WATER TREATMENT: IMMOBILIZATION OF MICROORGANISMS ON A SPECIAL SUPPORT.

DESCRIPTION:

The fixation of microorganisms and development of highly sophisticated systems may improve traditional ways of treating sludge. For instance, the Fluidized Bed is a technology for immobilizing microorganisms on sand in suspension in a column, by a flow of ascending water.

APPLICATION STAGE:

Industrial development.

IMPACT ON ENVIRONMENT:

The following technologies will improve the treatment of household refuse:

- Diminution of size of sewage plants,
- Increase of transformation yields,
- Increase of specificity of the treatment.

These technologies would have noticeable applications in the output treatment of some industrial processes.

FIRMS AND INDUSTRIAL CONTEXT:

GIST BROCADE (NL) has developed an " Upflow Anaerobic Sludge Blanket" in collaboration with Wageningen University. Water purification, mud and biogas separation are integrated in a single system. DEGREMONT, OTV, ATOCHEM and SGN (in France) have developed plastic materials for fixed cultures in sewage plants. BAYER and HOECHST (F.R.G.) are working on tall vertical bioreactors.

The technology of the fluidized bed applied to bioreactors is being developed by numerous firms in Europe, Japan and the United States.

A.5. SUBSTITUTES FOR CHLOROFLUOROCARBONS (CFCs)

ADVANTAGE:

Protection of stratospheric ozone.

DESCRIPTION:

Chlorofluorocarbons (CFC 11, 12, and 113), and Halons 1211 and 1301 are used in foam blowing, refrigeration, solvents, and other uses. They attack stratospheric ozone which protects the earth's surface from UV radiation. The disappearance of stratospheric ozone may result in dramatic consequences on agriculture and life on earth.

Alternative chemicals have been developed for use in portable air conditioning systems and home appliances (FC 134a), and as substitutes for flexible polyurethane foam (CFC123), rigid polystyrene foam (CFC 124, C 134a), rigid polyolefin foam (CFC 124) and solvents (CFC123, CFC132b).

APPLICATION STAGE:

Patents have been deposited for the pre-cited substitutes in US, Canada, Germany and Japan, but the products are currently unavailable. Some other substitutes have been developed and are available, but they have lower potential application according to the U.S. Environmental Protection Agency.

IMPACT ON ENVIRONMENT:

The risk related to the utilization of such substitutes is that they are unstable or dangerous (flammable).

A.6. IMPROVEMENT OF THERMAL POWER PLANT TECHNOLOGIES: IMPROVED FLUIDIZED BEDS

DESCRIPTION:

Two main technologies are being developed and improved:

- Boilers with low rates of NO_x emissions,
- Fluidized bed combustion.

The fluidized bed technology is the most important. It is an old technology (1920), unused in the past for economic reasons. However, it permits high limits to be set on acid and NO_x emissions. The fuel is burnt on a bed of inert materials in suspension. Combustion air, or a mix of combustion air and recycling gas creates the suspension. Contact between the air and the fuel is enhanced, and thus the ignition temperatures and emissions (which are linked) are lower.

The main R&D orientations are:

- Improvement of fluidized bed technologies.
- The "circulating bed" technology: The bed's materials are carried away and recycled by the flow of air.
- The incineration of toxics.

APPLICATION STAGE:

Commercial and industrial development.

IMPACT ON ENVIRONMENT:

The reduction of nitrogen and sulfur oxides (both responsible for acid rain) has a positive impact on environment. These technologies seem to have no negative side effects, but thermal power plants are built for the long term, and all transformations of the process imply costly changes. Often, in fact, industrial managers prefer to install scrubbers,

although these systems are responsible for an increase in cost of between 5 and 13%. Development of this technology depends on the construction of new thermal power plants.

INDUSTRIAL CONTEXT:

Numerous experimental installations of fluidized beds have been tested in the U.S., Japan, U.K. and F.R.G.. The circulating bed technology has been developed in F.R.G., U.S. and France.

A.7. PLASTICS RECYCLING AND NEW PLASTIC TECHNOLOGIES

DESCRIPTION:

Plastics recovery:

Plastic recycling technologies originated in Japan, and are roughly classified into pellet reclamation and profile reclamation. The process can be divided into three stages :

- Prior treatment,
- Melting and mixed kneading,
- Molding.

Recycled pellets are used for producing toys, miscellaneous daily articles, roofing materials, pipes etc. In some cases, they are mixed with fresh plastics to some extent in order to reduce production costs. In Japan, the pellet industry is no longer a new industry.

Recycling of profiles is produced from lesser quality plastic wastes. The industry is being developed in Japan, and is looking for other markets. The biggest difficulty is in establishing channels for collecting waste which can also be used as raw material. The municipal source of plastic waste is limited. We must also note the difficulty of recycling some plastics like resin, and the bad quality of PVC recycling products.

Other plastics technologies:

Most forecasts assume the development of new types of plastic. The most interesting areas of research are:

- Improvement of biodegradable plastics,
- Polymerization of plastics by biotransformation,
- Improvement of water-soluble plastics,
- Development of new conductor plastics.

APPLICATION STAGE:

Industrial development of plastics recycling.
Research and development of other plastics technologies.

IMPACT ON ENVIRONMENT:

The main advantages of the development of plastics recycling appear to be:

- A decrease in plastics pollution,
- A greater utility of other wastes (because of the prior removal of plastics, which are not biodegradable, for example,
- A saving in energy.

Other technologies should incorporate this new concept of plastics technologies. The use of various new plastics, including components other than organic, will facilitate recycling and degrading abilities.

INDUSTRIAL CONTEXT:

Most of the new developments are in Japan. The "Reverse" program presents an interesting new development. The Plastic Waste Management Institute is facilitating this industrial change.

A.8. MEMBRANE PROCESSES: IMPROVEMENT OF RECYCLING TECHNOLOGY.

DESCRIPTION:

The main purpose is the elimination and separation of specific impurities, and recycling of solid elements in wastes and industrial effluents. The main new technologies are:

- Improvement of traditional membrane processes.
- Electro-dialysis: The process combines the membrane technology with the possibilities of electrotechnologies. New high separation abilities are now available.
- Improvement of reverse osmosis. Since 1970 Du PONT CO (U.S.) has been developing a membrane of reverse osmosis for salinization of seawater and for chlorine and soda production without using mercury and amiant.

APPLICATION STAGE:

Industrial development.

IMPACT ON THE ENVIRONMENT:

The impact could be high in some branches of industry such as the agrofood industry, surface treatment, and the steel industry. Especially in the surface treatment industry which is a highly polluting part of the European industry (5% of suspendable materials, 6% of oxidizable materials, 36.7% of toxicity).

INDUSTRIAL CONTEXT:

The main developments in membrane technology are German and American:

- ENKA - GENERAL ELECTRIC are developing the "hollow fiber" technology. ENKA is developing a high resistant filter that recovers *Cu*, *Ni*, *Cr*, and *U* in solution.
- ESDEX, MEMBRANE TECHNOLOGY CONSULTANTS BV. (F, UK, NL) are working on the purification of the effluents of surface treatment.
- SOGEA ELF ECOLOGIE (F) and ALLIED CORP IONICS (U.S.) are developing electro-dialysis. ELF has built a pilot system which treats chlorinated organics in industrial effluents. ALLIED CORP. is developing a recycling system for fluorides and nitrates in effluents of the steel industry.
- BAYER (FRG), ICI (UK), and ALFA LAVAL (S) are developing recycling technologies for incorporation into other chemical processes.

Applications of reverse osmosis of sludge and industrial effluents are mostly being developed in the USA, Japan and FRG. The R&D is less developed in the Netherlands, France and Sweden.

New applications are being developed in:

- Treatment of radioactive water.
- Organic membranes and filters for ultrafiltration. (The ecotechnologies should profit from the development of ultrafiltration in the agrofood industry.)
- Molecular selection for bioreactors in sewage plants.

A.9. DEVELOPMENT OF INTEGRATED SYSTEMS: APPLICATIONS IN ECOTECHNOLOGIES

DESCRIPTION:

The research is focused on incorporation of innovative new technologies, which associate sensors, communication systems, data treatment and decision support systems. All the new informatics capabilities, like expert systems, will be used increasingly in ecologically oriented industries for network management of water systems and pollution monitoring.

APPLICATION STAGE:

Industrial development.

IMPACT ON THE ENVIRONMENT:

New devices are emerging for better pollution control in treatment plants, and better modeling of pollution processes. Intelligent systems and automation are being developed to mitigate damages, and to have better control of such processes. This environmental control and better environmental management systems will have notable positive impacts

in the future. Hence, the cost of ecotechnologies should decrease.

FIRMS AND INDUSTRIAL CONTEXT:

Ecotechnologies take advantage of the development of intelligent systems developed for other purposes. There are numerous applications:

- HITACHI (Japan): Risk and incident management,
- GEOTOX (USA): Contamination rate assessment,
- STONE WEBSTER (USA): Optimization in equipment management,
- NAT PHYSICAL LAB. (UK): Diagnostics of the water networks,
- PHILIPPS (NL): Expert systems in chemical analysis.

A.10. ADVANCED INSTRUMENTATION

DESCRIPTION:

Ecotechnologies need better sensors for the assessment of environmental information:

- (1) Development of microsensors and miniaturization in the following technologies should improve our knowledge of the environment:
 - Colorimetry,
 - Chromatography,
 - Mass spectroscopy,
 - Spectrophotometry, Laser
- (2) Development of microelectronics, integration of self analysis systems.
- (3) Development of biosensors and adapted transmitters (a highly innovative field). In this technology, the biological signal generator used is either whole cells or an enzyme or both.

APPLICATION STAGE:

Various levels of application from research to industrial applications.

IMPACT ON THE ENVIRONMENT:

These systems should improve our knowledge of environmental conditions. They will be useful for monitoring biotransformations, and controlling bioreactors. Increasing miniaturization should allow new kinds of measurements and assessments to be made in the future.

A.11. BIODEGENERATION OF CHLORINATED-COMPOUNDS

DESCRIPTION

The main use is in the biodegradation of chlorinated organic compounds by natural strains related to *Pseudomonas*. Most of the time, some of their genes are introduced to other bacteria. Thus, they are able to degrade chlorinated-organics in heavily polluted sites. There are two main technologies :

- The first is "in situ". The bacteria, mutated or selected are spread on the contaminated site.
- The second is in a bioreactor. The bacteria are kept in the bioreactor, into which the pollutants are introduced.

APPLICATION STAGE:

Experimental level.

IMPACT ON ENVIRONMENT:

The decontamination of some sites could be possible. The specializations of some cultures are often very high, because of the high adaption abilities of the bacteria.

The release of some mutated bacteria could endanger the environment. In the United States, E.P.A. is working on this problem. The eventual impacts on ecosystems are unforeseeable .

INDUSTRIAL CONTEXT:

In situ: In the United States, Hooker Chemical (an Occidental Petroleum's subsidiary) is developing these bacteria to clean up their Love Canal site. General Electric is also developing these bacteria and is seeking E.P.A. authorization to release them.

DETOX, in the United States, has adapted some strains in a bioreactor, which are able to degrade 99% of PCBs. The cost is 60 to 120 dollars per ton. BIOCLEAN has developed a similar process to degrade pentachlorophenols. The high level of development of these technologies in the United States is partly due to the existence of numerous heavily polluted sites. Many American university faculty are also working on this subject.

In Japan the MITI is encouraging the development of high technologies in microbiological engineering. MITI will soon be able to build a depollution system for the complete series of PCBs. In Europe, only Germany has been involved in similar R&D programs.

A.12. IMPROVEMENT OF TRADITIONAL WATER TREATMENT METHODS: ADAPTED CULTURES

DESCRIPTION:

Researchers have isolated acclimated bacterial cultures in polluted waters. The quality of the strains have been improved in the following ways:

- Selection or mutation.
- Genetic engineering. The plasmids responsible for the degradation of toxics are transferred to *Pseudomonas*, which are then integrated into the pollutant effluent.

APPLICATION STAGE:

Research development.

IMPACT ON ENVIRONMENT:

Biodegradation in situ of toxics in water can be very efficient, because of the high specificity of the microorganisms. The development of these technologies could be important for water treatment. The treatment of hydrocarbons by bacteria could also solve numerous environmental catastrophes. However, spreading of bacteria could create another type of pollution, viz., an organic one. The development of these bacteria in the environment is uncontrolled.

- Nobody knows the impact of spreading new forms of life into the environment
- The methylation of some heavy metals by bacteria could result in increased production of chemicals toxic to living organisms (natural population of rivers and human beings).
- In fact most environmental risks are created by spreading of bacteria in situ. Treatments in confined areas, such as bioreactors, should not create harm to the outdoor environment.

INDUSTRIAL CONTEXT:

GENERAL ELECTRIC (U.S.) was issued the first patent in 1980 for an artificial microorganism capable of treating black tides. In fact, the main subject is the biodegradation of hydrocarbons, in situ. HOECHST (F.R.G.) is working on mercury elimination in wastewaters. LINDE AG (F.R.G.) is developing a pilot study for anaerobic biosorption of heavy metals. Oxford University (U.K.) is working on cadmium elimination in wastewaters. S.L.E. and C.G.E. (F) are also developing new heavy metal treatments. SYBRON, POLYBLAC and FLOWLABORATOIRES (U.S.) are working on mud reduction for sewage plants, using recombined bacteria to treat the sludge.

A.13. ANAEROBIC TREATMENT OF INDUSTRIAL EFFLUENTS: METHANIZATION

DESCRIPTION:

Industrial effluents are degraded by a digester which produces steam and methane. But the technology is less efficient than the activated sludge technique. The transformation is slower, and it requires warming of the reactor. In the future, the technology may be improved to make it more attractive.

APPLICATION STAGE:

Research and development. The Finnish company Tempella has developed the TAMAN multi-stage anaerobic process for the treatment of waste containing organic materials - two fullscale units are in operation.

IMPACT ON ENVIRONMENT:

Possible development for treatment of all the effluents of Agrofood industry (20% of the organic pollution in France). The purified yield will be 95%. Second-degree risks are undefined.

FIRMS AND INDUSTRIAL CONTEXT:

The research is less developed than for activated sludges. The process demands high energy consumption, because of the warming required of the bioreactor. The cost is highly dependent on the price of fossil fuels.

REPLIGEN Corp. (U.S.), CELLULOSE DU PIN and SANDOZ (F) have isolated a bacterium that produces enzymes capable of treating effluents in paper mills. NITTO CHEMICAL INDUSTRY (JAPAN) is preparing a system of treatment of muds in the petrochemical industry. The bacteria used are wocardia and corynebacterium. ADVANCED MINERAL TECHNOLOGIES (U.S.) is developing a recycling system for toxic metals in industrial effluents. The process is about to be commercialized. NIPPON ELECTRIC - WA MINING (JAPAN) have developed a pilot system for the treatment of acid mine residues. They treat ferrite and hematite ores with T.Ferroxidans.

A.14. COAL BIODESULFURIZATION

DESCRIPTION:

The biodesulfurization of coal is a cleaning technology in which the input is purified before combustion, in order to reduce the sulfur yield and the SO_x emissions. The coal is transformed by sulfonobacteria. The rate of SO_x elimination is nearly 90%. In the future, biotransformation of mineral inputs by similar processes could undergo greater development, although they imply higher costs than traditional systems.

APPLICATION STAGE:

Industrial development.

IMPACT ON ENVIRONMENT:

The decrease of the SO_x emissions by this technology could be valuable in the context of acid rain. The principle of treating the inputs rather than the outputs is interesting in the sense that it solves the basic problem.

FIRMS AND INDUSTRIAL CONTEXT:

R&D efforts have been emphasized in F.R.G., U.S. and Japan. ATLANTIC RESEARCH (U.S.) has isolated a bacterium capable of transforming 50% of sulfur components present in coal. German firms have obtained transformation rates of nearly 90%. At the same time, British research institutes are focusing on the bacterium *T. Ferroxidans* for the same application.

A.15. ANAEROBIC UPGRADING OF URBAN WASTES: METHANIZATION.

DESCRIPTION:

Urban wastes are decomposed in a digester with the production of methane (an energy source) and a residue. The inputs are muds from sewage plants of big towns. The outputs are methane and steam used for heating. The digester's residues are a high quality agricultural fertilizer. However, the existence of various toxics in the sludges (like antibiotics), prevents optimization of the treatment.

APPLICATION STAGE:

Industrial development.

IMPACT ON THE ENVIRONMENT:

This technology is a cleaning technology, and also a renewable energy producing system. The biological upgrading of urban wastes should have a highly beneficial impact on the environment.

FIRMS AND INDUSTRIAL CONTEXT:

In Japan, an integrated system has been developed by various firms.

VALORGA S.A. France, Amiens, have developed a plant which transforms about 100,000 tons per years of muds and wastes from household refuses and sewage plant outputs. The pilot installations have no functioning problems. In U.K. WESSEX WATER - SERK are developing new turbines and digesters for anaerobic bioreactors.

APPENDIX B: TECHNICAL DESCRIPTION OF BIOTECHNOLOGIES APPLIED TO AGRICULTURE

B.1. ATMOSPHERIC NITROGEN FIXATION

DESCRIPTION

Description of the biological phenomena

Some bacteria are able to operate the transformation of atmospheric nitrogen into ammonia assimilated by specific plants. They can be symbiotic (case Rhizobium bacteria and leguminous plants), or free (case of cyanobacteria developing in rice paddies).

Biotechnology application

1. Improvement of the existing symbiosis by DNA transfer techniques.
2. Nitrogen fixing bacterial contamination of wheat straw (utilization of straw as carbon source and provision of ammonia in the soil).
3. Creation of new symbiosis with higher plants.
4. Direct fixation of nitrogen by agricultural plants (introduction of the nitrogen fixation capacity into plants' genome).

APPLICATION STAGE

Research Level

1 and 2 may have middle term agricultural application. 3 and 4 are long term developments (if ever, especially for cereals).

IMPACT ON ENVIRONMENT

Advantages

Reduction of the consumption of nitrate fertilizer, implying:

- a decrease of the pollution of ground and under ground waters
- a decrease in energy consumption by the fertilizer industry

Risks

- Extension of the capacity of nitrogen fixation to wild plants (by transfer of genes), implying more resistant weeds (unlikely).
- Increase in pathogenicity (some pathogen micro-organisms develop more easily in environments rich in nitrogen).

- In the case of 2, there is the same problem of pollution of ground waters by nitrates (to a much lesser extent, however, the release of mineral nitrate being done at once).
- Migration of the cereal production in warmer regions as a result of lesser yield of the plant in the same climatic conditions. This would imply a destabilization of the cereal market. However, it is imaginable that nitrogen fixation will not be applied to agriculture if the loss of yield is too important.

B.2 PEST BIODEGRADATION

DESCRIPTION

Utilization of recombined insects

Modification of the genome of a kin of insects pests and introduction in the natural population in order to create sterile descendants.

Hormones

Utilization of pheromones in order to prevent the mating of pest insects, or to disturb their usual behavior.

Virus

Utilization of Baculovirus who attack only specific insects (by this way no perturbation of biotopes). DNA technology could improve this method by improving the toxicity of the virus and increasing the number of its possible hosts.

Bacteria

Modification of a harmless bacterium living on plants by genetic engineering so that it produces toxins.

Incorporation of toxin genes in superior plants

- Some plants have genes coding for pest toxins. Introduction of genes in other plants by interspecific hybridization (but problems of back-crossing and selection because of the simultaneous introduction of undesirable genes).
- Introduction of the genes coding for pest toxins in the seed. The plant which develops has leaves containing toxic crystals. This has already been done on tobacco according to the following scheme:

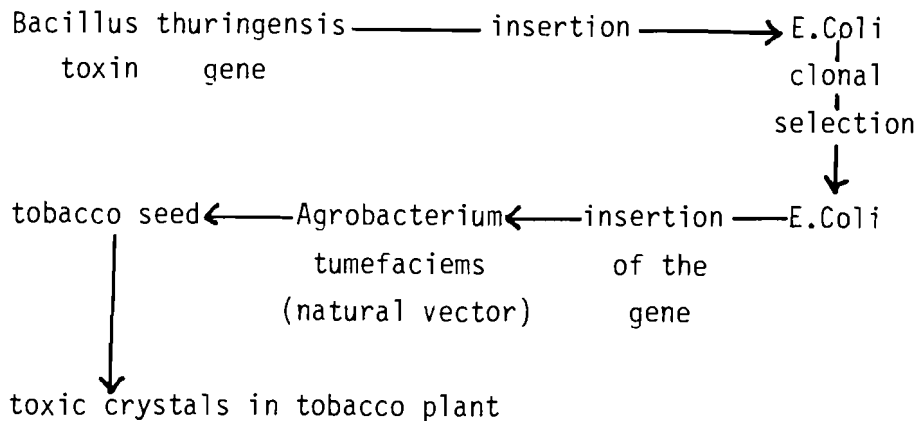

APPLICATION STAGE

Recombined insects: experimental stage (meat fly in Australia).

Virus: commercialization.

USA: Neodipron certifer sold under the name "preserve" by MICROGENESYS.

Bacteria experimentally applied to corn seeds enrobed with *Pseudomonas Fluorescens* in which toxin gene had been incorporated (MONSANTO, 1986).

Incorporation of genes in plants: experimental stage. First application in agriculture around 1990 according to Ghent University, in a longer term according to Cetus Corporation in the U.S. In the U.S., E.P.A. has given authorization to ROHM and HAAS to field test tobacco in which a gene of resistance to caterpillars has been introduced (1987).

IMPACT ON ENVIRONMENT

Advantages:

- Decrease of the pollution of ground waters due to chemical pesticides.
- No adaption of the concerned pests as with chemical pesticides.
- Cheaper

Risks

Pathogenicity for other insects as well as the pest insects, implying a perturbation of biotopes.

B.3. HERBICIDE RESISTANCE

PURPOSE

Resistant weeds have developed in response to chemical herbicides. In consequence of the increase in concentration of chemical weed killers in the soil, agricultural plants must now develop their own resistance.

DESCRIPTION

Cell culture: Culture techniques involve regeneration of entire plants from protoplasts, plant parts or single cells. Obtainment of resistant mutants in culture mediums characterized by an important concentration of herbicides. There is good correlation between the cell resistance and the entire plant resistance.

Genetic engineering: Insertion of vegetal genes (and not bacterial) in another plants's genome. This has already been done for tobacco and tomato, but the difficulties linked to the regeneration of the entire plant from the modified cell are more complex when dealing with monocots.

APPLICATION STAGE

Research application for cell culture (with *Nicotiana glauca*). Atrazine resistant soja obtained by genetic engineering are being tested in Canada. Research is now developing, at an experimental level, on herbicide resistance applied to monocots (MOSANTO, 1987). At experimental level, PLANT GENETIC SYSTEMS have managed to introduce in tobacco, potatoes and tomatoes a gene of resistance to the herbicide phinotricin (commercialized by HOECHST under the name BASTA). Some herbicide resistant plants will be commercialized in the near future.

IMPACT ON ENVIRONMENT

- Lesser productivity of herbicide resistant plants (orientation of part of the metabolism towards the production of the effective proteins)
- But mainly, increase in the quantity of herbicides applied on soil and therefore, of the pollution of waters and soils (for example, if atrazine resistant soja develops, atrazine may be used in larger quantity on the crop preceding soja). For this reason some researchers consider that the development of herbicide resistant plants consists in a bad ecological approach that treats the effect and not the cause (A. Olsthoorn, RIVM Program, Amsterdam). On the other hand, others argue that herbicide resistant plants might result in a more rational utilization of benign herbicides (Mantegazzini, CEE, DG XI; Sargent, CEE, C.U.B.E) and therefore, that the risk is small.
- A new cultural rotation on soils which have been too much impregnated with simazine (weed killer associated with corn) and that can nowadays tolerate no other culture than corn.

B.4. GROWTH ON SALINATED SOILS

DESCRIPTION

By genetic engineering, transfer of halophytes' "osm" gene to other agricultural plants coding for an overproduction of amino acids in order to balance intercellular and extracellular concentrations - insertion of *Salmonella* plasmids in plants.

APPLICATION STAGE

Experimental level (research at the University of California, Davis) possible agricultural application in 10 to 15 years?

Meanwhile, varietal selection has been done in order to obtain varieties resisting a higher degree of salinity (wheat, maize and tomatoes).

IMPACT ON ENVIRONMENT

Advantages

Prevention of the decrease of agricultural land due to salinization of irrigated soils.

Risks

Possible expansion of the salt tolerance to weeds? Increase in total agricultural land favoring an increase of agricultural production.

B.5. ANTI-FREEZE BACTERIA

DESCRIPTION

Recombined INA- bacteria: Deletion of the gene coding for the proteins located at the surface of the bacteria (*Pseudomonas Syringae* type) living on the leaves, and initiating the freezing process at higher temperatures. Spray and development of these recombined bacteria on the plants by creation of a competition effect with the INA+ population.

APPLICATION STAGE

Experimental level. In 1986 in the U.S., the E.P.A. suspended the authorization delivered to Advance Genetic Sciences (AGS) for field tests, under lobby pressures.

IMPACT ON ENVIRONMENT

Advantages

Prevention of the damages caused by spring freezes (some plants supercool when chilled well below their freezing point, because of INA+ bacteria living on the leaves and producing proteins at their surface).

Risks

- Development of pathogenic strains.
- Development of weeds benefiting from the bacteria as well.
- Modification of precipitation (recombined bacteria may spread in the environment and affect the totality of water transformation)?
- And, most important, change in the affectiveness of cultures (advancement of sensitive cultures in colder areas).

B.6. FORESTRY CLONAL SELECTION

DESCRIPTION

Meristematic tissue culture:

- Culture on nutritive gelose, resulting in the obtainment of identical trees.
- Culture in a hormonal medium (2,4 dichlorophenoxyacetic acid), resulting in the obtainment of variants by modification of the genome. This culture could be useful in genetic selection, by isolation of resistant embryos.

APPLICATION STAGE

Culture on nutritive gelose. Application stage for some species (*Eucalyptus*, *Sequoia*, *Douglas Pine Tree* and *Acacia*), experimental stage for others. Experimental stage for cultures in hormonal medium.

IMPACT ON ENVIRONMENT

"Industrial" wood production, implying better productivity, homogenous growth and better resistance to cold and diseases (in temperate climates and therefore profiting to developed countries).

Decrease of genetic diversity implying ecological perturbations and greater sensitivity to all kinds of parasites and to climatic change.

Fundamental transformation of forests:

- "tree fields"
- possible decrease of the total surface of forests.

B.7. ANIMAL PRODUCTION

DESCRIPTION

1. *Utilization of recombinated virus* for the production of vaccines for animals.
2. *Injection of growth hormones* for an accelerated growth of animals and for a greater production (e.g., milk).
3. *Insertion of gene coding* for growth of hormones in animal unicellular embryos.

APPLICATION STAGE

1. Commercialization of a vaccine for pigs (Omnibac PRV) by BIOLOGICS CORP in 1986.
2. *Research level for other vaccines* - European Parliament has voted against the commercialization of Somatotrophin growth hormone utilization for cows in 1987. Giant animals represent a long-term application according to the U.S. Department of Agriculture; a short-term application according to scientists of the University of Ohio.
3. *Experimental level* - "super sheep" and "super pigs" have been obtained in 1986 by scientists of the Animal Production division of the Organization of Scientific and Industrial Research of the Commonwealth, Australia.
4. Compaction and erosion of soil due to larger animals in some areas.
5. More manure implying water pollution by nitrates.
6. Uncontrolled risks due to the utilization of recombinated viruses for vaccines.
7. Overproduction of milk and meat, implying a destabilization of markets.
8. Utilization of animals in goals other than as agricultural products. For example, according to AGRACETUS, it may be possible to engineer cows that produce human insulin in their milk instead of casein. The cows would be milked for insulin. The cost effectiveness of this system versus bacterial fermentation is being considered for mass producing of proteins that have important pharmaceutical value. However, according to K. Sargent (C.U.B.E., CEE), this agricultural side of production for pharmacy instead of food would not concern enough of the animal production to contribute to reducing milk surpluses.

APPENDIX C: TECHNICAL DESCRIPTION OF PARTICULAR ENERGY TECHNOLOGIES

C.1. SUPERCONDUCTIVITY

DESCRIPTION:

The discovery of relatively high-temperature superconducting materials should eventually permit the transport and storage of electricity without losses. The main problem is that currently these materials are only superconductors at very low temperatures. Therefore, a main subject of research thrust is to find materials that will superconduct at higher temperatures. Recent breakthroughs have shown materials with superconducting abilities at liquid nitrogen temperatures. Researchers are assuming that research will ultimately lead to the use of superconductors at ambient temperatures.

The foreseeable applications are various, and the development of other applications, especially in transport, could be interesting.

APPLICATION STAGE:

Research and development.

IMPACT ON THE ENVIRONMENT:

The transport and storage of electricity will have many applications, in terms of energy saving. Hydrogen and superconductors would be competitors for energy transport. Superconductors will be less dangerous than hydrogen.

C.2. NEW HYDROGEN USES

DESCRIPTION:

Various new technologies are coupled to the development of new hydrogen uses.

Use of non-fossil derived hydrogen in coal conversion processes:

The use of NFD (non-fossil-derived) hydrogen for coal gasification allows a higher conversion of carbon in the coal to carbon in the liquid and gaseous fuel products obtained. The effect of this technology is also to increase coal utilization. The technology would be economic if the price of coal were to increase by a factor of 2 to 3 relative to that of nuclear energy (as a source of NFD hydrogen).

Use of hydrogen as a fuel

The development of high speed aircraft appears to provide the first practical application of hydrogen fuel. Moreover, hydrogen, in spite of the danger of its use, may also be the energy currency of the future for cars and ships.

APPLICATION STAGE:

A Japanese study foresees the application of hydrogen as a fuel in submersibles, cargo ships, aircraft and automobiles in the year 2020.

IMPACT ON THE ENVIRONMENT:

The use of hydrogen in coal conversion may upgrade the quality of coal as a fuel. It is also a way of storing NFD hydrogen under safe conditions. However, it does not seem to offer the most optimal use of NFD hydrogen.

The use of hydrogen as a fuel for transport and industry presents the advantage of non-polluting emissions. A major advantage is the elimination of CO_2 emissions associated with traditional fuels. However, because hydrogen is susceptible to explosion, it is considered a rather dangerous fuel. Therefore, high-level safety precautions must be installed for storage and transport. Technological problems related to its distribution should be solved soon.

The use of hydrogen as a fuel for car engines will produce emissions, like NH_xO_y , during air combustion. However, hydrogen-burning engines without pollution emissions are possible through the use of catalysers.

The use of hydrogen as an intermediary fuel permits utilization of various primary energies like methane, electricity (from hydropower, or nuclear power), coal, etc. Hence, hydrogen utilization as a secondary fuel offers wide flexibility, and may provide the best opportunity for energy independence in Europe.

INDUSTRIAL CONTEXT:

Various firms in the aircraft and car industries are working on the technology. The first cars with hydrogen fueled engines are in the pilot stage. Currently, however, the relatively low price of oil does not allow for further development.

C.3. CONTROLLED FUSION

DESCRIPTION:

To produce net power in a non-compression system, fusion reactions must take place at high temperatures. The power production that can occur at the lowest temperature, and hence the most readily attainable fusion process on earth, is the combination of a deuterium nucleus (D) with one of tritium (T). The products are:

- energetic helium: He^4 , the common isotope of helium (alpha particle).
- a more highly energetic free neutron (n)



Deuterium and tritium are confined in ionic form; the hot gas is called "plasma". This plasma forms a ring in a magnetic field which canalizes the stream of alpha particles and neutrons. Due to the confinement, the temperature required is $10^8^{\circ}C$. Under these conditions of ignition, the alpha particles, spiraling in the lines of the magnetic field, remain as plasma. The heat generated in this reaction is then converted to electricity.

APPLICATION STAGE:

Foreseeable first commercial development is in year 2020.

IMPACT ON THE ENVIRONMENT:

The amounts of deuterium and tritium in the fusion-reacting plasma will be so small that a large uncontrolled release of energy would strike the walls of the containment vessel and instantly cease producing nuclear reactions.

There are no long term storage problems with spent fuel materials as those gases not used up in the ongoing fusion reactions are returned to their on-site storage facilities for subsequent use.

Since no fossil fuel is used, there will be no release of chemical-combustion products.

No fission products will form to present a handling and disposal problem. Radioactivity will be produced by neutrons interacting with the reactor structure, but careful selection of materials is expected to minimize the handling and ultimate disposal of activated materials.

The major fuel, deuterium, can be readily extracted from ordinary seawater, which is available to nearly all nations. The surface waters of the earth contain more than 10 tons of deuterium which is an essentially inexhaustible supply. The tritium also required to achieve fusion would be produced as a by-product of the fusion reaction from lithium, which is available from land deposits or from seawater, and which contains thousands of years' supply. The worldwide availability of these materials would reduce international tensions caused by currently existing geographic imbalances in fuel supplies.

Another considerable advantage is that the materials and by-products of fusion are not suitable for use in the production of nuclear weapons.

The most dangerous technological risk is the use of hydrogen, but confinement and safe handling may prevent a major accident.

INDUSTRIAL CONTEXT:

All national and international R&D programs differ, especially in the geometry of the plasma chamber. They have a long-term time frame. The most important programs are:

United States: TFTR/TFM,
Europe: JET,
Japan: JT60,
USSR: TI5.

According to U.S. publications, the first commercial application should come from the STARFIRE project, which should provide a highly efficient machine resulting from an extensive R&D program. The first year of operation is assumed to be 2020. The foreseeable net electrical power should be 1,200 Mw.

In Europe, other forecasts seem to show a development of large scale fusion reactors. The foreseeable power will be 100 Gw. Another research path is the "candor fusion reactors". The system does not require radioactive fuels and does not produce high energy neutrons: The primary relevant reaction is:



C.4. IMPROVEMENT OF DRILLING TECHNOLOGIES: APPLICATION TO NATURAL GAS PROSPECTS

DESCRIPTION:

Advancements in drilling technology allow exploration of new gas fields, in depths where only methane can be expected due to high temperature and pressure conditions. Some scientific studies (Grubler and Nakicenovic 1987) foresee the exploitation of deep reservoirs of natural gas. The importance of these future reserves will allow a change in energy consumption. It also implies decoupling of methane from oil technologies.

APPLICATION STAGE:

Japanese studies foresee the first deep drilling in about 1990.

IMPACT ON THE ENVIRONMENT:

The discovery and delivery of natural gas from important fields should expand our use of natural gas.

The substitution of oil (CH_2) by methane (CH_4) in terms of primary energy, will change the average H/C ratio of the energy source. It is more interesting in the case of coal substitution by methane, because of the lower percentage of carbon in methane. For the same energy consumption, the emission of carbon dioxide will be less for methane than for the other traditional non-renewable energy forms. All substitution by methane will have a positive impact on the environment. However,

methane that escapes into the atmosphere will contribute to greenhouse climate warming.

A greater use of methane in our energy system implies also (for the long term) a substitution to liquid fuels, used in transportation. Numerous technologies are available:

- Methanol synthesis
- Ammonia synthesis (Haber-Bosch process)

C.5. TECHNOLOGIES OF METHANOL CONVERSION

DESCRIPTION:

Methanol can be used to produce a wide range of chemical and energy components.

Ethylene synthesis:

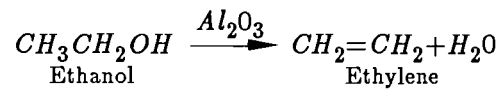
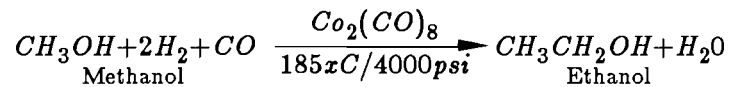

The yield remains low but it could be improved. It should be noted that the entire synthesis of ethylene via this route involves only syngas and catalysts or promoters.

Acetic acid synthesis

Traditional carbonation used a cobalt carbonyl catalyst. Recent developments using a highly active rhodium catalyst have led to a marked improvement in selectivity for converting methanol.

Gasoline synthesis

Catalytic conversion of methanol to gasoline also opens up a potential route to aromatic chemicals such as benzene, toluene and xylene. Methanol is converted to aliphatics and aromatics in gasoline in two stages. Both reactions are exothermic and form the basis of the Mobil process.

The first stage involves dehydration of the crude methanol using a conventional catalyst, yielding a mixture of methanol, dimethyl ether and water.

The second step involves conversion of the hydrocarbons of the mixture over a zeolite catalyst. This transformation offers significant advantages over the traditional Fisher Tropsch route for converting syngas into hydrocarbons since it is considerably more selective. Other applications of the new catalyst will allow conversion of

methanol to formaldehyde, diacetoxyethene, and vinylacetate. These technologies demonstrate the flexibility of methanol as a basis for chemical production.

APPLICATION STAGE:

Industrial developments.

IMPACT ON THE ENVIRONMENT:

The use of methanol as a precursor for a wide range of chemical products may lead to the complete substitution of oil by syngas (from coal) and natural gas. The development of new catalysts for these syntheses may improve the chemical yields of the transformations. The development of cleaner fuels and a variety of products could improve the energy independence of the users. However, the use of methanol as a secondary fuel does not completely solve the problem of CO_2 emissions. If we change the fuel for cars and other transportation systems, it is perhaps better to change it to a non-carbon fuel like hydrogen.

INDUSTRIAL CONTEXT:

These technologies are highly developed in New Zealand and South Africa. Particular economic conditions such as cheap coal supplies and high oil prices are an incentive for the development of these technologies.

C.6. UTILISATION OF NUCLEAR ENERGY FOR PROCESS HEAT: APPLICATION TO COAL CONVERSION

DESCRIPTION:

Progress in the development of the nuclear High Temperature Reactor (HTR) opens the possibility for utilizing Plant Nuclear Process (PNP) heat. The aim is to utilize the HTR as a source of process heat for transforming coal completely to gas. The new process should be more efficient than the traditional large system for coal gasification. The HTR seems to be the next important innovation in the nuclear industry. The energy efficiency of nuclear heat in the final product is likely to be 30 %. Hence, concurrently, it will upgrade coal and uranium use.

APPLICATION STAGE:

This technology may not be exploited commercially before the end of the 1990's.

IMPACT ON THE ENVIRONMENT:

This new technology offers advantages compared with existing processes namely, less emission of pollutants because the HTR instead of a coal-fired boiler is used for production of steam and electricity. Overall, the process produces gas from coal at a lower cost. Hence, it also seems to be a way to save coal.

INDUSTRIAL CONTEXT:

In Germany, the steam gasification of coal (WKV) and the hydrogasification of lignite (HKV) are being developed by Bergbau-Forschung GMBH in Essen.

C.7. COAL INTEGRATED GASIFICATION COMBINED CYCLE

DESCRIPTION:

The coal gasification products are SYNGAS (Synthesis gas) or SNG (Substitute natural gas). The first stage in all synthesis routes is the gasification of the coal to produce synthesis gas ($CO+H_2$). The second stage is a "methanization" step where the hydrogen-enriched syngas reacts to form methane in a catalytic reaction as follows:

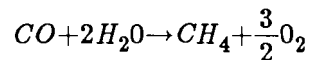
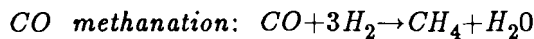

The most interesting type of contacting gasification devices seems to be the "entrained system" which includes, in the same input stream, steam, oxygen and coal. Advances in gas turbine technology indicate that further improvements in efficiency can be realized. Thus, future coal gasification systems may become more economically viable.

Another possibility for eventual development is the old dream of coal gasification "in situ". However, no new breakthroughs can be envisaged in the development of this technology.

APPLICATION STAGE:

Industrial development.

IMPACT ON THE ENVIRONMENT:

The Integrated Gasification Combined Cycle (IGCC) has the following advantages:

- Coal gasification is a clean emission system. It will reduce the emissions of SO_2 and NO_x (reducing acid rain).
- This system will be able to use various fuels including high sulfur coals, without significant penalty. Fuel flexibility should be very interesting for users concerned about energy independence.
- There is also a potential for coproduction of electricity, steam, gaseous fuel, and liquid fuels (methanol), as well as chemical feedstocks in the form of synthesis gas.

INDUSTRIAL CONTEXT:

The development of coal gasification is important in the United States, Germany, and the United Kingdom.

C.8. NOVEL BIOLOGICAL ROUTES TO BIOMASS UTILIZATION

DESCRIPTION:

The production of hydrogen and other fuels by photochemical, photoelectrochemical or photobiological dissociation of water is a potential method for utilizing solar energy. Large-scale production of algal biomass also seems to be possible:

- Nitrogen-fixing blue green algae can be induced to produce hydrogen and nitrogen under oxygen starved conditions.
- Photosynthetic bacteria have been shown to be able to produce large quantities of hydrogen, and even ammonia. Biomass production is also possible, but as researchers seem to assume, the development of these applications will start with the production of chemical and pharmaceutical products with high added value.
- Lignin utilization is an attractive source of chemical feedstocks, but the likelihood of large-scale exploitation in the foreseeable future seems to be remote. However, the first applications of methanol production from lignin have begun in France, and in the foreseeable future they will be more highly developed. Various uses of biomass could be developed. However, the profitability of these applications is not yet competitive with traditional energy forms. At the same time, the traditional technologies for ethanol production from crops (beets, sugar cane, Jerusalem artichoke, etc.) are improving. The Brazilian example shows that profitability is linked to particular economic conditions.

APPLICATION STAGE:

Research and development.

IMPACT ON ENVIRONMENT:

The development of biomass utilization could be a very important source of renewable energy, but it could compete with other energy sources in the future (e.g. solar). We also do not know the impact of the large-scale land conversions required.

INDUSTRIAL CONTEXT:

Numerous programs on biomass production have been started. Europe, France and Sweden have developed ambitious programs of biogas production from forest wastes. A.F.M.E., in France is speeding up the gasification of agricultural wastes. Biogas production is increasing in various fields of applications such as the treatment of pig manures. Other countries like Japan, United States, Canada, New Zealand, and Brazil are developing large projects of biomass development.

APPENDIX D: TECHNICAL DESCRIPTION OF DEVELOPMENTS IN PLASTICS AND CERAMICS

D.1. HIGH ENGINEERING PLASTICS

(1) The automobile

ADVANTAGES:

Lighter materials of equivalent strength, imply less fuel consumption. Less energy will be needed to fabricate plastics.

APPLICATION STAGE:

More and more plastic elements are being integrated into automobiles. GENERAL MOTORS' aim for 1990 is commercialization of 1 million plastic automobile bodies.

IMPACT ON THE ENVIRONMENT:

The decrease of emissions of hydrocarbons, CO, and especially NO_x (decrease of output by decrease of input) could lead to an improvement in air quality. However, there will be an increase of plastic wastes.

Lower energy consumption for fabrication of plastics will result in less demand for non-renewable energy resources. Reduction in the weight of cars would imply a decrease of fuel consumption which could contribute to an increase in the relative importance of other energy sources. According to the French Automobile Industry, a 200 kg weight reduction of cars in Europe would represent an economy of 10 million ton equivalents of petroleum (t.e.p.) per year.

(2) Packaging, Electronics, Computers, Aerospace

ADVANTAGES:

Less energy needed in the production of plastics.

APPLICATION STAGE:

Current, mid-term and long-term applications.

IMPACT ON THE ENVIRONMENT:

The increase of plastic wastes implies an increase of air pollution by combustion of plastics. This evolution will depend on the development of ecotechnologies concerned with treatment and recycling of plastics.

Lower energy consumption for the fabrication of plastics will result in less demand for non-renewable energy resources.

D.2. ENGINEERING CERAMICS:

(1) HIGH COMBUSTION AUTOMOBILE ENGINES

ADVANTAGES:

Ceramics in car engines would enable internal combustion to take place at much higher temperatures, and therefore would lead to less fuel consumption.

Ceramics could also permit a much wider variety of fuels than oil or gas.

APPLICATION STAGE:

Middle-term development of ceramics for use in gas or oil engines. Japanese industries' high scenario is 7 to 8 kg of ceramics in car engines by 1992.

Long-term development of ceramics for use in motors performing with other fuels.

IMPACT ON THE ENVIRONMENT:

Decrease of NO_x air pollution - especially in the case of development of new fuels.

Lower energy consumption resulting in less demand for non-renewable energy resources.

Energy substitution: increase of the relative importance of other energy sources. (cf. Long wave theory, Marchetti (1981)).

(2) ELECTRICAL GENERATORS

ADVANTAGES:

Ceramics could enable electrical generators to operate at higher and more efficient temperatures providing more complete burning of fuels.

APPLICATION STAGE:

Long-term application.

IMPACT ON THE ENVIRONMENT:

More complete burning of fossil fuels would provide fewer pollutants (hydrocarbons, *CO*); especially in countries where electricity is produced mainly with fossil fuel energy (Eastern Europe, United Kingdom, West Germany).

Lower energy consumption would result in less demand for non-renewable energy resources.

E.2. ENVIRONMENTAL CONTEXT

impact or influence over	Environment						
	q	r	s	t	u	v	w
N fix 1	++	(+)			(+)	+	
N fix 2	++	(+)	+		(+)	+	
pest degrad 1							++
pest degrad 2					+		++
herb resis	-		(+)		(+)		
salin soils			++		(+)		
anti freeze			++	+	(+)	+	
forestry			+		+		+
anim prod	-	-			+		
basic res							
applied res	+	+	+				
coop basic/app	(+)	(+)	(+)				
interncoop	+	+	+				
time var dev							
res training							
compet res							
water poll					(+)	+	
air poll	+						
affect cult				(+)			
clim change			+				+
gen divers							
pathogen							
perturb biotope			(+)				
reglementation	+	+					
patents							
regul tests	+	+	+	+	+	+	+
gov target pol	+	+			+		
gov funding res							
incentives firms							
greens							
LDC/DC rel			+				
tech transf DC/LDC			+				
gov sup envir	+	+			-	-	
world prod			+				
LDC agric prod							
farm pol			+				
cost prod							
productivity							
econ yield							
agric surplus			+				
export LDC/DC							
export DC							
indus interest							
tech transfer							
prod substit							
indus interconne							
energy	+	+					
risk business							
media	(+)	(+)					
public percep	(+)	(+)					

E.5. INDUSTRIAL AND ENERGY CONTEXT

impact or influence over	Industry (& Energy)					
	aq	ar	as	at	au	ax
N fix 1 N fix 2 pest degrad 1 pest degrad 2 herb resis salin soils anti freeze forestry anim prod			+/- +/- +/ +/- +/-			(+)
basic res applied res coop basic/app interncoop time var dev res training compet res						+ + + +
water poll air poll affect cult clim change gen divers pathogen perturb biotope						+/- +/-
reglementation patents regul tests gov target pol gov funding res incentives firms greens LDC/DC rel tech transf DC/LDC gov sup envir	++	+	-			- - - + +
world prod LDC agric prod farm pol cost prod productivity econ yield agric surplus export LDC/DC export DC	+/- (+)					+ (-) (-)
indus interest tech transfer prod substit indus interconne energy risk business		+	+	+		+ +/- +/- ++ (+) +
media public percep						

E.6. SOCIAL CONTEXT

impact or influence over	Social Context	
	av	aw
N fix 1 N fix 2 pest degrad 1 pest degrad 2 herb resis salin soils anti freeze forestry anim prod		
basic res applied res coop basic/app interncoop time var dev res training compet res		
water poll air poll affect cult clim change gen divers pathogen perturb biotope	+	+
reglementation patents regul tests gov target pol gov funding res incentives firms greens LDC/DC rel tech transf DC/LDC gov sup envir		+ + +
world prod LDC agric prod farm pol cost prod productivity econ yield agric surplus export LDC/DC export DC		
indus interest tech transfer prod substit indus interconne energy risk business		
media public percep		

REFERENCES

- Association Internationale Futuribles (Nov. 1983): Prospective, provision, planification strategique in, *Futuribles*, No. 71.
- Barker, R. and F.H. Buttel (Dec. 1985): Emerging Agricultural Technologies, Public Policy and Implications for Third World Agriculture: The Case of Biotechnology in, *American Journal of Agricultural Economics*.
- Beier, F.K., R.S. Crespi, J. Straus (1985): Biotechnology and Patent Protection: an International Review, O.E.C.D.
- Bever, B., et al., (1980): Selected papers from the Third Recycling World Congress held in Basle, Switzerland, 29 September - 3 October, 1980, Re-utilization of Waste Materials.
- Barre Remi, R. (1984): Les pluies acides en Europe in, *Futuribles*, (Association Internationale Futuribles).
- Berthelin, J. (May 1987): Des bacteries pour extraire des metaux in, *La Recherche*.
- Billen, et al. (1984): L'Ecosystem Belgique, Essai d'ecologie industriel, (CRISP).
- Bongaerst, Jan C. and R. Andreas Kraemer (1986a): Water pollution control policies: a comparison of France, West Germany, and the Netherlands, I.I.U.G. (International Institute for Environment and Society), Wissenschaftszentrum Berlin.
- Bongaerst, Jan C. and R. Andreas Kraemer (1986b): Small-Scale Power and Electric Utility Regulation: Potential for Reform, I.I.U.G. (International Institute for Environment and Society), Wissenschaftszentrum Berlin.
- Bongaerst, Jan C. and D. Heinrichs (1987): Government support of clean technology research in West Germany: Some Evidence, I.I.U.G. (International Institute for Environment and Society), Wissenschaftszentrum Berlin.
- Brill, W.J. (Dec. 1986): Genetic Engineering Applied to Agriculture: Opportunities and Concerns in, *American Journal of Agricultural Economics*.
- Busch, L., J. Burkhardt, M. Hansen, W.B. Lacy, and L.R. Lacy (1986): Plant breeding and biotechnology: New technologies raise important social questions in, *Bioscience*, vol. 3, No.1
- Chandler, W.U. (October 1983): Materials Recycling, the Virtue of Necessity, Worldwatch Paper No. 56, (Worldwatch Institute).
- Charnockl, A. (Jan. 1986): The Greening of Egypt in, *New Scientist*, Jan. 23, 1986.
- Clark, W.C. and R.E. Munn (eds.) (1986): *Sustainable Development of the Biosphere*, (Cambridge University Press, Cambridge, UK).
- Cocking, E.C. and M.R. Davey (June 1986): Gene Transfer in Cereals in, *Science*, vol. 236.
- Conrad, J. (1984): Nitrates in Ground and Drinking Water, Analysis of Policies and Regulations, I.I.U.G. (International Institute for Environment and Society), Wissenschaftszentrum Berlin.
- Danchin, A. (1986): Les Gelees de Printemps ont un Gene in, *La Recherche*, No. 174, February 1986.
- Davis, D. et al. (1986): Industrial Biotechnology in European Issues for Public Policy, Centre for European Policies Studies, Commission of the European Communities, (Frances Pinter, London and Dover, N.H.).
- Dixon, B. (1985): Genes: Out of the Laboratory, into the Unknown in, *New Scientist*, October 24, 1985.

- Dixon, R.O.D. and C.T. Wheeler (1986): *Nitrogen in Plants*, (Chapman and Hall, New York).
- Dommerges, Y., B. Dreyfus, H.G. Diem, E. Duhoux (1986): Fixation de l'Azote et Agriculture Tropicale in, *La Recherche*, No. 162, January 1986.
- Dorgham, M.A. et al. (1984): Technology in the Year 2000, in *Proceedings of the International Conference on Future Development of Technology*, 4 - 6 April 1984, Interscience Enterprises, Ltd.
- Drouet, D. (1987): *L'innovation dans les Industries de l'environnement, comparaison internationale*, (R & D International).
- Elkington, J. (1985): Biotechnologies: consequences économiques et applications in, *Futuribles*, April 1985.
- FAST Report (1984): EUROFUTURES: The Challenges of Innovation, (Commission of the European Communities in association with the journal *Future*, Butterworths).
- Gibbs, F. and M.E. Greehalgh (1983): Report prepared for the C.E.C., Directorate-General for Science. Research as part of the *FAST Programme: Biotechnology, Chemical Feedstocks and Energy Utilization*, (Frances Pinter, London and Dover, N.H.).
- Gross, R.A. (1984): *Fusion Energy*, (Willey-Interscience Publication, John Willey & Sons).
- Grubler, A. et al., (1987): Grenzkosten der Reduktion von SO_2 F-Emissionen in Oesterreich in, *Wirtschaftspolitische Blätter*, April, 1986.
- Grubler, A. and N. Nakicenovic (1987): The Dynamic Evolution of Methane Technologies, WP-87-2, International Institute for Applied Systems Analysis, Laxenburg, Austria).
- Halsall, D.M. and D.J. Goodchild (1985): Nitrogen Fixation Associated with Development and Localization of Mixed Populations of *Cellulomonas* and *Azospirillum Brasiliense* Grown on Cellulose or Wheat Straw in, *Applied and Environmental Microbiology*, April 1986, vol. 51, pp. 44.
- Hamer, G. (1985): Impacts of Economic Strategies on Biotechnological Developments in, *Trends in Biotechnology*, vol. 3.
- Hardy, R.W.F. and U.D. Havelka (1975): Nitrogen Fixation Research: A Key to World Food? in, *Science*, vol. 188.
- Kramer, R.A. (1986): Re-examining Agricultural Policy: Selected Issues and Alternatives in, *American Journal of Agricultural Economics*, December 1986.
- Krumbein, W.E. (1978): Nitrogen in Soil and its Impact on the Atmosphere in, *Environmental Biochemistry and Geochemistry*, vol. 2, session III, (Ann Arbor Science, Ann Arbor).
- Franzius, V. (1987): Landfill Gas Utilization Experience from the Federal Republic of Germany *Kurtz-Information Blätter*, (Umweltbundesamt Berlin, Federal Republic of Germany).
- Häfele, W., H. Barnert, S. Messner, M. Strubegger, and J. Anderer (1986): Novel integrated energy systems: the case of zero emissions in, *Sustainable Development of the Biosphere*, W.C. Clark and R.E. Munn (eds.) Cambridge: Cambridge University Press.
- Hartje, V.J. (1984): The State of Economic Research in Innovation and Environment in, *I.I.U.G. Discussion Papers*, (Wissenschaftszentrum, Berlin, Federal Republic of Germany).

- Hettelingh, J.P. et al. (1985): *RIM: A Modeling and Information System for the Environment in the Netherlands*, (Institute for Environmental Studies, Free University, Amsterdam, the Netherlands).
- Joly, J. (1985): A.F.M.E.: Les programmes de valorisation de la biomasse in, *La Recherche*.
- Joyce, C. (1985): Brazil goes back to its roots in, *New Scientist*, 18 July 1985.
- Junne, G. and K. van den Doel (1986): Product Substitution through Biotechnology: Impact on the Third World in, *Tibtech*, April 1986.
- Kurunoglu, B.N. et al. (1982): *A Global View of Energy*, (Lexington Books).
- Lavoux, T. (1987): Impacts sur l'environnement des biotechnologies, risques et opportunités in, *SRETIE*, Ministère de l'Environnement, Group de prospective.
- Long, S. (1985): Why only some plants can fix nitrogen in, *New Scientist*, vol. 22.
- Lyons, J.M., R.C. Valentine, A. Phillips, D.W. Rains and R.C. Huffaker (1981): Genetic Engineering of Symbiotic Nitrogen Fixation and Conservation of Fixed Nitrogen in, *Life Sciences*, vol. 17.
- Magnien, E. and D. de Netancourt (1985): *Genetic Engineering of Plants and Microorganisms Important for Agriculture*, (Marinus Nijhoff/Dr. W. Junk Publishers).
- Marchetti, C. (1981): Society as a learning system: Discovery, Invention, and Innovation Cycles Revisited, RR-81-29, (International Institute for Applied Systems Analysis, Laxenburg, Austria).
- Marchetti, C. (1986): The future of hydrogen: an analysis at world level, with a special look at air transport, WP-86-25, (International Institute for Applied Systems Analysis, Laxenburg, Austria).
- Messner, S. et al. (1987): First Order Effects of a Nuclear Moratorium in Central Europe, WP-87-80, (International Institute for Applied Systems Analysis, Laxenburg, Austria).
- Messner, S. et al. (1986): Natural Gas in Europe, WP-86-39, (International Institute for Applied Systems Analysis, Laxenburg, Austria).
- Nakicenovic, N. et al. (1987): Solar Energy Futures in a Western European Context, WP-87-126, (International Institute for Applied Systems Analysis, Laxenburg, Austria).
- Nakicenovic, N. et al. (1986): Patterns of Change: Technological Substitution and Long Waves in the United States, WP-86-13, (International Institute for Applied Systems Analysis, Laxenburg, Austria).
- National Research Council, U.S.A. (1987): *Agriculture and Biotechnology, executive summary and recommendations*, (Washington, National Academy Press), pp.1-15.
- O.E.C.D. (1984): Environment and Economics in, *Proceedings of O.E.C.D. International Conference, June 1984*.
- Olsthoorn, A.A. et al. (1987): Scenario's voor Toekomstige Milieuverontreiniging in, *RIM 25 CONCEPT*, (Institut voor Milieuverontreiniging vu Amsterdam, Netherlands).
- Parker, C.A. (1986): Legumes and nitrogen fixation: their importance for farming in the future in, *Impact of Science on Society*, UNESCO, No. 142.
- Pautz, D. (1987): *Die abfallwirtschaftliche Bedeutung der Erzeugung von Kunststoffen im Automobilbau*, (Umweltbundesamt, Berlin, Federal Republic Germany).
- Rexen, F. and L. Munck (1987): Cereal Crop for Industrial Use in Europe (EEC and the Carlsbergh Research Laboratory).

- Rogner, H.H. (1987a): A Multi Regional Study of European Energy Markets in, *Proceedings of Models for Strategic Energy Decisions in Urban and Regional Context*, Royal Swedish Institute of Technology, (in press)
- Rogner, H.H. (1987b): Technology and the Prospect of Natural Gas Results of Current Gas Studies in, *Energy Policy*, (Butterworth and Co., February, 1988).
- Rogner, H.H. (1986): Long-term Energy Projections and Novel Energy Systems in, *The Changing Carbon Cycle - Global Analysis*, J.R. Trabalka and E. Recchle (eds.), (Springer Verlag, New York, Berlin, 1987), pp. 508-533, (in press).
- Sikyta, B., E. Pavlasova, E. Strejskalova (1986): Biotechnology: Health Care, Agriculture, Industry, Environment in, *Acta Biotechnol.*, 6(1986)2.
- Sinha, S.K., and M.S. Swaminathan (1986): *Global Aspects of Food Production*, (International Rice Research Institute, Tyccooly International).
- Skinner, F.A and P. Uomala (1986): *Nitrogen Fixation with Non Legumes*, (Dordrecht ND: Martinus Nijhoff Publishers).
- Souchu, P. and D. Etchanchu (1988): Nitrogen fertilizer use in Europe: Processes of change, changes in the past, not impossible changes in the next century, Project in IIASA's Young Summer Scientist Program, IIASA Working Paper, (in preparation).
- Stewman, S. and D. Lincoln (1981): Recombinant DNA Breakthroughs in Agriculture, Industry, and Medicine: A Delphi Study in, *Futures*, April 1981.
- Svending, U. and B. Aniansson (eds.) (1986): Surprising Futures in, *Proceedings of the International Workshop on Long-term World Development*, (Friiberggh Manor, Sweden).
- O.E.C.D. (1984): *Proceedings of an International Conference on Environment and Economics*, 18 - 21 June, 1984, vol. I & II.
- Office of Technology Assessment (1984): *Commercial Biotechnology: an International Analysis*, (Washington, D.C.).
- Tapie, P. and A. Vermeglio (1987): A bioconversion de l'energie solaire in, *La Recherche*, May, 1987.
- Tarnowski, D. (1987): Des supraconducteurs sur le chemin des 100 Kelvins in, *La Recherche*, April, 1987.
- Tempe, J. and J. Schell (1987): La Manipulation des Plantes in, *La Recherche*, May 1987, pp.188.
- Tillman, D.A. et al. (1977): *Fuels and Energy From Renewable Resources*, (New York: Academic Press).
- Theys, J. (1985a): L'environnement entre la crise et la modernisation in, *Futuribles*, June 1985.
- Theys, J. (1987b): L'environnement et les ressources au XXI eme Siecle in, *Cahiers Francais*, September 1987.
- UNEP (1984): Environmental Assessment of Ozone Layer Depletion and its Impact as of April 1983 in, *UNEP Bulletin*, No.8.
- Webber, D. (1986): *Engineering Plastics: More Products, More Competition*, (C & News, April 18).
- World Commission on Environment and Development (1987): Food 2000 in, *Global Policies for Sustainable Agriculture*, (Oxford: Oxford University Press).