

## GIS AND ENVIRONMENTAL MODELING

Kurt Fedra

*International Institute for Applied Systems Analysis  
Laxenburg, Austria*

RR-94-2

February 1994

Reprinted from *Environmental Modeling with GIS* (1993) pps. 35–50.

INTERNATIONAL INSTITUTE FOR APPLIED SYSTEMS ANALYSIS  
Laxenburg, Austria

*Research Reports*, which record research conducted at IIASA, are independently reviewed before publication. Views or opinions expressed herein do not necessarily represent those of the Institute, its National Member Organizations, or other organizations supporting the work.

---

Reprinted with permission from *Environmental Modeling with GIS*, 1993, M.F. Goodchild, B.O. Parks, and L.T. Steyaert, eds., Oxford University Press, New York, NY, USA.  
Copyright ©1993 Oxford University Press, Inc.

All rights reserved. No part of this publication may be reproduced or transmitted in any form or by any means, electronic or mechanical, including photocopy, recording, or any information storage or retrieval system, without permission in writing from the copyright holder.

---

Printed by Novographic, Vienna, Austria.

# Preface

Geographical Information Systems (GIS) are a relatively new and rapidly developing class of computer applications. They show considerable potential in a growing number of application domains, regional and environmental planning and management being one of them. The integration of GIS methods adds a key technology for spatial analysis to the set of tools of applied systems analysis, and environmental systems analysis, in particular.

IIASA's Advanced Computer Applications (ACA) project develops and implements environmental information and decision support systems that bring together key technologies such as data base management, simulation and optimization modeling, computer graphics, expert systems, and geographical information systems.

This report is the background material to a keynote address delivered at the First International Conference and Workshop on Integrating Geographic Information Systems and Environmental Modeling, held September 15–19, 1991, in Boulder, Colorado.

Using several of the software systems developed at ACA as examples, the paper explores and illustrates the integration of GIS and modeling as a paradigm shift for both fields, adding more complex and dynamic analytical capabilities to the world of GIS, and better spatial data handling and display functionality to environmental models.

*Kurt Fedra*  
Leader  
Advanced Computer Applications Project



## GIS and Environmental Modeling

KURT FEDRA

Many human activities, such as large-scale industrial, energy, construction, water resources, or agricultural projects driven by increasing resource consumption with increasing affluence and population numbers, considerably affect the natural environment. Growing concern about these impacts and their immediate, as well as long-term, consequences, including risk involved with technological systems and the inherent uncertainty of any forecast, makes the prediction and analysis of environmental impacts and risks the basis for a rational management of our environment, a task of increasing global importance.

Environmental modeling, as one of the scientific tools for this prediction and assessment, is a well-established field of environmental research. International conferences, monographs, and dedicated journals illustrate a mature field.

Most environmental problems do have an obvious spatial dimension. Within the domain of environmental modeling this is addressed by spatially distributed models that describe environmental phenomena in one (for example, in river models), two (land, atmospheric, and water-quality models, models of population dynamics), or three dimensions (again air and water models). The increasing development and use of spatially distributed models replacing simple spatially aggregated or lumped parameter models is, at least in part, driven by the availability of more and more powerful and affordable computers (Loucks and Fedra, 1987; Fedra and Loucks, 1985).

On the other hand, geographical information systems are tools to capture, manipulate, process, and display spatial or geo-referenced data. They contain both geometry data (coordinates and topological information) and attribute data, that is, information describing the properties of geometrical spatial objects such as points, lines, and areas.

In GIS, the basic concept is one of location, of spatial distribution and relationship, and basic elements are spatial objects. In environmental modeling, by contrast, the basic concept is one of state, expressed in terms of numbers, mass, or energy, of interaction and dynamics; the

basic elements are "species," which may be biological, chemical, and environmental media such as air, water, or sediment.

The overlap and relationship is apparent, and thus the integration of these two fields of research, technologies, or sets of methods, that is, their paradigms, is an obvious and promising idea.

This chapter will first present an argument for the integration of the two fields as a paradigm change or rather extension. It will then try to summarize the state of the respective arts and current trends in these two fields, drawing on the available overview papers of this volume. This will be followed by a more detailed analysis of the ways and means of integration from a technical, a modeler's perspective. Finally, the idea of integration will be expanded to cover other areas such as expert systems, scientific visualization, or multimedia systems, and to discuss integration from a perspective of users and uses, that is, institutional aspects of integrated environmental information systems.

---

### INTEGRATING FIELDS OF ENQUIRY: MERGING OF PARADIGMS

---

Merging of fields of research, or adding a new technology to an established and mature field, usually leads to new and exciting developments. Adding the telescope to astronomy (or astrology, for that matter), the portable clock and the sextant to cartography, the microscope to classical biology (i.e., anatomy and morphology), space probes to astrophysics, x rays or the laser to medicine, are just a few arbitrary examples. But they all have had profound effects on the respective fields of enquiry.

Adding the computer to environmental sciences is yet another one of these possibly fruitful mergers. It is not only the technology that allows us to do things better and faster, it is new concepts and ideas, or a new paradigm, that leads us to do different things.

Normal science à la Kuhn (Kuhn, 1962) tends to organize itself into research programs (Lakatos, 1968). They

are supposed to anticipate novel facts and auxiliary theory, and as opposed to pedestrian trial and error (the hallmark of immature science according to Lakatos), they have heuristic power. In other words, they tell us what to do, how to do it, and what to look for. Journals, monographs, textbooks, and peer groups see to that. However, in his *Consolations for the Specialist*, Feyerabend (1970) states that "Everybody may follow his inclinations, and science, conceived as a critical enterprise, will profit from such an activity".

Central to normal science is the paradigm: It has a sociological notion related to the researchers rather than the research; that is, it can function even if an all-encompassing theory or any amount of theoretical underpinning, for that matter, is not there; it is a puzzle-solving device rather than a metaphysical world view; it has to be a concrete picture used analogically, a way of seeing. As something concrete or even crude, a paradigm may literally be a model or a picture, or an analogy-drawing story, or some combination (Masterman, 1970). Thus, a paradigm is something that works, and makes people work, in practical science.

Clearly, this could describe environmental modeling and probably GIS as a field of research, often enough a puzzle-solving activity short on theory with its own way of seeing (and displaying) things. It is exactly this way of seeing things that gets changed, or enlarged, when paradigms are merged and thus at least shifted if not revolutionized. Language, concepts, and tools of different fields can certainly enrich each other.

In GIS, the basic concept is maybe one of location, of spatial distribution, and relationship. Spatial objects such as areas, lines, or points and their usually static properties are the basic units. Interaction is more or less limited to being at the same location, or maybe in close proximity to each other.

By contrast, in environmental modeling the basic concept is one of system state, of mass and energy conservation, of transformation and translocation, of species and individuals' interaction and dynamics. Populations and species, environmental media such as air, water, and soil, and environmental chemicals are the basic units. Since all the basic units, or better, actors, in environmental modeling do have a spatial distribution, and this distribution does affect the processes and dynamics of their interactions considerably, GIS has a lot to offer to environmental modeling. At the same time, an enriched repertoire of object interactions and more explicit dynamics can make GIS a more attractive tool as well.

---

#### GIS AND ENVIRONMENTAL MODELING: STATE OF THE ART

---

Both environmental modeling and GIS are well-established methods and fields of research. Their integration,

however, seems at best an emerging field. A simple analysis of a DIALOG computer search in a number of relevant databases seems to indicate just that. Using Geographical Information System or GIS as a key, individual files like Water Resources Abstracts or Enviroline would yield maybe 100 to 200 entries. Using Environment, several thousand entries would typically be found. Combining the GIS and Environment keys, just a few publications could be identified.

Datafile	GIS	ENV	GIS + ENV
SocSciSearch	181	9,898	6
SciSearch	143	6,118	7
Enviroline	121	25,310	34
Water Resources Abstracts	165	44,696	56
Computer DB	501	21,933	81
INSPEC	1,711	105,781	266

Another piece of circumstantial evidence might be the following: In a hefty volume on Computerized Decision Support Systems for Water Managers (Labadie et al. 1989) a conference proceedings of close to 1000 pages, GIS is not mentioned once (at least according to the subject index). In contrast, and three years later, at a session of the 1991 General Assembly of the European Geophysical Society, dedicated to Decision Support Systems in Hydrology and Water Resources Management, more than half the papers discuss GIS as a component of the research method (EGS, 1991).

And here is another nugget of corroboration: in an article in the *Government Computer News*, Weil (1990) quotes an assistant administrator of EPA as singling out "GIS and modeling as cornerstones for achieving EPA's goals for the 1990s."

While this literature search was neither systematic nor exhaustive, I believe it is certainly indicative: The integration of environmental modeling and GIS is a new and emerging field, and thus, full of opportunities.

#### GIS

GIS are computer-based tools to capture, manipulate, process, and display spatial or geo-referenced data. They contain both geometry data (coordinates and topological information) and attribute data, that is, information describing the properties of geometrical objects such as points, lines, and areas. Berry (Chapter 7), Nyerges (Chapter 8), and Goodchild (Chapter 9) summarize everything you ever wanted to know about GIS.

GIS are quite common and generally accepted in surveying and mapping, cartography, geography, and urban

and regional planning (Smyrnew, 1990; Scholten and Stillwell, 1990) and land resources assessment, with conferences, journals, and monographs documenting an established field (e.g., Burrough, 1986).

For environmental applications in a rather loose sense, including land management, there is considerable tradition in the field, for example, in Canada under the header of land modeling in the Lands Directorate of Environment Canada (e.g., Gélinas, Bond, and Smit, 1988). There are also major initiatives to build up or integrate geographical and environmental databases in many countries worldwide (for example, Kessell, 1990), and in most European countries (e.g., van Est and de Vroege, 1985; Jackson, James, and Stevens, 1988; Sucksdorff, Lemmelä, and Keisteri, 1989) at the European Community level (Wiggins et al., 1986) or at the global level within the UN framework with systems such as GRID (Witt, 1989) or GEMS (Gwynne, 1988).

While many of these systems have explicit environmental components and functions, they are not usually integrated with any modeling capabilities in the sense of simulation models, that is, transport or process and fate models, models of population development, etc. The idea of this integration, however, is obvious and discussed frequently (Granger, 1989; Tikunov, 1989; Fedra, 1990b; Lam and Swayne, 1991).

Recent overview papers on environmental GIS, and more generally, information technology for environmental applications include Jackson, James, and Stevens (1988), or Woodcock, Sham, and Shaw (1990); Moffat, (1990); Bishop, Hull, and Bruce (1991). There are also critical appraisals of the field (e.g., Arend, 1990), but often enough critical question like: GIS, useful tool or expensive toy? are rhetorical in nature.

Current trends in GIS include a better integration between raster- and vector-based systems; in the GIS World survey of 1988 (Parker, 1988), 17 vector-based, 7 raster-based, and 12 supporting both raster and vector formats were listed, with the ArcInfo/ERDAS combination as one of the more widely used ones (Tilley and Sperry, 1988). A recent discussion of hybrid systems is given by Fedra and Kubat (forthcoming). There also is increasing emphasis on remote sensing data as a valuable source of environmental data (Woodcock and Strahler, 1983; Welch, Madden Remillard, and Slack, 1988).

Another interesting line of development is the integration of GIS and expert systems (Maidment and Djokic, 1990; Lam and Swayne, 1991; Davis and Nanninga, 1985; Davis et al. 1991). This aims at a more flexible and complex analysis of maps and map overlays, based on rules and logical inference. Alternatively, GIS can provide spatial data to rule-based assessment systems (Fedra and Winkelbauer, 1991).

Related is the explicit use of GIS as decision support systems (Fedra and Reitsma, 1990; Parent and Church, 1989).

Adding dynamics or temporality in spatial databases (Armstrong, 1988; Langran, 1988) gets them closer to spatially distributed dynamic models. The integration with video technology for fast animation adds yet another feature for better visualization and presentation (Gimblett and Itami, 1988).

One of the more frequently discussed issues is the extension of traditional 2D GIS into full 3D systems (Turner, 1991).

Technically, moving from proprietary systems to open systems, embracing window environments (Gardels, 1988), and experiments with distributed systems (Seaborn, 1988; Ferreira and Menendez, 1988) are notable trends. And Dangermond (Chapter 6) in his report on the GIS developer or vendor's perspective on GIS and model integration provides an overview of what is in store in the commercial sector.

## Environmental modeling

Environmental modeling has a considerable history and development. A number of analytical approaches applied to biological and ecological problems date back to Lotka (1924), and fields like hydrology can look to more than a hundred years of modeling history (Maidment, Chapter 14).

With the advent of digital computers, numerical simulation models became feasible. Early linear models (Patten, 1971), applications of system dynamics to ecological problems (Forrester, 1932), and ever more complex multi-compartment models like CLEANER and MS. CLEANER (Park et al., 1974, 1979) were developed. An overview of environmental systems process modeling is given by Steyaert (Chapter 13).

None of these approaches had explicit spatial dimensions yet. In limnology, oceanography, and plant sociology concepts such as patchiness were discussed, however, not in relation to a fixed coordinate system as used in GIS.

More powerful computers allow more complex models to be developed and run. Spatial distribution and increased dimensionality and resolution is one straightforward way of "improving" models. And spatially distributed models can interact with GIS.

The following sections, based mainly on the overview papers of this volume and the literature survey, summarize current developments and trends in environmental modeling, and emphasize examples of GIS integration.

## Atmospheric systems

In modeling the atmospheric environment, the relationship to geographical data should be self-evident. For more complex models that go beyond the classical Gaussian plume models, topographic relief, surface roughness, and

surface temperatures are important input parameters. Sources of pollution are spatially distributed, and may be point sources such as large industrial stacks or power plants, line sources such as highways, and area sources, such as urban areas.

And for the impact and exposure calculations, land use and population distribution are required, again spatial data that a GIS could well handle. And what is true for local and regional air and air quality models is certainly the case for global models in climate change research.

A recent "prototypical" application of atmospheric modeling with GIS integration is Zack and Minnich (1991), who applied a diagnostic wind field model for forest fire management. A GIS was used both for input data preparation (DEM and meteorological stations) and the display and analysis of model results. And case studies at IASA of air pollution management for the City of Vienna and for Northern Bohemia also apply a tight coupling between air quality simulation models, optimization models for the design of pollution control strategies, and GIS functions (see the following).

Larger-scale models, and in particular, general circulation models (GCM) at a global scale, and their GIS connections are discussed by Lee et al. (Chapter 10). The chapter describes different surface modeling schemes to represent the interface to the GCMs. Coupling with GIS here is mainly seen as a way for proper input characterization, that is, landscape and land-use data preparation.

The coupling between terrestrial and atmospheric systems, and in particular, the role of vegetation in shaping weather and climate, influencing the hydrological cycle, and as sources and sinks of greenhouse gases, is discussed in Schimel's overview paper (Chapter 26).

### Hydrological systems

Maidment (Chapter 14) summarizes the state of the art of hydrological modeling. Hydrological modeling deals with two major topics, namely the quality and quantity of water. Quality concerns have undergone a change in emphasis from oxygen to eutrophication to toxics, following both improvements in treatment technology and analytical chemistry.

Spatial elements are important in marine systems, lake models, and groundwater problems, which have obvious 2 or 3D structure. Finite element and finite difference models provide a well-established discretization of space for these models. River models, in contrast, usually operate in a one-dimensional representation of a sequence of reaches or cells, and networks such as canals or pipes can be represented by a graph with nodes defined in 2D and arcs with the necessary connectivity information.

Maidment sees a major role of GIS in hydrological modeling in its capability to assist explicit treatment of spatial variability. It is important to note, however, that a

GIS is not a source of information, but only a way to manipulate information. Unless appropriate spatially distributed input data exist, even a state of the art GIS coupled with a 3D model will not guarantee reasonable results.

GIS coupling and linkages are described for hydrologic assessment, that is, mapping of hydrologic factors using qualitative or semi-quantitative index-based assessment, for example, of groundwater contamination potential.

The estimation of hydrologic parameters is another area of GIS application: Watershed parameters such as slope, soils, land cover, and channel characteristics can be used for terrain models and simple flow descriptions. These parameters are, of course, of central importance for the land surface and sub-surface process models (Moore et al., Chapter 19).

Recent applications include work on runoff and erosion models (De Roo, Hazelhoff, and Burrough, 1989; Oslin and Morgan, 1988), river basin management (Goulter and Forrest, 1987; Hughes, 1991), surface water modeling (Arnold, Datta, and Haenscheid, 1989; Andreu and Capilla, 1991; White, 1991; Wilde and Drayton, 1991), or groundwater modeling (Steppacher, 1988; Fedra and Diersch, 1989; Fedra, Diersch and Härig, forthcoming; Hedges, 1991; Nachtnebel et al., 1991).

### Land surface and subsurface processes

Watershed models, erosion and non-point modeling, and groundwater modeling are areas of environmental modeling that have an obvious and explicit spatial dimension. Distributed models, and the use of finite difference and finite element schemes, provide a natural opportunity for GIS coupling for both input data preparation as well as for the display and further analysis of model results.

Moore et al. (Chapter 19) discuss GIS and land surface-subsurface process modeling. An important concern in their analysis is one of scale. There are several scale-related issues and problems identified for spatially distributed models and GIS applications: the grid or polygon size, the method used to derive attribute values such as slope, aspect, soil type, for these elements, merging data of different resolution, and the scale differences between model representation and the observational methods used to derive a priori parameter values. A related issue is the concern that by moving from a lumped parameter model to a spatially distributed one, the interpretation of parameters may have to differ.

### Biological and ecological models

Spatial patterns have a considerable history in plant sociology, forestry, and plankton studies. Until recently, any consideration of patterns or spatial distribution, however,



was statistical in nature rather than explicit, that is, connected to absolute location with an  $X,Y$  coordinate system. An earlier spatially distributed ecological model is the famous spruce budworm exercise (Holling, 1978). And in the 1982 state of the art conference in ecological modeling (to pick one more or less at random), only very few examples of spatially distributed models, mainly in the river and lake modeling areas can be found (Lauenroth, Skogerboe, and Flug, 1983).

Hunsaker et al. (Chapter 22) also review a rich literature with numerous examples of studies that include GIS methods in the various applications fields. Again, the review demonstrates a movement from point or spatially lumped models towards distributed models, a development that in part seems to be made possible if not motivated by increasingly affordable computer resources. The trend is clearly towards more spatial resolution, and linkage with GIS as a ready-made technology to handle spatial information.

Application examples include Johnston (1989); Johnston and Naiman (1990); Johnston and Bonde (1989); Johnston et al. (1988); Lindenmayer et al. (1991); and Johnson (1990).

Problems identified by Hunsaker et al. (Chapter 22) include the software engineering problems of tight linkage and data requirements; related to the need for large volumes of data are problems of their effective storage, although this is a largely technical constraint that is changing rapidly as computer technology advances. Problems of scale and uncertainty come up again (see Moore et al., Chapter 19)

Approaches to integration are found to range from GIS as pre- and post-processors to complex "intelligent" GIS with built-in modeling capabilities or expert systems integration (Lam and Swayne, 1991), high-level application, and modeling languages.

### Risk and hazards

The mapping of risk, as a rather abstract concept, makes it much easier to communicate. And elements of environmental and technological risk, from its sources to the recipient, are spatially distributed. Exposure analysis as an overlay of sources and receptors is an almost classical GIS application.

Rejeski (Chapter 30), in his analysis of GIS and risk, emphasizes the cultural dimensions and problems of plural rationalities. Believability, honesty, decision utility, and clarity are major issues he addresses. GIS have the ability to integrate spatial variables into risk assessment models, and maps are powerful visual tools to communicate risk information. A major concern, since risk analysis is a risky business, is again uncertainty.

Recent applications include Best et al. (1990) or the XENVIS system developed at IIASA (see the following).

### Modeling in policy-making

Models are built for a purpose, and scientific research as an end in itself and better understanding is, although noble, increasingly insufficient to get research funded. Direct responsiveness to society's actual and perceived needs is important as well.

Modeling for decision support or model-based decision support systems for environmental problems have been discussed and advocated for a considerable time (Holcomb Research Institute, 1976; Bachmat et al., 1980; Andelin and Niblock, 1982; Loucks, Kindler, and Fedra, 1985; de Wispelaere, Schiermeier, and Gillani, 1986; Labadie et al., 1989; Fedra and Reitsma, 1990; Fedra, 1991). Success stories of actual use in the public debate and policy-making process are somewhat more rare.

In his overview chapter, King (Chapter 34) presents a view of models in what he calls the datawars of public policy-making. Implementation, that is, putting a model into an institution for a political purpose, is the key concept, and a consequently partisan rather than "value free science" approach is advocated.

The specific role of environmental models integrated with GIS would largely be in their ability to communicate effectively, using maps as a well-understood and accepted form of information display, generating a widely accepted and familiar format for a shared information basis.

### Summary

Every field of environmental modeling is increasingly using spatially distributed approaches, and the use of GIS methods can be found everywhere. With ever more powerful and affordable computer technology, spatial distribution and increasing resolution for dynamic environmental models become feasible.

A repeated concern of modelers, however, is in the area of uncertainty, scale, and data availability. Powerful tools can be tempting, and distributed models without good distributed data are at best expensive interpolation tools, and at worst subject to the GIGO (garbage in-garbage out) syndrome. Linkage with GIS is frequently found, but in the majority of cases, GIS and environmental models are not really integrated, they are just used together. GIS are frequently used as pre-processors to prepare spatially distributed input data, and as post-processors to display and possibly analyze model results further. Alternatively, modeling approaches directly built into GIS appear rather simple and restrictive.

---

### LEVELS OF INTEGRATION

---

Integration, trans and multidisciplinary, hybrid, embedded, etc., are recurring keywords in today's modeling lit-

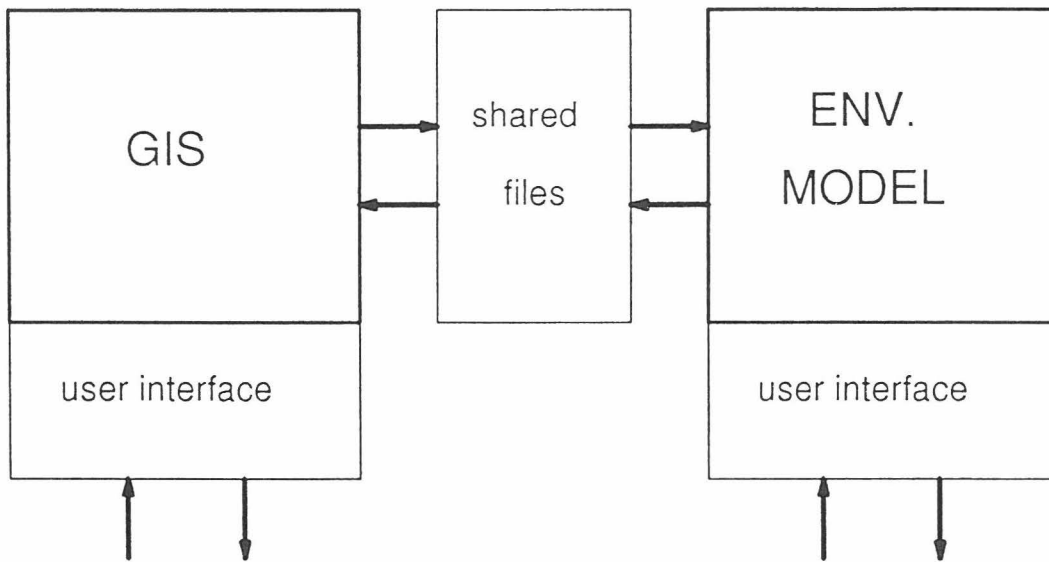

Figure 5-1: Linkage of separate programs through common files.

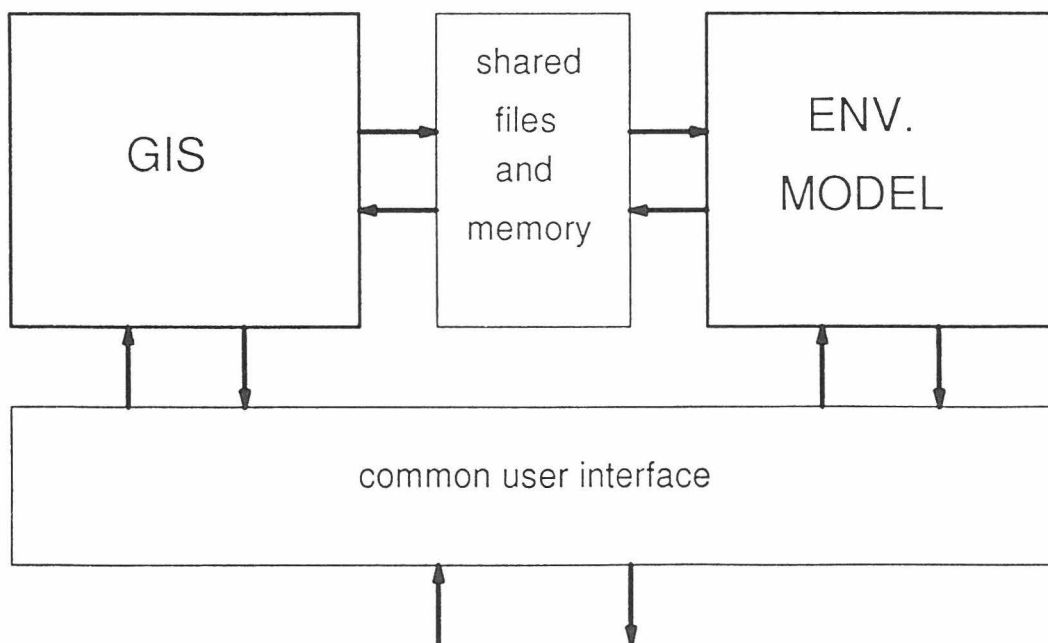

Figure 5-2: Integration within one program with a common interface.

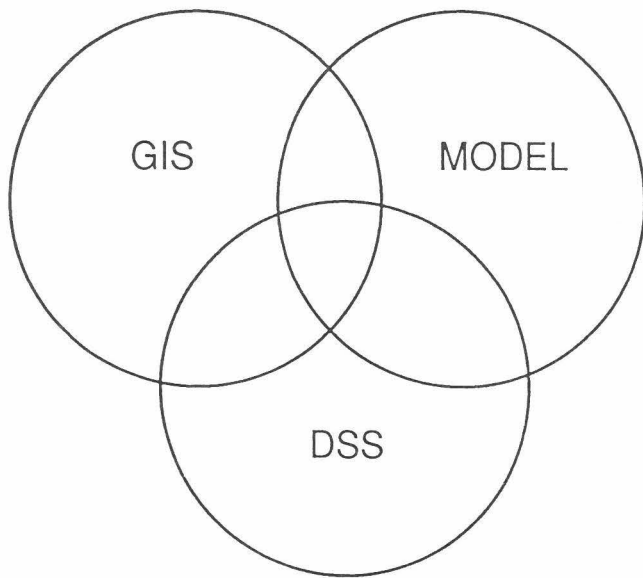

Figure 5-3: Partial functions overlap in a dedicated system.

erature. The integration of GIS and environmental models can come in many forms. In the simplest case, two separate systems, the GIS and the model, just exchange files: The model may read some of its input data from GIS files, and produce some of its output in a format that allows processing and display with the GIS (Figure 5-1).

This seems to be a rather common approach, since it requires little if any software modifications. Only the file formats and the corresponding input and output routines, usually of the model, have to be adapted.

Depending on the implementation, however, a solution based on files shared between two separate applications is cumbersome and error prone. Deeper integration provides a common interface and transparent file or information sharing and transfer between the respective components (Figure 5-2).

One possible way is the use of a higher-level application language or application generators built into the GIS. An alternative is the use of tool kits that provide both GIS functionality as well as interface components for simulation models, and, in the worst case, there is always assembler programming.

A recent example of integration that draws together GIS, models, spreadsheet, and expert systems in a programmable system is RAISON (Lam and Swayne, 1991). Application generators and modeling capabilities with commercial GIS also offer the possibility of tight integration within the limits of the respective package's options.

Any integration at this level, however, requires a suffi-

ciently open GIS architecture that provides the interface and linkages necessary for tight coupling.

For a problem-specific information and decision support system rather than a generic tool, only a subset of the functions a GIS supports may be required for a given application. Functions such as data capture and preprocessing and final analysis can conveniently be separated: They support different users with different time frames. This subset of functionality concept (Figure 5-3) applies equally to models: For the analysis stage, for example, we would assume that the model has already been successfully calibrated. Calibration is an important and often time-consuming and difficult task, but it can be separated from the interactive decision support use of a model.

Parallel to this technical level of coupling, there are different conceptual levels of integration. In the simplest case, the GIS is used to store and manipulate and maybe also analyze distributed model input data; alternatively, the GIS is used to present and maybe further analyze modeling results. A majority of applications found in the literature represent this approach.

A deeper level of integration would merge the two approaches, such that the model becomes one of the analytical functions of a GIS, or the GIS becomes yet another option to generate additional state and output variables in the model, and to provide additional display options.

This requires, however, tools that are sufficiently modular, so that the coupling of software components within one single application with shared memory rather than files and a common interface becomes possible (Figure 5-4). Obviously, this most elegant form of integration is also the most costly one in terms of development effort.

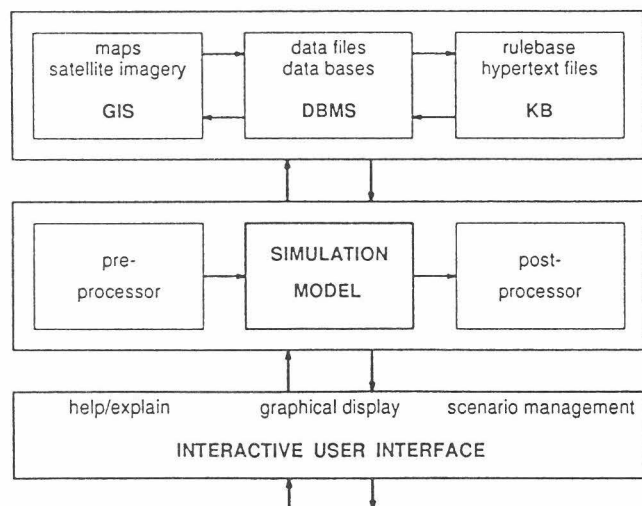

Figure 5-4: Interactive modeling in an integrated framework: a model oriented perspective.

However, if the ultimate goal is not only to develop a better research tool, in the form of more powerful models and analysis software, but also to aid the environmental planning and policy-making process, more than the integration of environmental models and GIS technology will be required to integrate these methods successfully into the policy- and decision-making process.

---

#### TOWARDS BETTER INTEGRATED ENVIRONMENTAL INFORMATION SYSTEMS

---

Given this overall objective of institutional integration for practical application, the task then is to construct and apply better tools for better results. This includes not only collecting more and better data of ever increasing resolution and precision and developing better models and tools for analysis, but also providing more effective interfaces in a technical as well as procedural, organizational, and institutional sense of our efforts with the policy- and decision-making process.

Integrated environmental information and decision support systems, built around one or more coupled models, numerical simulation models or rule-driven inference models, and integrated with GIS, feature:

- An interactive, menu-driven user interface that guides the user with prompt and explain messages through the application. No command language or special format of interaction is necessary. The computer assists the user in its proper use; help and explain functions can be based on hypertext and possibly include multi-media methods to add video and audio technology to provide tutorial and background information.
- Dynamic color graphics for the model output and a symbolic representation of major problem components that allow easy and immediate understanding of basic patterns and relationships. Rather than emphasizing the numerical results, symbolic representations and the visualization of complex patterns support an intuitive understanding of complex systems behavior; the goal is to translate a model's state variables and outputs into the information requirements of the decision-making process.
- The coupling to one or several databases, including GIS, and distributed or remote sources of information in local or wide area networks that provide necessary input information to the models and the user. The user's choice or definition of a specific scenario can be expressed in an aggregated and symbolic, problem-oriented manner without concern for the technical details of the computer implementation.
- Embedded AI components such as specific knowl-

edge bases allow user specifications in allowable ranges to be checked and constrained, and ensure the consistency of an interactively defined scenario.

- They are, wherever feasible, built in direct collaboration with the users, who are, after all, experts in the problem areas these systems address.

In summary, integrated information systems are designed for easy and efficient use, even in data-poor situations, and cater to the user's degree of computer expertise. The "intelligent" interface and its transparent pre- and post-processing functions free the user from the time-consuming and error-prone tasks of data file preparation, the mechanics of model runs, and finally the interpretation and translation of numerical results into meaningful terms that are adequate to the problem. This not only allows the user to employ the models more freely in a more experimental and interesting way, it also allows the analyst to concentrate on the more important tasks he can do best, that is, the recognition of emerging patterns, the comparative evaluation of complex alternatives, and the entire institutional aspects of any environmental impact assessment rather than its technicalities.

The models, and their interfaces, are representations of the problems they address as much as of the planning and decision-making processes they are designed to support. In the latter field, if not also in the former, their users are the real experts. Thus, their expertise and experience needs to be included in the systems. As a consequence, the user must be involved in the design and development, so that he can accept responsibility and ownership for the software system.

Institutional integration also must look at aspects such as user training, data entry, maintenance issues of keeping systems current and operational, providing adaptations and updates, etc. Any complex information system has more than one user at more than one level of technical competence and with different roles within an institution. Different users have different requirements that need to be supported: Flexibility and adaptability are therefore important features. Systems must be able to grow with their users. Therefore, the institutional commitment and technical infrastructure to keep a system alive and evolving are as important as the scientific and technical quality of the original software system.

It is, however, important to recognize that there is a price to be paid for the ease of use and all the features of these systems: Not only are they more expensive to build—after all, all the information that makes them smart has to be compiled and included at some stage—they are also much less flexible than their more conventional, general-purpose siblings. Only by restricting the range of applications are we able to build more application-specific knowledge into the systems and thus make them appear smart. There is no such thing as the general-purpose

problem solver, or a generic model or decision support system that is easy to use. Mastery of a problem area comes at the price of increasingly narrow specialization.

Certainly the expert systems approach, or any computerized decision support system for that matter, is not a replacement for the human expert in such a complex problem domain; it still requires a knowledgeable and responsible person to use it, to interpret and apply the results. However, the system will take care of the more mundane tasks of data handling, freeing the analyst to concentrate on the real problems that require human creativity.

Integrated software systems, whether they are expert systems or based on simulation or optimization models, organize the planning or decision-making process; they provide structure, ensure completeness, and may even ascertain plausibility. It is the easy to use "smart" interface, the fast and efficient operation, and the apparent intelligence of the programs that makes them attractive. Based not only on the organized collection of experience from numerous experts, and international literature, but also on various guidelines, regulations, and environmental law, a system's knowledge base, with or without one or more numerical models in its core, may indeed provide intelligent advice to any individual user.

For the specific model and GIS coupling, this means that their respective functions are fully and transparently integrated. Imagine a system that is structured not in terms of state variables and parameters, or spatial objects and attributes, but in terms of problems and problem owners, intentions and objectives, constraints and regulations, options and decision alternatives, facts and assumptions, preferences and perceptions.

A problem is represented by a set of descriptors, some of which may be spatially distributed or derived from spatially distributed descriptors, within a context of facts and assumptions. The user can now manipulate and analyze his problem situation in terms of decisions or assumptions, and explore the behavior of his system in response to any of his specifications. This may involve queries to databases, browsing through a hypertext system, or running simulation or optimization models, using expert systems, and of course GIS functions for both mapping as well as spatial analysis. In most practical situations, it will involve all of the above and more. For the user it is immaterial which method is used to generate the answer to his questions, to provide insights or arguments, help structure his thinking and communicate information within a group. In fact, it will usually be the combination of several "methods" or tools that are required.

If the problem is spatial in nature, and most if not all practical environmental problems are, the distinction between GIS and spatial model disappears. The system provides a coordinated set of functions or tools that cooperate in a common environment, within a single integrated system.

### Application examples

To illustrate the concept of integrated environmental information systems better, I would like to present a few examples, first prototypes that illustrate, or rather experiment with, some of these concepts. I apologize for drawing them all from our own work at ILASA's Advanced Computer Applications Project, but, for obvious reasons, these are the ones I have most information on. A typical example system is an environmental information system for the city of Hanover. It combines a GIS component with simulation models for specific problems, such as groundwater or air pollution.

The GIS forms a central framework and integrating component, providing a variety of map types for use in the system. Maps or overlays include simple line features, such as the city boundaries or complex topical maps as background for the spatially distributed models, including model input data sets. Examples would be a landuse map, the geological map, or a biotope map, stored in vector format, or groundwater head and groundwater recharge, stored as grid cell files. Similar to the model input files, model results, (i.e., computed groundwater heads or concentration fields of pollutants from air, ground- or surface water models) can also be stored as grid cell files.

Another raster format integrated in the GIS is a SPOT satellite image of the city area. The satellite image is stored and treated as a "true" raster, that is, only color numbers, the attribute data, are stored rather than the original multi-spectral data.

While most of the maps fully cover the entire area, an interactive map editor allows one to select individual features from a given map for an overlay. For example, from the full area coverage of the landuse map, only the road and rail network, or the area above a certain threshold value of pollution as computed by a model, can be extracted as an overlay for the biotope map, for example, for transportation corridor analysis. A color editor offers the possibility to adjust the display color and style of a given feature so that any arbitrary combination of features and overlays will result in a well-designed display, highlighting the important features.

From a user point of view, all these different maps, including model input data and model results, are equivalent; the user is not necessarily aware of their structural differences. Composite maps can be generated by overlaying the various maps or subsets of features of the maps (Plate 5-1), and the GIS offers the possibility of zooming into any subarea down to the limits of the resolution of the database. Here, the differences between vector and raster formats become obvious. One of the models in the system is a finite-difference-based groundwater flow and transport model, using a particle tracking scheme (Fedra, Diersch, and Härig, forthcoming). The model uses spatially distributed input data, such as initial head, porosity, or groundwater recharge, that are also available as overlay

planes in the GIS. The GIS functions can be called directly from the model so that the various data sets can be viewed and analyzed. At the same time, a problem relevant background map such as the geological map or the biotope map, or combined selected features can be prepared interactively.

Model output (groundwater head, flows, and pollutant concentration) is displayed dynamically over the background map. The user can modify the display at any point, stop or rerun the model with alternative scenario assumptions, etc. (Plate 5-2). Model output can also be stored as a map overlay, and thus passed to the GIS for further analysis in conjunction with other overlay planes such as landuse, etc. However, since the GIS functions are directly accessible from the model interface, there are no differences for the user between model or GIS functions. They both serve to analyze his problems and help him to design a meaningful representation and display.

To this end, other features include a built-in expert system for parameter estimation and input feasibility checking. This will, for example, advise the user on reasonable pumping rates for wells introduced in the simulation (Plate 5-3) or check the proper design and location for remediation strategies such as hydraulic barriers or interception pumping. Another feature is a hypertext-based help and explain system, which can provide background information on models, data, assumptions, and explain parameters as well as the results from the expert system's use.

A similar approach is used in a series of air quality models, both on a local and a regional scale (Plate 5-4). Again the models are operated in a GIS context, with a map background and data such as the emission sources, topography, surface roughness, and temperature managed by the GIS.

In addition to the dynamic simulation model, optimization tools allow one to design cost-effective pollution abatement strategies. Here objective functions including human health criteria, such as exposure, are derived from the spatially distributed model output (on a regular grid), superimposed on administrative units (polygons) with associated population and age distribution data (tabular). Land use, analyzed for an environmental impact criterion, is derived from satellite imagery.

It is interesting to note that, from the GIS perspective, many of the "maps" or "overlays" are not stored as data, but are dynamically generated and regenerated by a model, or a set of rules from an expert system. There is, however, a trade-off between computation times and storage space. In other examples, dynamic data may be stored rather than computed on request, simply for reasons of efficiency. An example is CLIMEX, an expert system for climate impact assessment with a global GIS. Monthly climate data and GCM results and population data are stored in the respective formats, and can be seen in an

animated display. These data are then used for regional rule-based impact assessment.

Another reason for storing selected model results is the ability to compare different scenarios and generate, for example, the delta of two pollution concentration fields resulting from alternative abatement policies. But even in this case, parallel or distributed processing may provide the computer power to run several scenarios simultaneously.

Other applications of integrated environmental information systems with various technologies combined include MEXSES, an expert system for environmental impact assessment that includes both GIS and dynamic simulation models (Fedra and Winkelbauer, 1991). The inference engine in processing the rules to assess environmental impacts can use more rules to infer facts. It can, if appropriate, get data from the GIS (examples would be soils and slopes, vegetation, land use, etc. for a given project location), derive them from a simulation model, or ask the user. Where the information required comes from is more or less transparent for the user. And the strategy (i.e., which source of information to try first) is controlled by the knowledge base of the system and can be modified dynamically, based on context and state of the system.

REPLACE is a spatial expert system for site suitability analysis (Reitsma, 1990). Implemented in PROLOG and with a graphical user interface, it matches the spatial requirements of "activities" such as industrial plants or hospitals with spatial properties such as physiography, infrastructure, or environmental constraints (Plate 5-5). REPLACE, rather than being a spatial model, models space. By sharing data with a number of related simulation and optimization models as well as statistical and geographical databases, it is an integrated component of a modular regional information and decision support system (Fedra et al., 1987).

XENVIS is a national level environmental information system implemented for the Netherlands, that incorporates a GIS, a water quality model for simulation of spills of toxics into the Rhine, a transportation risk analysis model, and an interface to a fault-tree-based risk assessment system for process industries. Model output, including risk contour plots based on plant safety characteristics, weather data, and population distribution, is displayed over an interactively constructed map (Plate 5-6). Designed for risk analysis and risk communication, the system also includes a noise analysis module for railways and a number of interrelated databases, implemented in a hypertext structure, covering topics such as hazardous installations or chemicals.

These and similar applications are described by Fedra (1991), Fedra (1990a,b), and Fedra and Reitsma (1990).

## Uses and users

Advocating integrated environmental information systems as a central theme for environmental research, research in GIS, and in the coupling of GIS and environmental models is based on a few personal political science premises.

First, that what scientists do, or should do, is to ultimately assist societal decision making-processes; that research priorities are set, or should be set, in response or better anticipation of societal needs and problems; and third, that a sustainable development of life on this planet and the generation or maintenance of an enjoyable environment for future generations is, or should be, one of the basic goals of our societies.

A very similar credo, by the way, was formulated by E.W. Manning from the Lands Directorate in Canada, in the context of land modeling (Manning, 1988). Like any other tools, environmental models with integrated GIS, or the other way around, are built for a purpose, for users.

Like many computer-based models and methods, integrated environmental information systems and their components, such as simulation models and GIS, are potentially useful. A large amount of formal, mathematical, and computational methods have been developed in the area of environmental planning and management, and the field has a considerable history in the use of computers. However, to turn a potentially useful method into one actually used requires a number of special features as well as an approach that takes psychological and institutional aspects as well as scientific and technical ones into account.

Tools that are easy to use, equipped with a friendly user interface, use problem-adequate representation formats and a high degree of visualization, are customized for an institution and its specific view of problems and are developed in close collaboration with the end user, stand a better chance of being used than tools that are based on "only" good science.

Good science is a necessary, but certainly not sufficient, condition for a useful and usable information and decision support system; there are definite advantages to increased user participation, with consideration of questions of maintenance and the update of information requirements from the very beginning, but also questions of control and ownership, responsibility, and credibility.

All science is propaganda, to paraphrase Paul Feyerabend again, and a strong argument along this line is provided by King (Chapter 34) on modeling in the policy process. I must hasten to add, however, that while I find his arguments most convincing, I cannot follow all his conclusions. Decades of neopositivist brainwashing in academe (and in Vienna circles) have led me to believe that indeed, and if only in the long run, truth wins (sometimes). You can probably cheat your way out of a hearing with the fancier model, but you cannot cheat thermody-

namics (not with cold fusion) and evolution in the long run. Having real practical use is important for a model. Being close to reality (which of course includes the policy-making process as part of the overall environmental system) is at least equally important.

Having said that, I can agree, however, that in most decision-making situations the model is not so much a model of reality, and thus subject to all our scientific aspirations. It is rather a tool to help organize a learning or bargaining exercise, where it is more important that it provides a framework, a mirror for our thinking, stimulation or excuses, or justification for compromise. However, models and information systems are used at various levels in the policy making process, and the research level is certainly one of them. Uses and user requirements differ considerably at these levels, and the challenge is to provide a smooth and credible connection between these different levels of abstraction, detail, and interpretation.

Advanced information technology provides the tools to design and implement smart software, where in a broad sense, the emphasis is on the man-machine interface. Integration, interaction, intelligence, visualization, and customization are key concepts that are briefly discussed below.

Integration implies that in any given software system for real-world applications, more than one problem representation form or model, several sources of information or databases, and finally a multi-faceted and problem-oriented user interface ought to be combined in a common framework to provide a useful and realistic information base. The integration of environmental modeling and GIS is one step in this direction.

Interaction is a central feature of any effective man-machine system: a real-time dialogue allows the user to define and explore a problem incrementally in response to immediate answers from the system; fast and powerful systems with modern processor technology can offer the possibility to simulate dynamic processes with animated output, and they can provide a high degree of responsiveness that is essential to maintain a successful dialogue and direct control over the software.

Intelligence requires software to be "knowledgeable," not only about its own possibilities and constraints, but also about the application domain and about the user, that is, the context of its use. Defaults and predefined options in a menu system, sensitivity to context and history of use, learning, or alternative ways of problem specification, can all be achieved by the integration of expert systems technology in the user interface and in the system itself.

Visualization provides the bandwidth necessary to understand large amounts of highly structured information, and permits the development of an intuitive understanding of processes and interdependencies, of spatial and temporal patterns, and complex systems in general. Many of the problem components in a real-world planning or management situation are rather abstract: Representing

them in a symbolic, graphical format that allows visual inspection of systems behavior and symbolic interaction with the machine and its software is an important element in friendly and easy to use computer-based systems.

Customization is based on the direct involvement of the end user in systems design and development. It is his view of the problem and his experience in many aspects of the management and decision-making process that the system is designed to support. This then must be central to a system's implementation to provide the basis for user acceptance.

Software and computer-based tools are designed to make things easier for the human user, and they improve the efficiency and quality of information processing tasks. In practice, only very few programs do that. They make things possible that would not be possible without the computer, but they rarely make it easy on the user.

As with the better mousetrap, one would expect to see demand for such techniques. However, simply doing things faster—once all the input has been painstakingly collected and entered, or solving a more complex version of the problem—and then leaving it to the user to extract the meaning from a flood of output and translate into his problem description language may not rate as a better mousetrap in the eye of the practitioner. All tools, and models in particular, have to become integrated parts in a much more complex information processing and decision-making procedure, which involves not only running the model, but certainly preparing its inputs over and over again, interpreting and communicating its results, and making them fit the usually rather formalized framework of the existing procedures.

There are several important aspects that need to be addressed. Computer-based tools, information and decision support systems as a rule imply a change in personal work habits, institutional procedures, and thus, institutional culture. While they may or may not change what is done, they most certainly change the way things are done—if they are used.

There is a tradeoff between the efficiency and ease of use and the flexibility of a system. The more options are predetermined and available from a menu of choices, the more defaults are provided, the easier it becomes to use a system for an increasingly smaller set of tasks.

There also is a tradeoff between the ease of understanding and the (at least numerical) precision of results. Providing a visual graphical or symbolic representation changes the quality of the information provided from a quantitative and thus at least apparently precise format, to a qualitative format. The latter, however, certainly is more appropriate to display patterns and complex interdependencies.

Finally, the easier a system is to use for some, the harder it is to make, and possibly also to maintain. Predefined options need to be defined at some point, and a knowledge base must be well developed and tested to work reliably.

Automatic downloading of data and defaults requires that these data and defaults have been compiled and prepared in the first place. Thus, use has to be understood in a much wider sense, including problems of data collection and preparation, keeping data current, communicating and using the output within the institutional framework and communication channels, adapting the system to changing requirements, training new users, etc.

### Ceterum censeo

The integration of environmental models and GIS is an obvious, challenging, and promising development in environmental research.

The need for better tools to handle ever more critical environmental problems is obvious, and the rapidly developing field of information technology provides the necessary machinery. To exploit the full potential of this integration, however, I believe it is important to try to really merge and combine modeling and GIS, rather than just using them together. The challenge is in merging the respective paradigms to create a new field of integrated environmental information systems that goes beyond models and GIS. Problem-oriented but scientifically based, with the computer as one of the most versatile tools and technologies as its basis, integrated environmental information systems should find their place both in academic research as well as in public policy-making.

---

### REFERENCES

---

- Andelin, J., and Niblock, R.W. (1982) *Use of Models for Water Resources Management, Planning, and Policy. Office of Technology Assessment Report*, Washington, DC: Congress of the United States.
- Andreu, J., and Capilla, J. (1991) A computer aided support system for complex water resources schemes management. *Annales Geophysicae*. Supplement to Volume 9. XVI General Assembly Wiesbaden. 22–26 April, 1991, European Geophysical Society, p. C476.
- Anthony, S.J., and Corr, D.G. (1987) Data structures in an integrated geographical information system. *ESA Journal*, 11/12: 69–72.
- Arend, R.B. (1990) GIS: useful tool or expensive toy? *Journal of Surveying Engineering* 116(2): 131–138.
- Armstrong, M.P. (1988) Temporality in spatial databases. *GIS/LIS '88, Accessing the World. Proceedings, Third annual international conference, San Antonio*, Vol 2, pp. 880–889.
- Armstrong, M.P., and Densham P.J. (1990) Database organization strategies for spatial decision support systems. *Int. J. Geographical Information Systems* 4(1): 3–20.



- Arnold, U., Datta, B., and Haenscheid, P. (1989) Intelligent geographic information systems (IGIS) and surface water modeling. *New Directions for Surface Water Modeling (Proceedings of the Baltimore Symposium)*, pp. 407–416.
- Bachmat, Y., Bredehoeft, J., Andrews, B., Holtz, D., and Sebastian, S. (1980) Groundwater management: the use of numerical models. *Water Resources Monograph 5*, Washington, D.C.: American Geophysical Union.
- Best, R.G., Guber, A.L., Kliman, D.H., Kowalkowski, S.M., Rohde, S.L., and Tinney, L.R. (1990) Emergency response and environmental applications of geographic information systems. *Transactions of the American Nuclear Society 62*: 42–43.
- Bishop, I.D., Hull I.V., and Bruce, R. (1991) Integrating technologies for visual resource management. *Journal of Environmental Management 32*: 295–312.
- Burrough, P.A. (1986) *Principles of Geographical Information Systems for Land Resources Assessment*. Monographs on Soil and Resources Survey, Oxford: Clarendon Press, 193pp.
- Davis, J.R., Cuddy, S.M., Laut, P., Goodspeed, M.J., and Whigham, P.A. (1991) Canberra: Division of Water Resources, CSIRO.
- Davis, J.R., and Nanninga, P.M. (1985) GEOMYCIN: towards a geographic expert system for resource management. *Journal of Environmental Management 21*: 377–390.
- De Roo, A.P.J., Hazelhoff, L., and Burrough P.A. (1989) Soil erosion modelling using 'Answers' and geographical information systems. *Earth Surface Processes and Landforms 14*: 517–532.
- De Wispelaere, D., Schiermeier, F.A., and Gillani, N.V. (eds.) (1986) *Air Pollution Modeling and Its Application V. NATO Challenges of Modern Society*, Plenum Press, 773pp.
- EGS (1991) *XVI General Assembly, Wiesbaden, 22–26 April 1991. Annales Geophysicae*, Supplement to Volume 9.
- Fedra, K. (1990a) A computer-based approach to environmental impact assessment. *RR-91-13*, Laxenburg, Austria: International Institute for Applied Systems Analysis.
- Fedra, K. (1990b) Interactive environmental software: integration, simulation and visualization. *RR-90-10*, Laxenburg, Austria: International Institute for Applied Systems Analysis.
- Fedra, K. (1991) Smart software for water resources planning and management. *Decision Support Systems. NATO ASI Series, Vol. G26. Proceedings of NATO Advanced Research Workshop on Computer Support Systems for Water Resources Planning and Management. September 24–28, 1990. Eiriceira, Portugal, Springer*, pp. 145–172.
- Fedra, K., and Diersch, H.J. (1989) Interactive groundwater modeling: color graphics, ICAD and AI. *Proceedings of International Symposium on Groundwater Management: Quantity and Quality. Benidorm, Spain October 2–5, 1989. LAHS Publication No 188*, pp. 305–320.
- Fedra, K., Diersch, H.J., and Härig, F. (forthcoming) *Interactive Modeling of Groundwater Contamination: Visualization and Intelligent User Interfaces. Advances in Environmental Science: Groundwater Contamination Series*, New York: Springer Verlag.
- Fedra, K., and Kubat M. (forthcoming) Hybrid geographical information systems. *Paper presented at the EAR-SeL Workshop on Relationship of Remote Sensing and Geographic Information Systems. Hanover, Germany. September 1991*.
- Fedra, K., Li, Z., Wang, Z., and Zhao, C. (1987) Expert systems for integrated development: a case study of Shanxi Province, The People's Republic of China. *SR-87-001*, Laxenburg, Austria: International Institute for Applied Systems Analysis.
- Fedra, K., and Loucks, D.P. (1985) Interactive computer technology for planning and policy modeling. *Water Resources Research 21/2*: 114–122.
- Fedra, K., and Reitsma, R.F. (1990) Decision support and geographical information systems. *RR-90-9*, Scholten, H.J., and Stillwell, J.C. H. (eds.) *Geographical Information Systems for Urban and Regional Planning*, Dordrecht: Kluwer Academic Publishers, pp. 177–186.
- Fedra, K., and Winkelbauer, L. (1991) MEXSES: An expert system for environmental screening. *Proceedings Seventh IEEE Conference on Artificial Intelligence Applications. February 24–28, 1991, Miami Beach, Florida*, Los Alamitos, California: IEEE Computer Society Press. pp. 294–298.
- Ferreira, J., Jr. and Menendez, A. (1988) Distributing spatial analysis tools among networked workstations. *URISA '88—Mapping the Future*, Washington, DC: Urban and Regional Information Systems Association, pp. 200–215.
- Feyerabend, P. (1970) Consolations for the specialist. In: Lakatos, I., and Musgrave, A. (eds.) *Criticism and the Growth of Knowledge*, Cambridge: Cambridge University Press, pp. 197–230.
- Fischer, D. (1988) CAD thematic mapping as part of an environmental information system. In Kovacs, P., and Straub, E. (eds.) *Proceedings of the IFIP TCB Conference on Governmental and Municipal Information Systems*, The Netherlands: North-Holland, Amsterdam, pp. 23–29.
- Forrester, J.W. (1982) *Principles of Systems. Second Preliminary Edition*, Cambridge, MA: MIT Press.
- Gardels, K. (1988) GRASS in the X-Windows environment. Distributing GIS data and technology. *GIS/LIS '88, Accessing the World. Proceedings, Third annual international conference, San Antonio, Vol 2*, pp. 751–758.
- Gélinas, R., Bond, D., and Smit B. (eds.) (1988) *Perspectives on Land Modelling. Workshop Proceedings, To-*

- ronto, Ontario. November 17–20, Montreal: Polyscience Publications Inc., 230pp.
- Gimblett, R.H., and Itami, R.M. (1988) Linking GIS with video technology to simulate environmental change. *GIS/LIS '88, Accessing the World. Proceedings, Third annual international conference, San Antonio*. Vol 1, pp. 208–219.
- Goulter, I.C., and Forrest, D. (1987) Use of geographic information systems (GIS) in river basin management. *Water Science and Technology* 19(9): 81–86.
- Granger, K.J. (1989) Process modelling and geographic information systems: breathing life into spatial analysis. *Proceedings of Eighth Biennial Conference and Bushfire Dynamics Workshop*, Canberra, ACT, Australia: Australian National University. pp. 37–341.
- Gwynne, M.D. (1988) The Global Environment Monitoring System (GEMS): Some recent developments. *Environmental Monitoring and Assessment* 11: 219–223.
- Hedges, P.D. (1991) Evaluation of the effects of groundwater drawdown on vegetation using GIS. *Annales Geophysicae. Supplement to Volume 9. XVI General Assembly Wiesbaden. 22–26 April, 1991*, European Geophysical Society, p. C481.
- Holcomb Research Institute (1976) Environmental modeling and decision making. The United States experience. *A report by the Holcomb Research Institute Butler University for the Scientific Committee on Problems of the Environment*, Praeger Publishers. 152pp.
- Holling, C.S. (ed.) (1978) *Adaptive Environmental Assessment and Management*, John Wiley and Sons, 377pp.
- Hughes, D.A. (1991) The development of a flexible, PC based hydrological modelling system. *Annales Geophysicae. Supplement to Volume 9. XVI General Assembly Wiesbaden. 22–26 April, 1991*, European Geophysical Society, p. C481.
- Jackson, M.J., James, W.J., and A. Stevens (1988) The design of environmental geographic information systems. *Phil. Trans. R. Soc. Lond. A* 324: 373–380
- Johnson, L.B. (1990) Analyzing spatial and temporal phenomena using geographical information systems: a review of ecological applications. *Landscape Ecology* 4(1): 31–43.
- Johnston, C.A. (1989) Ecological research applications of geographic information systems. *GIS/LIS'89 Proceedings, Orlando, Florida. November 26–30*, Vol. 2, pp. 569–577.
- Johnston, C.A., and Bonde, J. (1989) Quantitative analysis of ecotones using a geographic information system. *Photogrammetric Engineering and Remote Sensing* 55(11): 1643–1647.
- Johnston, C.A., Detenbeck, N.E., Bonde, J.P., and Niemi, G.J. (1988) Geographic information systems for cumulative impact assessment. *Photogrammetric Engineering and Remote Sensing* 54(11): 1609–1615.
- Johnston, C.A., and Naiman, R.J. (1990) The use of a geographic information system to analyze long-term landscape alteration by beaver. *Landscape Ecology*, 4(1): 5–19.
- Kessell, S.R. (1990) An Australian geographical information and modelling system for natural area management. *International Journal of Geographical Information Systems* 4(3): 333–362.
- Khan, M. Akram, and Liang, T. (1989) Mapping pesticide contamination potential. *Environmental Management* 13(2): 233–242.
- Kuhn, T.S. (1970 and 1962) *The Structure of Scientific Revolutions, 2nd Edition*, Chicago University Press.
- Labadie, J.W., Brazil, L.E., Corbu, I., and Johnson, L.E. (1989) Computerized decision support systems for water managers. *Proceedings of the 3rd Water Resources Operations Workshop, Colorado State University, Fort Collins, CO, June 27–30, 1988*, New York: ASCE, 978pp.
- Lakatos, I. (1968) Criticism and the methodology of scientific research programmes. *Proceedings of the Aristotelian Society* 69: 149–186.
- Lam, D.C.L., and Swayne, D.A. (1991) Integrating database, spreadsheet, graphics, GIS, statistics, simulation models and expert Systems: experiences with the Raison system on microcomputers. *NATO ASI Series, Vol. G26*, Heidelberg: Springer, pp. 429–459.
- Langran, G. (1988) Temporal GIS design tradeoffs. *GIS/LIS '88, Accessing the World. Proceedings, Third annual international conference, San Antonio*, Vol 2., pp. 890–899.
- Lauenroth, W.K., Skogerboe, G.V., and Flug, M. (eds.) (1983) Analysis of Ecological Systems: State-of-the-Art in Ecological Modelling. *Proceedings of a Symposium 24–28 May 1982 at Colorado State University, Fort Collins, Colorado*, Elsevier Scientific Publishing Company, 992pp.
- Lindenmayer, D.B., Cunningham, R.B., Nix, H.A., Tanton, M.T., and Smith, A.P. (1991) Predicting the abundance of hollow-bearing trees in montane forests of Southeastern Australia. *Australian Journal of Ecology* 16: 91–98.
- Lotka, A.J. (1924) *Elements of Physical Biology*, Baltimore: Williams and Wilkins Co. Inc., 460pp.
- Loucks, D.P., and Fedra, K. (1987) Impact of changing computer technology on hydrologic and water resource modeling. *Review of Geophysics*, 25(2).
- Loucks, D.P., Kindler, J., and Fedra, K. (1985) Interactive water resources modeling and model use: an overview. *Water Resources Research* 21/2: 95–102.
- Maidment, D.R., and Djokic, D. (1990) Creating an expert geographic information system: the Arc-Nexpert interface. *Internal paper*, Austin, TX: Dept. of Civil Engineering, University of Texas.
- Manning, E.W. (1988) Models and the decision maker. In: Gélinas, R., Bond, D., and Smit, B. (eds.) *Perspectives on Land Modelling. Workshop Proceedings, Toronto, Ontario, November 17–20, 1986*, Montreal: Polyscience

- Publications, pp. 3–7.
- Masterman, M. (1970) The nature of a paradigm. In: Lakatos, I., and Musgrave, A. (eds.) *Criticism and the Growth of Knowledge*, Cambridge: Cambridge University Press, pp. 59–89.
- Moffatt, I. (1990) The potentialities and problems associated with applying information technology to environmental management. *Journal of Environmental Management* 30: 209–220.
- Nachtnebel, H.P., Fürst, J., Girstmair, G., and Holzmann, H. (1991) Integration of a GIS with a groundwater model to assist in regional water management. *Annales Geophysicae. Supplement to Volume 9. XVI General Assembly Wiesbaden. 22–26 April, 1991*, European Geophysical Society, p. C484.
- Oslin, A.J., and Morgan, D.S. (1988) Streams: A basin and soil erosion model using CADD remote sensing and GIS to facilitate watershed management. *Proceedings of NCGA's Mapping and GIS System '88*, Fairfax, VA: National Computer Graphics Association.
- Parent, P., and Church, R. (1989) Evolution of geographic information systems as decision making tools. In: Ripple, W.J. (ed.) *Fundamentals of Geographic Information Systems: A Compendium*, Bethesda, MD: American Society for Photogrammetry and Remote Sensing, pp. 9–18.
- Park, R.A., Collins, C.D., Leung, D.K., Boylen, C.W., Albanese, J.R., de Caprariis, P., and Forstner H. (1979) The aquatic ecosystem model MS.CLEANER. In: Jorgensen, S.E. (ed.) *State-of-the-Art in Ecological Modelling*, Copenhagen: International Society of Ecological Modelling.
- Park, R.A., O'Neill, R.V., Bloomfield, J.A., Shugart, Jr., H.H., Booth, R.S., Koonce, J.F., Adams, M.S., Clesceri, L.S., Colon, E.M., Dettman, E.H., Goldstein, R.A., Hoopes, J.A., Huff, D.D., Katz, S., Kitchell, J.F., Kohberger, R.C., LaRow, E.J., McNaught, D.C., Peterson, J.L., Scavia, D., Titus, J.E., Weiler, P.R., Wilkinson, J.W., and Zahorcak, C.S. (1974) A generalized model for simulating lake ecosystems. *Simulation* 23: 33–50.
- Parker, H.D. (1988) A comparison of current GIS software: the results of a survey. *GIS/LIS '88, Accessing the World. Third annual international conference, San Antonio, Vol. 2*, pp. 911–914.
- Patten, B.C. (ed.) (1971) *Systems Analysis and Simulation in Ecology. Volume I*, Academic Press.
- Phillips, J.D. (1990) A saturation-based model of relative wetness for wetland identification. *Water Resources Bulletin* 26(2): 333–342.
- Piwowar, J.M., LeDrew, E.F., and Dudyca, D.J. (1990) Integration of spatial data in vector and raster formats in a geographic information system environment. *Int. J. Geographical Information Systems* 4(4): 429–444.
- Reitsma, R.F. (1990) Functional classification of space. Aspects of site suitability assessment in a decision support environment. *RR-90-2, A-2361 Laxenburg, Austria: International Institute for Applied Systems Analysis*, 301pp.
- Reitsma, R.F., and Behrens, J.S. (1991) Integrated river basin management (IRBM): a decision support approach. *Proceedings of Second International Conference on Computers in Urban Planning and Urban Management*, Akron, OH: Institute for Computer Aided Planning, University of Akron.
- Scholten, H.J., and Stillwell, J.C.H. (eds.) (1990) *Geographical Information Systems for Urban and Regional Planning*, Dordrecht: Kluwer, 261pp.
- Seaborn, D.W. (1988) Distributed processing and distributed databases in GIS—separating hype from reality. *GIS/LIS '88, Accessing the World. Proceedings, Third annual international conference, San Antonio, Vol 1.*, pp. 141–144.
- Smyrnew, J.M. (1990) Trends in geographic information system technology. *Journal of Surveying Engineering*, 116(2) 105–111.
- Steppacher, L. (1988) Ground water risk management on Cape Cod: the applicability of geographic information system technology. *Proceedings of FOCUS Conference on Eastern Regional Ground Water Issues. September 27–29, Stamford, Connecticut*, Dublin, OH: National Water Well Association.
- Sucksdorff, Y., Lemmelä, R., and Keisteri T. (1989) The environmental geographic information system in Finland. *New Directions for Surface Water Modeling (Proceedings of the Baltimore Symposium)*. May, pp. 427–434.
- Tikunov, V.S. (1989) Modern research tools on the 'Society-Natural Environment' System in Soviet geography. *Journal of Environmental Systems* 19(1): 59–69.
- Tilley, S., and Sperry, S.L. (1988) Raster and vector integration. *Computer Graphics World* (August 1988): 73–76.
- Turner, A.K. (ed.) (1991) *Three-dimensional Modeling with Geoscientific Information Systems*, Dordrecht: Kluwer Academic Publishers, 443pp.
- van Est, J.V., and de Vroeghe, F. (1985) Spatially oriented information systems for planning and decision making in the Netherlands. *Environment and Planning B: Planning and Design* 12: 251–267.
- Weil, U. (1990) Info technology helps with environmental cleanup. *Government Computer News* (November 26): 50.
- Welch, R., Madden Remillard, M., and Slack, R.B. (1988) Remote sensing and geographic information system techniques for aquatic resource evaluation. *Photogrammetric Engineering and Remote Sensing* 54(2): 177–185.
- White, S.M. (1991) The use of a geographic information system to automate data input to the Système Hydrologique Européen (SHE-UK). *Annales Geophysicae. Supplement to Volume 9. XVI General*

- Assembly Wiesbaden. 22–26 April, 1991*, European Geophysical Society, p. C488.
- Wiggins, J.C., Hartley, R.P., Higgins, M.J., and Whittaker, R.J. (1986) Computing aspects of a large geographic information system for the European Community. *Conference Proceedings of Auto Carto London*, Vol. 2, pp. 28–43.
- Wilde, B.M., and Drayton, R.S. (1991) A geo-information system approach to distributed modelling. *Annales Geophysicae. Supplement to Volume 9. XVI General Assembly Wiesbaden. 22–26 April, 1991*, European Geophysical Society, p. C488.
- Witt, R.G. (1989) An overview of GRID: a working global database. In Zirm, K.L., and Mayer, J. (eds.) *Envirotech Vienna 1989—Computer-Based Information Systems in Environmental Protection and Public Administration (Workshop). February 20–23, 1989*, Vienna/Hofburg, Austria: International Society for Environmental Protection.
- Woodcock, C.E., Sham, C.H., and Shaw, B. (1990) Comments on selecting a geographic information system for environmental management. *Environmental Management* 14(3): 307–315.
- Woodcock, C.E., and Strahler, A.H. (1983) PROFILE: remote sensing for land management and planning. *Environmental Management* 7(3): 223–238.
- Zack, J.A., and Minnich, R.A. (1991) Integration of geographic information systems with a diagnostic wind field model for fire management. *Forest Science* 37(2): 560–573.

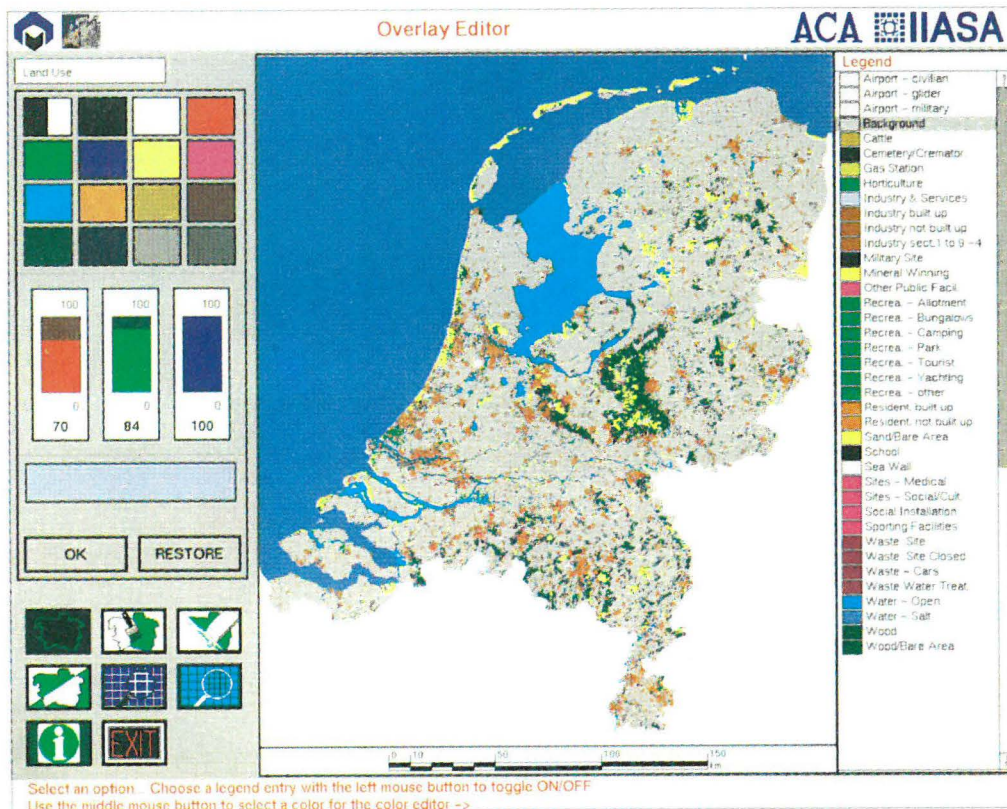

Plate 1: An interactive map editor

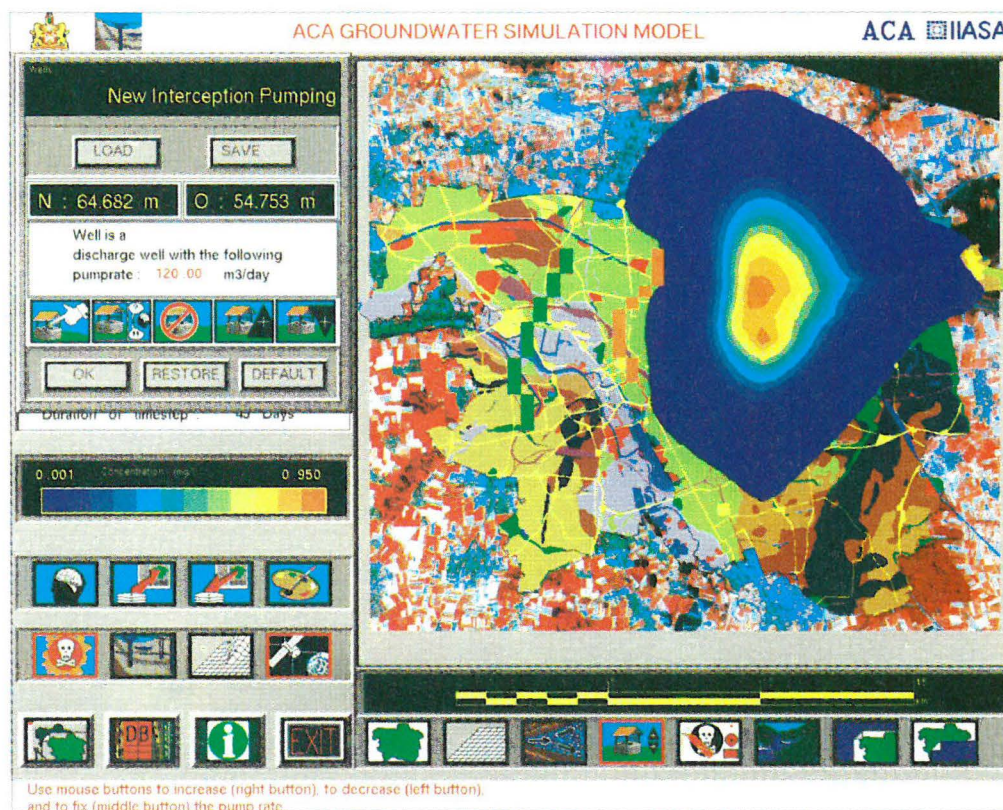

Plate 2: Groundwater model interface with integrated GIS functions

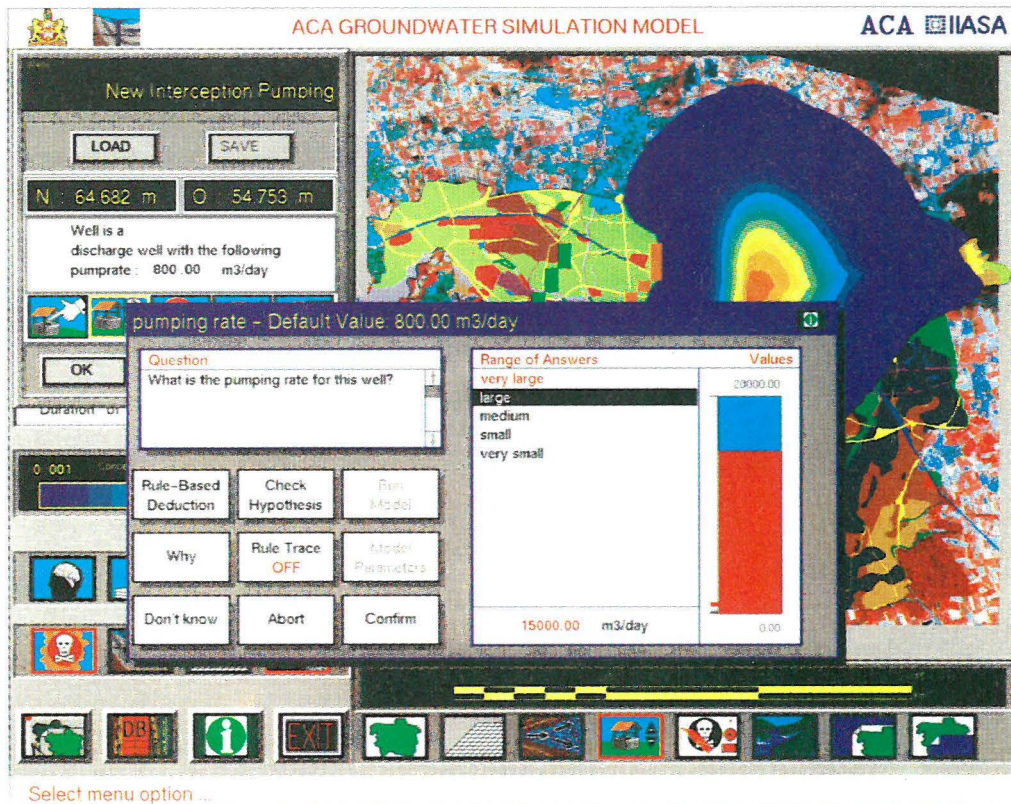

Plate 3: The expert system integrated in the groundwater model

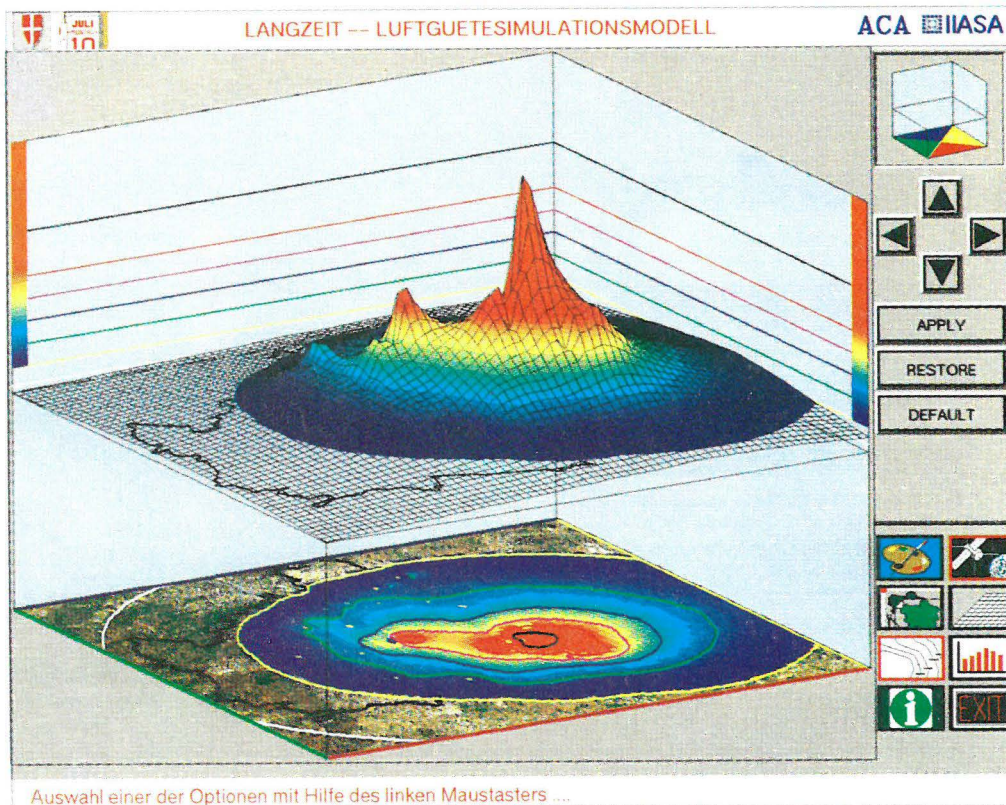

Plate 4: Air quality model with integrated GIS

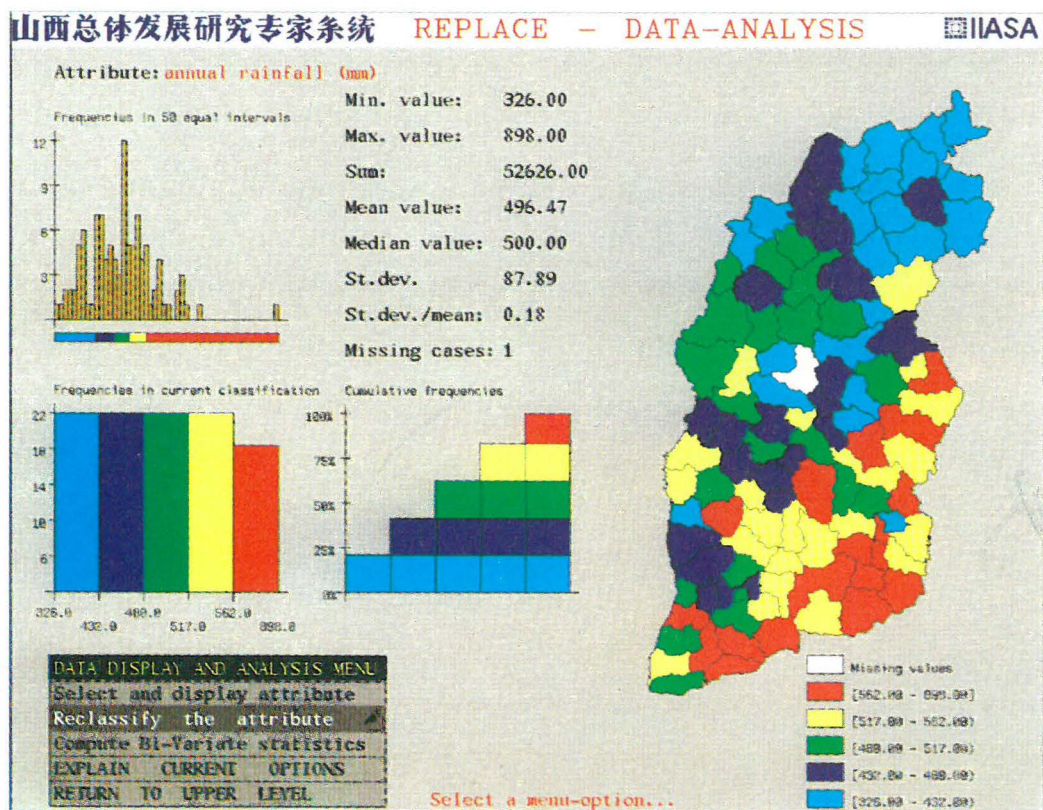

Plate 5: REPLACE, a site suitability analysis expert system

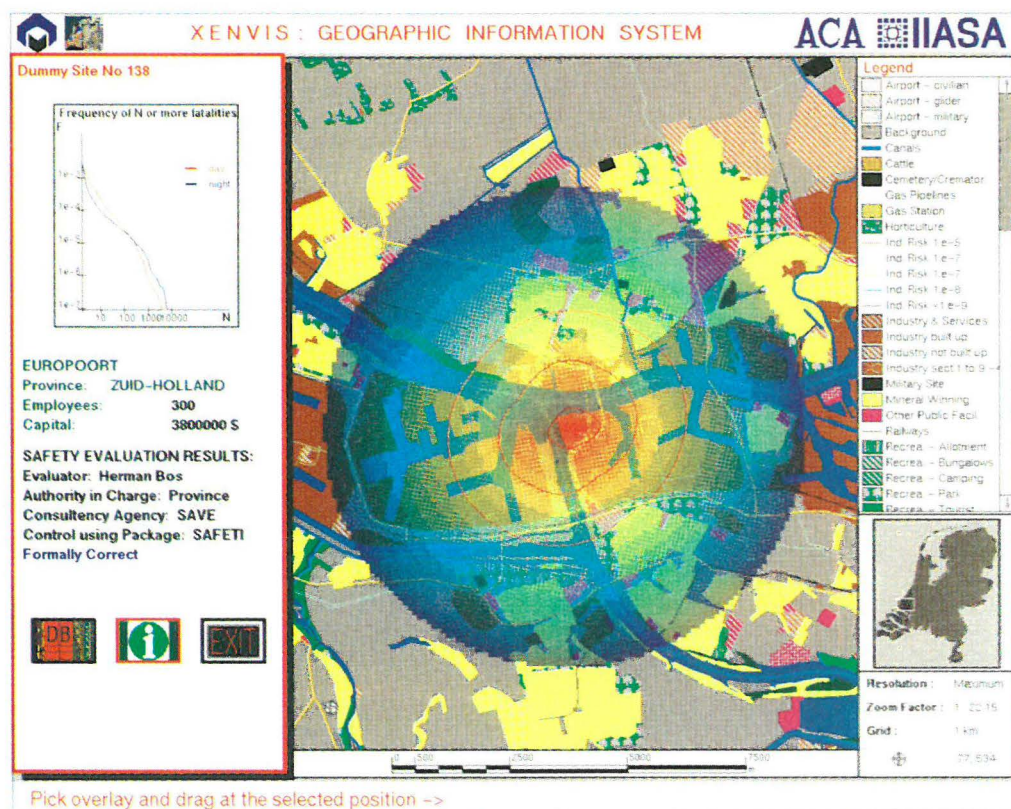

Plate 6: Risk contours in XENVIS

