

Working Paper

Assessment of Technologies for Reducing CO₂ Emission

*Y. Kaya, Y. Fujii, R. Matsuhashi,
I. Furugaki, K. Yamaji, O. Kobayaski,
Y. Shindo, and H. Saiki*

WP-93-10
March 1993



International Institute for Applied Systems Analysis □ A-2361 Laxenburg □ Austria
Telephone: +43 2236 715210 □ Telex: 079 137 iiasa a □ Telefax: +43 2236 71313

Assessment of Technologies for Reducing CO₂ Emission

Y. Kaya^{*1}, *Y. Fujii*^{*1}, *R. Matsushashi*^{*1},
I. Furugaki^{*2}, *K. Yamaji*^{*1}, *O. Kobayashi*^{*3}
Y. Shindo^{*4} and *H. Saiki*^{*5}

Presented at the IPCC/EIS-IIASA International Workshop
on Energy-Related Greenhouse Gases Reduction and Re-
moval, 1-2 October 1992

^{*1}Faculty of Engineering, the University of Tokyo

^{*2}Energy Conservation Center

^{*3}Global Industrial and Social Progress Research Institute (GISPRI)

^{*4}National Chemical Laboratory for Industry, Ministry of International Trade and Industry (MITI)

^{*5}Central Research Institute of Electric Power Industry (CRIEPI)

Working Papers are interim reports on work of the International Institute for Applied Systems Analysis and have received only limited review. Views or opinions expressed herein do not necessarily represent those of the Institute or of its National Member Organizations.



International Institute for Applied Systems Analysis □ A-2361 Laxenburg □ Austria

Telephone: +43 2236 715210 □ Telex: 079 137 iiasa a □ Telefax: +43 2236 71313

Contents

Summary and Introduction	1
1. Assessment of Individual Technology	2
1.1 Energy Conservation	2
1.1.1 Energy Conservation in OECD Countries	
1.1.2 Energy Conservation in Non-OECD Countries	
1.2 Photovoltaics (PV)	12
1.2.1 Difficulties in Network Linked PV System	
1.2.2 Large Scale PV System and Energy Transportation	
1.2.3 PV in Developing Countries	
1.3 Biomass	15
1.3.1 Biomass Energy in Developed Countries	
1.3.2 Biomass Energy in Developing Countries	
1.4 CO ₂ Sequestration	18
1.4.1 CO ₂ Recovery	
1.4.2 Ocean CO ₂ Disposal	
1.4.3 Subterranean CO ₂ Disposal	
1.5 Nuclear Power	23
2. Model Building and Scenario Analysis	25
2.1 The Outline of the Model	25
2.1.1 Geographical Coverage and Time Horizon	
2.1.2 Methodology	
2.1.3 Energy Supply	
2.1.4 Energy Demand and Conservation in End Use Sectors	
2.1.5 CO ₂ Recovery, Disposal and Storage	
2.1.6 Regional Model	
2.1.7 Inter-regional Trade	
2.2 Energy and CO ₂ to the Year 2050: Scenario Analysis	35
2.2.1 Scenario Assumption	
2.2.2 Computational Results	
2.3 Concluding Remarks	43
References	44

Summary

There are a wide variety of technologies for reducing CO₂ emissions, of which a greater part are those of energy technologies. The paper aims at assessing these technologies with regional differences of technology characteristics taken into account. The first part examines merits and demerits of individual technology, and thus envisages its possible future. The second part describes a global energy model, which generates comprehensive long term future scenarios of energy and CO₂ emission in various regions of the world.

Introduction

The climate change induced by greenhouse gases is probably the most serious environmental threat that the mankind ever experienced. The principal component of greenhouse gases is the carbon dioxide almost inevitably emitted in burning carbon oriented fuels such as fossil fuels. Taking into account that we mankind have relied on energy produced by carbon burning since the beginning of our history, we realize that the problem of climate change is not a mere pollution problem but an issue connected to the basic character of human civilization. Required are long term efforts for substantial changes in energy systems toward much less reliance on fossil fuels.

We already know a variety of technologies which may contribute to reduction of CO₂ emission. However these technologies are mostly premature and constrained by various technological, economical and environmental constraints. There is no "almighty" technology by which the issue will be almost completely solved. One of the subtasks of IPCC/EIS is to make a broad survey of these technologies and evaluate their usefulness in the long run. A US group has been doing efforts for building "Technology characterization inventory". Independently of this we formed a work group for assessing technologies in an consistent way. The work started in the middle of 1991, and the official interim report will be published soon as a paper in IPCC WG-3 supporting material.

The work is divided into two parts, one for the survey of individual technology and the other for building an optimization type model designed for generating future CO₂ related technology scenarios of the world. The work is still going on and the tentative observations from the work will be presented in this paper.

1. Assessment of Individual Technology

Individual technology which serves to reduction in CO₂ emission will be surveyed in this sector with the difference between developing countries and developed countries taken into account. Note that the authors do not present all technologies but only principal ones, as the purpose of the work is not a mere construction of technology inventory but assessment of these technologies.

1.1 Energy Conservation

1.1.1 Energy Conservation in OECD Countries

Energy conservation is generally acknowledged to be one of the most effective options for reducing CO₂. A lot of efforts has been made for energy conservation particularly since the first oil crisis. USA and Japan attained reduction in energy/GDP by almost 25% and 30% respectively between 1973 and 1986. However, it depends on availability of measures whether we can reduce energy/GDP also in future.

Measures for energy conservation are categorized into two types, i.e. pattern change type and investment type. The former includes options to change usage patterns of commodities or facilities so as to save energy. Reduction in running distances of automobiles due to rise in oil prices is a typical example of pattern change type. The latter corresponds to options which attain higher energy efficiency by adding new facilities or by replacing existent production processes with new ones. Installation of blast furnace top pressure recovery turbine in iron and steel industries belongs to investment type. We have to investigate both types of options to know the whole potential of energy conservation.

We are also trying to evaluate energy conservation potential in different countries. Preliminary results are shown in our interim report^[1-1-1]. In evaluating the feasibility of energy conservation we should note that the potential and economic attractiveness of each option are different depending on regional conditions. For example, thermal insulation in household sector is more attractive in regions of cold climate than in regions of warm climate. Such regional differences is a significant factor in comparing the energy conservation potential in different countries.

Industry Sector

◎Energy Conservation by Investment Type Measures

We already evaluated the energy conservation potential of major industries in Japan.^[1-1-1] In this paper we make a more detailed analysis focusing on iron and steel industry so as to reveal the differences among various countries. First we built an energy flow model describing each process in producing basic oxygen furnace steel in Japan. Figure 1.1.1 depicts a schematic diagram of this model.

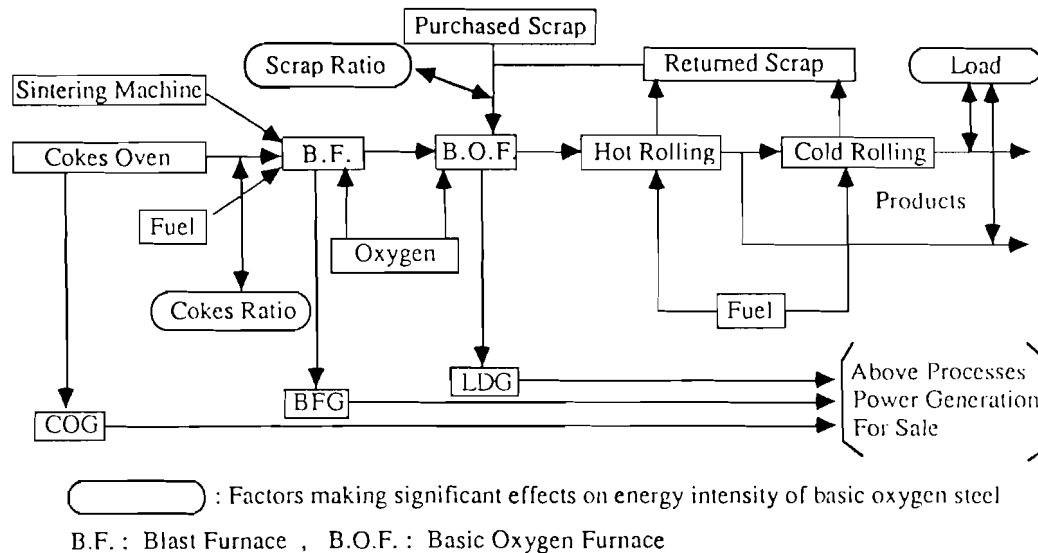

Figure.1.1.1 Schematic diagram of the Energy Flow Model

Based on the above model, we have evaluated energy conservation potential of eleven types of measures presently available. Figure 1.1.2 shows the conservation potential of these measures in Japan. It indicates that there is not much conservation potential left in iron and steel industries in Japan. Then the question is how much potential other countries have. For comparison, we built the energy flow models also for the Netherlands and U.S.A.. Figure 1.1.3 shows the main differences of steel production in these three countries. From these models we can evaluate the conservation potential by those measures. For example, Figure 1.1.4 shows the potential of cokes dry quenching (CDQ) in three countries. In the case of the Netherlands, less cokes and more pulverized coal are put into blast furnaces than those in Japan. This is the reason why the CDQ potential is less in the Netherlands than in Japan. In the case of U.S.A., scrap ratio in BOF is much higher than that in Japan. Therefore cokes needed to produce one ton of basic oxygen furnace steel is less than those in Japan. As the result, the potential of CDQ is less in U.S.A. than in Japan. Thus operational conditions are different in each country, and this makes the conservation potential different among various countries. We should be aware of such differences in evaluating the energy conservation potential in different countries.

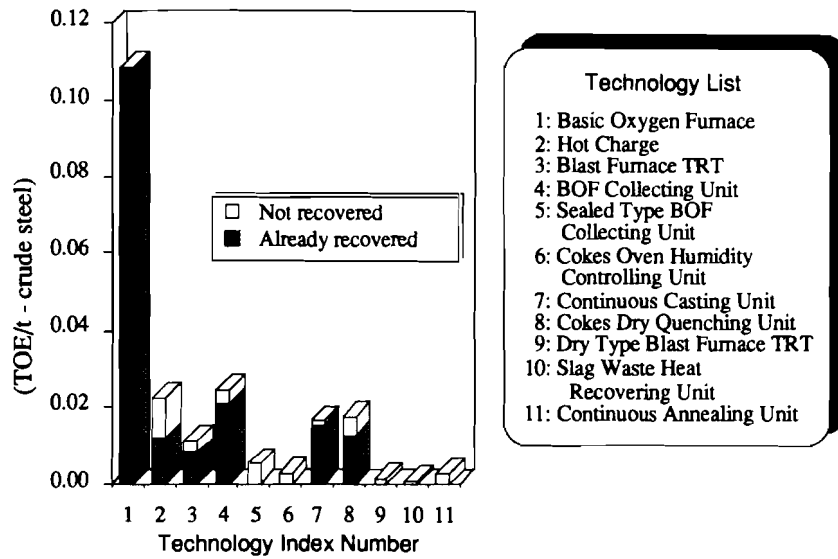

Figure 1.1.2 Energy Conservation Potential of Iron and Steel Industries

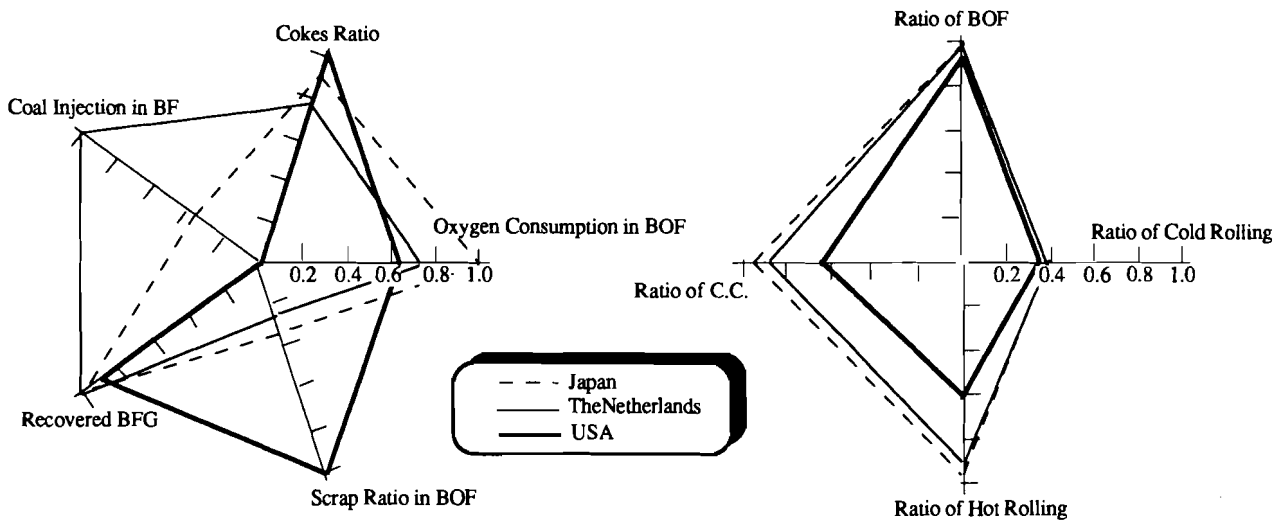

Figure 1.1.3 Differences of Steel Production in The Netherlands, USA, and Japan

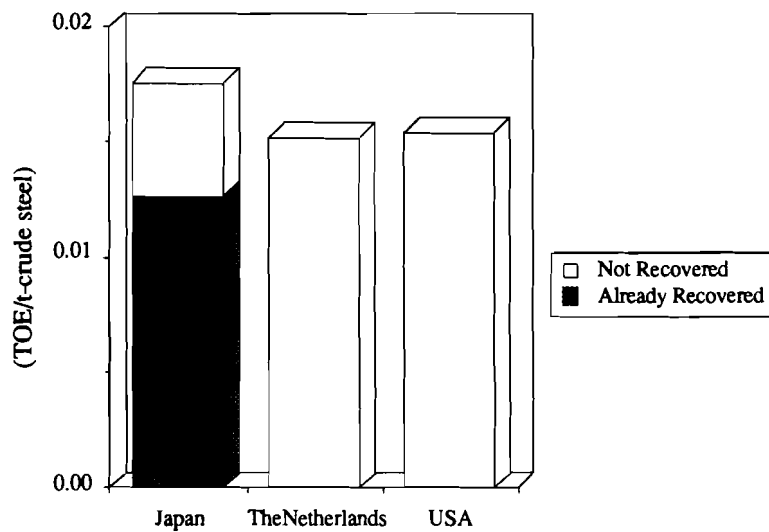

Figure 1.1.4 The energy conservation potential by cokes dry quenching (CDQ)

◎Energy Conservation by Recycling

There is another type of energy conservation measure in the industry sector, i.e. recycling of iron scraps, used paper and other goods. Less energy is required to produce crude steel from iron scraps than from iron ore. In Japan, the average energy required to produce crude steel from iron ore is 0.56 TOE per ton of steel, while that from scraps is only 0.13 TOE per ton of steel, about 22% of the former. Recycling of used paper also leads to energy conservation. In the case of high quality paper, 0.14 TOE per ton of paper is saved by the recycling. Thus recycling of materials leads to considerable amounts of energy conservation. However we should note that the recycling generally deteriorates the quality of materials. For example, iron scraps often includes impurities such as tin or copper, which make steel fragile. For this reason steel produced from scraps is apt to be used as low quality steel.

We should also note that availability of scraps is different among various countries. For example, large amounts of scraps are available in USA, since there is a long history and large amount of steel production in that country. On the other hand scraps are increasing in Japan, but still less than those in USA. Thus available quantity of scraps is different among various countries, depending on the history of steel production.

Households Sector

Thermal insulation of walls, roofs and floors of houses and buildings is a typical example of investment type measures in this sector. 30% of Japanese houses have already installed insulation materials with the average thickness of 50 mm. However, the cost-effectiveness of insulation materials depends on climate conditions in each region. Here we evaluate the cost-effectiveness in different regions. We have selected typical wooden detached houses (total area of 119.3 m²) in Sapporo, Tokyo, and Kagoshima, which are located in the northern, the central and the southern parts of Japan respectively. Figure 1.1.5 shows the relationship between heating/cooling demand and thickness of insulation materials respectively.^[1-1-2] These figures indicate that insulation material is not so effective for reducing cooling demand as for reducing heating demand.

From the relationship we have evaluated the cost-effectiveness of insulation materials as shown in Figure 1.1.6. Annual expense ratio of those is assumed to be 5%. Figure 1.1.6 indicates that regional difference is significant, and that insulation material is much more attractive in cold regions than in warm regions. Therefore in warm regions, we need other option such as passive solar technique, which can reduce not only the demand for heating but also for cooling. Such innovative technology should be developed from a long range perspective.

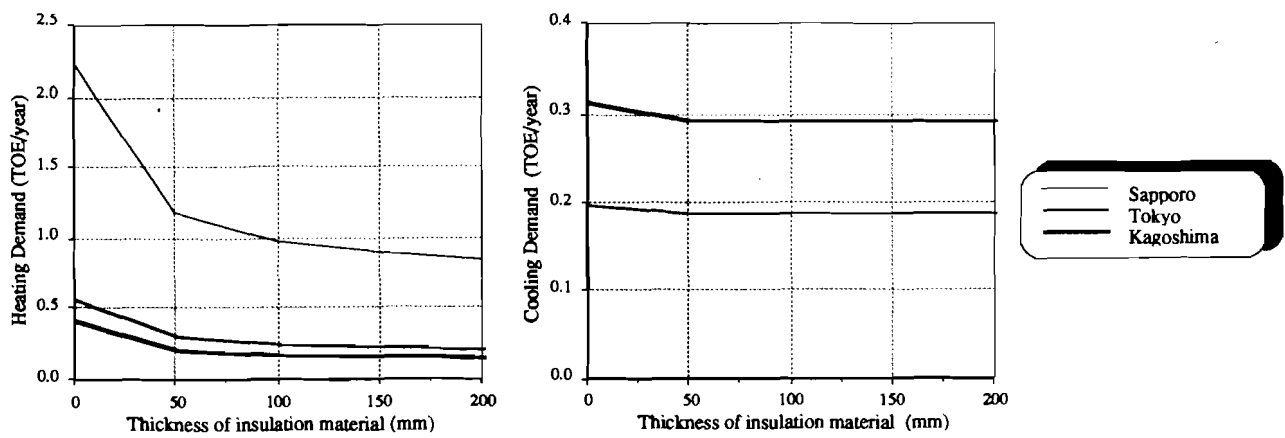

Figure 1.1.5 The Relationship between Thickness of Insulation Material and Heating and Cooling Demand

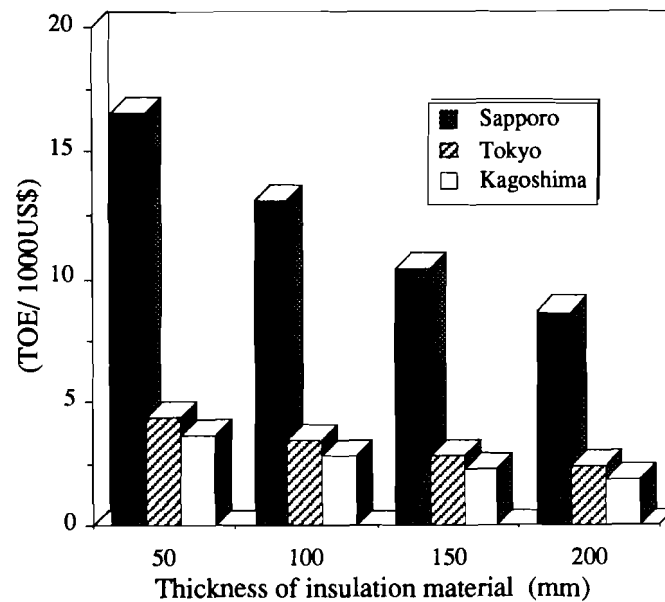

Figure 1.1.6 The Cost-effectiveness of Insulation Materials in Each Region

Another important problem in Household sector is how to reduce energy demand of electric appliances such as refrigerators or televisions. The smaller appliances consume less energy and more economical. Nevertheless the sizes of those appliances are going up in Japan, as national income increases. Thus the market penetration of those appliances are heavily influenced by preferences of people. In such cases, econometric methods may be more effectively applied, and the work is now under way.

Transportation Sector

The usage patterns of vehicles heavily depend upon socioeconomic variables such as energy price and standard fuel economy, so that econometric method is applied here. Detailed analysis is still under way and its output will be reported in a year or two.

Energy Conversion Technologies

Among various energy conversion technologies, electric power generation is the most important, since electrification has been promoted in developed countries and will also be promoted in non-OECD countries in future. Moreover, there are several kinds of innovative technologies to improve the efficiency of generating electricity. The key technology in future is certainly use of combined cycle, which is already put into practice for natural gas in a few countries. The efficiency of 43% (HHV) is achieved by natural gas combined cycle plants presently operated in Japan. We expect that the efficiencies of combined cycle plants will be improved to 48% (HHV) or to 53% (LHV) due to the advancement of material technology.^[1-1-4] This technology will be also effectively applied to integrated coal gasification combined cycle, which is now at experimental stage.^[1-1-5] Efficiencies of those innovative measures are shown in Table 1.1.1. Table 1.1.1 also shows average efficiencies of coal and natural gas fired power plants in major OECD regions in 1988.^[1-1-6]

Table 1.1.1 The Efficiencies of Energy Conversion Technologies (HHV)

Coal Fired Power Plant		
	North America	35.1%
Conventional	OECD Europe	34.7%
	Japan	38.0%
	Pressurized Fluidized Bed Combustion	41.0%
	Integrated Coal Gasification Combined Cycle	43.4%
Natural Gas Fired Power Plant		
	North America	33.7%
Conventional	OECD Europe	34.4%
	Japan	40.3%
	Natural Gas Combined Cycle	48.3%

Since the average efficiencies in Japan are the highest among them, more energy can be saved in other OECD regions by replacing old power plants with the above innovative technologies than in Japan. Taking this into account, we have evaluated the cost of energy conservation as shown in Figure 1.1.7. Annual expense ratio of those measures is assumed to be 20%. We can see the differences of the cost-effectiveness in major OECD regions from these figures.

One of other promising options is fuel cell power generation. Although the conversion efficiency of present fuel cells (phosphoric acid) is about 40%, it is expected to go up to the level of 50~60% in future. Capital costs of fuel cells are at present much higher than those of conventional power plants. We should take this technology into account when it becomes competitive with conventional power plants.

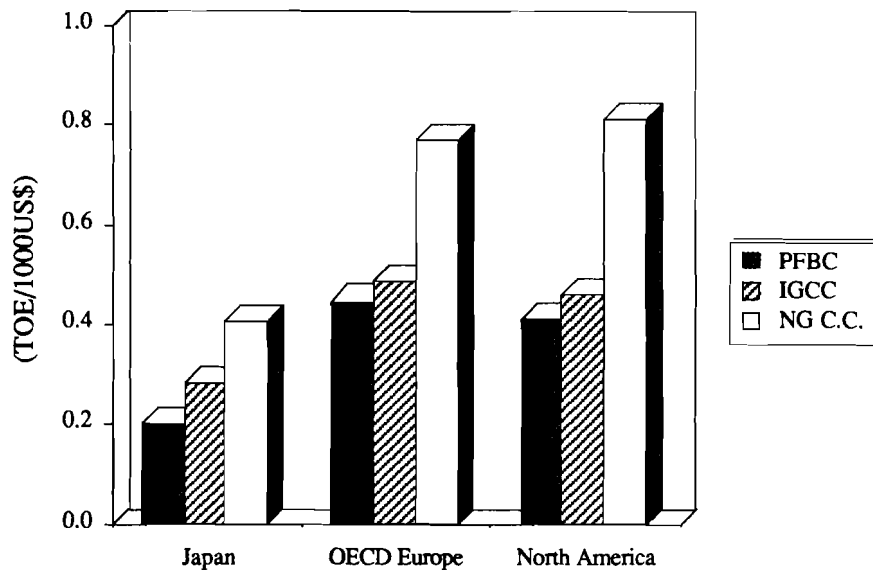

Figure 1.1.7 The Cost-effectiveness of Innovative Power Generation

Cogeneration is another type of energy conservation technologies, which can produce not only electricity but also heat. Gas turbines, phosphoric acid fuel cell and molten carbonate fuel cell are promising in future. However, we have to investigate both electricity and heat demand so as to evaluate the conservation potential by cogeneration.

System Modification for Energy Conservation

In this section we describe modification of energy system structures so as to save energy. This type of option is promising in future, although we are fully aware that it takes long time to reshape energy system. A typical example of this is a heat cascading utilization system. For example, Grothcurth and Kummel⁽¹⁻¹⁻⁷⁾ evaluated energy conservation by heat cascading. First they investigated the energy demands as functions of temperatures, and then evaluated how much energy can be saved by connecting system elements with each other by use of heat exchangers, cogenerations and heat pumps. The results are shown in Figure 1.1.8, which shows a great potential of energy conservation by heat exchangers. Such a great potential of energy conservation results from neglecting energy loss in transporting heat. They also made an analysis taking the energy loss into account, in which cogenerations and heat pumps played greater roles for energy conservation.

These results indicate that heat cascading is a promising option for energy conservation in future. There are several other promising ideas of system restructuring so as to attain higher system efficiency. The survey and analysis of these ideas are under way.

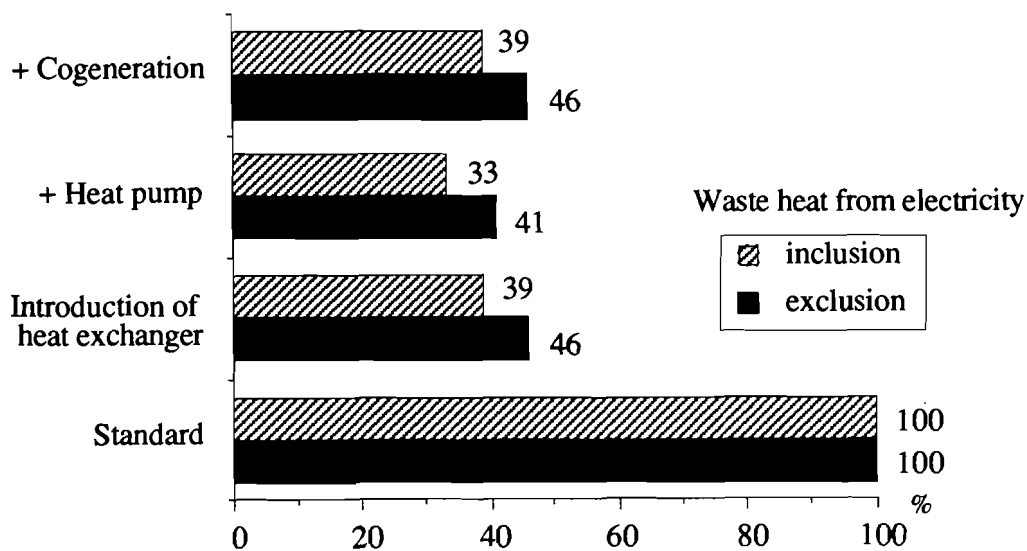

Figure 1.1.8 Optimization Results for Japanese Industrial Sector

1.1.2 Energy Conservation in Non-OECD Countries

Energy conservation is a promising option for mitigating global warming also in non-OECD countries. We describe principal characteristics of non-OECD countries as follows.

- (1) Rapid increase in population is observed in many non-OECD countries.
- (2) Steady growth of GDP is needed so as to raise life standards.
- (3) Such trends as (1) and (2) would give rise to rapid increase in energy demand.
- (4) Energy efficiency in industry, energy conversion, households and transportation sectors are generally low.
- (5) (4) means that there is more room for energy conservation in non-OECD countries than in OECD countries.
- (6) Statistics show that 47% of total primary energy is consumed in non-OECD countries in 1988. The share of those countries would continue to increase, considering above mentioned trends.

These observations suggest that energy conservation is the most effective option to mitigate global warming while satisfying requirements for developments. And it could be no regrets policy for non-OECD countries to promote energy conservation to some extent.

Technology transfer from OECD countries is indispensable in promoting energy conservation in non-OECD countries. But we do not discuss the question, 'Who pays the cost by what mechanism?', since it is a political issue.

Industry and Energy Conversion Sector

CO₂ emissions of major three industries and power generation is shown in Table 1.1.2. This table indicates following things.

- (1) Efficiency of power generation is generally low around 30%.
 - (2) In China, energy intensity of crude steel production is surprisingly high.
 - (3) CO₂ emission in four industries in CIS and China occupies nearly 80% of those seven countries.
- Therefore we discuss the energy conservation focusing on CIS and China.

Table 1.1.2 CO₂ Emissions in Selected Non-OECD Countries

Item	Unit	(1)	(2)	(3)	(4)	(5)	(6)	(7)	(8)
Total CO ₂ Emission	(Mt-C)	604.	140.	61.3	77.0	980.	62.1	121.	2050
4 Industries	(Mt-C)	275.	66.5	13.3	21.9	371.	21.0	56.4	836
The share	(%)	45.5	47.5	21.7	28.4	37.9	33.9	46.5	40.9
Power Generation	(Mt-C)	117.	52.2	2.68	14.5	224.	18.0	40.2	469
Thermal Efficiency	(%)	32.5	28.0	29.0	36.1	36.6	29.1	31.1	34.2
Iron & Steel	(Mt-C)	81.9	9.18	8.43	5.20	95.9	2.33	9.56	219
CO ₂ Intensity	(t-C/t-steel)	1.38	0.67	0.34	0.71	0.59	0.15	0.62	0.68
Cement	(Mt-C)	65.3	5.16	1.59	1.29	42.8	0.69	5.00	126
CO ₂ Intensity	(t-C/t-cement)	0.31	0.14	0.06	0.06	0.32	0.06	0.30	0.26
Paper	(Mt-C)	10.8	0.00	0.61	0.92	8.49	0.02	1.54	23.1
CO ₂ Intensity	(t-C/t-paper)	0.53	0.00	0.07	0.23	0.41	0.006	0.68	0.34

(1)China (2)India (3)Brazil (4)Mexico (5)CIS (6)Czechoslovakia (7)Poland (8)Total

From this table, we evaluate how much CO₂ can be reduced by improving energy intensities. The cost effectiveness of power generation technologies in CIS and China are shown in Figure 1.1.9. This figure indicates that efficiency improvement is less expensive in China than in CIS.

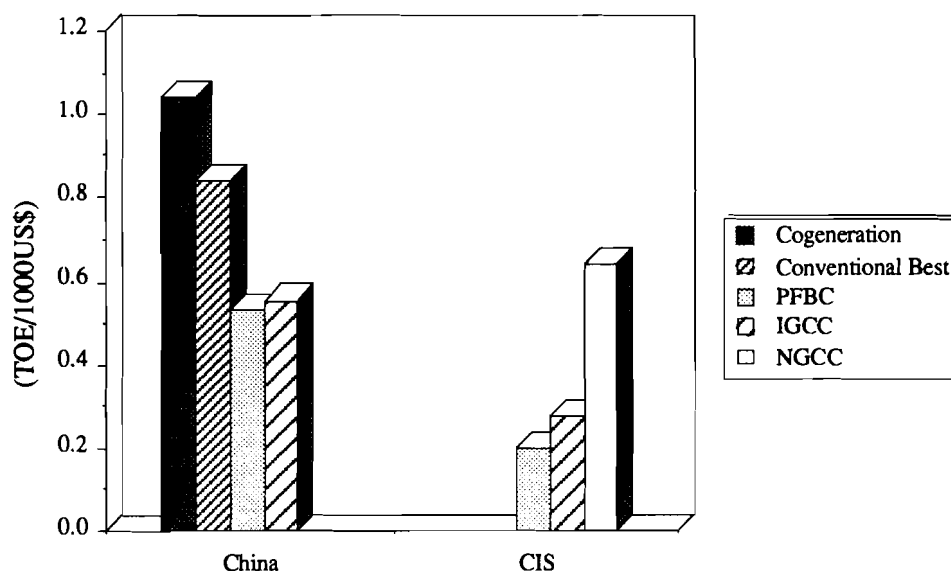

Figure 1.1.9 Cost Effectiveness of Power Generation Technologies in CIS and China

Figure 1.1.10 shows the curve of conserved energy power generation technologies in CIS and China. This figure indicates that the considerable amounts of energy can be saved by power generation technologies in these two countries. In particular, improvement of coal fueled power generation technologies is significant in China. On the other hand, natural gas combined cycle is a key for conserving energy in CIS.

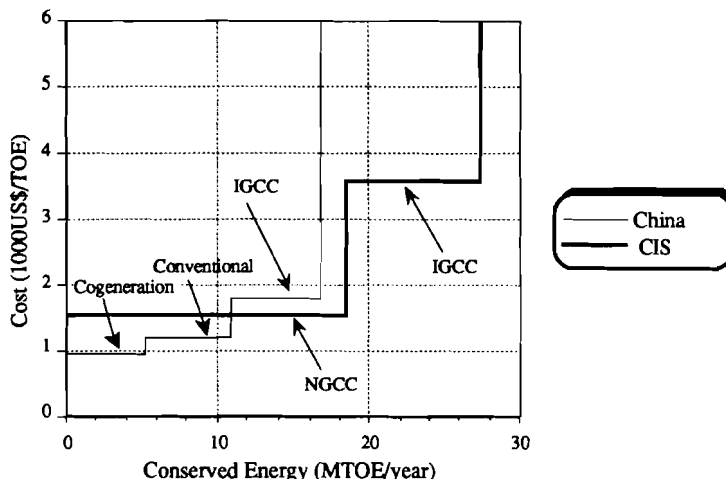

Figure 1.1.10 The Curve of Conserved Energy Power Generation Technologies in CIS and China

There are considerable potential of energy conservation also in industry sector in these countries. Evaluation of cost-effectiveness of options in industry sector is now under way.

Households and Transportation Sector

As described in [1-1-2], thermal insulations of walls, roofs and floors of houses and buildings are typical example of investment type measures in households sector. However, insulation materials are not so effective in tropical or subtropical regions where many non-OECD countries are located. Furthermore, demand for cooling would increase rapidly in future in those countries. Therefore we need to develop the passive solar house fitted with climate conditions in each region.

On the contrary, thermal insulation and cogeneration is a key for energy conservation in CIS and other non-OECD countries in Europe.

Fuel economy of automobiles in non-OECD countries is generally low. It is an effective conservation option in transportation sector to replace the old inefficient automobiles with new efficient ones.

Modification of Energy System

As described in [1-1-5], heat cascading utilization system is a promising energy conservation measure in future. City planning incorporating heat cascading utilization can be made, where social infrastructures are not enough. Therefore in a sense, this system could be more easily established in non-OECD countries than in OECD countries. However we do not have enough data to investigate the feasibility of this system in non-OECD countries. It is a significant work in future.

1.2 Photovoltaics (PV)

PV is at least apparently one of the most promising non-fossil resources. Prices of solar cells have been going down rapidly and their energy conversion efficiencies going higher last ten years. Sunlight is available in any part of the world and in this sense the most easily accessible energy source.

1.2.1 Difficulties in Network Linked PV Systems

There are in general two types of PV use, i.e. centralized and decentralized. The former means to locate a number of solar batteries in a broad area and to produce a huge amount of electric power. This therefore requires a large space for power production. The latter means to locate small PV systems in many places which are connected to satisfy local energy demands. Since the population densities of EC and Japan are high the potential of the former type is relatively small due to limited availability of lands. The latter type may on the other hand be realized by utilizing various unused spaces in cities and industries. Those which have the largest potential among these are roofs of houses, buildings and factories. The total physical potentials of PV systems located on house roofs in developed countries are as shown in Figure 1.2.1 where we assume all roofs are available for PV with 10 % conversion efficiency and the roof utilization rate for PV is 50%. The future price targets of PV systems in USA^[1-2-1] and Japan^[1-2-2] are also shown in Figure 1.2.2 which suggests the possibility that a considerable amount of electricity will be covered by decentralized PV systems in future.

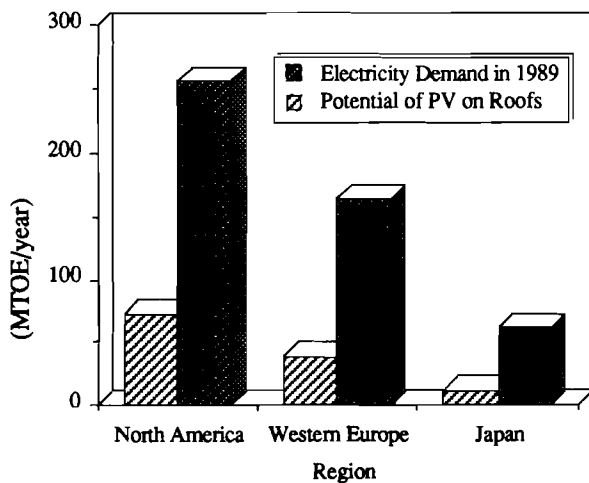

Figure 1.2.1 The potential of PV installed on roofs

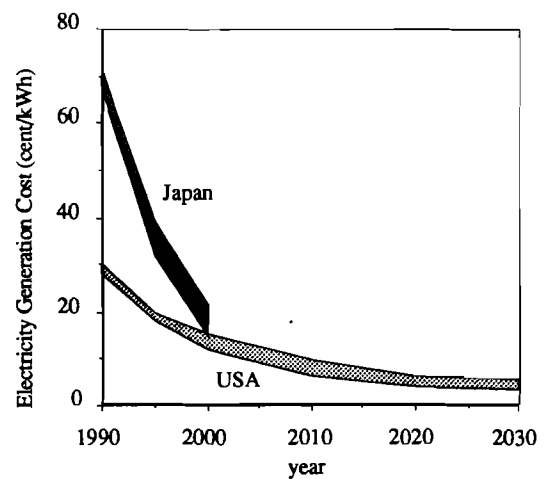

Figure 1.2.2 The projected trends of PV cost

However the above observation neglects serious technological problems resulting from variability of outputs of PV systems. If we want to introduce PV systems to help satisfy ordinary power demands, we have to link PV systems with conventional power systems so as to maintain the power supply

with the assigned quality (on frequency, voltage and higher harmonics) to satisfy the demand. This linkage however is a heavy burden of conventional power systems, as the total capacity PV systems becomes larger.

The first problem is the maintenance of instantaneous voltage stability at the demand end. If PV systems located on roofs of city houses are linked with the conventional power system without any voltage regulation voltages at demand ends vary considerably by changes in PV outputs induced by various weather factors such as mere draft of clouds. This is due to the limited ability of voltage regulation of distribution lines. For PV systems to avoid this difficulty they have to have some power storage devices such as batteries besides them. This in turn deteriorates the economic feasibility of PV systems considerably.

The second problem is the operational inefficiency of PV linked power systems when the capacity of PV systems is large. Even if they include batteries to avoid large instantaneous voltage changeability PV system outputs may change from hour to hour due to changes in solar inputs. For example if it rains almost a day PV outputs may go down even with a buffer battery at the end of the day to the level of almost an order lower than the nominal output capacity, as the capacity of batteries is also limited. Mere increase in battery capacity is no other than worsening the economic feasibility of PV systems. In response to changes in PV outputs, other conventional power plants in the system have to adjust their outputs so as to satisfy the demands. In other words the total size of the power plants which have to adjust their outputs from time to time may increase, as the size of PV systems linked with the power system becomes larger. This means that introduction of PV systems in a large scale into power systems will deteriorate the average capacity utilization ratio of other power plants in the system and then give rise to increase in the system unit cost.

In sum we believe that the economic feasibility of PV systems connected to conventional power systems is worse than we expect from the simple cost measure such as shown in Figure 1.2.2. Substantial progress in efforts for reducing costs of not only solar cells but those of supporting devices such as power storages (batteries etc.) and inverters is indispensable to realize use of PV systems in a large scale.

1.2.2 Large Scale PV Systems and Energy Transportation

Another idea of utilizing PV systems is to install a number of solar batteries on a large, sunny space such as desert and transport energy thus obtained to demand sites. The government of Japan plans to launch a new project called WENET(World Energy NETwork) from 1993 which aims at developing technologies useful for realizing the above idea. The land cost is in this case far cheaper than in the case of locating PV in developed countries and the total utilizable solar radiation is much higher.

The key for realizing this idea is the way to transport energy from PV site to the demand site. Most deserts are far from demand site so that long distance transportation of energy obtained from PV systems is required. In case of Australian deserts the distance between them and East Asian countries including Japan, which are and will be one of major energy importers, is more than 5,000 km. Transmission of electric power generated from PV systems by transmission lines is for this case almost impossible and conversion of electricity into transportable media is required. Figure 1.2.3 exhibits such a concept with three types of transport media. At the present stage of technology the total cost of this system is very expensive and according to our calculation^[1-1-1] it is roughly of an order higher than the present oil prices. In other words some innovation in energy transportation technology is indispensable for this WENET concept to be economically feasible.

Another idea but similar to WENET is to receive solar power in the outer space by PV systems and transmit that power by microwave to the earth. This concept was originally proposed by Glaser^[1-2-3] in 1968 and US DOE made a preliminary research on this with NASA at the end of 1970's^[1-2-4] under the name of Satellite Power System (SPS) Program. At this moment the estimated cost of SPS is much expensive than those of conventional power plants, but it will go down as the space technology will advance. Taking into account that the capacity utilization ratio of PV in outer space is several times higher than those on the earth surface, we should involve this concept in the list of long term energy technologies.

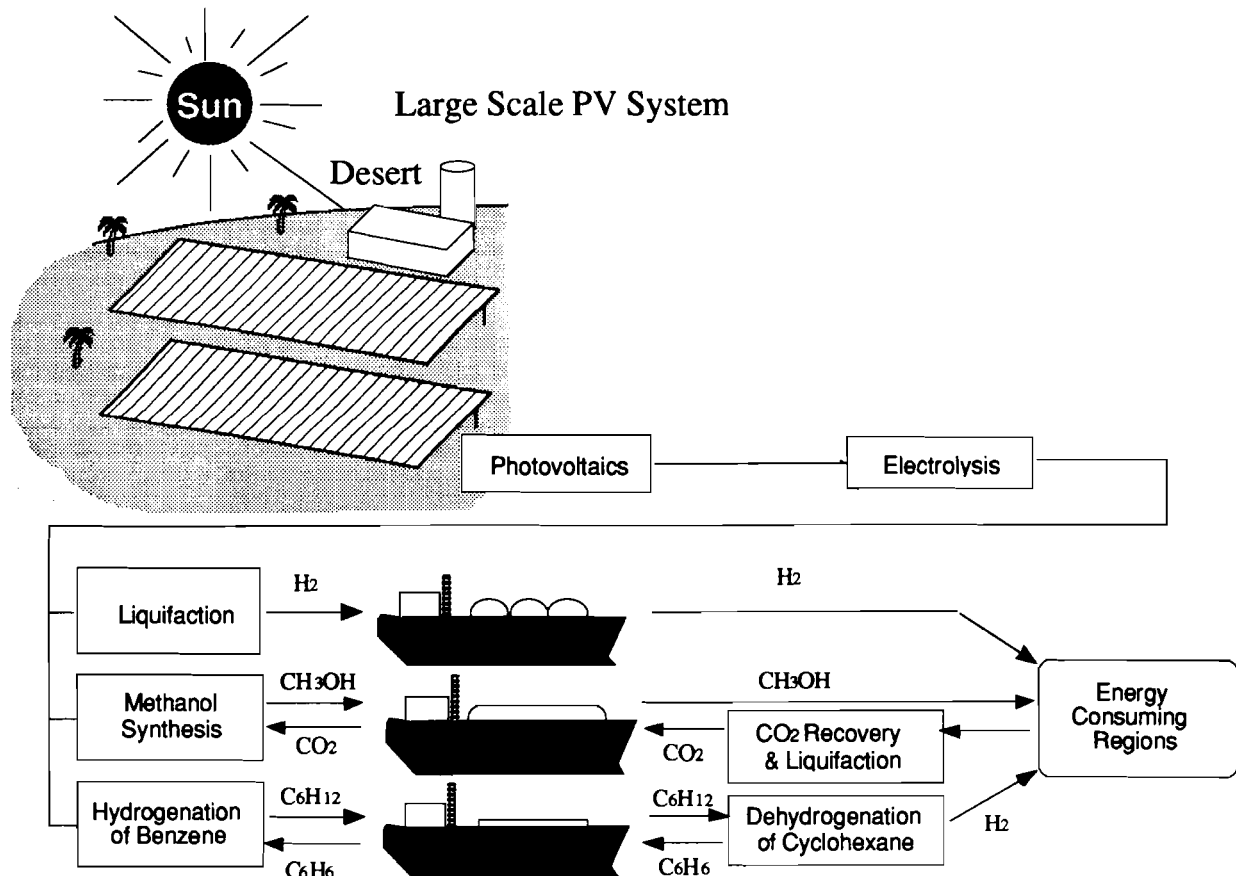

Figure 1.2.3 Large Scale PV System and Long Distance Transportation of Clean Energy

1.2.3 PV in Developing Countries

PV system is however a useful electric power source when power distribution lines are not available, particularly in those regions of developing countries in which electrification is not advanced yet.

We should notice that electrification is still at the stage of development in a number of developing countries, and Asian developing countries is not an exception. For example about 37% of the population of Thailand live still without electric power supply and 32% of Malaysian people to. Introduction of PV systems in those areas where such people live will be one of attractive ideas and will contribute to reduction in emission of various pollutants such as NO_x, SO_x and CO₂.

1.3 Biomass

1.3.1 Biomass Energy in Developed Countries

Historically speaking, biomass energy has been developed as by-products of waste management. Wood-fired power plants in USA had been installed in timber & pulp industries to utilize saw mill and barks.^[1-3-1] A greater part of electricity produced in these plants had been consumed within these factories, and in this sense it had been regarded as non-commercial energy. Then, the utilization of the biomass including agricultural residue has been expanded to commercial electric power generation. Urban waste power plants are also within this category. Urban wastes belong to biomass, and their average heat content is as much as 2,000 cal per gram. They have to be burnt to reduce its volume for easier waste disposal. Urban waste power plants have been installed to utilize the heat thus produced, and in Japan they supplied electricity mostly to waste disposal factories.

Other examples are alcohol production in USA and rape oil utilization in Europe. Both fuels are used as automobile fuels with the government subsidization. Alcohol from sugar cane in Brazil has also been used for an automobile fuel, and has been regarded as the only biomass fuel which is competitive with gasoline. Its production had been expanded up to 12 billion liters by 1990, and it has been substituted for gasoline by mixing it at the ratio of 20~22%. However, the economic feasibility for the alcohol production is still in doubt at the condition of low oil price, less than \$24 per barrel.^[1-3-2] Until now, economically feasible biomass production have never been established except firewood for domestic use at least in developed countries.

The available energy from waste disposal is limited, so that economical development of other types of biomass production is desired. Short rotation of woody crops looks the most economically feasible biomass production.^[1-3-3] Genetically improved hardwood trees are grown under good management systems that use weed control, fertilizer, and pesticide to maximize yields. In short rotation woody

crops we can harvest trees only after 5~7 years growth, and will obtain inexpensive woody fuels than before. One of the promising way to utilize trees for energy production is to burn them as fuels for electric power plants. To minimize the transportation cost of woody fuels, the power plant will be located in the center of the plantation area. Then, the land is divided into six or eight parts. These parts are rotationally used for fuel production. Electricity from these power plant is currently somewhat too expensive to make the plant feasible (refer to Table 1.3.1), but its future seems to be very promising.

Table 1.3.1 Cost of Electricity from Wood-fired Power Station

country	cost [*]	scale	Area
USA ^[1-3-3]	7 cent/kWh	100MW	6 mile radius(30 thousand ha) divided into 6 areas
Japan ^[1-3-4]	20 cent/kWh	50MW	13.5km square (20 thousand ha) divided into 8 areas
Brazil ^[1-3-5]	8 cent/kWh	50MW	

* Presently, the average electricity production cost is about 5 cent/kWh in USA, and 8-10 cent/kWh in Japan.

Although biomass production is limited by land use for other purposes, i.e., agricultural use, forest reservation, and pulp & timber industries, some crop exporting countries have room for biomass production. USA and European countries have surplus crop fields where the land is currently occupied forests and they will be cultivated if crop production is in shortage. The land of this type is called potential arable land. FAO statistics showed that the forest area in developed countries increased in the last decade, whereas it decreased in developing countries.^[1-3-6] Table 1.3.2 shows the potential arable land in the world regions.

Table 1.3.2 Potential Arable Land for Biomass Production

Area	potential arable land 10 ⁶ ha	Arable land 10 ⁶ ha	unused arable 10 ⁶ ha	potential energy from unused 10 ⁶ TOE
World Total	3012	1507.6	1504.1	7226
Africa(sub sahara)	815.7	201.3	614.4	3004
Middle East/N.Africa	85.9	83.3	2.6	13
Asia	334.6	280.1	54.5	266
C.P.E.Asia	129.4	109.3	20.1	79
North America	264.0	234.0	30.0	117
Latin America	889.1	194.6	694.5	3395
Western Europe	89.0	80.0	9.0	26
E. Europe & USSR	308.0	277.0	31.0	91
Oceania	96.0	48.0	48.0	235

*Potential arable land was compiled from World Agriculture Towards 2000, FAO(1988), The Global 2000 Report to the President, USA(1980), and The World Food Problem, the White House USA(1967).

*The area for arable land was quoted from FAO year book.

*The energy production per hectare was estimated by the value of the productivities of the land, 30 to 50 million kilocalories per ha for potential arable land.

*We estimated these potentials on the basis of the productivities attained by presently available plantation technologies.

Currently, North America and Western Europe are eager for biomass production. In the next 20 years, biomass energy of 28 MTOE could be exploited for commercial use. This amount of energy corresponds to 20% of the potential biomass energy in these regions.

1.3.2 Biomass Energy in Developing Countries

Biomass is one of important energy resources in most of developing countries. It is only an energy resource available in those countries which are not endowed with any fossil fuel resources but forest. According to D.O.Hall,^[1-3-7] more than 90% of total energy was supplied from biomass in many developing countries.

In these countries, agriculture is a major industry. The biomass fuels are mainly used for domestic purpose. They consist of not only firewood and charcoal, but also agricultural and animal wastes, of which a part is used as fertilizer. Agricultural and animal waste are mixed into soils of crop fields after fermentation to maintain soil fertility. This indicates that use of too much biomass as energy resources may give rise to low productivity of the crop fields, or soil erosion by lack of organic materials in the soil. The key issue is how to expand biomass energy while keeping sustainable production in agriculture.^[1-3-8]

We still have a huge potential of biomass production as shown in Table 1.3.2. A greater part of unused arable land is found in Africa and Amazon area of Latin America, and is mostly covered with forest. The population in these regions is rapidly growing, and some of the countries in the regions are suffering from food shortage. It seems most unlikely that a huge area of forests will be exploited for non-food purpose. In sum we believe that biomass will be still used only for domestic purpose in the next 30 years, and that the commercial use of biomass fuels including their conversion into alcohol will be limited.

1.4 CO₂ Sequestration

1.4.1 CO₂ Recovery

Fossil fuels nowadays occupy the majority of the world commercial energy supply. Coal is, without consideration of the threat of global warming, the most promising energy resources, as coal is cheap and its reserves are still abundant and spread worldwide. Coal fired power plants occupy around 38% of the entire power supply. Some nations such as China and Poland are and will be heavily dependent on coal in the twenty first century. Around 30% of CO₂ in the world is emitted from thermal power plants. It indicates that technologies to recover CO₂ from flue gas of thermal power plants and sequester it in some storage sites are to be developed.

Various processes for CO₂ removal have been developed and many technologies for CO₂ recovery are proposed. This report doesn't aim to deal with the details of CO₂ removal technologies. The proceedings^[1-4-1] of the First International Conference on Carbon Dioxide Removal describes the detailed information about newest research on CO₂ recovery.

CO₂ can be recovered from flue gas either by chemical absorption, adsorption or cryogenic distillation. Since the development of chemical absorption process by the use of amine, this process has been utilized in the food and chemical process industries as well as in enhanced oil recovery application. Chemical absorption is for the time being the most effective, because it allows large scale processing with relatively low cost. Selection of concrete separation process including choice of solvent depends upon the composition, pressure and temperature of the flue gas. In the case of coal gasification process CO₂ can be removed from fuel gas in a high efficiency by physical absorption utilizing the shift reaction before the gas is burnt^[1-4-2]. The total cost of CO₂ removal varies from process to process but in the range of 50~100% of power generation cost.

Fossil fuel combustion with O₂/CO₂ mixtures is expected to be effective for improving combustion efficiency and for CO₂ recovery from flue gas without the process of CO₂ separation. In this process air separation to produce highly pure O₂ is necessary instead of CO₂ separation, and pure O₂ is diluted by CO₂ for the control of combustion temperature. Many studies indicate that this process is more economic than the process of CO₂ capture after burning.^[1-4-3,1-4-4]

CO₂ recovery from thermal power plants will increase the cost of power generation by 50~100%. This cost, however, is cheaper than the cost of power generation by non-fossil energy such as photovoltaics.

1.4.2 Ocean CO₂ Disposal

Then how do we dispose CO₂ thus removed from flue gas? Among various candidates the following two are promising, i.e. ocean disposal and subterranean sequestration. Ocean has the largest CO₂ storage capacity. Ocean disposal includes sequestration of liquid CO₂ at deep sea, disposal of CO₂ in a form of hydrate or dry ice, and dissolution of CO₂ at shallows.

The most important matter of ocean CO₂ disposal is to reduce harmful influence on ecosystems. Ocean CO₂ disposal can be classified into two cases; concentration-type and diffusion-type. Liquid CO₂ disposal at deep sea is one of the concentration types to control the diffusion of CO₂. Dissolution of CO₂ at shallows is one of the diffusion types to aim the dilution of CO₂.

If liquid CO₂ is sequestered at a depth of more than 3000 m below sea level, it will sink to the seabed by its own weight and stay there.^[1-4-5] CO₂ hydrate will be formed at the surface of contact between CO₂ and seawater, and this CO₂ hydrate will work as a barrier of CO₂ diffusion.^[1-4-6] CO₂ hydrate (CO₂ - nH₂O n=6~7) is stable under the condition of temperature of below 10.2 °C and pressure over 44.5 atm. The density of CO₂ hydrate is 1.04~1.07 g/cm³.

It is predicted that liquid CO₂ injected at the depth of 200~400 m is dissolved into the sea water before it reaches the sea surface.^[1-4-7] Dissolution of CO₂ makes the density of sea water larger, and this will lead a down-flow of sea water.^[1-4-8] CO₂ dissolved at deep sea will stay longer time than CO₂ dissolved at shallows.

Each method has both merits and demerits. Formation of dry ice needs more energy than liquid CO₂. Precision techniques are necessary for the production of CO₂ hydrate in the ocean. It is uncertain that the CO₂ dissolved at shallows always flows down to the deep sea.

CO₂ sequestration at a depth of more than 3000 m below sea level is promising for some countries including Japan. It is predicted based on mathematical modeling that CO₂ disposal into ocean more than 3000 m depth would delay equilibrium with the atmosphere for several hundreds years. Figure 1.4.1^[1-4-9] shows the sea area of 3000 m deep or more. It seems difficult to dispose CO₂ in the deep ocean from most parts of the former USSR, China, midsection of U.S.A. and European countries.

It is still unknown for ocean disposal how long it would take for circulation to bring the CO₂ back to the atmosphere and what the effect of large amount of CO₂ on the ocean ecosystem would be.

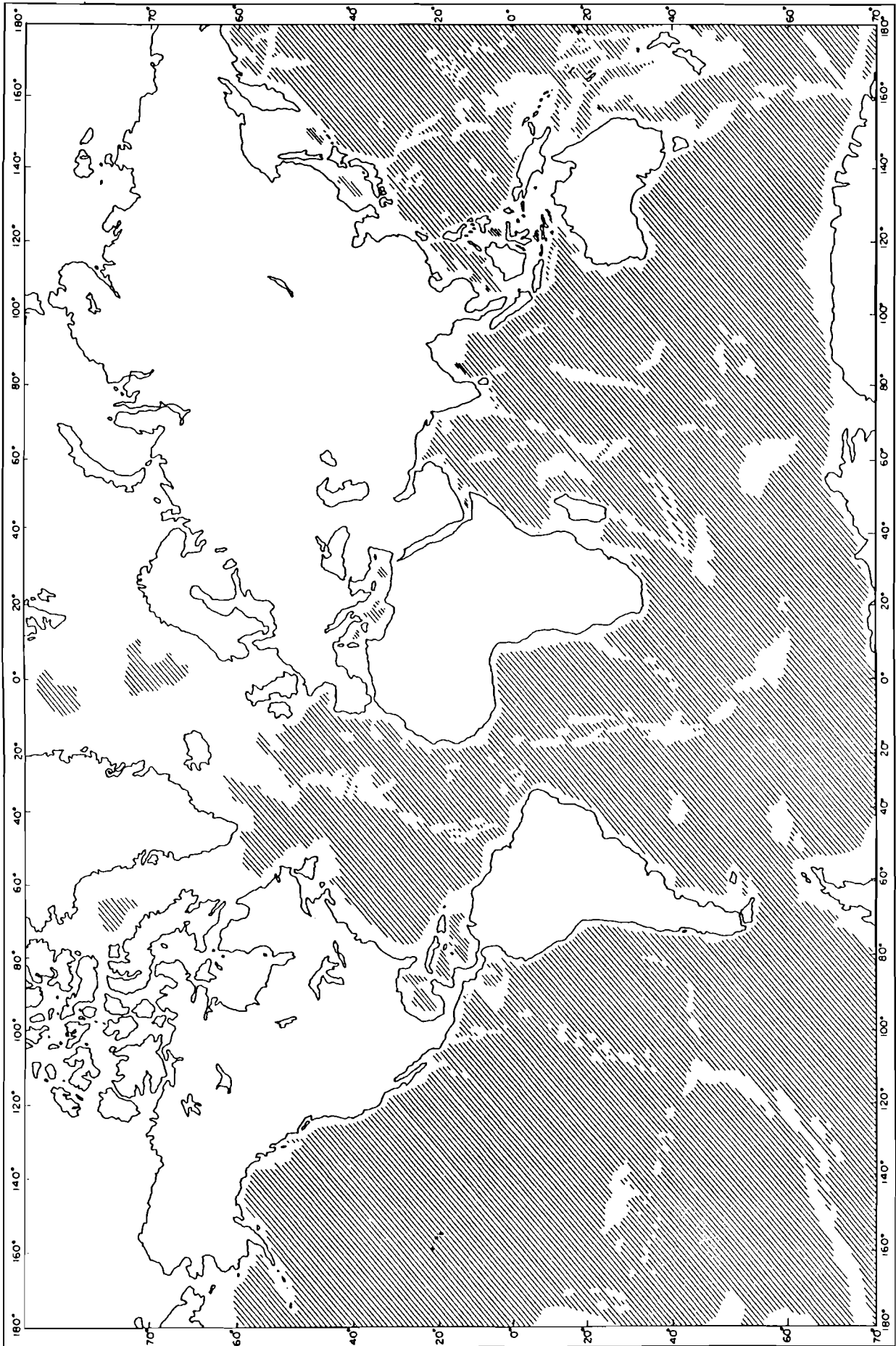

Figure 1.4.1 Sea Areas of 3000 m Deep or More^[1-4]



Figure 1.4.2 Distribution of Sedimentary Basins^[1+4+8,1+4+11]

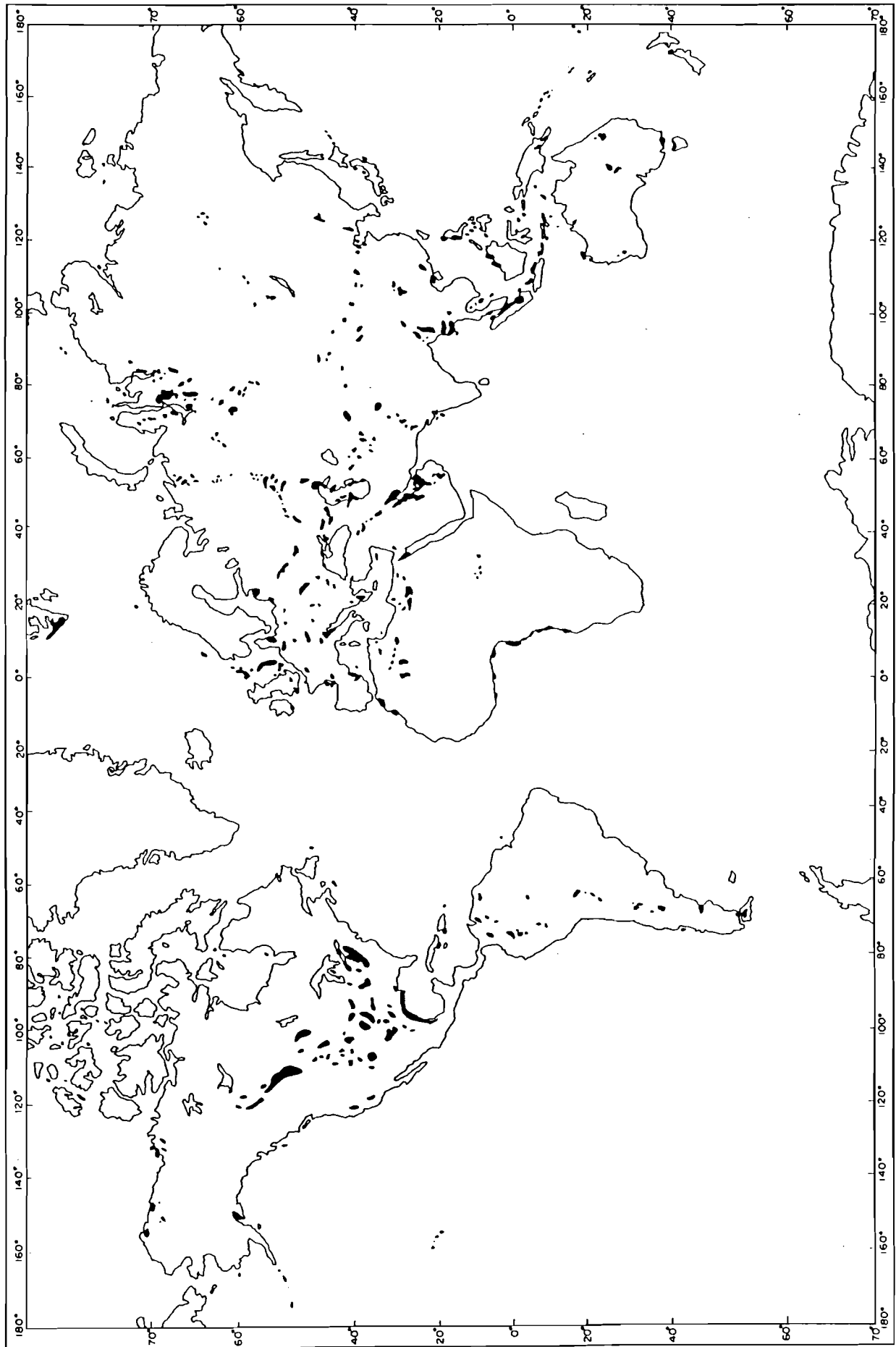

Figure 1.4.3 Distribution of Oil and Gas Fields^[1-4,8,14-11]

1.4.3 Subterranean CO₂ Disposal

Subterranean CO₂ disposal includes sequestration of CO₂ at aquifers, storage of CO₂ in the depleted natural gas wells, and injection of CO₂ in the oil wells for enhanced oil recovery. There exist huge volumes of unused aquifers in the earth due to high salinity of the ground water. The total capacity of CO₂ sequestration in the aquifers of about 2000~3000 m depth in the world is estimated as about 87 Gton carbon.^[1-4-10] Aquifers locate in the depths of sedimentary basins, which differ widely in size and exist in various regions of the world as shown in Figure 1.4.2.^[1-4-9,1-4-11] It is estimated that total CO₂ storage capacity in the depleted natural gas wells in the world is about 49 Gton carbon (mainly in the former USSR and the Middle and Near East).^[1-4-12] The total capacity of CO₂ sequestration on the enhanced oil recovery is estimated to be about 34 Gton carbon.^[1-4-13] Figure 1.4.3^[1-4-9,1-4-11] shows the distribution of oil and gas fields in the world. Natural gas wells and oil wells are unevenly distributed compared to aquifers. Most of the natural gas wells will be depleted a few decades from now. More than half of world oil wells exist at the Middle and Near East, and the their life is estimated to be more than eighty years^[1-4-14].

As compared with ocean disposal, subterranean CO₂ disposal has a few merits. Ocean disposal needs a CO₂ liquefaction process for the storage at a port and the transportation by a tanker. Liquefaction process is unnecessary for subterranean disposal, because gaseous CO₂ can be injected continuously into the subterranean sites by passing through pipelines at high pressure. It is also considered that the influence of subterranean CO₂ disposal on ecosystem is much smaller than ocean disposal. The subterranean CO₂ disposal is suitable for the inland areas such as the most parts of the former USSR, China, European nations and the midsection of USA.

1.5 Nuclear Power

Among commercially available energy technologies, nuclear power generation represents a useful non-fossil technology along with hydro power generation. Even when indirect CO₂ emissions from power plant construction and various fuel cycle processes are taken into account, the amount of CO₂ emission per unit energy production related to nuclear power generation is evaluated well less than one tenth of that of conventional fossil power generation. Technical potential of nuclear power in reducing CO₂ emission is apparently quite huge. Nuclear power in the world, actually, supplied about two trillion kWh in 1991; there would have been around 500 million t-C of CO₂ emission if the equivalent amount of electricity had been produced by coal-fired power plants.

Data on the trends in nuclear power developments, however, imply that the first nuclear era is closing to its end in several regions of the world. The total capacity of operating nuclear power plants in the

world reached around 330 GWe (gross output) by the end of 1980s; and then, it has been rather slightly decreasing for the past few years mainly due to closedowns of nuclear power plants before the expected plant life.

Since nuclear power developments involve a long lead time, near term future of nuclear power can be forecasted with certainty by evaluating the amounts and status of backlogs in the pipeline of construction and planning processes. Through the review of regional data of nuclear power developments, we find many regions where new nuclear commitments have been suspended for more than ten years: Sweden and Italy declared withdrawal from nuclear power; Switzerland and Spain officially froze nuclear power plant construction; de facto nuclear moratorium has come into being in USA and Germany; and many existing reactors in ex-USSR and eastern Europe are going to be closed because of safety concerns. On the other hand, active plans of nuclear power developments can be found only in a handful of countries such as far east Asia and France. Operating nuclear power capacity in the world will be around 400 GWe (gross output) in 2000.

In contrast with the relatively certain near term future, long term projection of nuclear power involves many uncertain factors such as public attitudes, electricity demands, financial conditions, regulatory climate, regimes for nuclear non-proliferation, and new technology developments. For around twenty years beyond 2000, maximum limit of operating nuclear power capacity will depend on the capability of reactor manufacturers, prospects of life extension of existing reactors, and maximum nuclear shares in electricity supply in several advanced regions. Maximum world increment rate of operating nuclear power capacity will range from twenty to thirty GWe per year. There could be a net decrease in nuclear power capacity; however, it would be quite a difficult task to find alternative clean energy sources since a standard nuclear power reactor of one GWe produces around 250 billion kWh and saves around sixty million t-C for its forty year plant life.

2. Model Building and Scenario Analysis

The proceeding chapter has attempted to give some brief indications of how and what technologies can contribute individually toward reducing CO₂ emissions. The purpose of the study in this chapter is to obtain for the first time an insight into the question of what combination of technologies will be most attractive from the view point of economic practicability and technological feasibility.

In order to answer this question, we are building a new global energy model which can explicitly take into account engineering characteristics of the CO₂ abatement technologies and both the potentials and cost-supply curves of regional energy resources.

2.1 The Outline of the Model

The model we are building is a technology oriented energy model with the following principal characteristics.

Geographical coverage : The whole world (divided into 10 regions)

Time horizon : From 1990 to 2050 at intervals of 10 years

Methodology : Nonlinear optimization (semi-dynamic)

Our major concern is not to predict either the volume of future energy demand or the growth rates of world economy, but rather to develop future scenarios of the CO₂ abatement technologies. The model attempts to draw pictures of desirable future energy systems under various energy demand scenarios. We will explain the outline of the model briefly in the following section.

2.1.1. Geographical Coverage and Time Horizon

The technological potentials are often constrained by regional factors, such as the sectoral structure of energy consumption and the availability of natural resources. For a logical and consistent technology assessment, it is necessary to identify energy systems of different world regions.

In the model, the whole world is geopolitically divided into 10 regions: 1)North America, 2)Western Europe, 3)Japan, 4)Oceania, 5)Centrally Planned Economy Asia, 6)South & East Asia, 7)Middle East & Northern Africa, 8)Subsaharan & Southern Africa, 9)Latin America, 10)Former USSR & Eastern Europe. (Figure2.1.1)

Most of the differences in the regional technological potentials are thought to be evaluated properly in this division framework. However, in such a rough framework, it is possible that the intra-regional heterogeneity of the energy systems may be completely ignored, and furthermore international trades of fuels and CO₂ within the individual region cannot explicitly be taken into account.

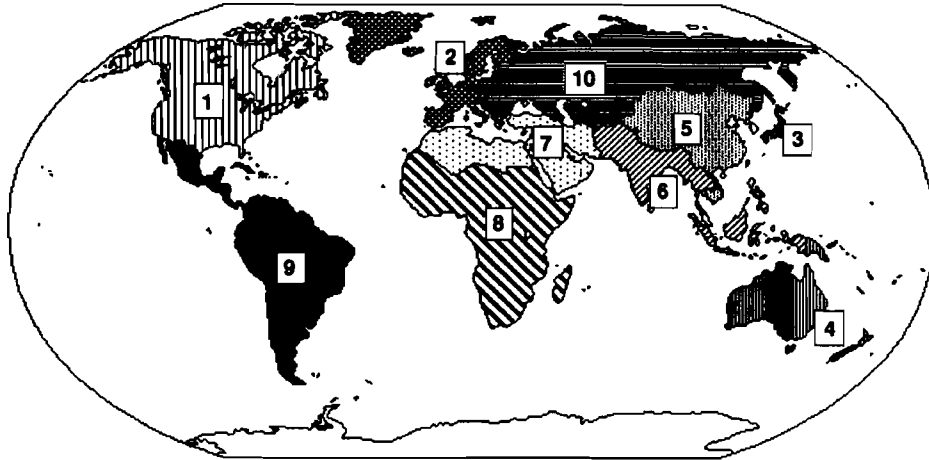

Figure2.1.1 Divisions of the World Countries

The CO₂ problem requires quite a long term analysis of future energy systems. Currently published literature on the CO₂ problem indicates that it is unlikely that we can settle the problem early in the next century, and suggests that the time horizon of this kind of analysis should be as far as the middle of the next century. However, the longer time horizon does not necessarily yield more meaningful results of the analysis. The time horizon is inevitably restricted by one fundamental factor, that is the uncertainties in the long term projections on future energy demand and technological innovation. For example, some future technologies, such as a nuclear fusion technology, might be successfully utilized on a commercial scale in the second half of the next century. The application of these highly advanced technologies might drastically change future CO₂ emission profiles. Therefore we decided that the moderate terminal year of the model should be the year 2050.

2.1.2. Methodology

The global energy model given here is formulated as a complex of single-period nonlinear optimization problems with inequality and equality linear constraints. The energy model seeks the optimal solution for the future world energy system at intervals of ten years. The constraints in the model represent supply-demand balances, mass and energy balances in the various types of energy plants of each period, and several inter-temporal constraints such as limitations on the maximum growth rates of annual fuel production. The objective function of the problem is defined as the sum of fuel production costs, levelized plant construction costs, fuel transportation and electricity

transmission costs, and the amount of the tax levied on CO₂ emissions into the atmosphere. The cost functions of primary energy supply, CO₂ subterranean storage, and energy conservation are assumed to be nonlinear.

The existing capacity of each type of plant during the one simulation period in question is derived from the computational results of the preceding periods and the historical data between 1950 and 1990. The resource depletion of each kind of fossil fuel and the stored volume of CO₂ in subterranean reservoirs are computed from the integrals of the annual production of the fuel and the annual amounts of CO₂ injected into the reservoirs respectively in the foregoing periods. Our model can therefore take account of the dynamics of the energy systems, and can sketch out fully consistent scenarios of their future evolution.

Unlike most of the existing energy models, such as MARKAL, our energy model places great emphasis on inter-regional optimization of the world energy system. Avoiding explosive increases in both the computation time and cost, this model does not conduct inter-temporal optimization, and we should note that this is one of the crucial points of the model. However, we do not necessarily think that this period-by-period optimization approach significantly deteriorates either the validity or the usefulness of the model. Considering both the sensitivity of an inter-temporal optimization problem solution for presumed future scenarios, and the inherent uncertainties as to future energy demand and fuel prices, we can reasonably expect that carefully conducted scenario analyses by the period-by-period approach can provide us with helpful guidelines for future technology development.

The inter-regional optimization model which seeks an equilibrium of world energy trade is formulated on the basis of the maximum principle of discrete type. The maximum principle is generally applied to a dynamic optimization problem, but here in this model it is applied to a transportation problem. We will refer to the world energy trade in more detail in section 2.1.7.

2.1.3. Energy Supply

In the framework of our model, three primary energy categories are used: fossil fuels, renewables, and nuclear energy. As seen in Table 2.2.1, the first two categories are disaggregated further with respect to carbon emission coefficients, production costs, and power supply characteristics.

Table 2.1.1. Disaggregation of Primary Energy Sources

Fossil Fuels	Oil, Natural Gas, Coal, Shale Oil
Renewables	Biomass, Hydro & Geothermal, Solar, Wind & Other Renewables
Nuclear Energy	Nuclear fission

Recent studies of oil and gas resources^[2-1-1-2-1-3] have estimated that the worldwide amount of crude oil and natural gas resources are approximately 230~340 GTOE and 250 GTOE respectively. With the wide variety of economic and geological conditions, their production costs can be estimated only with considerable uncertainty. The worldwide cost-supply curves of crude oil and natural gas production are illustrated in Figure 2.1.2, in which one can see a general tendency of the cost escalation caused by resource depletion.

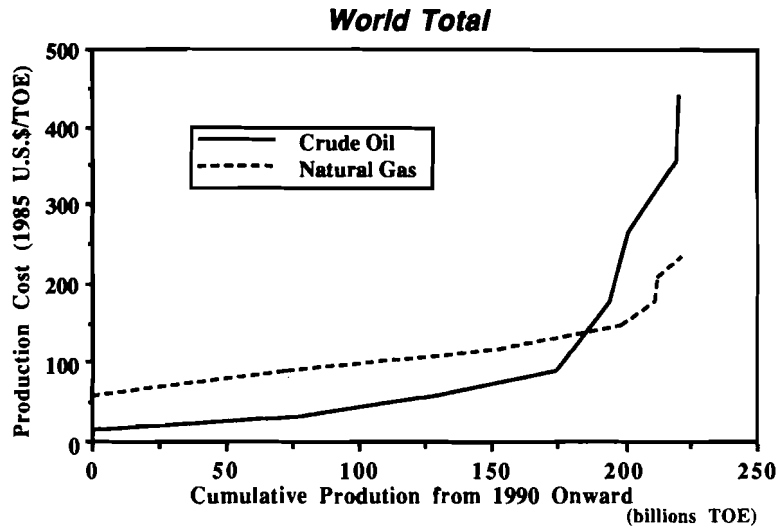

Figure 2.1.2 Estimated Cost-Supply Curves^[2-1-1,2-1-2]

In our model, the production costs of fossil fuels are expressed as functions of their cumulative productions by region. The well head or pit head prices of these fuels are computed as the sum of the above production costs, their levelized finding costs, and royalties.

In the case of renewable energy, production costs are expressed as functions of annual productions. The related input data of the current optimization model are derived mainly from the estimates made by WEC^[2-1-3], IIASA (ECS)^[2-1-4], SERI^[1-2-1] and MITI (the government of Japan)^[1-2-2], and from a recent study by B. Dessus.^[2-1-5] The assumed world potentials of biomass (for commercial use), hydro & geothermal energy, and wind energy are about 2,000 MTOE/year, 10,000 TWh/year and 5,000 TWh/year respectively. The biomass energy in the current study does not include either agricultural wastes or municipal solid wastes. In case of solar and wind energy, their respective maximum capacities are assumed to be limited to 15% of the total capacity of a regional power system in order to maintain supply reliability. It should be noticed that most of the practical potentials of renewable energy are still uncertain, to say nothing of their future production costs. This is because the practical potentials are highly dependent on site characteristics, which can significantly affect the capacity factors of capital intensive facilities and the cost for measures to mitigate harmful impacts on local environment.

Nuclear power generation is certainly a useful non-fossil fuel technology, but many uncertain factors, such as the difficulty in obtaining public acceptance of nuclear power plants, makes their future prospects less clear. Future development paths of nuclear power can hardly be assessed through the use of an optimization model which minimizes simply the costs of energy systems. In our model, the future total capacities of nuclear power plants are given as scenarios by region and year.

2.1.4. Energy Demand and Conservation In End Use Sectors

The end use sector of the model is disaggregated into the following seven sectors: gaseous fuel for heat use, liquid fuel for heat use, liquid fuel for automobile, liquid fuel for aviation, solid fuel for heat use, solid fuel for iron & steel industry, and electricity (peak, intermediate, off-peak). The amounts of future energy demand in each sector are exogenously given as scenarios by region and year. We assumed that electricity can substitute for all types of fuels for heating use, and that gaseous or liquid fuels can substitute for solid fuels for heating use.

The evaluation of the possibilities of both electric and hydrogen fueled vehicles are assumed to be incorporated in the process of building the energy demand scenarios.

Table 2.1.2. Disaggregation of End Use Sectors

End Use Sector	Available Fuels & Electricity
Gaseous Fuel for Heat Use	Hydrogen, Natural Gas, Electricity
Liquid Fuel for Heat Use	Oil, Methanol, Syn. Oil, Electricity
Liquid Fuel for Automobile	Oil, Methanol, Syn. Oil
Liquid Fuel for Aviation	Oil, Syn. Oil, Hydrogen (Liquified)
Solid Fuel for Heat Use	Coal, Biomass, Gaseous & Liquid Fuels, Electricity
Solid Fuel for Iron & Steel Industry	Coal, Biomass
Electricity (peak, intermediate, off-peak)	Electricity

Using a cost supply curve of energy conservation measures in each end use sector, we can also evaluate an energy conservation potential. Although the software of the model was already formulated for this purpose, we have not conducted a complete system analysis of the energy conservation potentials so far, due to the difficulty in arranging a detailed and comprehensive data set on the end use sectors especially in developing regions.

In order to make a rough estimation of the energy conservation potentials, we are planning to take a rather simplified approach, in which the required cost for energy conservation in each sector is calculated from the cost-supply curve represented by only a couple of parameters, such as the price elasticity of sectoral energy demand. The arrangement of the cost-supply curves of energy conservation is still under way.

2.1.5. CO₂ Recovery, Disposal and Storage

One of the notable features of this model is that it can explicitly analyze the roles of processes of CO₂ recovery, disposal, and storage in the world energy system. As specific measures for CO₂ recovery, we consider both chemical absorption from flue gas of thermal power plants and physical adsorption from output gas of fossil fuel gasification plants. The physical adsorption is assumed to be installed also in IGCC (Integrated coal Gasification Combined Cycle) power plants.

As mentioned in the previous chapter, there are two major methods for CO₂ disposal: ocean disposal and subterranean disposal. Subterranean disposal is classified into three types: 1) sequestration of CO₂ at aquifers, 2) storage of CO₂ in depleted natural gas wells, and 3) injection of CO₂ into oil wells for EOR (Enhanced Oil Recovery) operation. The energy model given here takes account of all these disposal methods, and can assess their future potentials by world region. The operational cost for subterranean disposal is assumed to increase in accordance to the depletion of the storage capacity of CO₂. It should be noted, however, that the estimates of both their storage capacities and operational costs are still uncertain. In this study, the analysis is mainly based on the estimates made by Japanese experts.^[1-4-10,1-4-12,1-4-13] Specifically, we have assumed the practical capacity of subterranean CO₂ storage to be about 150 Gton of carbon in the world. This estimate seems to be comparatively conservative as compared to those made by experts in the Netherlands.

In the case of ocean disposal, CO₂ is assumed to be liquified, and then to be transported to offshore disposal sites by tanker. Unquestionably the storage capacity of the ocean is sufficiently large, but it is very difficult to estimate specific costs for the secure deposition of CO₂ in the ocean. This is because there are many types of uncertainties: changes in pH of the seawater, clathrate formation on the seabed, and the resultant ecological impacts. In this study, we assumed a prohibitively high CO₂ deposition cost so that this disposal method cannot be easily adopted. In order to get an insight into the technological feasibility of ocean disposal, we additionally conducted sensitivity analyses of the deposition cost by varying it from zero to two hundred dollars per ton of carbon. The deposition cost does not include either the transportation cost or the liquifaction cost of CO₂.

In the model, the recovered CO₂ is assumed not only to be disposed of, but also to be recycled as a chemical feedstock for methanol synthesis plants which produce methanol from CO₂ and hydrogen. This option can build up a kind of carbon cycle within the energy system, but the amount of CO₂ thus recycled is limited by the regional capability of hydrogen provision.

2.1.6. Regional Energy Model

The configuration of the regional energy model is shown in Figure 2.1.3. The global energy model consists of ten of these regional models.

Regional Model

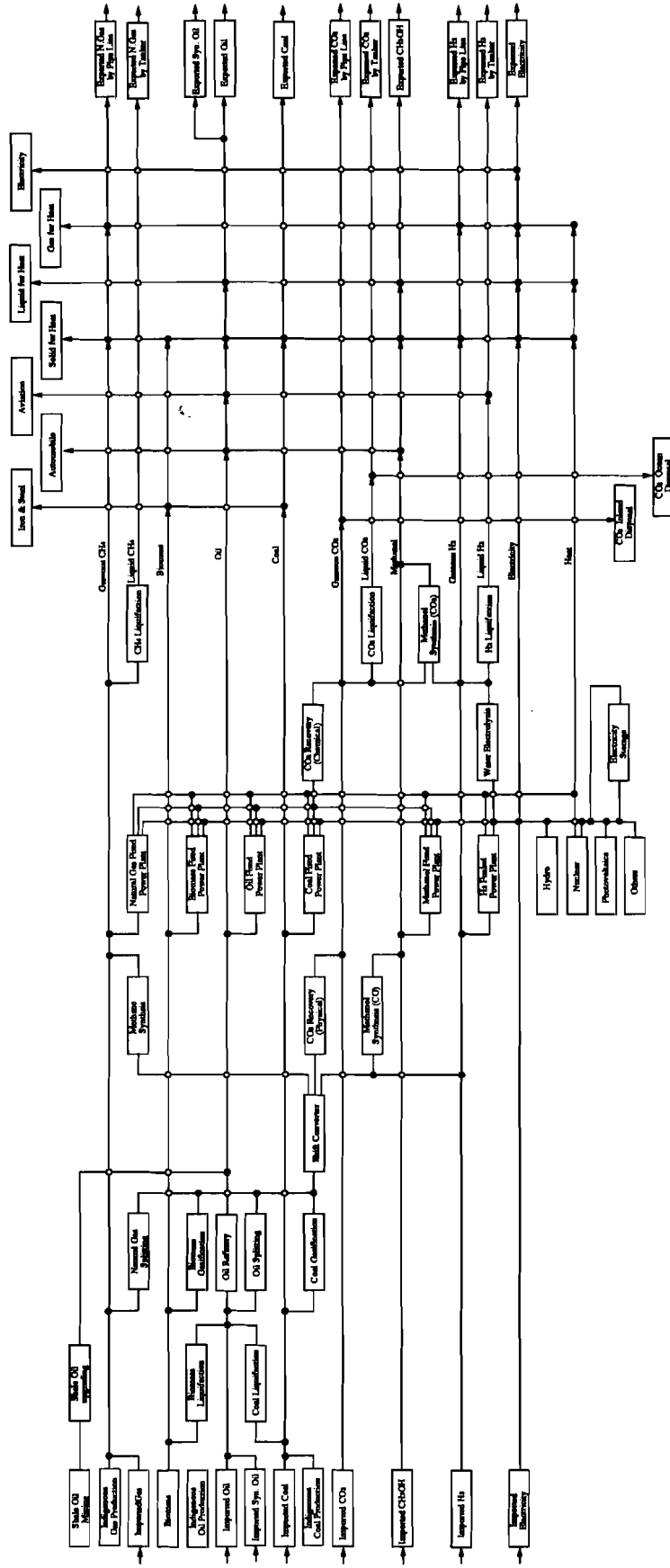

Figure 2.1.3 Configuration of the Regional Model

The part representing the oil refinery process is rather simplified, as compared to existing energy models. This is because our working effort has been mainly focused on the evaluation of future energy technologies.

In the case of electricity sectors, we explicitly take into account daily load duration curves expressed simply with three time periods (peak period, intermediate period and off-peak period), so as to determine how each type of power plant will be operated in accordance with diurnal variation of electricity loads. (Figure 2.1.4) This is because some of the future energy technologies, such as photovoltaics and water electrolysis, are closely related to electric power systems, and the capacity factors of these capital-intensive technologies are supposed to have a great influence on their economic characteristics.

The maximum capacities of solar and wind power generation are limited to 15% of the total capacity of the regional power system. However, if water electrolysis and/or electricity storage are used, then we assume that this constraint on their capacities no longer applies.

The maximum contributions of cogeneration and CHP (combined heat and power) to regional heating demand will be given as scenarios exogenously.

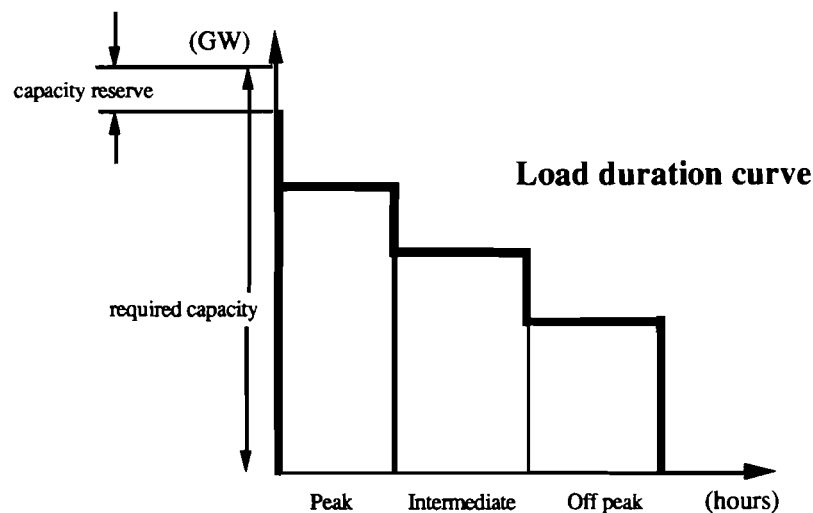

Figure 2.1.4 Daily Load Duration Curve

In addition to thermal electric power plants, various types of energy conversion plants, such as coal gasification plants, are introduced as technology options. An elaborate integration of these plants together with CO₂ recovery facilities has great potential for providing low carbon intensity fuels, such as methanol and hydrogen, without much additional CO₂ emissions from their conversion processes. Such integration can be expected to contribute remarkable reductions in net CO₂ emissions from the end-use sectors, especially from the automobile sector.

2.1.7. Inter-regional Trade

The above regional models are linked to each other by inter-regionally traded goods. These are hydrogen, natural gas, recovered CO₂, electricity, oil, coal, methanol, and synthetic oil. We have not included the inter-regional trade of biomass, unless it is converted into gaseous or liquid fuels.

The transportation cost of liquid and solid fuels are relatively inexpensive as compared to gaseous fuels. In order to reduce the size of the model, the quantities of liquid and solid fuels are equilibrated only in their respective world markets. The transportation costs are assumed to be constant, irrespective of the distances.

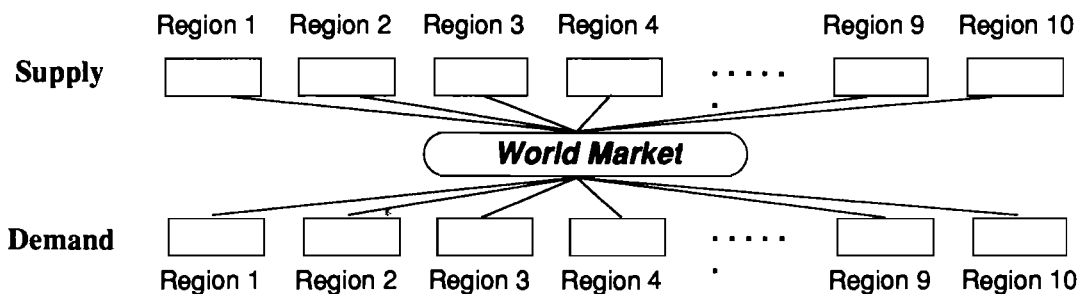

Figure 2.1.5. The inter-regional Trades of Solid and Liquid Fuels

In contrast with solid and liquid fuels, the unit transportation costs of natural gas, hydrogen, electricity and CO₂ are remarkably more expensive, and therefore make noticeable differences in the CIF (cost, insurance and freight) of these traded goods by transportation distance. In our model, as shown in Figure 2.1.6, the quantity of each type of the goods demanded by each individual region is assumed to be a balance of the quantities supplied by all of the other nine regions. This formulation enables us to identify the inter-regional trade patterns and the associated transportation costs by each bilateral trade path.

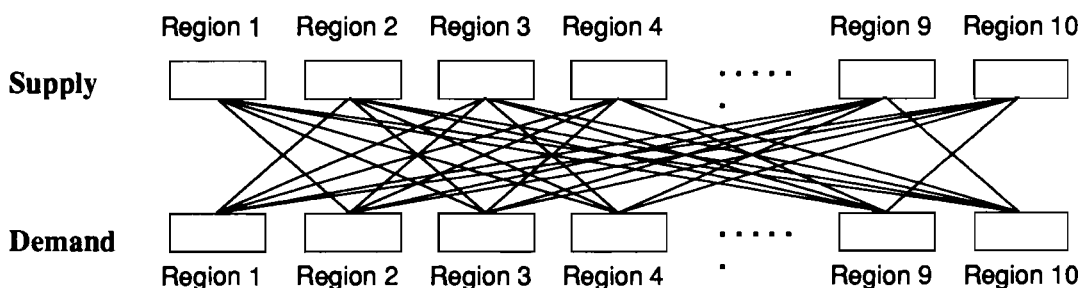

Figure 2.1.6. The inter-regional Trades of Gaseous Fuels, Electricity and CO₂

The transportation distances between the world regions were specified simply on the basis of those between the following representative cities of the respective regions: Chicago, North America; Brussels, Western Europe; Tokyo, Japan; Sydney, Oceania; Beijing, Centrally Planned Economy Asia; New Delhi, South & East Asia; Cairo, Middle East & Northern Africa; Lagos, Subsaharan & Southern Africa; Rio De Janeiro, Latin America; Moscow, Former USSR & Eastern Europe.

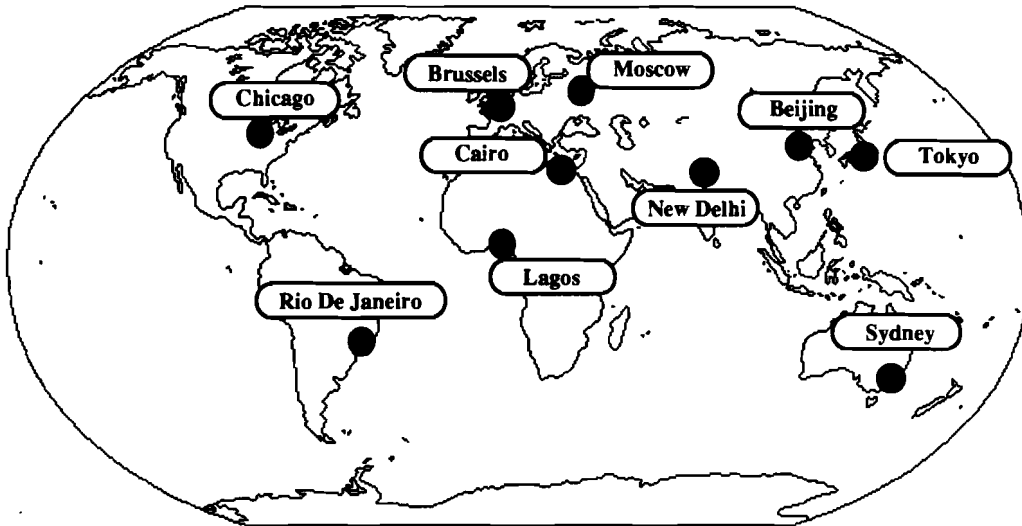

Figure 2.1.7 Representative Cities in the World Regions

We assumed trans-continental pipelines and DC transmission lines as means of land transportation. In the case of ocean transportation, hydrogen, natural gas and CO₂ are assumed to be liquified, and then to be transported by tanker.

2.2 Energy and CO₂ to the year 2050 : Scenario Analysis

2.2.1. Scenario Assumptions

⊙ **Energy Demand**

Scenarios of future energy demand in this study were derived from the report of IPCC emission scenarios. We assumed three scenarios: 'Higher Growth case', 'Lower Growth case', and 'Average Growth case.' The first two scenarios correspond to the cases of '2030 High Emissions - Higher Growth' and '2030 High Emissions - Lower Growth' in the above IPCC report respectively. It is to be noted that we made some modifications in the original scenarios so as to make them consistent with the disaggregation framework of the energy model given here. 'Average Growth case' scenario was calculated as the simple arithmetic average of the above two extreme scenarios. End use fuel and electricity demand of the world in these scenarios are illustrated in Figure 2.2.1 and Figure 2.2.2.

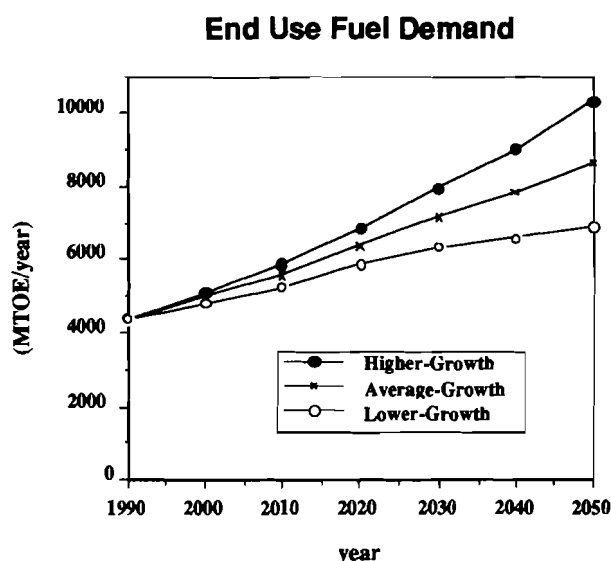

Figure 2.2.1 Scenarios of End Use Fuel Demand

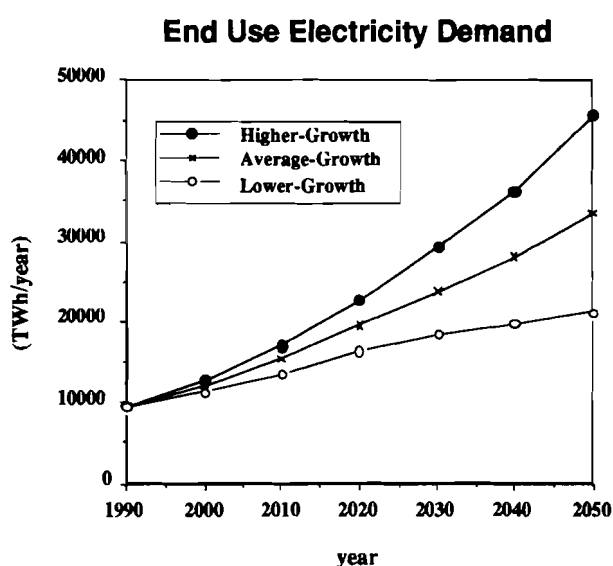

Figure 2.2.2 Scenarios of End Use Electricity Demand

⊙ **Carbon Tax**

In the scenario analysis of this study, a carbon tax is introduced as a policy parameter. We assumed four cases of carbon tax scenarios in addition to the 'Base Scenario' (i.e. business-as-usual), as shown in Table 2.2.1. These tax scenarios are also illustrated in Figure 2.2.3. We assumed equal tax rates in all countries irrespective of the world regions. Please note that we are not implying that any of these taxation policies should be recommended.

Table 2.2.1 Carbon Tax Scenarios

Base Scenario	No carbon tax
Tax Scenario 1	Carbon tax fixed at 100 dollar per ton of carbon during the simulation period
Tax Scenario 2	Carbon tax fixed at 200 dollar per ton of carbon during the simulation period
Tax Scenario 3	Carbon tax incremented at the rate of 30 dollar per ton of carbon per decade
Tax Scenario 4	Carbon tax incremented at the rate of 60 dollar per ton of carbon per decade

The carbon tax in this study should be interpreted as a simple indicator of the incentive to reduce CO₂ emissions from the energy system. The optimization problem defined here is a multi-objective optimization problem concerned with both the costs of the energy systems and the amounts of CO₂ emissions into the atmosphere. The carbon tax in this model is thus a weighting parameter of the CO₂ emissions term in the objective function. Therefore the obtained solution in this model describes the optimal energy system that fully adopts the abatement measures with costs of less than the carbon tax for reducing one unit of carbon emission, but not measures with costs that exceed the carbon tax.

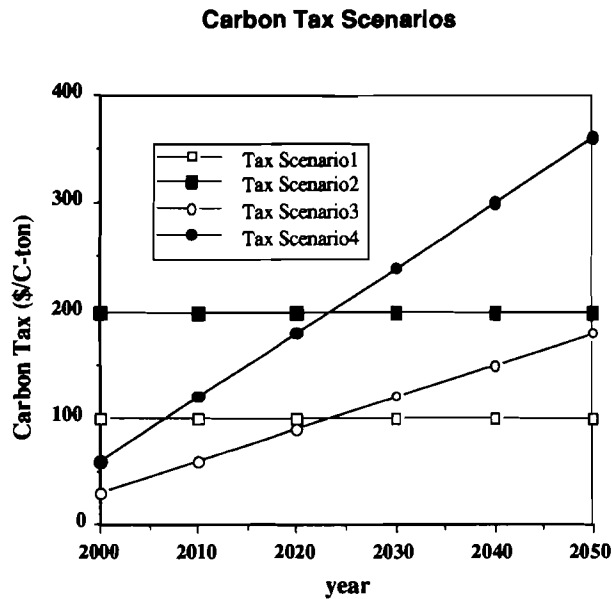

Figure 2.2.3 Carbon Tax Scenarios

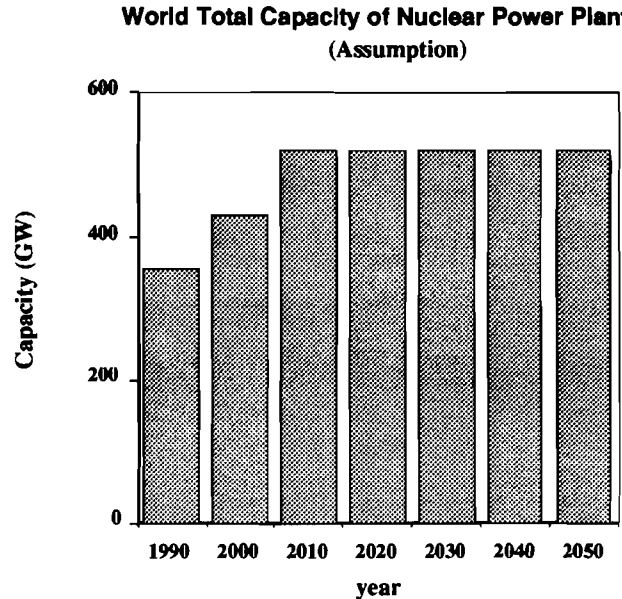

Figure 2.2.4 Assumed Nuclear Power Scenario

⊙ Nuclear power

As mentioned in the previous section, future development paths of nuclear power plants are exogenously given as scenarios by region and year. In this study, we assumed a rather conservative nuclear power development scenario which expects that the world total capacity of nuclear power plants will be expanded up to the level of around 500 GW by the year 2010, and maintained at that same level thereafter. (Figure 2.2.4)

2.2.2. Computational Results

The model uses more than 5,000 pieces of input data on the CO₂ abatement technologies and the scenarios, and generates several thousand lines of detailed reports on the future energy systems of each of the world regions. In this paper, however, we only show some of the aggregated computational results of the future world energy system.

An engineering work station takes about one and a half hours to complete a series of six of the single-period nonlinear optimization procedures.

© **World Primary Energy Supply**

The calculated future profiles of world primary energy supply are shown in Figures 2.2.1~2.2.5 by demand and tax scenario. Figure 2.2.6 illustrates their cumulative amounts between 1990 and 2050. A conversion coefficient of 860kcal/kWh was assumed in order to calculate the primary energy equivalents of hydro & geothermal, solar, wind & other renewables, and nuclear energy resources. The values for the year 1990 were derived from IEA statistical data.

Observations of these figures suggest some prospects for world primary energy supply in the future. They are summarized as follows.

- 1) The introduction of a carbon tax enlarges the production of natural gas as expected, but in the 'Higher Growth case', we observed decreases in the natural gas supply for the year 2050 under any of the taxation scenarios in this study. This is obviously due to the natural gas resource depletion accelerated by the carbon tax and the resultant escalation of its production cost.
- 2) The amounts of coal supply under the taxation policies were estimated to decrease significantly as compared to those under the 'Base Scenario' (non tax scenario), but the graphs shown here also suggest an increasing dependency of our future energy systems upon this most carbon-intensive fuel. This result indicates that it will be rather difficult to diminish gross CO₂ emissions from the energy systems. However, as discussed below, it does not necessarily mean that we have no counter measures to control net CO₂ emissions into the atmosphere.
- 3) Since biomass can be regarded as a fuel which does not emit any CO₂ into the atmosphere, a carbon tax of around \$100 per ton of carbon would theoretically make biomass fuels fully competitive with conventional fossil fuels. Under such carbon taxation policies, biomass can be expected to provide economically substantial amounts of energy for some particular regions, such as Latin America and Sub-Saharan Africa. However, it can meet only a portion of the world energy requirements. As we suggested in the previous chapter, it seems to be very difficult for many developing countries to increase remarkably the production of biomass fuels in a renewable way. This is mainly because most future agricultural activities in these countries are thought to be concentrated on the production of food crops rather than biomass for fuel in order to sustain their rapidly growing populations.
- 4) The contributions of the renewable energy resources other than biomass to the future world energy system were estimated to be rather small in spite of the expected remarkable improvement in these future technologies. To expand the shares of solar and wind energy, it seems to be necessary to make further improvements not only in electricity generation technologies, but also in their related technologies, such as those for electricity storage and water electrolysis.

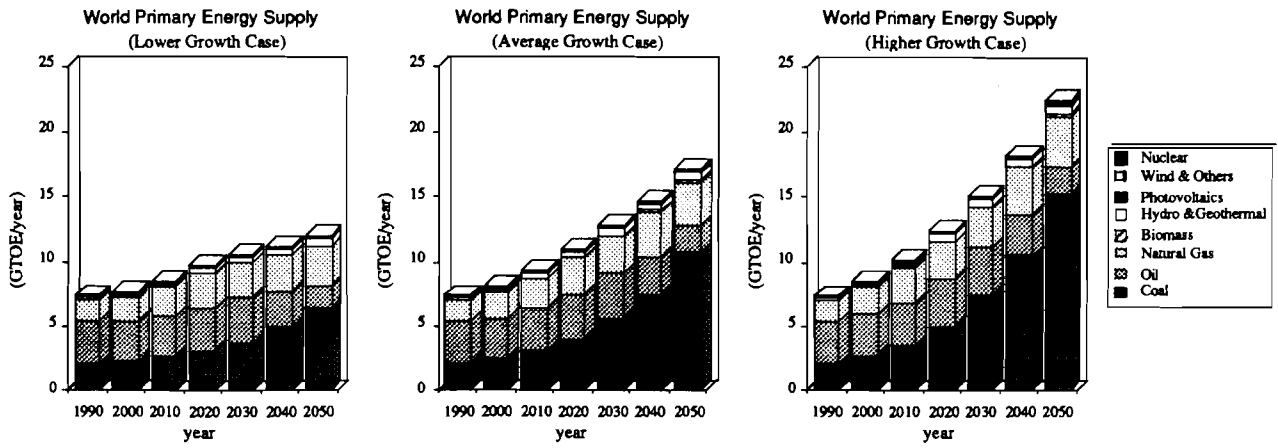

Figure 2.2.1 World Primary Energy Supply (Base Case)

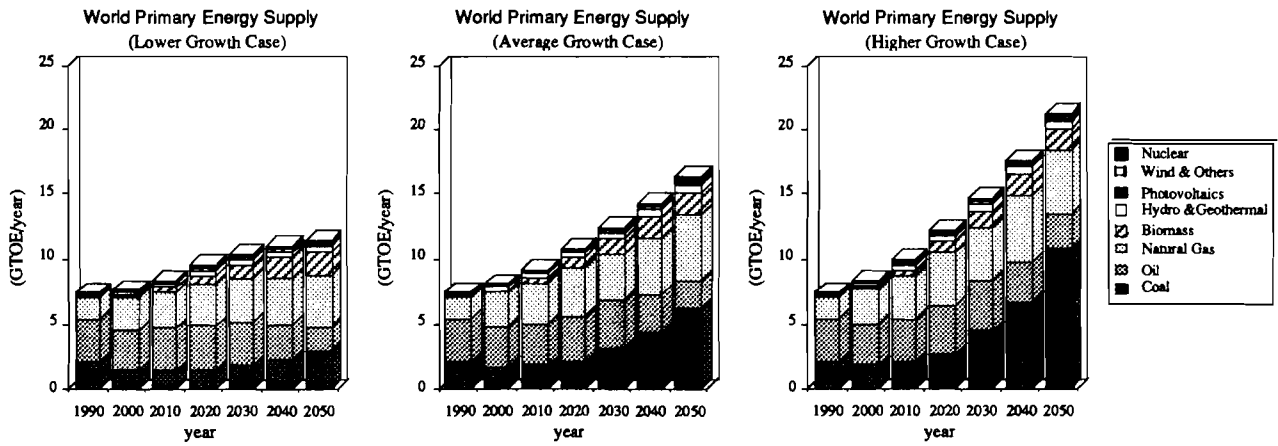

Figure 2.2.2 World Primary Energy Supply (Tax Scenario 1)

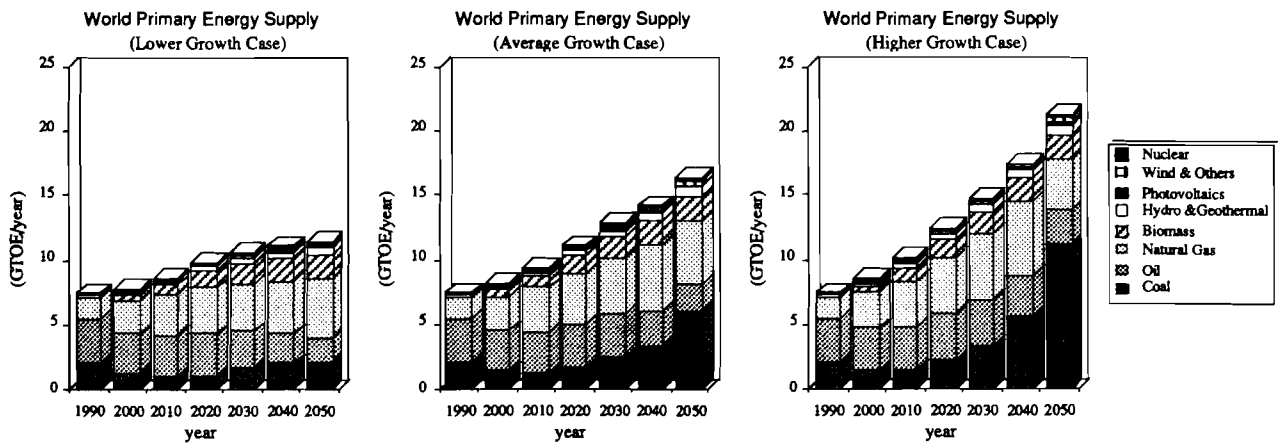

Figure 2.2.3 World Primary Energy Supply (Tax Scenario 2)

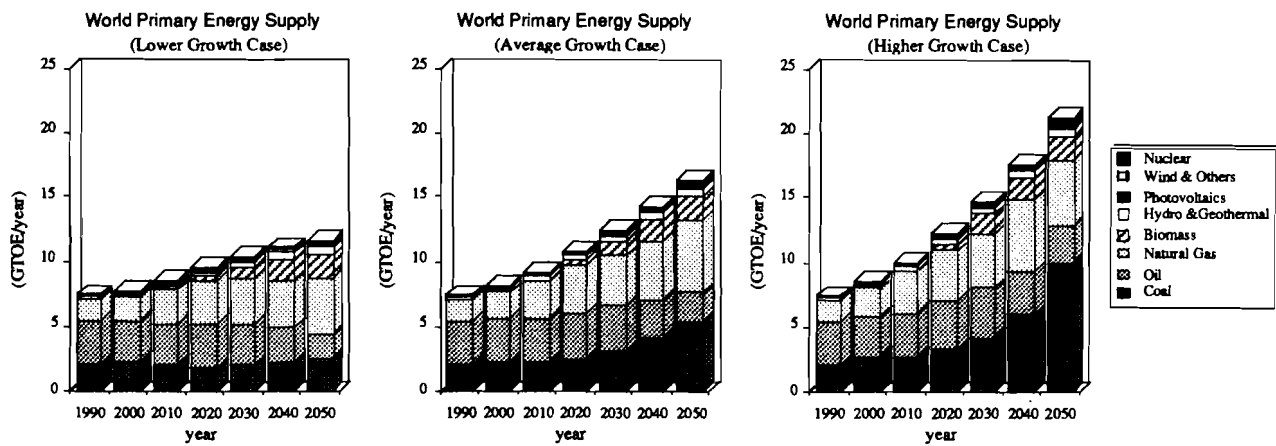

Figure 2.2.4 World Primary Energy Supply (Tax Scenario 3)

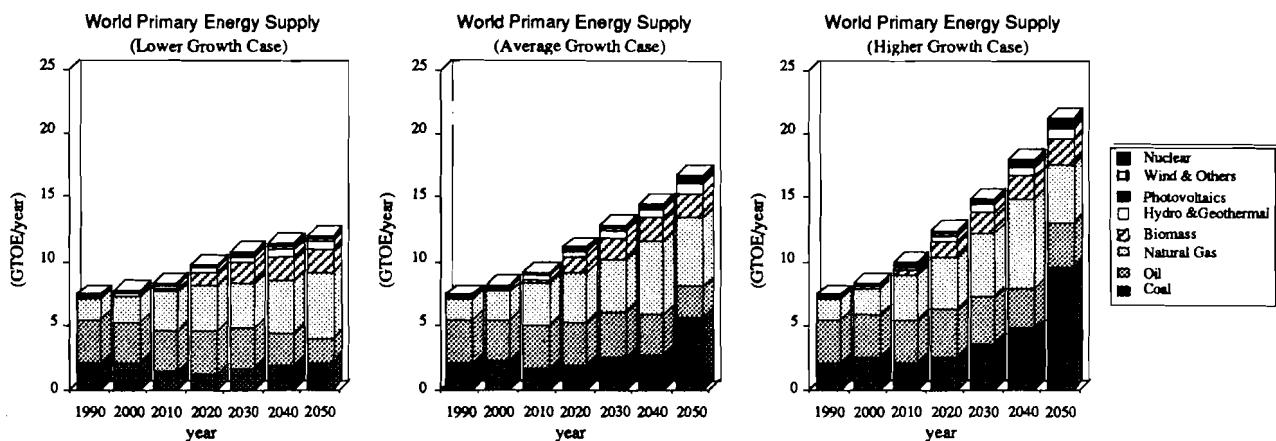

Figure 2.2.5 World Primary Energy Supply (Tax Scenario 4)

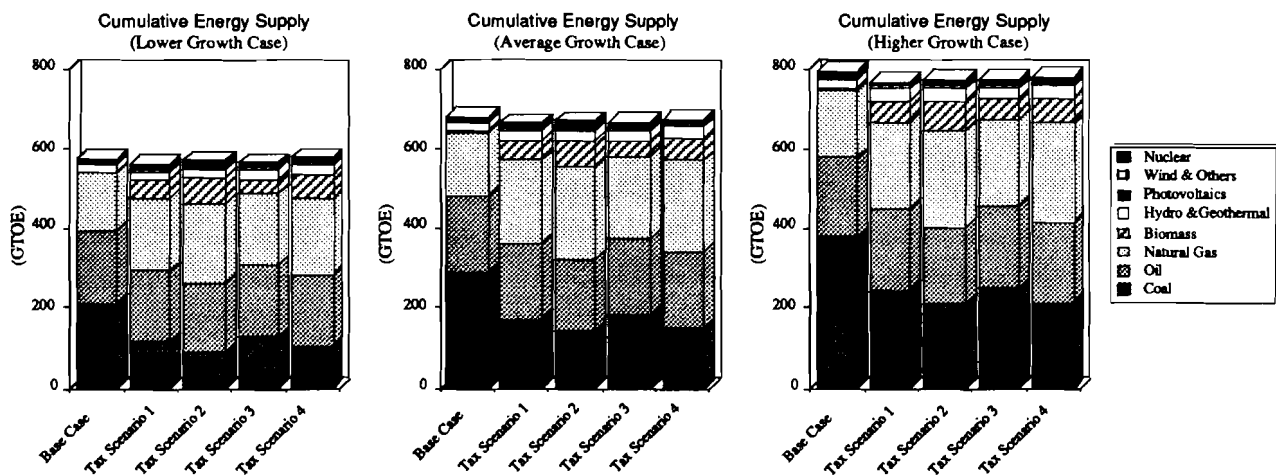

Figure 2.2.6 Cumulative World Primary Energy Supply between 1990 and 2050

© **Carbon Dioxide Emission and Disposal**

The estimated future emission and disposal profiles of CO₂ in the world as a whole are shown in Figure 2.2.7 and Figure 2.2.8 respectively. The cumulative amounts of the emission and disposal of CO₂ between 1990 and 2050 are illustrated in Figure 2.2.9. On the assumption that the so-called airborne fraction of CO₂ is simply a constant value of 40%, a cumulative emission of 100 Gton of carbon corresponds approximately to an increase of 20 ppm in the atmospheric concentration of CO₂. Please note that carbon emissions in these figures do not include the emissions originating from deforestation. Biomass fuels in this study are assumed to be produced in an entirely renewable way.

In this section, assuming the prohibitively expensive deposition cost of CO₂ in the ocean, we deliberately left out ocean disposal as a technology option for reducing net CO₂ emissions into the atmosphere. In a later section, we analyze the feasibility of ocean disposal through a sensitivity analysis on the deposition cost.

As seen in these figures, the calculated future profiles of CO₂ emissions diverge greatly by demand and tax scenario. Careful observations of these figures, however, lead to the following intriguing discoveries.

- 1) In each demand scenario given here, the emission profile of Tax Scenario 1 indicates that a carbon tax of \$100 per ton of carbon effectively induces notable amounts of CO₂ emission reduction without adopting CO₂ recovery and disposal. For example, in the year 2050, a reduction of 2~3 Gton in annual carbon emissions is estimated to be achieved under such a tax scenario.
- 2) The insensitivity of the amounts of gross CO₂ emission¹ to the different tax scenarios can be observed in Figure 2.2.8. The results suggest that there exist limitations on the practicable fuel switching that can be applied to reduce the average carbon-intensity of the supplied primary energy resources, and also suggest the relevance of the technology option of CO₂ recovery and disposal in order to attain a still more stringent emission reduction goal.
- 3) Figure 2.2.8 also shows that the amount of CO₂ injected into reservoirs reaches nearly 100 Gton of carbon by the terminal year under the relatively higher tax scenarios. This amount of carbon is equivalent to about two-thirds of the world total capacity of the reservoirs assumed in this study. The results obtained here imply that we would face a shortage of the reservoirs in due course of time. Particularly, in view of the tremendous amount of coal resources in the world, it is not difficult to imagine that the amount of probable future carbon emissions will absolutely exceed the ultimate capacity of subterranean reservoirs even according to more optimistic capacity estimates.

¹ gross emission = net emission + disposal

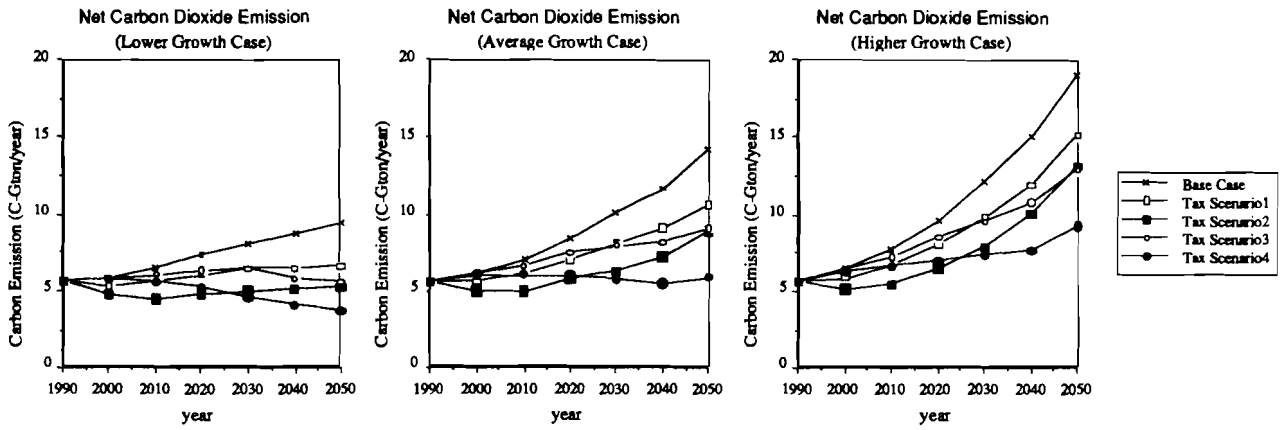

Figure 2.2.7 Net Carbon Dioxide Emissions

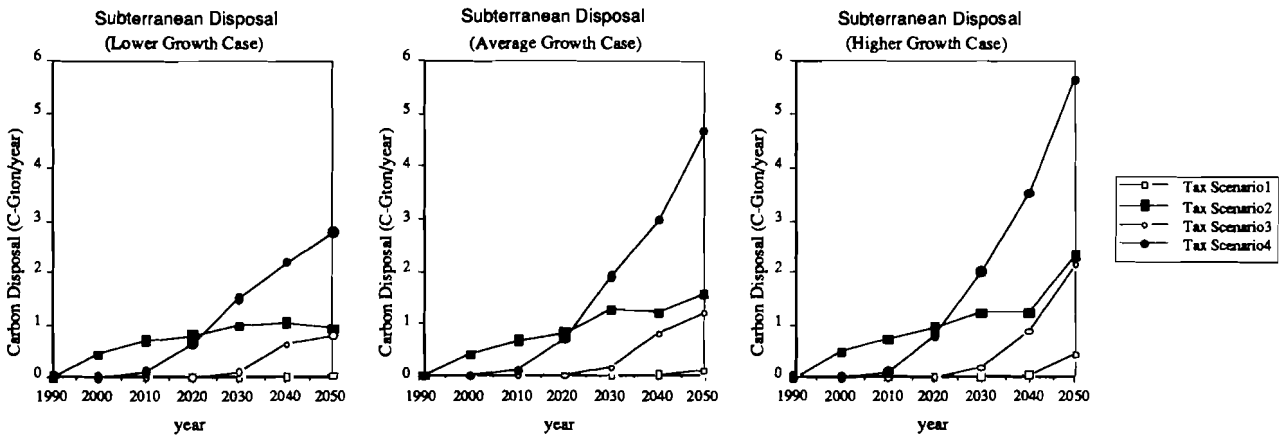

Figure 2.2.8 Carbon Dioxide Subterranean Disposal

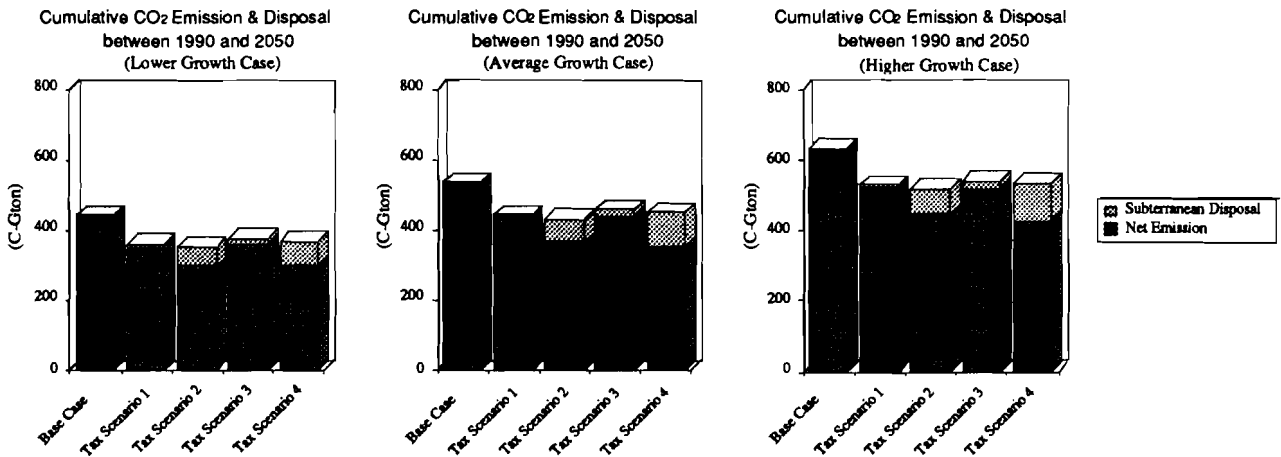

Figure 2.2.9 Carbon Dioxide Cumulative Emission and Subterranean Disposal

©Sensitivity Analysis of Carbon Dioxide Ocean Disposal

In order to reduce net CO₂ emissions into the atmosphere, ocean disposal of recovered CO₂ seems to be a very attractive technology option along with subterranean disposal. As we mentioned in the previous chapter, however, ocean disposal of CO₂ involves numerous uncertainties, such as environmental impacts of the disposed CO₂ in the deep ocean, and the required cost for their mitigation measures.

To obtain an insight into the feasibility and practicability of ocean disposal, we conducted a sensitivity analysis of the CO₂ ocean deposition cost by varying it from zero to two hundred dollars per ton of carbon. In this model, the system cost for recovery, liquifaction and transportation of CO₂ is appraised by region separately from the ocean deposition cost considered here. The computational results for 'Average Growth Case' are shown in Figure 2.2.10.

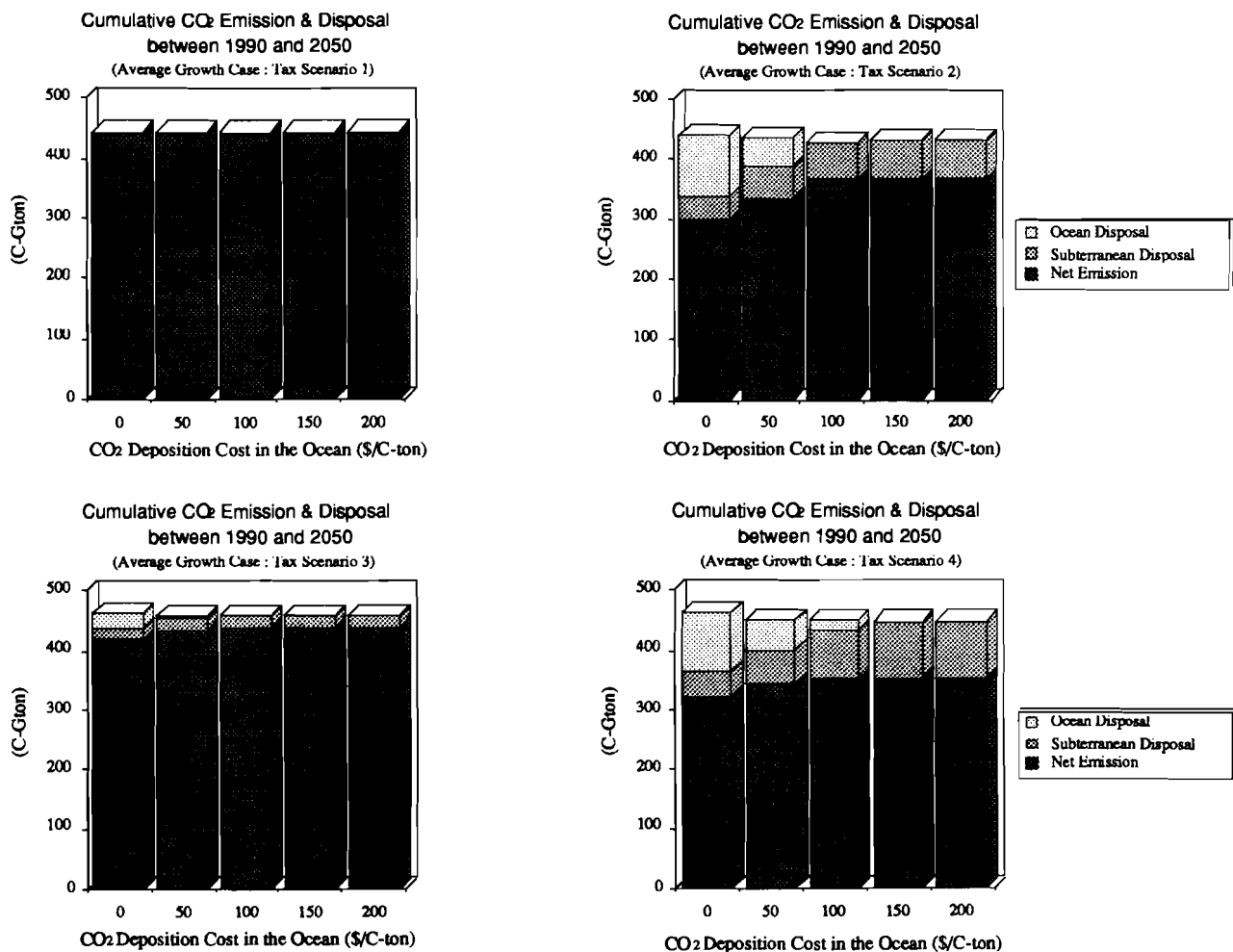

Figure 2.2.10 Sensitivity Analysis of the CO₂ Ocean Disposal

The results shown in Figure 2.2.10 indicate that the ocean disposal of CO₂ can be a cost-effective technology option for reducing net CO₂ emissions, if the ocean deposition cost of CO₂ is less than roughly \$100 per ton of carbon. However, even when the deposition cost is assumed to be nothing, significant amounts of CO₂ are estimated to be emitted into the atmosphere. This suggests the necessity of a much more rigorous taxation policy than those assumed in this study.

In the cases of Tax Scenarios 2 and 4, we actually observed a slight increase in the amount of gross CO₂ emissions when ocean disposal is conducted on a large scale. This is obviously stemming from the deterioration of the net efficiency of the total energy system.

2.3 Concluding Remarks

The purpose of the study in this chapter was to obtain for the first time an insight into the question of what combination of technologies would be the most attractive, through the use of the global energy model given here. With considerable uncertainties as to various assumptions made in this study, the results of the scenario analysis are summarized as follows.

- 1) Our energy system will be still dependent on fossil fuels in the middle of the next century. The share of coal in total primary energy supply will gradually increase, even if we introduce a carbon tax of a few hundred dollars per ton of carbon. Solar, wind and other renewable energy sources will be able to meet only a fraction of the world energy requirements.
- 2) A certain amount of CO₂ emissions can be reduced solely through fuel switching from coal to less carbon-intensive fuels, such as biomass and natural gas. However, a further reduction in net CO₂ emissions into the atmosphere can hardly be attained without CO₂ recovery and disposal operation.
- 3) Subterranean disposal of recovered CO₂ is one of the most attractive technology options, but the capacity of the subterranean reservoirs is probably not large enough to completely settle the CO₂ problem. Ocean disposal of CO₂ can be an alternative technology option if the ocean deposition cost of CO₂ is less than about \$100 per ton of carbon.

The scenario analysis considered in this chapter is still not yet complete. Please note that this is not a final report of our analysis, and that the renewal of the input data may change to some extent the computational results shown here. The results of the entire work and detailed computational results will probably be reported in 1993, together with the results of the technology assessment discussed in the previous chapter.

References

- [1-1-1] Y. Kaya et al, "Assessment of Technological Options for Mitigating Global Warming", Energy and Industry Subgroup, WG 3 of IPCC on August 6-7, 1991 in Geneva (1991)
- [1-1-2] Institute of Building Energy Conservation: "Energy Conservation Handbook '85" (1985) (in Japanese)
- [1-1-3] The Institute of Energy Economics: "Econometric Analysis of Substitution for Oil Utilizing a Model of Energy Supply and Demand", pp152-155 (1987)
- [1-1-4] Combined Cycle I, Fossil and Nuclear Power Generation, Vol.35, No.4 (1984) (in Japanese)
- [1-1-5] H. Moritsuka, "Thermal Efficiency Analysis on Coal Gasification Combined Cycle Power System (1st report; Calory Based Analysis)", J. of the Japan Society of Mechanical Engineering, Vol.52, No.484 (1986) (in Japanese)
- [1-1-6] Energy Balances of OECD Countries, 1986-1987, IEA
- [1-1-7] H.M.Grothcurth, R.Kummel, et al., "Thermodynamic Limits to Energy Conservation", ENERGY, Vol.14, No.5, pp.241-258 (1989)
- [1-2-1] Solar Energy Research Institute, The Potential of Renewable Energy -An Interlaboratory White Paper-, SERI/TP-260-3674, DE90000322, March (1990)
- [1-2-2] K.Takahashi, "Recent Progress in Solar Cells", ENERGY AND RESOURCES, Japan Society of Energy and Resources, Vol.11, No.1 (1990) (in Japanese)
- [1-2-3] P. E. Glaser, Power from the Sun, Science, 162, p.3856 (1968)
- [1-2-4] U.S.Department of Energy, Satellite Power System, FY 79 Program Summary, (1980)
- [1-3-1] C.E.KeeganIII and T.P.Jackson, Forest Production Journal, 35(10), p.56 (1985)
- [1-3-2] A.K.N.Reddy and J.Goldenberg, Scientific American, 263(3), p.62 (1990)
- [1-3-3] Electric Power Research Institute, Biomass State of the Art Assessment, EPRI GS-7471 (1991)
- [1-3-4] unpublished data of ours
- [1-3-5] PLANO 2010, Plano Nacional de Energia Eletrica 1987/2010, Centrais Eletricas Brasileiras S. A. Eletrobas (1987)
- [1-3-6] FAO, Year book of Production (1988)
- [1-3-7] D.O.Hall, Energy Policy, Vol.19, No.8, p.711 (1990)
- [1-3-8] FAO, World Agriculture Toward 2000 (1988)
- [1-3-9] IEA, Renewable Source of Energy, Paris (1987)
- [1-3-10] The Stockholm Environmental Institute, Options for Reducing Green Gas Emission (1990)
- [1-3-11] E.D.Larson, et.al., Biomass Gasification for Gas Turbine Power Generation in Electricity, p.697, Lund University press, Sweden (1988)
- [1-4-1] Proc. 1st ICCDR, Energy Convers. Mgmt, Vol.33, No.5-8 (1992)
- [1-4-2] R.Matsushashi, et al.: T.IEE Japan, 112-B, 531 (1992)
- [1-4-3] S.Nakayama, et al.: Energy Convers. Mgmt, 33, 379 (1992)
- [1-4-4] C.A.Hendriks, et al.: Energy Convers. Mgmt, 33, 387 (1992)
- [1-4-5] M.Steinberg, et al.: A Systems Study for the Removal, Recovery and Disposal of carbon Dioxide from Fossil Fuel Power Plants in the US, BNL-35666 (1984)
- [1-4-6] T.Ohsumi, et al.: Energy Convers. Mgmt, 33, 685 (1992)
- [1-4-7] C.R.Liro, et al.: Energy Convers. Mgmt, 33, 667 (1992)
- [1-4-8] P.M.Haugen, et al: Nature, 357, 318 (1992)

- [1-4-9] Y.Noguchi: Possible CO₂ Disposal Sites in the World, Electric Power Development Co., Tokyo (1992)
- [1-4-10] H.Koide, et al.: Energy Convers. Mgmt, 33, 619 (1992)
- [1-4-11] U.Suzuki: Global Patterns of Petroleum Basins, Idemitsu Oil Development Co., Ltd., Tokyo (1986)
- [1-4-12] NEDO: Report NEDO-P-9014, Tokyo (1991)
- [1-4-13] NEDO: Report NEDO-ITE-9001, Tokyo (1991)
- [1-4-14] British Petroleum: BP Statistical Review of World Energy (1986)
- [2-1-1] JPDA (Japan Petroleum Development Association), *Studies on resources of oil and natural gas*, JPDA working group for resource assessment, Tokyo (1986)
- [2-1-2] JPDA, *Studies on resources of oil and natural gas*, JPDA working group for resource assessment, Tokyo (1991)
- [2-1-3] WEC (World Energy Conference), *Survey of Energy Resources* (1989).
- [2-1-4] IIASA(ECS), *Long-Term Strategies for Mitigating Global Warming: Toward New Earth*. Report on Contract No.91-128 to Japan Industrial Policy Research Institute, March (1992)
- [2-1-5] B.Dessus, *World Potential of Renewable Energies*, Extraits de la Houille Blanche n° 1-1992, Paris (1992)