

# Working Paper

## Integrating Water into an Economic Assessment of Climate Change Impacts on Egypt

*David Yates*

WP-96-31  
April 1996



International Institute for Applied Systems Analysis □ A-2361 Laxenburg □ Austria

Telephone: +43 2236 807 □ Fax: +43 2236 71313 □ E-Mail: [info@iiasa.ac.at](mailto:info@iiasa.ac.at)

# Integrating Water into an Economic Assessment of Climate Change Impacts on Egypt

*David Yates*

WP-96-31  
April 1996

*Working Papers* are interim reports on work of the International Institute for Applied Systems Analysis and have received only limited review. Views or opinions expressed herein do not necessarily represent those of the Institute, its National Member Organizations, or other organizations supporting the work.



International Institute for Applied Systems Analysis □ A-2361 Laxenburg □ Austria  
Telephone: +43 2236 807 □ Fax: +43 2236 71313 □ E-Mail: [info@iiasa.ac.at](mailto:info@iiasa.ac.at)

# Integrating Water into an Economic Assessment of Climate Change Impacts on Egypt

*David Yates*

## Abstract

*Recent research indicates that larger countries, with multiple agro-climatic zones, have the capacity to adjust to marginal climate changes which could occur over the next century (Adams et al. 1990; Rosenzweig and Parry 1993; Crosson 1993; Darwin et al. 1995). However, in countries with fewer adaptation options and with increasing dependency on imports to meet growing domestic demands, climate change might have significant impacts. To date, little has been done on assessing integrated impacts of climate change in developing countries (Akong'a et al. 1988; Downing, T. 1992; Oneyji and Fisher 1994).*

*This motivates the need for improving and extending the research on the potential impacts of climate change on developing countries. An integrated assessment of climate change impacts on Egypt was performed; incorporating water resources, agronomics, land resources, socio-economics, and economic modeling into a consistent modeling framework. A monthly water balance model of the Nile basin was developed for determining water availability under climate change scenarios. A computable general equilibrium model of world agriculture (Fischer et al 1988) was used and modified to address climate change issues in Egypt, with a focus on the water resources sector. Results indicated that continued structural transformation of the socio-economic system will be necessary to meet growing domestic demands for goods and services— caused by a growing population with a limited resource base. Three of four GCM's (Global Circulation Model) indicate increases in Nile flows which give rise to different development paths. This makes the issue of vulnerability and adaptation assessment difficult because there is a pressing need in Egypt to improve irrigation and agriculture efficiencies. Climate models forecasting increased Nile floods might serve only to delay the implementation of better management strategies through their bright outlook on available water resources.*

# CONTENTS

<b>1. INTRODUCTION</b>	<b>3</b>
1.1. Integrated Economic Modeling	4
1.2. Climate Change Impact Assessments of Agricultural Systems	5
1.3. Water Resources and Climate Change	8
<b>2. OBJECTIVE AND METHODOLOGIES</b>	<b>10</b>
2.1. An Integrated Assessment Tool: The Basic Linked System	10
2.2. The Addition of Water within the SNM	13
2.2.1. Water as a Resource Constraint	13
2.2.2. Water within the Production Function	14
2.2.3. Other Water Demands	15
2.3. Water Resource Modeling of the Nile Basin	15
2.3.1. A Water Balance Approach	15
2.3.2. A Monthly Hydrologic Model of the Nile Basin	19
2.3.3. Climate Change Scenarios for the Nile Basin	29
<b>3. A SKETCH OF THE SOCIO-ECONOMIC STATE OF EGYPT</b>	<b>30</b>
3.1. The Economy, Population Trends, and a Future Perspective	30
3.2. Current and future water use in Egypt	31
3.3. Agronomics and Land	32
<b>4. BASELINE - OPTIMISTIC AND PESSIMISTIC SCENARIOS WITH AND WITHOUT WATER</b>	<b>32</b>
4.1. Reference Scenario: Optimistic	34
4.2. Reference Scenario: Pessimistic	35
4.3. Analysis of the Baseline Scenarios	36
<b>5. CLIMATE CHANGE SCENARIOS</b>	<b>38</b>
5.1. GFDL	42
5.2. GISS	43
5.3. UKMO	43
5.4. LOWEND	44
<b>6. DISCUSSION AND CONCLUSIONS</b>	<b>44</b>

# Integrating Water into an Economic Assessment of Climate Change Impacts on Egypt

## 1. Introduction

Recent assessments of the potential impact of climate change on economic output estimates that the global output of all goods and services might be reduced by as little 1.4% (Nordhaus,1994). Most research on impact assessment thus far has focused on the industrialized countries, primarily due to the fact that they are the greatest emitters of green house gases (GHG) and current research is interested in GHG reduction policy. Nordhaus (1994) points out that specific, national impacts due to climate change are a function of the sectoral composition of national outputs and states that the “stakes” are particularly high for developing countries. Nordhaus surveyed leading experts whose major concern is that climate change impacts are thought to be considerably higher for low-income countries than for high-income countries, yet he points out that:

- Impact assessment is still in its infancy and studies of low income regions are virtually non-existent.
- There are few estimates of impacts of climate change on developing countries and research must focus more attention on the impacts of climate change.

Climate change is most likely to affect those regions with a larger share of economic output which relies on climate related inputs. For example, agriculture depends on rainfall or irrigation to meet crop water demands, recreational activities like skiing depend on snowfall. More industrialized countries are often better able to adapt economic activity to reduce the risk associated with uncertain climate conditions; and are even capable of exploiting harsh climatic regions by investing in capital intensive industries that minimize the harmful climate conditions and take advantage of the “hidden” benefits. The dry and warm southwest desert region of the United States is one of the fastest growing regions of the US. Would this be such a thriving region without a population that can build massive infrastructure to move natural resources and who afford such luxuries as air conditioning? Sophisticated and well developed transportation networks, multiple agro-climatic zones, robust markets, strong research, well educated laborers in all sectors, are just a few of the reasons that current research points to marginal impacts of climate change on industrialized nations<sup>1</sup>.

In industrialized countries such as the US, the agricultural industry is likely to be robust with respect to negative climate change impacts. Adams et al. (1990) notes geographic shifts in major US field crops due to temperature increases and precipitation decreases in the “farm belt” of the US which would keep climate change impacts at marginal levels. Crosson (1993) claims that the impact of climate change on the economy of four Midwestern states (with larger shares of income from agriculture) would be minor because of the ability of the region to adjust and the small portion of the economy dependent on agriculture. In most cases, countries with multiple agro-climatic zones and large economies have shown marginal economic impacts due to climate change.

Developing countries such as Egypt are possibly a different story. Many of the advantages that developed nations currently possess simply do not exist within developing countries. Already gross inequities plague the modern world, yet with all the discussion regarding sustainable, socio-economic development, there continues to be gross and widespread inequity between the socio-economic conditions of developed and developing

---

<sup>1</sup> Marginal impacts of climate change on industrialized nations assumes relatively small, gradual shifts in mean climate conditions in the long run and not catastrophic, abrupt changes in the short term

countries. It appears that the future climate that is being forecast by today's scientists would only serve to widen this gap.

These issues motivate the need to study the potential impacts of climate change on developing countries. Egypt was chosen because it has been identified as a country that could be particularly vulnerable to climate change. Broadus et al. (1986) and El-Raey (1991) suggest land losses of 12 to 15 percent of Egypt's current arable land for a one-meter sea-level rise. Gleick (1991), in an aggregated study of the Nile Basin, suggested that it is extremely sensitive to changes in temperature and precipitation.

Effectively, the only source of water for Egypt is the Nile, as this river meets nearly all the national water requirements of the country. Egypt currently make water resource allocation decisions based on an assumed annual reliable yield of 55.5 billion m<sup>3</sup>. Positive or negative shifts in this assumed stationary value of 55.5 billion m<sup>3</sup> could significantly change the economic environment of Egypt, as Egypt would be forced to adjust to changing resource availability.

With a World Bank projection of a 2.2 times increase in population by 2060, resource utilization and economic development decisions will be critical of Egypt. The role of agriculture in the development process will continue to be important, as it still maintains a large share of the overall GDP (in 1990 Agriculture GDP was approximately 18% of total, World Bank 1991) and is a major source of jobs for an economy with high unemployment rate (20% in 1991; CIA World Factbook 1994). Potential climate might have direct effects—some positive some negative; but climate change serves as an additional element of uncertainty with respect to future development decisions.

The objectives of this research were to: 1) Quantify the potential impact of climate change on water resource availability to Egypt. 2) Integrate predictions of climate change impacts on the principal biophysical sectors (water resources, agronomics, and land) and scenarios of future socio-economic conditions into an economic model. 3) Examine the role of water resources in the integrated climate change impact assessment. 4) Discuss policy implications regarding the GCM predictions of future climatic change on water resources and on the economy of Egypt as modeled by the general equilibrium model.

### ***1.1. Integrated Economic Modeling***

A number of different kinds of economic models can be used to evaluate the impacts of a potential climate change for local, regional, national, or even global economies. Generally, there are three types of economic models, according to the approach used to construct them, and three scales of economic activity (Carter et al. 1994). The first *type* is the math programming model, which contain an objective function and a constraint set. Adams et al. (1990) use a math-programming model to address the impacts of climate change on U.S. agriculture. The second class of models are econometric models. Econometric models use computer analysis and statistical techniques to describe in mathematical terms the relationship between key economic forces. The final type of economic model is the Input-Output (I-O) model. These models focus on the interdependency of different economic sectors by accounting for buying, selling, and consumption activities among the different sectors. The input-output relationships are generally static, therefore structural changes are difficult to account for. The approach is relatively simple to apply and is in common use (Taylor 1979; Williams et al. 1988; and Rosenberg 1993).

Carter et al. (1994) notes three scales of economic activity which can be represented by economic models. In increasing order of scale, they include: 1) firm level models; 2) sector-level models; and 3) economy-wide models. Firm level models represent a single enterprise such as a farm and seek to investigate decision making processes by individuals

(Hazell and Norton 1986; Williams et al. 1988; Kaiser et al. 1993). Sector level models generally model a single sector within an entire economy using aggregate values. They can be either static or dynamic, but do not capture the interactions between sectors. The advantage of sectoral models is that they allow for detailed specification of the sector of interest. Adams et al. (1990) and Strzepek et al. (1994 b) have used sectoral models to assess climate change impacts in the USA and Egypt, respectively. The third scale are economy wide or macro-economic models. Economy wide models include general equilibrium (GE) and input-output (I-O) models. General equilibrium models attempt to account for all economic activity in the region through the inclusion of income effects. Varying levels of sectoral representation are possible in a GE model. The major distinction between partial and general equilibrium is that partial equilibrium is price endogenous within a single sector only, and there are no cross effects from other sectors influencing the single sectors and no consumer income effects. General equilibrium specifies the dynamics between all sectors of the economy at varying levels of aggregation. Partial equilibrium determines a point *on* a fixed demand curve, while general equilibrium determines a point *on* and the position *of* the demand curve through the inclusion of income. Schereaga et al. (1993), Rosenzweig and Parry (1994) and Darwin et al. (1995) have all used general equilibrium models to assess the impacts of climate change on economic markets. Schereaga et al. (1994) investigated impacts on the United States, while Rosenzweig and Parry (1993) and Darwin et al. (1995) addressed global agricultural systems. The problem with many of the current climate change studies is that they do not account for many of the significant non-market effects. Rosenzweig and Parry (1994) did not include water or land changes in their assessment of global agriculture and Bowes and Crosson (1993) state that water is indirectly considered in their input-output assessment of the MINK (Missouri, Iowa, Nebraska and Kansas) region and does not include cross sectoral competition for what was assessed to be a scarce resource under climate change. A recent publication by Darwin et al. (1995) is one of the first attempts to include water within a global agriculture model. Water is included in an aggregated fashion, with the globe broken into 8 regions and 6 land classes which have varying water demands. However, all of Africa and South America are lumped into a Rest of the World category, and this level of aggregation loses important regional differences.

### ***1.2. Climate Change Impact Assessments of Agricultural Systems***

Recent research on the global impacts of climate change indicate that global food production will not be dramatically affected by climate change (Liverman 1986; Kane et al. 1992; Rosenzweig et al. 1995, Darwin et al. 1995). Although from a global perspective food production is not greatly affected in these studies, the analyses generally indicate that the developed world fairs well under climate change and the developing world is at a greater risk. Kane et al. (1992) state that the affect of climate change on domestic economies is critically dependent on their net trade position.

Even if climate change reduces overall global food production, larger exporters could still fair well. Overall production might decrease, but lower global production could increase world market prices which would actually generate an increase in producer revenue in exporting countries. Exporters generally win and importers generally lose under this simplified climate change scenario. The implication of this scenario is that there are many developing countries (such as Egypt) which depend on imports to meet growing demands, and population projections indicate that these are the fastest growing countries into the next century.

Rosenzweig and Parry (1993) conducted a study on the potential impacts of climate change on world food supply (see also Rosenzweig et al. 1995). Their study used the same

global food model used in this study (Fischer et al. 1988) to estimate the number of people at risk of hunger due to climate change. They concluded that the net effect of climate change is to reduce global cereal production by up to 5%. Strikingly, however, their analysis showed that the relative disparities between the developed and the developing will actually decline during the coming century. Figure 1 is the change in cereal production in 2060 with moderate adaptation measures taken<sup>2</sup>. Rosenzweig and Parry's 2060 baseline scenario (without climate change) predicts an average decrease in the percentage of hungry people from the 1990 estimate (Figure 2)! This kind of result is very scenario dependent and hinges on assumptions regarding economic growth of non-agricultural markets.

An interesting conclusion is drawn from Figure 1 and Figure 2, which shows the need for multiple baseline scenarios which might include both optimistic and pessimistic economic growth projections. Consider the GISS climate scenario. Globally, cereal production does not change (Figure 1), but the GISS scenario is the most dramatic with respect to production differences between developed and developing countries. The impact on the percentage at risk of hunger has practically not changed relative to the 2060 base scenario and is still lower than the 1990 scenario (Figure 2). Although net trade activity is not reported in Rosenzweig and Parry, it is a logical conclusion that the developing countries are meeting food demands through imports from the developed world.

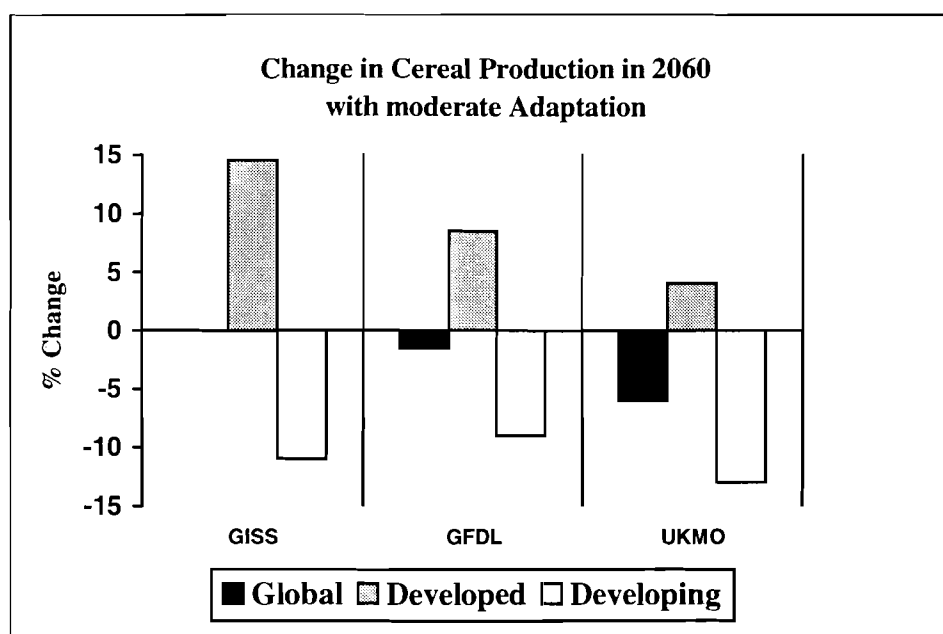

Figure 1. Percent change in cereal production for the globe, developed countries, and developing countries under climate change scenario with moderate adaptation and inclusion of direct CO<sub>2</sub> effects (from Rosenzweig, and Parry 1993).

<sup>2</sup> Adaptation measures include moderate shifts in planting dates (+/- 1 month), cultivar changes to more tolerant crops.



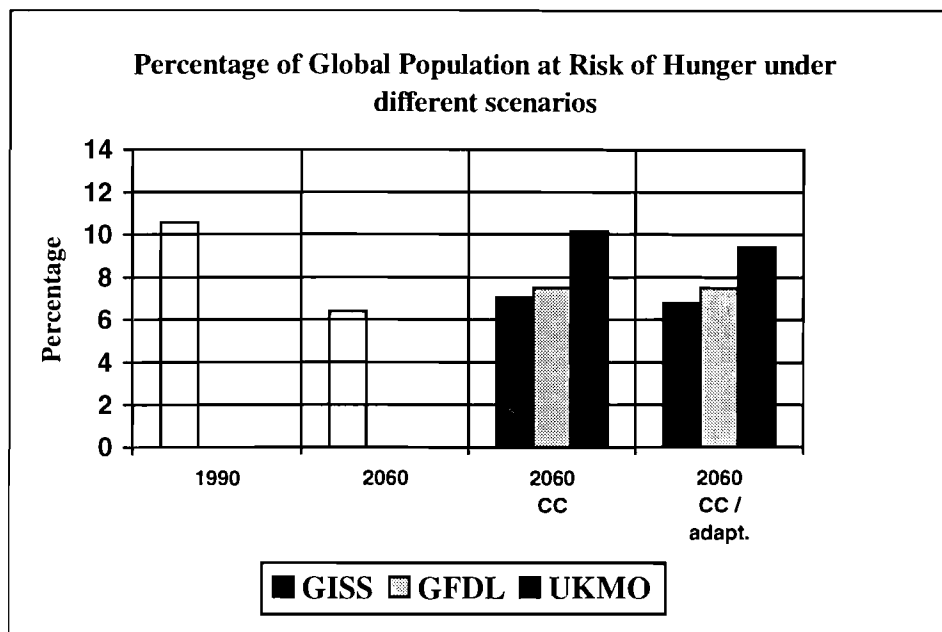

Figure 2. Percentage of global population at risk of Hunger. Data taken from Rosensweig and Parry, (1993). The 1990 and 2060 scenarios consider global populations of 5,000 and 10,000 million people respectively (Strzepek and Smith 1995). The 2060 CC scenario is without farmer adaptation to climate change and the 2060 CC /adapt. is with moderate adaptations. The GCMs used in the Rosensweig and Parry work: **GISS** - Goddard Institute for Space Studies; **GFDL**- Geophysical Fluid Dynamics Laboratory; and **UKMO**- United Kingdom Meteorological Office.

Liverman (1986) used a 10 region global model which included 4 economic sectors (agriculture, energy, manufacturing and service) to investigate the response of these markets to climate change. Agriculture was broken into two commodities: crops and meat. Liverman implies that the aggregation is perhaps too coarse because the model is over sensitive to yield changes. For instance a 20 percent increase in yields reduces global starvation by half. Also, the 10th region of the model (the 'all encompassing rest of the world') is simply not adequate for proper model response. Kane et al. (1992) use a static world policy simulation model which was highly disaggregated at the commodity level (20 agricultural commodities) and included 13 geographic regions (4 of the 13 were developing countries, including China). Their analysis did not include farm response to changing conditions, nor did it include changes in technology, population or other economic sectors. At this level of aggregation, impacts on GDP due to climate change on "the rest of the world" (primarily developing) were less than 1%. They point to the importance of global analysis of agricultural systems to capture regional differences and the role of price changes in forcing structural adjustments.

Parry et al. (1988a. and 1988b.) performed regional assessments of climatic variations on agriculture. These studies looked at short-term climate effects and their impact on regional agricultural production and distribution. Interestingly, much of the work focused on the role of drought (primarily the lack of precipitation) on agriculture. There was little discussion on evapotranspiration changes and its impact on agricultural production problems. The analysis did not concern itself with future climate change scenarios, but focused on recently observed climate variations, how agriculture responded and what future measures

can be taken to mitigate harmful climate variations. These examples from literature are not meant to be an exhaustive overview of all research on integrated assessments, but is a highlight of the major studies undertaken thus far.

### 1.3. Water Resources and Climate Change

Figure 3 is a general account of the global freshwater situation and shows that stable river runoff (the portion of freshwater that can be made available for use) is approximately 25% of the water discharged by the rivers of the world. A large portion of this stable runoff is made available for the irrigation of agricultural commodities. Some estimates put agriculture's share of consumed global water at close to 75% (Postel 1992), and with growing food demands it is unlikely this number will decrease any time soon. Kulshreshtha (1993) estimated that nearly two-thirds of the global population could become more vulnerable to the availability and use of water under current population and climate change scenarios. Figure 3 does not reveal more complex problems like spatial and temporal variability which makes the problem more difficult.

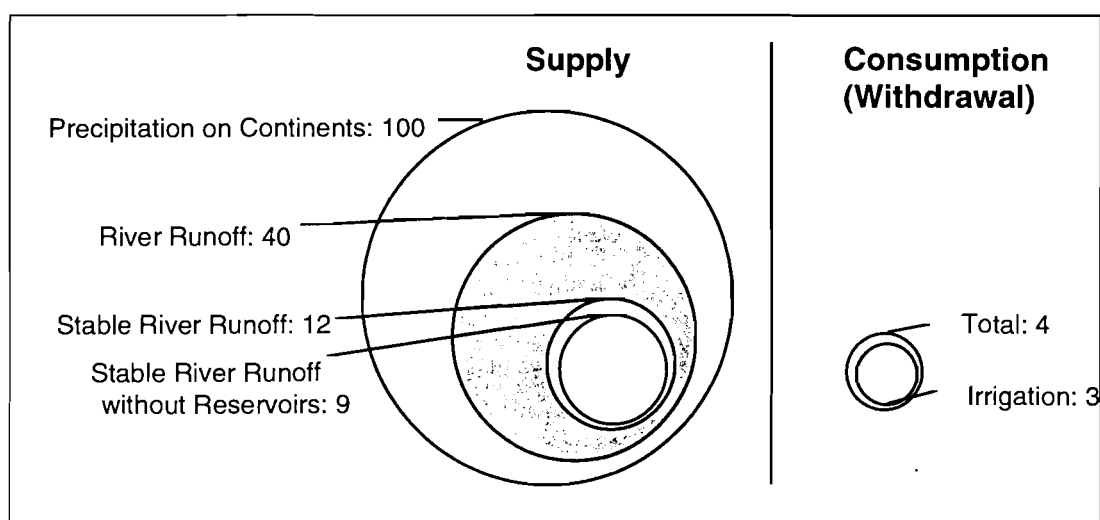

Figure 3. Global freshwater balance (data from Golubev 1993). Units are 1000 km<sup>3</sup> per year

Figure 4 is an estimate of the total global population which currently experiences different levels of vulnerability with respect to freshwater (Strzepek et al. 1994 a). The four vulnerability classes (scarce, stressed, marginal, surplus) used to arrive at these results are based on a combination of per-capita availability and relative use. For example, a scarce vulnerability ranking is characterized by low availability (less than 1000 m<sup>3</sup> per capita per year) and high use (greater than 60% of availability). The portion of the global population currently experiencing a water scarce or stressed situation is relatively small (approximately 6% of the total), with most occurring within the region of the Middle East. It should be mentioned that this analysis only includes water quantity based on national, aggregate values and it is likely that including quality information or disaggregating spatially and temporally could drastically change the vulnerability outlook.

Figure 4 also includes a 2025 forecast of global freshwater vulnerability. In this scenario a mean value population projections for 2025 was used. This scenario implies uniform demand increases as related to population growth, while availability remained unchanged between the 1990 scenario and the 2025 scenario. The issue of climate change introduces additional uncertainties into the issue of vulnerability (bearing in mind significant

uncertainties and poor understanding of climate change impacts on both water quantity and quality). Strzepek et al. created a climate change scenario using results of climate change impacts on water resources availability taken from Miller and Russell (1992). Miller and Russell (1992) compiled runoff results from the GISS Global Circulation Models (GCM) for 33 of the larger river basins of the world. Strzepek et al. (1994) used these basin runoff results from Miller and Russell, combined with an interpolation technique for areas that were not within one of the 33 basins, to derive more detailed climate change impacts at the national level. The same 2025 demand scenario was used for the 2025 climate change scenario, using the “average” population forecast. Their 2025 results (without climate change) show a wider distribution of the population over the four vulnerability classes as compared to the 1990 estimate. For the 2025 climate change scenario, a large increase in inequity with respect to water vulnerability was shown. Alarmingly, major portions of the global population shift from the central categories (marginal and stressed) to the scarce and surplus classes. It should be pointed out that the method and criteria chosen for vulnerability assessment can have a significant impact on the outcome of the results as pointed out in their study.

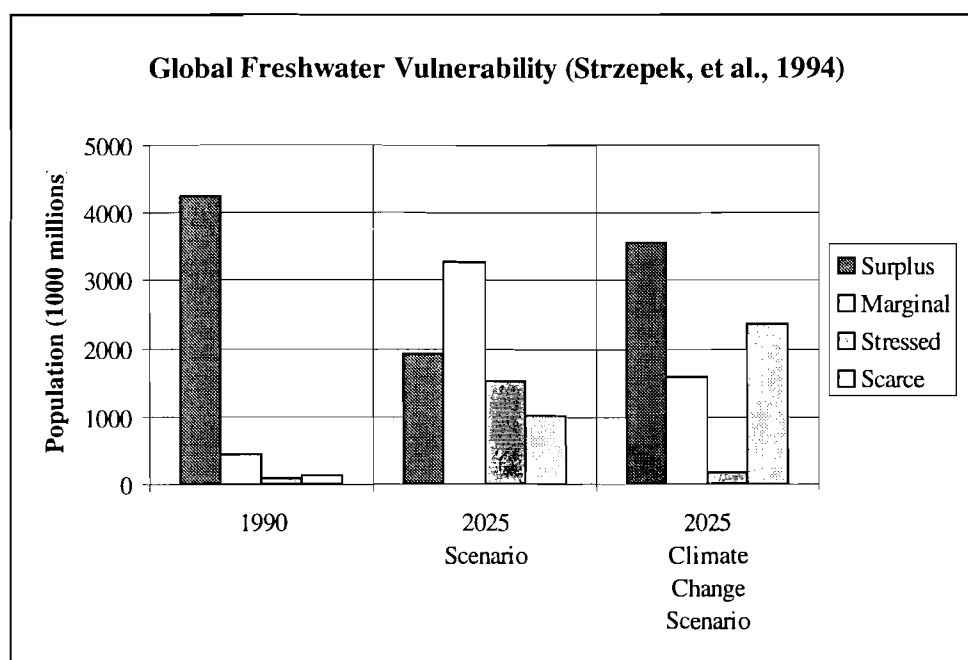

Figure 4. Vulnerability of the global population to water supply deficits using a use/availability approach (Strzepek et al. 1994).

## 2. Objective and Methodologies

### 2.1. *An Integrated Assessment Tool: The Basic Linked System*

To perform an integrated<sup>3</sup> assessment of climate change impacts, a recursively dynamic computable general equilibrium (CGE) model of world food trade was used. Agriculture is broken into nine different sectors including, wheat, rice, coarse grains, bovine and ovine meat, dairy products, other animal products, protein feed, other food, and non-food agriculture. Onyeji and Fisher (1994) performed a climate change impact assessment on Egypt using the same computable general equilibrium model used in this study. The conclusion drawn by their study is that both the agriculture and non-agricultural sectors will be less self-sufficient into the 21st century. However, their work was forced to overlook the issue of water resources due to model limitations at the time of their study. The current study is an attempt to bring a larger portion of the resource base into the assessment picture by investigating the impacts of climate change on crop yields, land and water resources. These resources are then combined into an assessment of potential climate change impacts on Egypt. Figure 5 is a diagram of the integrated approach that is to be used for this study. The physiological sectoral impacts (water, agronomics, and sea level rise) and the methodologies used to implement them within the economic model are described below.

The Basic Linked System (BLS) is an Applied General Equilibrium (AGE) model of world food production and trade (Fischer et al. 1988). Currently, the BLS consists of several national models linked together through an international market which globally balances commodities and adjusts international prices to generate a balanced state. There are 16 linked national models which generally maintain a typical structure and 4 unique national models (U.S.A, India, China, and the former planned economies of the Eastern Block) which together comprise almost 80% of the agricultural activity of the globe (i.e., production, demand and land usage). There are 14 regional group models which comprise the remaining 20% and are generally grouped according to socio-economic conditions (i.e. African oil exporters, African low-income calorie importers, Asia low income, etc.). The 16 typical, linked national models are referred to as Standard National Models (SNMs), with Egypt being one of the sixteen SNM countries.

---

<sup>3</sup> Integrated in this context does not include the integration of causes, impacts, and feedback's of the 'greenhouse problem'. Models of this nature are global in scope and include economic, climate, and damage assessment models (Vloedbeld and Leemans, 1993)

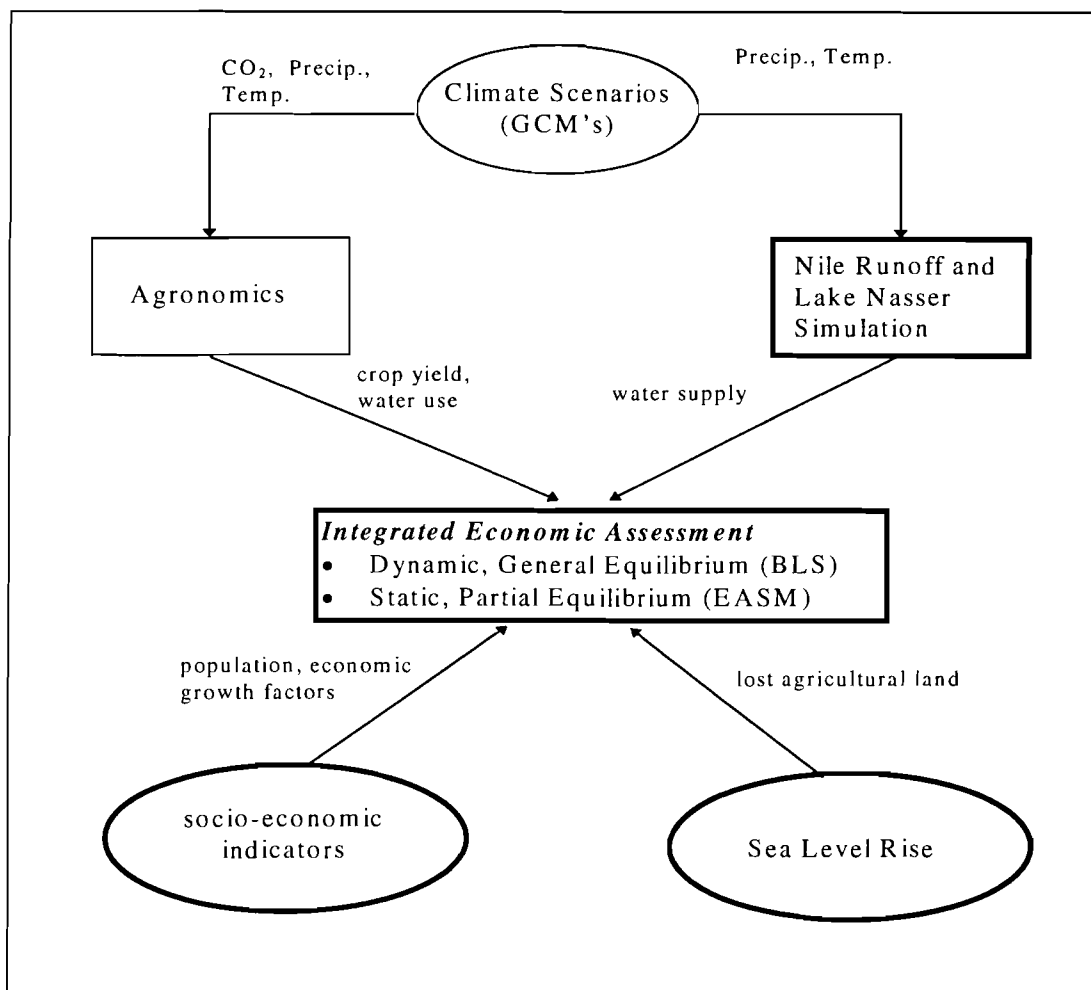

Figure 5 Integrated approach to impact assessment. The boxes in bold highlight the additional contribution made in this study to assess climate change impacts on Egypt.

The BLS is recursively dynamic (Figure 6). A set of initial conditions are specified for all countries, as are global trade conditions for the first year (including such things as domestic prices, production and consumption and international prices). An international exchange algorithm iterates over world market prices (maximizing net utility) by performing a commodity balance and determining final consumer demand (using a linear expenditure system), income formation at the given supply, market clearing conditions, net exports, etc. Once equilibrium prices are reached, the model advances to the next time step. A calibration period can be specified based on observed international prices for up to 30 years (currently, 10 years of world market prices are available from 1970 and 1980 within the BLS dataset). For each country and in each time period, factor accumulation and allocation (for capital, land, and labor) are determined for each sector (10 agriculture and 1 non-agriculture).

Non-agriculture supply is determined through a Cobb-Douglas production function dependent upon labor and capital, while supply within the 10 agricultural sectors is found through revenue-maximization and feed-mix cost minimization given availability of factor inputs (fertilizer, land, labor and water) at current domestic prices. Processing of agricultural products and the purchase of intermediate inputs as well as the non-agricultural sector are also part of agricultural production. With prices and incomes set at current year values, consumer demand is determined and used in the international exchange for the next year.

Feed mix is estimated, but can adjust in the international exchange to allow for changes in imports or exports to meet target demands.

The BLS is a world trade model, but this work focuses on a single country. Fortunately, the SNM is able to run in “stand alone mode”, where world market prices are taken as exogenous. An ambitious project and an area of future research is the incorporation of water into all the country specific models, the SNM’s and the regional sub models (the complete BLS) for a thorough analysis of water’s role in global agricultural production and trade.

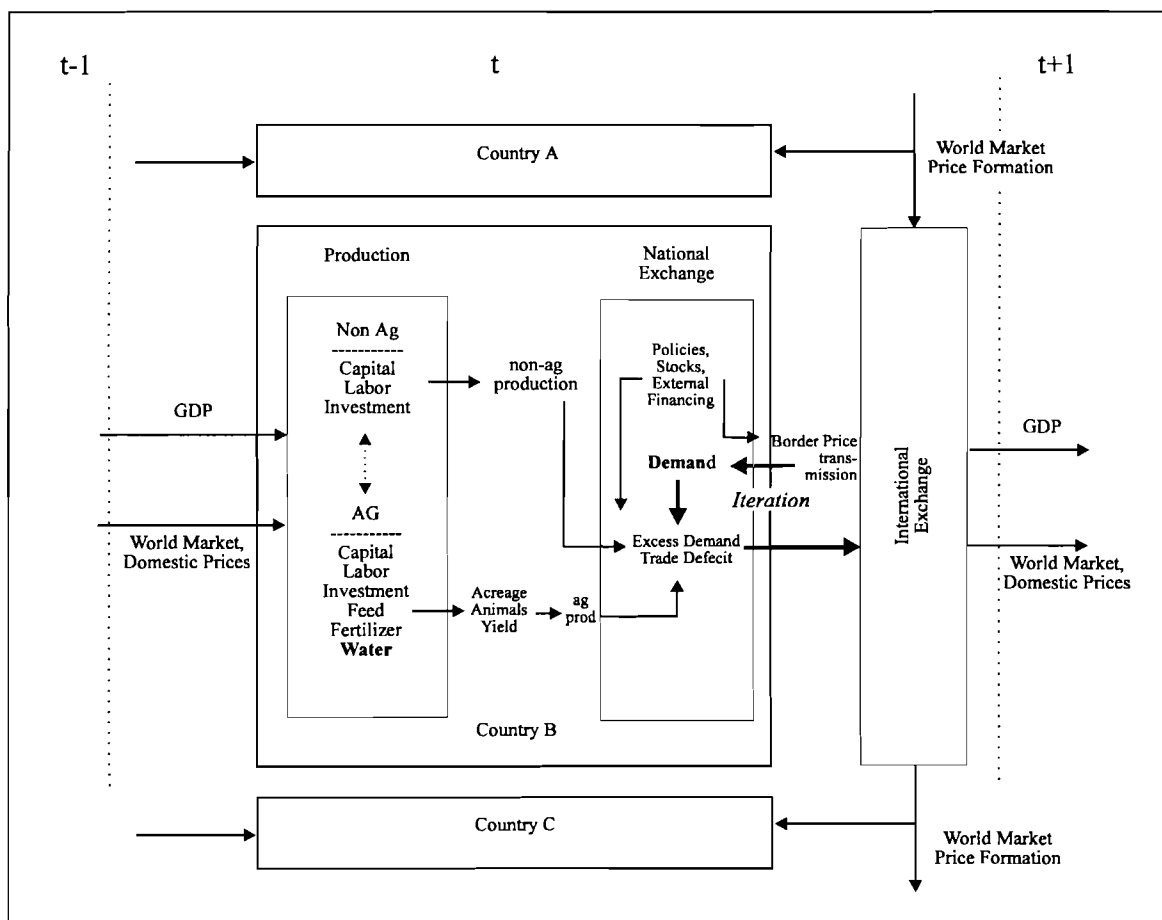

Figure 6. A schematic of the Basic Linked System (adapted from Fisher et al. 1988).

## 2.2. *The Addition of Water within the SNM*

Water availability constraints have been entered into the model based on annual aggregate values. Ideally, the SNM of a country should be disaggregated into agro-climatic zones to capture the varying levels of climate uncertainty within each region. In the case of the SNM, modeling is always done on a country wide level (i.e. no spatial disaggregation by socio-economic or agro-climatic zones), which for this study on Egypt might be an adequate assumption. An auto regressive (AR1) model was used to model the annual availability of water to the country as a whole with an attempt to include a storage term to account for infrastructure development (Salas 1993). Although it is recognized that interannual availability plays a significant role in defining water security, it is assumed that the concept of annual availability can act as a surrogate for seasonal variability. This becomes important for countries that have limited storage and high annual variability.

For countries with unreliable water supplies, irrigation is often used in an attempt to reduce the variability associated with water delivery. For Egypt, this is clearly visible in the existence of its massive irrigation network and the famous High Aswan Dam. Active dam storage<sup>4</sup> allows for over year storage of almost 1.5 times the annual flow of the Nile (approximately 85 milliards<sup>5</sup> of storage). This storage greatly reduces the risk of periodic drought within Egypt. An annual water balance is used within the SNM that allows for over-year storage. A stock term is also incorporated to reflect conservation surplus as storage reaches zero. If there is no storage, then water availability is equal to the natural water available. The simple AR(1) model is given as:

$$W_t = \bar{W} + \phi(W_{t-1} - \bar{W}) + \varepsilon_t \quad \text{Equ. 2.2.1}$$

where,

$W_t$  = modeled annual mean flow, at time t

$\bar{W}$  = annual mean flow from historic time series

$\phi$  = lag -1 autocorrelation coefficient

$\varepsilon_t$  = uncorrelated, random normal variable

In the case of irrigated agriculture, an efficiency term is used to develop irrigation investment scenarios. Water as a constraint to agricultural production is given as a resource constraint to limiting horizontal expansion and as an independent variable in commodity output. Because the BLS works on an annual time step, cropping decision (1st stage decisions) and factor input decisions (2nd stage decisions) occur simultaneously (Rosa and Yates 1994). The approach to water as a resource constraint and within the production function are described below.

### 2.2.1. **Water as a Resource Constraint**

Water is added as an additional resource constraint in the optimal allocation sub-model (also referred to as the supply module). Production is determined by net revenue maximization based on acreage, labor, capital and **water** resource constraints. Resources are allocated based on net revenue maximization. This set of equations is given below.

---

<sup>4</sup> Active Storage is that which is annually available from the reservoir to meet target demands. Dead storage is defined as water stored in the dam below a removable or usable level.

<sup>5</sup> milliard =  $10^9$  m<sup>3</sup>

$$\max_{K,L \geq 0} = \sum_{h \in C_1} r_h A_h + \sum_{h \in C_2} r_h N_h \quad \text{Equ. 2.2.2}$$

subject to,

$$A_h = f(K, L, W)_h \quad h \in C_1 \quad (\text{crops})$$

$$N_h = f(K, L, W')_h \quad h \in C_2 \quad (\text{animals})$$

$$\sum_{h \in C_1, C_2} W_h \leq W \quad (\text{water})$$

$$\sum_{h \in C_1} A_h + \sum_{h \in C_2} N_h \leq A \quad (\text{Acreage})$$

$$\sum_{h \in C_1, C_2} K_h \leq K \quad (\text{Capital})$$

$$\sum_{h \in C_1, C_2} L_h \leq L \quad (\text{Labor})$$

where,

$r_h$  = net revenue per unit agriculture, h

$A_h$  = Acreage ( $C_1$ )

$N_h$  = Animals ( $C_2$ )

$K_h$  = Capital

$L_h$  = Labor

$W_h$  = water

$W'_h$  = water for fodder

$W, A, K, L$  = Total Water, Acreage, Capital and Labor Available

$f()$  = cobb douglas production functions

### 2.2.2. Water within the Production Function

In the SNM formulation of agricultural production within the BLS, three sub-problems are recursively computed to find: 1) fertilizer and **water** application and resulting yield for crop production; 2) feed mix in livestock production; and 3) feed mix and resulting yield in livestock production. In order to include water as a limiting resource to crop production, a water variable was introduced into the first sub-component- the fertilizer and yield maximization sub-problem, which is optimized using first-order conditions. Water is given as a fixed demand based on herd size and fodder area planted (also dependent on herd size). Fodder yield is fixed and was not allowed to vary according to water inputs. Factor inputs are allocated using a utility maximizing function. These include (land, fertilizer, labor, and **water**) for the production of the six agricultural commodities (wheat, rice, coarse grains, protein feeds, other foods, non-food agriculture). Livestock remains fairly independent of water availability. Fodder requirements are likely to change with structural adjustments in the livestock sector, as livestock activity shifts to a more capital intensive, specialized form as is observed in developed countries. However, this structural transformation is weakly implied in the BLS because capital and labor move out of crop activities and into livestock production as water becomes a constraint to the production of food crops.



$$r_h \left( \begin{matrix} \sim \\ p^e \end{matrix} \right) = \max_{f_h, w_h \geq 0} \begin{matrix} \sim \\ p_h^e \end{matrix} y_h(f_h, w_h) - \begin{matrix} \sim \\ p_f^e \end{matrix} f_h \quad h \in C_1 \quad \text{Equ. 2.2.3}$$

where,

$r_h$  = revenue of crop activity, h

$\sim$

$p_h^e$  = expected gross revenue of crop, h

$C_1$  = crop activities

$y_h(f_h, w_h) = \alpha_m (1 - \exp(-a_f f_h))(1 - \exp(-a_w w_h))$

$\alpha_m$  = maximum attainable yield (parameter)

$a_f$  = fertilizer coefficient (parameter)

$a_w$  = water coefficient (parameter)

$f_h$  = fertilizer applied (endogenous)

$w_h$  = water applied (endogenous)

Additionally, crop water demand changes under various climate change scenarios have been used, with results taken from the work by Strzepek et al. (1994). For climate change scenarios, linear crop water demand changes were applied over the simulation period.

### 2.2.3. Other Water Demands

Municipal and industrial water demand is given as a function of human population, income, and non-agricultural GDP. It is assumed that as non-agricultural GDP grows, it will become a more efficient user of water, but larger increases in overall demand will be greater than increases in efficiency.

$$M_w = w_p \ln(\text{gdpcap}) + (\text{gdpn}70^{0.75}) \text{pop} \quad \text{Equ. 2.2.4}$$

$M_w$  = domestic, municipal and industrial water use

$\text{gdpcap}$  = per capita gdp (1970 Egyptian Pounds, L.E.)

$\text{gdpn}$  = non agricultural GDP (1970 Egyptian Pounds, L.E.)

$w_p$  = water use per capita

$\text{pop}$  = population (1000's)

## 2.3. Water Resource Modeling of the Nile Basin

### 2.3.1. A Water Balance Approach

A number of modeling approaches have been developed and previous models modified for studying the impact of a potentially altered climate on river basin runoff (Nemec and Shaake 1982; Gleick 1987; Lettenmaier and Gan 1990; Kaczmark 1990; Mimikou and Kouvopoulos 1991; McCabe and Wolock 1992; Nash and Gleick 1993; Reibsame et al. 1996). Generally there is no accepted method or approach for proper assessment and often simply using different models, assumptions, and methods can lead to different conclusions regarding the impact of climate change on water resources. Proper evaluation of soil moisture changes and potential evapotranspiration are important, as evapotranspiration can be

considered a key "link" between the atmosphere and the soil matrix within the hydrologic cycle. The importance of this link has been observed by Dooge (1992) who states that any estimate of climate change impacts on water resources depends on the ability to relate changes in actual evapotranspiration to predicted changes in precipitation and potential evapotranspiration ( $E_p$ ). To predict proper changes in evapotranspiration it is obviously important to begin with good estimates of the mechanisms of that change which are the water balance and potential evapotranspiration.

The model described here (WatBal) is an attempt to use simple yet widely accepted assumptions regarding the water balance within the soil moisture zone and sound physical approaches to estimating potential evapotranspiration (Eagleson 1978 and Kaczmark 1990). This model could be viewed as simply another, slightly modified approach in a long line of hydrologic models. However Kundzewicz and Somlyódy (1993) have observed a recent trend toward simpler, classical modeling approaches especially with the new challenges which climate change brings. More sophisticated rainfall-runoff models have been developed over the past thirty years, but these are usually aimed at short-term flood forecasting on time scales of days or even hours. These distributed models have been used for analyzing climate impacts (Lettenmaier and Gan 1990; Nash and Gleick 1993), yet Franchini and Pacciani (1991) comment on event scale models such as the STANFORD IV and SACRAMENTO models. They state that the interaction of the various phases of rainfall-runoff transformation within the soil is not advantageous for computational purposes, resulting in over-parameterization which leads to difficulty in the calibration procedure. Beven (1989) states that three to five parameters should be sufficient to reproduce most of the information in a hydrological record.

There are essentially two main modeling components within the WatBal model. The first is the water balance component that uses continuous functions to describe water movement into an out of a conceptualized basin. The second component is the calculation of potential evapotranspiration using the well known Priestly-Taylor approach. These two components are described below.

### Soil Moisture

The common link in most water balance approaches is the computation of a mass balance within the soil moisture zone. There are many ways of representing the infiltration, discharge and storage behavior of the soil moisture zone (Eagelson 1978; Shaw 1982; Chow et al. 1988). The uniqueness of this lumped conceptual model to represent water balance is the use of continuous functions of relative storage to represent surface outflow, sub-surface outflow, and evapotranspiration (Kaczmarek and Krasuski 1991 and Yates 1994). In this approach the mass balance is written as a differential equation and storage is lumped as a single, conceptualized "bucket" (Figure 7) with the components of discharge and infiltration being dependent upon the state variable, relative storage (1). The water balance component of the model contains five parameters related to: 1) direct runoff; 2) surface runoff; 3) subsurface runoff; 4) maximum catchment water-holding capacity; and 5) base flow (Figure 1).

Direct runoff ( $R_d$ ) is given as:

$$R_d = \beta P_{eff} \quad \text{Equ. 2.3.1}$$

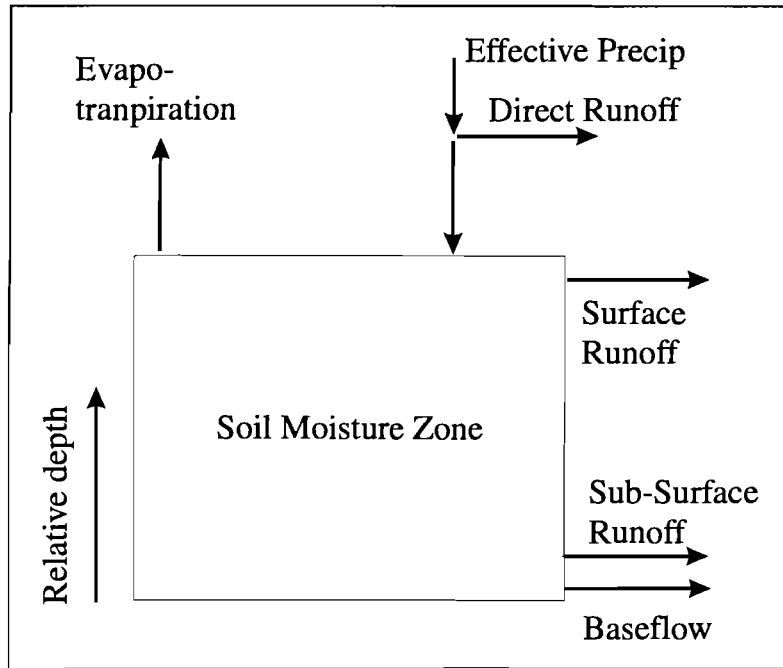

Figure 7. Conceptualization of the water balance for the WatBal model

The soil moisture balance is written as:

$$S_{\max} \frac{dz}{dt} = (P_{\text{eff}}(t)(1 - \beta)) - R_s(z, t) - R_{ss}(z, t) - Ev(PET, z, t) - R_b \quad \text{Equ. 2.3.2}$$

$P_{\text{eff}}$  = Effective Precipitation (length / time)

$R_s$  = Surface runoff (length / time)

$R_{ss}$  = Sub - Surface runoff (length / time)

$Ev$  = Evaporation (length / time)

$R_b$  = baseflow (length / time)

$S_{\max}$  = Maximum storage capacity (length)

$z$  = relative storage ( $0 \leq z \leq 1$ )

The Continuous functional forms that are used in equation 2 are:

1. Evapotranspiration -  $E_v$ :

Evapotranspiration is a function of Potential Evapotranspiration (PET) and the relative catchment storage state. A non-linear relationship has been used to describe evapotranspiration.

$$Ev(z, PET, t) = PET(t) \left( \frac{5z - 2z^2}{3} \right) \quad \text{Equ. 2.3.3}$$

2. Surface Runoff -  $R_s$ :

Surface runoff is described in terms of the storage state,  $z$ , the effective precipitation,  $P_{\text{eff}}$ , and the baseflow. If the precipitation exceeds the predefined baseflow, then surface runoff is zero.

$$R_s(z, P, t) = \begin{cases} z^\beta (P_{eff} - R_b) & \text{for } P_{eff} > R_b \\ 0 & \text{for } P_{eff} \leq R_b \end{cases} \quad \text{Equ. 2.3.4}$$

Equ. 2.3.4 allows the surface runoff term to approach zero as the relative storage becomes very small. If there is a large contribution from direct runoff, then this can be described with the parameter  $\beta$  (1).

### 3. Sub-Surface Runoff - $R_{ss}$ :

Sub-surface discharge is a function of the relative storage state times a coefficient,  $\alpha$ ). In most cases, the value of  $\gamma$  is 2.0, however it has been observed that for some basins, the value is smaller than 2.0 (Yates 1994). As  $\gamma$  approaches 1.0 the sub-surface discharge responds more linearly with relative storage, indicating a decrease in the holding or retention capacity of the soil.

$$R_{ss} = \alpha z^\gamma \quad \text{Equ. 2.3.5}$$

The 4th model parameter is the maximum catchment holding capacity,  $S_{max}$ . The storage variable,  $Z$ , is given as the relative storage state:  $0 \leq Z \leq 1$ . Referring to figure 9,  $S_{max}$  is defined as the maximum storage volume. Total runoff, for each time step, is the sum of the four components:

$$R_t = R_s + R_{ss} + R_b + R_d \quad \text{Equ. 2.3.6}$$

The differential equation (2.3.2) is solved using a predictor-corrector method (Carnale and Chapra 1988) and the model is calibrated using a unconstrained heuristic algorithm (minimizing the root mean square error between the observed and predicted monthly runoff value; Yates 1994). The direct runoff coefficient,  $\beta$ , and the power term on sub-surface runoff,  $\gamma$ , are not part of the optimization routine. The model has been developed within the Visual Basic programming language of Excel5.0.

### Potential Evapotranspiration

Penman (in Thom and Oliver 1977) was one of the first to describe evaporation in terms of the two main micrometeorological components: energy for the conversion of water to a vapor phase and aerodynamic processes for the removal of saturated air away from the surface. The Penman equation is the most widely known combined method of estimating evaporation.

$$E = \frac{\Delta}{\Delta + \gamma} E_r + \frac{\gamma}{\Delta + \gamma} E_a \quad \text{Equ. 2.3.7}$$

where:

$E$  = Combined evaporation estimate [mm/day]

$E_a$  = Evaporation estimate which assumes an unlimited availability of energy.

$E_r$  = Evaporation estimate which assumes the ability of the system to remove moist air is not limiting.

$\Delta$  = slope of the saturated vapor pressure curve

$\gamma$  = psychrometric constant =  $C_p p K_h / (0.622 + K_w)$

where,  $C_p$  = specific heat at constant temperature

$K_h, K_w$  = diffusivity [ $L^2/t$ ]

Priestley and Taylor (1972) found that for very large areas the second term of the Penman equation is approximately thirty percent that of the first. Thus an approximation to the Penman equation which gives an estimate of reference crop evapotranspiration may be written as:

$$E_{rc} = \alpha \frac{\Delta}{\Delta + \gamma} (R_n - G) \quad \text{Equ. 2.3.8}$$

where  $\alpha$  has been given the value of 1.26 in humid climates (relative humidity greater than 60 percent in the month with the maximum evaporation) and 1.74 for arid climates (relative humidity less than 60 percent in the month with the maximum evaporation).  $G$  is the soil heat flux which for regional estimates can be assumed to be zero.  $R_n$  is the net radiation in ( $\text{MJ m}^{-2}\text{day}^{-1}$ ). This is a reference crop evapotranspiration estimate (referred here as potential evapotranspiration), which should show lower values than similar estimates which give free surface or potential evapotranspiration.

### 2.3.2. A Monthly Hydrologic Model of the Nile Basin

The Nile River Basin covers roughly 2.9 million  $\text{km}^2$ , or almost one-tenth the area of Africa and traverses some 6,500 kilometers from south to north as it winds its way across the boundaries of nine different countries. The Nile is unique among the world's larger river basins, having perhaps the lowest specific discharge of any of the major river basins of the world with over 1 million  $\text{km}^2$ . One of the primary reasons for this unique characteristic is the fact that the basin passes through a number of different hydro-climatic zones and unique geological regions. The portion of the basin that contributes to streamflow is only 1.6 million  $\text{km}^2$ , ending below the confluence of the Atbara River and the Nile in northern Sudan.

Generally, five different climate zones have been identified along the Nile basin. These include the Mediterranean zone near the coast of Egypt, where precipitation is between 25 to 150 mm/year. Moving southward, the climate changes to a rather harsh desert environment with little rainfall. This region extends from just north of Cairo, Egypt to around the mouth of the Atbara basin in north-central area of Sudan. To the south of the Atbara, a tropical environment dominates and is comprised of three general domains. The first is the Sudan plains, where precipitation is between 500 and 1000 mm/year and potential evapotranspiration is around 1,800 mm/year, making for little contribution to total Nile flow. Next are the tropical highlands of Ethiopia and Sudan, where annual precipitation can range between 700 to 1600 mm primarily occurring over a short, three month period. This region contributes the major portion of runoff from the Nile through the tributaries of the Blue Nile. In one region along the north-east border of the Sobat basin, precipitation can exceed 2000 mm/year which is the wettest portion of the Nile Basin. Potential evapotranspiration in this region is around 1400 mm/year. The final climate zone is the lake plateau region of central Africa, containing Burundi, Kenya, Rwanda, Tanzania and Uganda. Here precipitation is around 1250 mm/year distributed in a uniform fashion throughout the year. As has been noted by Hurst (1952), Kite (1981), and Piper et al. (1986), the lake region is very sensitive to the balance of precipitation and evaporation. Between 1961 and 1964 a sharp rise in lakes levels occurred, mainly attributed to increases in rainfall on the lake and the surrounding region.

Figure 8 is of the entire Nile basins and shows the average, annual distribution of rainfall over the basin Figure 9 and is the mean daily potential evapotranspiration demand over the basin using a Penman method.

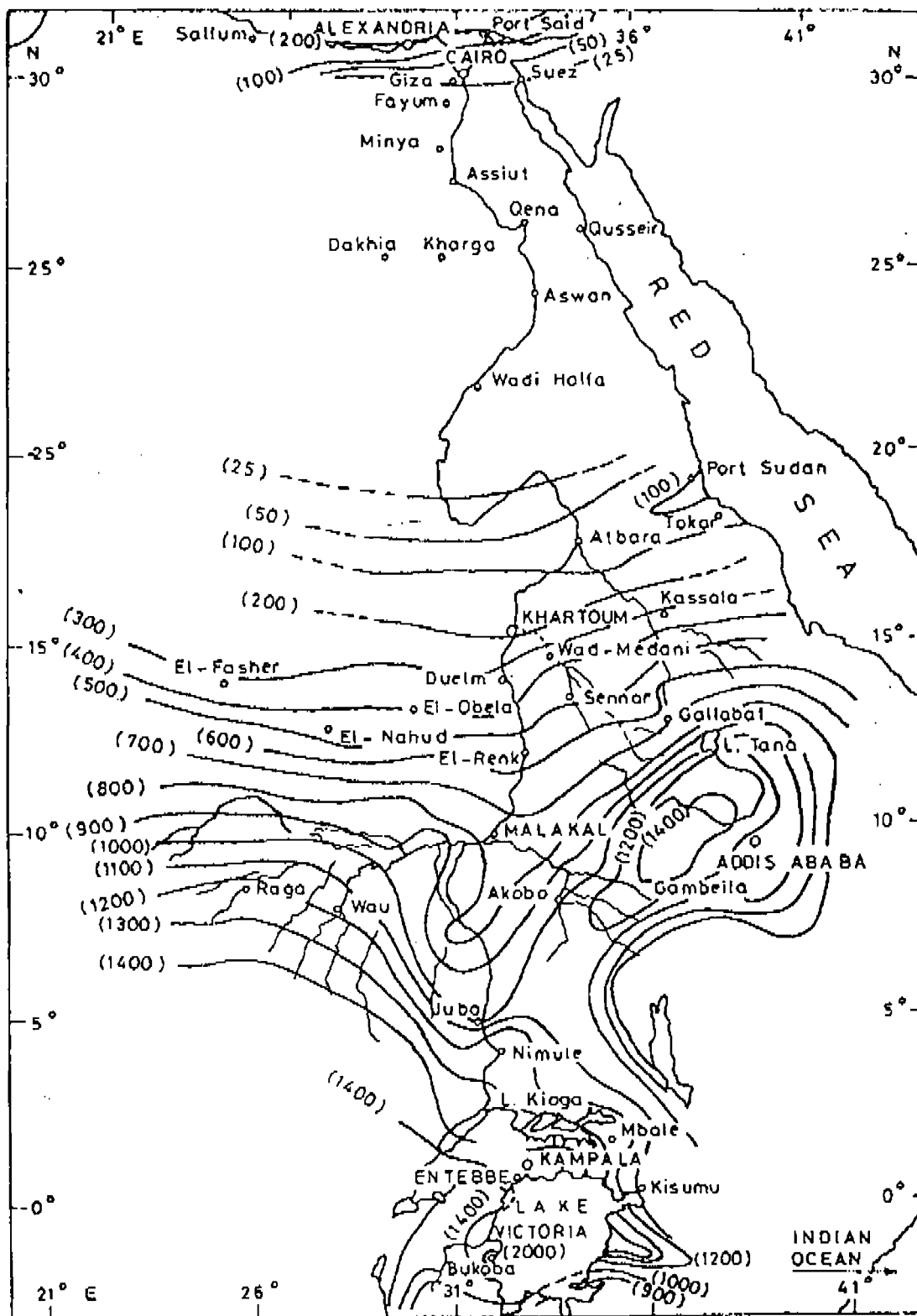

Figure 8. Annual Precipitation over the Nile Basin in mm/year (from Shahin 1985)

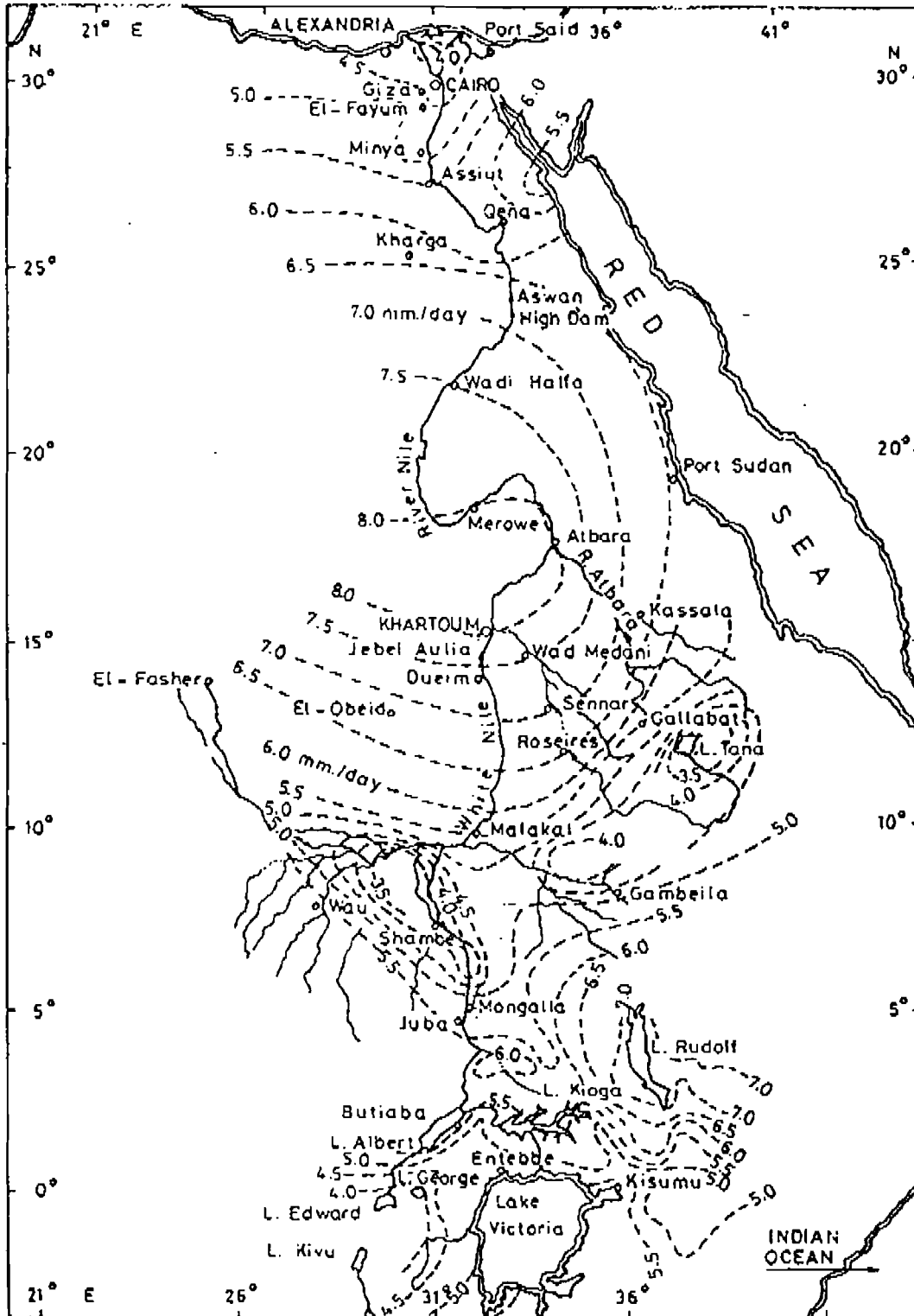

Figure 9 Mean annual potential evapotranspiration over the Nile Basin in mm/day (from Shahin 1985).

## **Basin Delineation**

In this modeling work, the Nile basin has been sub-divided into 12 sub-basins, including the Kagera, Lake Victoria, Upper Kyoga, Albert-Edward-Semiliki, Lower Kyoga, Bahr El Jebel, Bahr El Gazal, Sobat, Lake Tana, Upper Blue, Dinder-Rahad, and Atbara basins (Figure 10). A number of regression relationships were used to determine flows where contribution due to precipitation is negligible and net loss occurs between monitoring stations. These included the stretch of the Blue Nile from Roseries to Senar (Lower Blue) and along the mainstem of the Nile; from Malakal to Khartoum, Khartoum to Atbara, Atbara to Dongalla, and Dongalla to Lake Nasser.

## **Lake Region**

### Lakes Victoria and Kyoga

The headwaters of the Nile Basin begin just south of the equator where a series of lakes are connected to one another and serve as steady contributor to Nile flow throughout the year. The first and perhaps most important lake is Victoria, the 2nd largest freshwater lake on Earth. Approximately 50% of the runoff into lake Victoria is from the Kagera basin. The other 50% comes from catchments draining to the. Because of the availability of discharge data from the Kagera basin, this basin along with lumped input from the surrounding region were taken as the inflow to lake Victoria.

Lake Victoria discharges its water into the upper Kyoga basin. The inputs to Lake Kyoga include the discharge from Lake Victoria and contribution from the surrounding catchment. Lake Kyoga discharges water downstream to Lake Albert although adds little if any additional flow. Lake Albert receives water from Lake Kyoga as well as its upstream basins (Semiliki Basin and the Lake Edward sub-basins).

Lake Kyoga receives water from the outflow of Lake Victoria and the approximate 75,000 km<sup>2</sup> of surrounding basin area. The lake is 6,300 km<sup>2</sup> and forms a number of swampy regions around its many fingers which makes for a net loss of water from this region. Below Kyoga, the river enters a series of rapids before entering Lake Albert through a swampy delta-a distance of 75 km and a drop of more than 400 meters.

Over lake Victoria precipitation estimates are very uncertain, as shore precipitation stations are the primary source for estimating lake precipitation. If climate change should significantly impact over-lake precipitation, Lake Victoria could experience drastic changes. For example, between 1959-1964, the level of Lake Victoria rose almost 2.5 m. Nemec and Shaake (1982) estimated that an increase in precipitation by 25% and a decrease in potential evapotranspiration of 6% could raise lake levels by as much as 3 meters. A 3 meter rise in Lake Victoria, assuming an initial lake level of 1134 meters could cause an increase of more than 3 times the mean flow!



Schematic of Nile Basin - Modeled Components

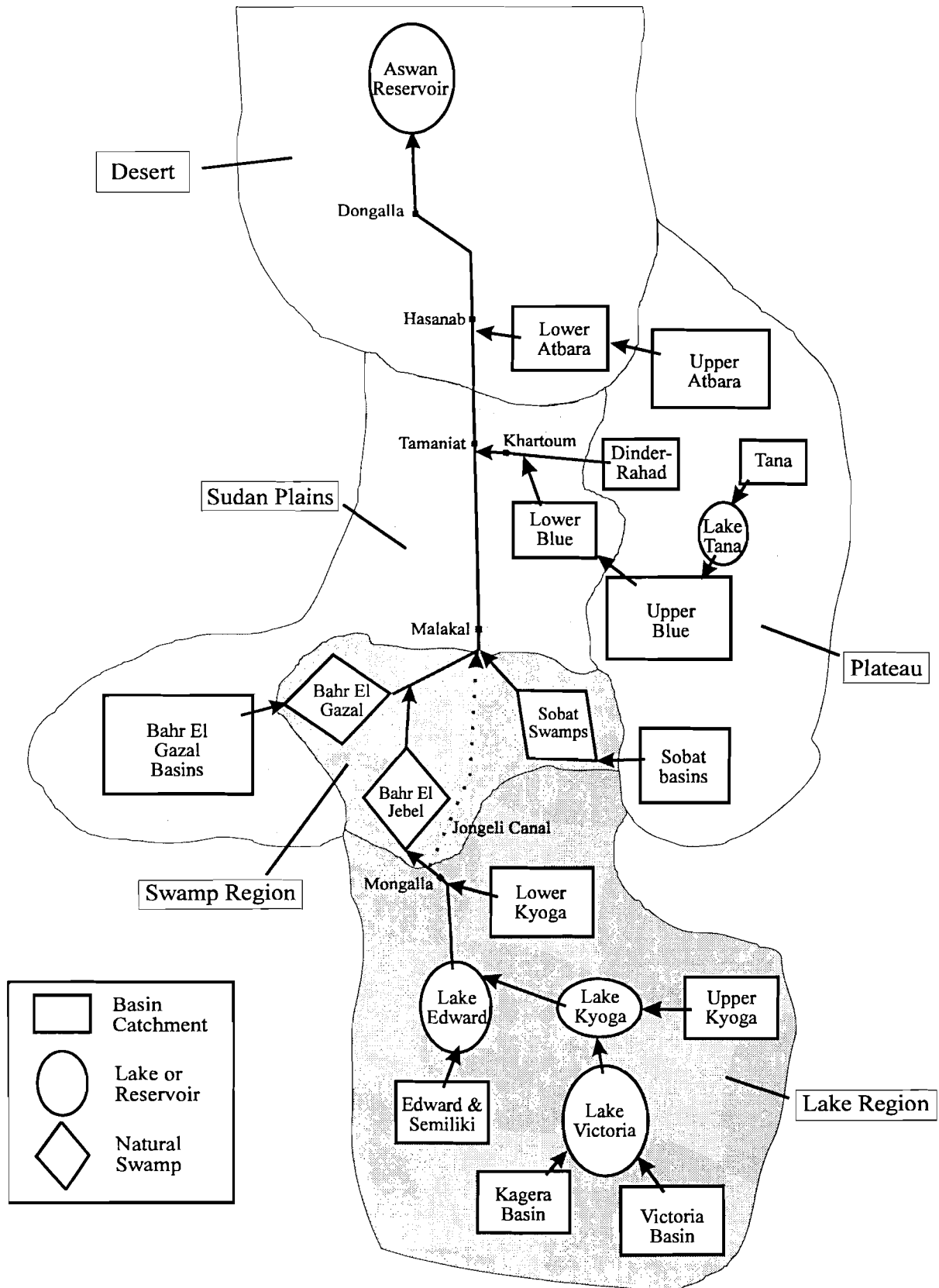

Figure 10. Schematic diagram of the Nile Basin and the main components of the hydrologic model.

Table 1 shows the sensitivity of Lake Victoria to changes in precipitation. Piper et al. (1986) have successfully modeled these changes and concluded they were mainly attributable to changes in precipitation and not to changes in evaporation, which was assumed to vary little from year to year.

Table 1 Precipitation on Lake Victoria and surrounding region for two periods (1956-1960 and 1961-1975) and discharge from Lake Victoria for the same two periods

	1956-1960	1961-1975	% change
Precip (mm)	1700	1880	11%
Evap (mm)	1600	1600	0%
Tributaries (mm)	260	365	41%
Outflow (mm)	300	640	113%

#### Lake Albert and the Semiliki Basin

Lake Albert, Edward and George form part of the Great Rift valley along the western edge of the Nile basin's lake region and comprise about 48,000 km<sup>2</sup> of the Nile, of which 7,800 km<sup>2</sup> is open water. The primary contributor to the Nile from this region is the River Semiliki, whose flow directly enters lake Albert from the southwest. Lake Albert discharges to the south and forms a broad, sluggish stream for about 230 km and then becomes fast moving for another 160 km and then slows considerably before reach Mongalla and the mouth of the Bahr El Jebel. A number of streams discharge water to the Nile along this reach, and the river Nile grows by on average an additional 4x10<sup>9</sup> m<sup>3</sup> from the exit of Lake Albert to Mongalla. The Nile flows northward, out of Lake Edward towards Mongalla, the headwaters of the Sudd swamp region. Between Lake Albert and Mongalla, the lower Kyoga basin further contributes to Nile flow.

#### **Sudd Swamps**

##### Bahr El Jabel

The region from Mongalla to Lake No comprises a vast series of swamps and Lagoons, with some estimates of permanent swamp area of over 10,000 km<sup>2</sup>, and with seasonal fluctuations adding as much as 25,000 km<sup>2</sup> of additional swamp area during high flow years (Sutcliffe and Parks 1987; Shahin 1981). A large portion of water is lost in these swamps, as (Figure 11) shows the relationship between the flow at Mongalla and the water lost to evaporation from the Bahr El Jebel, so even under high flow conditions, there is not a major increase in discharge from the swamp region before Malakal.

##### Bahr El Gazal

The Bahr El Gazal basin lies to the west of the Bahr El Jebel and extends westward, dividing the Nile and the Congo river basins. The area is over 500,000 km<sup>2</sup>, with approximately 16x10<sup>9</sup> m<sup>3</sup> of water coming from the basin into the swamp region, yet only 0.6 x10<sup>9</sup> m<sup>3</sup> of water leave the Bahr El Gazal at Lake No. A massive volume of water (over 25 x10<sup>9</sup> m<sup>3</sup>) is currently lost through evaporation from an average swamp area about 14,000 km<sup>2</sup>.

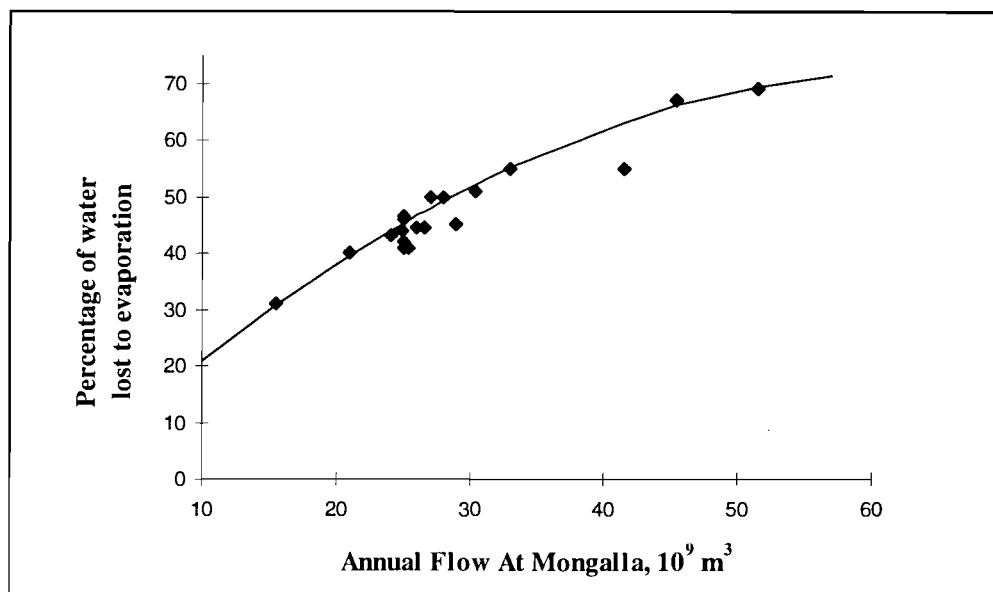

Figure 11. Curve depicting the water lost due to evaporation in the Bahr-El Jebel swamp region as function of the flow at Mongalla (Shahin 1981)

### Sobat

The Sobat basin (approximately 150,000 km<sup>2</sup>) is comprised of two primary tributaries: the Pibor and the Baro. The Baro is the smaller of the two, yet contributes a larger portion of the discharge because it originates in the mountainous region of Ethiopia. It is estimated that more than 35% of the discharge from this basin is lost to evaporation in the surrounding swamp region, which has about 7,000 km<sup>2</sup> of permanent swamp. The Pibor is the larger of the two basins, yet loses a great portion of water to evaporation from slopes due to its flatness. The discharge of the Sobat meets with the water exiting the swamp region just above Malakal, where it continues its journey towards the Mediterranean.

### **Sudan Plains**

Below Malakal, on the main stem of the White Nile, regression relationships were used to route flows between gauging stations along the main stem of the Nile. Along these portions of the Nile River, there is a net loss in flow due to seepage and evaporative losses. It was decided that regression relationships would adequately describe these losses and that physical modeling would not significantly contribute to modeling accuracy. Also, climate changes were not imposed on these stretches and the assumption that these regression relationships hold under future climates is assumed

### **Highland Plateau**

The highland plateau of Ethiopia contains the tributaries of the Blue Nile comprising some 12 significant sub-basins which form the largest contributor to the Nile flow. These 12 sub-basins of the Blue Nile have been aggregated into four primary basins comprising the over 300,000 km<sup>2</sup> of the Blue Nile. These include: Lake Tana (20,000 km<sup>2</sup>), Upper Blue (150,000 km<sup>2</sup>), the Lower Blue (60,000 km<sup>2</sup>) and the Dinder-Rahad (70,000 km<sup>2</sup>). The Blue Nile basin comprises around 16% of the physical area of the Nile Basin, yet contributes over 60% of the Nile River flow which indicates its great significance in determining climate change impacts. Over the year, the basin has a “negative” water potential because potential evaporation exceeds precipitation. However, precipitation occurs within a short period on

steep portions of the plateau region. If there should be significant changes in the seasonal distribution of rainfall, runoff patterns could be greatly affected. A flattening of the rainfall hyetograph could significantly reduce runoff, especially if potential evapotranspiration remains high throughout the year. Increased rainfall during the already rainy periods could bring dramatic increases in runoff because a large portion of this additional rainfall would not have a chance to evaporate or infiltrate.

#### Lake Tana and the Upper Blue

Lake Tana and its surrounding catchment are the headwaters of the Blue Nile and contributes, on average, less than ten percent of the total Blue Nile flow. Water emerges from Lake Tana, where a series of tributaries add the bulk of the Nile water to the main channel of the Blue. The water then falls down the steep Ethiopian plateau (a 1200 m drop in less than 1000 km) where it reaches Roseries. From Roseries to Senar, evaporative demands far exceed precipitation and a net loss occurs between these two gauging stations. A regression relationship is used to determine the flow at Senar.

#### Dinder-Rhadad

From Senar to Khartoum, two additional tributaries spill to the Blue Nile. These are the Dinder and the Rhadad, which are seasonal streams with practically no flow from January to May. Combined, these two basins contribute a little more than 4 milliards on average. Upon receiving the inflows from the Dinder and Rhahad, the Blue Nile meets the White Nile at Khartoum where it flows in a northerly direction towards the confluence of the Atbara. Along this stretch of the Nile, evaporative losses dominate the flow regime.

#### Atbara

The Atbara basin is a intermittent stream with a surface area of about 100,000 km<sup>2</sup>. The upper portion of the basin, containing the river Setti, is the primary contributor because the lower portion of the Atbara receives little precipitation and has a much larger evaporative demand. The Atbara, on average, contributes an additional 11 to 12 milliards of water to the main Nile.

### **Desert Region**

#### Main Nile (Hasanab to Aswan)

From around Atbara, northward towards Egypt the climate of the Nile Basin becomes hot and dry. There are essentially no additional contributions to flow below Atbara, and in fact a net loss occurs between Atbara and Lake Nasser due to evaporative and seepage losses from the river channel. Again, established regression relationships were used to determine flows along this stretch of the river, which included a relationship for the Atbara - Dongalla reach and the Dongalla - Lake Nasser reach.

### **Modeling Approach**

The monthly water balance approach, appropriately modified to handle varying hydrologic conditions was used for studying the impacts of a changed climate on water resource availability within the Nile Basin. There are several reasons for the use of a monthly approach. Most important is that monthly climate and runoff data is readily available throughout the entire basin. Also, the primary research objective is the sensitivity of Nile basin discharge to climate shifts as a result of global warming. Shorter hydrologic time scales, such as days, hours or minutes are useful for looking at event scale processes, but this work is concerned with long-term water availability; i.e. shifts in average values. Also, time steps longer than one month tend to lose the inter-annual fluctuation of important climate variables such as precipitation and temperature, which can exhibit a great deal of variability within the year and are important in determining basin discharge. Monthly mean values are

used as the input series, and the validity of their use for the assessment of climate change impacts can be found in Niemann et al. (1994). Because a monthly time step is used, it was determined that routing river flows was not necessary due to the fact that the longest travel time under low flow conditions is approximately 40 days. Although forty days does exceed the one month time step, it is felt that for the purposes of this modeling effort, the routing of flows would not enhance the evaluation of the basin's sensitivity to climate change.

All of the catchments were modeled using WatBal. Basin discharges were averaged over the period 1948-1973, primarily due to data availability. A geographic information system (GIS) was used to determine weighted average monthly precipitation and temperature values for each basin, with data coming from the Leemans and Cramer (1991) databases at  $0.5^{\circ} \times 0.5^{\circ}$  resolution. Precipitation was used directly in the water balance model while temperature values were used to derive monthly PET values using the Priestley-Taylor method. Descriptions of the water balance and PET methods were given above.

The Equatorial Lakes and Lake Tana were modeled using a mass balance approach with catchment inflow, direct lake precipitation and lake evaporation taken into account (Figure 12). Each of the four lake basins, Victoria, Kyoga, Albert, and Tana, have elevation-area-storage curves and non-linear outflow storage curves (WMO 1970). Calibration of each lake basin was based primarily on tributary inflows to the lake, where the discharge from the lakes served as the runoff series for calibration.

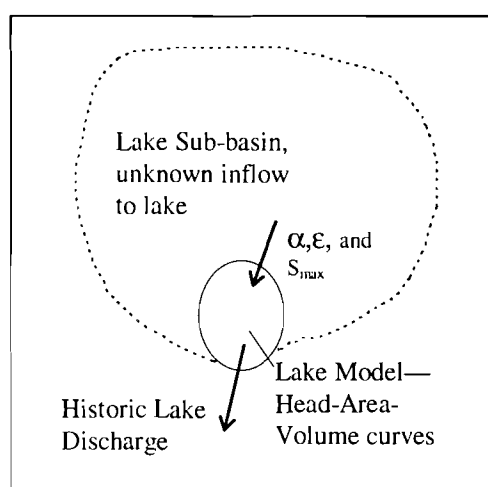

Figure 12 Lake basin models considered inflows to the lake from the surrounding tributary and simulation of lake storage based on head area volume curves. Calibration of the modeling coefficient,  $\alpha$ ,  $\epsilon$ , and  $S_{\max}$  was effectively performed on the tributary inflows.

The three swamp regions (Bahr El Jebel, Bahr El Gazal, and Sobat) were modeled using a mass balance and non-linear reservoir approach similar to the reservoir approach just described (Sutcliffe and Parks 1987). Figure 13 shows the general approach taken for modeling the Bahr El Jebel, the Bahr el Gazal and the Sobat swamp regions. The Bahr El Jebel was handled in a slightly different way due to the availability of data and past modeling efforts by Sutcliffe and Parks which took into consideration the Jonglei canal<sup>6</sup>. For the Bahr el Jebel swamp region, inflows from the upper lake region are the primary contributors to flow.

<sup>6</sup> The Jonglei Canal is a man-made diversion canal which cuts across the swamp region of Sudan to minimize water loss due to evaporation in the swamp region of southern Sudan. Although a large portion of the canal has been dug, construction has been halted due to continued civil war in southern Sudan.

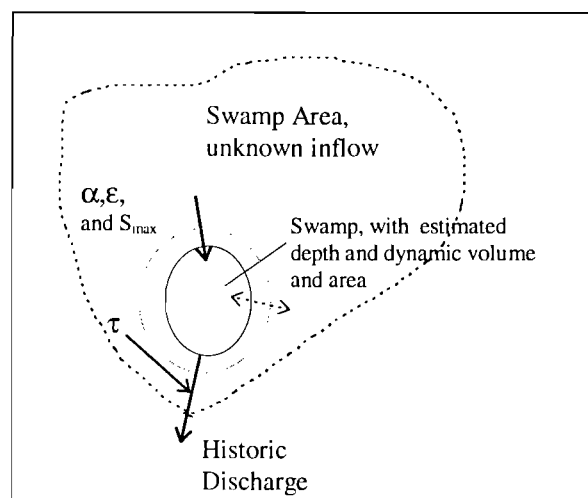

Figure 13 Swamp basin models considered inflows to the swamp from the surrounding tributary. The fraction of flow that does not enter swamp but enters the channel is  $\tau$  (Shahin 1985). The inflow to the swamp and the flow which goes directly to the channel at the outlet of the basin were lumped together for calibration of the modeling coefficients ( $\alpha$ ,  $\epsilon$ , and  $S_{max}$ ).

To calibrate the model, monthly mean values were used as the input series for precipitation, potential evapotranspiration and runoff. The calibration criteria were to minimize the sum of the squares of the difference between the observed and predicted discharge and to require that beginning and ending month storage be equal. This is a valid assumption when using mean values, where there is no long-term storage.

### 2.3.3. Climate Change Scenarios for the Nile Basin

Climate change scenarios were based on a GCM approach. The GCM's used are those from the Goddard Institute for Space Studies (GISS), the Geophysical Fluid Dynamics Laboratory (GFDL), and the United Kingdom Meteorological Office (UKMO). Three of these are steady state GCM's (GFDL, GISS, UKMO), the fourth is a transient GCM referred to as the LOWEND, which is a transient run of the GISS GCM. A summary of the global average changes predicted by these models and their resolution is given in

Table 2. The climate change scenarios were created by changing the historic, mean-monthly climate variables— precipitation, temperature, and sunshine hours based on the changes as reflected in each respective GCM.

Table 2. Summary of GCM Climate change scenarios

GCM	Resolution (lat x long)	CO <sub>2</sub> (ppm)	Change in average global: temp °C	precip %
GISS	7.8 x 10	630	4.2	11
GFDL	4.4 x 7.5	600	4.0	8
UKMO	5.0 x 7.5	640	5.2	15
LOWEND	7.8 x 10	630	2.5	6

Table 3 contains the main climate change indicators (temperature and precipitation) for the four primary regions within the Nile Basin. This includes the upper lakes region in the southern portion of the Nile; the Swamp region including the Bahr El Gazal and the Sobat basins; the Blue Nile including Tana and the upper and lower portions of the Blue; and the Atbara basin. The UKMO model is the warmest, with temperature increases as high as 4.8°C; while the GISS scenario is the wettest, with regional precipitation increases of over 150 percent.

An aggregation of available water to Egypt, based on model results is given in Table 4. Three of the four GCM's predict increases in annual average water availability to Egypt, with the GISS scenario showing a dramatic increase in available water. Water availability for each GCM was calculated using a reservoir simulation model which considers water abstraction for Sudan. Total available water for Egypt is the dependent variable. An iterative technique was employed to match the initial and ending month storage in Lake Nasser in order to assure mass balance. In all climate scenarios, a 15% increase in evaporative demand based on a 4°C warming was specified over Lake Nasser in order to compute new evaporative losses based on lake levels and evaporation.

Model results indicate that the Nile basin, on the whole, is quite sensitive to changes in precipitation. This is true not only within the lake region, but also along the Blue Nile and Atbara Rivers. Nemec and Shaake (1982) support this finding and point to the strong non-linearities between precipitation and runoff. They modeled a tributary of Lake Victoria and found that a 20% increase in precipitation, combined with 6% increase in potential evapotranspiration can lead to a greater than 80% increase in runoff!

Table 3. Annual changes in temperature and precipitation for the main regions of the Nile Basin.  $\Delta T^{\circ}\text{C}$  is the absolute change in temperature, while %P is the precipitation ratio for the given GCM scenario ( $2x\text{CO}_2/1x\text{CO}_2$ ). The LOWEND scenario are taken for the decade of 2030.

	GFDL		GISS		UKMO		LOWEND	
	$\Delta T^{\circ}\text{C}$	%P	$\Delta T^{\circ}\text{C}$	%P	$\Delta T^{\circ}\text{C}$	%P	$\Delta T^{\circ}\text{C}$	%P
Lake Region	2.7	1.14	3.6	1.31	4.8	1.20	2.1	1.22
Swamps	3.3	1.02	3.5	1.30	4.7	1.17	2.1	1.28
Blue Nile	3.5	0.95	3.4	1.47	4.8	1.29	2.2	1.30
Atbara	3.6	0.95	3.3	1.53	4.8	1.42	2.2	1.29

Table 4. Runoff from the Nile Basin for the baseline and 4 GCM models (in billions)

	BASE	GFDL	GISS	UKMO	LOWEND
Natural Inflow	84	74	160	132	130
Sudan Abstraction	18.5	13.6	56.6	42.5	41.0
Evaporation Loss at Aswan	10.0	10.6	12.1	11.9	11.6
Total to Available for Egypt	55.5	49.8	91.3	77.6	77.4

### 3. A Sketch of the Socio-Economic State of Egypt

#### 3.1. *The Economy, Population Trends, and a Future Perspective*

During the first half of the 20th century, private enterprise and free trade were characteristic of the Egyptian economy. Development was driven by public investment in agriculture with little industrial and agricultural protection from the state. From Nasser's program of Arab Socialism which began in the 1950's until the late 1980's, public ownership or control of a large portion of the industrial and agricultural sector, major international trade restrictions, and import substitution were dominant (Strzepek et al. 1994). Government policies appear to have worked well during the 50's, 60's and 70's, as standard of living conditions improved, real annual economic growth was about 9 percent and inflation was approximately 10 percent. Balance of payments were "sustainable" through foreign exchange earnings from expatriate worker remittances, tourism and foreign aid (Zeineldin 1986).

Since the 1980's, however, the situation has changed. Oil earnings have decreased as well as worker remittances, industrial growth has lagged, and domestic demand has increased rapidly due to an increasing population. Economic growth has declined, and unemployment and inflation have increased. Hansen (1991) points out several weaknesses in the current Egyptian economy which are of concern. The first is that Egypt has been spending more than it has earned, with expenditure growth about 1% greater than earnings. In addition, the trade and finance sectors have shown strong growth, while manufacturing has experiencing a steady decline which indicates a basic weakness in the Egyptian economy. This could be a short-term effect caused by the devaluation of the Egyptian pound which began in the mid 1980's (the International Monetary Fund concluded a monetary stabilization program during this time). Devaluation has caused an increase in costs of both intermediate and final import goods. The problem for Egypt, might be that the devaluation has not lead to decreases in demand because of food AID imports, which minimizes the affects of monetary devaluation. O'mara (1994) points out that Egypt is one of the highest consuming developing countries, despite the fact that it imports over half of its food commodities.

The agricultural sector continues to liberalize and remove restrictive controls. Indicators of this liberalization are already quite self-evident, especially within the agricultural sector. For example, cotton and wheat cultivation have responded dramatically to new pricing policies, as the liberalization has brought about greater flexibility and more rapid response to price fluctuation both on the domestic and international markets.

Egypt has undergone major changes during the last few decades, as the standard of living has increased significantly within the last few generations. Standard of living indicators are given in the World Bank's poverty matrix, Table 5 . The World Bank reports that women and children are among the most vulnerable members of Egyptian society with poor children in particular living in some of the worst conditions. In rural areas, the poor are generally agricultural laborers with little or no land, although the land reforms did help to improve there position (see summary and discussion section below). The ultra poor remain heavily dependent on direct income transfer.



Table 5. Poverty matrix for Egypt broken into both rural and urban regions and aggregated to a national level. Taken from the World Bank 1991 (Strzepek 1995)

Indicators	Rural Population	Urban Population	National
Proportion of poor (%)	24.2	22.5	N/A.
Proportion of Ultra Poor (%)	12.8	10.8	N/A.
Malnutrition	19.7	14.8	16.8
Infant Mortality (per 1000)	N/A.	N/A.	60.0
Child Mortality (per 1000)	N/A.	N/A.	7.4
Lack of Safe Water (%)	44.1	7.6	26.9
Poor Housing (%)	29.0	21.0	24.9
Illiteracy (%)	61.2	35.3	49.4

In 1990 Egypt's population was 52.4 million, of which 27.9 million lived in rural areas and 24.5 million lived in large urban centers (FAO 1993). The current projected annual population growth rate is 2.3 percent. This means that within less than a year, over a million people are added to one of the most densely populated regions on the earth. The strong population growth rate has led to a strong rural-urban migration. Cairo, for example, had grown to around 10 million by 1983 and could near 18 million by 2000 (Aliboni et al. 1984)

### 3.2. *Current and future water use in Egypt*

Egypt currently has the lowest per capita arable land of any African country, and with present population growth trends it is unlikely that this situation will improve. Agricultural activity is located in a narrow corridor along the Nile Valley and Delta region. Only 4% of the country's land is presently cultivated with over 96% of Egypt's agricultural land residing in the Nile Valley and Delta region. With vast amounts of open land, albeit predominantly low productivity areas, water is truly the constraint to expanding the agricultural land base. Egypt is currently granted 55.5 milliards of Nile water based on the Nile Waters agreement with Sudan. Any additional gains or losses are shared equally between the two countries. Interestingly, there is little international legislation with respect to Egypt and the other riparian countries of the Nile River and the allocation of her waters. What will happen if countries such as Ethiopia begin to experience rapid economic development and begin infrastructure expansion on the Blue Nile? Egypt's future is certainly dependent on the development strategies of her upstream neighbors.

As of 1989 Egypt's cultivated area was approximately 28,000 km<sup>2</sup>. If it is assumed that current annual evapotranspiration losses over irrigated land are approximately 1800 mm/year and using an irrigation efficiency of 70%, then the 1989 consumed use by agriculture was roughly 35 milliards, which corresponds closely to the estimate given by Keller (1992). Current plans within Egyptian planning agencies call for an increase in irrigated lands by about 11,200 km<sup>2</sup> with 6,400 km<sup>2</sup> receiving priority with respect to economic criteria (Biswas 1993). Using these increases in total irrigated lands through reclamation schemes (total irrigated could total more than 39,000 km<sup>2</sup>) and assuming irrigation efficiency remains unchanged, a future estimate of agricultural water demands is on the order of 49 km<sup>3</sup> of Nile water. Not only are irrigation needs increasing to meet growing food demands, but the swelling population searching for improved living standards will also strain future water supplies. The Egyptian Ministry of Public Works and Water Resources (MPWWR) estimate that 1980 industrial water use was 4.7 milliards and project a demand of

7.6 milliards by the year 2000. These types of future needs point the necessity of including water within an integrated economic assessment.

### **3.3. Agronomics and Land**

The U.S. Agency for International Development has built a set of comprehensive crop models (IBSNAT 1989) for assisting agricultural scientists in their research. The IBSNAT models have been used in numerous climate change studies for assessing the impact of climate change on crop yields (Rosenzweig and Parry 1993). Rosenzweig and Iglesias (1993) have compiled the results of a study involving agricultural scientists in 18 countries to estimate potential changes in national grain crop yields using the IBSNAT models. Because the IBSNAT model is physiologically based, it is able to account for moisture stress on plants as well as the fertilization effects from increased levels of atmospheric CO<sub>2</sub>. The crops modeled were wheat, rice, maize and soybeans. Rosenzweig and Parry (1993) state that 85% of the world cereal exports are comprised of wheat, rice and maize, while 67% of the protein cake trade (animal feed) is from soybean, so these are good representative crops.

Sea level rise associated with rising temperatures could have a major impact on coastal regions. El-Raey (1991) and others assume that agriculture cannot take place within the 1 meter contour, but current practice and future plans call for irrigation within this region. A 0.75 meter net sea level rise could result in lost agricultural lands of about 5 percent (Strzepek and Saidin 1994). It should be noted that it is estimated that between 8 and 40 tHa<sup>7</sup> of fertile, agricultural lands are lost per year to urban encroachment. Future land resources will require careful management and the impact on productive lands due to climate change are highly uncertain. As mentioned above, water is the real resource constraint and it is unlikely that a marginal sea-level rise would be of great significance. Nevertheless, in all climate change scenarios a 5% loss of land due to rising sea-levels are assumed to occur in a linear fashion over the time horizon of the study (1990-2060) and no concession is made for land loss due to human pressures.

## **4. Baseline - optimistic and pessimistic scenarios with and without water**

To address climate change impacts and the role of scarce resources such as water within the economy, a set of reference or baseline scenarios were developed. The baseline scenarios make a number of assumptions regarding national economic development and assume that crop yields, land, and water resources are not affected by climate change.

The BLS requires a large number of exogenous parameters which are a prerequisite to the simulation. As Onyeji and Fisher (1994) point out, "simulation results show that the assumption of exogenously determined technological progress may be inappropriate." While this is perhaps true, certain assumptions must be made and it becomes practically impossible to endogenize certain variables given the complete lack of knowledge. For example, what type of yield increases will be realized over the next 80 years? Have we reached the point of diminishing returns with respect to yield increases or could there be a second "green revolution"? For these reasons, it seems useful to define a number of baseline scenarios—caveat the assumptions for each scenario—and proceed. It is important to remember that the definition of these baseline scenarios plays major role in the climate impact assessment.

Because of the method used to determine non-agricultural production, the associated parameters of this component of the model greatly influence the simulation results. It is immediately evident that not only Egypt, but any country involved in the global marketplace

---

<sup>7</sup> tHa = thousands of hectares

will face a host uncertain possible futures. Any simulation that is generated by the BLS out to fifty, sixty, seventy or more years in the future is really only a single realization of a myriad of possible futures. Therefore, a single simulation for a given set of assumptions within the BLS can be thought of as *only* a scenario and *not* a prediction. For this reason, two different baseline, economic scenarios were generated. One is designated optimistic, the other pessimistic. The importance of the exogenous specification of model parameters, even the few chosen for the two optimistic and pessimistic cases given here reveal the sensitivity of the BLS to model parameters.

In all scenarios an important policy assumption is made concerning the terms of trade. Egypt currently is a large importer of food grains to meet domestic demand, however in all simulations an exogenous policy of reducing the 2060 net trade balance by one half the observed 1990 value is prescribed.

World market conditions of commodity prices and output play an important role in determining Egypt's economic condition. Although food self sufficient just over 25 years ago, Egypt now is a major importer of food to meet domestic demands. From an export perspective, Egypt's agricultural sector accounts for almost 15% of total export earnings (Hansen 1991). Depending on global prices and production, and domestic output and quality of exported goods; Egypt's relative position on the world market will determine its ability to secure food and export cotton and other cash crops.

Table 6 lists the relative prices for the 10 commodities of the BLS to 1990. For the 2060 BASE scenario, staple food output (wheat, rice, and coarse grains) expanded considerably, lowering relative prices<sup>\*</sup>. There was little price change in animal goods and other food and non-food agriculture showed a significant decrease in relative price, due to significant increases in production. Only protein feed showed a significant price increase.

The GCM's give a mixed picture. The UKMO GCM shows the biggest impact due to depressed yields reducing production and raising prices. The GISS model has the most moderate changes as this scenario is "cooler" than the others and yields remain higher. In all cases, both *non-food agriculture* (for Egypt this would be cotton) and *other food* (fruit and vegetables) decrease in price due to large production increases. This points to a deterioration of any comparative advantage Egypt might have for these types of commodities.

Table 6. Relative index of world commodity prices to 1990 values (1990=1.0).

	2060 BASE	GISS CO <sub>2</sub>	GISS Adpt II	GFDL CO <sub>2</sub>	GFDL Adpt II	UKMO CO <sub>2</sub>	UKMO Adpt II	LOW
Wheat	1.01	1.04	0.87	1.21	0.97	2.22	1.29	0.70
Rice	0.89	1.25	0.96	1.17	0.95	2.13	1.25	0.79
Coarse Grains	0.90	1.14	0.84	1.33	0.92	2.41	1.24	0.69
Bov & Ov Meat	1.04	1.07	1.05	1.08	1.05	1.18	1.07	1.04
Dairy	0.97	1.01	0.97	1.03	0.98	1.21	1.01	0.94
Other Animal	0.91	0.93	0.88	0.97	0.90	1.07	0.96	0.85
Protein Feed	1.51	1.49	1.24	1.72	1.38	3.53	1.90	0.92
Other Food	0.74	0.73	0.66	0.78	0.70	1.13	0.87	0.55
Non Food Ag	0.59	0.63	0.55	0.66	0.56	1.05	0.70	0.44
Non-Ag	1.00	1.00	1.00	1.00	1.00	1.00	1.00	1.00

<sup>\*</sup> Prices are based on 1970 Egyptian pounds

#### 4.1. Reference Scenario: Optimistic

The global community sees the advantage of Egypt's location and chooses to invest capital in the non agricultural production sector. Egypt becomes the "South Korea" of the 21st century. Egypt will invest in new, efficient technologies and will be able to use this to its advantage as compared to aging, less productive technologies.

Higher agricultural prices accelerate economic growth and generate employment for the poor in the non-agricultural sector in the long run. The possible short term effect is higher prices, which reduces the purchasing power of the poor. Regardless, it is likely that the transformation from an agriculturally to non-agriculturally dominated society would probably lead to heavy short-run costs reflected mostly onto the rural class poor. Egypt's economy might likely be experiencing some of these trends already (El-din 1993). An aggregate input-output table for 1975 is compared to a similar table for 1993, which shows a trend towards a shrinking agricultural sector (Taylor 1979).

A Leontief input-output analysis (Equ 4.1) using the 1975 table (Table 7) shows that a 10% increase in agricultural demand would correspond to a 3% increase in production in the non-agricultural sector. By 1993, a 10% increase in agricultural demand corresponds to an approximate increase of only 1% in non-agricultural production. Where,

$$P=(I-A)^{-1}D \quad \text{Equ 4.1}$$

$P$  = Production

$I$  = Inverse Matrix

$A$  = Input-Output coefficients (Table 7)

$D$  = Demand

Table 7 Input-Output coefficients for agriculture (ag) and non-agriculture (non-ag)

A (1975)	ag	non ag	A (1993)	ag	non ag
ag	0.02	0.00	ag	0.17	0.04
non ag	0.41	0.29	non ag	0.17	0.23

This simple analysis indicates that the influence of agriculture on the non-agricultural sectors is diminishing. In order to achieve the kind of structural adjustments that the optimistic scenario predicts, domestic and foreign liberalization policies will have to occur. This is predicated on the idea that the Egyptian industrial sector can produce exportable goods that are competitive on the world market. Decreased government intervention will increase the flexibility of both the agriculture and non agriculture markets which will both benefit from liberalized policies. Resource and environmental conditions are not a major constraint to growth.

With trade liberalization, its advantageous location on the Mediterranean, its control over the Suez Canal, and a fairly well educated yet inexpensive labor force, Egypt could become a major center for manufactured goods using imported factor inputs. The value of the real exchange rate is a critical component of the structural adjustment process. A summary of assumptions for the optimistic scenario includes:

- Investment rate, high (12 % above depreciation rate for non-agricultural sector)
- High non-agricultural productivity rate increase (2+%/year)

- Labor transformation rate, movement from agricultural to non-agricultural activity is high.
- High Quality, competitively priced Non-agricultural good is reflected through a competitively priced non-agricultural good available on the world market
- Increasing labor rate relative to population growth - labor force is assimilated into the economy
- Non-agricultural sector becomes highly dominate into the 21st century
- Non-agricultural sector has little dependency on the Agricultural sector

Within the agricultural sector, the optimistic scenario implies improved water use efficiencies through improved technologies. Irrigation practices would move away from infrequent flooding to modern methods of irrigation based on high-frequency, low-volume applications of water and fertilizer (Rosenzweig and Hillel 1994). Owing to the small-scale nature of a large portion of Egyptian agriculture, adapting new technologies is quite practical. What will be needed are incentive programs and capital to be able to adopt new technologies.

#### **4.2. Reference Scenario: Pessimistic**

Egypt currently adds a million inhabitants to its population in less than a year, which places into questions whether or not the country will be able to absorb the large, young labor force. Egypt continues to be a “major” consumer through inexpensive imports of food commodities. Although Egypt has arguably some of the best agricultural land in the world, it is currently importing over two-thirds of its wheat and vegetable oils and one-third of its corn. Agricultural imports have increased nearly 300% over the last twenty years and these imports are “costing” Egypt over \$3 billion annually (Strzepek et al. 1994), yet their food production efficiency is quite low considering that almost 25% of the total cropped area is used for animal fodder, which is perhaps an inefficient use of scarce land and water resources.

The pessimist sees these trends as Egypt digging itself into a hole. Population will continue to outpace employment opportunities, foreign debt will increase, poor public policy will stymie growth, and investment within any sector will remain small. Structural change is often difficult because payoff is often delayed and there are immediate costs of under-taking structural reform. Policy makers are often unwilling to take such “painful” short run risks without knowing the long-run benefits. Thus, the hole will only grow deeper. Resource and environmental conditions constrain growth. A summary of assumptions for the pessimistic scenario includes:

- Investment rate, low (8% above depreciation rate of non-agricultural sector)
- Low non-agricultural productivity rate increase (1%/year)
- Labor transformation rate, low
- No Non-agricultural advantage to Egypt, reflected in higher relative price to world market
- Decreasing or constant labor rate relative to population growth, slow mobility of agriculture from agriculture to non-agriculture sector.
- Non-agricultural sector remains labor intensive: i.e., limited foreign capital investment
- Agriculture sector remains a large portion of the economy into the 21st century
- Non-agricultural sector is more dependent upon the agricultural sector

With a ballooning population, pressing for a limited number of jobs, structural adaptation and transformation of the agricultural sector continue to be difficult. Technological advancements are seen as competition to employment and are be looked at

negatively. Irrigation practices continue along their present course, with low efficiencies and large losses. Intervention and regulation by government continues to be haphazardly implemented and agricultural inefficiencies remain.

With a limited natural resource base, it is hard to imagine a country like Egypt becoming a major producer of industrial goods. With one of the larger global population densities and its umbilical attachment to the Nile, major industrial growth is not likely to occur without major outside investment as well as the fact that internal capital creation is difficult due to the limited natural resource base. Likewise, it is difficult to imagine Egypt becoming a major exporter of raw or manufactured industrial goods.

### **4.3. Analysis of the Baseline Scenarios**

The four baseline scenarios were developed in order to look at a number of issues. First was to look at assumptions regarding development paths, second was to address the role of water in the economic modeling process and finally was the use of the baseline scenarios as a comparison metric to the climate change simulations.

- OPT\_WC = Optimistic scenario with water resources as a constraint to development within the BLS.
- PES\_WC = Pessimistic scenario with water resources as a constraint to development within the BLS.
- OPT\_UW = Optimistic scenario with unlimited water. Water is not a constraint to agricultural production.
- PES\_UW = Pessimistic scenario with unlimited water. Water is not a constraint to agricultural production.

Table 8 is a compilation of general socio-economic indicators for these baseline scenarios. Generally, the pessimistic cases maintained a higher level of agricultural production than do the optimistic cases. This was primarily attributable to the fact that fewer resources were diverted to the non-agricultural sector. Assumptions regarding the development of the non-agricultural sector, investment rates, and agriculture-non agriculture transformation rates with respect to capital and labor were a dominant factor in the baseline scenarios.

For the OPT\_WC scenario, a larger portion of labor is occupied in the non-agricultural sector and labor participation outpaces population growth. The population in 2060 is 2.22 times greater than in 1990 and employment in 2060 is 2.26 times the 1990 value. In the PES\_WC scenario, a larger share of economic activity remains in the agricultural sector and for this reason, labor assimilation (2.23) barely outpaces population growth (2.22).

Incomes in the optimistic scenario rise as is reflected in higher food prices, and although farm prices (measured by the crop price index) fall, increased production raises the net revenues of producers. In the pessimistic scenarios, relative food prices fall below 1990 values, which indicate smaller income improvements. Per capita GDP is much higher in the optimistic scenario due to increases in the non-agriculture sector.

Table 8. Economic and resource indicators for 1990 and the four 2060 reference scenarios. The 2060 reference scenarios are ratios of the 2060 to 1990 values.

General Indicators for Reference Scenarios					
Indicator	1990 base	<sup>1</sup> 2060 optimal water constraint <sup>a</sup>	<sup>2</sup> 2060 optimal unlimited water <sup>a</sup>	<sup>3</sup> 2060 pessimistic water constraint <sup>a</sup>	<sup>4</sup> 2060 pessimistic unlimited water <sup>a</sup>
Population	54156	2.22	2.22	2.22	2.22
GDP Ag	1143	1.96	2.09	2.35	2.50
GDP Non-Ag	4878	7.17	7.20	3.24	3.40
GDP/Cap.	256	2.78	2.80	1.38	1.45
Trade Balance	247	0.81	0.81	0.55	0.57
Ag Capital	3431	2.25	2.33	2.47	2.55
Non-Ag Capital	9912	8.09	8.12	2.96	3.03
Labor Ag	7506	1.26	1.25	1.72	1.65
Labor Non-Ag	7699	3.25	3.26	2.73	2.80
Cal/day	2587	1.25	1.25	1.09	1.12
Parity	0.30	0.58	0.63	0.93	1.01
PAg / PNon-Ag	1.25	0.83	0.83	0.80	0.81
Crop Price Index	1.19	0.78	0.78	0.77	0.77
Food Price Index	1.16	1.07	1.07	0.97	0.97
Harvested Area	3808	1.10	1.28	1.22	1.42
Ag Water Use	32.8	0.91	1.50	1.19	1.63
M&I Water Use	7.5	3.09	3.09	2.38	2.42
Fertilizer	397	1.70	2.15	1.76	2.28

For the 1990 Base the above indicators are as follows: GDP is given in millions of 1970 dollars. Trade balance is the net import (positive) or export (negative) in millions of 1970 dollars. Ag and Non-Ag Capital are capital stock in millions of dollars. Ag and Non-Ag labor are participants in millions. Cal/day is the per capita calorie intake. Parity is the ratio of agricultural GDP per capita of agricultural wage earner divided by non-agricultural GDP per capita of non-agricultural wage earner; an equity indicator. Crop price index is the index of crop prices at the farm level, while the food price index is the price of food at the retail level. Harvested area is the total cropped area (tHa<sup>a</sup>). Agricultural water is the consumptively used water for agricultural production, including fodder production and M&I are municipal and industrial uses. <sup>1</sup> OPT\_WC = 2060 optimal/water as constraint; <sup>2</sup> OPT\_UW = 2060 optimal/unlimited water; <sup>3</sup> PES\_WC = 2060 pessimistic/water as constraint; <sup>4</sup> PES\_UW = 2060 pessimistic/unlimited water.

Onyeji and Fischer (1994) report no significant change in commodity value share with respect to total agricultural production, keeping in mind that their analysis did not include water. This means they found no significant shift in the basic structure of agricultural production over the simulation period. With respect to this metric, the impact of water within the simulation becomes evident. Table 9 gives the value share for the agricultural commodities for 1990 and the four 2060 baseline scenarios. Comparing the scenarios with constrained water and unlimited water (for both the optimistic and pessimistic scenarios), the commodity share shows a much greater change for the two scenarios with water as a constraint. The 2060 optimistic (OPT\_WC) scenario has an absolute summed difference of 0.30 and the 2060 pessimistic (OPT\_WC) has a value of 0.19, with a larger number indicating greater structural change. There is a shift away from high water consumers such as rice. The water constrained scenarios also show a greater emphasis on livestock, as budget shares for all three livestock commodities grow in greater proportion under these scenarios. This is

<sup>a</sup> tHa = thousands of hectares

explained by the fact that a greater emphasis is placed on investments in livestock which are only indirectly related to water. Increased feed demands are met through using domestic resources and an increasing amount of imported feed. This can be considered a significant structural change for Egypt.

Table 9. Specific commodity value share as a percentage of total (metric taken from Onyeji and Fischer 1994).

	1990 base	2060 optimal water	2060 optimal no water	2060 pessimistic water	2060 pessimistic no water
Wheat	0.04	0.07	0.07	0.07	0.06
Rice	0.06	0.02	0.08	0.02	0.06
Coarse Grains	0.10	0.08	0.09	0.07	0.08
Bov & Ov Meat	0.12	0.15	0.13	0.16	0.14
Dairy	0.10	0.13	0.11	0.13	0.10
Other Animal	0.15	0.20	0.18	0.23	0.21
Protein Feed	0.01	0.02	0.02	0.02	0.02
Other Food	0.26	0.22	0.22	0.21	0.23
Non Food Ag	0.15	0.10	0.10	0.10	0.10
$\Sigma$ abs(2060-1990)	--	0.30	0.13	0.19	0.15

The optimistic and pessimistic scenarios which include water as a resource constraint (OPT\_WC and PES\_WC) show improving economic conditions within Egypt. OPT\_WC gives a “brighter” future for Egypt. In 1990 agriculture accounts for approximately 19% of GDP and by 2060 this is reduced to 6% in the OPT\_WC scenario, while in the PES\_WC scenario agriculture’s share of GDP is 14.5%. In general, the optimistic scenarios show a decreasing role of agriculture in the economy while the pessimistic scenarios maintain a greater agricultural sector. Even agriculture’s share of water has declined by 2060 in the OPT\_WC scenario, as municipal and industrial demands are the recipients of water transfers from the agricultural sector.

## 5. Climate Change Scenarios

A total of 28 climate change simulations were performed with the BLS including both optimistic and pessimistic simulations which included and excluded water as a resource constraint. Water as a resource constraint has not been incorporated into earlier studies of climate change using the BLS (Rosenzweig et al. 1995; Onyeji and Fisher 1994). Two simulations for each steady-state GCM at  $2xCO_2$  (GFDL, GISS, and UKMO) and a single simulation with a transient<sup>10</sup> GCM (LOWEND) were run. The first climate change scenario took into account the positive physiological impacts of a  $CO_2$  doubling on yield while the second scenario accounted for  $CO_2$  fertilization as well as extensive adaptation measures, *Adpt II*.

Table 10 are the relative changes in crop yield from 1900 for the four GCM’s. Yield changes are based on GCM’s only, so are not altered based on the pessimistic or optimistic scenarios of with and without water. The UKMO model displays the most negative impacts, primarily due to larger temperature changes, while the LOWEND scenario has yield increases for some of the commodities.

<sup>10</sup> Transient GCM: Atmospheric concentrations of greenhouse gases are assumed to increase gradually over time, which is captured in transient GCM simulations. The other three GCM’s (GFDL, UKMO, GISS) are equilibrium solutions, where greenhouse gases are assumed to double and atmospheric equilibrium is achieved.



Table 10. Percentage change in crop yields relative to 1990 for the four GCM's. \*CO<sub>2</sub> is impact of climate change on crop yield with CO<sub>2</sub> fertilization considered. \*\*Adpt II, is level II adaptation as defined by Rosenzweig et al. (1993); which include the physiological effects of carbon dioxide and climatic variables (temperature and precipitation) as well as high cost adaptation measures.

	GFDL		GISS		UKMO		LOWEND
	*CO <sub>2</sub>	**Adpt II	CO <sub>2</sub>	Adpt II	CO <sub>2</sub>	Adpt II	Adpt II
Wheat	-0.26	-0.13	-0.31	-0.16	-0.51	-0.25	0.08
Rice	-0.07	-0.03	-0.13	-0.06	-0.27	-0.13	0.08
Coarse Grains	-0.17	-0.08	-0.17	-0.08	-0.30	-0.15	-0.12
Protein Feed	-0.01	0.00	-0.06	-0.03	-0.21	-0.10	-0.01
Other Food	-0.01	0.00	-0.06	-0.03	-0.21	-0.10	-0.01
Non-Food	-0.01	0.00	-0.06	-0.03	-0.21	-0.10	-0.01
Fruit	-0.06	-0.03	-0.06	-0.03	-0.21	-0.10	-0.01

Table 11 gives the changes in crop water use under the climate change scenarios relative to the 1990 base. In some cases, crop water use declines under the GCM scenario because of reduced plant transpiration caused by positive CO<sub>2</sub> effects. The protein feed, other food, and non-food crops show the most significant increases in water use, while wheat and coarse grains generally show a decline in water use.

Table 11. Percentage change crop water use for the four GCM scenarios relative to the 1990 base scenario. A negative value indicates a decrease in crop water use while a positive value is an increase

	GFDL		GISS		UKMO		LOWEND
	CO <sub>2</sub>	Adpt II	CO <sub>2</sub>	Adpt II	CO <sub>2</sub>	Adpt II	Adpt II
Wheat	-0.10	-0.10	-0.18	-0.18	-0.08	-0.08	-0.15
Rice	0.06	0.06	0.01	0.01	0.13	0.13	0.00
Coarse Grains	-0.10	-0.10	-0.16	-0.16	0.00	0.00	-0.10
Protein Feed	0.20	0.20	0.12	0.12	0.25	0.25	0.00
Other Food	0.20	0.20	0.12	0.12	0.25	0.25	0.00
Non-Food	0.20	0.20	0.12	0.12	0.25	0.25	0.00

Table 12, 13, 14, and 15 are the general indicators for the climate change simulations. The climate change simulations reported here include water as a resource constraint (OPT\_WC and PES\_WC). The large number of runs makes analysis difficult due to the amount of data, so the tables include one simulation using the GFDL GCM with unlimited water (grayed columns in these two tables). This is done to highlight the role of water, since the GFDL scenario was the only one with a decrease in Nile flow. Results for the other GCM's (GISS, UKMO, and LOWEND), assuming water as unlimited resource, would be trivial due to the fact that these GCM's predict large increases in Nile flows. It was decided not to report the results from these climate change scenarios. Also, comparing across the relative optimistic and pessimistic tables can be misleading due to the large differences in the baselines. For example, the 2060 GDP/capita for the optimistic case is 700 Egyptian pounds while the pessimistic case is 350 Egyptian pounds. Therefore, percent changes can be misleading, as to which scenario produces a better or worse results with respect to climate change.

Table 12 2060 climate change scenarios (Absolute). (GFDL\*—scenario with **unlimited water**; should be compared with the GFDL numbers found in columns 2 and 6 of these tables). *See Table 8 for indicator description.*

<b>General Climate Change Indicators-Optimistic Scenarios (Absolute)</b>									
	w/ CO <sub>2</sub> Fertilization				Adaptation level II				
	GFDL	GISS	UKMO	GFDL*	GFDL	GISS	UKMO	LOW	GFDL*
GDP Ag	1874	2141	2041	2262	1931	2123	2183	1804	2219
GDP Non-Ag	35377	35513	34815	35413	35673	35837	35301	36485	35678
GDP/Cap.	711	719	704	719	718	725	716	731	724
Trade Balance	199	199	195	199	200	201	199	202	201
Ag Capital	7193	7598	8799	7995	6967	7199	7995	6266	7517
Non-Ag Capital	80624	81178	78665	80886	81500	82057	80520	83329	81686
Labor Ag	9213	9061	9208	9069	9051	8915	9140	8525	9010
Labor Non-Ag	25282	25442	25293	25436	25448	25590	25363	25983	25495
Cal/day	3181	3219	3073	3196	3233	3259	3186	3299	3241
Parity	0.16	0.19	0.26	0.21	0.15	0.17	0.21	0.14	0.18
Pag / PNon-Ag	1.13	1.11	1.60	1.16	1.02	1.00	1.20	0.90	1.03
Crop Price Index	1.09	1.03	1.77	1.10	0.90	0.87	1.17	0.71	0.92
Food Price Index	1.33	1.27	1.61	1.33	1.22	1.17	1.36	1.07	1.22
Harvested Area	3371	4641	5142	4974	3313	4278	4884	3369	4564
Ag Water	24.9	52.8	50.6	54.4	24.7	46.2	51.0	31.9	47.9
M&I Water	23.2	23.3	23.1	23.3	23.3	23.4	23.2	23.5	23.3
Fertilizer	405	844	966	932	436	722	897	350	791

Table 13 2060 pessimistic reference scenario with water (Absolute). (GFDL\* - scenario with unlimited water). *See Table 8 for indicator description.*

<b>General Climate Change Indicators-Pessimistic Scenarios (Absolute)</b>									
	w/ CO <sub>2</sub> Fertilization				Adaptation level II				
	GFDL	GISS	UKMO	GFDL*	GFDL	GISS	UKMO	LOW	GFDL*
GDP Ag	2201	2587	2470	2725	2263	2576	2628	2247	2672
GDP Non-Ag	15933	16113	14817	15894	16244	16549	15801	16913	16450
GDP/Cap.	346	357	330	355	353	365	352	366	365
Trade Balance	133	135	123	134	136	139	133	140	138
Ag Capital	7820	8316	9670	8772	7568	7898	8759	6991	8243
Non-Ag Capital	29199	29698	26659	29137	30003	30619	28882	31527	30218
Labor Ag	12096	12042	12412	12116	12052	11937	12187	11749	12037
Labor Non-Ag	21828	21897	21513	21823	21878	22007	21750	22193	21908
Cal/day	2752	2823	2606	2828	2821	2873	2781	2910	2887
Parity	0.27	0.31	0.44	0.35	0.25	0.28	0.34	0.22	0.30
Pag / PNon-Ag	1.10	1.07	1.53	1.12	0.99	0.97	1.16	0.88	1.00
Crop Price Index	1.07	1.01	1.72	1.08	0.90	0.86	1.14	0.71	0.90
Food Price Index	1.20	1.16	1.48	1.20	1.12	1.09	1.22	1.00	1.12
Harvested Area	3781	5073	5387	5231	3696	4993	5206	4197	5045
Ag Water	33.1	59.1	61.9	57.5	33.1	54.2	61.9	39.5	52.6
M&I Water	17.9	18.0	17.5	17.9	18.0	18.1	17.9	18.2	18.1
Fertilizer	492	892	995	932	492	826	903	540	835

Table 14 Percent change in indicators relative to 2060 optimistic reference scenario with water. (GFDL\*—scenario with **unlimited water** and should be compared with the GFDL numbers found in columns 2 and 6 of these tables). *See Table 8 for indicator description.*

	<i>General Climate Change Indicators-Optimistic Scenarios (Relative)</i>								
	w/ CO <sub>2</sub> Fertilization				Adaptation level II				
	GFDL	GISS	UKMO	GFDL*	GFDL	GISS	UKMO	LOW	GFDL*
GDP Ag	-16.5	-4.6	-9.1	-5.5	-14.0	-5.4	-2.8	-19.6	-7.3
GDP Non-Ag	1.1	1.5	-0.5	0.8	1.9	2.4	0.9	4.3	1.6
GDP/Cap.	0.0	1.1	-1.0	0.4	1.0	1.9	0.7	2.8	1.0
Trade Balance	-0.1	0.2	-2.1	-0.2	0.5	1.0	-0.3	1.5	0.5
Ag Capital	-6.8	-1.5	14.1	0.0	-9.7	-6.7	3.6	-18.8	-6.0
Non-Ag Capital	0.5	1.2	-1.9	0.5	1.6	2.3	0.4	3.9	1.5
Labor Ag	-2.5	-4.1	-2.6	-3.7	-4.2	-5.7	-3.3	-9.8	-4.3
Labor Non-Ag	1.0	1.6	1.0	1.4	1.6	2.2	1.3	3.8	1.6
Cal/day	-1.3	-0.1	-4.6	-1.0	0.3	1.2	-1.1	2.4	0.4
Parity	-6.8	7.1	46.8	10.1	-11.8	-3.5	17.0	-22.6	-3.9
Pag / PNon-Ag	9.0	7.5	55.0	11.7	-1.4	-3.5	15.9	-12.6	-0.9
Crop Price Index	16.9	11.3	90.6	18.3	-3.0	-6.4	25.3	-23.2	-1.8
Food Price Index	7.3	2.4	29.6	7.4	-1.9	-5.6	9.3	-14.1	-1.9
Harvested Area	-19.5	10.8	22.8	2.3	-20.9	2.2	16.6	-19.5	-6.1
Ag Water	-16.8	76.1	69.1	10.7	-17.5	54.3	70.3	6.5	-2.4
M&I Water	0.3	0.5	-0.2	0.3	0.6	0.8	0.3	1.4	0.5
Fertilizer	-39.9	25.4	43.6	9.2	-35.2	7.3	33.3	-47.9	-7.4

Table 15 Percent change in indicators relative to the 2060 pessimistic reference scenario with water. (GFDL\* - scenario with unlimited water). *See Table 8 for indicator description.*

	<i>General Climate Change Indicators-Pessimistic Scenarios (Relative)</i>								
	w/ CO <sub>2</sub> Fertilization				Adaptation level II				
	GFDL	GISS	UKMO	GFDL*	GFDL	GISS	UKMO	LOW	GFDL*
GDP Ag	-18.0	-3.6	-8.0	-4.7	-15.7	-4.0	-2.1	-16.3	-6.5
GDP Non-Ag	0.9	2.1	-6.2	-4.1	2.9	4.8	0.1	7.1	-0.7
GDP/Cap.	-1.8	1.2	-6.4	-4.2	0.2	3.5	-0.2	3.7	-1.6
Trade Balance	-1.8	0.1	-9.1	-3.7	0.3	2.8	-1.8	3.6	-0.8
Ag Capital	-7.6	-1.8	14.2	0.3	-10.6	-6.7	3.5	-17.4	-5.8
Non-Ag Capital	-0.3	1.4	-9.0	-2.9	2.4	4.5	-1.4	7.6	0.7
Labor Ag	-6.2	-6.6	-3.8	-2.4	-6.5	-7.4	-5.5	-8.9	-3.0
Labor Non-Ag	3.8	4.1	2.3	1.3	4.0	4.6	3.4	5.5	1.7
Cal/day	-2.3	0.2	-7.5	-2.2	0.1	2.0	-1.3	3.3	-0.2
Parity	-2.2	12.2	58.8	14.2	-10.2	-0.5	23.1	-21.3	-2.3
Pag / PNon-Ag	8.8	6.6	52.4	10.7	-1.5	-3.9	15.0	-13.0	-1.1
Crop Price Index	16.4	9.8	86.5	17.0	-3.1	-7.1	23.9	-23.2	-2.2
Food Price Index	6.5	3.3	31.7	6.1	-0.5	-2.5	8.7	-11.0	-0.8
Harvested Area	-18.7	9.0	15.8	-2.9	-20.6	7.3	11.9	-9.8	-6.4
Ag Water	-15.2	51.1	58.4	7.7	-15.4	38.5	58.3	0.9	-1.4
M&I Water	-0.1	0.5	-2.0	-1.3	0.5	1.3	0.0	1.7	-0.3
Fertilizer	-29.3	28.1	42.9	2.9	-29.3	18.6	29.7	-22.5	-7.9

### 5.1. GFDL

The GFDL scenario has the largest negative impact on the agricultural sector which is attributed to the decrease in Nile water. Interestingly, the overall negative impact on key economic indicators such as GDP/capita and calories/capita are not large relative to the 2060 base. This can be explained purely by economic adaptation or autonomous economic adjustment, as Egypt “learns” quickly that climate change is reducing Nile flows and moves capital resources out of cropped agriculture and into the livestock and the non-agriculture sectors. Figure 14 gives the dynamic trend of crop and livestock production over the time horizon of the GFDL GCM. Figure 15 is the consumed agricultural water use over the same period, which shows agriculture’s share of water declining most rapidly in the optimistic scenario where water is a constraint (OPT\_WC). Table 12, 13, 14, and 15 include results from the GFDL under unlimited water. This is shown to highlight the impact of introducing water as a resource constraint. With unlimited water, the GFDL scenario of Table 12, 13, 14, and 15 shows a different situation than when water is a constraint, primarily within the agriculture sector. In most cases, the changes have a different sign when compared with water as resource constraint. For example, per capita calorie consumption increases, parity improves, farm and food prices drop in the unlimited water scenario (GFDL\* in Table 12, 13, 14, and 15) which are opposite when water is a scarce resource (GFDL in Table 12, 13, 14 and 15).

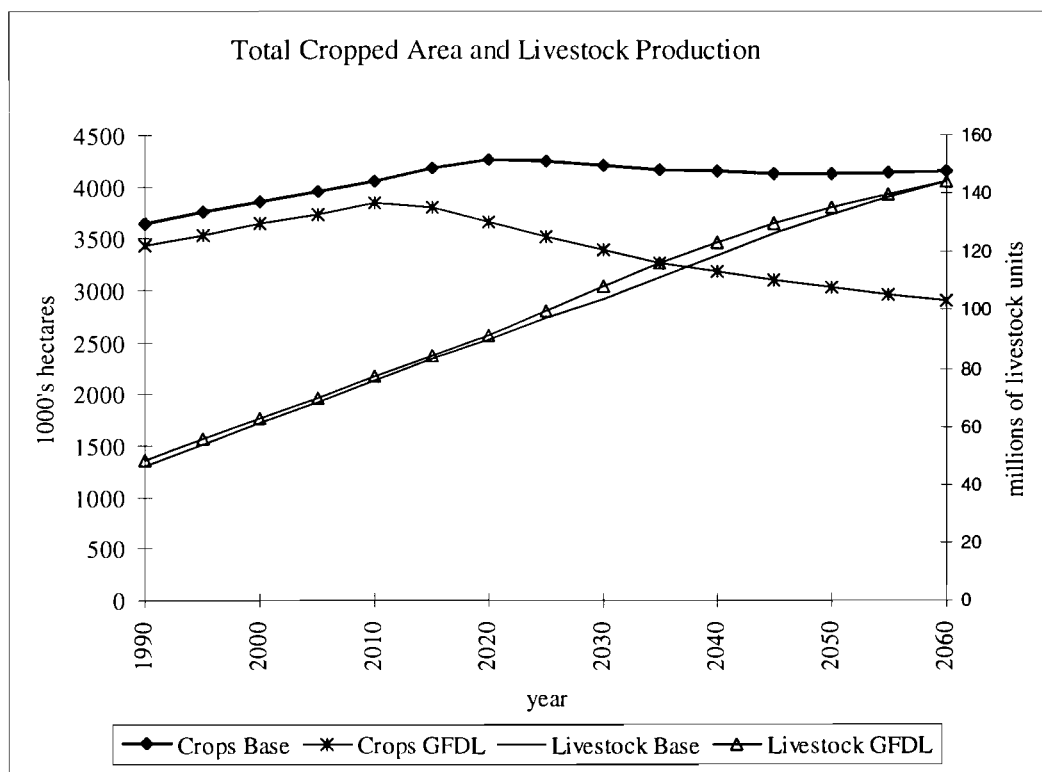

Figure 14 Total cropped area (thousands of hectares) and total livestock units (millions) for the pessimistic, base 2060 scenario (PES\_WC) and the GFDL climate scenario.

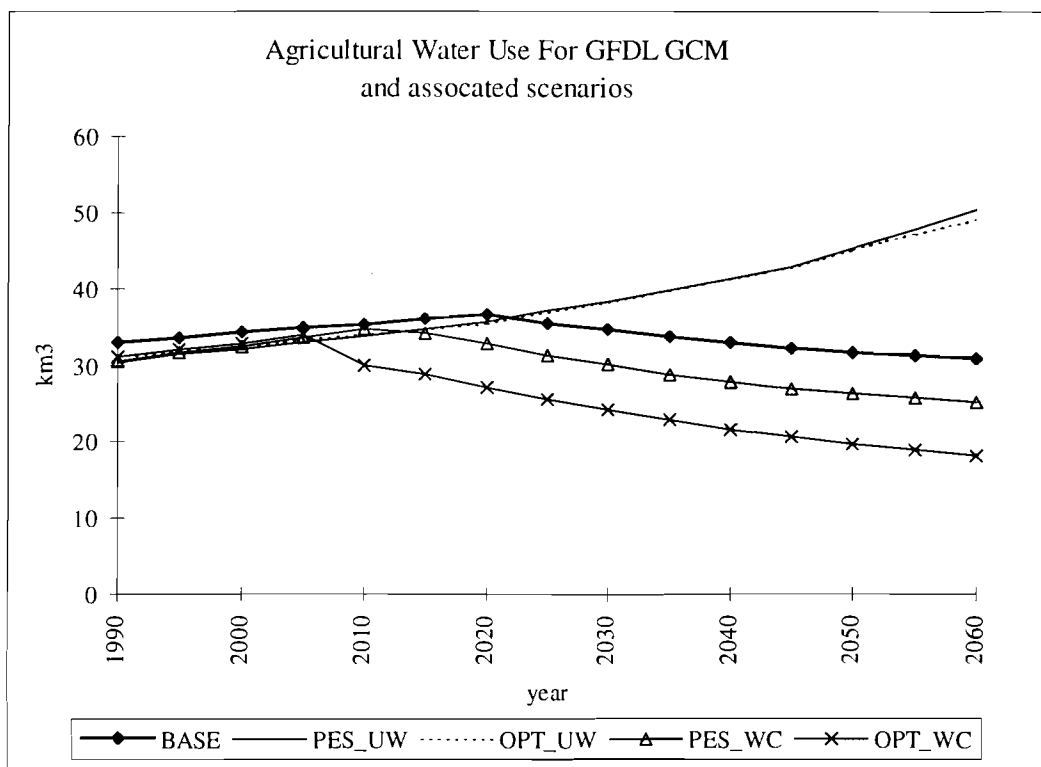

Figure 15. Time Series of agricultural water demand for the GFDL GCM scenario. This was the only GCM which gave a drop in annual water availability to Egypt. Shown are crop water demands for all scenarios using the GFDL GCM.

## 5.2. GISS

International market prices for the GISS GCM show the smallest variation relative to the BASE (see Table 6). Overall trade balance improves for both the pessimistic and optimistic scenarios and the impact of the world markets on Egypt are not as significant as either the UKMO or the LOWEND scenarios. Again, the importance of increased Nile flows is shown here because agricultural water use increases by over 75 percent and the land base is able to expand by an additional 10 percent (for the optimistic scenario). The trade balance improves, primarily due to growth in the non-agricultural sector and the ability of the agricultural sector to meet a larger share of domestic demand.

## 5.3. UKMO

Even with ample water, the general indicators of Table 12, 13, 14, and 15 imply that the UKMO climate model is the worst case GCM scenario for Egypt. This is because of lower food production caused by declines in yield for the primary food commodities (i.e. wheat, maize, and coarse grains). Both the crop and food price indexes increase considerably and Egypt's trade balance worsens in order to meet domestic food demands. Water use soars for the UKMO scenario, taking advantage of the increased Nile flow in an attempt to meet domestic demands through local production.

This large increase in agricultural water use (70% OPT\_WC; 60% PES\_WC) greatly dampens the negative impacts of higher temperatures within the Egyptian borders. The pessimistic scenario for the UKMO GCM shows the most negative impact (PES\_WC). However, adaptation measures greatly reduce the negative impacts as is seen in the tables.

#### 5.4. *LOWEND*

The state of Egypt under the *LOWEND* (transient) GCM scenario depends heavily on world market conditions. Yields and water use impacts are the smallest of the scenarios on the global level, reflected in lower food prices at both the international and domestic levels. Despite large increases in available water, Egypt chooses to divert investments to the non-agricultural markets and increase food imports to meet domestic needs. In fact, despite the large increase in available water a large portion remains unused as the shadow price for both land and water drop to zero.

The agriculture sector shrinks relative to the non-agriculture sector. This scenario is heavily dependent upon the ability of Egypt to assimilate the rural agriculture labor force into the non-agriculture sector, as the agricultural labor force shrinks by almost 10% while the non-agriculture labor force increases by about 2.5%. The percent increase in municipal and industrial water use is greatest in this scenario, due to the large structural transformation which occurs. Surprisingly, even the pessimistic scenario of the *LOWEND* GCM shows a large decrease in the agricultural sector, as investments are focused in the non-agricultural area.

### 6. Discussion and Conclusions

This study highlights the need to incorporate water within economic assessments of climate change impacts, especially in a country like Egypt whose current and future socio-economies are strongly linked to the natural resource base. When addressing Egypt's vulnerability to climate change, the country can not be looked at in isolation. International markets play a significant role in defining Egypt's vulnerability to climate change as was shown especially by the UKMO and *LOWEND* scenarios. The capacity to import food and the quality and marketability of high valued export crops are important issues for Egypt. Also, how it copes with its rising population in light of scarce resources will continue to be a challenge for this country.

Three of the four GCM models highlight the sensitivity of the Nile Basin to climate variability—especially precipitation—by predicting significant increases in Nile flows. This is consistent with what other researchers (Nemec and Shaake 1982; Sutcliffe and Parks 1987) have found for the Nile Basin. However, there is much uncertainty regarding GCM's ability to model precipitation. The large uncertainties motivate the need to continue research within the atmospheric sciences, with the goal of improving our understanding of the impact of anthropogenic green house gases on the hydrologic cycle.

The inclusion of water within the BLS plays a significant role in defining the socio-economic development path that the model computes for Egypt. Although only one of the GCM scenarios predicted decreased Nile flows, the fact that the other scenarios gave significant increases served to highlight the role of water in the development path. The structural makeup of the economy, especially the agricultural sector, is significantly different when water is included in the model, whether there is a decrease or increase in its availability. Also, international market prices are likely to play a significant role in the development and structure of the future economy of Egypt—regardless of climate change. Figure 16 and Table 16 includes 3 select GCM scenarios and shows the relative change in crop production to the 2060 pessimistic baseline. This figure is shown to highlight the role of water and international markets on the economy of Egypt.

Table 16 Percentage change of macro-indicators for the 3 selected GCM scenarios relative to the 2060 pessimistic baseline.

Indicator	GFDL	GFDL	LOWEND
	Water not Modeled	49 Milliards	77 Milliards
GDP Agriculture	+1.5	-18.0	-16.3
GDP Non-Agriculture	+0.6	+0.8	+7.0
GDP/ Capita	+0.5	-2.1	+3.6
Ag's share of GDP	+0.8	-16.4	-19.3
Ag Commodity Import	-8.4	+26.3	+30.5
Non-Ag Commodity Export	-70.0	+87.0	+23.0
World Market Prices*	+14%	+14%	-17.0
Number of agriculture laborers	-6.0	-6.2	-8.9
Parity	+25.4	-3.2	-21.1

\* World market prices are given as the sum of the relative changes from 1990 (summation of columns in Table 6). Parity: ratio of the agricultural GDP per capita of agricultural wage earner to the non-agricultural GDP per capita of the non-agricultural wage earner. (Ag)riculture.

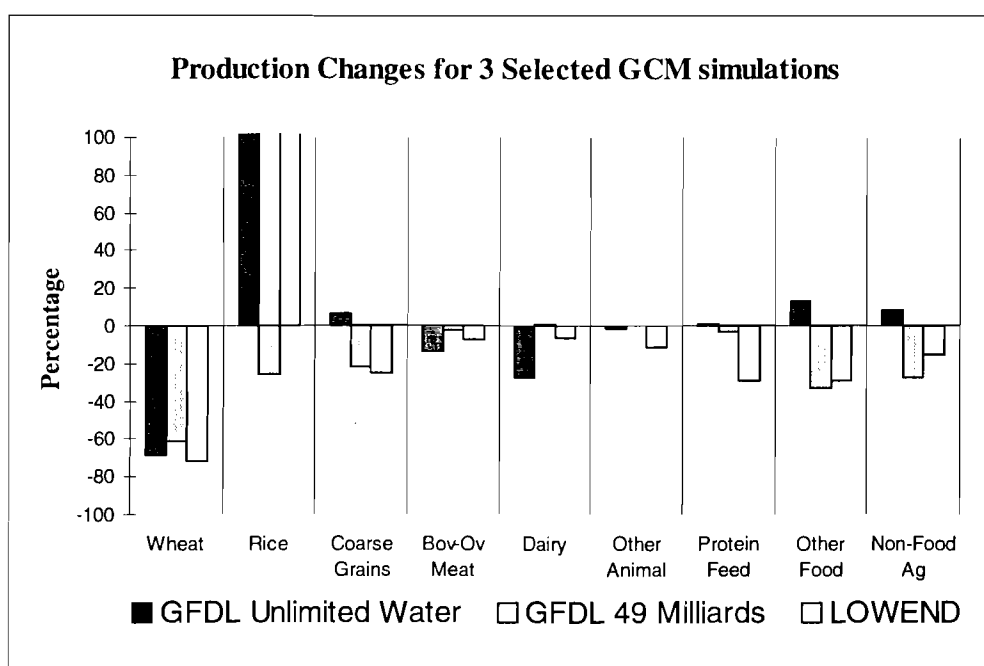

Figure 16. Change in domestic crop production for 3 of the GCMs. The *GFDL Unlimited Water* scenario removes water as a constraint (unlimited) but applies yield impacts due to climate change. *GFDL 49 Milliards* is the same *GFDL* scenario with water. The *LOWEND* scenario includes 75 milliards of annual water.

The *GFDL* scenario with water (49 milliards of annual availability) and water removed as a constraint (i.e. not modeled) showed a significant impact on crop production patterns (Figure 16) and differences in the macro indicators. When water is not modeled (effectively treating it as an unlimited resources), the *GFDL* solution gave a significant increase in rice production and increases in coarse grains, other food and non-food agriculture; while dairy and meat production dropped. The addition of water constraints produced an opposite result—rice, coarse grains, other food and non-food agriculture production decreased, while dairy and meat production remained practically unchanged. Imports to meet domestic demand were increased when water was included as a constraint in

the GFDL scenarios. Interestingly, the *GFDL 49 milliard* scenario showed a large increase in non-agricultural export compared to the *GFDL water not modeled scenario*. This situation occurred because, under the *GFDL 49 milliard scenario*, resources were moved into the non-agricultural sector for export earnings for the financing of agricultural imports.

Two different forces drove the decline in agricultural GDP between the *LOWEND* (-16.3%) and the *GFDL 49 milliards* scenarios (-18.0%). The decline in agricultural GDP under the *LOWEND* was primarily due to lower international agricultural commodity prices, which enable the import of inexpensive agricultural commodities. Investments were diverted away from agriculture and into the non-agricultural sector which decreased agriculture's share of total GDP. The decline in agricultural GDP under the *GFDL 49 milliards* scenario was primarily due to reductions in yields and reduced Nile flows—decreasing agriculture's output. The two different scenarios (*LOWEND* and *GFDL 49 milliards*) achieve the same macro effect of reducing agricultural output; but achieve this through two different mechanisms— one is low international prices and the other is decreased production.

Despite the dramatic reduction in the GDP of the agriculture sector under the *LOWEND* scenario (-16.3%), the *LOWEND* showed the largest increase in overall GDP (+3.6%). This was primarily due to lower international market prices for commodities combined with moderate yield impacts. Despite the large increases in available Nile water, investments and resources were diverted towards the non-agricultural sector, as a large portion of the increased available water remained unused. Exports of non-agricultural goods increased, which helped to finance increased agricultural imports to meet domestic demands. Parity—a measure of equity between an agricultural and non-agricultural wage earner—drops significantly (-21.1%), pointing to a deterioration in the agricultural wage earner's standard of living. Although there are fewer agricultural laborers which experience the decline in parity in the *LOWEND* scenario (-8.9%).

Because of the time horizon of climate change, multiple baseline scenarios should be generated to offer a broader spectrum of possible development paths and adaptation options. The optimistic and pessimistic scenarios defined in this study outline a significantly different, but realistic picture of possible socio-economic conditions in Egypt. The difficulty comes in simply analyzing the results, as the data associated with multiple scenarios can become overwhelming.

There are still many important issues for Egypt which have been overlooked in this study and are candidates for future research. First is the role of upstream countries and their use of Nile waters. Reductions in available water to Egypt due to increased use by Ethiopia, Sudan, or the other basin countries were not considered; but could be important if these countries experience improved economic growth.

As noted, the rural poor without access to agricultural production resources like land, water, fertilizer, seed, etc. are at the greatest risk to climate change. This points to the need to disaggregate the BLS model into income and social classes to capture these types of market effects. Without this distinction, there can be little *quantitative* analysis on the impact of climate change on rural regions in developing countries.

Technological improvements of the irrigation system were not incorporated due to a lack of information regarding investment costs. This is a critical issue for Egypt should Nile waters decrease. How they should proceed is unclear given the myriad of pressing social needs.



## References

- Adams, R., Rosenzweig, C., Peart, R., Ritchie, McCarl, B., Glycer, D., Curry, B., Jones, J., Boote, K., and Allen, H. (1990) 'Global Climate Change and US Agriculture'. *Nature*. Vol. 345 17 May, 1990.
- Akong'a, J. Downing, T. Konijn, N. Mungai, D., Muturi, H. and Potter, H. (1989) 'The Effects of Climatic Variations on Agriculture in Central and Eastern Kenay'. In (Eds. Parry, M. Carter, T., and Konjin, T.) 'The Impact of Climatic Variations on Agriculture Vol. 2: Assessments in Semi-Arid Regions'. Kluwer Press, The Netherlands.
- Aliboni, R., Dessouki, A., Ibrahim, S., Luciano, G., and Padoam, P. (1984) 'Egypt's Economic Potential'. Bill and Sons Ltd. Worcester Great Britian
- Beven, K. (1989) 'Changing Ideas in Hydrology - The Case of the Physically-Based Models', *J. of Hydrol.*, 105, 157-172.
- Biswas, A. (1993) 'Land Resources for Sustainable Agricultural Development in Egypt'. *AMBIO* Vol 22 No. 8 Dec.
- Bowes, M. and Crosson, P. (1993). 'Consequences of Climate Change in the MINK Region'. In (Ed. Rosenburg, N., 'Towards an Integrated Impact Assessment of Climate Change: The MINK Study'). Kluwer Academic Publisher.
- Broadus, J., J. Milliman, S., Edwards, A., and Gable, F. (1986) 'Rising Sea Level and Damming of Rivers: Possible Effects in Egypt and Bangladesh'. In *Effects of Changes in Stratospheric Ozone and Global Climate, Volume 4: Sea Level Rise*, ed. J. Titus. Washington, D.C.: United Nations Environment Programme and US Environmental Protection Agency.
- Carnell, C. and Chapra, S. (1988) 'Numerical Method for Engineers with Personal Computer Applications' McGraw Hill, New York.
- Carter, T., Parry, M., Harasawa, H., and Nishioka, S. (1994) 'IPCC Technical Guidelines for Assessing Climate Change Impacts and Adaptations'. Working Group II of the Intergovernmental Panel on Climate Change.
- Chow, V.T., D. R. Maidment, and L.W. Mays (1988) 'Applied Hydrology', McGraw Hill, New York.
- Crosson, P. (1993) 'Impacts of Climate Change on the Agriculture and Economy of the Missouri, Iowa, Nebraska, and Kansas (MINK) Region'. in (Eds. Kaiser, H. and Drennen, T.) *Agricultural Dimesnions of Global Climate Change*. St. Lucie Press Fl.
- Darwin, R., Tsigas, M., Lewandrowski, J. and Raneses, A., (1995) 'World Agriculture and Climate Change: Economic Adaptations'. Agricultural Economic Report No. 703, US Department of Agriculture.

- Dooge, J.C.I. (1992) 'Hydrologic Models and Climate Change'. *J. of Geophysical Res.*, 97(D3): 2677-2686.
- Eagleson, P.S. (1978) 'Climate Soil and Vegetation: Parts 1-7'. *Water Resour. Res.*, 14(5): 705-776.
- El-Din, G., (1993) 'It's no bed of flours, say local wheat millers'. *Egyptian Gazette (Cairo)*, 3 October.
- El-Raye, M. (1991) 'Responses to the Impacts of Greenhouse-Induced Sea Level Rise on Egypt'. In *Changing Climate and the Coast, Volume 2: West Africa, the Americas, the Mediterranean Basin, and the Rest of Europe*. ed. J. Titus. Washington, D.C.: United Nations Environment Programme and US Environmental Protection Agency.
- Fischer, G., Froberg, K., Keyzer, M. and Parikh, K. (1988) 'Linked National Models: A tool for International Food Policy'. Kluwer Academic Press. IIASA.
- Franchini, M. and M. Pacciani (1991) 'Comparative Analysis of Several Conceptual Rainfall-Runoff Models'. *J. of Hydrol.*, 122, 161-219.
- Gleick, P.H. (1987) 'The Development and Testing of a Water Balance Model for Climate Impact Assessment: Modeling the Sacramento Basin'. *Water Resour. Res.* 23(6): 1049-1061.
- Gleick, P., (1991) 'The Vulnerability of Runoff in the Nile Basin to Climate Changes'. *The Environmental Professional*, Vol.13, 66-73.
- Golubev, G. (1993) 'Sustainable Water Development: Implications for the Future'. *Water Resources Development*. Vol. 9, No. 2.
- Hansen, B. (1991) 'The Political Economy of Poverty, Equity and Growth: Egypt and Turkey'. New York, Oxford; Oxford University Press.
- Hazell, P. and Norton, W. (1986) 'Mathematical Programming for Economic Analysis in Agriculture'. Macmillan Publishing Co. New York.
- Humpries, J. (1991) 'The Egyptian Agricultural Sector Model (EASM): A Users Guide'. US Bureau of Reclamation/Egyptian Ministry of Public Works and Water Resources.
- Hurst, H. (1952) 'The Nile' Constable and Company. London
- International Benchmark Sites Network for Agrotechnology Transfer (IBSNAT) Project (1989). DSSAT V2.1 Dept. of Agronomy and Soil Science. College of Tropical Agriculture and Human Resources. University of Hawaii. Honolulu.
- Kaczmarek, Z. (1990) 'On the Sensitivity of Runoff to Climate Change'. IIASA working paper, WP-90-58, Laxenburg, Austria.

- Kaczmarek, Z. and Krasuski, D. (1991) 'Sensitivity of Water Balance to Climate Change and Variability'. IIASA WP-91-047. Laxenburg, Austria.
- Kaiser, H., Riha, S., Wilks, D. and Sampath, R. (1993) 'Adaptation to Global Climate Change at the Farm Level'. in (Eds. Kaiser, H. and Drennen, T.) *Agricultural Dimensions of Global Climate Change*. St. Lucie Press Fl.
- Kane, S., Reilly, J., and Tobey, J. (1992) 'An Empirical Study of the Economic Effects of Climate Change on World Agriculture'. *Climatic Change* **21**: 17-35
- Keller, J. (1992) 'Implication of Improving Physical Water Use Efficiency for Agricultural Water Conservation. prepared paper for: Roundtable on Egyptian Water Policy, Alexandria, Egypt. Apr. 1992.
- Kite, G. (1981) 'Recent Changes in the Level of Lake Victoria'. *J. of Hydrologic Sciences*. 26.23 9/81.
- Kundzewicz, Z. and Somlyódy, L. (1993) 'Climatic Change Impact on Water Resources - a Systems View'. IIASA WP-93-30. Laxenburg, Austria.
- Kulshreshtha, S., (1993) 'World Water Resources and Regional Vulnerability: Impacts of Future Changes'. RR-93-10, IIASA, Laxenburg, Austria.
- Leemans, R. and W.P. Cramer (1991) 'The IIASA Database for Mean Monthly Values of Temperature, Precipitation, and Cloudiness on a Global Terrestrial Grid'. RR-91-18, International Institute for Applied Systems Analysis, Laxenburg, Austria.
- Lettenmaier, D. and Gan, T. (1990) 'Hydrologic Sensitivities of the Sacramento-San Joaquin River Basin, California, to Global Warming'. *Water Resources Research*. 26(1). pp. 29-86.
- Liverman, D. (1986) 'The Response of a Global Food Model to Possible Climate Changes: A Sensitivity Analysis'. *J. of Climatology* Vol. 6, 355-373
- McCabe, G.J. Jr. and D.M. Wolock (1992) 'Effects of climatic change and climatic variability on the Thornthwaite moisture index in the Delaware river basin'. *Climatic Change* (Feb), 143-159.
- Miller, J., and Russell, G. (1992) 'The Impact of Global Warming on River Runoff'. *Journal of Geophysical Research*. Vol 97. No. D3. pp. 2757-2764.
- Mimikou, M.A. and Y.S. Kouvopoulos (1991) 'Regional climate change impacts: I. Impacts on water resources'. *Hydrol. Sci. J.*, 36(3): 247-258.
- Nash, L. and Gleick, P. (1993) 'The Colorado River Basin and Climate Change: The Sensitivity of Streamflow and Water Supply to Variations in Temperature and Precipitation'. USEPA. EPA230-R-93-009.

- Nemec, J. and J. Schaake (1982) 'Sensitivity of Water Resource Systems to Climate Variation'. *J. Sci. Hydro* 27(3): 327-243.
- Niemann, J., Strzepek, K., and Yates, D. (1994) 'The Impact of spatial and Temporal Data on a Climate Change Assessment of Blue Nile Runoff'. IIASA WP-94-44. Laxenburg Austria.
- Nordhaus, W. (1994) 'Managing the Global Commons'. MIT Press, Cambridge MA.
- O'mara, G. (1994) 'Reformulation of the Egyptian Agricultural Sector Model'. (unpublished paper), International Institute for Applied Systems Analysis.
- Onyeji, C. and Fischer, G. (1994) 'An Economic Analysis of Potential Impacts of Climate Change in Egypt'. *Global Environmental Change* Vol 4 No. 4
- Parry, M., Carter, T. and Konijn, N. (1988 a.) 'The Impact of Climatic Variations on Agriculture Vol. 1: Assessments in Cool Temperature and Cold Regions'. Kluwer Press, The Netherlands.
- Parry, M., Carter, T. and Konijn, N. (1988 b.) 'The Impact of Climatic Variations on Agriculture Vol. 2: Assessment in Semi-Arid Regions'. Kluwer Press, The Netherlands.
- Piper, B.S., Plinston, D.T. and Sutcliff, J.V., (1986) 'The Water Balance of Lake Victoria'. *Hydrological Sciences* 31(1):25-37.
- Postel, S. (1992) 'Last Oasis'. The Worldwatch Environmental Alert Series. W.W. Norton & Co.
- Priestly, C. and Taylor, R., (1972) 'On the Assessment of Surface Heat Flux and Evaporation Using Large Scale Parameters'. *Mon. Weather Rev.*, vol. 100, pp. 81-92, 1972.
- Reibsame, et al. (1996) 'Complex River Basins'. In (Eds. Strzepek, K., and Smith, J.) 'As Climate Changes, International Impacts and Implications'. Cambridge University Press.
- Rosa, C. and Yates, D. (1994). 'Addressing the Issue of Uncertainty within the Egyptian Agricultural Sector'. WP-94-97. IIASA, Laxenburg Austria.
- Rosenburg, N.; editor (1993) 'Towards an Integrated Impact Assessment of Climate Change: The MINK Study'. Kluwer Academic Publisher,
- Rosenzweig, C. and Iglesias, A. eds. (1993) 'Implications of Climate Change for International Agriculture: Crop Modeling Study'. US Environmental Protection Agency: Washington D.C.
- Rosenzweig, C., Parry, M., and Fischer, G. (1995) 'Climate Change and Global Agriculture' in (Eds. Strzepek and Smith) 'As Climate Changes'. Cambridge Press, Cambridge England.

- Rosenzweig, C. and Parry, M. (1993) 'Potential Impacts of Climate Change on World Food Supply: A Summary of a Recent International Study'. in (Eds. Kaiser, H. and Drennen, T.) *Agricultural Dimensions of Global Climate Change*. St. Lucie Press Fl.
- Salas, P. (1993) 'Analysis and Modeling of Hydrologic Time Series'. In: Maidment, D.R. (Ed.), *Handbook of Hydrology* McGraw-Hill Book Company, New York City, New York, 19.1-19.72.
- Scheraga, J. Leary, N., Goettle, R., Jorgenson, D. and Wilcoxon, P. (1993) 'Macroeconomic Modeling and the Assessment of Climate Change Impacts'. In (Eds. Kaya, Y. , Nakicenovic, N., Nordhaus, W. and Toth, F. ). *Costs, Impacts, and Possible Benefits of CO<sub>2</sub> Mitigation*. IIASA Collaborative Paper, CP-93-2, pp. 107-132.
- Shahin, M. (1985) 'Hydrology of the Nile Basin'. *Developments in Water Science No. 21*. Elsevier Pub. The Netherlands.
- Shaw, E. (1982) 'Hydrology in Practice'. Van Nostrand Reinhold, United Kingdom.
- Strzepek, K., Niemann, J., Somloyody, L, and Kulshreshtha, S. (1994 a) 'A Global Assessment of National Water Vulnerabilities: Sensitivities, Assumptions and Driving Forces'. forthcoming, IIASA, Laxenburgh, Austria..
- Strzepek, K., Onyeji, C., Saleh, M., and Yates, D. (1994 b). 'An Assessment of Integrated Climate Change Impacts on Egypt'. WP-94-48. IIASA, Laxenburg Austria.
- Strzepek, K. and Saidin, S (1994) 'A GIS Assessment of Sea-Level Rise on the Nile Delta'. WP-94-48. Laxenburg, Austria.
- Sutcliffe, J. and Parks, Y. (1987) 'Hydrologic Modeling of the Sudd and Jongeli Canal'. *J. of Hydrologic Science*. 32/2, 6/1987.
- Taylor, L. (1979) 'Macro Models for Developing Countries'. McGraw Hill New York.
- Thom, A.S. and Oliver H.R. (1977) 'On Penman's Equation for Estimating Regional Evaporation'. *Q.J.R. Meteorol.Soc.*, vol 193 p. 345-357.
- Vloedveld, M. and Leemans, R. (1993) 'Quantifying feedback processes in the response of the terrestrial carbon cycle to global change: the modeling approach of IMAGE-2'. *Wat. Air Soil Pollut.* **70**, 79-141.
- Willians, G., Fautley, R., Jones, K., Stewart, R., and Wheaton, E. (1988) 'Estimating the Effects of Climatic Change on Agriculture in Saskatchewan, Canada'. In (Eds. Parry, M. Carter, T., and Konjin, T.) 'The Impact of Climatic Variations on Agriculture Vol. 1: Assessments in Cool Temperature and Cold Regions'. Kluwer Press, The Netherlands.
- WMO (1970) World Meteorological Organization. Data derived from reports on Lakes of the Nile Basin.

Yates, D. (1994) 'WatBal: An Integrated Tool for Climate Change Assessment on River Basins'. WP 94-48. IIASA, Laxenburg, Austria.

Zeineldin, A. (1986) 'The Egyptian Economy in 1999: An input-output Study'. *Economic Modeling* 3(2): 140-146.