

**Research-Report
RR-76-2**

**THE IIASA ECOLOGY
PROJECT:
A STATUS REPORT**

JULY 1975

Research Reports provide the formal record of research conducted by the International Institute for Applied Systems Analysis. They are carefully reviewed before publication and represent, in the Institute's best judgment, competent scientific work. Views or opinions expressed herein, however, do not necessarily reflect those of the National Member Organizations supporting the Institute or of the Institute itself.

**International Institute for Applied Systems Analysis
2361 Laxenburg, Austria**

Preface

The Ecology Project commenced work in 1973 with the initial and continuing goal of developing a coherent science of ecological management. The products of our research can be divided into three groups: conceptual, applied, and case studies. To give the project focus, we chose to analyze in detail specific regional case studies. Each of these examples has all the ingredients of a large class of problems that together comprise the global problems of resource management for food, fiber, energy, and cultural needs of societies.

The following report provides an overview of the work of this project through July, 1975, and a summary of our current thinking on future directions and formats of ecological and environmental research at IIASA. The major content of the report is comprised of a description of the case studies which have formed the core of the past two years' efforts.

Table of Contents

	<u>Page</u>
Preface.....	iii
I. INTRODUCTION AND OVERVIEW.....	1
II. INSTITUTIONAL NETWORKING.....	11
III. CASE STUDIES.....	15
3.1 A Case Study of Forest Ecosystems/Pest Management.....	15
3.2 Salmon Watershed Management Case Study.....	45
3.3 Regional Energy/Environment Case Study.....	63
Part I. Integrated Energy System Modelling and Policy Analysis: A Description of an IIASA Research Program.....	64
Part II. Current Status of the Comparative Regional Energy/Environment Study.....	85
3.4 Human Impact on High Mountain Regions: Obergurgl Case Study.....	97
3.5 Ecological Models of River Basin Water Quality.....	99
3.6 Global Monitoring.....	113
3.7 Decision Analysis Applications in Ecology.....	119
Appendix 1: Papers by Members of the IIASA Ecology Project.....	121

I. INTRODUCTION AND OVERVIEW

C.S. Holling and C. Walters

1. What We Intended

The Ecology Project has been operational at IIASA since 1973. The project's initial goal has been to determine how far we could go in developing a coherent science of ecological management--i.e., concepts, methodology, and case studies. This goal requires the blending of the techniques and concepts of ecology, modelling, mathematical analysis, optimization, and decision theory. To give the project focus, we chose to analyze in detail specific regional case studies, choosing problems that had a universal character, adequate but incomplete data, outside collaborators, a troubled management history, and that intersected the interests of other IIASA scientists.

Since IIASA was in its initial stage in 1973, we believed the first priority should be to put something in its place as quickly as possible. Once this had been completed, we hoped that this would provide a base on which to move onto larger, more global issues, and to tackle, more directly, issues of multi-national cooperation. It is these possibilities that make IIASA a unique international experiment. We are at that point now.

2. What We Did

Such an approach could easily become an irrelevant but pleasant exercise in methodology, only appropriate (if at all) to specific cases. Although the case studies had labels as, for example, forest/spruce budworm management, Pacific salmon and water management, and human impact on high mountain regions, they were not chosen because of their obvious and transcendent global significance. Do many people, after all, care about forests and budworm, or salmon, or alpine regions? The point is that each of the specific examples has all the ingredients of a large class of problems that together comprise the global problems of resource management for food, fiber, and cultural needs of societies.

Hence the "products" of our research can be divided into three groups:

1. Conceptual

General theoretical and comparative analyses of these resource management systems to: a) identify their properties of

stability and resilience; and b) to design policies that are "robust," that is, less sensitive to the unexpected and the unknown;

2. Applied

Methodology for: a) descriptive and prescriptive analyses of renewable resource problems; b) guide books for environmental impact assessment; c) policy design and evaluation; and d) descriptive modelling; and

3. Case Studies

Detailed presentation of the results of each of the case studies in a form that can lead to implementation (the acid test).

3. Present Status of Case Studies

A Case Study of Forest Ecosystems/Pest Management

(W.C. Clark, C.S. Holling, D.D. Jones, Rashid)

The first case study (that began in September 1973) concerns a problem of ecosystem/pest management in the softwood forests of Eastern North America. It was chosen because it represented a classic example of a large class of pest problems; good data were available; it intersected the interests of other IIASA projects and scientists; and managers concerned with the problem were eager to cooperate. It thus provided an effective vehicle with two objectives: a) to apply ecological modelling, optimization, policy design and evaluation, and decision theory techniques to a significant ecology problem; and b) to explore the value of IIASA for cross-project and cross-institutional collaboration.

An extensive monograph on the analysis stage will be completed by October 1975, co-authored by scientists from IIASA, from the Institute of Resource Ecology, University of British Columbia, and from the Maritimes Forest Research Centre, Department of the Environment (Environment Canada). Cooperation among these three institutions has persisted even though most of the members of the original IIASA project groups have returned to their home institutions--i.e., University of British Columbia, Harvard University, and Stanford University. This experiment points to a major value of IIASA--namely, the catalyzing of a cross-project study within IIASA, followed by continuing working collaboration among a network of IIASA alumni. The post-IIASA program of the forest/budworm study is almost totally funded by agencies other than IIASA.

At present, plans are being prepared for implementation of the study in New Brunswick, with the formal agreement of officials of Environment Canada from the Deputy Minister to regional authorities in New Brunswick.

Salmon/Watershed Management Case Study (S. Buckingham,
R. Hilborn, C. Walters, M. Gatto, S. Rinaldi, F.E.A. Wood)

The first phase of analysis was initiated at IIASA in September 1974, and will be completed by December 1975, with implementation envisaged two to three years thereafter. This salmon study is more complex than the budworm study for two reasons. First, there are a larger set of societal effects--i.e., power, regional development, recreation and fisheries. Second, there is a major international component, since Pacific salmon are jointly harvested by Canada, Japan, USSR, and USA. The first phase of the salmon study has concentrated only on problems of regional management. Some of the efforts were similar to those expanded for the budworm study--e.g., the ecological modelling, analysis, and optimization. Significantly different steps were taken in exploring ways of dealing with uncertain information, with hierarchical management issues on the local, regional, provincial, and national levels, and with adaptive management. Through workshops, effective cooperation has developed with Canadian Federal fisheries scientists and, more recently, with Soviet fisheries specialists.

Rinaldi and Gatto are developing a related study starting from the salmon study that will show how this approach can be applied to more complex fisheries; as a test case, they are using a multi-species, multi-fleet fishery on the Gulf of Venezuela.

Regional Energy/Environment Study (W. Foell, R. Dennis,
K. Ito, and members of other IIASA projects)

This case study began in January 1975. It was initiated jointly by the Energy and the Ecology Projects in order to explore the ecological, environmental, and land use consequences of different energy developments and policies. The study is concentrating on three regions--in Wisconsin (USA), France, and the German Democratic Republic, in order to compare existing patterns of energy use and supply as well as alternative methods for forecasting, planning, and policy making. From this comparison, alternate energy policy strategies will be developed for each of the regions, and their consequences assessed from various perspectives using indicators of environmental impact, energy use efficiency, etc.

A strong core group has developed at IIASA involving scientists from the Ecology, Energy, Methodology, Bio-Medical, and Industrial Systems Projects. Firm working arrangements have been made with the appropriate research groups in Wisconsin (USA), France, and the German Democratic Republic.

The energy/environment study was designed as the next logical step following the Budworm and the Salmon studies, and is an effective working link with three institutions from

national member organizations (NMO) from non-socialist and socialist countries. This planned sequential effort has led to an effective program.

Human Impact on High Mountain Regions: Obergurgl Case Study (S. Buckingham, R. Hilborn, G. Margreiter, C. Walters)

This is less a case study to develop new techniques and concepts than it is an exercise of communication, transfer, and conflict resolution. The study began in January 1974, and focussed on the Obergurgl region of Austria. A series of workshops were held with scientists from Man-and-Biosphere (MAB) projects, with regional government officials, and businessmen and villagers from Obergurgl. That study is a microcosm of interaction of economics, land and development that, in a particularly vivid form, has led to close links among scientists, government officials and villagers for the development of specific regional plans. The techniques used and the results obtained have been exchanged, and IIASA's role has been completed with the last workshop held in May 1975.

Ecological Models of River Basin Water Quality (H. Stehfest, R. Soncini, S. Rinaldi, J. Gros, T. Ostrom)

Using data from the Rhine River in the Federal Republic of Germany, this study has been developing a series of approaches for comparing alternative models that could be applied to the establishment of control policies to meet water quality standards. The study has shown that simple models (e.g. Streeter-Phelps) result in essentially the same prescriptive recommendations as complex ecological models, and attention has shifted toward problems of optimization and conflict resolution in large river basins. The study will continue into 1976; the final output is expected to be a book.

4. What We Didn't Do

Our initial objective of putting something in place as quickly as possible had a price attached to it. Superb interaction evolved between Ecology and other IIASA projects--Methodology, Energy, and, in particular Urban. Cross-cultural and international interactions within IIASA have not been realized; yet it is these activities where the major potential of IIASA lies. This was made all the worse because the perception has developed that the work was done by Canadians on purely Canadian problems. In reality, the scientists from the Project have come from the FRG, Italy, Japan, USSR, and the USA as well as from Canada. We are deeply involved in a water quality study of the Rhine River, and a cross-comparison of regional energy systems

in France, the GDR, and the USA. During the next few years, we must concentrate from a regional base on more global problems, with emphasis switched to international linking and cooperation; this will require persons of the highest skills in scientific diplomacy.

5. What We Propose Should Be Done

We propose a reorganization of these activities in the following three ways:

- 1) Identification of activities, not as a separate project but as a series of task groups that, combined with other activities, would form a larger area of resources and environment. This area should have more permanent leadership, with the task groups coming and going as needs warrant;
- 2) Development of a decentralized network of cooperators and institutes that would either tie into the work of the IIASA task group or use IIASA as a communication, workshop, and information center; and
- 3) Coordination of this network by at least two individuals who would act as "scientific diplomats" and would nurture, develop, and reinforce the network. This will require immense experience, planning, time, and travel since all the forces will tend to dissolve the network.

The specific tasks envisaged are as follows:

Pest Management: The budworm study can shortly move to implementation. That is important since it is widely recognized that the spraying policy of the past twenty-three years has left the forests of New Brunswick ripe for an outbreak more extensive and intensive than any in the past. Implementation is a non-trivial problem: twenty-six government agencies, three provinces, one state, two nations, forest industry, and recreational groups are all involved. In the first phase of implementation, the center and control must be shifted to our New Brunswick collaborators, since they alone know the setting, the institutions, and the actors. By December 1975, we expect to have completed the following steps:

- 1) Transfer and implementation of existing models, techniques, and data to the New Brunswick group;
- 2) Holding of an initial workshop with the New Brunswick group to test the effectiveness of the transfer and to help plan the succeeding steps;
- 3) Holding of a workshop (the first of a series) to be organized by the New Brunswick group and involving provincial and industrial people, that would start a mutual educational process which, we hope, will lead to the beginning of new management approaches; and

- 4) Establishment of a "mini-network" of collaborating centers--e.g. at Harvard University, the Institute of Resource Ecology, and at IIASA--that would participate in the implementation process.

Parelleling the workshop series and feeding into it will be an institutional and decision-analysis study of the kind strongly recommended by the Ecology Project Advisory Committee. (This will involve Raiffa, Bell, and Fiering from their base at Harvard University.)

It will not be possible to plan any further activities until these steps are completed. However, it is proposed that IIASA hold at least one major conference on resource management in 1976 that would bring together groups from the FRG, GDR, Japan, Poland, USSR, and USA which are facing similar problems, in order to explore possibilities of a broader international transfer.

Oceanic Fisheries: The work being done by Walters, Hilborn, Buckingham, Gatto, and Rinaldi on modelling and policy analysis of the salmon problem will be transferred to the University of British Columbia, in order to consolidate and expand those analyses set in motion at IIASA. This can best be done with a close and continual working relation with fisheries scientists and fisheries managers; cooperation of this type has already been obtained from personnel of Environment Canada in British Columbia. There will be a series of intense working sessions with scientists and managers that will be consolidated by mid-1976 into a major workshop emphasizing communication of existing developments. This workshop would aim at participants from Canada, Japan, and the USSR and USA, and would be co-sponsored by IIASA, Environment Canada, and the University of British Columbia.

After this transfer has been completed, a new opportunity opens for IIASA to initiate the next step in which emphasis would be more broadly placed on oceanic fisheries and the establishment of an international network of cooperating institutes and individuals. This activity would require world fisheries data. Attempts have been made (e.g. by the Food and Agriculture Organization (FAO)) to develop a common data bank that could be used to explore regional and global questions of fisheries resources and management. These efforts have not been successful mainly because of their institutional formality. IIASA, as a unique institution, has the potential to break through this problem by bringing together informally working scientists to discuss the issues, to identify the political constraints, and to identify minimum data needs. This could be done in a low-key way that might avoid some of the more extreme suspicions and conflicts that have previously emerged.

Wilimovsky (who has wide contacts with scientists in both developing and developed countries) has agreed to initiate the first steps in such an effort. The first step will capitalize on the opportunity provided by the Pacific Science Congress that

will meet in Vancouver in August 1975. A dozen key fisheries scientists will be brought together, informally, to raise the issue and to explore its feasibility. If it appears reasonable to proceed, Wilimovsky, Gulland (or an alternate from FAO), and P. Moiseev (USSR) will meet at IIASA for one week in early October to prepare a definitive working plan for the approval of the IIASA Council in November. The implementation of this plan is likely to require a six to eight month period during which small workshops will be held to identify problems and to determine the questions that should be asked and the actual needs. Subsequent steps could be a pilot study of a reasonably simple region with a number of fisheries and a number of nations exploiting these fisheries. This would provide an identification of data needs, and the determination of how these data could be acquired, stored and used. Data use could be of two kinds: a) as a basis for comparison of various theoretical and modelling efforts of the type conducted in the salmon study; and b) as a source of information for real time regional management.

This proposal represents a probing experiment to see if IIASA can perform a "Pugwash" conferencing activity that would effectively short circuit some of the impossible barriers encountered by FAO and by other United Nations organizations. It has the potential to address an important scientific issue-- namely how much information is needed and for what purpose. For example, the experience gained from intensive management of fisheries that use sophisticated information suggests that the use of richer information yields only modestly improved management approaches as opposed to the use of simple and primitive data sources. The value of information in an uncertain world is of considerable interest to other groups at IIASA; their experience and techniques could well be brought to bear on this problem.

Comparative Integrated Regional Energy/Environment Systems:
This study (that began in 1975) will continue at least until 1976 and will probably be followed up by a third year (1977). It has already established very effective cross-project working relations, and has had greater success than the Budworm and the Salmon case studies in developing effective international relations with the appropriate groups in Wisconsin (USA), France, and the German Democratic Republic. This project is another experiment in networking, with IIASA at the center of a small network of collaborating institutes. The network concept will be continued in 1976 and 1977; its exact form will depend on which scientists will remain in residence at IIASA and which will conduct the research at their home institutions. In 1976 and 1977, the research effort will be directed jointly by IIASA and the University of Wisconsin. During this period, Foell will continue to play a major role from one or the other of these bases.

In 1976 a follow-up study (to the first three regions studied in 1975) will focus on three additional regions that differ greatly in physical, socio-economic, and institutional

planning characteristics. One of these regions will be a developing country. In addition to continuing the innovative research format of 1975, the 1976 program will be further designed to examine the mechanisms of inter-regional transferability of the the concepts and methodologies studied during 1975. (This will have already been discussed in a preliminary manner at the IIASA regional energy/environment workshop in November 1975.) The 1976 program will evaluate the "research format" used in this project as a more general systems analysis tool for bridging the gap between systems analysis and policy design.

By 1977, there should emerge a clearer picture of the poorly understood relationships between the socio-economic and the energetic characteristics of regional energy systems. Based upon the study of five to seven well-chosen regions with greatly differing characteristics, we should begin to develop an array of tools (e.g. modelling techniques, data basis, communication and decision tools) for more effective management of regional energy/environment systems. The results of these studies will be documented in a series of monographs containing case study descriptions and the hierarchy of methodologies, with emphasis on their applicability under different conditions, e.g. in a developing country, a centrally-planned economy.

Environmental Management of Information: In September 1975, Matthews of Massachusetts Institute of Technology (MIT) will initiate a study of environmental management. The United Nations Environmental Programme (UNEP) will be a key collaborator in the study, and additional working links will be established with other NMO institutions.

Environmental Impact Assessment: One of the primary intents in this effort is to lay out a hierarchy of impact assessment methods that proceed from simple and qualitative, to complex and highly quantitative. Along this spectrum would be an increase in the amount of knowledge available and in the resources of expertise and computers. From our present experience, we have found that there are techniques of qualitative modelling that are simple and less demanding of expertise, data, and resources. Although these techniques do not provide highly detailed assessment information, they are responsive to qualitative questions that might, in fact, be the more important ones. These simpler techniques are more practical, and are within the scope of reality of existing impact assessment teams in both developing and developed countries. This activity is totally supported by a grant to IIASA from UNEP.

We have a rich array of models of regional environmental problems--e.g. fisheries, forestry, wildlife and regional development. These models can be the testing bed for the development of key environmental indicators and environmental impact

assessment procedures. A group of scientists from Argentina, Canada, the UK, the USA and Venezuela have agreed to work together to develop a series of handbooks on environmental impact assessment procedures. Implementation of this activity will require approximately two years, and will proceed in four stages. The first three stages will be the analyses and development of indicators and methodologies. At the end of each of the stages, a workshop will be held involving the participating scientists in order to consolidate developments to that point, to identify new activities and to assign corresponding responsibilities. Thus there will be a revolving set of papers that will gradually move to consolidation, and will form the briefing document for a major conference at IIASA in which practitioners of environmental impact assessment will be brought together to critique the effort. With that critique, the documents will be rewritten as a series of handbooks for environmental impact assessment.

Conceptual and Methodological Issues (Ecological Policy Design): In 1974-1975 there has emerged at IIASA a fruitful cross-project cooperation on key methodological and conceptual issues. At one level there is a common effort, using our different case studies, to develop a coherent set of methodologies for a new science of environmental management. To give focus to this effort, elements of the Ecology, the Energy, and the Methodology Projects have committed themselves to the preparation of an assessment of three case studies--salmon, budworm, and energy. By comparing these studies, we have found that some of the efforts identified techniques that other efforts did not, and that a full range of techniques could be identified by a cross-case study analysis of this type. These techniques of description and prescription will be documented in a book that will be presented at the initial session of the IIASA resource management conference in 1976.

Regardless of how elegant and effective the methodology might be, it can be grossly misused unless set within a relevant conceptual context. The key issue that seems to have captured the interests of a wide range of people at IIASA is ways of dealing with partially, or even totally, unknown systems. All of our techniques have historically tended to plan on the presumption of sufficient knowledge. But increasingly, we are realizing that the domain of our ignorance is so great that we have tended to produce larger and larger systems whose failures incur larger and larger costs. The nuclear engineers of the Energy Project have labelled this issue "hypotheticality". They argue that technological advances have come through a trial and error way of handling ignorance; a small trial is established and if it fails, information is gained and modifications can take place. But, the scale of our trials are so large that we cannot comfortably afford any error. They say we have locked ourselves into a world in which we can establish hypotheses but dare not test them. The ecologists have been approaching the same issue from a different direction, and have coined the word "resilience". They argue that natural systems have an immense

capacity to absorb unexpected traumas and to persist. There is a matter of a trade-off between "efficiency" and "persistence". Considerable work has been done with theoretical models and with the models coming from the case studies to give this concept of resilience more specific definition and numerical representation. It does seem to be standing up, and to be providing at the minimum a direction toward an alternate strategy of design that can explicitly take into account partially known systems.

This center of intersecting interests has great consequences for a number of issues at IIASA, for example, risk assessment, engineering for safety and health, and environmental standards. The present approaches to these issues aim at minimizing the probability of failure. But increasingly, our experience and our analyses suggest that successful efforts to minimize the probability of failure are paid for at the price of a high cost of failure when it does occur. Such approaches tend to be "fail-safe". Our analyses suggest an alternate approach that is "safe-fail" in which there is explicit effort to design a certain probability of failure as well as an accompanying low cost of failure. Through these efforts, it appears possible to develop policies that are most robust--less sensitive to those unexpected events that seem to bedevil present environmental management.

The cooperation among IIASA alumni on these issues has been so effective that it will continue over 1975-1976, using existing networks of IIASA alumni.

In summary, the above set of tasks emphasizes a new stage for our activities:

- 1) A strong emphasis on international linking through the oceanic fisheries and environmental management studies;
- 2) The establishment of two mini-institutional networks through the regional energy case study and the budworm case study; and
- 3) A major continuing in-house case study of the regional energy analysis.

II. INSTITUTIONAL NETWORKING

C.S. Holling

The issue of institutional networking lies at the heart of IIASA's mission. IIASA has no rationale for existence except to the extent that it can fulfill the goal of international, and in particular, "east-west" cooperation. Almost incidentally, good application of systems analysis requires the same ingredients. But the realities are frightening. It is difficult to collaborate with groups from other disciplines, often located in other buildings. Added to the difficulty are the problems of different languages, ideologies, cultures, and distance. All we can be sure of is that an immense amount of professional planning must go into the initiation of networks and the nurturing of these networks against the overwhelming forces moving to their dissolution.

The Ecology Project has been developing this type of network with the hope that the experiences gained can contribute to the next few years of IIASA's operation. It concerns the forest/budworm problem, and involves the three prime steps suggested in Figures 1, 2 and 3. The key features of this design are as follows:

- 1) Start very small and modestly, biasing the effort toward minimizing complexity, and accepting the criticism that the real goals are not being addressed;
- 2) In each of the steps set the seeds--the information flow needed to identify the centers for the next step;
- 3) Make each of the succeeding steps ruthlessly practical;
- 4) Have each of the elements of the network realize that it is to its advantage to be a part of the network;
- 5) Obtain a formal commitment and funds designated by each and every one of the coordinating and collaborating institutions;
- 6) Undertake explicit efforts to involve one client management agency from the beginning;

- 7) Assign two or three individuals to take prime responsibility for maintaining the network (by travel, telephone and a rich use of telexes, irrespective of expense). Ideally, telecopies would be more effective because of the continuous need to transmit graphic information. The style of operation should involve the use of these devices as one would use a visit to a neighboring office --both for casual contact and for intense working interaction. This will require immense discipline and commitment;
- 8) Hold every two to four months a one- to two-week intensive and focussed working session at one of the network institutions to consolidate previous work, and to generate detailed tasks and responsibilities for the next phase; and
- 9) Be willing to shift the centers of coordination and control as the steps evolve.

It is this series of ingredients that has led to a firm base for Step III in Figure 3. But, for Step III to succeed, and in particular for the success of that part at the bottom concentrating on international transfer, there must be recognition of the immense difficulties.

It is our bias that these difficulties demand individuals whose total time is spent in initiating, maintaining, and gently guiding the network. They need not be scientists in the field; but they must be creative and highly professional. IIASA requires no more than three to four such individuals so long as the in-house scientists can be used as their stable of consultants. While this is a necessary condition, it is in no way sufficient. Funds are needed--funds that are specifically identified to prevent dissolution of the network itself as distinct from financial support for the work. For example, for a three-month period during Step III, the telex bill was \$3,000.

None of the above is science. But in a naive way, it is a suggestion that IIASA can develop a new art--the art of scientific diplomacy that will require the best of scientific projects at IIASA, provided there is something to feed upon. The central goal is the art itself.

If financial and political constraints prevent a serious and professional development of that art through the networking approach, then an explicit alternative proposal is in order.

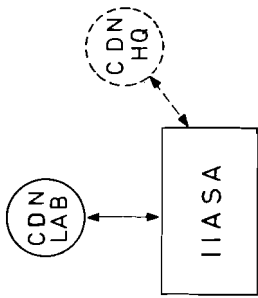

Figure 1. Networking - Step 1
1973-1974.

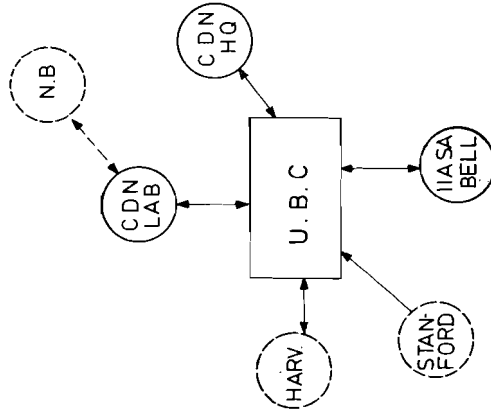

Figure 2. Networking - Step 2
1974-1975.

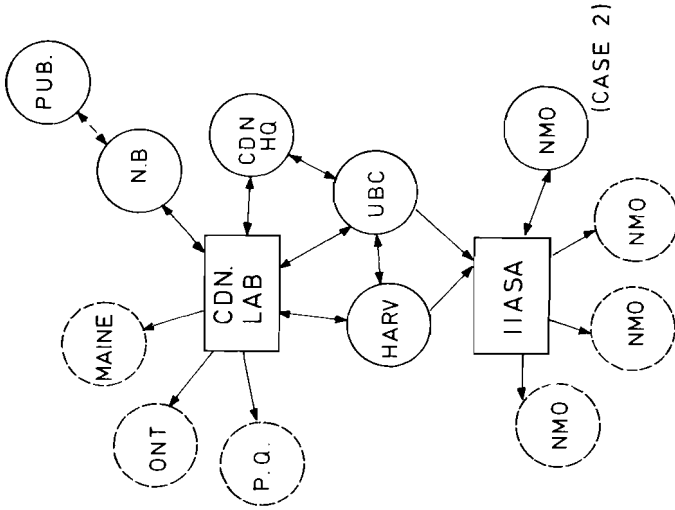

Figure 3. Networking - Step 3
1975-1976.

- ▭ CENTERS OF COORDINATION & PLANNING
- CENTERS OF WORKING COLLABORATION BOTH ANALYSTS & CLIENTS
- CENTERS OF CONTACT SOURCE OF OBSERVERS FOR DEVELOPING FUTURE WORKING RELATIONS

III. CASE STUDIES

3.1. A Case Study of Forest Ecosystems/Pest Management

C.S. Holling, G.B. Dantzig, C. Baskerville,
D.D. Jones and W.C. Clark

1. Introduction

The Boreal Forests of North America have, for centuries, experienced periodic outbreaks of a defoliating insect called the Spruce Budworm. In any one outbreak cycle a major proportion of the mature softwood forest in affected areas can die, with major consequences to the economy and employment of regions such as New Brunswick that are highly dependent on the forest industry. An extensive insecticide spraying programme initiated in New Brunswick in 1951 has succeeded in minimizing tree mortality, but at the price of maintaining incipient outbreak conditions over an area considerably more extensive than in the past. The present management approach is therefore sensitive to unexpected shifts in economic, social and regulatory constraints, and to unanticipated behaviour of the forest ecosystem.

Most major environmental problems in the world today are characterized by similar basic ingredients: high variability in space and time, large scale, and a troubled management history. Because of the enormous complexity of these problems, there has been little concerted effort to apply systems analysis techniques to the coordinated development of effective descriptions of, and prescriptions for, these problems. The budworm-forest system seemed to present an admirable focus for a case study with two objectives. The first was to attempt to develop sets of alternate policies appropriate for the specific problem. The second, more significant objective was to see how far we could stretch the state of the art capabilities in ecology, modelling, optimization, policy design and evaluation to apply them to complex ecosystem management problems.

Three principal issues in any resource environmental problem challenge existing techniques. First, the resources that provide the food, fibre and recreational opportunities for society are integral parts of ecosystems characterized by complex interrelationships of species among themselves and with the land, water and climate in which they live. The interactions of these systems are highly non-linear and have a significant spatial component. Events in any one point in space, as at any moment of time, can affect events at other points in space and time. The resulting high order of dimensionality becomes all the more significant as these ecological systems couple with complex socio-economic systems.

The second prime challenge is that we have only partial knowledge of the variables and relationships governing the systems. A large body of theoretical and experimental analyses and data has led to an identification of the general form and kind of functional relations existing among organisms. Only occasionally is there a rich body of data specific to any one situation. To develop an analysis that implicitly or explicitly presumes sufficient knowledge is therefore to guarantee management policies that become more the source of the problem than the source of the solution. In a particularly challenging way, present ecological management situations require concepts and techniques that cope creatively with the uncertainties and unknowns that in fact pervade most of our major social, economic and environmental problems.

The third challenge reflects the previous two: How can we design policies that achieve specific social objectives and are still "robust"? Once policies are set in play, they produce intelligently linked ecological, social and economic systems that can absorb the inevitable unexpected events and the unknown. These "unexpecteds" might be the "one in a thousand years" drought that perversely occurs this year, the appearance or disappearance of key species, the emergence of new economic and regulatory constraints, or the shift of societal objectives. We must learn to design in a way that shifts our emphasis away from minimizing the probability of failure toward minimizing the cost of those failures that will inevitably occur.

2. The Descriptive Analysis

The descriptive analysis of the budworm-forest system aims at producing a well validated simulation model that could be used as a laboratory world to aid in the design and evaluation of alternate policies. The key requirement of that laboratory world is that it capture the essential qualitative behaviour of the budworm forest ecosystem in both space and time. Extensive data concerning forest-pest and economic interrelations had been collected by Environment Canada over the past thirty years, as one of the earliest interdisciplinary efforts in the field of renewable resource management. There are many missing elements, but this is an inevitability rather than a draw-back. If systems analysis is to be applied successfully to the management of ecological systems, it must be able to cope with the unknown.

The essential qualitative behaviour in time has been identified through an analysis of tree ring studies. Four outbreaks have been detected in Eastern Canada since 1770 (Figure 1), each lasting seven to sixteen years, with a thirty-four to seventy-two-year period between them. During the interim periods, the budworm is present in barely detectable densities; however, when appropriate conditions occur, these densities can increase explosively over four orders of magnitude during a three- to four-year period.

The distinctive pattern in time is paralleled by one in space. The historical outbreaks initiated in one, three or four local areas of Eastern Canada, and from these areas spread to and contaminated progressively larger areas. Collapse of the outbreaks occurred in the original areas of infestation in conjunction with mortality of the trees, and similarly spread to the areas infested at later times. The resulting high degree of spatial heterogeneity in the forest age and species composition is closely coupled to the "contamination" feature caused by the high dispersal properties of this insect.

The essential first step in the dynamic description of this system is a parsimonious bounding of the problem in terms of prime variables, space and time. The process of bounding the problem from the start of the analysis is a key activity. All other steps in the analysis flow from these decisions that profoundly influence the final form and relevance of the policies. The key requirement in bounding the problem in space, time and variables is to ruthlessly simplify while still retaining the essential properties of the system's behaviour to meet management needs.

Bounding Time

Because of the pattern of outbreaks shown in Figure 1, the minimum time horizon of 150 to 200 years is required to contain two outbreaks. A time resolution of one year with seasonal events implicitly represented is needed in order to capture the dynamics of this system.

Bounding in Space

As in many pest species, the budworm disperses over long distances. The modal distance of dispersal is about fifty miles from one site, although dispersal distances of several hundred miles have also been recorded. For this study, we thought it essential to have a minimum total area of at least twice this modal distance, leading to a minimum modelled region of 14,000 to 15,000 square miles. We selected a 17,000 square mile area that contains much of the Province of New Brunswick (Figure 2). But events even in an area of this size are profoundly affected by contagion from outside it. It was therefore necessary to add a buffer zone of an approximate width of seventy-five miles around the area in order to compensate for edge effects. The behaviour of this system is as highly heterogeneous in space as it is in time, and because of the contagion problem spatial disaggregation is essential. There is high variation in the spatial distribution of the primary tree species, of harvesting activities and of recreational potential, in part as a consequence of the historical interplay between the forest and the budworm. The fifty mile modal dispersal distance also suggests a minimum resolution of about one-fifth to about one-tenth of that distance. Hence the overall area is divided into 265 distinct six by nine mile subregions (Figure 3).

Bounding Variables

An ecosystem of this extent has many thousands of species and potential variables. Since our understanding of the dominant budworm-forest dynamics is sufficiently detailed, the system's relevant behaviour can be captured through the interrelations among five species, each of which represents a key role in determining the major dynamics of the forest ecosystem and its resulting diversity. These key variables are summarized in Figure 4.

The principal tree species are birch, spruce and balsam. In the absence of budworm and its associated natural enemies, balsam tends to out-compete spruce and birch, and so would tend to produce a monoculture of balsam. However, budworm shifts that competitive edge since balsam is most susceptible to damage, spruce less so, and birch not at all. Thus there is a dynamic rhythm, with balsam having the advantage between outbreaks, and spruce and birch during outbreaks. The result is a diverse species mix.

As noted earlier, the budworm is rare but not extinct between outbreaks. Its numbers are controlled by its natural enemies such as insectivorous birds and parasites. A key feature of this control is that there exists an upper threshold of budworm numbers that, once exceeded, allows the budworm to "escape" predation and multiply unchecked. In other words, there is a distinct but limited stability region at low budworm densities.

In addition to tree species and natural enemies, there is a key stochastic driving variable--weather--that affects survival of the budworm and can flip the system out of the low density stability region, provided forest conditions are appropriate. Outbreaks cannot occur unless the forest has sufficiently recovered from the previous outbreak to provide adequate food. Even where the food conditions have been met, the budworm remains at low densities controlled by natural enemies until the weather shifts to successive years of warm dry summers. Such conditions allow larvae to develop so rapidly that densities above the escape threshold are achieved. An outbreak is then inevitable, regardless of weather.

In summary, the decisions on bounding the problem are as follows:

Time horizon	-	150-200 years;
Time resolution	-	one year with seasonal causation;
Spatial area	-	17,000 square miles;
Spatial resolution	-	265 six- by nine- mile subregions;
Key variables to capture behaviour	-	ideally, three tree species, budworm, natural enemies and weather.

This bounding of the problem immediately determines the number of state variables, which in turn affect the decisions about subsequent analytic steps such as optimization. Even though the previous steps of bounding seem to have led to a highly simplified representation, the number of state variables generated is still enormous. For this ideal condition, Table 1 summarizes the minimum number of state variables necessary to represent the essential behaviour of the system in space and time. In any one subregion 107 state variables are required; for the 265 subregions, as a whole, a total of 107×265 , or 28,355 state variables are required. Even this drastic simplification accomplished through the bounding exercise leaves an impossible number of state variables, thus demanding further simplification. It would be possible to develop a simulation model with this number of state variables. However, this would be expensive and time consuming to run and debug. Our key goal is to provide a useable and well tested model for exploring behaviour and policy alternates. With such a high dimensionality, the model would become nearly as incomprehensible as the real world and the opportunities for systematic exploration would be greatly reduced.

As a consequence, a systematic series of further compressions and tests were made to determine whether the number of state variables could be significantly reduced. This led to four prime variables: tree density, foliage condition, budworm density, and weather. The tree density actually had to be represented by seventy-five state variables associated with tree age, but techniques were developed to collapse these into one state variable for descriptive purposes. The effects of all other variables can be incorporated implicitly so that this ultimate compression requires essentially four state variables per site or 1,060 for the region.

The Model

The basic form of the model structure is shown in Figure 5. Budworm reproduction and survival, forest response, and control policies are independent for each of the 265 sites. Dispersal occurs once each year among the sites, and the process is repeated for the next simulated year. The budworm and forest response models were developed from the extensive set of data collected by Environment Canada over the past thirty years. Many of the component processes such as growth and reproduction have been examined in extensive detail by Morris et al. [3], using multi-variate statistical procedures. There are three critical processes that are not clearly understood at present and for which there is, at best, qualitative information. These three areas of semi-knowns are: the effect of natural enemies at low densities of the insect; the detailed response of trees to defoliation; and the specifics of dispersal. Since this problem of grappling effectively with substantive unknowns is central to any successful analysis of ecological problems, considerable effort was spent in developing a formal procedure to

Table 1. The state variables emerging from the bounding of the problem.

Ideal Number of State Variables	
In one subregion	1
Birch	1
Spruce by age	30
Balsam by age	70
Budworm	1
Natural enemies	1
Weather	1
Tree stress	1
Foliage new	1
Foliage old	1
	} retains memory
Number of state variables per subregion	107
Total number of state variables in all 265 subregions	$107 \times 265 = 28,355$

cope with such uncertainties. Moreover, these three particular areas of uncertainty are typical of many situations. Rarely, for example, is there much detailed information about events where the number of organisms is very small. Nor is there often much knowledge concerning very slow processes such as those involved in tree responses. Finally, dispersal occurs over such large areas that only recent application of radar technology has made it possible to define and quantify the form and magnitude of spatial contagion. We know that each of these three sources of uncertainty is critical in determining aspects of renewable resource systems behaviour that have been troublesome in past efforts of environmental management.

The ecological literature contains a rich body of experimental and theoretical analyses of key ecological processes. These analyses have led to the identification of classes of interactions, each characterized by a specific family of mathematical equations. For example, predators display a set of responses to prey or to host species that fall into nine primary classes. Not only is each of these classes defined by a specific family of functional relations, but the biological attributes for each class have also been sufficiently well identified. Qualitative information usually makes it possible to assign a specific example to the appropriate general class.

This work provides us with a theoretical framework for mobilizing the existing information, however sparse, in a way that we can proceed in a series of steps that gradually define a narrower range of possible relations. Once the classes of responses characterizing specific situations have been identified, it is necessary to parameterize them. Even in the worst of circumstances, information usually exists to permit rough specifications of the parameters, leading to the definition of a maximum possible range for each of the response classes.

The final step is to cycle these possible relationships through the full simulation model in order to define a "feasible range" of forms that result in retaining the known qualitative behaviour of the system. At that point, informed judgement can informally select a "standard" relationship for use. Alternatively, an organized application of decision theory can assign subjective probabilities and so generate a range of possible outcomes.

The key point of this exercise is to directly face the reality of unknowns and to recognize that an organized approach in dealing with them can provide reasonable solutions that will allow the policy design process to proceed; at the same time it can provide clear and specific priorities for future research.

A dynamic descriptive model of the sort described here is useless for prescription unless it presents opportunities for meaningful management intervention by policy actions. There are two main classes of policy action possible: one relating to control of the budworm; and one relating to management of the forest.

These are structured in broad terms allowing for the exploration of insecticide control of budworm as well as for biological and other control methods. Similarly, the forest management policy can include specific actions of cutting by age in different regions of the forest and, at least implicitly, a variety of silvicultural and tree breeding actions. The model is structured to accommodate a wide range of possible actions; however, for the purpose of this case study, attention was largely directed toward budworm control using insecticides or bacterial agents and toward forest management using different techniques of scheduling cutting in space, time and by tree age.

Model Validation

Validation of an ecological model is always difficult. In this example, a statistically rigorous validation would require detailed historical information about all of the state variables over a large spatial area and covering a long period of time (at least seventy to 150 years). Only in that way could the full dynamic interplay of the system over time and space be adequately tested. The budworm case is rare in that such data are in fact available for a thirty-year period; but that is scarcely long enough to instill a profound confidence in the model. Our present validation approach has therefore been to combine a quantitative comparison of state variable values over the period for which detailed historical data are available, with a qualitative comparison of gross behavioural properties (e.g. mean outbreak densities and variances, length of inter- and intra-outbreak periods) for the longer term (Figure 6A). This figure shows a series of computer drawn maps generated by the simulation model, showing on the vertical axis the density of budworm eggs over a fifty-four year period. Two outbreak sequences are covered, and the essential pattern of these predictions has been confirmed by historical data from New Brunswick and from elsewhere in Eastern Canada.

In summary, the descriptive analysis led to the development of a dynamic simulation model that could describe the behaviour of the forest/pest ecosystem in space and time, with opportunities for intervention with a variety of management acts. It provides a laboratory world in which the consequences of a variety of alternate policies can be explored, and constitutes the essential base for the prescriptive analysis.

3. The Prescriptive Analysis

The goal of the prescriptive analysis is to provide a management tool that can aid in policy design and evaluation. There are three parts to the analysis as we implemented it: 1) the definition of a strategic range of management objectives; 2) the application of optimization techniques to develop policy rules for each of the objectives; and 3) the development of a framework to broadly evaluate the consequences of each of the policy rules in terms of a wide range of potential management goals.

Strategic Range of Objectives

The uncertainties and unknowns in describing an ecological system are trivial compared to the ambiguities in defining societal objectives. The objectives that appear clear at any moment can shift dramatically, as testified to by the recent concern for environmental issues. Moreover, as has been discovered by the water resource planners in particular, even the best of policy analyses can founder on unrecognized or hidden public objectives. Since social objectives are hidden, ambiguous, conflicting, and otherwise indefinite, the analyses rarely can accommodate them satisfactorily. Hence they become uncomfortable, intrusive and divisive issues of confrontation.

In response to this essential ambiguity of objectives, we felt it essential to identify a strategic range of objectives containing a systematic spectrum of plausible and not-so-plausible management goals. Any specific example drawn from that spectrum was initially considered only as a touch-stone and in no sense a realistic or desired objective. Again, our aim was to provide a tool for articulating and exploring alternatives, not to provide a predictor of prepackaged social goals. The strategic range, as we conceive it, covers at one extreme objectives that attempt to achieve long-term profit maximization, and to minimize probabilities of failure. At the other extreme, and equally unrealistic, the objectives seek more to retain the dynamic variability of the system in ways less sensitive to ecological surprise or to changes in social and economic goals. These latter objectives attempt to achieve systems that are resilient or robust; that work with the dynamic rhythm of the system rather than against it. If the first extreme represents the goal of a fail-safe world, the latter represents one that is "safe in failure".

Five strategic touch-stones of this kind were defined as follows:

- 1) Unconstrained profit maximization;
- 2) Constrained profit maximization, where the maximum processing capacity of the existing logging industry sets constraints;
- 3) Recreation maximization, acting as an additional constraint on 2 above;
- 4) Budworm minimization, replacing the spraying policy of 3 above with alternate methods of forest management and budworm control; and
- 5) Variability transformation, operating independently of 2 above, in which the goal is to transform the high temporal variability (that causes a boom and a bust situation for employment and the forest industry) to spatial variability. The goal in this extreme is to develop a forest ecosystem where the budworm can be used as a forest manager, and where the essential dynamic interplay of natural forces is retained.

Two additional policies are explored: one of "no management"; and one of "historical management". This produces a total strategic array of seven alternate objectives that, after evaluation and comparison, can be modified, combined and refined as starting points for a policy design dialogue with managers and specific interest groups.

Optimization

Given a range of objectives, the next step is to specify ways of combining available management actions with sets of policy rules appropriate for their realization. Simulation gaming, at an early stage, is a useful exercise for heuristically exploring the possible consequences of different management acts. Even after more formal optimization procedures have suggested specific rules, gaming can still be a rich environment for dialogue. But the immense variety of different ways of combining acts in space and time demands more structured procedures as well. Figure 6B is an example of a gaming simulation run.

The approach we have taken is to regard the simulator as a means of bringing the real world into the laboratory. The various policies (whether obtained by common sense or by common practice or through the use of an "optimizer") can always be compared by making a sufficient number of runs on the simulator. An analyst weak in analytic skills, poorly trained in the formulation of models, poorly informed about algorithms for solving classes of models, or unfamiliar with software availability may well opt to run many cases on the simulator to see if local improvements in a proposed policy is possible. Most simulation efforts end up this way. This is unfortunate because the high cost of using simulators to test many cases usually exhausts the patience and funds of sponsors to support development of an optimizer. If these funds had been used instead to develop a simplified model, the process of determining an optimal policy for the simplified model could serve as a "brain" for the simulator, and would have resulted in the identification of significantly improved policies.

In general, there are two types of analytic models that have had many successful applications: (1) "linear programming" models; and (2) "dynamic programming" models.

The linear programming model is characterized mathematically by a system of linear inequalities. Many kinds of non-linear relations can be practically approximated by systems that can be both dynamic and stochastic. Software is available at reasonable costs for solving such systems even where these systems involve thousands of inequalities and variables.

The dynamic programming model is characterized by a dynamic system that moves from any given state in time to the next state without being affected by the past history of how it arrived at its given state. Many practical models can be cast in this form.

In practice, however, applications are narrowly limited to those whose "state space" may be approximated by a low number of cases. In our research we have pursued an alternative possibility--one that allows the state space to be multidimensional and continuous in certain components. We were able to do this by finding a practical way to approximate the "pay off" for each of the states if one follows an optimal policy.

For the Budworm Optimizer, we used a mathematical model closely related to the dynamic programme--the so-called Markov Process. At each of the points in time t , the system is in some state A, B, C, \dots . If in state A , the system will move to state A or B or C, \dots , at time $t + 1$ with probabilities $P(A|A), P(B|A), P(C|A), \dots$; similarly if the system is in state B , it will move to A or B or C at time $t + 1$ with probabilities $P(A|B), P(B|B), P(C|B), \dots$, etc.

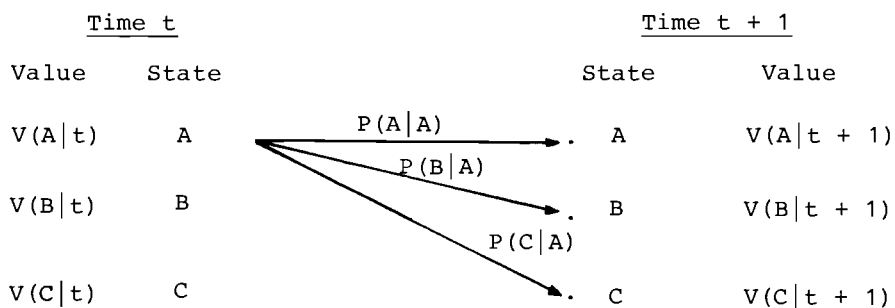

In our application, these probabilities can be changed at a price by engaging in certain alternative actions. The problem is to find the best choice of these alternative actions. This is easy to do if we know the value $V(A|t + 1), V(B|t + 1), \dots$, of being in various states at time $t + 1$. Thus the expected value $V(A|t)$ is given by:

$$\begin{aligned}
 V(A|t) = & P(A|A) \{V(A|t + 1) - C_{AA}\} \\
 & + P(B|A) V(B|t + 1) - C_{AB} + P(C|A) V(C|t + 1) \\
 & - C_{AC}, \dots,
 \end{aligned}$$

where, for example, C_{AB} is the cost (revenue if negative) of transitioning from A to B in time period t . If there are alternative actions in period t that can affect these probabilities, then the action that yields the maximum value of $V(A|t)$

is chosen. The procedure is a backward induction to time $t = 0$, and requires (in order to get it started) the knowledge of $V(A,t)$, $V(B,t)$, $V(C,t)$ for some future time $t = T$ in the future.

As noted, a Markov-type model was used for the budworm study. The key idea used in the development of this analytic model was to view the single tree as an entity that changes state from year to year--its state being defined by its age, stress, and the number of budworms it hosts. The tree, depending on the weather and on whether or not it is sprayed or cut, will (with certain probabilities) become one year older with certain stresses and egg densities or it will revert to age zero and be replanted. If it were not for the spread of budworm eggs by the adult moth from one timber stand to another, this model has the merit that all other relations can be used with little or no simplification or change. This leaves open the question of how to approximate the effect of egg contamination. Several approaches have been posed and are dealt with by Dantzig and Holling [1]. Acute simplification is the rule in dynamic programming applications, and we shall show how we have presently elected to live with this after we outline the existing model and its solution.

For the simplified model, we wish to find for every state (tree age, stress, and egg density) the optimal policy. One way to determine optimal policy with regard to the tree and its replanting is to begin with a guess V_0 as to the entire discounted future value of a tree, starting at age zero and including the value of all its future harvesting and replanting (to time infinity). A tree planted a year from now has a present value of $.95 V_0$ for its time stream from one year to infinity where (say) 5% is the discounted factor (without inflation). If for the moment we accept our guess V_0 , we are in a position to evaluate the present value of all other states. One begins by noting that, as far as harvesting the lumber of the tree now (or in the future), it does not pay to allow a tree to become older than (say) sixty years. The optimal policy is then to cut down the tree and its present value would be; $V_{60} = V_0 + L_{60}$, where L_{60} is the value of the sixty year old tree as lumber (less any cost for replanting it). To obtain the value V_{59} of a fifty-nine year old tree (that is in some state of stress and egg infestation) and, at the same time, to determine the optimal policies, we must consider the following: (1) cut the tree down, $V_0 + L_{59}$; (2) leave the tree alone, $.95\{pV_{60} + (1 - p)V_0\}$, where p is the probability of the tree living; or (3) spray the tree, $-S + .95\{\bar{p}V_{60} + (1 - \bar{p})V_0\}$, where S is the cost of spraying and \bar{p} is the probability of the tree living after it has been sprayed. The policy that yields the highest value is optimal. Note that the effect of random weather factors are part of the calculations (i.e. weather affects the probabilities of dying or the probabilities of moving from one state to another),

so that values (and optimal policies) of various states can be determined backwards from the highest age sixty down to age zero. If it turns out that our guess V_0 checks with the value V_0 obtained by the backward calculations, we accept our guess as correct; if our guess proves to be wrong, then we revise our guess up or down until it checks with the value.

This procedure defines an optimal way to apply the variety of management acts for a specific objective in terms of the values of the key state variables. These policy rules may be represented in the form of policy tables as shown in Figure 7. For any tree age, foliage condition and density of insects, the manager can either take no action, spray (and the spray can be at different intensities and concentrations) or harvest. The advantage of such policy tables is that they are clear and unambiguous, and can be easily applied by a forest manager attempting to manage a stand in isolation from the rest of the regional forest system.

Gross simplifications are needed to achieve these "optimal" rules because of the limitations of available optimization techniques. Two major simplifying assumptions were needed. The first concerned a simplified expression of the objective function; the second required that we assume that dispersal between spatial areas was unimportant. It was only in this way that the high dimensionality of the problem could be simplified to the point where dynamic programming could be successfully applied. Similarly, gross simplifications will be required in most problems involving dynamic management of resource and environmental systems.

Dynamic programming is a powerful and valuable tool for use in ecosystem management studies. But unless really substantial advances are made in its ability to handle certain classes of high dimensionality, it will properly remain only a special-use "sub-optimizer" methodology. For the foreseeable future, we will have to learn to make the most--without making too much--of this fact.

Sub-optimal or partial optimal solutions have a useful role to play. The key to their constructive use is an ability to cycle simplified policies through the full simulation model with all of its complexity. By using a variety of indicators, each of these policies can be assessed in terms of a possible drift of solution from some broader societal and environmental goal. When this is detected, ad hoc, heuristic modifications of the policies can be employed to produce more desirable behaviour.

This process should be in the form of dialogue between managers and interest groups. As we stated previously, the optimization model was designed to provide a "brain" for the simulator. But that "brain" is a childish thing, and for proper functioning it requires the guidance that can be provided only by those who make policy and those who endure it.

Evaluation

A program of policy exploration and evaluation using a simulator requires the development of a rich array of social, economic and environmental indicators, as well as a framework for their use and interpretation. The manager must be able to converse with the model in a critical and flexible manner, if the model is to have any legitimate use as a policy design tool. A system of indicators was therefore designed to serve as the common, comprehensible language in which that conversation could take place. The grammar and syntax rules that give structure to the manager's dialogue with the model are derived from the discipline of operations research and, more particularly, from decision analysis.

The central difficulty in applying traditional decision analysis approaches to the budworm-forest management problem has been the essentially dynamic nature of both the system itself and the majority of possible policies for its control. The "present state" description of the system tells us only a little about future states, and the essence of a good management policy is precisely the ability to adapt quickly and successfully to the inevitable future state surprises as they arise. We are really more interested in what the forest is doing than what it is at a given moment, and the standard paraphernalia of a discipline that is heavily concerned with relatively complacent marbled urns have predictably been unable to give us the help we need.

Our ad hoc solution to the problem of specifying objectives for a time changing system has been to present the decision maker with full time series descriptions of the forest's behaviour, without regard to the policies employed to generate that behaviour. In principal, the choice problem simply becomes one of ranking time streams rather than state descriptions of the managed system. The full panoply of time stream indicators associated with any simple management policy is exceedingly complex. Thus, to enable consistent rankings of alternatives, we must first drastically and meaningfully simplify.

The first step in the process is straightforward. The individual manager is asked to review the list of indicators, to strike those of no or minor relevance to the determination of his time stream preferences, to retain the rest, and to add or alter where necessary. A representative list of one decision maker's "things I am interested in" is shown in Table 2.

A small amount of additional simplification can be easily done. These indicators are listed by intuitive groups of like "kind". It turns out that the decision maker's expressed trade-offs among indicators within such groups are often independent of the values taken by indicators outside the group (a sort of preferential independence). As a decision maker stated, "I can add apples and apples without caring too much about oranges".

Table 2. Preliminary "grouped" list of relevant indicators.

A) <u>Economic:</u>	X_1 = "Profit" to logging industry; X_2 = Cost of insecticide spraying; X_3 = Cost of other control measures.
B) <u>Forest Appearance:</u>	X_4 = Age class diversity; X_5 = Proportion of trees in "mature" classes; X_6 = Proportion of trees severely defoliated; X_7 = Proportion of dead trees; X_8 = Proportion of area logged.
C) <u>Social:</u>	X_9 = "Unemployment"; 1-prop. of mill capacity not filled.
D) <u>Forest Potential:</u>	X_{10} = Amount of merchantable wood present; X_{11} = Amount of merchantable wood harvested.
E) <u>Ecological:</u>	X_{12} = Average concentration of insecticide in sprayed areas.

In addition, within-group tradeoffs were usually expressed as "noncompensatory" or threshold phenomena in which a given indicator became important only when it took a value outside a wide "normal" range. These convenient simplifications made it possible to reduce most of the groups in Table 2 to single, aggregate indicators in a relatively unambiguous and intuitively plausible manner. An example of this reduction is shown in Figure 8. Following similar procedures, one manager reduced his initial long list of indicators to only three: one for economic effects (including logging, spraying, and operating costs); one for recreational value (including accessibility factors, forest composition, logging and insect damage); and one for social issues (essentially the level of labour force displacement due to forest destruction by budworm).

Having completed the initial indicator selection and aggregation, we possess a reasonably concise way of describing any given pattern of system behaviour. The task remains, however, of systematically, meaningfully, and unambiguously ranking alternative sets of time streams such as those shown in Figure 9. Most regrettably, this seems to present a problem wholly beyond the capacity of present theory and methodology in decision analysis. Consider for a moment, the difficulties.

Time lies at the heart of all of our problems. If we wish to assign a single ranking value to a given set of indicator time streams, we must ultimately compress indicator values across time. The first inclination is to take variously weighted time averages of the indicators, means, discounted sums, and so forth. But any such time averaging scheme implies an explicit attitude of intertemporal tradeoffs through which we are willing to relate the future to the present. It is arguable whether standard "1-15%" discounting arguments can be defensibly applied to even purely financial matters. Their appropriateness outside the world of capital investment is highly suspect, to say the least. And despite the large volume of writing on "social rates of discount", little of practical import has yet been said on this matter. It would seem that our society has yet to agree upon a fixed rate at which it is willing to discount its posterity into insignificance. And whatever that rate may be, the proper solution to the discounting problem certainly does not involve convincing society to do so.

Even if the overall time averaging problem could be resolved, we are left with the problem of assigning appropriate ranking weights to different temporal patterns of an indicator. Surely an unemployment rate time stream averaging 10% and based on alternating years of full employment and 20% unemployment deserves a different ranking from one that holds a static rate of 10% year after year. Potentially meaningful properties of time stream behaviour are almost certainly captured in correlation and run statistics as well as in variance estimates. As with the averaging problem, the important issue is not whether we can perform requisite calculations but how we could make the results meaningful to the manager.

One potentially useful compromise approach to the time problem has been to compress indicators across kind but not time, resulting in a single aggregated value function time trace (Figure 9). The key here is conditionally to assume temporal independence of indicator tradeoff values, in essence to pretend that the relative weighting attached to various indicators in a given year is independent of their values in neighboring years. After this assumption has been made, intra-temporal, inter-indicator tradeoffs are evaluated using a standard multi-attribute, revealed preference approach and an overall calculated value function. This function is applied independent to separate indicator values for each of the years, generating the aggregate value time stream shown in Figure 9. In our work we have permitted no discounting of the component indicators or final value stream because of the ambiguities inherent in aggregating across differentially discounted indicators.

At this point, the manager has reduced his ranking problem to one of comparing a single aggregate value stream for each of the patterns of system behaviour in question. By visually pairing these value streams with their component indicator streams, the decision maker may be able to interpret the former consistently and to evolve a stable ranking pattern. The pairing also serves to show, through the component indicators, those portions of the value stream that are most likely to be sensitive to the temporal independence assumption. We have no methodology to cope with this sensitivity, but the "flag" serves to temper our interpretation of the aggregate value stream with skepticism.

Further work is underway at IIASA to improve upon the present unsatisfactory state of affairs. It appears unlikely that any breakthroughs will occur in the areas of discounting or handling inter-temporal tradeoffs, but some progress on crucial issues of communication may be expected.

4. Summary and Conclusions

What Has Been Done

The intent of this case study was to see just how far one could proceed in combining the best of ecological modelling, policy design evaluation and decision theory toward a realistic and characteristic problem of ecosystem management. The key ingredient of this analysis was the development of a rigorous, parsimonious and well-validated simulation model that explicitly addressed issues of unknowns and uncertainties. It provided the laboratory world for the development and exploration of alternate policies. The process led to optimization, where the limitations of existing techniques required an evaluation of "sub-optimal" policies through the simulation model. This process of evaluation in turn generated the need for a rich variety of social, economic and environmental indicators that could be used to judge the consequences of alternate policies.

It became essential to develop an alternate array of indicators, explicitly designed to handle the uncertainties or unknowns. These are necessary because ecosystems and, for that matter, social systems, are generally multi-equilibria systems in which each equilibrium is bounded by a stability region. Very little information can usually be mobilized to concretely and specifically establish where those boundaries lie, or how the stability regions may contract with the application of management activities. There is growing evidence from fisheries, forest and other ecological systems that suggests that these domains of stability do contract with no obvious indications until collapse occurs. Hence three classes of "resilience indicators" were also developed: one measuring the unused environmental capital that would provide the alternate options required in the event of an unexpected event; one relating to measurements of the stability boundaries; and one concerning the resilience of benefits. The latter are generated by explicitly simulating specific kinds of policy failure and by monitoring the stream of benefits thereafter.

The final key piece that linked the whole range of techniques was an explicit effort to generate a strategic range of objectives as first-cut management alternates. This range was designed to cover both non-resilient and resilient objectives with the intent of providing a rich menu for comparison and subsequent modification.

So far we have emphasized mainly the techniques used, saying little about the process by which they were developed and employed in the research programme. Yet a crucial element of this exercise has been the inter-disciplinary and inter-institutional character of the operation. From the start the Maritimes Forest Research Centre, Department of the Environment (Environment Canada), Fredericton, Canada, was involved in every stage of the project. Much of the economic and ecological analysis was performed at the MFRC Laboratory in close conjunction with other members of the team. The Institute of Resource Ecology, University of British Columbia, provided the expertise in systems ecology and mathematics. The whole activity was given focus and a disciplinary breadth at IIASA. The final group of collaborators involved ecologists, systems mathematicians, and operations researchers, covering a wide spectrum of talents. Despite that interdisciplinary breadth and the several thousand miles between the three key participating institutions, the degree of cooperation and communication was truly remarkable, in large part because of the initial fostering and flexible interactive environment of IIASA.

What Is Missing

If the test of this study is whether critical systems analysis can provide a more effective approach to ecosystem management problems than past approaches, the answer is yes. At the very least, a specific list of research priorities can

be defined, critically focussed on management needs, and leading to a more effective expenditure of available funds. Similarly, the exploratory policies generated, although in need of further modification as the effort leads to implementation, suggest management routes to greater benefits and robustness at considerably less cost.

But if the test of this study is whether this range of techniques and the new ones added are adequate to the problems at hand, then the answer is no. Several major issues are unresolved. One of the most important issues concerns the difficulties of meaningfully aggregating indicators across kind, time, and space so that rational preferences can be expressed among alternate futures. The use of present discounting procedures to handle inter-temporal tradeoffs is totally inadequate, the more so because it makes the problem deceptively tractable. We know of no meaningful and effective way to make this time compression. Similarly, fundamental problems of the effective application of optimization techniques have already been discussed.

Beyond the technical inadequacies, there are more important elements totally missing from the full process of policy design. When we compared the steps taken in the present case study with others that were developing simultaneously at IIASA, a total set of analytic steps began to emerge that would cover the full range of activities required in effective policy design. These are shown in Table 3 and in Figure 10. The Budworm Case Study concentrated on the steps contained in the heavily outlined region of the table. Our implementation phase is just starting, and it will encounter major issues of practical concern relating to availability of an infrastructure of roads, logging logistics and capital availability. That effort will have to develop additional tactical and more detailed simulation models and optimization routines, and must proceed in close interaction with those agencies and industries actually responsible for management. The step of implementation is one that few exercises of systems analysis have successfully accomplished; certainly there are few major examples in the environmental field, outside of water resources work, that have involved effective implementation. That will be the challenge and the acid test for the budworm programme over the next few years.

An equally important missing element in our programme has been the embedding of whatever policies that are developed within the larger socio-economic reality of New Brunswick, and of Canada as a whole. Typically, relatively little effort is expended in specifically addressing these questions of social embedding. Yet it is essential to develop some general overview of the broadest consequences of local policies. A promising lead has been provided by the energy case study at IIASA that argues for the possible development of some simplified alternate societal models that in no sense pretend to be accurate representations of reality; rather they provide a framework

Table 3. The full policy design process.

Analytic Step	Systems Level	Function	Technique	Purpose
Hypothetical overview (embedding)	N-1	Consequence check	-	To assess larger societal consequences of local policies.
Detailed dynamic description	N	System description	Simulation model with full spatial disaggregation	To describe, dynamically, the local system with enough confidence in its reality to be treated as reality.
Policy prescription	N	Policy design	Strategic range of objectives; optimization using simplified simulation model	To develop policy rules that are <u>only</u> state dependent, using simplifying assumptions.
Policy evaluation	N	Policy check	Cycling policies through full model; generating indicators (social, economic, recreational, environmental and resilience); decision analysis	To evaluate broader consequences and feasibility of policy rules within the local system.
Policy implementation	N+1	Implementation feasibility check	-	To develop detailed operational rules for implementing policy.

or "mythology" to interpret the consequences as one person's view of the world. In the final analysis, those societal consequences must be explored by those who must make the management decisions, and by those who must endure them.

The effective exploration of societal consequences is dependent upon communication in its broadest sense. That too is an area of neglect in this and nearly all other efforts. If we were to devote 5% of the ingenuity we now spend on analysis to studying innovative and effective ways of communication, the payoff in terms of improved management would be astounding. The question at issue is how information concerning such a complex system can be presented in forms that are clear, understandable and usable; usable in a way that the perceptions and experience of the non-experts can be brought to bear on the analysis in a full and effective manner.

One final point needs re-emphasis. Past efforts in resource management have been essentially trial and error approaches to coping with the unknown. And indeed that is the way our society has advanced since the industrial revolution. Existing information is mobilized to suggest a trial; if an error is detected then that provides additional information to modify subsequent trials. We are now at the point where the intensity and extensiveness of our trials generate errors that are potentially larger than our society can afford. Trial and error seems increasingly to be a dangerous method for coping with the unknown. We need a new strategy to deal with ignorance. The concept of systems resilience provides at least a hint of a direction to proceed, focussing as it does not on the prediction of future surprises, but on designing systems that have the internal resilience to absorb those surprises when they inevitably appear.

Unless we can integrate into our design activities some approach for dealing explicitly with the unknown, and unless we honestly and effectively address the larger issues of social embedding and meaningful communication, all that we applied systems analysts can do is promise larger disasters, achieved faster and in a more pretentious and disciplined manner.

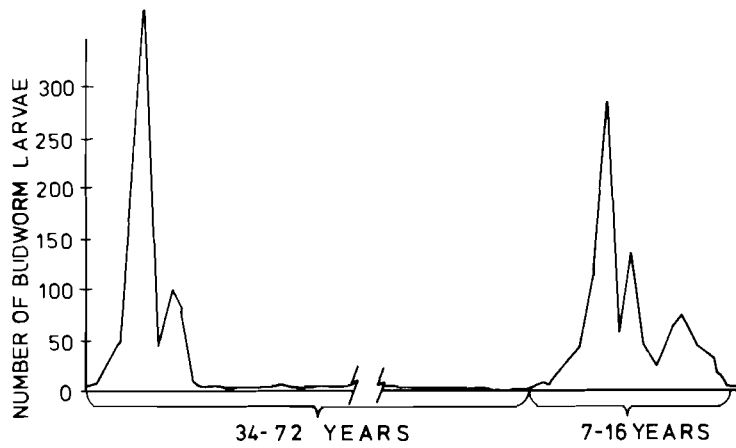

Figure 1. The pattern in time. Representative historical pattern of Spruce Budworm outbreak in Eastern Canada. There have been four major outbreaks since 1770.

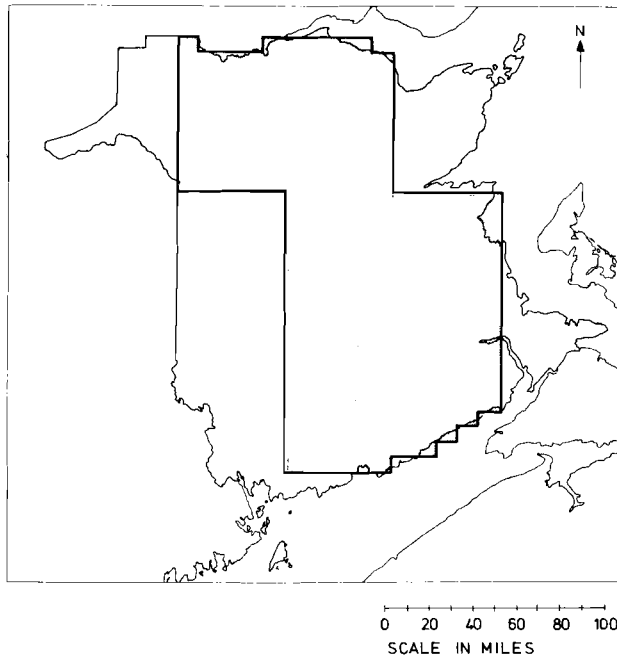

Figure 2. Study area within the Province of New Brunswick used in the current study. Hatched area includes the primary forested regions of New Brunswick.

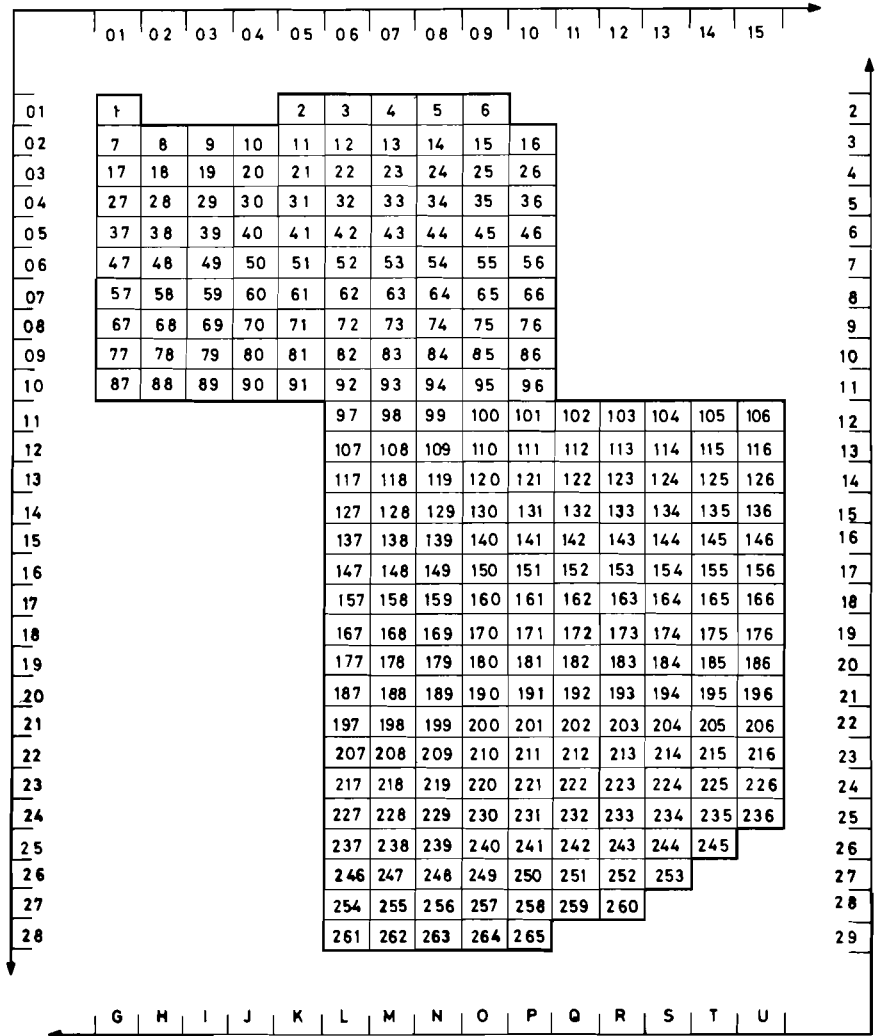

Figure 3. Numbering and indexing system for the 265 subregions, or "sites", in the study area.

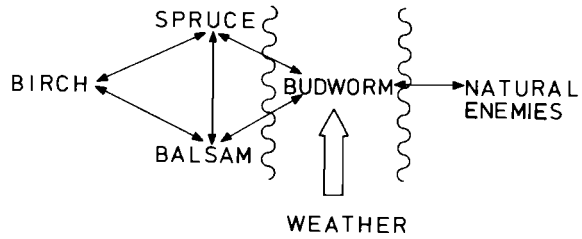

Figure 4. The key roles or variables and their interrelations in the natural ecosystem.

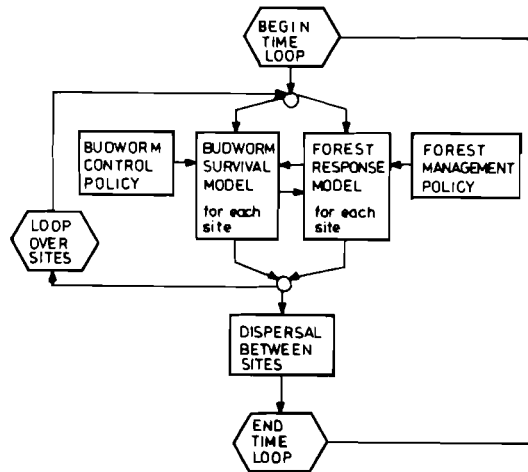

Figure 5. Basic model structure for the budworm-forest simulation model.

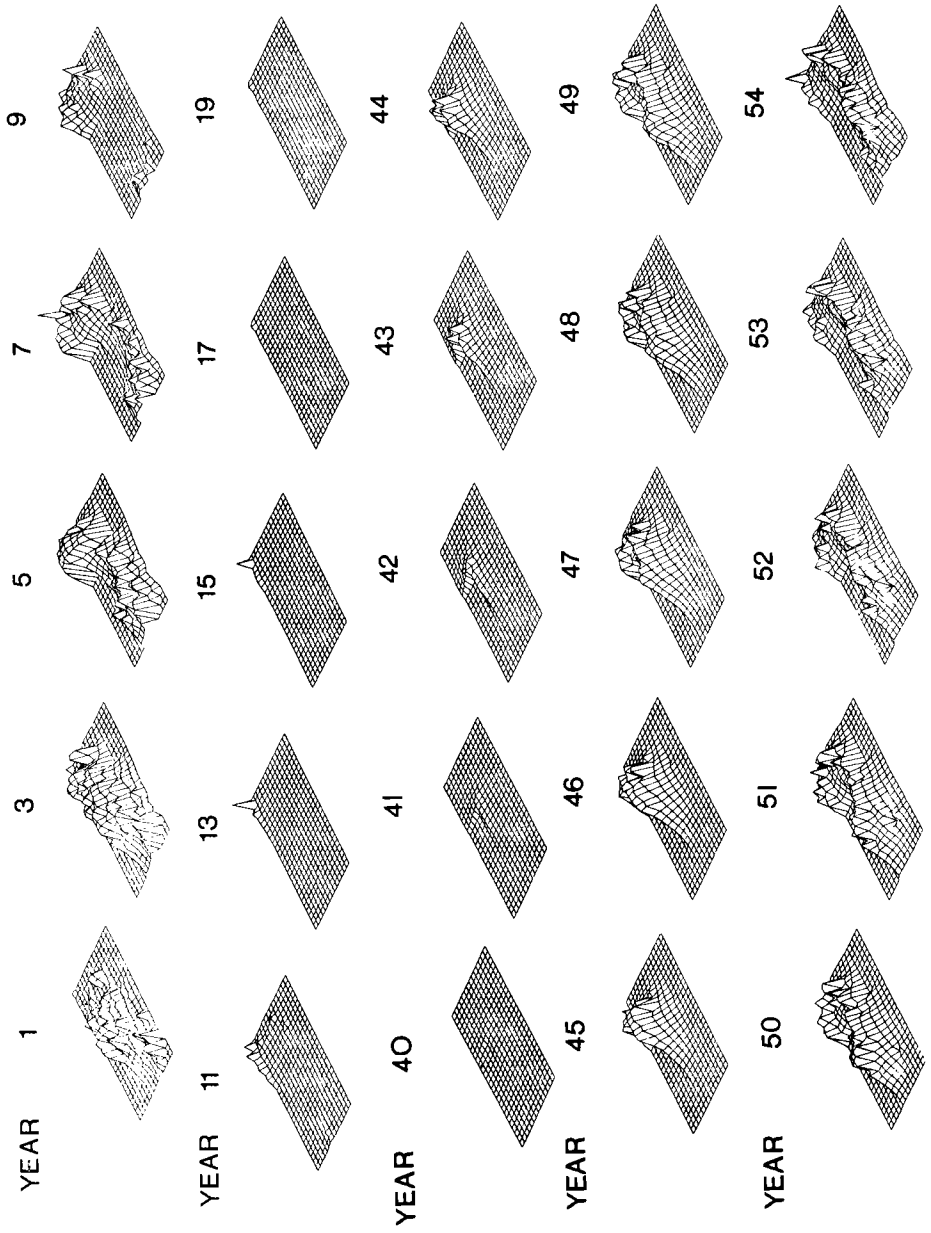

Figure 6A. Computer simulation maps of budworm egg density - (no management).

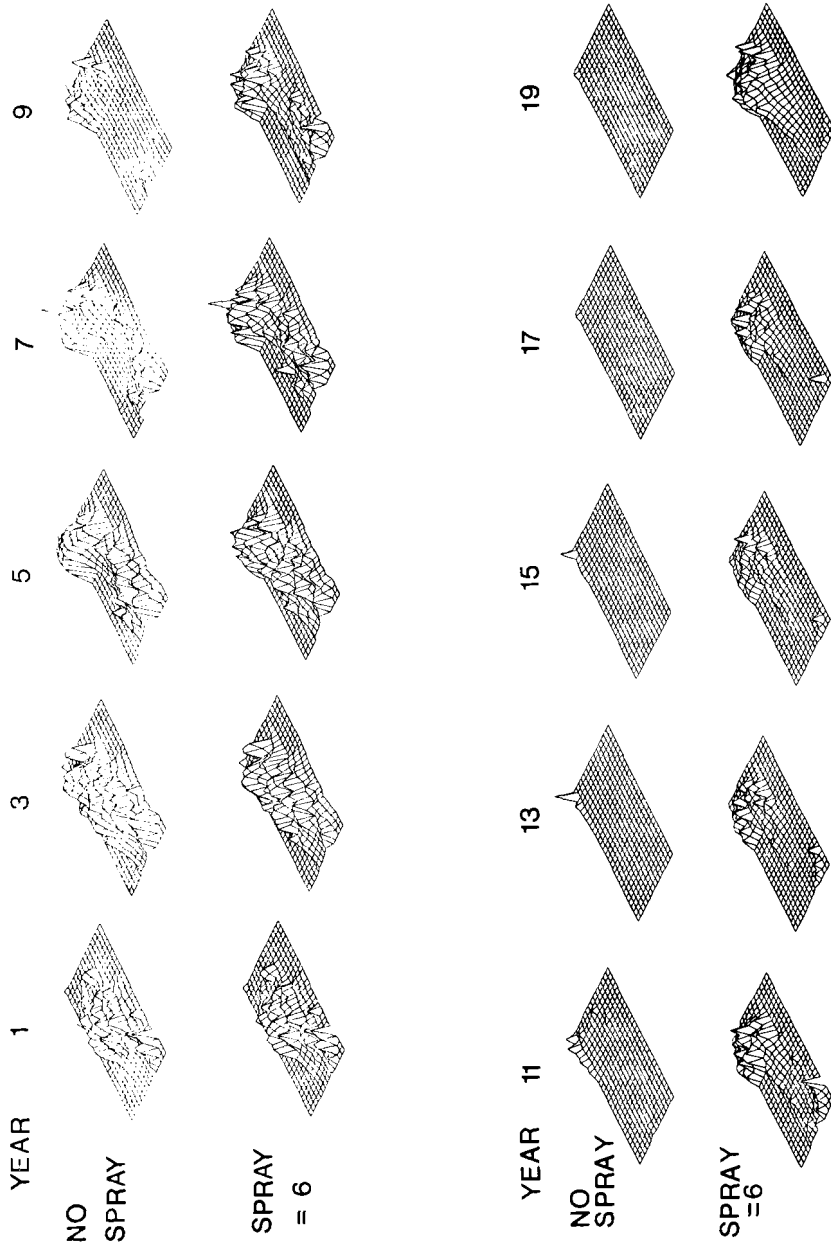

Figure 6B. Example of gaming simulation in which a spraying procedure, similar to that used historically, produces sustained semi-outbreak situation.

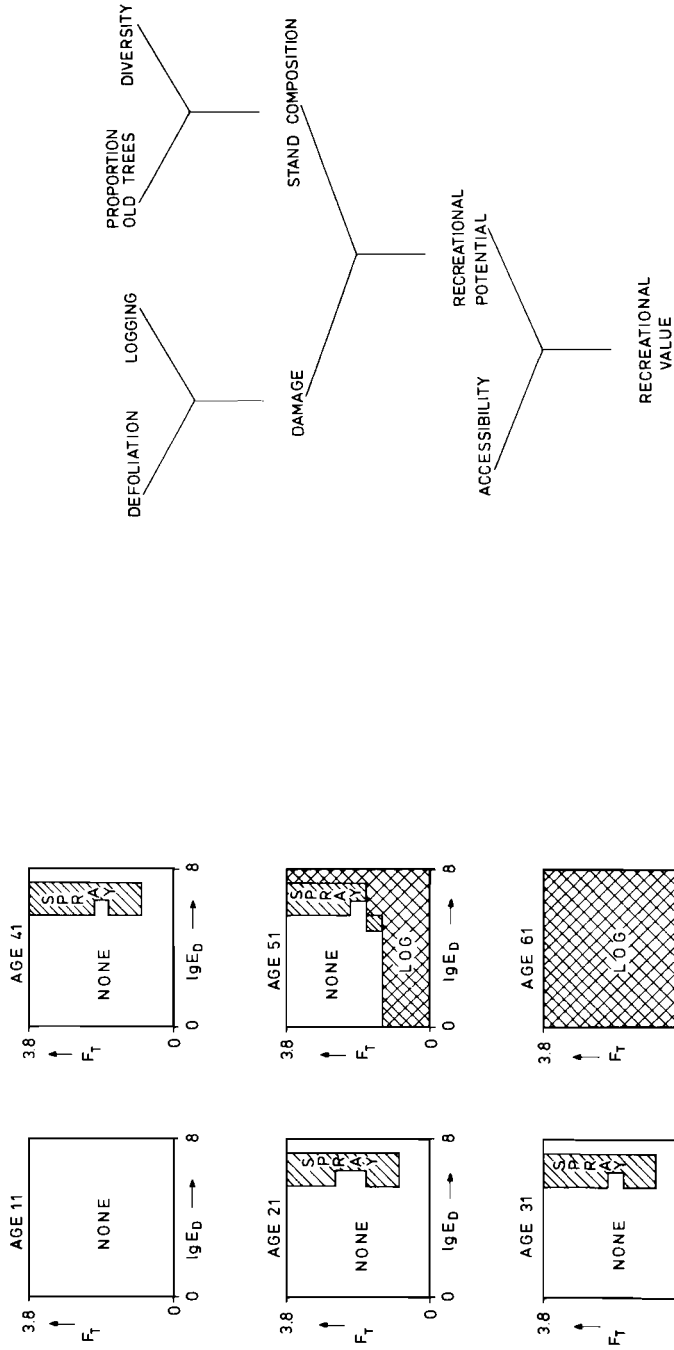

Figure 7. Policy tables for representative ages
(price = 55 Canadian\$/cunit;
 $p = .05$).

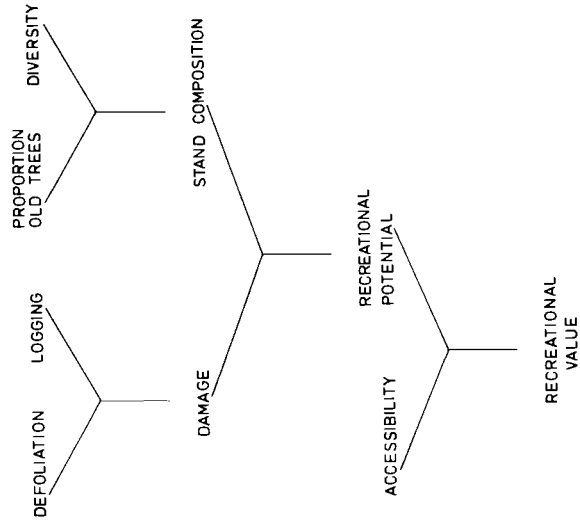

Figure 8. Steps in aggregating four basic variables into a recreational indicator.

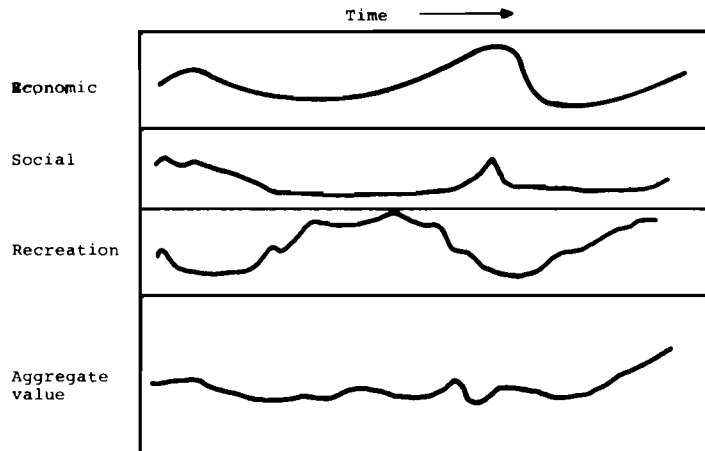

Figure 9. Example of time traces of three selected indicators and their aggregate.

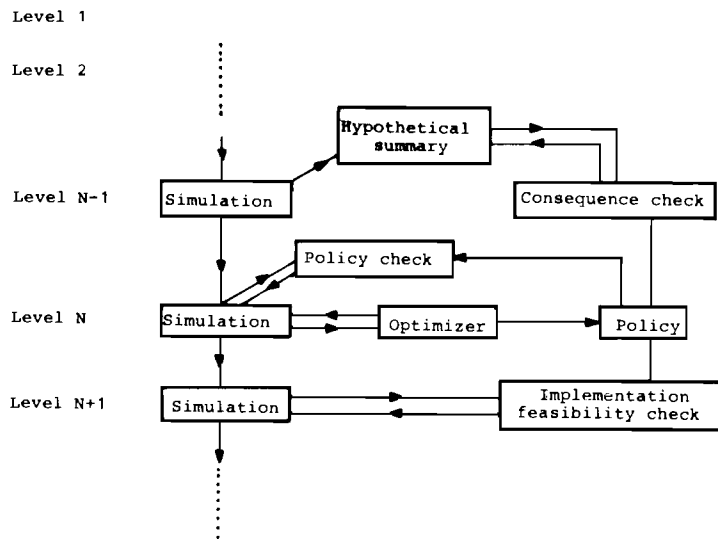

Figure 10. Flow chart for policy determination.

References

- [1] Dantzig, George B., and Holling, C.S. "Determining Optimal Policies for Ecosystems." Laxenburg, Austria, International Institute for Applied Systems Analysis, (forthcoming).
- [2] Holling, C.S. et al. "Project Status Report: Ecology and Environmental Project." IIASA SR-74-2-EC. Laxenburg, Austria, International Institute for Applied Systems Analysis, 1974.
- [3] Morris, R.F. et al. "The Dynamics of Epidemic Spruce Budworm Populations." Mem. Ent. Soc. of Canada, 31 (1963).

3.2. Salmon Watershed Management Case Study

C. Walters, R. Hilborn, S. Buckingham,
S. Rinaldi and M. Gatto

The salmon case study centers on a single region, the province of British Columbia in Canada (Figure 1). This system area has several of the dozen major salmon producing rivers around the rim of the Pacific Ocean from Japan to California. Salmon are born in the rivers, then go to sea for one to three years. At sea they may be exploited by an international mix of fishing fleets; most of the harvest occurs near the river mouth when the adult fish return to spawn and die. Because they have an orderly life cycle, a concentrated harvest period and a population size that can be easily determined, salmon are considered the most manageable of the large world fisheries. Many fundamental concepts of fishery management (e.g. stock-recruitment relationships, economics of exploitation) have stemmed largely from studies of salmon.

We had five basic reasons for choosing the salmon for a case study:

- 1) Our results should be generalizable to other fisheries around the world, and perhaps to other renewable resources;
- 2) Our results might have real benefits to people; the British Columbia fishery employs over 10,000 people, representing a gross income of 200 million (Canadian) dollars per year;
- 3) There is an extraordinary history of data on the ecological dynamics of the system;
- 4) There is a solid history of data of actual management performance in the absence of systems analysis; and
- 5) Perhaps most important, there is a clearly defined client for our results; we have a good working relationship with Environment Canada, the primary agency for salmon management in British Columbia.

1. Historical Background

Figure 2 shows historical changes in the two major salmon populations of the Skeena River. Prior to 1950, there was essentially no management, and the system was evolving toward a predator-prey equilibrium between the fishing fleets and the

salmon stocks. Fearing that the stocks might be driven to extinction, the Canadian government began instituting catch regulations in the early 1950s. Other nations (particularly Japan) were excluded from the fishery by international agreement (the so-called abstention arrangements) during this period.

Stock sizes began to recover after the mid-1950s; by 1970, a disastrous economic situation had arisen: investment in the fishery was not controlled and a larger and larger fleet was thus forced to share the same catch. Beginning in 1970 a program of license limitation was initiated to dramatically reduce the fleet size and, presumably, to make the industry more economically efficient.

Around 1970 it was realized that maximum average catches were likely to result from a "fixed escapement" policy in which the same number of fish are allowed to spawn each year. This policy was adopted and forms the basis for present management.

British Columbia is in a period of rapid economic growth, and in recent years there has been considerable pressure for watershed development. Several hydroelectric dams have been proposed, and it is likely that there will be urban and industrial development near the river mouths. Thus Environment Canada is having to deal with a much broader set of issues and institutions (Table 1). So far, the policy has been to completely oppose any watershed development that might influence salmon populations; this unyielding attitude will almost certainly have to change in the next few decades, especially in relation to urban and industrial development.

2. Framework for Analysis

There is no single problem about salmon to which we can direct appropriate systems techniques. Our case study deals with a hierarchic set of decision problems, as shown in Figure 3. We assume that broad decision about regional resource allocation will establish a (time varying) potential for salmon production. Within this potential, there are some basic strategy options for dealing with the enormous stochastic variation in production from year to year (Figure 2). Given a production strategy, there are several options for distribution (utilization) of the catch, ranging from no control (open entry "commons" fishery) to a complete government monopoly where the entire catch is taken by a single large trap. The production and utilization strategies that we may suggest are of no value unless we can show that these strategies can actually be implemented; thus we are examining several possible implementation tactics. Finally, we are concerned with mechanisms to translate the variable catch stream produced by management actions into a more stable and predictable income stream for the fishermen.

Table 1. Institutions and issues in salmon management.

KEY INSTITUTIONS	PROBLEM LEVELS		
	I	II	III
INTERNATIONAL: Salmon Commission	SALMON INTRASEASON TACTICS Equity in distribu- tion of catches among national fleets	SALMON LONG RANGE STRATEGIES Sustained yields	RIVER BASIN AND REGIONAL MANAGEMENT Maintenance of salmon habitats
FEDERAL: Environment Canada	Meeting long-range targets, equity among users, economic efficiency	Sustained yields, mix of species stocks, enhancement systems	Maintenance of salmon habitats
PROVINCIAL: Resource Secretariat	Opportunities for recreational users	Equity for recreational users	Recreational fisheries and wildlife, forestry
PROVINCIAL: B.C. Hydro	Short-term profits and employment	Stable economic returns and employ- ment	Regional mix of resources, industries, induced economic development
INDUSTRY AND ECONOMIC: Development Agencies	Short-term profits and employment	Stable economic returns and employ- ment	Regional mix of resources, industries, induced economic development

We are attempting to analyze the decision system of Figure 3 in two steps. First, we are doing a series of simple optimizations across options at each of the decision levels, assuming an optimal input pattern from the higher levels and perfect control at the lower levels. This first step should allow us to discard some options that are clearly inferior under most objective functions. Second, we are trying to evaluate a sample of the more promising overall options (combinations of options from all five levels) for changes in optima that might result from policy failure, imperfect control at the various levels, or changes in objective functions. This second step is essentially a simulation exercise.

3. Analytical Procedures

This section gives an overview of the decision options and analytical procedures we are using for each of the decision levels shown in Figure 3. Each of the analyses described here is intended to provide a different perspective for decision makers; we feel that a variety of perspectives should be useful even if no single coherent decision framework can be developed.

Level I: Regional Resource Decisions

In cooperation with Environment Canada, the British Columbia Resources Secretariat (forestry, recreational fisheries and wildlife), and with British Columbia Hydro (energy), we have developed a large-scale simulation model for the Skeena System. This model is designed to examine long-range (thirty to fifty years) patterns of watershed development, and consists of five basic components:

- 1) A synthetic hydrology submodel to generate runoff patterns (monthly) across the watershed;
- 2) A hydroelectric dam submodel that can accept alternative siting, construction timing, operation decisions, and can produce regulated storage and water flow patterns for any runoff input sequence;
- 3) A water quality submodel to simulate transport and degradation of pollutants, particularly silt (associated with hydro dam construction and forestry);
- 4) A population dynamics submodel for the major salmon and steelhead subpopulations (there are nineteen of these) that use various parts of the watershed; population changes and yields are represented as a function of harvesting policy, water flow, water quality, access to spawning areas (as affected by dams and forestry operations), and enhancement policy (hatcheries, spawning channels, etc.); and

- 5) A recreational fishing submodel to predict recreational demand and catches in relation to fishing quality and to alternative regional population growth patterns (as might arise from different economic development policies).

This model can accept a bewildering variety of development policies and tactical options (e.g. fishways to allow salmon passage around dams); so far we have used the model only in a gaming format with the cooperating agencies to obtain a broad picture of potential development impact on salmon. Our results suggest that there are only a few hydroelectric development options that would seriously affect the salmon, and these options have low priority with British Columbia Hydro. Clearly we need a more systematic procedure for identifying, testing, and evaluating the various broad options.

Level II: Production Strategy Decisions

The regional resource modelling provides alternative operating contexts for salmon production, expressed in terms of potential stock productivities and equilibrium stock sizes (carrying capacities) over time. For any context, we use stochastic dynamic programming to derive optimal control laws for salmon harvesting. These control laws specify optimal harvest rate (proportion of fish caught each year) as a function of stock size for a variety of possible objective functions.

We have developed such optimal control solutions under the assumption that watershed conditions will not change for objective functions emphasizing tradeoffs between mean and variability of catches (Figure 4). These solutions take account of the enormous stochastic variation that has been observed in salmon production; they should also be close to optimal for management response to occasional human disturbances (e.g. dam construction, pulses of toxic mine waste,) that do not have a persistent effect on watershed condition but may cause dramatic stock collapse for a few years.

Recently, Soviet scientists have called attention to the internal complexity of fish populations; essentially it appears that every managed population actually consists of many genetically and dynamically specialized subunits, analogous to firms within an economic or industrial sector (Figure 5). For the salmon, these subunits cannot be harvested separately; we have shown by dynamic programming that long-term harvests can be improved significantly if the overall harvest rate is modified to reflect subpopulation composition (Figure 6). That is, a bit of extra monitoring (composition as well as total abundance) may buy extra returns even if complex harvesting schemes are impractical.

Moving beyond simple stochastic optimization, we have been experimenting with various schemes for adaptive or "dual" control. We have examined several methods for estimating stock

production parameters, and have found that recursive regression techniques (Kalman filtering) with high rates of data discounting give very good control of mixed, complex simulated populations even when the regression model is simple (Figure 7). We have also obtained a few closed-loop control law solutions for situations where the model parameter estimates and the parameter covariance structure are considered part of the system state. These solutions have been obtained with dynamic programming where Bayesian pre-posterior analysis is considered part of the stage-to-stage process of state transition. Such closed-loop adaptive solutions are dramatically different from our stochastic programming solutions, but we are not yet certain what implications this has for management practice.

Finally, we have been trying to design harvest manipulation experiments to help identify the underlying form of the ecological production function (Figure 8). Simulation gaming is used to identify effective experiments in the face of alternative model proposals, and decision analysis is then used to sort out those experimental alternatives with the best expected payoff.

Level II: Utilization Strategy Decisions

Table 2 shows a spectrum of options for organization of the fishing industry, and a qualitative rating of these options for several benefit indicators. In the future we will develop this options-indicators table much more fully, substituting a more comprehensive and quantitative set of indicators. Some of these indicators can be readily computed from historical data; others can be developed by making long stochastic simulations using catch distributions generated in the Level II production analysis.

We expect that a small set of dominant options will emerge from the spectrum in Table 2. This smaller set can be examined in relation to a restricted set of indicators, using multi-attribute theory. Rather than specify a singly best option, we would prefer to identify ranges of indicator weightings for which each of the options would be optimal (inverse objective function analysis). From preliminary analyses, the most promising options appear to be:

- 1) Open entry with taxation to limit investment and provision of insurance against disasters;
- 2) Restricted entry with licenses valid only in specified fishing territories; and
- 3) Monopoly trap system: doing away entirely with the fishing fleet.

Present management is close to option 2; evaluation of option 1 will require us to develop a good dynamic model for investment and disinvestment in the fishing fleet ("population dynamics" of the fishermen).

Table 2. Strategic and tactical options for organization of the salmon fishery.

STRATEGIES	TACTICAL OPTIONS	Annual Management Effort	Employment	Profits	Catch	Probability of Policy Failure	Immediate Social Change
OPEN ENTRY	No catch control	none	high	0-very low	low	highest	+
	Fixed season catch control	low	high	0-very low	medium	high	+
	Adaptive catch control	medium-high	high	0-very low	high	low-medium	+
	Tax-insurance control	low	high	0-very low	medium	high	+
RESTRICTED ENTRY	No catch control	very low	medium-high	high	high	high	+
	Fixed season catch control	low	medium	high	high	medium	0
	Adaptive catch control	medium-high	medium	high	very high	low	0
	Fishing territories	low	medium-low	high	high	low	-
MONOPOLY TRAP SYSTEM	Fixed season	high	low	very high	very high	low	-
	Adaptive catch control	very high	low	very high	very high	none	-

We have undertaken a multi-attribute utility analysis of preferences of various people interested in salmon. We explicitly recognize five interest groups in this study: (1) troll fishermen; (2) net fishermen; (3) sports fishermen and industry; (4) Indians; and (5) regional public. We have used the standard methods of multi-attribute utility analysis to construct utility functions for each of these five groups, using members of the Ecology Project to pretend they are part of the specific interest group. In 1976 we shall attempt to repeat the analysis on the real members of the interest group. Using the utility functions we have derived, we can analyze any proposed development scheme to identify conflicts between groups. It is our hope to use this analysis to generate some new proposals for development that involve less conflict and are in some sense "better".

Level III: Implementation Tactics

The analyses at Levels II and III can provide idealized targets for management, but they will remain academic exercises unless we can demonstrate practical ways to implement them. The biggest practical difficulties occur within each fishing season when regulations are modified from week to week as catches accumulate and stock size forecasts are revised. At present, the key control variable is the number of days open for fishing each week, though there is some regulation of the type of fishing gear (size and type of nets). Though there is license limitation, fishing effort can change dramatically from week to week; fishermen are free to decide when to go out, and whole fleets can move from one river system to another.

A few of the utilization strategies at Level II call for the elimination of within-season regulation of total catch. In all cases it will be necessary to have mechanisms for distributing the catch across the fishing season; processing (packing and cannery) facilities are limited, and there is risk of genetic damage to the stocks if the fish running at any time receive much heavier exploitation than the fish running at other times.

There are two extreme options:

- 1) An elaborate adaptive control system involving statistical run and effort forecasts, close monitoring of catches and escapements, and weekly modification of regulations; and
- 2) A simpler and less costly fixed regulation system in which preseason stock forecasts are used to set a schedule of weekly regulations that is not modified during the fishing season.

Figure 9 shows one structure that we have developed for adaptive, within-year control; we have completed most the data analysis necessary to fill in the functional components of this

system. Using the data and relationships developed for adaptive control, it is a simple matter to design reasonable rules for establishing fixed regulations.

We have tested alternative regulatory options by stochastic simulation (Figure 10). Adequate data are available to establish bounds and probabilities for the variety of input situations (forecast errors, changes in timing of fish movements, changes in fishing power per unit of effort) that any control system is likely to face in practice. By computerizing the control system and feeding it a stochastic stream of input situations, we have established probability distributions for deviations from target catches. These probability distributions are fed upward as input for more refined simulation and optimization modelling at decision Level II.

Level X: Lest We Forget People

Some management choices at decision Levels II and III might produce good overall biological or economic returns, yet may be unacceptable or extremely harsh for the individual fisherman. Certainly the maximum yield, fixed escapement production policies are of this type: they result in the highest average catches, but also the greatest year-to-year variation in catches. Under current policy, fishermen will be forced to use existing federal and provincial unemployment insurance programs when no catches are allowed.

An alternative to current policy would be to internalize the unemployment insurance system, by taxing catches in the good years and feeding this money back to the fishermen in the bad years. The simplest system is to allow each fishing boat to choose a minimum guaranteed income level, and to impose a proportional tax on income above this level. Simulation and dynamic programming have been used to estimate the necessary tax rate for any desired minimum income level in conjunction with various management strategies from Levels II and III.

An added benefit from some sort of tax/insurance system would be to give Environment Canada more flexibility in choosing basic harvest strategies. Under existing policy, it would probably be politically disastrous to shut down the Skeena fishery for even one year; any proposal of that sort would almost certainly be turned down by the Minister of the Environment.

4. Coping With the Unexpected: Policy Resilience Analysis

For each of the three decision levels shown in Figure 3, our analyses are explicitly directed at stochastic variability. However, it would be foolish to assume that we have thought of every possible source of variability and uncertainty, or that there will never be more extreme conditions than we have

detected and represented from historical data. It is easy to list a few of the possibilities:

- 1) A new source of pollution in the watershed could decimate stocks before it could be detected and controlled;
- 2) The international treaty system could fail, resulting in overexploitation by high seas fishing;
- 3) Disease organisms, algae blooms or some other agent, could wipe out enhancement production (at least for a few years);
- 4) Several drought or flood years could occur in sequence, with especially disastrous effects on pink salmon;
- 5) An economic depression could drastically lower the value of catches, and stimulate the government to invest in other resource developments (e.g. hydro-electric dams).

The possibilities are almost endless, but the key point is that something bad is bound to happen, and policy combinations with poor performance in the face of the unexpected should be identified and avoided. For example, it would be foolish to allow the development of a very large fishing fleet completely dependent on enhancement (hatchery) production; should any production failure occur, this fleet would become a serious economic burden (witness the Peruvian anchovetta fishery).

The hope is that we will be able to identify resilient policy combinations that are nearly as productive as the best of the unsafe options. This is not likely; usually the most productive or profitable policies are also the most risky. We are not in a position to judge and weigh the risk aversions of the various interest groups involved in salmon management; these are political problems. Our task will be to present the production-risk tradeoff so that it can be clearly understood by decision makers.

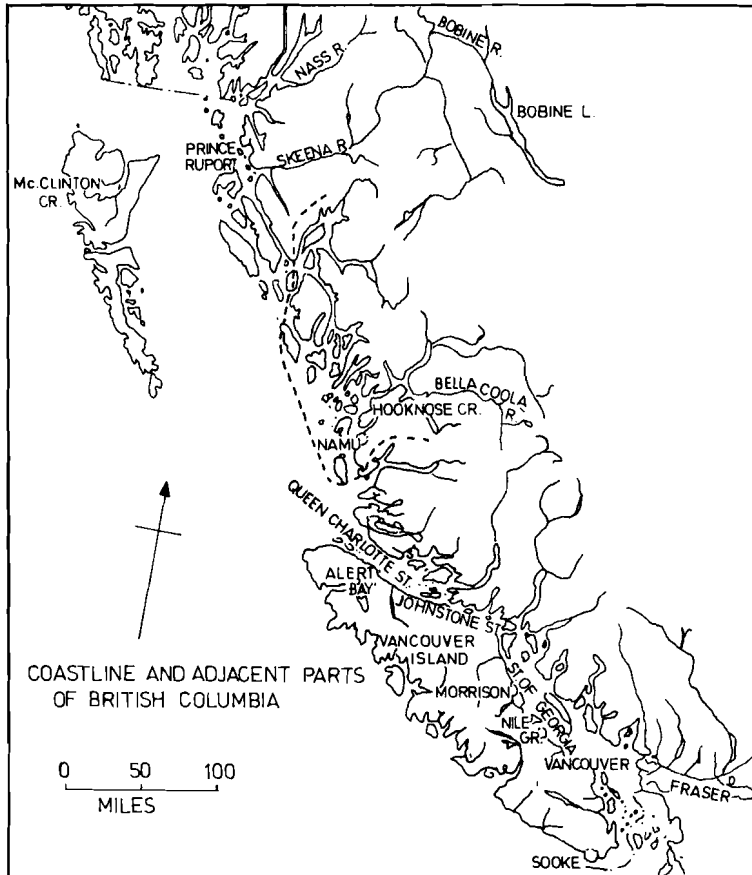

Figure 1. Regional context for salmon management (British Columbia, Canada): conflicting water uses; several fishing fleets; many river systems; many populations with different productivities; management clients not clearly defined.

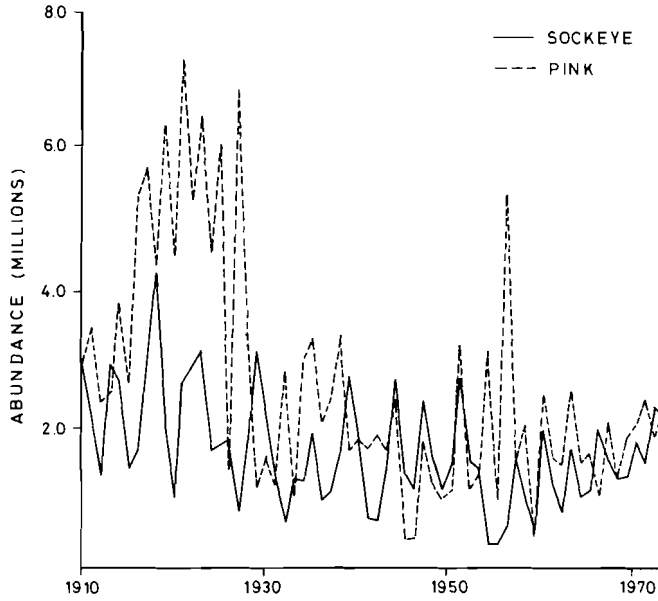

Figure 2. Historical changes in Skeena River salmon populations.

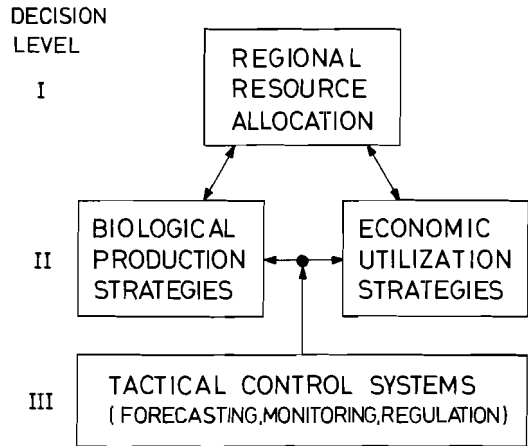

Figure 3. Salmon case study, hierarchic levels.

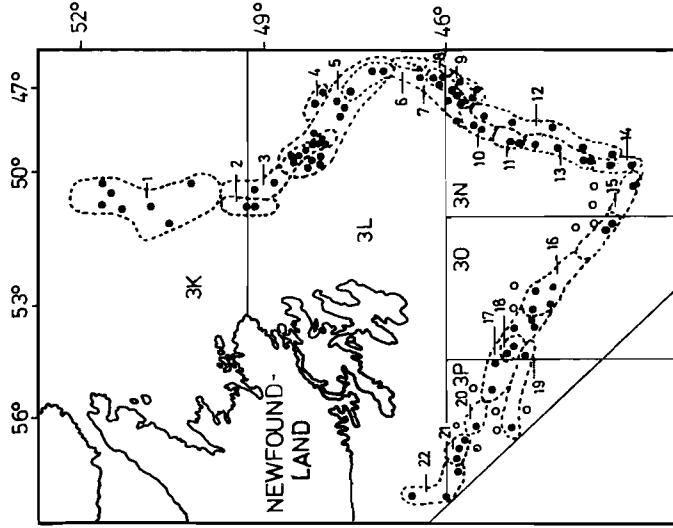

Figure 5. Areas of redfish elementary populations (NN 1-22) on the Newfoundland bank.
 ● Location of trawl catches
 ○ "Placebo" trawl catches

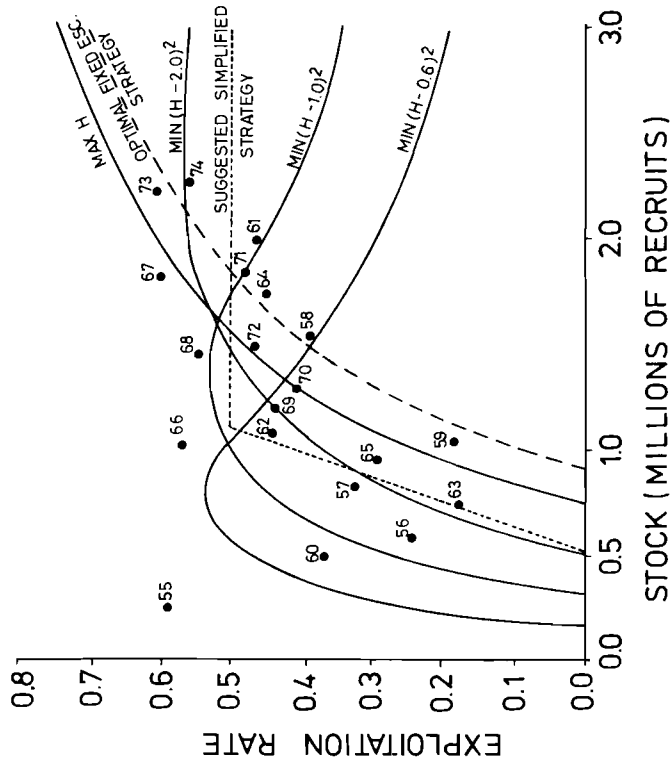

Figure 4. Optimal harvest strategies in relation to actual management practice: can we show an incremental direction for improvement?

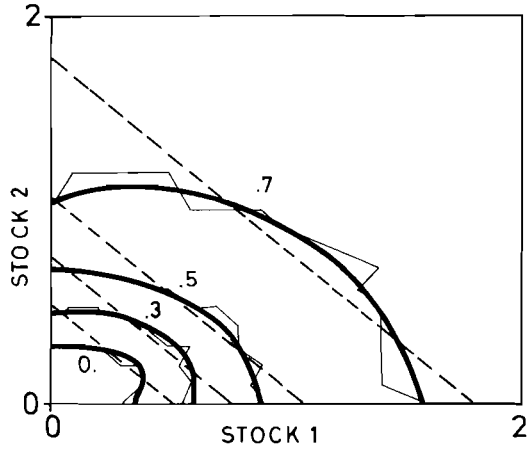

Figure 6. Optimal harvest rates for a mixture of two subpopulations.

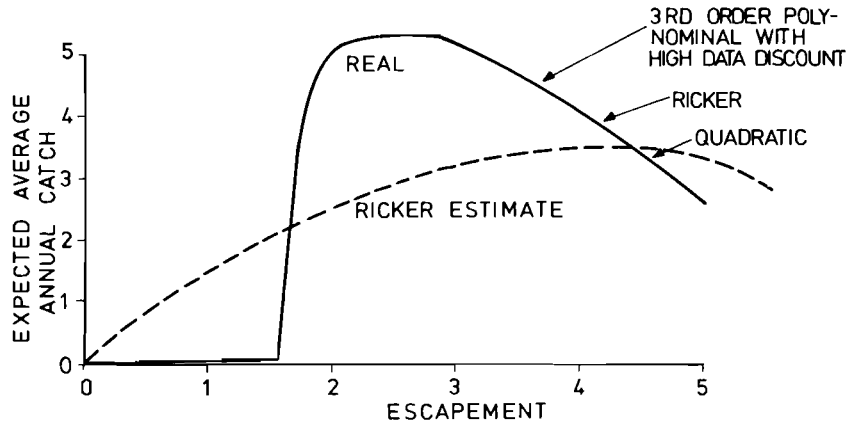
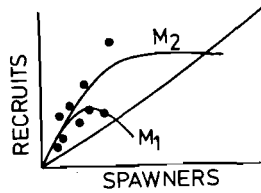
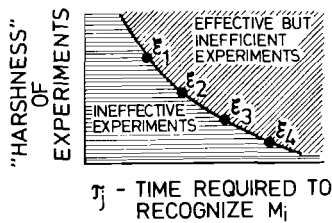

Figure 7. Yields obtained from a complex model ("real" population) compared to yields predicted by various simple models using adaptive parameter estimation.

1. Identification of alternative models, M_1, M_2, \dots



2. Design of alternative experiments, $\epsilon_1, \epsilon_2, \dots$. manager selects experimental controls, analyst secretly chooses model and runs simulation until manager recognizes M_i . Over many such gaming trials, develop:



3. Time stream evaluation of each $M_i - \epsilon_j$ combination by Monte-Carlo simulations

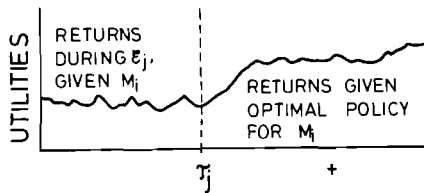

$$V_{ij} = \text{TOTAL UTILITY FOR THE TIME STREAM}$$

4. Subjective probability assessments $p^*(M_i)$ and selection of best experiment

	ϵ_1	ϵ_2	\dots	ϵ_n
MODELS				
M_1	V_{11}	V_{12}	\dots	
M_2	\dots	V_{22}	\dots	
\dots				
M_m	V_{im}	V_{2m}		

$$V_{\epsilon_j}^* = \sum_j p^*(M_i) V_{ij}$$

INVERSE PROBLEM: FOR WHAT RANGE OF p^* IS EACH ϵ_j OPTIMAL ?

Figure 8. Design and evaluation of adaptive experimental policies.

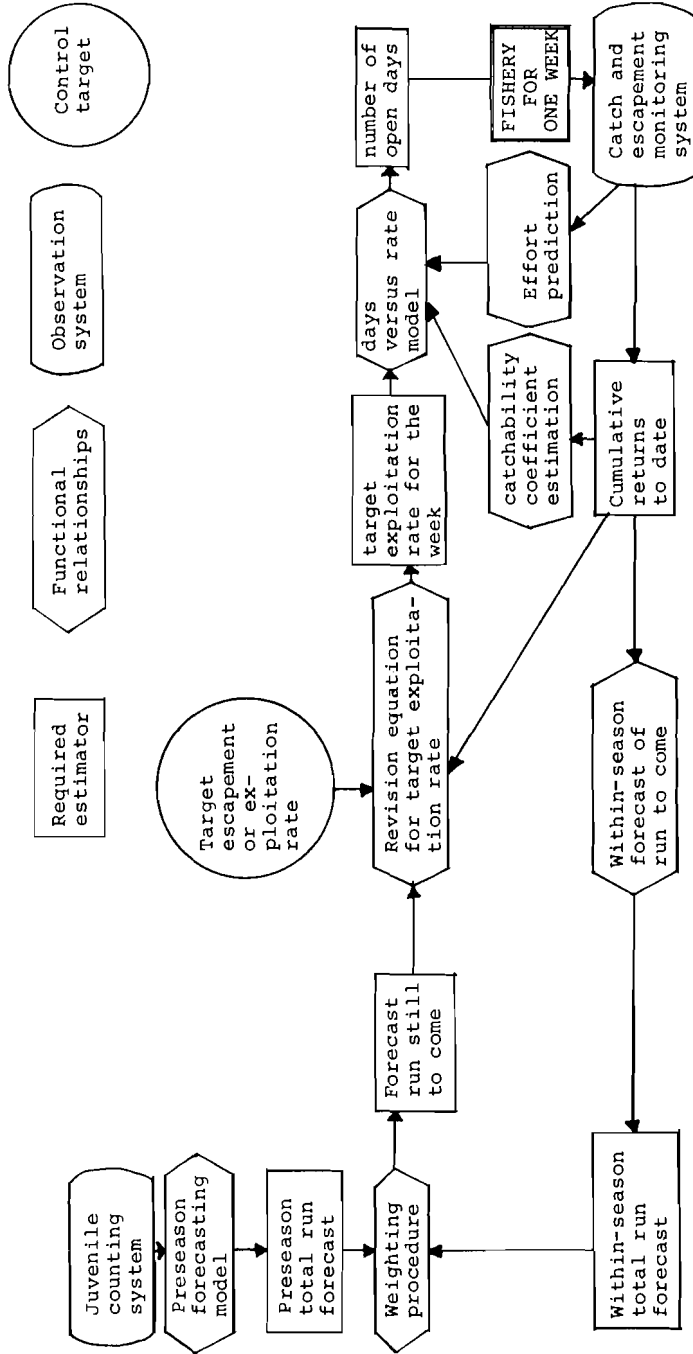

Figure 9. A control system structure for within-season salmon management.

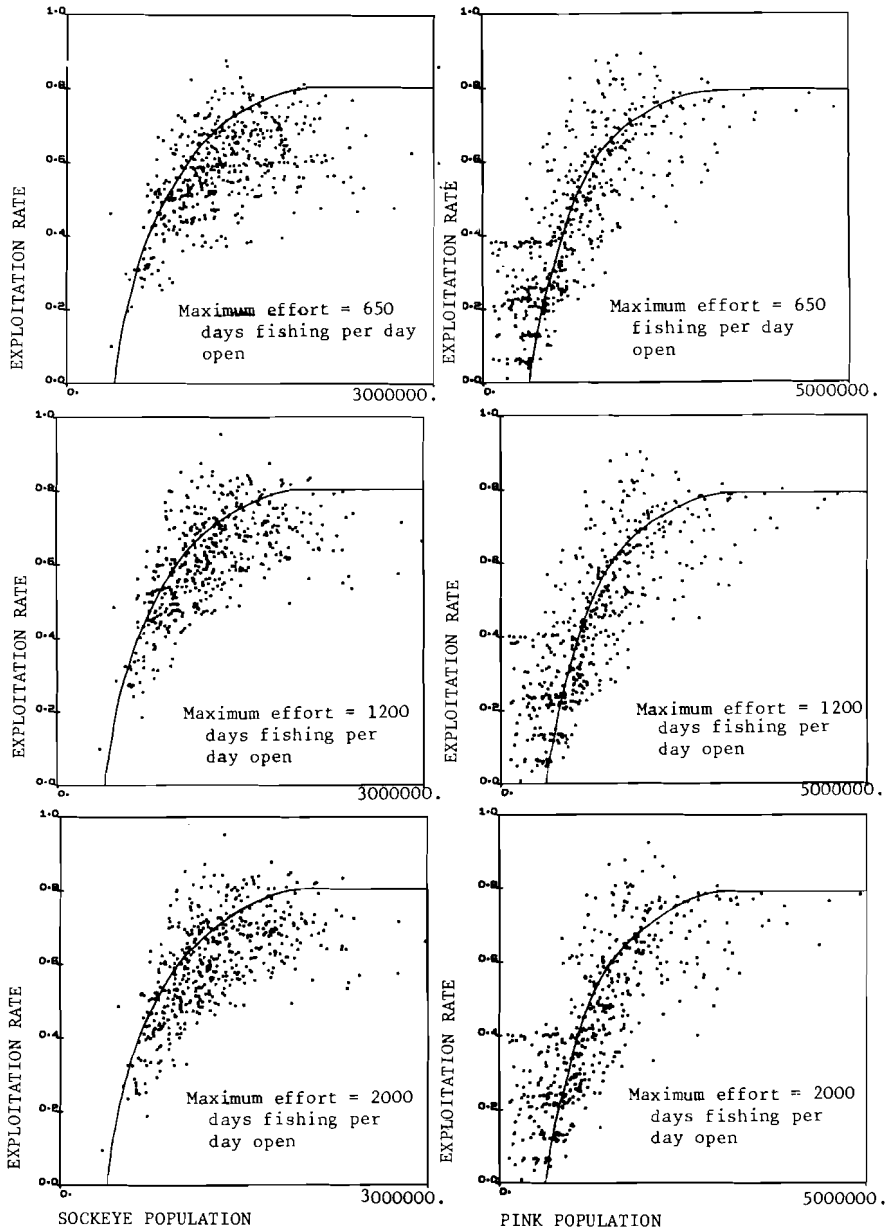

Figure 10. Simulation performance tests where the target curves are chosen to give long-term maximum sustained yield. Panel A-600, Panel B-1200, and Panel C-2000 licenses available.

3.3. Regional Energy/Environment Case Study

W.K. Foell

This project was initiated early in 1975. The research project is the development and comparison of a set of case studies of regional energy/environmental systems. The case studies are the focus of the application of an array of systems analysis tools as practiced by the methodologists of a number of IIASA research groups. As a result of the case studies, it is hoped (and it is already proving true) that new concepts and methodologies will be developed for the management of energy and environmental systems.

The description here is divided into two parts. Part I presents the research project as originally conceived and laid out by Foell at IIASA. Part II presents a brief synopsis of some of the current developments within the research project; the course of the project remains essentially as described in the original research proposal.

Part I. Integrated Energy System Modelling
and Policy Analysis:
A Description of an IIASA Research Program¹

1. Introduction

Part I describes an IIASA research program which was initiated early in 1975. The research project not only cuts across a number of disciplines and groups at IIASA, but is also conducted in close cooperation with external research institutes in IIASA member countries. This paper lays out a proposed initial research structure and interinstitutional framework as a basis for the work of the coming months. It is the result of a synthesis of my initial conception of this research and a distillation of the input and suggestions from several individuals at IIASA. Although the research is already well underway within the general framework described here, the program structure is meant to be flexible and dynamic. As the collaborating institutions play an increasing role in the coming months, it is anticipated that program changes will evolve because of the innovative nature of both the research content and the interinstitutional format.

1.1 Background of the Research

Energy Planning and Policy Analysis

Energy has achieved a new and prominent status in our societal planning processes--it is becoming an explicit rather than implicit variable. For example, in the United States, this phenomenon has occurred at almost all levels of decision making, ranging from the home-owner developing his preference for a specific air conditioner type or model, to national and international discussions over mechanisms to combat inflation through reductions of petroleum demands. Planners in the public and private sectors of agriculture, architecture, urban and transportation systems are beginning to treat energy more explicitly. Because of the complex manner in which energy is intertwined with virtually all of the characteristics of an industrialized society, this recognition of the importance of energy is having a strong influence on virtually all technological, economic and environmental decision-making bodies.

¹ Suggestions and contributions to this paper were also provided by several individuals at IIASA, including the following: R. Avenhaus, J.P. Charpentier, R. Dennis, K. Ito, H. Knop, W. Nordhaus, B. Sazonov, H. Stehfest, A. Suzuki, H. Swain, C. Walters and J. Weingart.

In contrast to North America, energy planning in many European countries has for many years played a more explicit role in the public sector. In part, this is due to the fact that energy has long been considered a scarce resource in many of these countries.

Energy Embedding at the Regional Level

In several industrialized countries, this greatly intensified concern with energy planning has emerged at all levels of government. The grass roots public concern about energy and its effect on day-to-day existence has stimulated greater action on the part of local, state, and regional governments. It is clear that national energy policy formulation must take subnational and local characteristics into account. One major reason for this phenomenon originates with the diverse ways in which each region within a nation or within a part of the world depends upon energy. For example, a primarily consuming region that neither extracts nor processes primary fuel in general employs a distinct set of objectives and values in formulating energy policies; these are in most cases different from those in an energy-producing region. In a similar manner, considerations differ between industry- and tourism-oriented regions, between agricultural and urban regions, etc. The maze of interdependencies between energy and the total human enterprise in each region binds its energy policy objectives tightly to the natural and man-made characteristics of that region. The recognition of this bond has made apparent the great need for an improved understanding of energy systems and their embedding in society at the regional level.

The major world or global models provide little regional or even national energy policy guidance. Even the Pestel-Mesarovic world model [15], although treating energy as an explicit variable in a world divided into ten regions, provides only limited assistance to regional energy decision makers.

Alternative Energy Futures

Many national and global energy studies now underway are exploring the consequences of a spectrum of supply scenarios, e.g. the nuclear fission, fusion, and solar options. In addition, various studies are underway to provide information on future energy demands. However, conspicuously missing from the current array of energy research is a major class of scenarios that integrates demand and supply scenarios and their embedding in a specific regional environment.

It has been convincingly demonstrated many times (e.g. Foell [7], Häfele [10]) that over almost any conceivable time period the limitation on man's use of energy will not be due to the amount of energy stored in the earth, or in the sea, or in space. That is, the potential energies from breeder reactors, fusion, and the sun are enormous. The limit will

most probably originate from man's inability to convert this energy into a useful form at acceptable costs, or from his unwillingness to accept some of the consequences that may accompany the conversion of these sources of energy into useful work. These consequences may be in the form of a broad spectrum of environmental effects (with the term environment used here in a very general sense) or in the form of unacceptable risks--many of which will be poorly understood, vaguely perceived, or even hypothetical. Some of these consequences may be primarily global in nature, but a majority of them, although having certain universal characteristics, derive a specific meaning only when related to a given region or human environment.

A second or perhaps even more controversial aspect of man's future energy systems is their relationship to economic growth and well being. Are there global or regional limits to our energy systems? If there are limits, how can these systems be designed so as to maximize human welfare? What would be the economic consequences of such limits for the less energy-intensive countries or regions; for the less-developed regions and countries? Will these regions need to consider alternative energy systems, e.g. solar or low-energy technologies? These questions of energy resource management cannot be answered from a purely global perspective.

1.2 Integrated Energy System Modelling and Policy Analysis - An Applied Research Theme

In simplest terms, the research project described here is the development and the comparison of a set of case studies of regional energy systems. Within this context, "regional" is rather ill-defined, and really means an energy system of limited size such that one can examine its characteristics in a reasonably detailed way so as to provide a degree of disaggregation sufficient to allow significant policy analysis. In the case of the Wisconsin regional study, a prototype energy system for this research project, the region was the State of Wisconsin [8]. In the case of a small nation, the region may be the entire country.

The primary purposes of the study are at least three-fold:

- 1) To identify existing patterns of regional energy use and supply at appropriate levels of disaggregation;
- 2) To compare alternative methodologies for regional energy forecasting, planning, and policy development; and
- 3) To use the above methodologies to examine alternate energy policy strategies for each of the regions, to explore their implications from various perspectives using sets of indicators related to environmental

impacts, energy use efficiency, etc., and to evaluate the adequacy of the alternative methodologies as policy tools.

Out of the above three items should evolve improved methodologies for energy systems research and policy analysis. The comparative method, intersecting the different disciplines and nations that would be involved in this project, should serve as a powerful tool to the mutual benefit of the participating nations as well as of other countries facing similar energy problems. It could also serve as a prototype for similar studies of other resources such as materials, water, air--i.e. as a vehicle for development of an approach for improved resource management.

2. The Research Program

2.1 The Case Study Approach

Case studies have proven to be a powerful tool for the focusing of IIASA research because of the applied methodology and the conceptual developments that have been emerging from such studies. The unusual nature of the IIASA institutional structure, research atmosphere, and staff composition make it imperative to carefully select these applied problems. Several obvious criteria present themselves as a basis for the selection. Among the more prominent are the following:

- 1) The case studies must lie within a set of applied problems from a general universal class;
- 2) Each of the studies should be reasonably defined with a good data base;
- 3) There should be an identifiable user for the output of the study, ideally policy as well as scientific clients;
- 4) Each of the studies should have enough innovative possibilities to extend certain fundamental methodological and conceptual issues;
- 5) The studies should provide an opportunity for a strong interrelation and rich interaction among several disciplines and groups at IIASA;
- 6) The study must be of a scope and size that it can yield meaningful results in a reasonable time period. Within the current IIASA personnel framework, this is of the order of one year; and
- 7) The study would ideally build upon the work of already existing projects external to IIASA.

Each of the above criteria has been considered during the design phase of the project described in this paper. It is believed that the project as described below goes a long way toward satisfying most, if not all, of these criteria.

2.2 General Research Format

A small team of IIASA scientists, cutting across several existing research groups, has been responsible for the initial structure of the research project. This core group is developing a working relationship with energy research projects in several IIASA member countries. The three research groups that are collaborating in the first phase of the IIASA Research Program are:

- 1) The Energy Systems and Policy Research Group of the Institute for Environmental Studies, University of Wisconsin, Madison, USA;
- 2) Institut für Energetik, Leipzig, German Democratic Republic; and
- 3) Institut Economique et Juridique de l'Energie at the University of Grenoble, Grenoble, France.

Discussions for later participation are also underway with two additional research institutes in other IIASA member countries.

Each of the collaborating institutions was chosen because it has an active research program that studies energy systems from a broad resource management perspective. Equally important in the choice of the collaborating institutions is the greatly different planning and policy framework in the respective countries.

The overall interaction between IIASA and the collaborating institutions is shown in Figure 1. The core IIASA staff will work closely with each of the collaborating institutes, and members of each of these institutes will spend some time at IIASA. As indicated in Figure 1, there will be an interinstitutional flow of models, data, and personnel, with the latter being exchanged either on a short-term basis or in some cases for a longer period of time. For example, personnel from one of the collaborating projects may spend some weeks at IIASA. As shown in the dotted square, planning for a followup phase is already underway, with existing energy projects in other member countries preparing for participation.

Emphasis will be given to comparison as a method for illumination of the salient characteristics and differences among the regional energy modelling and policy analysis methodologies. The comparisons will be achieved through a research program that includes the research stages shown schematically in Figure 2. These are discussed below in more detail.

1) Communication

One of the keys to this research program is the establishment of communication between already existing research projects. It is important that the research not be diluted through the inclusion of too many research institutes--although the number could be expanded as the research continues if it appears desirable. Effective communication has already been established among the initial three collaboration research groups. These three integrated energy research projects will form key components in the study.

As the research structure evolves, and we gain some experience with handling comparative questions of data, models, policy evaluations etc., periodic reports will be issued to provide a basis for the development of a Followup Phase to the project with another set of countries or regions having greatly different energy system characteristics.

2) Definition of the Energy System Comparisons

This work will define those areas in the energy systems that will be modelled, compared, etc. This is an important stage of the research since it will structure much of the activity in the coming months. Included in the definitions are the general questions:

Which models will be analyzed and to what degree? Demand? Supply? Environment?

How much effort will be devoted to building new models or to modifying existing models?

What data will be required for meaningful analyses of the models and for a comparative policy analysis?

What policy questions are appropriate for evaluation of the models?

Some of the above questions have already been answered whereas others have been discussed at small working sessions held between April and July of 1975 with participation by the IIASA core group and by each of the collaborating institutions.

Section 3 of this report describes a proposed structure of these research components, including areas of focus, data requirements, suggested application and development models.

This proposed structure has been discussed at these working sessions.

3) Conformable Energy Data Basis

In order to understand and evaluate the utility of the various methodologies for forecasting planning and policy analysis, it will be necessary to work with consistent sets of

data. The development of consistent sets will require effort very early in the research program. Examples of these sets would be time series of energy demand in each of the sectors, energy prices as function of time, etc. This is discussed further in Section 3.

4) Comparison of Models

After the areas of comparison are defined, e.g. supply, demand, environmental impacts, the tools used by each of the participating projects will be compared according to methodology, areas of application, constraints for usage, domains of applicability, etc. IIASA would play a major role in this comparison area.

5) Development of New Models, Methodology and Concepts

This phase of the research represents one of the rewards --the possibility of the synthesis of the methodologies, of new concepts arising from the mutual exposure of the scientists to alternative concepts, of imaginative new research directions. At the present early stages of the research, it is too early to predict what the payoff might be in this area. However, it is already clear that exchanges of models or of model components are occurring.

6) Multinational Workshop

The project will culminate with a five-day workshop at IIASA tentatively scheduled for November 3-7, 1975. Cross-comparisons will be carried out with various combinations of models and policies applied to each of the regions. Participation in the workshop will include energy experts from each of the regions, IIASA scientists, and policy-makers from each of the regions. The workshop is described in Section 4.

As indicated in Figure 2, there are certain feedback loops within the overall structure of the research program. New data systems and improved models will hopefully be the result of certain phases of the research program. In addition, as shown in the diagram it would be possible for the project to have followup phases with other countries or regions becoming successively involved, using the collaboration of the first three countries as a prototype approach. During some of the earlier discussions on this research project, consideration was given to including a developing country in the followup phase. An additional suggestion was that the methodology be extended to other resources in addition to energy. These two considerations are under active discussion within the IIASA core group.

3. A Proposed Disaggregation of Regional Energy Systems

To provide an initial working structure for the design of the research program that included a) evaluation and choice of models to be included in the research, b) assessment of data availability, and c) formulation of appropriate policy questions, the components of an integrated energy system have been laid out according to the structure outlined in Table 1. The Wisconsin Regional Energy Model served as a prototypical example of these components.

As a tentative basis for the more detailed structure of the research program, each of the macrocomponents in Table I is laid out in more detail in the following subsections. These structures are proposed as a vehicle for implementing comparisons of the case studies, data sets, models, etc. They should be viewed only as a starting point for discussions.

3.1 Energy Demand

Each of the initial three regions would appear to have significantly different patterns of energy demand. Furthermore, the demand forecasting and planning procedures in each of the three differ greatly. For this reason, a practical initial step is to provide a descriptive framework for the components of demand. A second step would then be the specification of the quantitative tools used to describe or forecast these demands in the future within a specific planning process at some level of disaggregation (which may differ from the level used for descriptive purposes). A third step is the examination of appropriate policy questions associated with energy demand. Each of these three steps or components of the demand question is described below:

1) Descriptive Structure

A general descriptive structure is shown in Figure 3 where the demand processes are categorized according to economic sector, physical process, and fuel type. The differences and similarities in demand patterns across the regions should be of great value in developing the concept of national or regional "energy indicators",² i.e. coefficients or parameters that could be useful indices in evaluating the state of a broad spectrum of energy systems.

²Within the more general context of environmental management, these are analogous to the "Ecological Reynold's Numbers" referred to by Holling [12].

Table 1. A descriptive structure of an integrated regional energy system.

<p>1. Energy demand component:</p> <ul style="list-style-type: none">a. Economic sector;b. Physical process;c. Fuel type.
<p>2. Energy supply component:</p> <ul style="list-style-type: none">a. Fuel type;b. Source.
<p>3. Environmental component:</p> <ul style="list-style-type: none">a. Air;b. Water;c. Land;d. Standards and monitoring;e. Public health.
<p>4. Socio-economic component:</p> <ul style="list-style-type: none">a. Demography;b. Land use;c. Urban design;d. Fiscal considerations.

In the descriptive framework of Figure 3, the question of dimensionality in time and space is a key one. An initial step (designated here as the zero level of complexity) would be to specify annual demands for each of the three regions.

A "first level" complexity would include more disaggregation in space and in time, e.g. seasonal demands and demands according to urban and rural locations. These would be useful in evaluating approaches to land use planning. A second level of complexity might associate these demands even more explicitly with given societal activities. The appropriate choice and definition of these levels of complexity should evolve during the early stages of the research program.

2) Comparison and Evaluation of the Energy Demand Models

One of the important outputs of this research will be a better understanding of the applicability of various demand modelling approaches under a wide range of conditions, and of the need and opportunities for new techniques. As an initial basis for this discussion, the classification and descriptive framework suggested by Charpentier [3,4] at IIASA has proven very useful. Representative of the types of characteristics in his classifications are:

a) Type of Model:

Econometric (correlation);
Optimization;
Simulation;
Scenarios; and
Input-output (static and dynamic);

b) Other Characteristics:

Linkage to the economy;
Linkage to supply;
Disaggregation in time and space;
Input data requirements (disaggregation, etc.); and
Output.

The linkage of these models to national and regional energy systems will be of great interest.

3) Some Representative Policy Questions

Within the framework of the modelling and planning techniques used in the regions, several policy questions will be posed with the objective of evaluating the applicability of the array of policy analysis tools that emerge from the research. A few representative policy questions are:

- What effect would the phased introduction of specific techniques (e.g. greater reliance on mass transportation, or on the auto, modified building or urban designs, modified agricultural technologies) have on energy demands?
- What would be the consequences of a gradual and long-term transition to a high, low or zero energy growth society (as described in the recent Ford Foundation's Energy Policy Project Report)?

3.2 Energy in the Agricultural Sector

Because of the special importance of food production, processing and distribution in the world today, and because of the important role that energy plays in the food system, special emphasis is being given to food-energy relationships within the program of Regional Integrated Management of Energy/Environment Systems.

1) Major Objectives

The major objectives of the agricultural energy use comparison can be divided into two components:

- a) Descriptive: To examine the differences and similarities of energy use in the agricultural sector of the study regions. This would be done by looking at patterns of energy use in the crop production and the livestock production subsectors, and the interrelatedness of energy use between these two subsectors. If data permit, the food processing subsector energy use should be included here in agriculture. The relative division of energy use in each of the agricultural subsectors would also be described.
- b) Policy: To examine specific food-energy policy questions. For example, what potential is there in these regions for energy conservation in the agricultural sector without causing a loss in crop yields and without greatly expanding crop acreage. Environmental considerations would play a role here, since some strategies of energy conservation might be more conserving of the long-range ecological, productive potential of the land than others.

2) General Overview

Figure 4 shows a sample block diagram of the types of components and pathways that could form the core of the agricultural sector's energy use comparison and analysis. In the diagram, direct energy use and indirect energy use are noted. Direct energy is the per hectare gallons of gasoline; indirect energy is the energy required to produce fertilizer. There are four major areas of data of interest:

- a) Production and land use (e.g. hectares of land in each major crop and production for each major crop);
- b) Energy use per unit of production (e.g. gallons of gasoline/hectare/year, hours of labor input/hectare/year);
- c) Flow of agricultural material (e.g. agricultural production used locally, exported, imported, used for feed, or going to food processing);
- d) Food processing energy per unit of production (e.g. kcal/unit output or kcal/unit of value added).

It is felt that (b) above will be one of the most interesting and important data sets for an extremely meaningful study; yet it will be one of the most difficult data sets to develop.

3.3 Energy Supply

In the energy supply area, a research structure is suggested similar to that described above for demand, i.e. descriptive, model comparison, and policy analysis. Each of these is described briefly below. The suggested descriptive structure, based upon previous work at IIASA, is presented.

1) Descriptive Structure

In general, energy supply should be specified by type, origin, and special characteristics, e.g. energy content, important impurities such as sulfur content. A reasonable time series of these data, as well as cost information over that time period, would be useful. For the purposes of specific policy questions such as feasibility of district heating, energy recovery from waste products, some locational information might be useful.

2) Comparison and Evaluation of the Energy Supply Models

As in the Demand Section above, there are several categories according to which the supply models can be described and compared. A more tightly structured comparison should evolve in the course of the study. Some initial steps are already underway in connection with two well-known supply models, the model developed by Finon et al. at Grenoble [5,6] and a model developed and applied at IIASA [9]. Both of these models

are based upon optimization procedures involving linear programming techniques. It is proposed that these models can be examined for their applicability to the regional energy supply questions of interest here. The supply models in use at the Institut für Energetik in Leipzig [11] are also based upon optimization procedures; as further information about the Leipzig models becomes available, it will also be analyzed for general applicability in the regions.

To provide a basis for further discussion of the supply area, the basis of the IIASA supply model and the requirements for its application to the one or more regions is described here.

The IIASA Supply Model: If it is assumed that the energy system is comprised of m energy supply categories (coal, oil, nuclear etc.), and n demand categories (transportation, household, etc.), then the question arises how to allocate in an optimal way the supplies to the demands. Here the term "optimal" has to be defined. It is clear that not every supply category can meet every demand (e.g. electricity cannot be used for air traffic); in addition, there exist competitions for the supply as well as for the demand side. This means that boundary conditions have to be taken into account. Furthermore, if one considers a planning horizon over several years, and optimizes the allocation for each year separately, then changes in the allocation may occur that cannot be tolerated from some economical or other point of view. Problems of that kind may call for an iterative procedure.

The IIASA model has been developed by Häfele, Manne and Shikorr (HMS) for the study of the optimal supply of energy for a model society over a planning horizon of seventy-five years, going through a transition from fossil to nuclear fuels and using total discounted costs as an objective function. In a continuation of that work, Suzuki and Avenhaus [17] used Hoffman's demand estimates for the US through the year 2000 [13] and analyzed if and under what circumstances the energy supplied by the HMS model could meet the energy demand of the different demand categories. In contrast to Hoffman's work and according to the HMS model, different points of time were considered. An illustration for the supply and demand categories used in reference is given in Figure 5. In addition, Konno and Srinivasan [14], and Suzuki and Schratzenholzer [16] have carried out numerical calculations in order to study the sensitivity of some of the more important parameters of the models. It is not appropriate to report here on the details of these results; instead an outline is given to show what is necessary for similar studies that could be used for comparative purposes.

The following information and data are necessary to study supply problems along lines similar to those carried out at IIASA as described above:

- a) Demand and supply categories have to be specified, depending on the degree of aggregation necessary and possible for the whole study, as well as projections for the totals of the supply and demand of the different categories over the whole planning horizon;
- b) The planning horizon as well as the time steps for the optimization procedure (e.g. 1975-2025, with five year time steps);
- c) The optimization criterion;
- d) The allocation coefficients from each of the supply to each of the demand categories (e.g. unit cost if the optimization criterion was costs);
- c) All the boundary conditions to be taken into account, both qualitatively and quantitatively, projected over the whole planning horizon.

3.4 The Solar Supply Option

Solar energy is emerging as a strong contender for playing a major role in future energy supply systems. For this reason, and because IIASA has an active research program investigating the several aspects of the solar supply option [18], it will be considered explicitly in this research program.

In principle, solar energy can be converted via a large menu of technologies to heat, electricity, shaft horsepower and synthetic fuels. None of these has achieved the status of a fully commercialized technology with the exception, on a relatively small scale, of domestic water heating. Domestic solar water heating provides about one fourth the people in Israel with hot water. Smaller, but still substantial numbers of people in Australia, Hawaii, Latin America and New Zealand also use such devices. Solar space heating and cooling systems are now marketed in the United States and will soon also be marketed in Japan. Under some considerations (available front-end capital, for example), such systems are cost effective on a life-cycle cost basis when compared with oil heating or all-electric resistive heating.

1) Objectives

- To develop and evaluate research methodologies for the assessment of the potential of solar conversion systems in specific regions and human settlements;

- To test these assessment procedures in the regions collaborating in the program of Regional Integrated Management of Energy/Environment Systems.

2) Methodology and Models

IIASA has made a major commitment to evaluating the solar energy option as a long-term major energy source for mankind [18], with particular emphasis upon its application to European countries. An array of methodologies are being developed to implement the following evaluation tasks:

- Technical and economic characteristics of various solar conversion systems;
- Land costs and availability; solar conversion system site identification;
- Inputs of large-scale deployment of solar conversion systems.

These methodologies developed at IIASA will be applied to the regions under study in the program of Regional Integrated Management of Energy/Environment Systems. In addition, solar energy expertise from some of the collaborating institutions will be utilized. In particular, the Solar Energy Research Group at the University of Wisconsin [1] will provide expertise in the area of solar heating and cooling in buildings.

The general approach proposed for the Integrated Energy Systems Project is as follows:

- a) Data specification and collection for each region;
- b) Evaluation of siting potential in each of the regions, based upon technical, economic, and regional information;
- c) Development of scenarios for high, medium, and low technological implementation of solar energy systems of a long-term planning horizon (~50 years) with particular attention to the overall energy supply system mix.

3) Preliminary Data Requirements

It is believed that a zero order assessment can be made using the above approach within the time and resource constraints of this project. This would involve only a preliminary look at the availability of land, sunlight and water, as well as at the current and projected patterns of energy use. This would require the following types of information:

- a) Land Use Patterns and Physical Geography:
 - Types of land, e.g. agriculture, forests, pasture, settlements;

- Availability and economics of land;
- Climatic variables, e.g. precipitation (type and amount), sunlight (direct and diffuse plus cloud cover indices), wind patterns (frequency and speed).

b) Soil Types and Slopes:

- General information about the infrastructure of the regions, most of which would be in connection with the energy demand models (Section 3.1).

4) Representative Policy Evaluations

Is solar energy at all feasible for each of the regions? Is any one particular solar technology more attractive, and should it be investigated in more detail? Is further research warranted?

3.5 Environmental Impact

1) Major Objectives

The major objectives of the environmental impact comparison can be divided into three components:

- a) Descriptive: To examine differences and similarities of the environmental impacts connected with energy use in each of the regions, looking for both intuitive and counter-intuitive patterns of differences and similarities, given the different patterns of energy use in the regions compared. This will be of interest to policy concerned with environmental impact forecasting and planning;
- b) Model Comparison: To compare and develop some "gross" measures of environmental impact that are meaningful in the assessment of policy and planning. For what measures is the Δ impact/ Δ policy more easily differentiable and thus able to provide a better impact indicator for planning?
- c) Policy: To examine specific policy questions, e.g. what effect would certain environmental standards have on energy use. To examine how environmental impact is viewed and assessed at the policy level in the different regions.

2) A Structure for Impact Analysis

Figure 6 gives a proposed structure of the different pathways to be considered for an environmental impact analysis, with a key word or phrase for each of the steps.

a) Input Data: It would be most desirable to have data available to be able to evaluate each of the pathways 1 to 8 shown in Figure 6. General areas of data needs are:

- Geographical data (e.g. city population density);
- Meteorological data (e.g. wind statistics, atmospheric stability statistics);
- Pollutant emission data (e.g. emissions from tall stacks, emissions from space heating);
- Results of monitoring data (e.g. SO₂ measurements);
- Economic and fuel use data (e.g. different fuels used for space heating, value added).

b) Output: Depending on the data available, the output could be one of several levels of complexity. For example, the within region output could be:

- Zeroth level - total emissions from each sector;
- First level - zeroth level with simple dispersion;
- Second level - zeroth and first levels with measurements and more complex dispersion considerations.

Additional output would be further impact attributes such as:

- Potential health impact;
- Potential economic impact;
- Severity of impact vs. importance;
- Short-term vs. long-term impacts;
- Societal vs. individual impacts;
- Geographic distribution of impacts.

3) Typical Policy Questions

Policy questions have several levels of complexity.

For example;

- a) First Level: What consequences would environmental standards have for energy use:
 - with zeroth level output above?
 - with first or second level output above?
- b) Second Level: For a given set of dispersion and cost information, what would be an economically optimal standard?

4. Tentative Preparation and Structure of Major Workshop

As described in Section 2, the final stage of the First Phase of this project would be a major comparative workshop scheduled for November 3-7, 1975. In the workshop, which will be preceded by several months of model and data preparation, etc., cross-comparisons will be carried out with various combinations of models and policies applied to each of the regions. Table 2 below gives the general picture of the nature of the workshop.

It is believed that the examination of these scenarios for three or more regions, each differing greatly in their energy systems characteristics, can lead to a much better understanding of the systems themselves and the methodologies with which we study the systems. If only partial success is achieved in the objectives, then the results of this research will be extremely valuable in moving on to other resource systems, including those of industrialized nations, and in pointing toward systems analysis of energy and other resource systems in the developing countries. It is this later point that is implied in part C of Item 6 below "global feasibility maps" - that is, the extension of these systems analysis methodologies to other regions of the world.

5. Proposed Schedule for the Research Project

One of the criteria listed in Section 1 was that a project be implemented on a time scale consistent with IIASA's "stability and resilience" characteristics. Presented below is a preliminary schedule for this project.

1975

Jan. - Feb. 15	Project definition and preplanning at IIASA.
Feb. 17-20	Planning session with University of Grenoble.

Feb. 20 - March 10	Exploratory planning session with Institut für Energetik, Leipzig.
Late March	Report from Grenoble on adequacy of data for Rhône-Alpes region.
Early April	Exploratory sessions with other potential participating regions.
Mid-April	Small one-day working session in Vienna with representatives from each of the participating countries. Definition of areas of model comparison, data requirements, hypothetical policy questions.
May 1	Working paper describing project, structure, objectives, etc.
May 19-23	Research meeting at IIASA during IIASA Workshop on Energy Demand.
November 3-7	Major workshop with the three countries participating, including policy makers.
November-December	Publication of workshop proceedings; evaluation of First Phase of project; transition to Followup Phase.

Table 2. Proposed structure of a multinational workshop.

1. Basic method of cross comparison				
		Regional group		
		A	B	C
Region	I	x	x	x
	II	x	x	x
	III	x	x	x
2. Energy system components considered				
		Regional group		
		A	B	C
a)	Ext. world:	x	x	x
	1. Fixed;			
	2. Driven by world model, etc;			
	3. :			
	:			
b)	Energy demands:	x	x	x
	1. Aggregated;			
	2. By sector and processes (e.g. agriculture, heating);			
	3. By fuel;			
	4. Feedback from supply.			
c)	Supply:	x	x	x
	1. Primary fuel;			
	2. Secondary (e.g. electricity);			
	3. :			
	:			
d)	Environmental impact:	x	x	x
	1. External to region;			
	2. Internal;			
	3. Land use.			
e)	Socio-economic:	x	x	x
	1. Population;			
	2. Jobs/energy indices;			
	3. Energy costs;			
	4. :			
	:			

Table 2. Proposed structure of a multinational workshop (cont.).

3. Standardized Data Base			
(Developed and distributed well before workshop)			
		Region	
		I	II
		III	
a.	Energy Demands;	x	x
b.	Supply;	x	x
c.	Socio-economic variables.	x	x
4. Possible basis for comparisons of models and policy analysis methodology			
a)	Similarity or differences in short-and long-range projections;		
b)	Effects of disaggregation levels;		
c)	Effects of special components, e.g. feedbacks (price, environment) between supply and demand;		
d)	Breadth and depth of policy alternatives accommodated.		
5. Types of Recommendations to be produced			
a)	Data adequacy and needs;		
b)	Disaggregation and feedback;		
c)	Critically sensitive areas;		
d)	Breadth of options analyzable;		
e)	Implications of alternate policy objectives;		
f)	Research priorities.		
6. Output of Workshop			
a)	Proceedings of workshop including data bases, models, evaluations, policy tests, comparisons, recommendations, etc.;		
b)	Recommendations for further research, possible follow-up workshop extension to other countries;		
c)	Global feasibility maps for applications of this approach to other regions, including developing countries.		

Part II. Current Status of the Comparative
Regional Energy/Environment Study

The study as described in Part I is proceeding along the general lines laid out in the original proposal. The primary objectives of the project are the following:

- 1) Description of regional energy systems: demand, supply, environmental systems, etc.;
- 2) Comparison of alternative methodologies for regional forecasting, planning and policy analysis;
- 3) Development of new models, methodologies and concepts;
- 4) Examination of alternative energy policies and strategies for each of the regions within the framework of the above methodologies.

The third objective, the development of new methodologies and concepts, is receiving special attention because of the opportunity for testing these concepts across widely varying regions.

The components and methodologies used in descriptive analysis and modelling in the project are shown below.

1. Areas:
 - Regional energy demand;
 - Embedding of energy supply systems in a regional environment;
 - Environmental impact of regional energy systems;
 - Regional embedding of solar energy systems;
 - Food-energy system interrelationships.
2. Methodologies:
 - Econometrics (correlation);
 - Physical models;
 - Simulation;
 - Input-output;
 - Behavioral models based on optimization.

These descriptive techniques are being brought together in a comprehensive write-up so as to provide a type of procedural handbook for guidance in future regional energy/environmental studies.

Because of the broad range of methodologies, it has been necessary to develop participation by a number of different disciplines and projects within IIASA. The table below indicates, at least in part, some of the individuals involved in the research and their projects at IIASA. This structure of participants is constantly evolving, and appears to mesh well with the dynamic nature of the population of scientists at IIASA.

Table 3.

Research Area	Ecology	Energy	Methodology	Industrial Systems
Energy Demand	Foell Hölzl	Charpentier	Bigelow	
Energy Supply	Foell	Hätscher Suzuki Weingart		
Environment	Buehring Dennis Foell Stehfest Sazonov		Bigelow	Ito
Food-Energy	Dennis			
Decision Analysis	Buehring (Walters, Hilborn)		Keeney	

One of the early substantial tasks of the project is the development of an adequate data base across the three regions. Tables 4, 5 and 6 show interesting comparative figures on regional energy supply and demand as well as population and land use data. The data show diversity among the three regions; of particular interest is the very great difference in the major components of fuel supply for the respective regions. These different characteristics relate to the important policy questions in the area and to the types of modelling and planning techniques used.

The center of gravity of the research effort lies in the areas of the evaluation of environmental consequences of regional energy use and of the development of adequate methodology for improved environmental management. Figure 7 shows a block diagram of an overall scheme for describing the process of environmental management. Each of the boxes in Figure 7 represents a

Table 4. A comparison of regional energy use.

[1972-73 Data]

	Annual Energy Use [10 ¹² kcal/yr]	Annual Energy Use Per Capita [10 ⁶ kcal/yr]	Density of Annual Energy Use [10 ⁹ kcal/km ²]
GDR	718	42	6.7
Rhône-Alpes	151	32	3.4
Wisconsin	323	72	2.2

Table 5. Comparison of total energy use by source, 1972.

	GDR %	Rhône-Alpes %	Wisconsin %
Coal	77.5 (lignite)	6.2	26.2
Natural Gas	1.0	5.9	30.0
Petroleum	21.4	54.2	39.4
transport	[7.1]	[13.5]	[24.9]
non-transport	[14.3]	[40.7]	[14.5]
Hydropower	0.1	33.7	1.6
Nuclear	-	-	2.8
	<hr/> 100.0	<hr/> 100.0	<hr/> 100.0

Table 6. Comparison of population and land area.

	Gross Land Area (km ²)	1973 Population (10 ⁶)	1973 Population Density p/km ²
GDR	108,178	17.0	157
Rhône-Alpes	44,967	4.8	107
Wisconsin	145,320	4.6	31

major area of research attention. The environmental attributes in box 2 are given by a large simulation model that was originally developed at the University of Wisconsin, and is now being modified to be applicable to the other two regions. IIASA scientists are implementing a major addition to the Wisconsin model that will provide a basis for applying multi-attribute utility theory analysis to the environmental management of the regional energy systems; it is this activity that is denoted by the box in Figure 7 "Evaluation of Preferences". The general process for application of the multi-attribute decision analysis is shown in Figure 8. Currently in progress are the assessments of environmental preferences of a broad range of individuals within the three regions involved in energy planning. The successful implementation of this phase of the research program will undoubtedly lead to modification of the Wisconsin environmental model as indicated by the feedback arrows in Figure 8. An indication of some of the types of special considerations that may have to be built into the environmental model in order to take into account different value structures of decision and policy makers is given below. It is believed, from early indications, that this research format, coupled with an effective set of displays and communications of information for decision makers, may provide an effective tool for improved regional energy/environmental management. Structural considerations for environmental impact assessment are given below.

1. Basic

- a) Number of impact variables
- b) Boundaries of system
 - internal and/or external impacts
- c) Level of disaggregation
 - space
 - time

2. Special

- a) Intergenerational effects (e.g., today vs. tomorrow)
- b) Societal and individual effects (e.g., occupational vs. public)
- c) Predictable, on-going effects vs. catastrophes.

The research is pointing toward a major workshop to be held late in 1975 at which both the methodologies and the sets of alternative policies will be discussed.

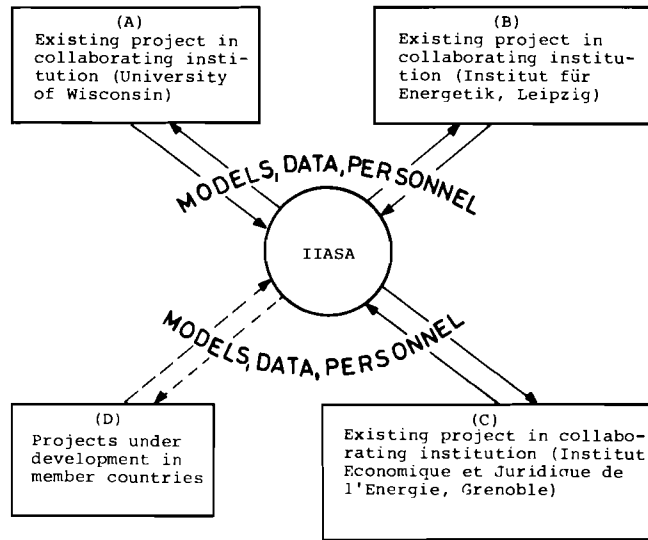

Figure 1. Interinstitutional relationships within the Integrated Energy Systems Project.

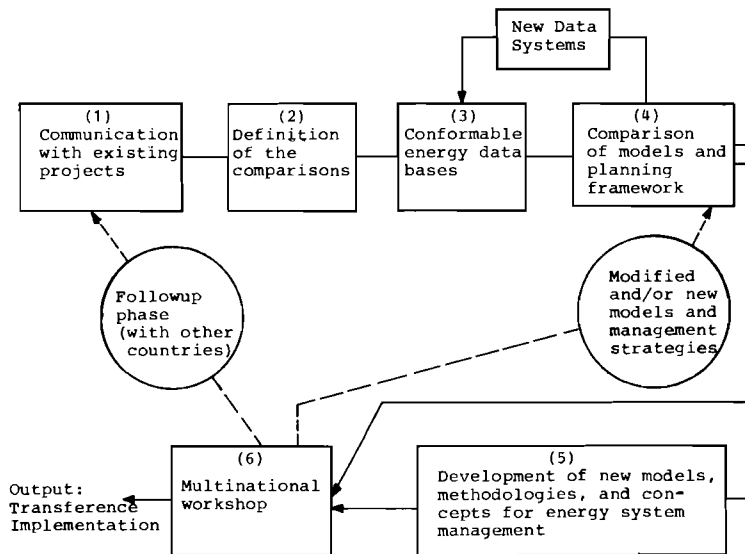

Figure 2. Stages of the Integrated Energy Systems research program.

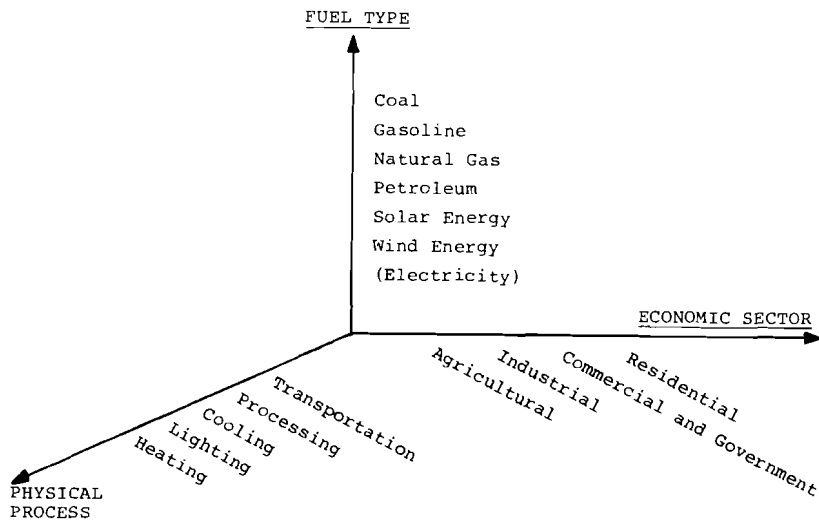

Figure 3. Descriptive structure of end-use energy demand.

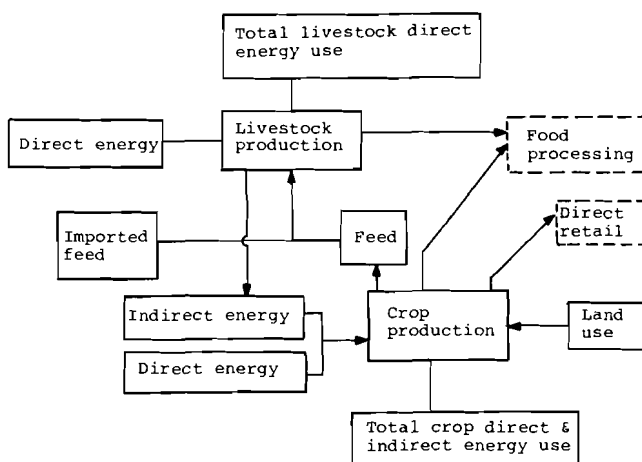

Figure 4. Agricultural sector.

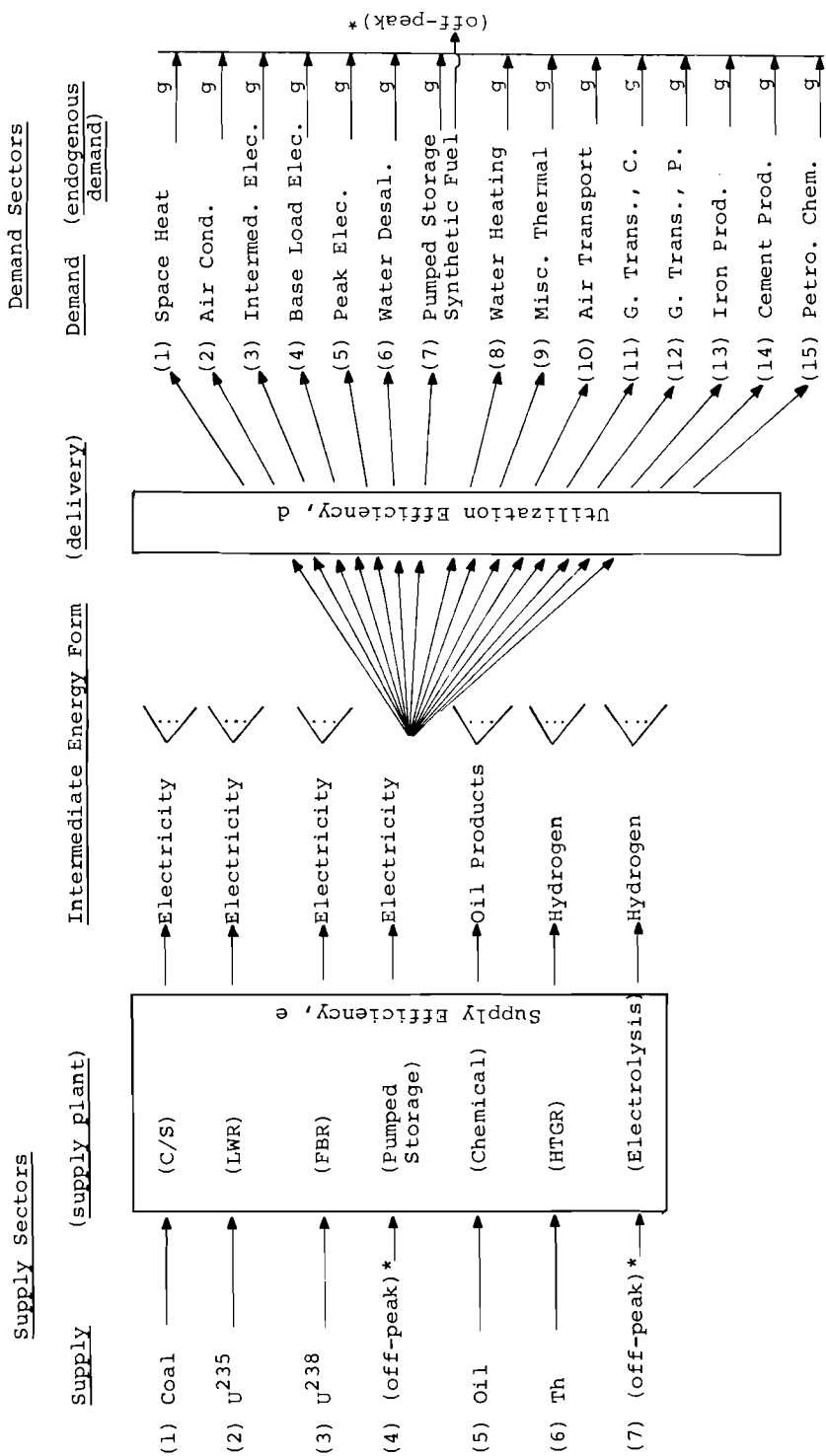
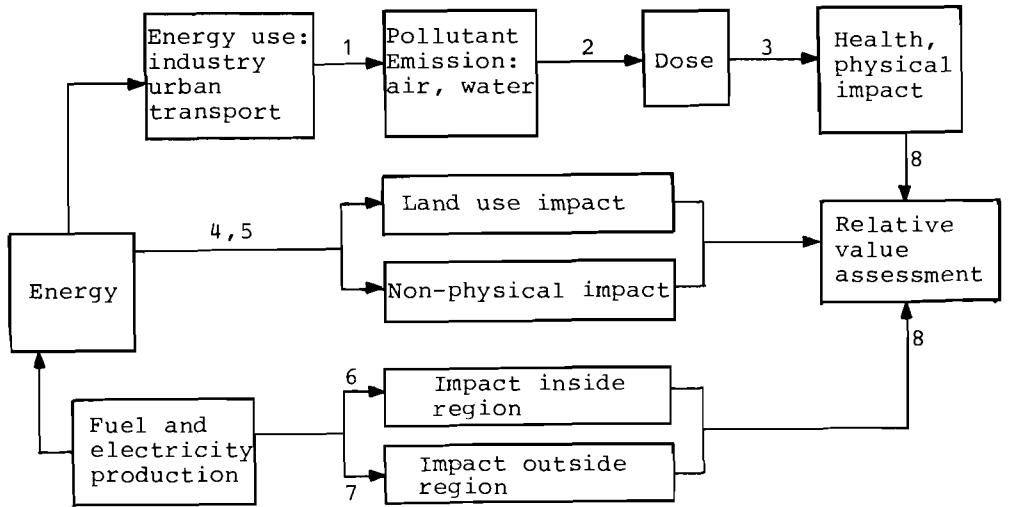

Figure 5. Schematic description of the format in the application of the IIASA Energy Supply Model [17].



- | | |
|-------------------|---|
| 1 Emission | 5 Direct economic effects |
| 2 Dispersion | 6 Fuel chain impacts, within the region |
| 3 Dose-response | 7 Fuel chain impacts, outside region |
| 4 Direct land use | 8 Value assessment |

Figure 6. Pathways for environmental impact analysis. (This structure is essentially identical to that used in the Wisconsin Regional Energy Model [2].)

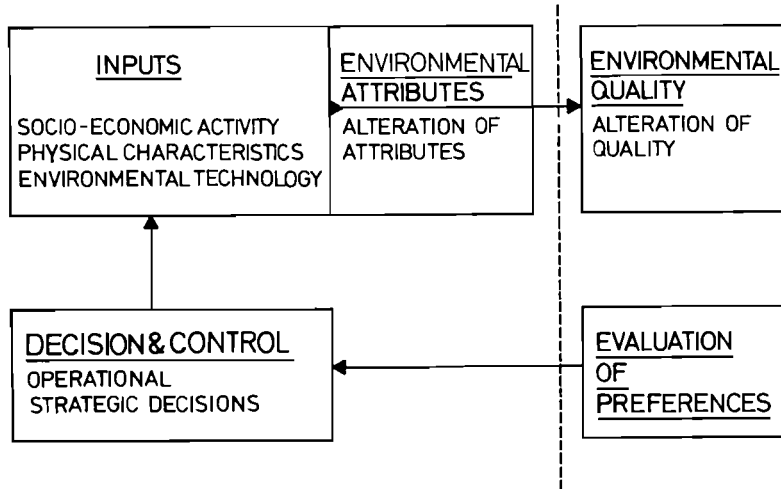

Figure 7. Environmental management process.

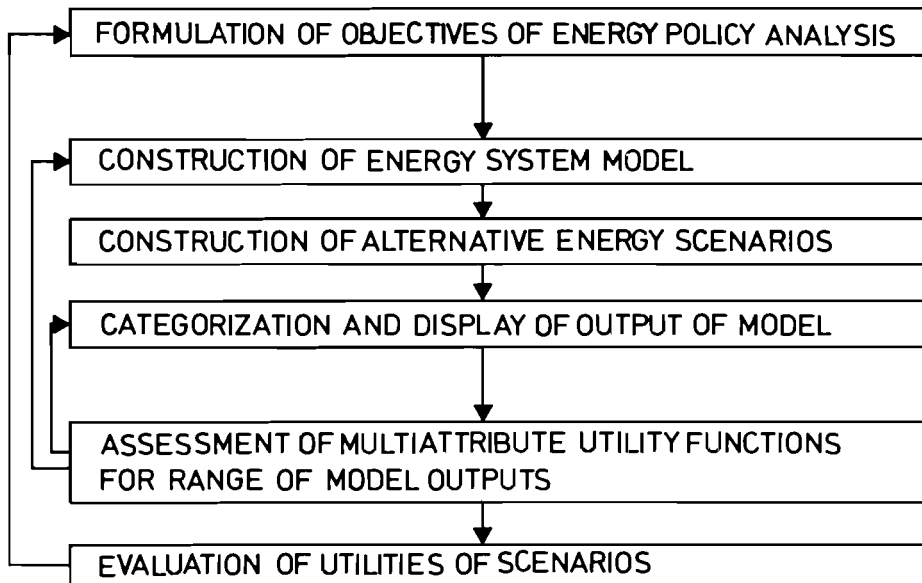

Figure 8. Multiattribute decision analysis.

References

- [1] Beckman, W.A. and Duffie, J.A. "The Energy Crisis and Energy From the Sun." Symposium on Solar Energy Utilization. Washington, D.C., September 30, 1974.
- [2] Buehring, W.A., Foell, W.K., and Dennis, R.L. "Environmental Impact of Regional Energy Use: A Unified Systems Approach," Energy Systems Planning, Forecasting and Pricing. Ed. C.J. Cicchetti and W.K. Foell. Madison, University of Wisconsin Press, 1975.
- [3] Charpentier, J-P. "A Review of Energy Models." IIASA-RR-74-12, Laxenburg, Austria, International Institute for Applied Systems Analysis, 1974.
- [4] Charpentier, J-P. "Overview of Techniques and Models Used in the Energy Field." IIASA-RM-75-8, Laxenburg, Austria, International Institute for Applied Systems Analysis, 1975.
- [5] Finon, D. "Optimization Model for the French Energy Sector," Energy Policy, 2, June 1974.
- [6] Finon, D. "An Aggregate Approach to the Energy Problem: An Optimization Approach for the French Energy Sector." Energy Systems Forecasting, Planning, and Pricing. Ed. C.J. Cicchetti and W.K. Foell. Madison, University of Wisconsin Press (forthcoming).
- [7] Foell, W.K. A Long-Range View of the Energy Crisis. Paper Presented at Conference on the Implication of the Energy Crisis. Milwaukee, Wisconsin, March 1973.
- [8] Foell, W.K. The Wisconsin Energy: A Tool for Regional Energy Systems and Policy, Report No. 10. Madison, Institute for Environmental Studies, University of Wisconsin, November 1974.
- [9] Häfele, W. and Manne, A.S. "Strategies for a Transition from Fossil to Nuclear Fuels." IIASA-RR-74-7, Laxenburg, International Institute for Applied Systems Analysis, 1974.
- [10] Häfele, W. "Future Energy Resources." IIASA-RR-74-20, Laxenburg, Austria, International Institute for Applied Systems Analysis, 1974.

- [11] Hätscher, W. and Scientific Staff. Institut für Energetik, Leipzig, March 19, 1975
- [12] Holling, C.S., and Fiering, M.B. "Management and Standards for Perturbed Ecosystems." IIASA-RR-74-3, Laxenburg, Austria, International Institute for Applied Systems Analysis, 1974.
- [13] Hoffman, K.C. "The United States Energy System - A Unified Planning Framework." Unpublished Doctoral Dissertation. Polytechnic Institute of Brooklyn, June 1972.
- [14] Konno, H. and Srinivasan, T.N. "The Häfele-Manne Model of Reactor Strategies: Some Sensitivity Analysis." IIASA-RM-74-19, Laxenburg, Austria, International Institute for Applied Systems Analysis, 1974.
- [15] Mesarovic, M. and Pestel, E. "Multilevel Model of World Development System." Proceedings of an IIASA Symposium. IIASA-SP-74-5, Laxenburg, Austria, International Institute for Applied Systems Analysis, April 29-May 3, 1974.
- [16] Suzuki, A. and Schrattenholzer, L. "Sensitivity Analysis on Hydrogen Utilization Factor of the Häfele-Manne Model." IIASA-RM-74-30, Laxenburg, Austria, International Institute for Applied Systems Analysis, 1974.
- [17] Suzuki, A. and Avenhaus, R. "A Study of the Demand Aspects of the Häfele-Manne Model - An Application of the Mathematical Technique of the Hoffman Model." IIASA RM-75-4, Laxenburg, Austria, International Institute for Applied Systems Analysis, 1975.
- [18] Weingart, J. "Evaluating the Solar Energy Option as a Long-Term Major Energy Option for Mankind." IIASA-WP-74-43, Laxenburg, Austria, International Institute for Applied Systems Analysis, 1974.

3.4. Human Impact on High Mountain Regions: Obergurgl Case Study

C. Walters, G. Margreiter, S. Buckingham and R. Hilborn

We initiated work in 1974 on Obergurgl, a small alpine area in Austria. The study was intended originally as a simple transfer activity to provide education in modelling techniques and interdisciplinary communication for a Man-and-Biosphere (MAB) research team that had been studying the area for several years. We held a small modelling workshop where we helped a team of MAB scientists, villagers from Obergurgl, and regional government officials, to develop and implement a simulation model of the area. This model considered environmental changes, population growth, land use for tourism and recreation, and economic development.

These initial modelling activities revealed that Obergurgl is an instructive microcosm of development problems faced all over the world. As a small valley surrounded by mountains, Obergurgl has well defined and easily quantifiable resource limits for further growth (land, water, environmental quality). It has a rapidly growing population that is essentially closed to immigration; this population exerts tight control over land ownership (thus economic development by external agents is unlikely). Population growth combined with high demand for tourism has led to rapid growth in the hotel industry, and industrial growth itself helps provide jobs and thus investment money for further growth. Before 1950, agriculture was the primary economic activity, and large family sizes were the rule as in most agrarian social systems; high birthrates were translated into high emigration rates. The hotel industry provided opportunities for potential emigrants to stay in the area, and birth rates in the hotel-owning population segment dropped rapidly. This has led to a "have-have not" split; the remaining agricultural families, with their high birth rates and relative poverty, are fueling population growth while demanding their own opportunities to enter the hotel industry. Thus overdevelopment of the area for tourism seems a virtual certainty, and the area is heading toward an economic monoculture that is dangerously dependent on the future of European tourism.

In subsequent workshops with the villagers of Obergurgl, we have used a simplified and well-tested version of the original model as a focus for public debate. By providing a quantitative picture of emerging problems and trends (population and land use especially), the model has helped to prevent public discussion from degenerating into essentially trivial arguments about

tactical side issues (i.e. whether or not to pay higher prices for agricultural products - some villagers had felt that such a simple step would be adequate to solve the have-have not problem). From the debates so far, it is clear that no really palatable options remain open to the Obergurglers; population growth has been allowed to proceed unchecked for too long. The remaining options fall into three broad classes:

1) Defer the problem and the risks

Stimulate rapid development to move the have-not families into the hotel industry. Their birthrates will then decline, but the region will become a dangerously overdeveloped monoculture.

2) Accept short run hardships

Stop the hotel development and encourage emigration of young people. The risk here is that the "have-nots" will seize political control and permit overdevelopment anyway. They have nothing to lose by doing so since they will still control large areas of agricultural land that are unsuitable (avalanches, etc.) for building.

3) Seek a new social order

The present hotel owners have a variety of options for transferring wealth to the have-nots in the form of alternative economic opportunities (jobs in hotels, light industry, etc.). But new economic developments sufficiently large and attractive to handle the current "baby boom" will entail high risks for the recreation industry, since such developments will involve physical structures that are sure to affect the aesthetic appeal of the area.

The story is familiar, and indeed we see the same issues on the global scale. We began the Obergurgl work as an exercise in environmental monitoring, but it soon became clear that the environmental problems are not going to be solved unless a series of larger issues are first resolved.

Studies of microcosms such as Obergurgl may well be a useful step in the development of global models, since we may be able to more clearly pinpoint with small systems those issues that the global models should address. This proposition follows from a simple observation: almost any natural system can appear to be impossibly complex when we are not sure what questions to ask about it. Those who argue that global modelling is premature because of problems with complexity and data would do well to pause for a moment and ask what they would want such models to do. If the main concerns are with problems of deferring risks, population pressures for economic development, and the appearance of desperate monocultures, some simple modelling efforts may be of considerable policy value.

3.5. Ecological Models of River Basin Water Quality

H. Stehfest

1. Description of the Problem

The ability of rivers to purify themselves is an important economic factor; accordingly there have been many attempts to model mathematically the self-purification process. Since it is an extremely complex process, these models vary greatly as to degree of aggregation. At one end of the range there is the Streeter-Phelps model [3] that has only two variables: one for the organic pollutants (BOD) and one for the oxygen concentration (see Figure 1). At the other end of the range, there are models with many variables and interconnections as, for example, the model developed for the Delaware River [2] (see Figure 1). (In reality, even this model has to be considered very rough.)

There has been much discussion about how complex a river quality model should be that is to be used, for example, for the optimal allocation of waste water treatment effort along a river. The Streeter-Phelps model is easy to deal with because it is linear, it can be solved analytically, it has only two parameters to be estimated, etc. But, because of the model's roughness, in general, it is not possible to make the best use of the self-purification ability of the river. On the other hand, a model such as the Delaware model may be able to predict more accurately future river quality; however, in practice it is impossible to determine uniquely the many parameters of the model or to use the model in an optimization calculation.

The problem discussed below is the resolution of this trade-off in a quantitative way. This involves a comparison of the optimal solutions of the above mentioned allocation problem using the Streeter-Phelps model, and a more complex, but manageable model. For the latter, a model was chosen that was developed for the Rhine River [6] (see Figure 1). This model has been investigated well with regard to sensitivity, equilibria, possibility for parameter estimation, etc. After a comparison of the models has been made, one can determine if it is worthwhile to validate and to use a water quality model more complex than the Streeter-Phelps model. The Rhine River was selected as an example for the comparison. Figures 2 and 3 show how measured data are fitted by the two models. The fit with the ecological (Rhine River) model is somewhat better than the fit with the Streeter-Phelps model, although the difference is not very pronounced.

2. Methodological Issues

2.1 Model Identification

In order to evaluate the usefulness of the ecological model, it was necessary to check if its parameters could be determined uniquely from measurements that could be obtained at reasonable expenses. The quasi-linearization technique by Bellman was used with success, and the model proved to be identifiable under reasonable assumptions [6].

2.2 Sensitivity Analysis

It was necessary to determine how the model solution can deviate from the nominal solution if the parameter and the initial values vary over certain ranges. In this connection, a more fundamental problem of sensitivity analysis was identified and solved.

There are two first order estimates for the maximum deviation: a) one solves the sensitivity system (differential sensitivity); or b) one solves the model twice with different parameter (or initial) values (finite sensitivity). Figure 4 illustrates the difference between the two estimates for two examples, whereby the t-dependency is disregarded. In both cases, the deviation from the nominal value is greater than a prescribed standard if the parameter varies over a fixed range; this is obviously not recognized with finite sensitivity in the first case, and with differential sensitivity in the second case. Thus the question arises: which estimate should be used in order to minimize losses due to discrepancies between actual deviation from the nominal solution and sensitivity? It has been proved, under very weak assumptions, that, in general, the finite sensitivity gives the better estimate for the maximum deviation [7].

2.3 Optimization

The aim of this exercise was to find the optimal kind and extent of waste water treatment in each of sixteen reaches of the Rhine River so as to meet certain standards at minimum costs. In both of the models, dynamic programming was used whereby the decision steps correspond to the reaches [8]. The scheme chosen is shown in Figure 5. State and decision variables were discretized. Starting from the given initial values, all possible policies were traced in the forward direction; each time two policies led to the same state, the more costly one was discarded. Finally, the optimal solution was constructed in the backward direction starting from that state in the last reach that had the lowest accumulated cost attached to it. One drawback of this scheme is that one has to use both the state transformation function and its inverse, which causes computational troubles. Nevertheless, it is believed that this scheme is the most efficient for the problem at hand. The optimization had to be repeated up to three times with finer and finer grids for the state and decision variables.

2.4 Model Discrimination

After obtaining the optimal solutions x_1, x_2 , with associated costs c_1, c_2 for the two models, the question arises: what can be inferred from that by a decision maker? He has, in the simplest case, three alternatives: a) realize solution $x_1(A_1)$; b) realize solution $x_2(A_2)$; or c) initially take more measurements in order to get a better validated model (A_3) (see Figure 6). In order to choose rationally among these alternatives, he has to express his confidence in the models by assessing three judgemental probabilities [4] (that add up to one) for the following events:

- 1) Model 1 is (within certain limits) the "right one" (p_1);
- 2) Model 2 is the "right" one (p_2); or
- 3) A model sufficiently different from those used for the optimization is "true" (p_3).

Assuming that the sampling in alternative A_3 either verifies model 1 or model 2, or identifies the yet unknown true model (at cost c_s), the decision maker can evaluate the expected cost $E(c)$ for each of the alternatives and choose the cheapest one. To do this he must know the costs for changing each of the optimal solutions into a solution that satisfies the standards, given that the other model is true (Δ_{12} and Δ_{21} in Figure 6). These costs can be easily calculated.

3. Data

The optimization was done for estimated waste water production in 1985. Standards were imposed on oxygen concentration and on the concentration of non-degradable pollutants; oxygen concentration standards guarantee minimum conditions for aquatic life, while non-degradable pollutant standards limit the troubles that can occur with drinking water production. Essential data are given in Figure 7.

4. Results

The demonstration of the feasibility of dynamic programming for the ecological model may be looked upon as one result.

The optimal solutions for a particular pair of standards are shown in Figure 8. The differences are notable though not extremely dramatic. The ecological model seems to allocate more treatment effort to the upstream part of the river.

The differences depend of course on the standards, and numerical experiments with different standards are still being carried out [8]. If the oxygen standard is relaxed, only the standard for the non-degradable pollutants is active, and therefore the optimal solutions become identical. In this case, one could maximize the integral of the oxygen concentration with the total cost given. This would require only minor changes to the program.

The solution for the model discrimination problem described in Section 2.4 has not yet been derived because the transition cost has not yet been calculated.

5. Related Studies at IIASA

5.1 Implementation of the Optimal Solution (H. Stehfest, S. Rinaldi and R. Soncini)

The problem is to implement the optimal solution within a given time period in such a way that river quality improves as fast as possible at given cost constraints for each year. To formulate the problem precisely one has to define how quality improvements are measured and what the cost constraints are. The index P for the river pollution was defined as the total oxygen deficit in the river. That is:

$$P_k = \int_{z_0}^{z_1} A(z) D_k(z) dz ,$$

where

k = the year;

A = the river cross section; and

D_k = the deficit.

The cost constraint for year k was chosen as follows:

$$\sum_{i=1}^k c_i \leq k \frac{c_{total}}{N} ,$$

where

c_i = the cost in year i ; and

N = the number of years within which the optimal solution is to be implemented.

In most practical cases, the pollution index has the following additivity property:

$$P = P_0 - \sum_{i=1}^m q_i ,$$

where

P = the pollution index after the installment of any m plants;

P_0 = the index before that installment; and

q_i = the independent contributions of the plants to the quality improvement.

This additive property holds exactly for the Streeter-Phelps model, and approximately for the ecological (Rhine River) model.

The optimization problem can be stated from two different points of view: 1) select each year, those plants which yield the greatest improvement; or 2) minimize the integral of P over the whole implementation period. Assuming that the additive property is fulfilled, the myopic optimization leads to a knapsack problem that has been solved with a branch-and-bound-algorithm. Using the same assumption, even the overall optimization problem has been solved with a branch-and-bound-algorithm [5].

5.2 Decision Analytic Approach (J. Gros and A. Ostrom)

Instead of minimizing costs so as to meet certain standards, one could take into account explicitly that water quality and treatment expenditures are conflicting objectives. This requires the use of multi-dimensional utility functions. Moreover, one can assume that the treatment plants are already installed, and optimize the operation of the plants. This problem was treated within the Water Project, using the Rhine River data mentioned in Section 3 and the Streeter-Phelps model. The result is an operation rule that gives the degree of treatment as a function of river flow rate [1].

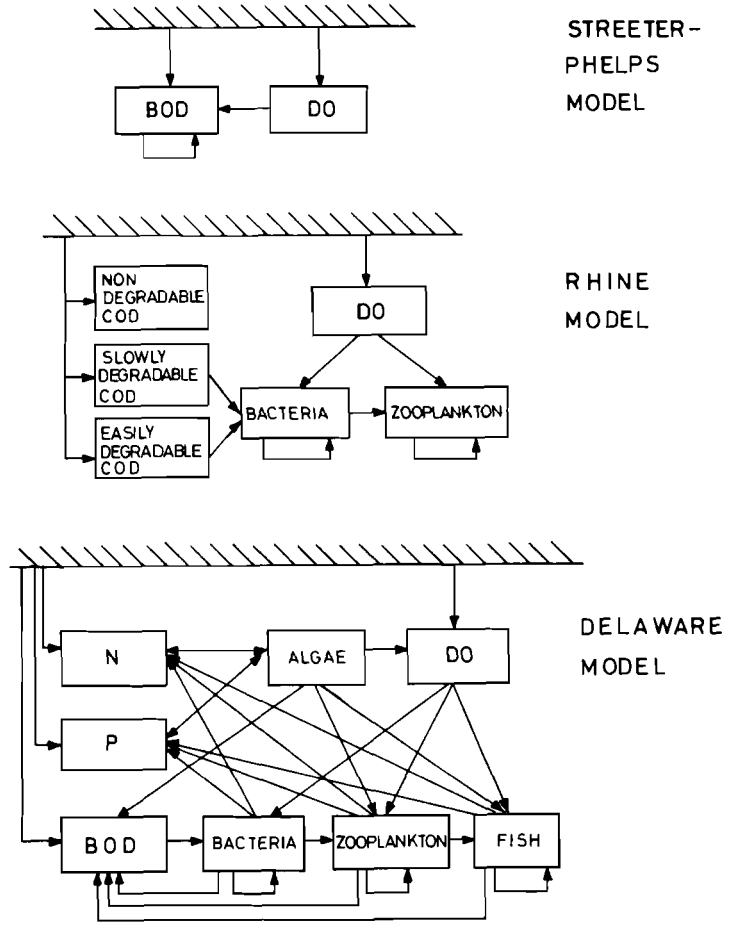

Figure 1. Structure of various river quality models. (Arrows denote flows of materials, and slanted lines the surroundings of the river.)

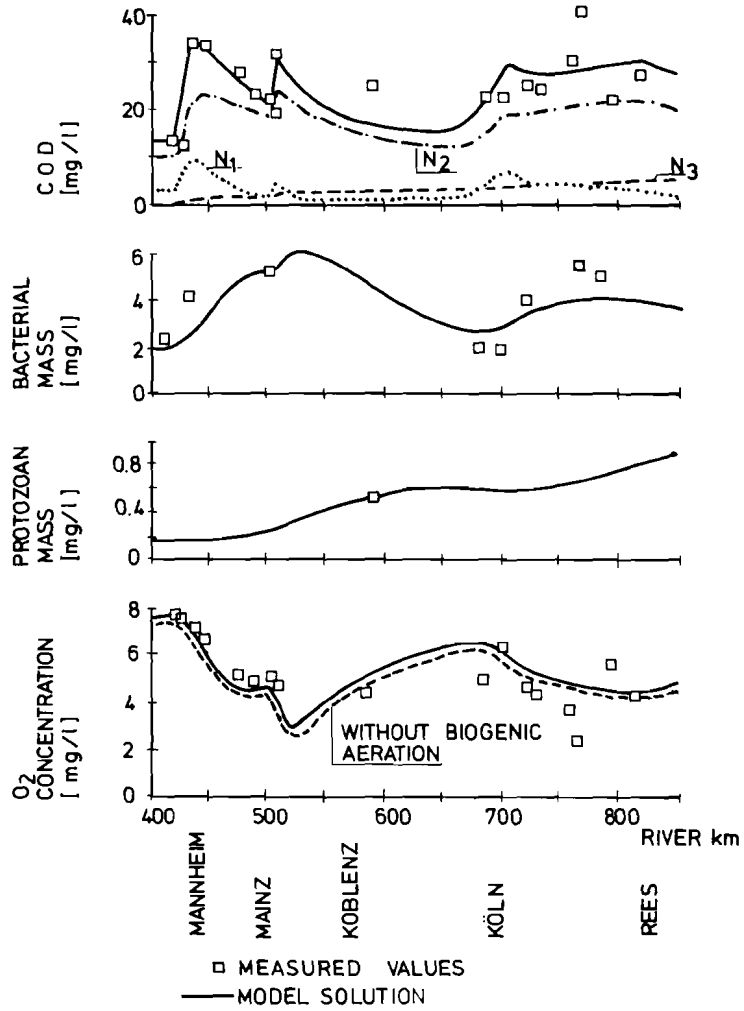
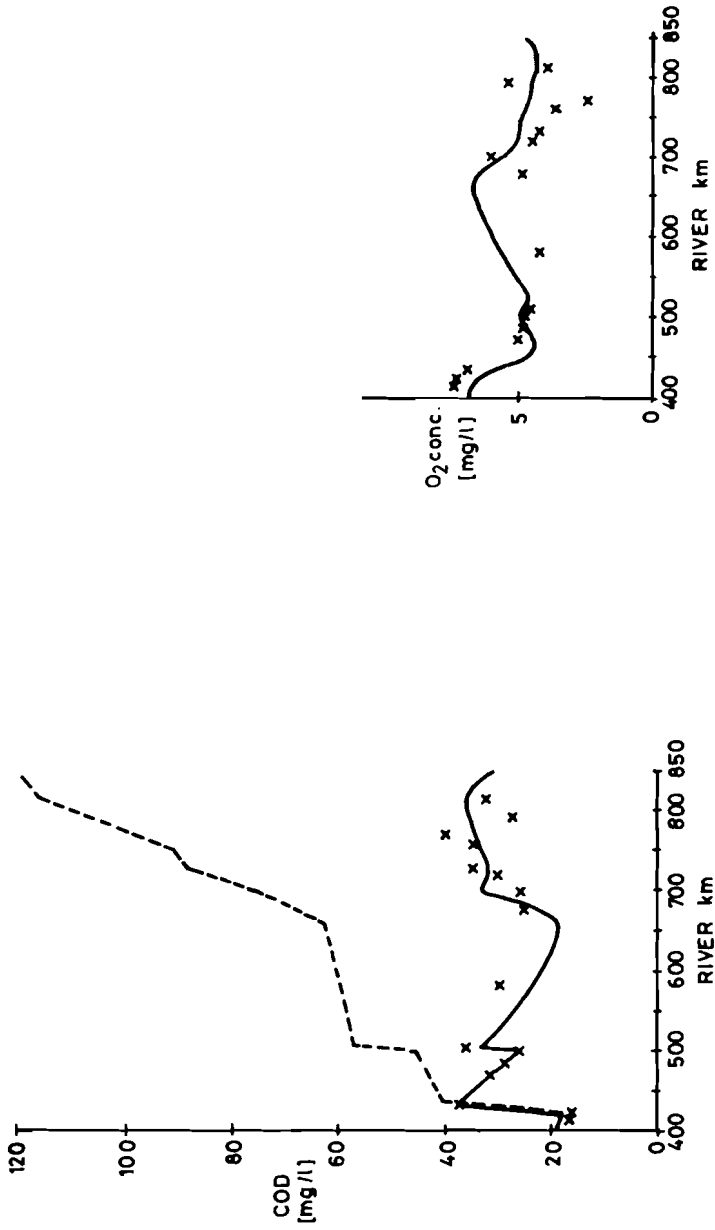

Figure 2. Comparison of measured values from the Rhine River with the solution of the ecological model.



a) Chemical oxygen demand
b) Oxygen concentration

Figure 3. Comparison of measured values from the Rhine River with solution of the Streeter-PHELPS Model.

--- without self-purification

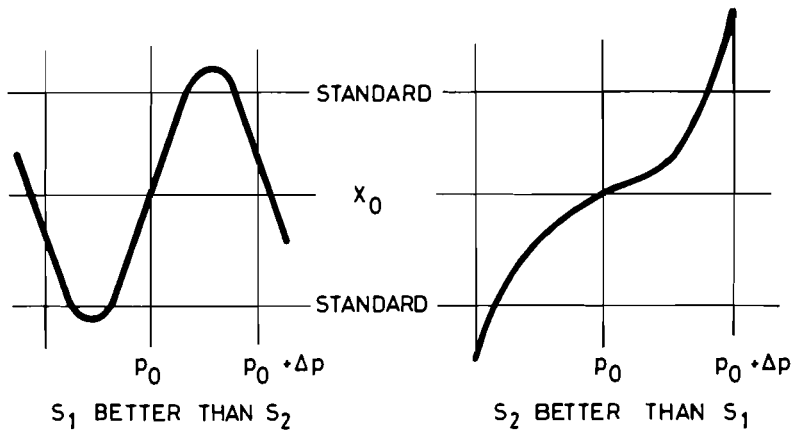

$$S_1 = \left. \frac{\partial x(t, p)}{\partial p} \right|_{p = p_0} = \text{differential sensitivity}$$

$$S_2 = \frac{x(t, p_0 + \Delta p) - x(t, p_0 - \Delta p)}{2\Delta p} = \text{finite sensitivity}$$

Figure 4. Illustration of the difference between two types of sensitivity analysis.

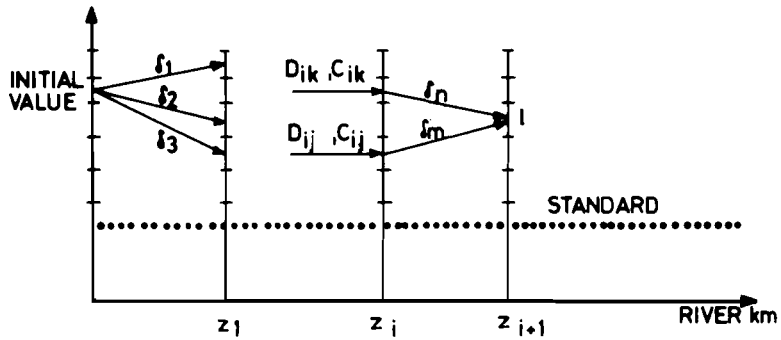

$$C_{i+1, l} = \text{Min} (C_{ij} + C(\delta_m), C_{ik} + C(\delta_n))$$

- Number of control points (reaches) 16;
- Number of states in each control point 6^6 ;
- Number of policies $\approx 6.25 \cdot 10^{25}$;
- Computing time for the complex model (IBM 370/155 ≈ 30 min).

Figure 5. Characteristics of the dynamic programming scheme.

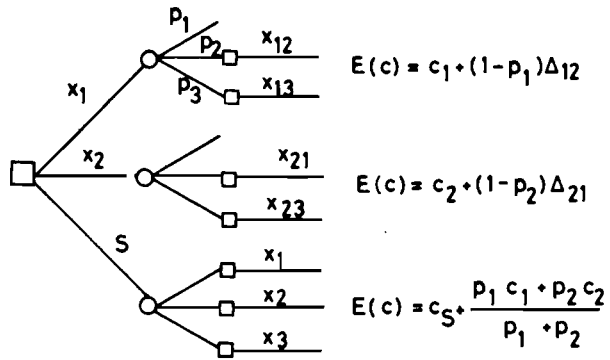

- a) Decision tree with expected costs of the three alternatives.

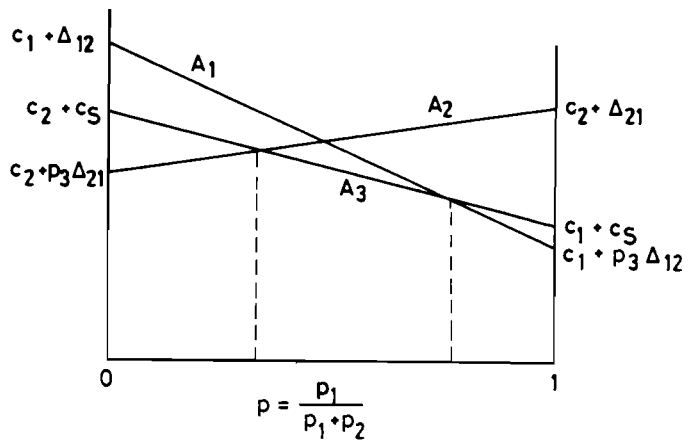

- b) Dependence of the cost of all alternatives on the probability that Model 1 is "right" with fixed probability for either Model 1 or Model 2 being "right".

Figure 6. Model discrimination.

Waste Water Production in 1985:

present
 e easily degradable
 s slowly degradable
 n non degradable

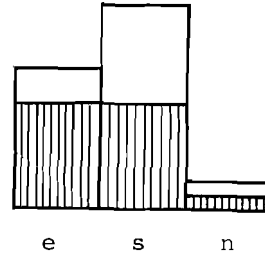

Kinds of Treatment:

A mechanical & biological
 B A & precipitation with Ca & adsorption with activated carbon

Efficiencies:

	e	s	n
A	0.95	0.8	0.65
B	0.995	0.98	0.97

Treatment Costs (DM/kg COD produced):

	pop. density	high	medium	low
A		0.18	0.24	0.35
B		0.54	0.73	1.27

Standards:

$O_2 > O_{2min}$, $N_3 < N_{3max}$ at mean flow rate and $T = 20^{\circ}C$

Figure 7. Basic data for optimization.

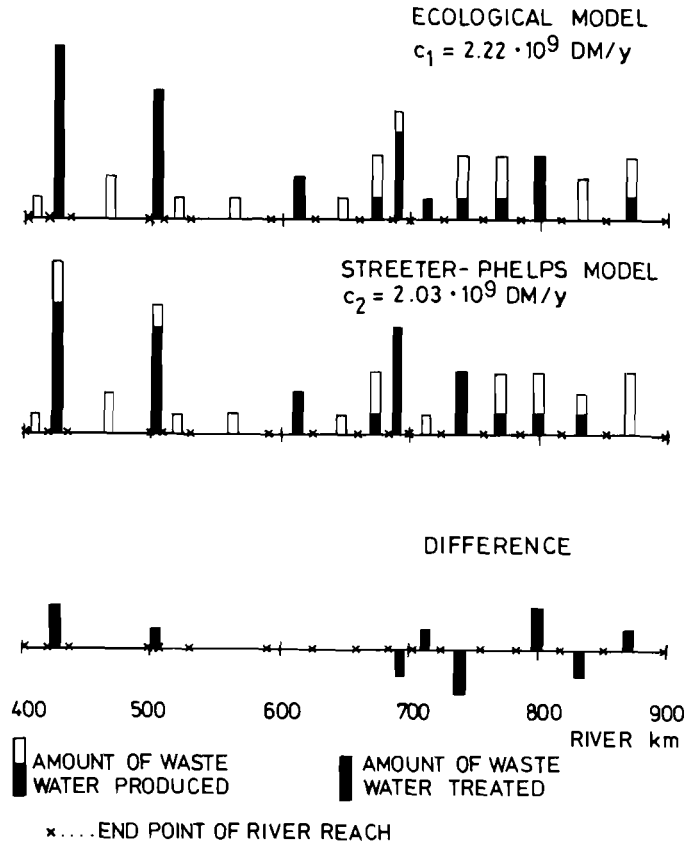

Figure 8. Comparison of optimal solutions based on two different water quality models.

Standards: $O_2 > 5.5$ mg/e

$N_3 < 9.0$ mg/e

References

- [1] Gros, J., and Ostrom, A. "Application of Decision Analysis to Pollution Control: The Rhine River Study." IIASA-RM-75-45. Laxenburg, Austria, International Institute for Applied Systems Analysis, 1975.
- [2] Kelly, R.A. "Conceptual Ecological Model of Delaware Estuary," to be published in Patten, B.C. (ed.). Systems Analysis and Stimulation in Ecology, Vol. III, New York and London, Academic Press, 1975.
- [3] Kneese, A.V. and Bower, B.T. Managing Water Quality. Baltimore, Johns Hopkins Press, 1968.
- [4] Raiffa, H. Decision Analysis. Reading (Massachusetts), Addison-Wesley Publishing Co., 1968.
- [5] Rinaldi, S., Soncini, R. and Stehfest, H. "On the Optimal Sequencing in the Implementation of Waste Water Treatment Plants." Laxenburg, Austria, International Institute for Applied Systems Analysis (forthcoming).
- [6] Stehfest, H. "Mathematical Modelling of Self-Purification of Rivers." IIASA-WP-75-43, Laxenburg, Austria, International Institute for Applied Systems Analysis, 1975.
- [7] Stehfest, H. "Decision Theoretical Remark on Sensitivity Analysis." IIASA-RR-75-3, Laxenburg, Austria, International Institute for Applied Systems Analysis, 1975.
- [8] Stehfest, H. "On the Monetary Value of Ecological River Quality Models." Laxenburg, Austria, International Institute for Applied Systems Analysis (forthcoming).

3.6. Global Monitoring

B. Sazonov

We are living in a transitional period where problems that were important in historical times are now being solved, and new problems begin to gain in importance. Shortages of energy have always been an important constraint to the development of nations. When man became master of the energy from rivers, wind, coal and oil, he made major steps toward the progress of civilization.

The scientific and technical revolution, as most scientists believe, will provide solutions to the energy problem in the near future. Energy will help to increase production of fertilizers, to improve irrigation and the treatment of the soil, and to preserve agricultural products. All of these will bring about improvements in food production.

The most important new problem is that of the environment. The quality of the environment is increasingly becoming the major constraint to development. There is no hope for the world environmental situation to fundamentally improve in the near future, because of continuous world population growth and of a tendency to manufacture products as economically as possible. The envisaged ten-fold increase in the world's energy production can cause irreversible climatic changes. In addition, an increase in fertilizer and pesticide production can cause disasters to the biosphere. Häfele has advised that one should therefore consider the hydro-atmo-eco- and sociosphere as a finite resource that will limit the production of energy.

Figure 1 shows how the rate of energy consumption has stimulated the production of iron ore and different kinds of fertilizers (N,P,K-fertilizers) in the last century. In spite of wars and of different types of world crises, there has been a constant increase in the production of energy, metals, and chemicals. There is little doubt that the amount of pollutants increased in the same way. It is interesting to note in Figure 1 that the average world data for a five-year period are represented by smooth curves.

In the future, the enormous productive capacity of the industrial world could be put to use for producing proper environmental conditions. However, before this is done, the process of degradation of the regional and global environmental conditions should be investigated to determine the nature of the degradation and the special actions that need to be taken to avoid disasters. It is extremely important to recognize what type of

natural processes are being endangered, and how far we are from irreversible changes to geophysical, geochemical and biological processes.

Through the observation and investigation of natural and man-made events in the environment, we can foresee the type of global and regional ecological crises that can arise, the time period involved, and the cost involved in avoiding crises.

In this connection, the question of a proper monitoring system shall be discussed. Only adequate and complete information can help to identify answers to the above-mentioned problems. To design a reliable monitoring system, we need first to determine the following:

- 1) What data should be chosen as the most important for the biosphere and for the people; and
- 2) Where and when such information should be collected.

It is easy to see that monitoring is a much broader activity than that of the construction and distribution of detectors for the purpose of observations. Environmental and monitoring problems cannot be considered ordinary natural science problems, because they not only describe important natural phenomena, but must also include man's decisions that can significantly change the situation.

Man disturbs all natural geophysical, geochemical and biological processes, and has even introduced new processes with which the biosphere is not acquainted (e.g. circulation of heavy metals, pesticides, fertilizers, nuclear radiation). Uncontrolled, man-made processes are in some instances comparable to natural processes that are supported mainly by solar energy. A comparison between natural and man-made trace-gas cycles has been made using data shown in Table 1. Concentrations of some trace gases control atmospheric long-range radiation, and the responses to climatic changes on the impact on fertility and health of the biosphere. The task of the monitoring system is not only to find exact values of natural and man-made trace gases in the environment, but also to forecast consequences that can be found in the climate and the biosphere.

A proper and elaborate monitoring system should provide the decision maker with information for the following:

- 1) Design of an optimal strategy under existing technology;
- 2) Development of a new and desirable technology to reduce pollutants on a regional or global scale; and
- 3) Development of a new type of observation needed to outline the peculiarities of future environmental situations.

Figure 2 shows how these activities can be practically carried out. The present method is for a number of scholars to meet to elaborate, through discussions, recommendations for the solution of global or regional environmental problems. In recent years, mathematical models have been prepared for this purpose. It should be emphasized that, in most cases, proper mathematical models cannot be prepared with the data available. Systems of observation stations to collect meteorological, hydrological, epidemiological and other data were created in the last century for the purpose of reducing the impact of unwanted natural processes and events on man's activity. The monitoring system we are discussing should serve to collect information about the influence of natural processes on man's activities and vice versa. Only a model based on complete information can be a reliable instrument for decision making.

Table 1. Natural and man-made trace-gas cycles (in metric tons/year).

		Natural	Man-made		Impact
			1970	~2020	
Carbon	CO ₂	7 · 10 ¹⁰	1 · 10 ¹⁰	3 · 10 ¹⁰	Health
Water	H ₂ O	5 · 10 ¹⁴	1 · 10 ¹⁰	1 · 10 ¹¹	
Carbon	CO	~10 ¹⁰	~2 · 10 ⁸	5 · 10 ⁸	Climate
Sulfur	S	1.42 · 10 ⁸	7 · 10 ⁷	1 · 10 ⁸	
Nitrogen	N	1.4 · 10 ⁹	1 · 10 ⁷	1 · 10 ⁸	Health and Climate
Ozone	O ₃	2 · 10 ⁹	~10 ⁶	~10 ⁷	

The survival of man will probably be one of the most important scientific problems in the future. New approaches are needed, and different models must be constructed to create scientific bases for actions that can influence the man-nature relationship.

It is possible to develop geophysical, geochemical, biological, economical and even ecological approaches to this problem and to create different models. We considered this problem from an ecological point of view. Using a preliminary and speculative model that depended on knowledge gained from interdisciplinary research, we determined the need for four related parts (or submodels), as shown in Figure 3. In constructing such models, we were faced with the difficulties of formalizing man-biosphere-environment interactions and technosphere development. For environmental and mineral resource submodels, the collection of data was made relatively easy.

Our experience brings us to the conclusion that man-biosphere-environment relationships as well as technosphere development related to the progress of science and technology are the most important and yet the weakest parts of global modelling. Existing economic global models also do not overcome these difficulties.

The contemporary world is and will continue to be substantially shaped by technology. Thus any attempt to look at what lies ahead must consider new technological possibilities. Prediction of future technology for the purpose of appreciation of environmental conditions is perhaps the most critical component of any model where environmental variables play a role.

There have always been crises concerning available technology. When one species of animal was exterminated through hunting by prehistoric man, man changed his technology and used another animal as food. One technological crisis made man a shephard, another one pushed him to plough the soil.

The more information available on expected technological changes and man-biosphere-environment interactions needed to build mathematical models, the better such models will be able to serve as instruments for the construction of adequate monitoring systems that will prevent man from self-destruction.

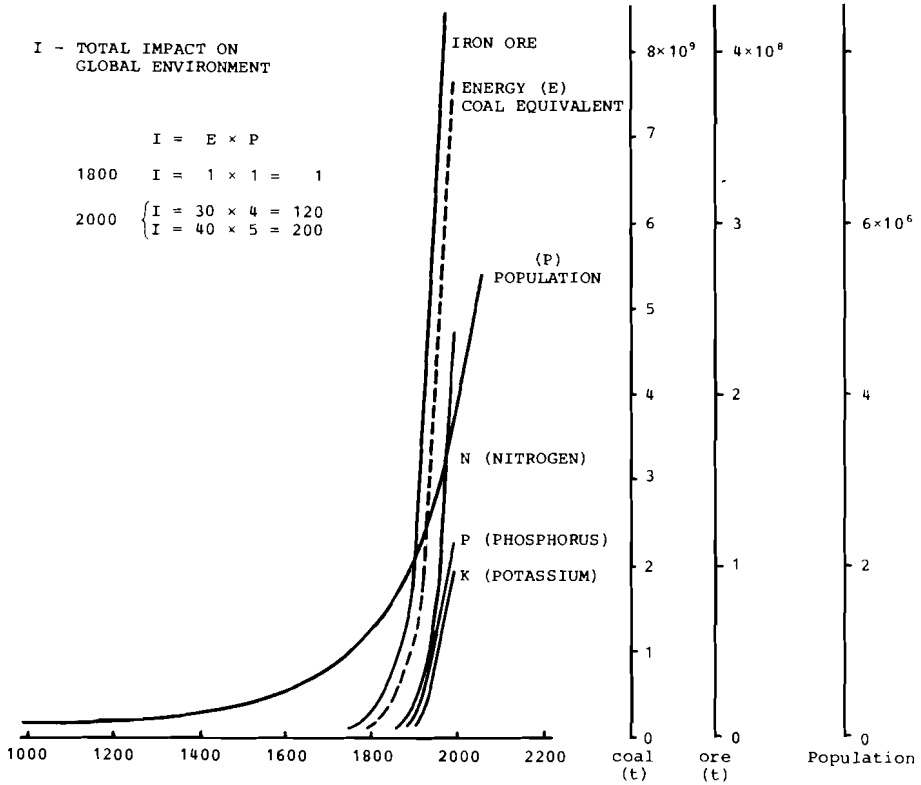

Figure 1. Estimated rates of global resource usage.

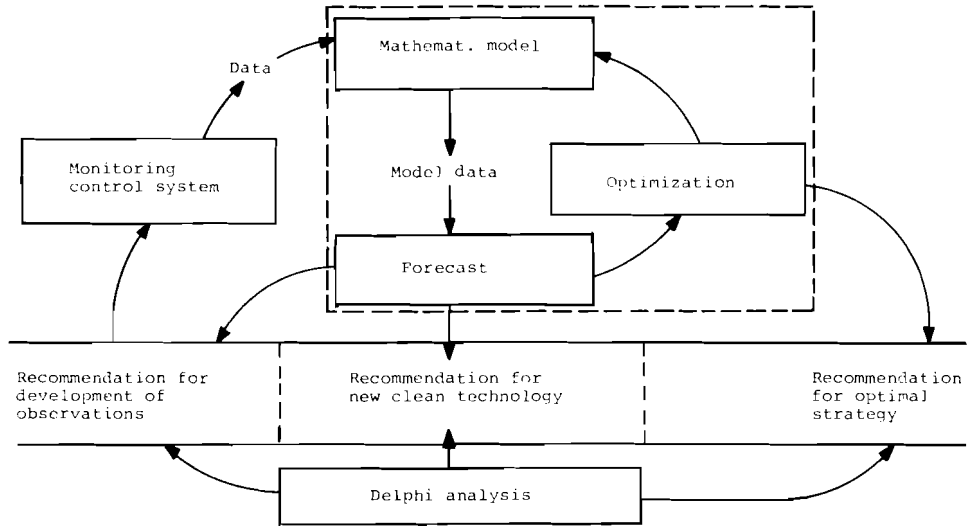

Figure 2. Conceptual structure of world monitoring system.

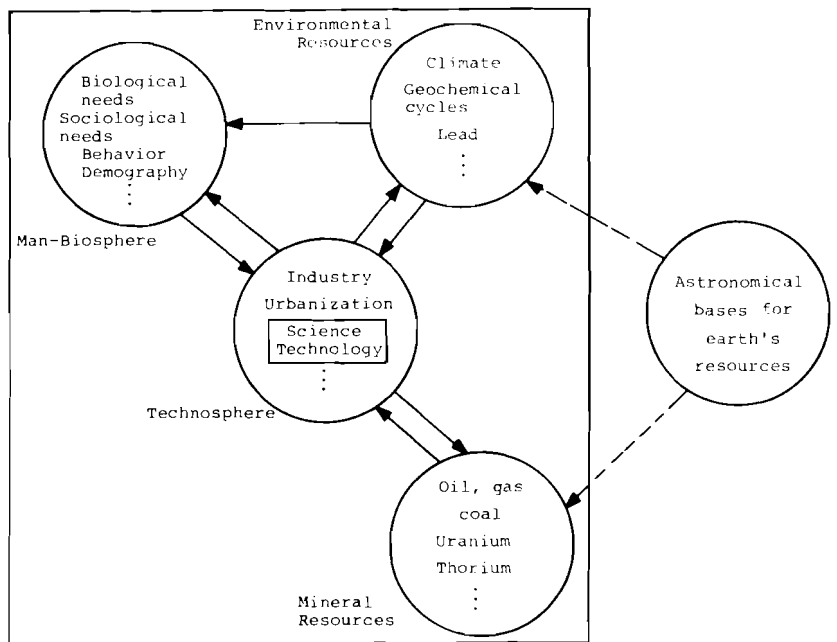

Figure 3. Model of the earth's ecosphere.

3.7. Decision Analysis Applications in Ecology

D.E. Bell

Members of the Methodology Project performed studies to measure objective functions for the three case studies of budworm, salmon and regional energy. In each of the cases, one or more members of the Ecology Project were interviewed regarding the statistics of the problem that they felt were important "attributes".

It is probable that the fundamental form of the utility function does not need to be sophisticated; but to verify this, the budworm case study was being done in both the simplified and sophisticated way.

In trying to reflect the decision makers preferences in the budworm study, we found that existing procedures for handling assessment for time streams were insufficient, and that a new approach had to be made. The main difficulty was that the decision makers attitude toward risk in one period depended on outcomes in other periods, a possibility normally assumed.

A complication in the salmon study was the presence of many different interest groups (different categories of fishermen, non-seagoing fish industries, Indians, etc.).

References

- [1] Bell, D.E. "Defining and Quantifying Goals for Measuring the State of an Ecosystem." IIASA-RR-74-26, Laxenburg, Austria, International Institute for Applied Systems Analysis, 1974.
- [2] Bell, D.E. "A Utility Function of Time Streams Having Inter-Period Dependencies." IIASA-RR-75-22, Laxenburg, Austria, International Institute for Applied Systems Analysis, 1975.
- [3] Bell, D.E. "A Utility Function Over Time for Forest Pest Management." Laxenburg, Austria, International Institute for Applied Systems Analysis (forthcoming).
- [4] Keeney, R.L. "Energy Policy and Value Tradeoff." Laxenburg, Austria, International Institute for Applied Systems Analysis (forthcoming).
- [5] Keeney, R.L. "A Group Preference Axiomatization of Cardinal Utility." IIASA-RM-75-47, Laxenburg, Austria, International Institute for Applied Systems Analysis, 1975.
- [6] Keeney, R.L. " A Utility Function for Examining Fishing Control Strategies on the Skeena River." Laxenburg, Austria, International Institute for Applied Systems Analysis (forthcoming).

Appendix 1

Papers by Members of the IIASA Ecology Project

Note:

The WP series are informal, in-house working papers that are distributed outside IIASA for comment and criticism solely at the discretion of their author(s). We include their titles here only to inform readers of the kinds of topics currently exercising project members. All other papers may be ordered through the IIASA Publications Department.

- [1] "Alpine Areas Workshop," May 13-17, 1974. H. Franz and C.S. Holling, Coordinators. IIASA-CP-74-2, Laxenburg, Austria, International Institute for Applied Systems Analysis, 1974.
- [2] Bigelow, J.H. "Transportation Modelling in the Comparative Energy Study." IIASA-WP-75-73, Laxenburg, Austria, International Institute for Applied Systems Analysis, 1975.
- [3] Clark, W.C. "What Is This Case All About?" IIASA-WP-73-7, Laxenburg, Austria, International Institute for Applied Systems Analysis, 1973.
- [4] Clark, W.C. "Annotated Bibliography on Ecological Aspects of Regional Development." IIASA-WP-74-15, Laxenburg, Austria, International Institute for Applied Systems Analysis, 1974.
- [5] Dantzig, G.B. "Comments on the Budworm-Forest Ecology Model." IIASA-WP-73-12, Laxenburg, Austria, International Institute for Applied Systems Analysis, 1973.
- [6] Dennis, R. and Ito, K. "An Initial Framework for Description of Regional Pollution Emissions in the IIASA Integrated Energy System Research Program." IIASA-WP-75-61, Laxenburg, Austria, International Institute for Applied Systems Analysis, 1975.
- [7] Fiering, M. "Proposal for Studying an Environmental 'Zoo'." IIASA-WP-73-19, Laxenburg, Austria, International Institute for Applied Systems Analysis, 1973.

- [8] Fiering, M.B. and Holling, C.S. "Management and Standards for Perturbed Ecosystems." IIASA-RR-74-3, Laxenburg, Austria, International Institute for Applied Systems Analysis, 1974.
- [9] Foell, W.K. "Integrated Energy Systems Modelling and Policy Analysis; A Description of an IIASA Research Program." IIASA-WP-75-38, Laxenburg, Austria, International Institute for Applied Systems Analysis, 1975.
- [10] Gatto, M., Rinaldi, S., and Walters, C. "A Predator-Prey Model for Discrete-Time Commercial Fisheries." IIASA-RR-75-5, Laxenburg, Austria, International Institute for Applied Systems Analysis, 1975.
- [11] Hilborn, Ray. "Stock Enhancement in Salmon and Maintenance of Historic Runs." IIASA-WP-74-63, Laxenburg, Austria, International Institute for Applied Systems Analysis, 1974.
- [12] Hilborn, Ray. "A Formal Method for the Construction of Cross Impact Matrices." IIASA-WP-74-64, Laxenburg, Austria, International Institute for Applied Systems Analysis, 1974.
- [13] Hilborn, Ray. "The Use of Parameter Space in Resource Management or Let's Stop Thinking in Terms of Equilibrium-Oriented Methods." IIASA-WP-74-65, Laxenburg, Austria, International Institute for Applied Systems Analysis, 1974.
- [14] Hilborn, Ray. "A Policy Failure Analysis of Salmon Enhancement Programs." IIASA-WP-75-11, Laxenburg, Austria, International Institute for Applied Systems Analysis, 1975.
- [15] Hilborn, Ray. "Thoughts on Preferences and Utility in the Salmon Case Study." IIASA-WP-75-39, Laxenburg, Austria, International Institute for Applied Systems Analysis, 1975.
- [16] Hilborn, Ray, Lee, Hilary, and Yorque, Ralf. "Seward's Folly, Salmon Management, and Discounting Rates." IIASA-WP-75-59, Laxenburg, Austria, International Institute for Applied Systems Analysis, 1975.
- [17] Hoelzl, A. and Foell, W.K. "A Brief Overview of Demographic and Energy Characteristics of the German Democratic Republic, Rhône-Alpes and Wisconsin." IIASA-WP-75-65, Laxenburg, Austria, International Institute for Applied Systems Analysis, 1975.
- [18] Holling, C.S. "Systems Resilience and Its Policy Consequences: Proposal for Work at IIASA." IIASA-WP-73-1, Laxenburg, Austria, International Institute for Applied Systems Analysis, 1973.

- [19] Holling, C.S. "Resilience and Stability of Ecological Systems." IIASA-RR-73-3, Laxenburg, Austria, International Institute for Applied Systems Analysis, 1973.
- [20] Holling, C.S. et al. "Description of the Predation Model." IIASA-RM-73-1, Laxenburg, Austria, International Institute for Applied Systems Analysis, 1973.
- [21] Holling, C.S. "Development and Use of Ecological Modules in Resource Development Simulation." IIASA-RM-73-3, Laxenburg, Austria, International Institute for Applied Systems Analysis, 1973.
- [22] Holling, C.S. "On Leaving China." IIASA-WP-73-6, Laxenburg, Austria, International Institute for Applied Systems Analysis, 1973.
- [23] Holling, C.S. "On Making A Marriage, An Institute, or A Society." IIASA-WP-73-10, Laxenburg, Austria, International Institute for Applied Systems Analysis, 1972.
- [24] Holling, C.S. "Program for Ecology and Environment Project." IIASA-WP-73-13, Laxenburg, Austria, International Institute for Applied Systems Analysis, 1973.
- [25] Holling, C.S. "Summary of Budworm Workshop." IIASA-WP-74-3, Laxenburg, Austria, International Institute for Applied Systems Analysis, 1974.
- [26] Holling, C.S. "Modelling and Simulation for Environmental Impact Analysis." IIASA-RM-74-4, Laxenburg, Austria, International Institute for Applied Systems Analysis, 1974.
- [27] Holling, C.S. "Notes Towards a Science of Ecological Management." IIASA-WP-74-22, Laxenburg, Austria, International Institute for Applied Systems Analysis, 1974.
- [28] Holling, C.S., Dantzig, G.B., Baskerville, C., Jones, D.D., and Clark, W.C. "A Case Study of Forest Ecosystem/Pest Management." IIASA-WP-75-60, Laxenburg, Austria, International Institute for Applied Systems Analysis, 1975.
- [29] Jones, D.D. "Explorations in Parameter Space." IIASA-WP-73-3, Laxenburg, Austria, International Institute for Applied Systems Analysis, 1973.
- [30] Jones, D.D. "Boundaries of Stability: A Potpourri of Dynamic Properties." IIASA-WP-73-4, Laxenburg, Austria, International Institute for Applied Systems Analysis, 1973.

- [31] Jones, D.D. "The Fourth Power in the Universe." IIASA-WP-73-5, Laxenburg, Austria, International Institute for Applied Systems Analysis, 1973.
- [32] Jones, D.D. "The Spruce Budworm Model: Some Questions, Corrections, and Comments." IIASA-WP-73-14, Laxenburg, Austria, International Institute for Applied Systems Analysis, 1973.
- [33] Jones, D.D. "Analysis of a Compact Predator-Prey Model I. The Basic Equations and Behavior." IIASA-WP-74-34, Laxenburg, Austria, International Institute for Applied Systems Analysis, 1974.
- [34] Jones, Dixon D. "The Application of Catastrophe Theory to Ecological Systems." IIASA-RR-75-15, Laxenburg, Austria, International Institute for Applied Systems Analysis, 1975.
- [35] "Proceedings of IIASA Planning Conference on Ecological Systems," September 4-6, 1973. Volumes I and II, IIASA-CP-73-6, Laxenburg, Austria, International Institute for Applied Systems Analysis, 1973.
- [36] "Proceedings of A Workshop on Salmon Management," February 24-28, 1975. IIASA-CP-75-2, Laxenburg, Austria, International Institute for Applied Systems Analysis, 1975.
- [37] "Project Status Report: Energy Systems," April 5, 1974. SR-74-2-/N, Laxenburg, Austria, International Institute for Applied Systems Analysis, 1974.
- [38] Sazonov, B.I. "An Approach to the Modelling of Global Environmental Problems." IIASA-WP-75-1, Laxenburg, Austria, International Institute for Applied Systems Analysis, 1975.
- [39] Sazonov, B.I. and Shvytov, I.A. "Random Process Theory in Ecological and Environmental Modelling." IIASA-WP-75-41, Laxenburg, Austria, International Institute for Applied Systems Analysis, 1975.
- [40] Staley, Michael. "Pre-Season Prediction of Sockeye Salmon Runs on the Skeena River." IIASA-WP-75-16, Laxenburg, Austria, International Institute for Applied Systems Analysis, 1975.
- [41] Stehfest, H. "Decision Theoretical Remark on Sensitivity Analysis." IIASA-RR-75-3, Laxenburg, Austria, International Institute for Applied Systems Analysis, 1975.
- [42] Stehfest, H. "Mathematical Modelling of Self-Purification of Rivers." IIASA-WP-75-49, Laxenburg, Austria, International Institute for Applied Systems Analysis, 1975.

- [43] Uzawa, H. "Economic Growth and the Social Ownership of Overhead Capital, I." IIASA-WP-74-33, Laxenburg, Austria, International Institute for Applied Systems Analysis, 1974.
- [44] Velimirovic, H. "Analysis of the Relationship Between Social Structure and Stress Behavior in Primitive Societies." IIASA-WP-74-2, Laxenburg, Austria, International Institute for Applied Systems Analysis, 1974.
- [45] Velimirovic, Helga. "Resilience Factors Inherent in Social Systems: A Comparative Study." IIASA-WP-74-36, Laxenburg, Austria, International Institute for Applied Systems Analysis, 1974.
- [46] Walters, Carl. "Optimal Harvest Strategies for Pink Salmon in the Skeena River: A Compressed Analysis." IIASA-WP-75-3, Laxenburg, Austria, International Institute for Applied Systems Analysis, 1975.
- [47] Walters, Carl. "Optimal Harvest Strategies for Salmon in Relation to Environmental Variability and Uncertainty about Production Parameters." IIASA-WP-75-4, Laxenburg, Austria, International Institute for Applied Systems Analysis, 1975.
- [48] Walters, Carl. "Adaptive Control Problems in Renewable Resource Development." IIASA-WP-75-7, Laxenburg, Austria, International Institute for Applied Systems Analysis, 1975.
- [49] Walters, Carl. "The Salmon Case Study: An Overview." IIASA-WP-75-10, Laxenburg, Austria, International Institute for Applied Systems Analysis, 1975.
- [50] Walters, Carl, and Buckingham, Sandra. "A Control System for Intraseason Salmon Management." IIASA-WP-75-28, Laxenburg, Austria, International Institute for Applied Systems Analysis, 1975.
- [51] Walters, Carl. "Identification of Potential Impacts of Resource Development Programs: The Need for a New Paradigm." IIASA-WP-75-32, Laxenburg, Austria, International Institute for Applied Systems Analysis, 1975.
- [52] Walters, Carl. "Foreclosure of Options in Sequential Resource Development Decisions." IIASA-RR-75-12, Laxenburg, Austria, International Institute for Applied Systems Analysis, 1975.
- [53] Walters, Carl. "Ralf's Rambling Resilience Number or How Big Is Your Tau Today." IIASA-WP-75-38, Laxenburg, Austria, International Institute for Applied Systems Analysis, 1975.

- [54] Walters, Carl and Hilborn, Ray. "Adaptive Control of Fishing Systems." Laxenburg, Austria, International Institute for Applied Systems Analysis (forthcoming).
- [55] Weingart, Jerome. "Preliminary Data Requirements for a Feasibility Study of the Solar Option in the Rhône-Alpes Region of France." IIASA-WP-75-68, Laxenburg, Austria, International Institute for Applied Systems Analysis, 1975.
- [56] Yorque, Ralf. "Glossary of Ecological Terminology with Particular Reference to Fisheries." IIASA-WP-75-14, Laxenburg, Austria, International Institute for Applied Systems Analysis, 1975.