

PROCEEDINGS OF A WORKSHOP ON  
MODELLING OF WATER DEMANDS

17-21 January 1977

J. Kindler, Editor

November 1977

WP-77-18

Working Papers are internal publications intended for circulation within the Institute only. Opinions or views contained herein are solely those of the author.

2361  
Laxenburg  
Austria

International Institute for Applied Systems Analysis



## Preface

Interest in water resources systems has been a critical part of resources and environment related research at IIASA since its inception. As demands for water increase relative to supply, the intensity and efficiency of water resources management must be developed further. This in turn requires an increase in the degree of detail and sophistication of the analysis, including economic, social and environmental evaluation of water resources development alternatives aided by application of mathematical modelling techniques, to generate inputs for planning, design and operational decisions.

In the years of 1976 and 1977 IIASA has initiated a concentrated research effort focusing on *modelling and forecasting of water demands*. Our interest in water demands derived itself from the generally accepted realization that these fundamental aspects of water resources management have not been given due consideration in the past.

The Resources and Environment Area of IIASA (Task 1, Regional Water Demand and Management) held from 17 to 21 January 1977 a Workshop on Modelling of Water Demands. 29 people from 14 different countries attended this Workshop.

The Proceedings open with an introduction which attempts to provide the reader with the overall framework of IIASA's studies on modelling and forecasting of water demands. Then follows a collection of invited papers and national review reports which provide a good overview as to what is understood by "water demand analysis" in most of the IIASA NMO countries.

Dr. Janusz Kindler  
Task Leader

## ACKNOWLEDGEMENTS

The research on water demands carried out at the International Institute for Applied Systems Analysis is partially supported with funds provided by Stiftung Volkswagenwerk and by Rockefeller Foundation grants RF75033, Allocation No. 32, and GANES 7712.

We would like to express our thanks to all those who contributed to the Workshop on Modelling of Water Demands, whether by means of formal presentations or through participation in the discussions. Special thanks are due to Ms. Denise Promper for her assistance in collating and editing this publication.

## Table of Contents

INTRODUCTION	
Janusz Kindler .....	1
INVITED PRESENTATIONS .....	9
<i>Demand, Supply, and Economic Efficiency</i>	
Anthony C. Fisher .....	11
<i>Economic Demand for Water and</i>	
<i>Economic Costs of Pollution Control</i>	
Russell G. Thompson .....	19
<i>Process Modelling Using Linear Programming</i>	
James A. Calloway .....	37
<i>Systems Analysis Applied to Agricultural</i>	
<i>Water Demand</i>	
David R. Maidment .....	47
<i>Regional Water Supply Functions</i>	
Ilya Gouevsky .....	57
<i>Remarks on Water Demand-Supply Coordination</i>	
Wladyslaw Findeisen .....	69
REVIEW REPORTS FROM THE NATIONAL MEMBER ORGANIZATIONS	75
<i>A Brief Account of Methods Used for Estimating</i>	
<i>Water Requirements in the USSR</i>	
G.V. Voropaev & A.L. Velikanov .....	77
<i>Water Demand Modelling--An Ecological Perspective</i>	
Alan Chambers .....	83
<i>Some Remarks on Modelling of</i>	
<i>Water Demands in Czechoslovakia</i>	
Quido Partl .....	87
<i>Some General Remarks on Modelling of Water</i>	
<i>Demands in the German Democratic Republic</i>	
Siegfried Dyck .....	91
<i>Determination of Water Demands in the</i>	
<i>Federal Republic of Germany</i>	
Wolfgang Günther .....	97
<i>Water Resources Planning and Management</i>	
<i>and The Role of Demand Studies</i>	
Charles W. Howe .....	101
<i>An Overview of Water Resources Management</i>	
<i>and Water Demand Problems in Poland</i>	
A. Laski & A. Symonowicz .....	105

Table of Contents continued

<i>Demand Modelling in England and Wales</i> Robert J. Smith .....	109
<i>Methods of Forecasting Water Use in Hungary</i> Joseph C. Csuka .....	115
<i>Modelling of Water Demands--A Review of Swedish Experiences</i> Gunnar Lindh .....	121
<i>Modelling of Water Use in Finland</i> Pentti Yletyinen .....	129
<i>Review of Activities on Water Resources Planning and Water Demands Modelling in the Netherlands</i> H.J. Colenbrander .....	137
APPENDIXES .....	151
I. Introductory Letter to the Workshop Participants .....	153
II. Definitions of Terms .....	157
III. Workshop Agenda .....	159
IV. List of Workshop Participants .....	161
V. Proposed Course of Action .....	163
VI. <i>Survey on Methods for Estimating Water Demands and Wastewater Discharges</i> .....	165

## I N T R O D U C T I O N

by

Janusz Kindler

International Institute for  
Applied Systems Analysis  
Laxenburg, Austria

When the former Water Project of the International Institute for Applied Systems Analysis first decided to focus its activities in the years 1976-1977 on *modelling and forecasting of water demands*, the original terms of reference for this study were conceived as follows (Agreement, 1975):

...In spite of the rising importance of water resources management most of the known studies have ignored the fact that the demand for water is largely affected by changes in technology, pricing policies and wastewater regulations. Rather than assuming a given water requirement, *water demand should be modelled as a function of several factors* which affect water withdrawals, water consumption, and the amount of wastewater. Such an analysis should form a basis for forecasting under alternative assumptions concerning the future. It should also provide the basis for evaluating whether certain measures related to the development and operation of the water resources systems are justified by the extent of demand for water and water-related services. *The key idea underlying the above mentioned considerations is the substitution of water for other inputs such as labour, material, and technology.*

There is a number of water demand models, for market as well as for centrally planned economies, with different degrees of aggregation. Some of them have been used for the forecasting of water demand for different time horizons (1990, 2000, 2020). IIASA's interdisciplinary character offers an excellent opportunity to judge, compare, and refine the existing water demand models. The models could be improved by their integration with the economic growth models and an input-output analysis, thus creating a new methodology by means of which the impact of general economic policy on the management of water resources might be determined.

Although the methodology for the derivation of water demand functions is rather general, *it is proposed to concentrate on those branches of economy which are most important for the regional water management.* Those include the following:

- power generation;
- coal mining;
- chemical industry, including petroleum refining;
- metallurgical industry;
- agriculture.

The parameters of the demand functions shall be estimated on the basis of the available data from selected countries and regions.

A water demand study shall be implemented at *IIASA in cooperation with a few selected national institutions* which are interested in this problem.

For 1976 it is planned to:

- collect information on the existing water demands models and discuss them at an *IIASA Workshop*;
- develop a general methodology for the derivation of water demand functions.

At the same time collaboration will start with the interested research institutions.

In 1977 models of water demands for selected branches of the economy will be developed and their parameters determined on the basis of data from selected regions. Most of this task will be conferred to the national institutions. The results will be discussed at the *Second IIASA Workshop* to be held at the end of 1977 or in early 1978...

In economics, the term *demand* means the quantity of a commodity or service wanted at a specific *price* and *time*, with due consideration given to all *other factors* which influence demand. As far as water is concerned, this term is still being used interchangeably with *needs* and *requirements* which describe the quantities that "people would like to have" if they could get them at the negligible cost or at a subsidized price. The interchangeable use of *demand*, *needs*, and *requirements* provide a good illustration of the fact that water is still often treated as a free commodity.

Our interest in *water demands* derived itself from the widely accepted realization that water cannot be considered a free commodity any longer. Even if water withdrawals and water use are not explicitly priced, beyond a certain level of resource development increasingly greater costs are generally incurred in developing each additional increment of water. These ever increasing costs, considerations for environmental protection, and



advancements in technology have all generated an ever growing concern throughout the world for the urgent need to conserve, recycle, and reuse our limited water resources. It is becoming increasingly apparent that water should be viewed as a partially substitutable input of the *industrial* and *agricultural* production processes and that effort should be made to find the most efficient use of this resource. The possibilities of substituting water for other inputs in production should be, therefore, studied in much more detail. As far as *municipal* water use is concerned, it has been found in many countries that the quantity of water demanded is significantly affected by pricing mechanisms and by various other factors related to the technology of water use in households and municipal services. All the foregoing has inspired IIASA to undertake a study of the methods and approaches by which current practices of *modelling and forecasting the demand for water* could be advanced to meet the increasing need for efficient use and protection of water resources.

After a period of preparation, assembly of the in-house research team (I. Gouevsky, J. Kindler, D.R. Maidment), and following an extensive literature search, it was decided in early fall 1976 that the Resources and Environment Area (Task 1, "Regional Water Demand and Management"--formerly part of the IIASA Water Project) would convene a Workshop on *Modelling of Water Demands* with the following objectives:

- 1) Review work to be done at IIASA in light of the experiences in each of the National Member Organization (NMO) countries.
- 2) Identify research institutions with whom IIASA could establish collaborative ties.
- 3) Establish an international working group directly supporting in-house research at IIASA.

The Introductory Letter to Workshop Participants and the proposed Definition of Terms are included as Appendices I and II of these Proceedings.

In the process of preparing for the Workshop and following the suggestion of Prof. C.W. Howe from the University of Colorado at Boulder, whose help in structuring the subject study is gratefully acknowledged, the IIASA Water Demand Group established working relations with the Industry Studies Program at the University of Houston, Texas. Economic models of water use and wastewater treatment were developed at the University of Houston to measure the economic demands for water and the economic costs of pollution control in *petroleum refining, electric power, and basic chemical industries*. This work has been undertaken in response to the U.S. National Water Commission's concern about the efficiency of water use in the industrial sector of the economy. One of the primary goals was to evaluate how water use would change in response to water conservation incentives, environmental enhancement considerations, technological developments, and economic growth in final demands (see for additional details the paper by R.G. Thompson included in these Proceedings).

The material distributed among the participants prior to the Workshop included two papers originating from the work carried out at the University of Houston, which describe how to derive the demand functions for water in electric power generation (Thompson and Young, 1973) and ammonia industries (Calloway, Schwartz, and Thompson, 1974). The first one of these two papers includes a small example of how demand function for water is derived under the assumption that the production function is differentiable. Moreover, both of these papers provide a good illustration of how the economic process model can be built and of how the method of linear programming can be employed for derivation of water demand functions (see the paper by J.A. Calloway which is also included in these Proceedings).

The Workshop Agenda and the List of Workshop Participants are presented as Appendices III and IV in these Proceedings. The simple structure of having invited presentations followed by review reports from the IIASA National Member Organization countries was adopted as the most suitable for achieving the aforementioned Workshop objectives. A considerable amount of time was allocated for questions, comments, discussion, and for the formulation of the Workshop recommendations. As opposed to some other seminars and workshops, the one reported here was primarily intended to plan in-house investigations and to stimulate collaborative research in the IIASA NMO countries. The reader should therefore not be surprised by the diversity of individual contributions published in these Proceedings. In spite of our editorial efforts, the manner in which the terminology is used is also not always consistent. This applies even to the key word *demand* which varies sometimes from our understanding of the term. The authors have, however, done their best to present the motivations and implications of water demand analysis, and the resultant publication provides the reader with an interesting overview as to what is understood by *water demand analysis* in most of the IIASA NMO countries<sup>1</sup>.

The invited presentations open with a paper by A.C. Fisher providing a brief exposition of the basic concepts of demand, supply, and economic efficiency, as a framework for water demand modelling. The purpose of this paper is to provide the reader

---

<sup>1</sup>Representatives from all 17 IIASA National Member Organizations were invited to the Workshop. Written contributions are not included from representatives of the Japanese Committee for IIASA, and the National Research Council of Italy. The Italian NMO was represented by Prof. Sergio Rinaldi, whose written contribution to the Workshop has subsequently been released as an IIASA Research Report ("Stable Taxation Schemes in Regional Environmental Management", RR-77-10). Dr. Saburo Ikeda represented the Japanese NMO, and his presentation on the Kinki Lake Project was made rather from the perspective of IIASA's Management and Technology Area where he was working and hence not included in this publication. The Bulgarian NMO was represented by Dr. Ilya Gouevsky from IIASA.

with a rudimentary acquaintance of the resource economist's point of view and vocabulary. The paper refers primarily to market economies and to the welfare economics setting of supply/demand analysis. The subsequent discussion pointed out the importance of planning and institutional arrangements which influence the pattern of resource allocation.

R.G. Thompson considers the importance of reassessment of the past trends in water use and of an evaluation as to how economic demands for water and economic costs of pollution control will be affected by different water conservation and environmental enhancement policies. The paper reviews briefly the studies carried out in the United States by the National Water Commission and provides a general description of the studies at the University of Houston concerned with the development of economic models of water use and wastewater treatment in some of the water-intensive industries (plant-level analysis).

The paper by J.A. Calloway deals with process modelling using linear programming. Conceptually, this is a straightforward extension of the classical theory of the firm which wants to determine such a combination of production activities that will minimize the total cost of the resource inputs used to produce a specified amount of the final product. The example of ammonia production analysis provides a good illustration of the issues raised. Finally, it is shown how to use the linear model for derivation of demand functions for scarce resources.

D.R. Maidment discusses a general framework for a systematic approach to the analysis of agricultural water demand. The agricultural production system is considered at three basic levels, i.e. farm, regional, and national. At each level, inputs, production system, and outputs are distinguished as the major components of the agricultural production system. The mathematical modelling of agricultural water demands is discussed from the viewpoint of substitution possibilities in the production system at each level.

Although the Workshop focused on water demands, the integration of demand and supply is the ultimate step leading to the efficient utilization of water resources. The last two invited contributions project into the future area of IIASA's water resources investigations. I. Gouevsky is concerned with derivation of regional water supply functions. Against a theoretical background of a cost minimization problem which takes into account alternative sources of water supply, he describes a linear model to be used for estimation of the said functions. Finally, W. Findeisen comments on demand-supply coordination from the point of view of hierarchical control theory.

The review reports published here contain much information on water demand problems in 12 of IIASA's NMO countries. Needless to say, they also raise a number of important questions for many of which no clear answers are as yet available. The review

reports and the consequent unpublished discussions lead to certain preliminary conclusions which should definitely be taken into consideration when proceedings further with IIASA's water demand study. These conclusions could be summarized as follows:

- (1) In the case of water resources, "demand" should not be considered simply as the relationship between price and the quantity of water demanded at this price. The amount of water withdrawal and use depends as well on a number of other factors (variables), including the technology involved in a given productive or societal activity, social tastes and behaviour, nature of raw materials, constraints and/or charges on wastewater discharges, etc. Even in the market economies, the demand for water cannot be controlled by price mechanisms only.

It is recognized that control of water demand is exceedingly important, whether it is achieved by means of rationing, market distribution, centralized planning, or various types of "economic levers" (incentives to make rational economic behaviour rewarding to the economic agent as well as to the society).

- (2) Water demand analysis has a different meaning depending on the objectives of the particular study. It seems, however, that IIASA's investigations on water demands should focus primarily on individual production or societal activities involving consumptive use of water resources (industrial, agricultural, and municipal activities). The notion of a *water use activity* is being introduced, whether it is an industrial plant, individual farm, agricultural region, city or municipal agglomeration.
- (3) To increase our understanding of water demand, in particular to determine which variables have the most significant influence on that demand, it is necessary to study the individual water use activities in considerable detail. Water demand models, which describe the technology and economics of water use in these activities, can be used to show how the demand for water changes in response to various regulations, prices of raw materials, effluent standards, technological innovations, and so on.
- (4) In most of the IIASA NMO countries, *water use coefficients* are being widely employed (especially in country-wide planning studies). Water demand models may serve as a very useful tool for better estimation of these coefficients and for relating them explicitly to certain assumptions concerning the variables determining demand.
- (5) The importance of institutional arrangements for effective control of water demands was stressed by many Workshop participants. It is an open question as to what extent and how these arrangements can be represented in water demand models.

- (6) One of the serious difficulties which must very often be faced in modelling of water demands, is the lack of a sufficient data base. This may call for considerable re-orientation of water-oriented data collection programs. In the documentation of any water demand model, special emphasis should be placed on the problems pertaining to the collection of basic data and their processing for further use in the modelling effort.
- (7) Integration of water demand and water supply analyses is the ultimate step for the formulation of efficient solutions in water resources management. For example, water demand models could be used for determining whether charges based on the costs of meeting the last increment in demand would actually reduce demand and thereby render new supply works unnecessary.
- (8) There was a general agreement among the Workshop participants that, so far, water demand forecasting has been confined largely to the fitting of trends to the data on past demands. The results are often not satisfactory, especially in light of phenomena observed in the last decade (energy crisis, enforcement of environmental protection regulations, etc.) For example, water use by Swedish industry has decreased by one third in the last three years.
- (9) The forecasting of water demands should involve forecasting the values of the variables which significantly affect demand levels. The water demand model can then be used to estimate future demand as a function of the forecast values of these variables. It was stressed, however, that the significance of individual variables may change over time. The structural and qualitative changes of social and economic processes cannot be fully foreseen, and the concept of "alternative futures" should be employed in the long-term forecasts of water demands.

At the end of the Workshop, the participants agreed on a Course of Action (see Appendix V), which delineated all major steps to be taken toward the next Workshop on Modelling of Water Demands and toward completion of the study. Because of a heavy stress on the collaborative arrangements, the Proceedings close with a copy of the memorandum by which all Workshop participants were requested to provide IIASA with a report on the experiences and the methods which are used in their respective countries for analysis and forecasting of water demands (see Appendix VI).

As pointed out previously, it was strongly felt by a majority of the participants at the Workshop, that the demand side of water resources management deserves much more attention than given in the past. In this context, IIASA's intention to concentrate on modelling and forecasting of water demands in the year to come met with complete support of the Workshop participants. It was made clear, however, that the knowledge of the subject problems is only partial and limited. The field is open for a vast amount of research.

REFERENCES

- Agreement with Stiftung Volkswagenwerk (1975), "Studie über die Methoden zur Ermittlung der Wasserbedarfsentwicklung".
- Calloway, J.A., A.K. Schwartz, Jr. and R.G. Thompson (1974), *An Integrated Power-Process Model of Water Use and Waste Treatment in Ammonia Production*.
- Thompson, R.G. and H.P. Young (1973), "Forecasting Water Use for Policy Making: A Review", *Water Resources Research*, 9, 4, August.

**INVITED PRESENTATIONS**





# DEMAND, SUPPLY, AND ECONOMIC EFFICIENCY

by

Anthony C. Fisher

International Institute for  
Applied Systems Analysis  
Laxenburg, Austria

on leave from the  
University of Maryland  
College Park, Maryland  
USA

## I. Introduction

The purpose of this paper is to provide a brief exposition of the concepts of demand, supply, and economic efficiency, as a framework for water demand modelling. It will be elementary from the economist's point of view, but it is addressed to engineers and others, besides economists, concerned with the modelling and management of water resource systems. The main point of the discussion will be that demand modelling plays a crucial role in the efficient development and management of a region's water resources. Below I indicate just why this may be a relevant consideration to decisionmakers--and what is meant by efficient management.

## II. Demand and Supply

Let me begin by defining the terms "demand" and "supply" as they are understood by economists. By water demand, we mean a functional relationship between the price or cost of water to users and the quantity that they purchase. In other words, associated with each (hypothetical) cost or price is a quantity purchased, or demanded. Note that in principle this definition includes the case in which water is not priced, i.e. is given a zero price. Both economic theory and empirical observation lead us to expect that the relationship between price and quantity will be negative: the higher the price, the less water demanded, the lower the price, the more demanded--at least after allowing sufficient time for adjustments in water-using equipment and practices.

By supply we mean a functional relationship between the price of a commodity and the quantity supplied by competitive producers, where the commodity is in fact produced and sold on competitive markets. The supply relationship is ordinarily

positive: the higher the price the more supplied, the lower the price the less supplied. But as we all know, even in market economies the development of water supply resources, and often also the provision of water to users, is carried out not by large numbers of competitive producers, but by governments. Provision may be by the private sector, but a government-regulated monopoly rather than competitive firms. However, as I show in the next section, the competitive supply curve is nothing other than the *marginal* or *incremental* cost curve for producing a commodity. That is, it is equally a functional relationship between the quantity produced or made available and the incremental cost of production. In this way, we can speak of a marginal cost or supply function for water, even where this commodity is supplied by a government agency.

All of this may be grasped more readily with the aid of a diagram. Since both demand and supply are relationships between price or cost and quantity, they may be represented in the same two-dimensional format, as in Figure 1. The demand curve slopes downward, to reflect the reduced quantities that will be taken at higher prices, and the supply curve slopes upward to reflect the higher incremental costs of supplying more water.<sup>1</sup>

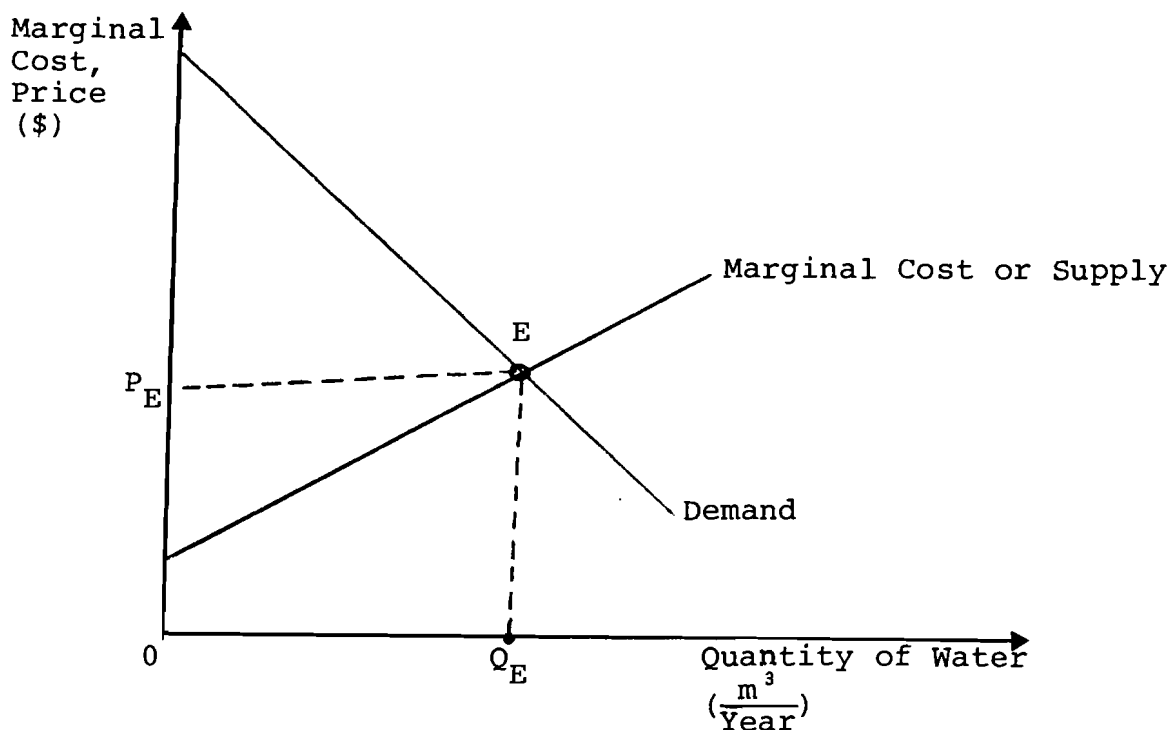

Figure 1

Water Demand and Supply

What is the significance of the intersection of demand and supply, point E in the diagram? In a market system this represents the equilibrium price and output. At price  $P_E$  the quantities supplied and demanded are just equal, there is no pressure on price due to excess demand, hence no net tendency to change: in short, the system is in equilibrium.

### III. Demand, Supply, and Welfare

The relationship of this point to the "welfare" produced by the system is an interesting and complicated one, and the subject of a vast literature.<sup>2</sup> Ignoring the complications and the subtleties, we can very briefly and loosely characterize the welfare implications of a competitive equilibrium in the following way. At the equilibrium point, the sacrifices required to obtain another unit of the good, as measured by the incremental cost, are just equal to the willingness of consumers to pay for it, as measured by the price.<sup>3</sup> At lower levels of output, the cost of expansion is less than the willingness to pay for it, so these outputs are *inefficient* in the sense that *it would be possible to make some people better off without harming others*. There is some "slack" in the system: additional net benefits can be obtained by some reallocation of resources to production of the good in question. Of course, actual price and output changes typically do harm some people, and a very knotty problem in welfare economics is how to evaluate changes that harm some and benefit others.<sup>4</sup> But the weaker efficiency condition that is satisfied by a market equilibrium says only that an allocation is *efficient* if *it is not possible to make a change that harms no one (while benefiting some)*, as might be accomplished through income transfers from the gainers to the losers. On this definition higher levels of output (than at E), as well as lower, are seen to be inefficient, since the incremental cost of obtaining them exceeds the willingness to pay. Only the equilibrium point, E, is efficient.<sup>5</sup>

What are the implications of efficiency, in the sense we have defined it, of a market equilibrium for a nonmarket economy, or for that matter for the nonmarket provision of water supplies typical of most market economies? One way of characterizing the equilibrium point is to say that it represents an output for which price equals incremental or marginal cost. This condition, namely that price equals marginal cost, has in turn been proposed as a guide to resource allocation in centrally planned economies.<sup>6</sup> The proposal is simply that the planning agency give the firm or plant manager a price for his product, along with instructions to produce up to the point where marginal cost equals price. The idea is presumably that this can achieve efficiency in resource allocation, as would a perfectly competitive market system, but in a manner that is not inconsistent with other planning objectives. Here, by the way, is the explanation of the equivalence of marginal

cost and supply. The marginal cost of producing any given output say  $n \frac{m^3}{\text{year}}$  of water, is just the extra cost involved in going from  $(n-1)$  to  $n$  units of output. But in a competitive equilibrium, as we have just seen, price will be equal to marginal cost. So the supply curve, which relates output to price, coincides with the marginal cost curve.

The demand-supply equilibrium can be characterized in another way, that leads to the efficiency criterion employed in water resource and other public sector benefit-cost analysis in market economies. We have defined demand as a function relating quantity purchased to price. But we have also spoken of price as the consumer's willingness-to-pay for or marginal valuation of the good or service in question. Thus we can write  $(P)$  as a function of quantity  $(Q)$ :

$$P = P(Q) \quad . \quad (1)$$

The area under this marginal valuation curve between zero and the quantity consumed,  $\bar{Q}$ , is then the total valuation of, or benefit from, the good. Analytically, it is represented as

$$\int_0^{\bar{Q}} P(Q) dQ \quad . \quad (2)$$

Let us represent the marginal cost (MC) curve as

$$MC = MC(Q) \quad , \quad (3)$$

and total cost as the area under it, or

$$\int_0^{\bar{Q}} MC(Q) dQ \quad . \quad (4)$$

Once again ignoring the many additional complications and subtleties, the idea of benefit-cost analysis is simply to compare (2) and (4); if  $(2) > (4)$ , the project in question yields net benefits and *on efficiency grounds* ought to be undertaken. The significance of the equilibrium point in this analysis is that it represents the *most* profitable size or output level for the project, i.e. the one for which *net* benefits

are maximum. If the shapes of the curves are known, and there is no resource or budgetary constraint that prevents it, this is the output that, again on efficiency grounds, ought to be chosen.

#### IV. Concluding Remarks

To sum up, information about the demand for water is important because without it, efficiency in the development and use of a region's water resources is not possible--even with the best technical and engineering information in the world. This conclusion of course depends on the definition of efficiency presented above, namely that an allocation is efficient if it is not possible to re-allocate resources in such a way as to make at least one person better off while harming no one else--i.e. if it is not possible to increase the net returns to economic activity.

Demand is a relationship between price and quantity purchased, and supply is a relationship between quantity produced and incremental cost. Where the quantity demanded equals the quantity supplied, the willingness of users to pay for another unit of the commodity, as measured by the price, is just equal to the sacrifices required to obtain it, as measured by the incremental cost. This point is efficient, and to determine it requires a knowledge of demand.

---

Footnotes

1. For some commodities, especially water, economies of scale in production may lead to a negatively sloped supply curve over low ranges of output. But eventually, as output is expanded, and higher cost sources must be drawn on, costs of water supply should rise.
2. The relationship between equilibrium in an economic system and welfare criteria is the heart of theoretical welfare economics. A good idea of the range of issues here can be gotten from the American Economic Assoc. volume, Readings in Welfare Economics, edited by Arrow and Scitovsky (1969).
3. When we talk about the willingness of consumers to pay for something, we recognize that this depends on a given distribution of income among them. If the distribution changes, in general so would willingness-to-pay, and prices. But the resulting equilibrium would still have the desirable property noted in the text.
4. Important contributions to the debate about a solution to this problem can be found in the Readings volume cited in footnote 2. In particular, see Kaldor, Hicks, and Scitovsky.
5. Although I have promised to ignore the many qualifications to this proposition, one that is often particularly important where water and other natural resources are concerned really must be mentioned. It is the possible deviation of private from social costs of obtaining the resource. If for example, the diversion of water by upstream users results in an increase in salinity - or other pollution - in the water available to downstream users, the upstream users' marginal cost curve will be "too low", and the market allocation of water to them too great. What is required for social efficiency, as a number of the contributions to the Readings volume point out, is that the external costs of upstream use be internalized to the users, perhaps through some sort of government policy to accomplish this, such as a tax on pollution or water use.
6. The classic work here is by Lange (1952).

REFERENCES

Arrow, K.J., and T. Scitowsky, *Readings in Welfare Economics*, Allen and Unwin, London, 1969.

Lange, O., "On The Economic Theory of Socialism",  
in Lange, O., and F. Taylor, *The Economic Theory of Socialism*, Minneapolis, 1952.





ECONOMIC DEMAND FOR WATER AND  
ECONOMIC COSTS OF POLLUTION CONTROL

by

Russell G. Thompson  
University of Houston  
Houston, Texas, USA

Abstract

Increasing scarcity of water resources requires a re-assessment of past trends in water use and an evaluation of how major changes in policy will result in new trends in water use. Evaluating the economic, resource, and technology consequences of different water policies requires a synthesis of relevant technical information into a comprehensive economic framework. This framework is needed to evaluate how the economic demands for water and the economic costs of pollution control will be affected by different water conservation and environmental enhancement policies. Also, this framework is needed to evaluate the interactive effects of a wide range of policies on the economic demands for water, the economic costs of pollution control, the economic demands for energy, and the economic demands for resource recovery.

Introduction

Increasing scarcity of natural and environmental resources is requiring virtually every nation to reassess its past trends in resource use and to evaluate how its future trends in resource use will differ from historical experience in a period of great policy change. Water is one of the key resources involved in this reassessment and evaluation because of its necessity for biological activity, its universal use in maintaining cleanliness, and its economic value in agricultural, industrial, and recreational activities.

Addressing water issues in both market and non-market economies immediately takes the analyst into the public policy arena. With regard to water use, vast expenditures of money are generally required to develop water resources, and uses of these water supplies are commonly sensitive to the prices charged. With regard to water quality, restrictive wastewater treatment requirements must be enforced by government effluent standards (or charges); and the determination of effluent standards involves a tradeoff between control costs to the water user and detriment costs to society.

Beyond a certain level of resource development, increasingly greater costs are generally incurred in developing each additional increment of water. Incremental costs of supplying larger quantities of water from a given water basin typically increase at an increasing rate; see, for example, Figure 1.

Since World War II, the costs of developing additional water supplies has been a subject of continual public concern in the United States. This public debate has been particularly intense with regard to proposed investments to transfer water from one basin to another. One plan called the Texas Water Plan involved the building of a huge reservoir system on the Mississippi River to insure an adequate flow of water for an interbasin transfer system from the Mississippi River below New Orleans to the High Plains Area in northwest Texas. This transfer system was visualized as essential for maintaining irrigated agricultural productivity in the High Plains, because of the depletion of underground water supplies. Initial costs of the proposed Project to lift immense volumes of water 3 to 4 thousand feet over a distance of around 1,000 miles were in excess of \$10 billion.

An even larger scale project of close to \$100 billion was proposed in the sixties to transfer water from the Yukon River through Canada to the central United States.

#### The National Water Commission Study

In response to public concern about the wisdom of these large proposed interbasin transfers, the Congress created the National Water Commission in the late 1960's to assess the national needs for additional water resource development and to recommend alternative ways of fulfilling these needs. This Commission, following appointment by the President, was given a budget of \$5 million and a five year period to make its report to the President and the Congress.

Fulfillment of the Commission's mandate required an evaluation of how water use would change in response to water conservation incentives, environmental enhancement considerations, technology developments, and economic growth in final demands. This evaluation, which differed fundamentally from previous trend extrapolations, was needed to (1) identify the significant policy levers available to modify the demands for water, (2) show how the use of water would change in response to these policy modifications, and (3) evaluate the economic justifiability of additional water resource development.

Sound measures of the economic demands for water were fundamental to making these evaluations, because the economic demand schedule shows how the use of water will vary in response to the price charged for water, the prices paid for alternative inputs, the technological configuration used in production, the wastewater standards imposed for pollutants, and consumer

requirements for final goods and services. Heavy emphasis was directed by the Commission to measuring the economic demand for water in irrigated agriculture to show the public how selected policy changes would modify the future trends in water use in the water scarce areas of the western United States.

Heady's linear programming model of U.S. agriculture (Heady and Nichol, 1976) (developed at Iowa State University) was used as the basis for measuring the economic demand for water in irrigated agriculture. This model represented a sound means of evaluating how farmers would substitute the use of alternative inputs for water in irrigated agriculture, how farmers would shift the pattern of land use between dryland and irrigated production of different crops, and how farmers in areas where irrigation was not needed would develop comparative economic advantages at higher prices of water.

A base solution in the year 2000 was computed for low existing water prices and specified land availabilities, water supplies, and food and fiber requirements. Higher water prices were charged in repeated solutions to determine how farmers would decrease water use in response to these price increases. Consumptive use of water in the 17 western states of the nation decreased from 53 million acre feet at a price of \$7.50 per acre foot to 16 million acre feet at a price of \$30 per acre foot, see Figure 2. Heady and Nichol (1976) reported "...the increase in the water price...has a more important effect on water use in the 17 western states than does change in the other parameters considered."

#### University of Houston Studies

With support of the National Science Foundation, economic models of water use and wastewater treatment were developed at the University of Houston to measure the economic demands for water and the economic costs of pollution control in the petroleum refining, electric power, and basic chemical industries. One of the first results of their study was the development of an analytical model for electric power generation (Thompson and Young, 1973) to show clearly how technical information needs to be synthesized into an economic framework for modelling of demand functions. This model was used to derive the economic demand for water withdrawals in an existing power plant without a cooling tower option and in an electric power plant with a cooling tower option; see Figures 3 and 4. Also, this model was used to show how the economic demand for water withdrawals may be altered at the design stage by choice of condenser size and level of thermal efficiency; see Figure 5.

Another result of the University of Houston study, following a lead of Russell (1973) was to approximate demand functions for water use in the petroleum refining, electric power, and basic chemicals industries. This approximation method is based

on an identification of the process alternatives, the inputs used, the outputs produced, the pollutants generated, and the resources recovered; see Figure 6. This identification provides the framework for estimating the quantity of each input used and each output produced (including wastes) by each production, resource recovery, and waste treatment process. Specification of the resource availabilities, product requirements, effluent standards, and unit costs completes the tableau for the L.P. problem; see Table 1. Solution of the model gives the least-cost program for producing the product requirements within the limitations of available resources and effluent standards. Repeating this solution process for each water price considered provides an estimate of the economic demand schedule for water withdrawals. Such an estimate is shown in Figure 7 for a representative fossil-fueled electric power model in the United States. Wet-tower cooling reduces water withdrawals in Figure 7 by more than 90 percent at a relatively low water price.

An important by-product of the industry modelling effort is a sound basis to estimate the economic costs of pollution abatement. This basis is needed in the United States to (1) evaluate the feasibility of the national goal to eliminate the discharge of all pollutants to the waterways by 1985 (PL 92-500) and (2) determine the costs of implementing the interim steps needed to accomplish total water recycle by the mid-1980's.

Accomplishment of total water recycle requires zero discharge of all inorganic as well as all organic pollutants; thus, total removal of dissolved solids from the wastewater is a necessity. Figure 8 shows how process adjustments would be made in an ammonia plant at the design stage to accomplish zero discharge of total dissolved solids. Recycle of the cooling water, demineralization and reuse in the boilers, and finally evaporation and recovery of the water from the brine streams are the technical options used in the ammonia model to achieve total recycle.

Similar process adjustments are shown in Figure 9 for the removal of mercury from the wastewaters of a chlor-alkali plant at the design stage. The interesting phenomenon in this case is that accomplishment of zero discharge requires a switch in the production process from a mercury to a diaphragm cell. Surprisingly, the model indicates the zero discharge goal would stimulate use of a lower cost production process.

Olefins production differs from that of ammonia and chlor-alkali production in that both organic and inorganic pollutants are discharged. Modelling of organic treatment processes requires special supporting methods to evaluate the non-additivities in the system. For example, higher removal of Biological Oxygen Demand (BOD) induces higher removal of Chemical Oxygen Demand (COD). This problem was handled in the U of H effort by developing a nonlinear simulation model to adjust the factor proportions and cost coefficients in the linear model. Zero discharge was accomplished in the model at a cost increase of 7.1 percent. As shown in Figure 10, around 63 percent of this increase (or a 4.5 percent independent cost effect) resulted from a switchover to wet-cycle cooling towers.

Table 1. Schematic of industrial model

C O L U M N S

	Exogenous supplies	Production alternatives	Resource recovery	Treatment of residuals	Residuals discharge	Product sales	Right hand sides	
	Exogenous resources	Accounting for exogenous resources					$\leq$ S	
	Product demand requirements		Production of products			Transfer of products to sales	$>$ Q	
R O W S	Resource material balances	Supply of exogenous resources	Input of resource materials	Recovery of resources			$=$ 0	
	Primary residual balances		Output of primary wastes	Input of primary wastes	Input of primary wastes	Input of primary wastes	$=$ 0	
	Secondary residual balances			Output of secondary wastes	Output of secondary wastes	Input of secondary wastes	$=$ 0	
	Residual discharge constraints				1...1		$\leq$ R	
	Objective function	Prices of exogenous supplies	Costs of production	Costs of recovery	Costs of treatment	Effluent charges	Sale price of products	$=$ Z

Another by-product of the modelling effort is a sound means to estimate the costs of air emission control and the interactions between restrictive control of both air and water pollutants. For different levels of wastewater treatment, Figure 11 shows the increasing costs of decreasing sulfur dioxide discharges ( $\text{SO}_2$ ) from a level of virtually no control to a level of maximum technological removal. Costs are estimated for an integrated production complex producing the nation's 1985 forecast requirements for petroleum products, electricity, and basic chemicals. Increasingly greater costs of accomplishing more restrictive levels of  $\text{SO}_2$  control are shown for each level of wastewater treatment. Also, increasingly greater costs of accomplishing more restrictive levels of wastewater treatment are shown for each level of  $\text{SO}_2$  control.

Still another by-product of the modelling effort is a sound means to estimate the economic demands for energy inputs at different levels of environmental control. With no air emission control, Figure 12 shows how the use of crude oil decreases as the price of crude oil increases in U.S. production of petroleum products and basic chemicals (zero discharge to water). Also, Figure 12 shows how restrictive air emission controls for sulfur dioxide and particulates expand the economic demand curve for crude oil at prices from \$6 to \$12 per barrel (no untreated effluent). Total recycle of water is required in both estimates.

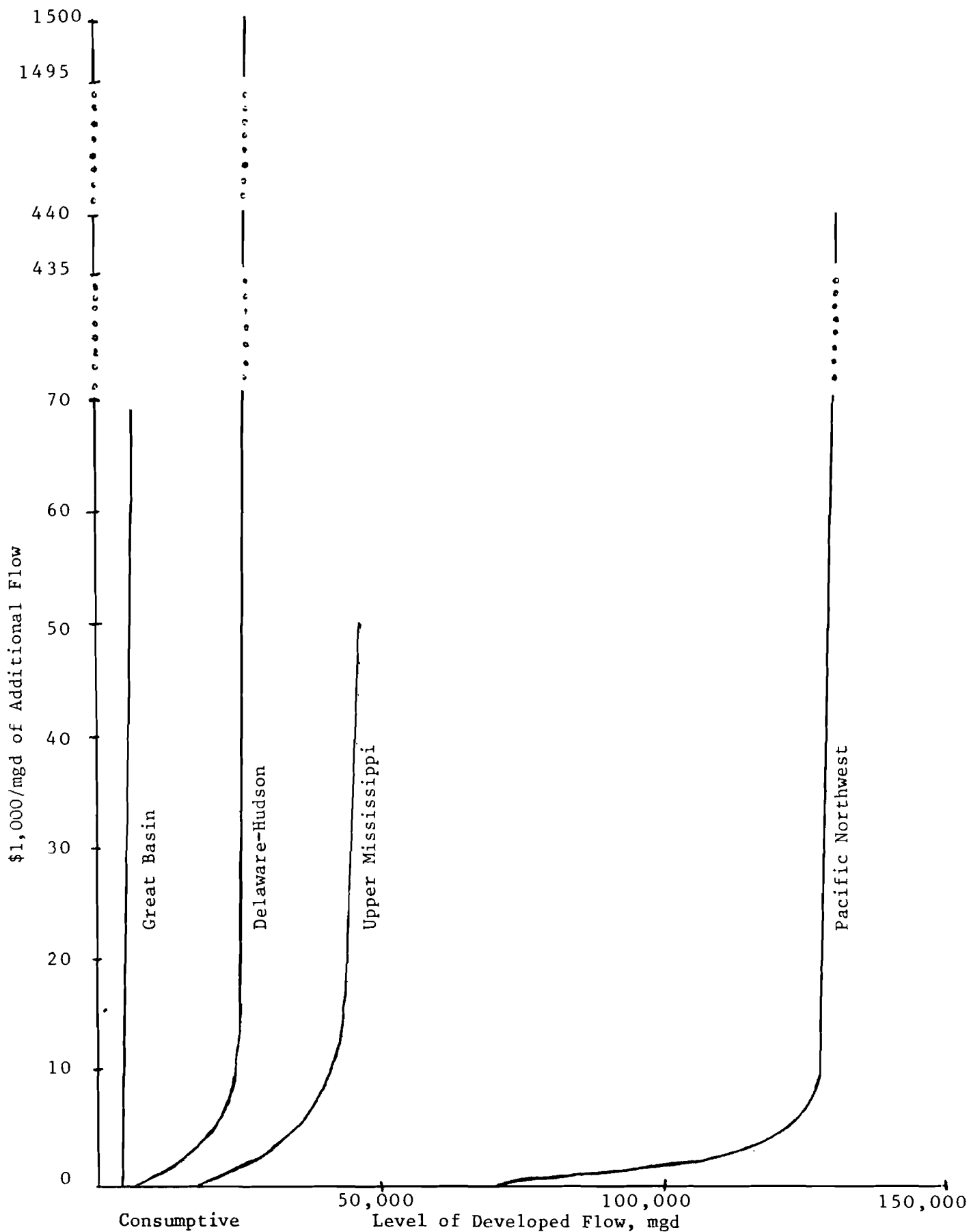

Figure 1

Supply Curves for Water in Selected Water Resource Regions of the United States, 98% Availability.

Source: R.G. Thompson, J.W. McFarland, M.L. Hyatt, and H.P. Young, *Forecasting Water Demands*, National Technical Information Service, Nov., 1971, PB 206491, p. 38.

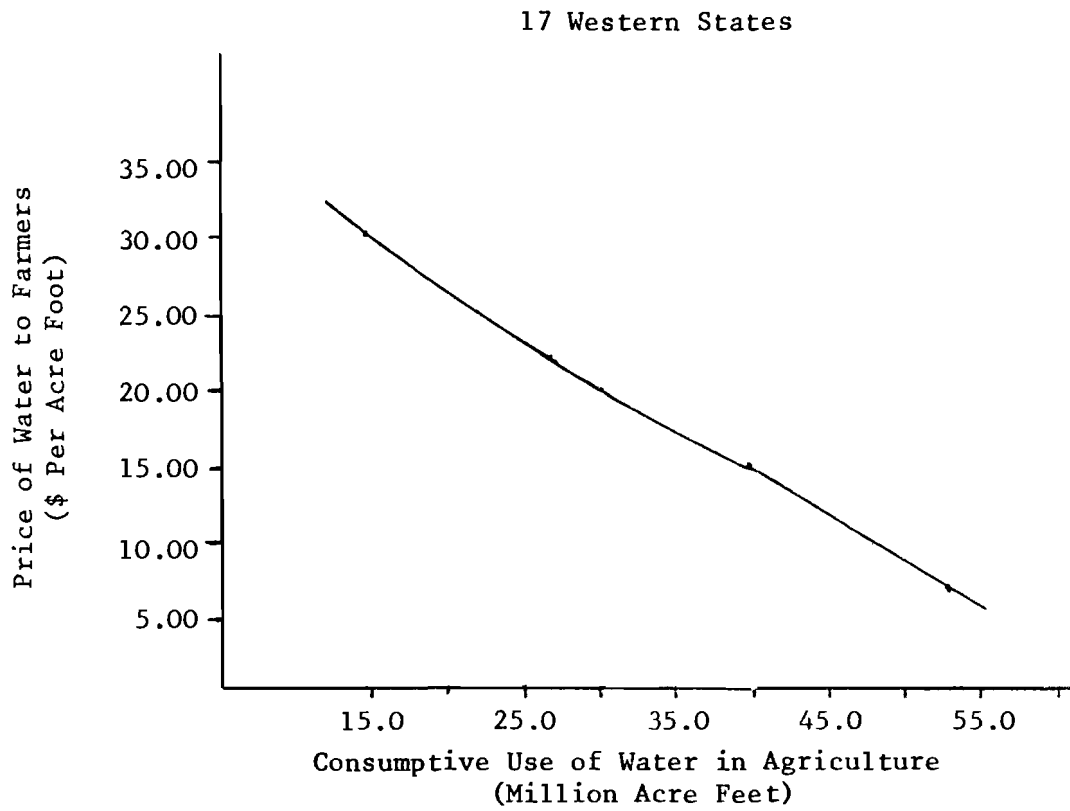

Figure 2

Agricultural demand for water in the  
17 Western States as generated by the model.



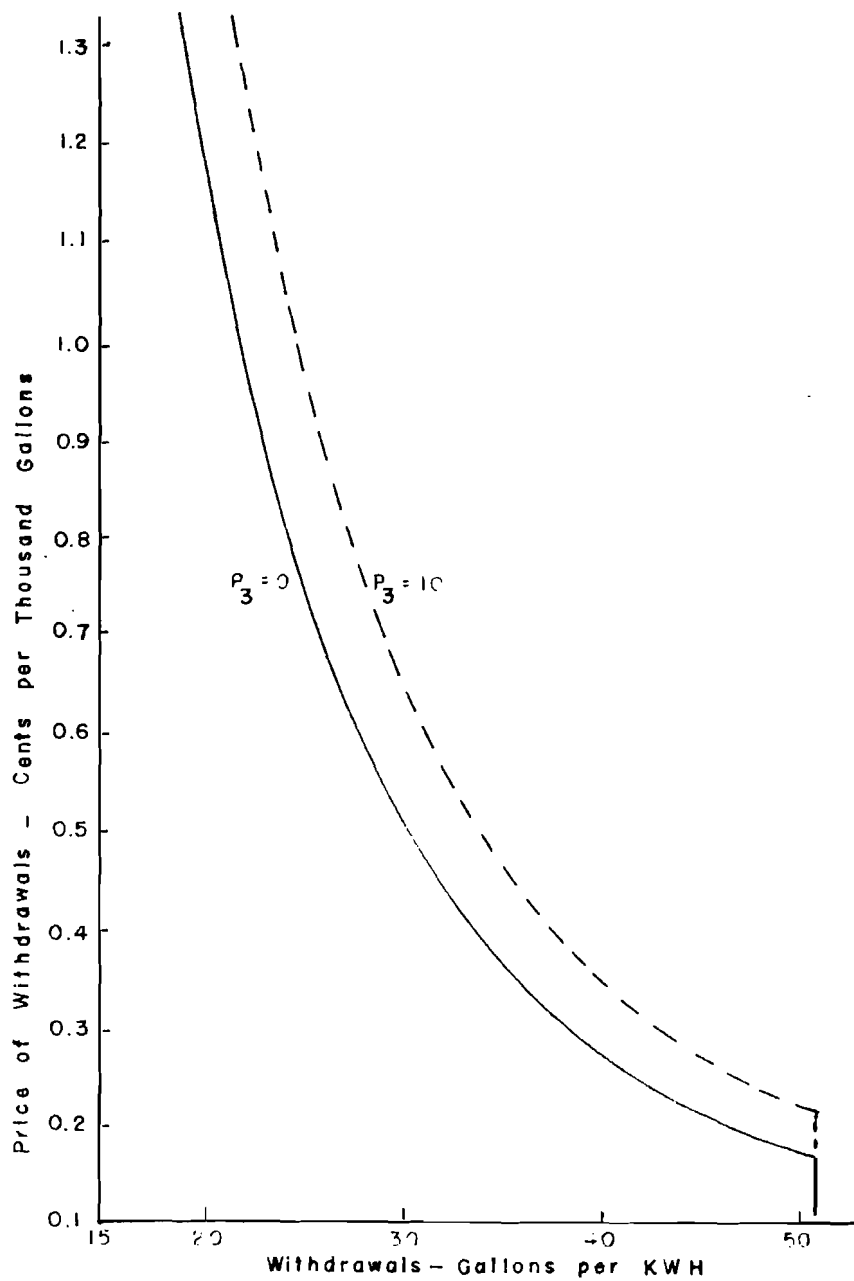

Figure 3

Imputed demand for water withdrawals for steam electric generation under different heat discharge taxes ( $p_1 = 30¢/10^6$  Btu,  $p_3 = 0$  and  $10¢/10^6$  Btu).

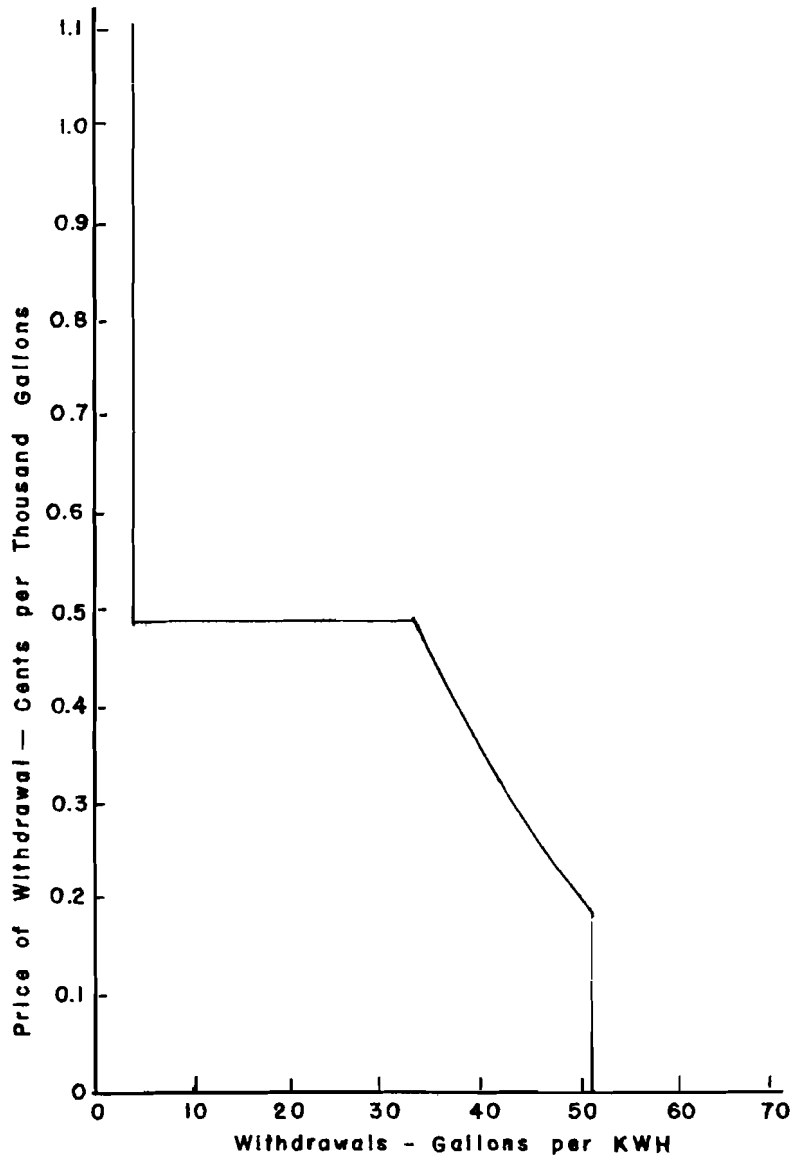

Figure 4

Imputed demand curve with cooling tower option ( $p_1 = 30¢/10^6$  Btu,  $p_3 = 0$ ).

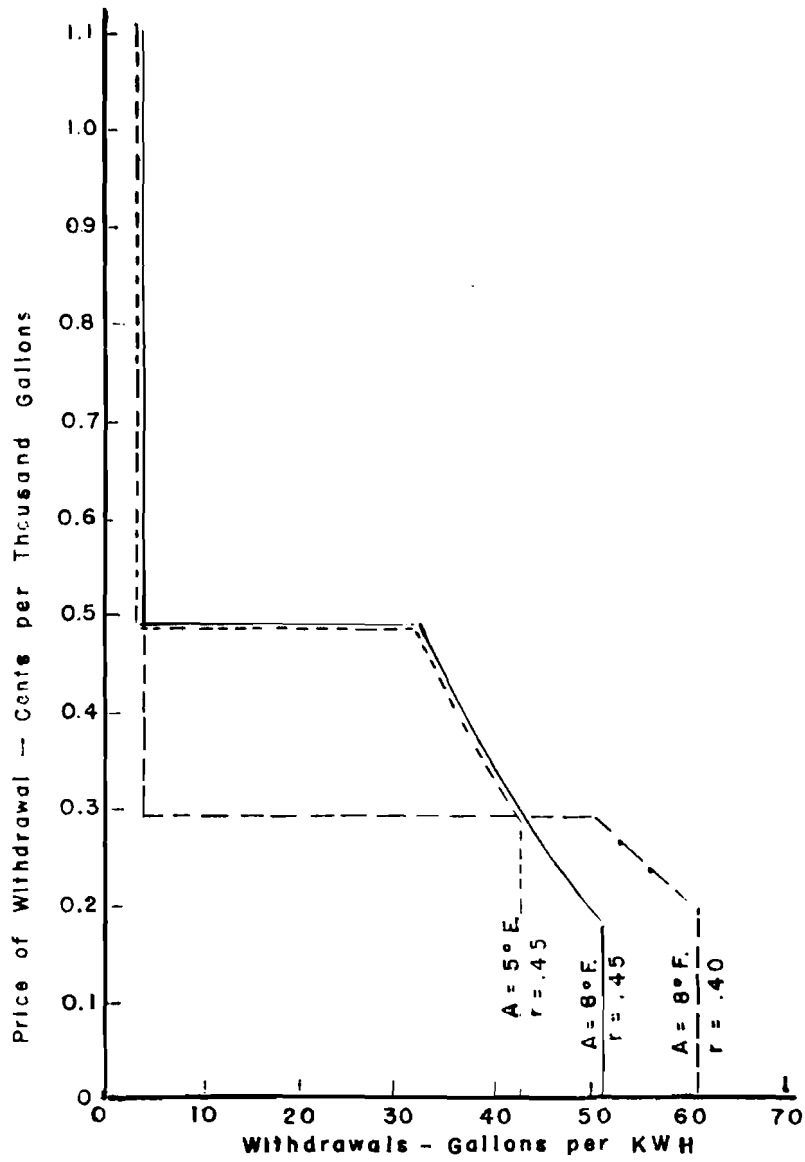

Figure 5

Shifts in the water demand curve due to changes in closest approach A and steam cycle efficiency r.

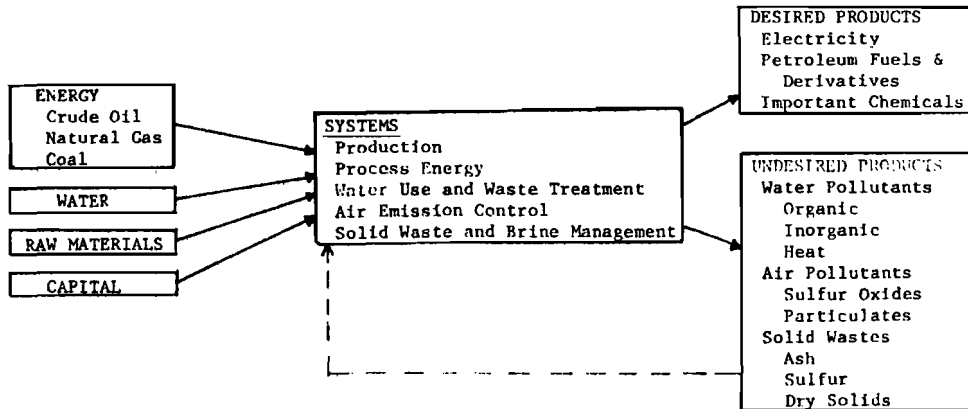

Figure 6

Fundamental components of representative industry models.

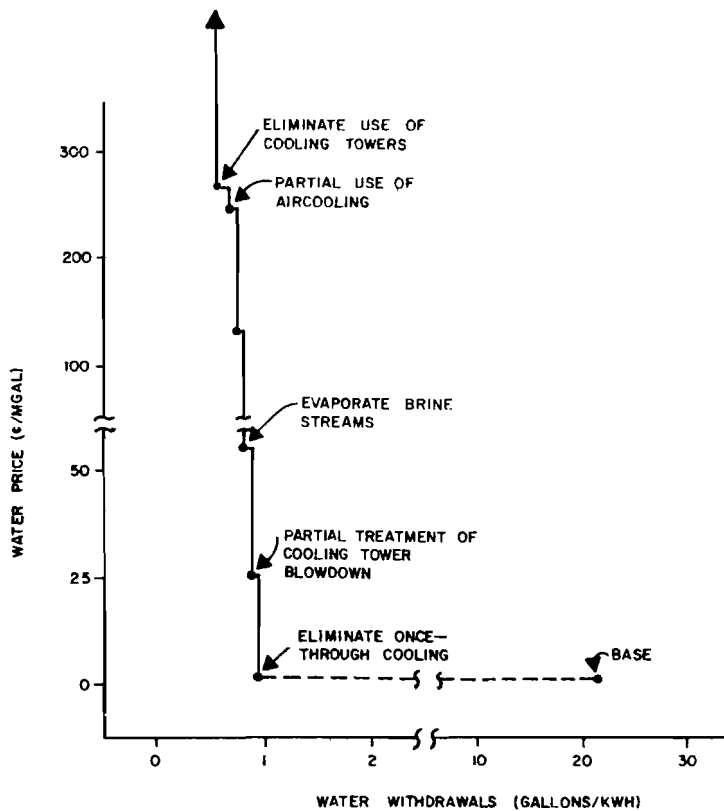

Figure 7

Water withdrawal price vs. water withdrawals.

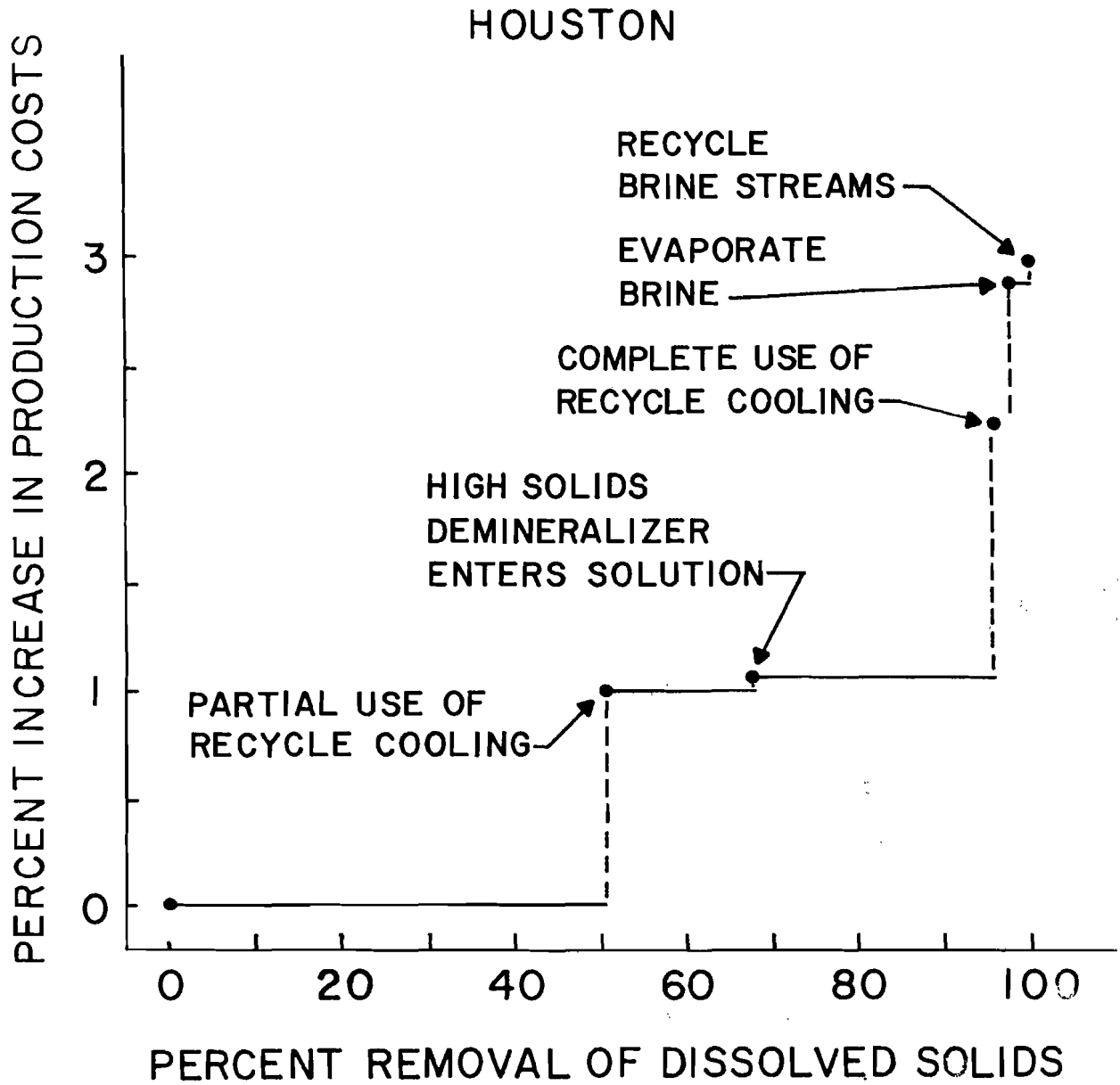

Figure 8

Percent increase in production costs vs. percent removal of dissolved solids in an ammonia plant.

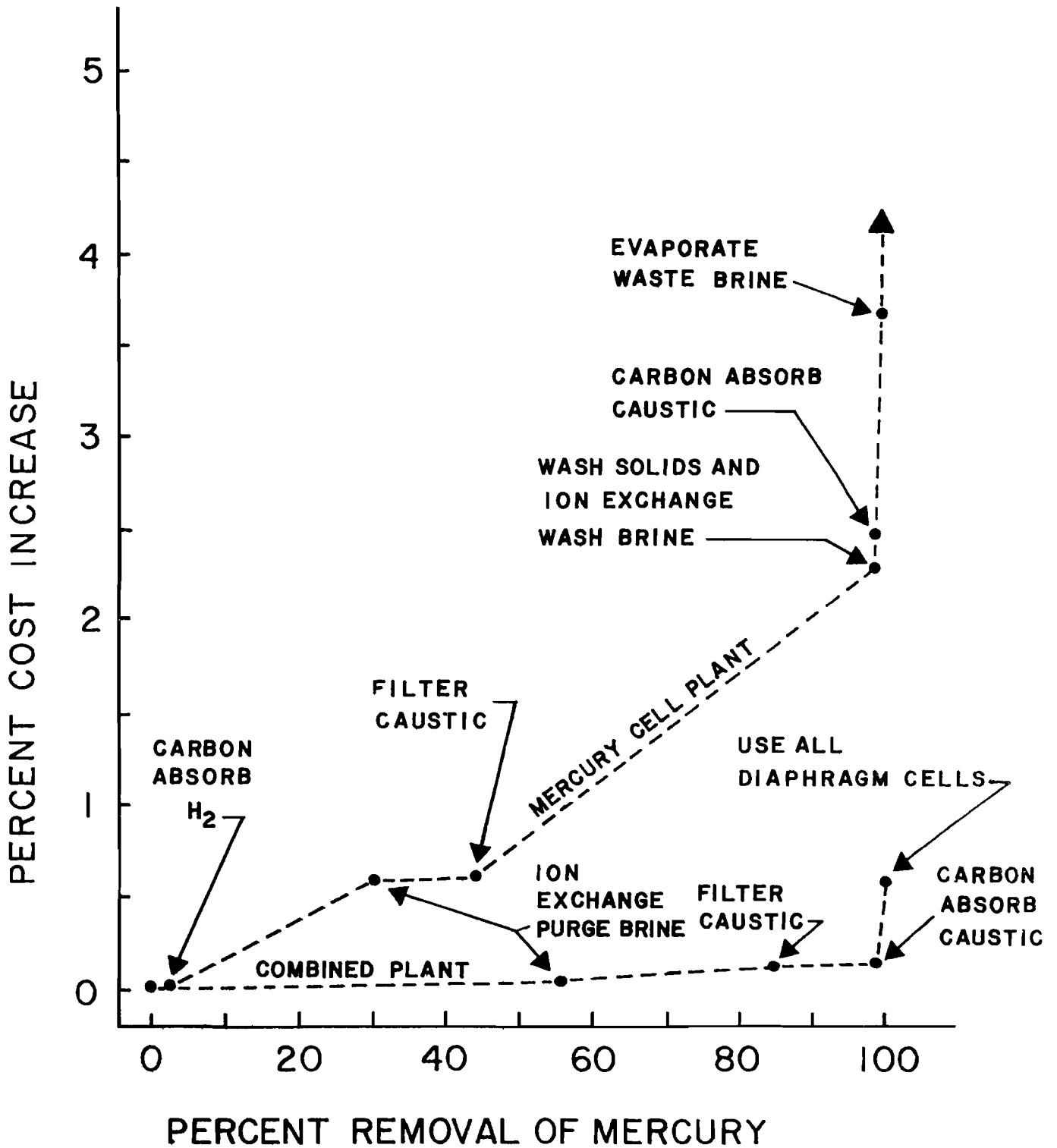

Figure 9

Comparison of percent cost increase vs. percent removal of mercury for mercury cell and combined mercury cell/diaphragm cell chlorine-caustic plant.

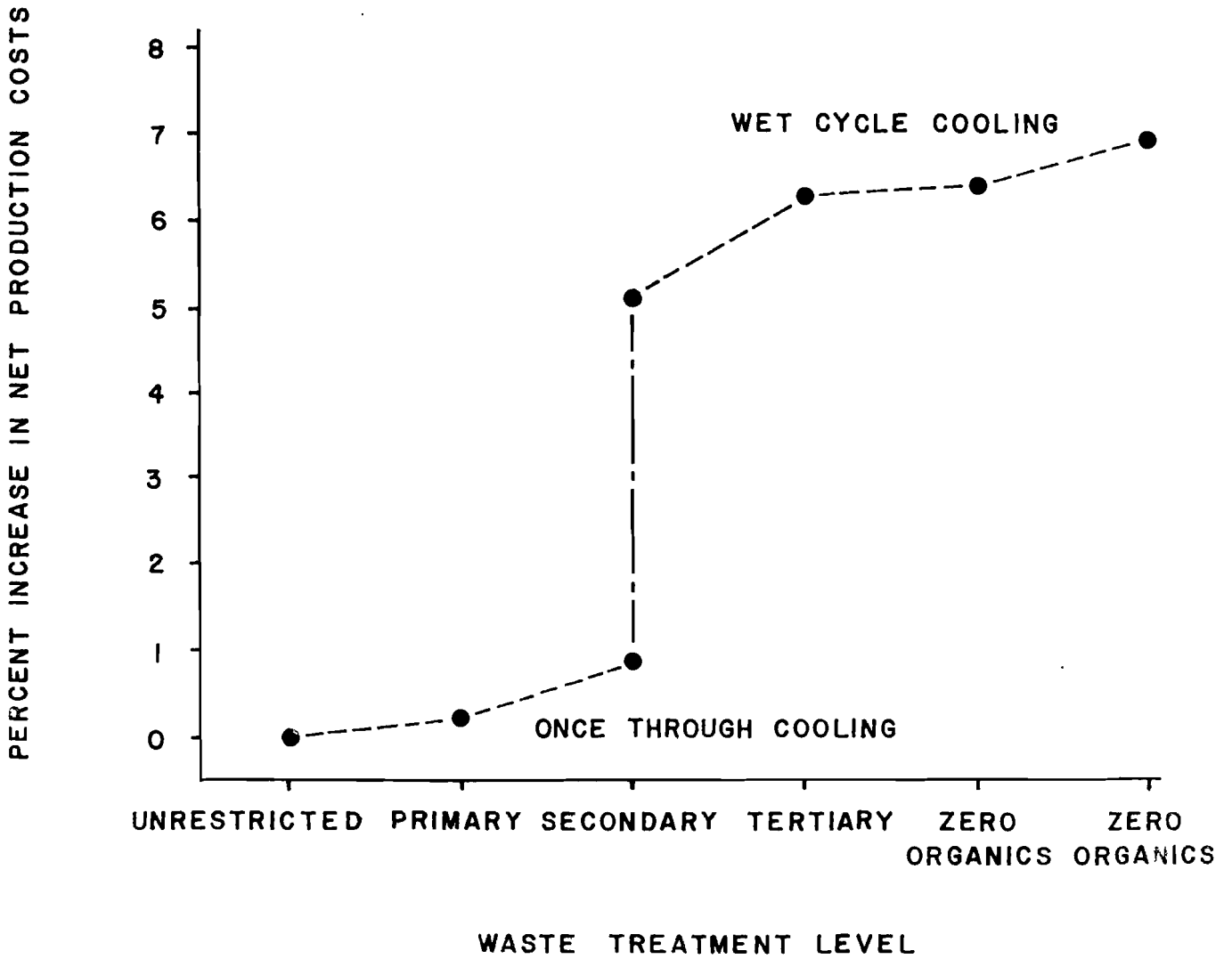

Figure 10

Effect of environmental policy on olefins production costs.

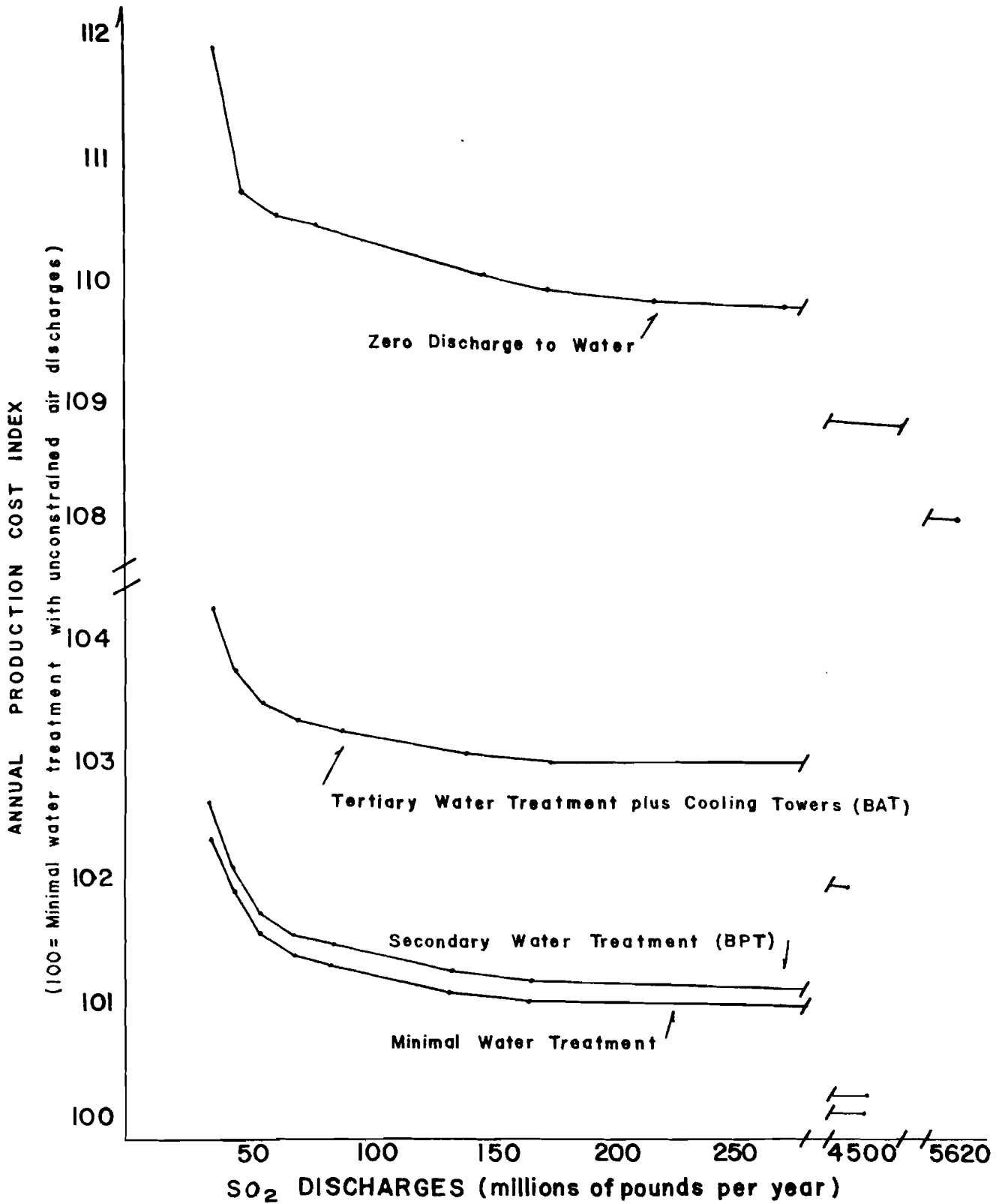

Figure 11

Sulfur/wastewater trade-offs in national production costs for petroleum refining and selected chemicals.



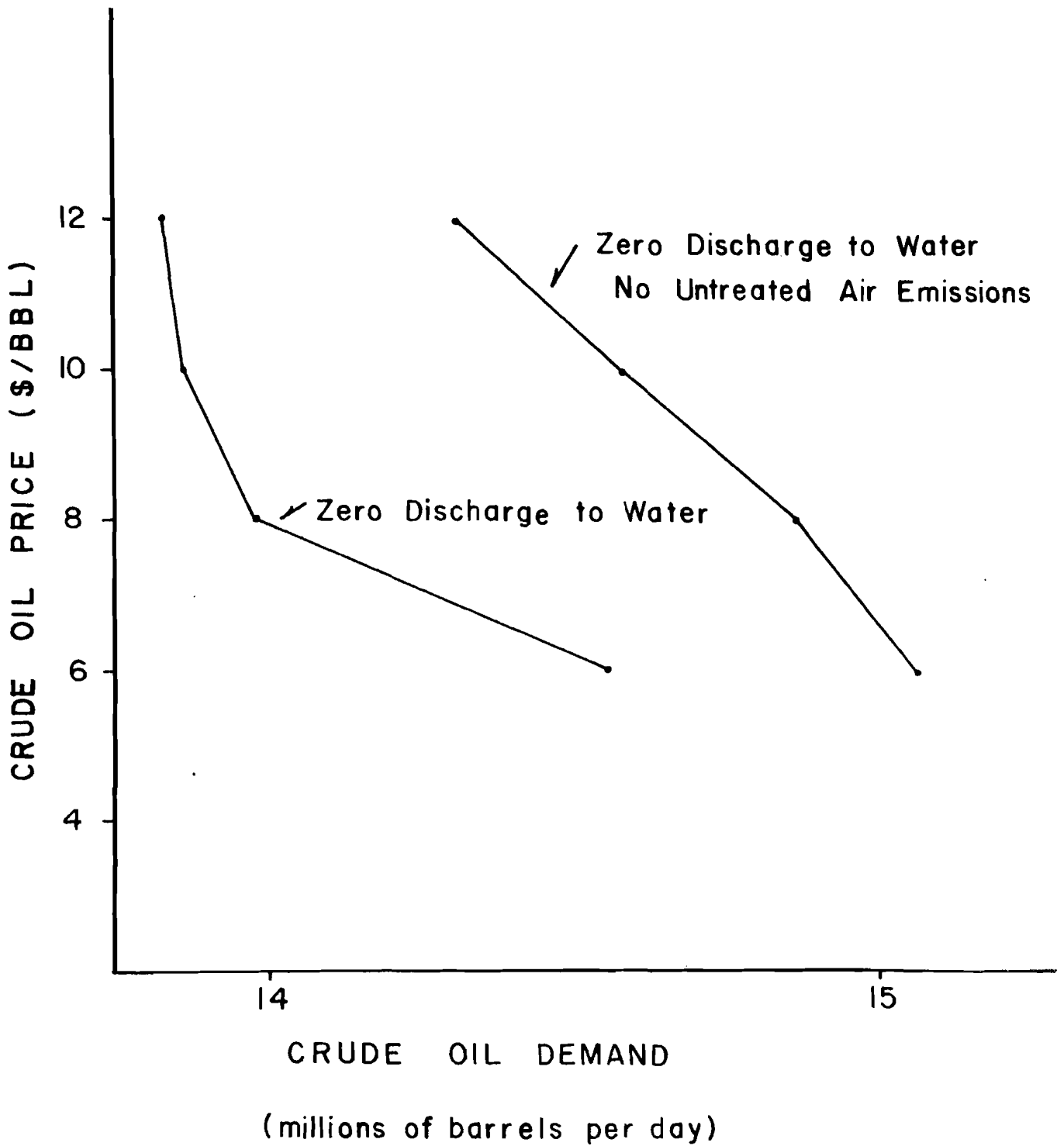

Figure 12

Crude oil prices vs. crude oil consumption for petroleum refining and selected chemicals.

REFERENCES

Heady, E.O. and K.J. Nichol, *Models of Agricultural Water, Land Use and the Environment, Economic Modeling for Water Policy Evaluation*, R.M. Thall, E. Heady, T. Schael, A.K. Schwartz and R.G. Thompson (eds.), North-Holland Pub. Co., Amsterdam, 1976.

Russell, C.S., *Models of Response to Residuals Management Action: A Case Study for Petroleum Refining*, Johns Hopkins Press, Baltimore, Md., 1973.

Thompson, R.G. and H.P. Young, *Forecasting Water Use for Policy Making: A Review*, Water Resources Research, Vol. 9, No. 4, August, 1973, pp. 792-799.

# PROCESS MODELLING USING LINEAR PROGRAMMING

by

James A. Calloway  
University of Houston  
Houston, Texas, USA

The primary objective of this exercise is to produce a mathematical model of an industrial, agricultural, or other process which has specific structural and economic properties. It is desired that the model should determine the best or optimal subset of production processes from the complete set of alternatives provided in the model. Further, the model should be capable of producing derived demand schedules for scarce resources.

Linear programming is a mathematical modelling technique which possesses the desired characteristics listed above. Specifically, the technique deals with the problem of allocating limited resources among competing activities in an optimal manner. Solution of the linear programming model (1) identifies the optimal sub-set of process alternatives (i.e., the production configuration), (2) the optimum levels of operation for each process selected, (3) the total optimal cost of achieving a desired level of production, and (4) the marginal values of limited resources.

Linear programming models are formulated in matrix form where the columns of the matrix describe the processes being modelled and are called column activities. The rows of the matrix describe resources and material transfers and are called row activities or simply rows. Once formulated, the model consists of a set of linear equations which take on the matrix form illustrated in Figure 1. The component parts are i) the

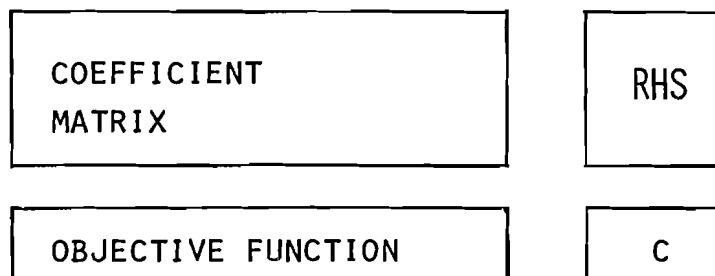

Figure 1

Matrix Configuration of a Linear Programming Model

coefficient matrix which identifies the inputs and outputs of the processes being modelled and their relative magnitudes, ii) the right hand sides (RHS) of the linear equations (constants) expressed by the rows of the matrix, iii) the objective function or cost function describing the relative variable operating costs of each of the column activities, and iv) the value of the objective function (c) which controls the direction the solution must proceed to achieve optimality.

The linear equations are solved simultaneously for values of the activity levels (operating levels of the process variables) but since there are usually more variables than equations, many solutions exist. Thus, the objective function value is checked for each solution of the equations to insure that each successive solution is better than the previous one. Mathematically, the model can be expressed as:

$$\text{Min } C = PX$$

subject to:

$$AX \geq B$$
$$X \geq 0$$

where,

- C = objective function value,
- P = vector of cost or price coefficients in the objective function,
- X = vector of column activities,
- A = coefficient matrix, and
- B = vector of right hand side constants.

#### MODEL STRUCTURE

Each column in the matrix is independent of every other column; that is, it is not necessary to know in advance which activities are to be modelled before describing a particular activity. Neither is it necessary to have full engineering knowledge of the intimate details of the process being modelled. However, the modelling effort proceeds most efficiently if the following steps are followed.

First, a flow diagram is prepared which identifies not only the basic system components necessary to accomplish the specific task but a full range of process alternatives. This diagram establishes both the configuration and level of detail to be

modelled, and explicitly indicates linkages and interrelationships which exist among system components. A finite subset of the alternatives listed constitutes the desired optimal solution.

Next, each system component is identified separately and described in terms of its resource input requirements and product outputs. At this point, the level of engineering knowledge required depends upon the predetermined level of detail desired in the model. At a minimum, the modeller must identify the inputs and outputs and their relative magnitudes.

Finally, when all inputs (negative) and outputs (positive) have been identified, the individual components are fitted into the structure of the linear programming technique. Each system component becomes a column (activity) in the linear programming matrix; each distinct input or output becomes a row (resource) in the matrix (coefficient matrix).

#### MODEL DEVELOPMENT

Suppose, for example, that you live in a country which has previously had no ammonia supply but now wishes to obtain one. You must now develop a production process which has ammonia ( $\text{NH}_3$ ) as an output. There may be other outputs as well but ammonia is of prime concern. The simplest process is one where money is the input and ammonia is the output. Diagrammatically, this can be represented as shown in Figure 2. This means of production is of course called imports. This process may or may not be the most economical means of obtaining the product thus additional alternatives need to be evaluated.

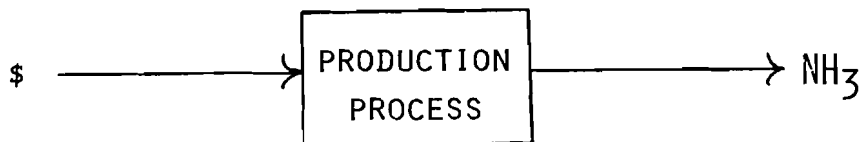

Figure 2

Ammonia Production from Imports

As the alternatives are considered, the flow diagram for the model becomes more and more complex. For example, there are several different constructors of ammonia plants, each using a slightly different type of manufacturing process, requiring different resource inputs, and having different operating costs. For each alternative to be considered, one or more additional blocks are needed in the flow diagram. This is illustrated in Figure 3. The diagram depicts differences in constructors, feedstock, input requirements, and product outputs. There may

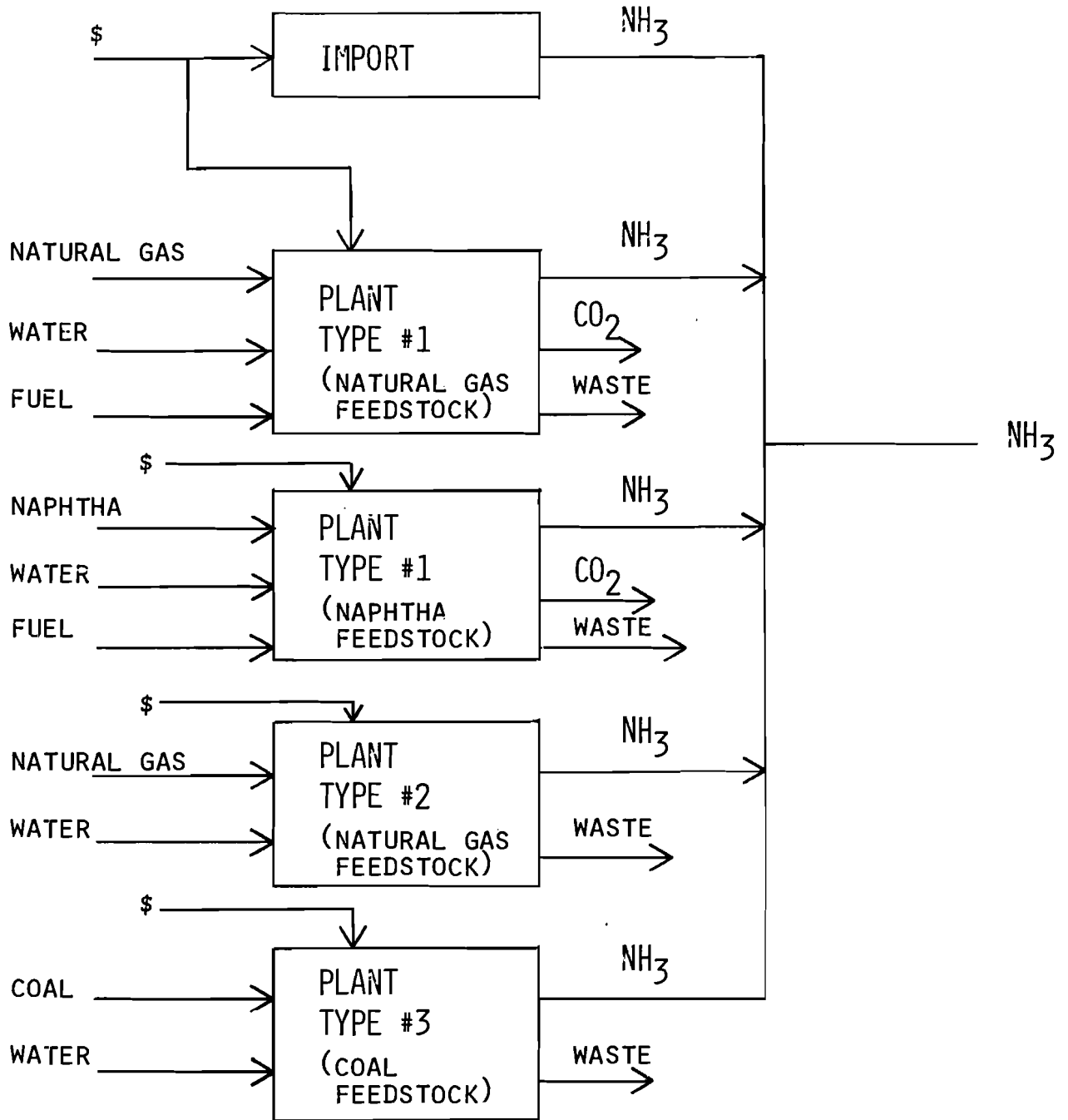

Figure 3  
Alternatives for Obtaining Ammonia

also be significant differences in the relative magnitudes of inputs and outputs which are not reflected in the flow diagram. Still further complexity is added when it is desired to extend the model to include alternative sources of raw materials or alternative means of treating waste discharges. Each of the alternatives must be identified and their interrelationships illustrated. Such a diagram is shown in Figure 4. Visualizing that the block labeled "ammonia plant" could be representative of either a single type of plant or several types of plants, the diagram illustrates the level of detail to which one might desire to model production from a single ammonia plant.

The next step in the modelling process is to determine the relative magnitudes of the inputs and outputs for each block shown in the flow diagram. At this point some engineering data must be collected from sources processing detailed knowledge of the particular processes being modelled. For example, if we wish merely to model imports we simply identify the vendors willing to supply ammonia and extract from them a price. The model of this activity then becomes:

OBJ (\$cost)	150.00
AMMONIA (ton)	1.00

The import activity may be the simplest but not necessarily the most economical means of obtaining ammonia. To model one of the more complex alternatives shown in Figure 3 requires additional engineering information. Using arbitrarily chosen data for illustrative purposes, the remaining four blocks in Figure 3 could become the columnar data shown in Table 1. Each of the values shown in the respective columns represent the relative magnitudes of inputs and outputs based on the production of one metric ton of ammonia.

Aside from expanding this relatively simple model to include the desired level of detail, the only remaining task is to provide supply activities for the resources and specify the right hand sides; that is to specify the maximum availability of resources and the minimum output level of product. The supply activities are illustrated in Table 2, assuming no restrictions on the availability of resources. Resource restrictions can be accomplished by placing upper bounds on the resource supply activities. The complete mathematical formulation is given in equations 1 through 10.

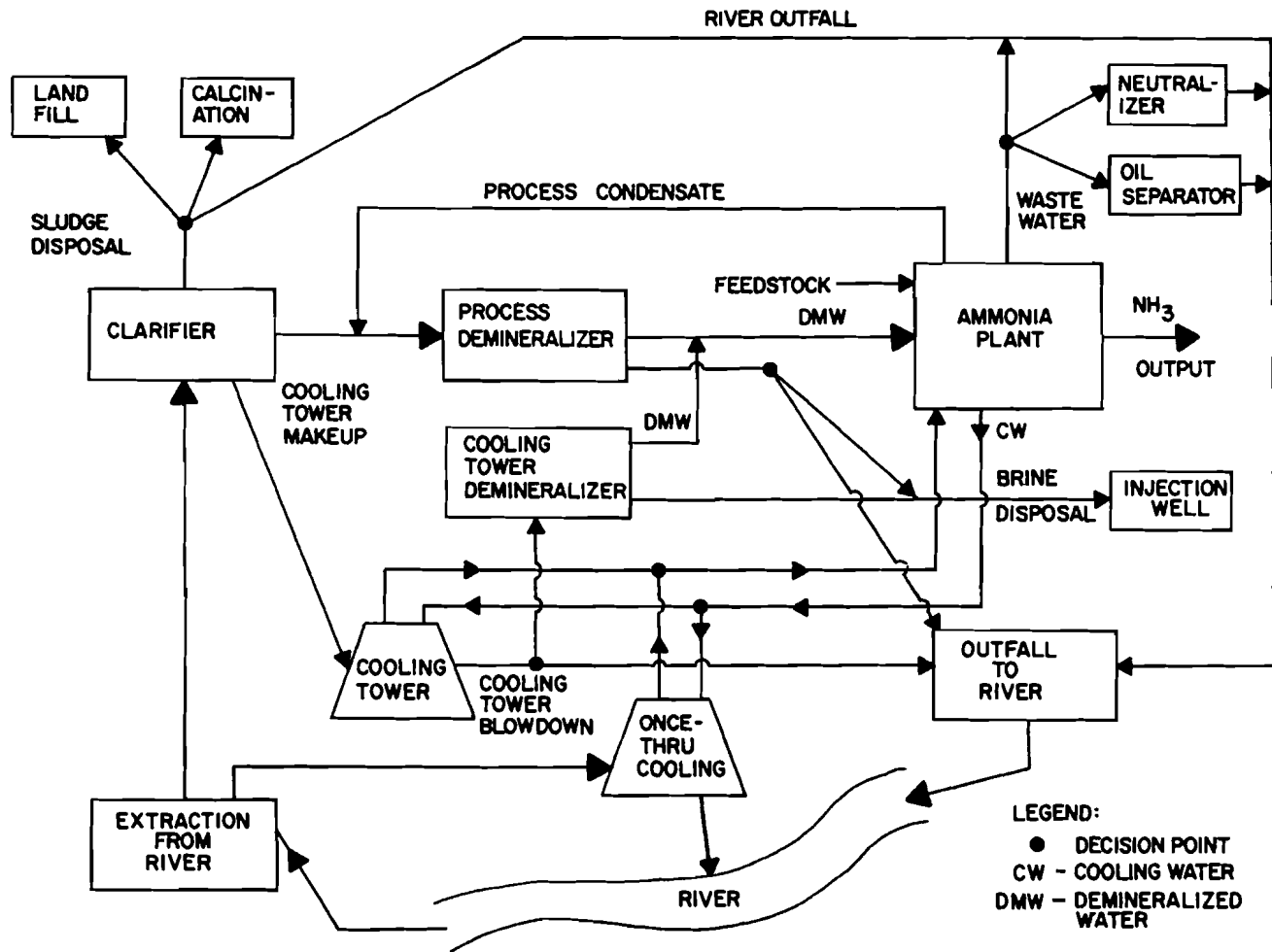

Figure 4  
Ammonia Production Process Flow Chart



Table 1.

Models of Alternative Ammonia Production Activities

<u>RESOURCES</u>	<u>Plant #1 (Gas)</u>	<u>Plant #1 (Naphtha)</u>	<u>Plant #2 (Gas)</u>	<u>Plant #3 (Coal)</u>
Cost (\$)	30.0	35.0	31.0	28.0
Natural Gas (Jx10 <sup>9</sup> )	-20.0	-	-22.0	-
Naphtha (Jx10 <sup>9</sup> )	-	-20.8	-	-
Coal (Jx10 <sup>9</sup> )	-	-	-	-28.0
Fuel (Jx10 <sup>9</sup> )	-10.6	-10.1	-9.5	-
Clean Water (cu.m.)	-3.44	-2.94	-4.0	-6.4
Ammonia (metric tons)	1.0	1.0	1.0	1.0
Carbon Dioxide (kg)	90.0	40.0	-	-
Wastewater (cu.m.)	0.09	0.09	0.11	3.2

Table 2.

Resource Supply Activities

<u>RESOURCES</u>	<u>Gas Supply</u>	<u>Naphtha Supply</u>	<u>Coal Supply</u>	<u>Fuel Supply</u>	<u>Water Supply</u>
Cost (\$)	1.422	2.085	1.688	0.566	3.00
Natural Gas (Jx10 <sup>9</sup> )	1.0				
Naphtha (Jx10 <sup>9</sup> )		1.0			
Coal (Jx10 <sup>9</sup> )			1.0		
Fuel (Jx10 <sup>9</sup> )				1.0	
Clean Water (cu.m.)					1.0

$$\begin{aligned} \text{Min } C = & 30X_1 + 35X_2 + 31X_3 + 28X_4 + 1422X_5 \\ & + 2085X_6 + 1688X_7 + 566X_8 + 3X_9 \end{aligned} \quad (1)$$

Subject to:

$$- 20X_1 - 22X_3 + X_5 = 0 \quad (2)$$

$$- 20.8X_2 + X_6 = 0 \quad (3)$$

$$- 28X_4 + X_7 = 0 \quad (4)$$

$$- 10.6X_1 - 10.1X_2 - 9.5X_3 + X_8 = 0 \quad (5)$$

$$- 3.44X_1 - 2.94X_2 - 4X_3 - 6.4X_4 + X_9 = 0 \quad (6)$$

$$X_1 + X_2 + X_3 + X_4 \geq 1 \quad (7)$$

$$90X_1 + 40X_2 \longrightarrow \text{FREE} \quad (8)$$

$$0.09X_1 + 0.09X_2 + 0.11X_3 + 3.2X_4 \leq \text{LARGE} \quad (9)$$

$$X_1 \geq 0 \quad (10)$$

Since carbon dioxide is a byproduct of ammonia production and has no economic value as the model is currently formulated, equation 8 is listed as a free row which merely accounts for the amount of CO<sub>2</sub> that is produced. Equation 9 accounts for waste production. The right hand side value is made arbitrarily large to indicate no restriction on the production of wastes. Solution of the model can now proceed with the object being to minimize the value of the objective function, equation 1. Figure 5 illustrates creation of the data matrix described in Figure 1 for the relatively complex system shown in Figure 4. Along the top and left side of the figure, column names and row names are provided to identify the column and row activities. The objective function is given by the first row (TCOST) and the remaining rows describe the coefficient matrix. The right hand side is given by column \*B1. Individual coefficients are indicated by letters; the relative magnitude of each letter is indicated at the bottom of the table.





# SYSTEMS ANALYSIS APPLIED TO AGRICULTURAL WATER DEMAND

by

David R. Maidment

Guest Scholar  
International Institute for  
Applied Systems Analysis  
Laxenburg, Austria

## Abstract

A framework for a systematic approach to the analysis of agricultural water demand is presented in which the factors involved are considered on three levels: the farm level, the regional level, and the national level. The agricultural production system at each level is regarded as having three components: the inputs, the production process, and the outputs. The mathematical modelling of agricultural water demand is discussed from the viewpoint of the substitution possibilities in the production system at each level.

## Introduction

The objective of this paper is to provide a systematic framework for the analysis of the factors affecting agricultural water demand. This framework is intended to act as a basis for further discussion on the mathematical modelling of agricultural water demand from the viewpoint of a "scenario" or "alternative futures" approach. The aim of such an approach to the forecasting of future agricultural water demands is to avoid some of the dangers of forecasting these demands merely by the method of projecting their historically observed trends. Instead, within a set of assumptions about external factors such as population and economic growth, and government policy, a mathematical model of the agricultural production system is formulated to simulate the response of this system to different future policies. In this way, a number of "scenarios" or "alternative futures" are generated, each of which expresses the consequences of alternative policy assumptions. Thus, the output of such a modelling effort is not a single number for the amount demanded at some future time, but rather a range of numbers which might prevail given different circumstances.

*At the national level*, a good example of the mathematical modelling of agricultural water demand is provided by the comprehensive study of the water use in agriculture in the United States which was carried out by E.O. Heady and his associates at Iowa State University for the U.S. National Water Commission (Heady et al., 1972; U.S. National Water Commission, 1973; Nicol and Heady, 1975). In this study, a linear programming model is formulated to account for all water use in agriculture, agricultural production, and the consumption of agricultural output in the United States. The objective of the study is to forecast agricultural water demand in the United States in the year 2000 under various assumptions about population level, farm policy, water price, level of exports, and rate of technological advance. The basic variable investigated is the substitution for water use in irrigation in the Western States by dry-land farming in the other States.

The impact on national economic development and environmental quality of government investments in irrigation developments must be investigated at the national level so that the actual costs and benefits to the nation of such developments are distinguished from the costs and benefits resulting from the transfer of activities from one region to another (Howe, 1976). The effect of irrigation in stabilizing agricultural production and the resulting commodity markets is also important at the national level, particularly in the case of developing countries which have few storage facilities to retain surplus production for times of need.

*At the regional level*, the decision-makers are commonly charged with granting the rights for water withdrawals and wastewater discharges so that the supply and the demand for water are balanced. Various factors affecting agricultural water demand at this level are listed in Figure 2. A number of mathematical models of agricultural water demand have been formulated at the regional level. To estimate farmers' response to falling levels in their groundwater supply for irrigation in an area of Arizona, Burdak (1970) coupled a linear programming model for the farm management in the region to an analog computer model of the groundwater basin, solving the linear programming model in 10 year time steps to produce pumping schedules then using the analog model to forecast the resulting decline in water levels. The increases in pumping costs due to the groundwater decline are fed back into the linear programming as new cost coefficients for the next time step. Dean et al. (1973) used a multiperiod linear programming model to investigate the economic and financial feasibility of irrigation development in the San Joaquin Valley, California. Again using linear programming, Onishi and Swanson (1974) evaluated the effect on crop production of limiting the use of nitrogen fertilizers and constraining the amount of sediment produced in the watershed of a planned recreational reservoir.

*At the farm level*, the decisions are made concerning the technological aspects of agricultural production: cropping pattern, tillage practice, fertilizer and water applications, Figure 2. These aspects are examined in studies listed by Meredith (1973).

## The Modelling of Agricultural Water Demands

For the purposes of modelling agricultural water demands, it is useful to consider the agricultural production system as being made up of three components: the inputs, the production processes and the outputs, Figure 3. Since water is one of the inputs, the demand for water must be derived from the demand for the outputs through the linkage of the production processes. Thus, to determine how much water is needed on a given farm in a given year, the cropping pattern and the schedule of irrigation for each crop must be decided, then the total water demanded on the farm and its delivery schedule may be found as the sum of the demands of the various crops.

Commonly in agriculture, the supply of water is spatially integrated with the demand at the farm level in that the water is pumped by the farmer from nearby groundwater or surface water sources. In this case, an approach to modelling the water supply and demands such as that of Burdak (1970) is appropriate, in which the supply and the demand are balanced on a farm-by-farm basis. Alternatively, it may be desired to develop a regional demand schedule for water from some source external to the farms, such as from a reservoir or major diversion from a river. This demand schedule is a relationship showing the marginal return from each unit of water withdrawn as a function of the number of units, or quantity withdrawn.

To develop such a regional agricultural water demand schedule, assume that the quantities of outputs of the regional agricultural production system have been specified. By using a linear programming model of the production system at the farm level, the solution for the least-cost combination of inputs and production processes can be found for each feasible level of the amount of input water. At each such level of input water, the marginal return from having an additional unit of water may then be computed as the difference between the least-cost solution at that level of input and the solution when one more unit of water is available (the assumption is implied that having more water reduces the overall costs of production). The regional water demand schedule can then be developed by aggregation of the farm-level demand schedules.

The key concept here is that as water becomes increasingly scarce, other inputs are substituted for it, or other production processes are used. A number of such input substitution possibilities exist in agriculture:

- (1) Substitution of labor for water through more frequent and better controlled application of irrigation water.
- (2) Substitution of capital for water by lining canals and using sprinklers or trickle irrigation instead of flood irrigation.
- (3) Substitution of fertilizer for water using the complementary relation which exists between them, an example of which is shown in Figure 4.

- (4) Substitution of land for water by reducing the area irrigated and growing the substitute crops without irrigation (this requires more land since yields are lower with dry-land farming).

Changes in the production process in response to decreasing water availability include the following:

- (1) Alteration of the crop-mix and crop rotation towards less water-intensive crops.
- (2) Reduction in tillage to conserve water in the topsoil.

The consideration of the quality of the wastewater is also important particularly with regard to the following: the build-up of salts in the soil, perhaps because of inadequate drainage; erosion, and sediment carried with surface runoff; and the leaching of fertilizers into natural water bodies, particularly nitrogen and phosphorous compounds.

For those familiar with industrial water demand modelling as described by Thompson, and Young (1973); and Calloway, Schwartz, and Thompson (1974); the previous discussion illustrates the similarities between this modelling and that for agricultural water demands. However, there are some important differences between these two types of water demands which should be noted:

- (1) Spatial location is critical in agriculture since soil fertility exhibits wide variations even within local areas. Industrial production processes are less affected by spatial location.

- (2) Random factors such as weather are much more important in agriculture than in industry. In general, agricultural production is less under human control than is industrial production.

- (3) Consumptive use is high in agriculture; there are few recycling possibilities compared with those in industry.

- (4) Agricultural water demand is dispersed over large areas at relatively low rates of use per unit area while industrial water demand is concentrated at point locations with high rates of water use per unit area.

- (5) The timing of water application is important in agriculture. By contrast, industry usually requires relatively constant flow rates of water over long periods of time.



## Summary and Conclusions

The objective of this paper is to provide a systematic framework for the analysis of the factors affecting agricultural water demand. The types of agricultural water demand are described and the factors affecting the demand are separated into three sets corresponding to national, regional, and farm levels. Mathematical modelling studies already carried out at these levels are discussed. The modelling of agricultural water demand is considered from the viewpoint of an agricultural production system comprising three components: inputs, production processes, and outputs. A procedure similar to that for industrial water demands is developed for deriving regional agricultural water demand schedules. This procedure relies on the concept of the substitution of other inputs and production processes as water becomes increasingly scarce. Several important differences between agricultural and industrial water demands are noted.

It is concluded that on a global basis at the present time, agricultural water demand, primarily for irrigation, is the dominant component of total water withdrawals and consumptive use. It seems most appropriate to consider the balance between the supply and the demand for agricultural water at the regional level, the demands being modelled at the farm level using linear programming then aggregated to find the regional level demand schedules. Although, in principle, the methodology used in developing industrial water demand schedules is also applicable to agricultural water demand, due account must be taken of the differences between agricultural and industrial production processes, particularly with regard to the spatial aspects of agricultural production.

## Acknowledgments

The research leading to this paper was supported in part by funds provided by a Rockefeller Foundation Fellowship in Environmental Affairs, Grant RF 75033, Allocation No. 32. The author is grateful for discussions with J. Kindler, H. Carter, and S. Schmidt, all of IIASA.

TYPES OF AGRICULTURAL WATER DEMAND

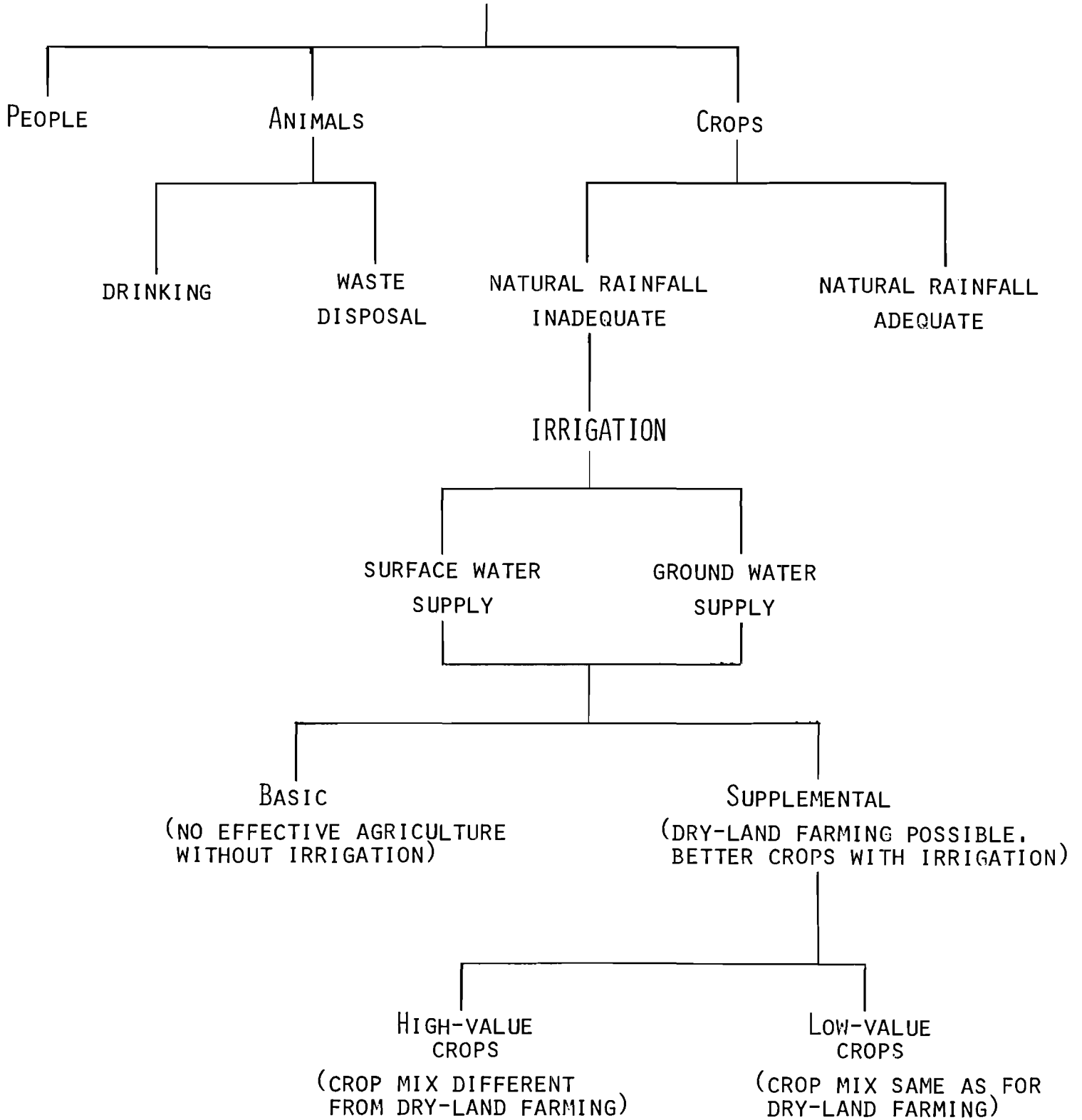

Figure 1

Types of Agricultural Water Demand

LEVEL	FIXED FACTORS	VARIABLE FACTORS
NATIONAL	NATIONAL LAND AND WATER RESOURCES; PRESENT CAPITAL STOCK AND LABOR SUPPLY IN AGRICULTURE; POLICIES OF OTHER COUNTRIES.	POPULATION GROWTH AND ITS DISTRIBUTION; GROWTH OF NATIONAL INCOME; OUTPUT OF AGRICULTURAL PRODUCTION FOR DOMESTIC USE AND EXPORT; INVESTMENT IN WATER RESOURCES DEVELOPMENTS; ENVIRONMENTAL PROTECTION POLICY; REGIONAL ECONOMIC DEVELOPMENT.
REGIONAL	NATIONAL POLICY; REGIONAL LAND AND WATER RESOURCES.	BALANCE OF SUPPLY AND DEMAND FOR WATER WITHIN REGION; IMPACT OF AGRICULTURAL WASTE WATER ("NON-POINT SOURCES") ON WATER QUALITY; REGULATION OF WATER SUPPLIES (GROUND WATER, SURFACE WATER); PROVISION OF OFF-FARM WATER SUPPLIES (RESERVOIRS, CANALS, PIPELINES, ETC.); DRAINAGE OF IRRIGATED LANDS.
FARM	NATIONAL AND REGIONAL POLICIES; OFF-FARM WATER SUPPLIES; DEMAND FOR AGRICULTURAL OUTPUTS.	CROP MIX ON FARM; PROVISION OF ON-FARM WATER SUPPLY; TYPE OF IRRIGATION SYSTEM USED (SPRINKLERS, FLOODING, ETC); FARM MANAGEMENT PROGRAM (FERTILISER, TILLAGE, LABOR); SCHEDULE OF IRRIGATION APPLICATIONS; FARM DRAINAGE.

-53-

Figure 2  
Factors Affecting Agricultural Water Demand

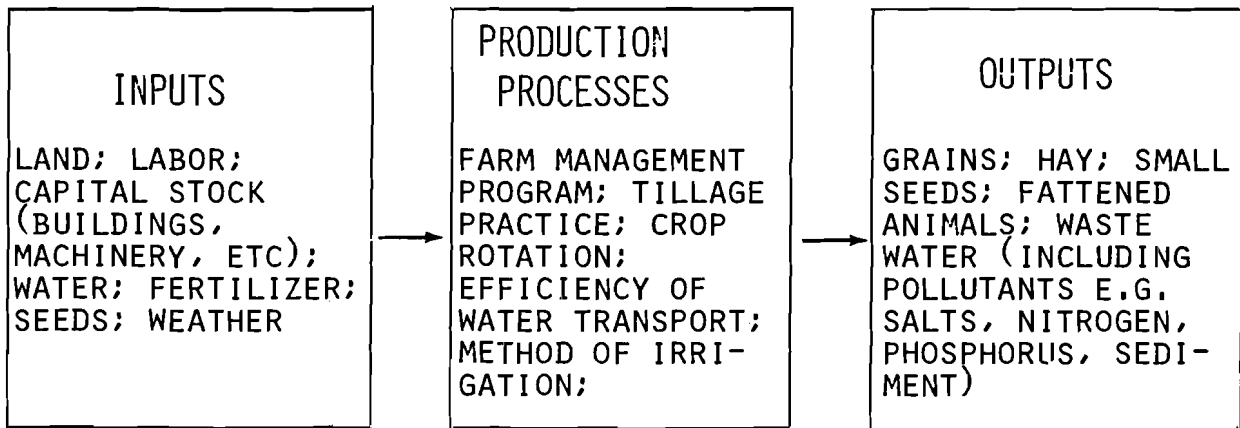
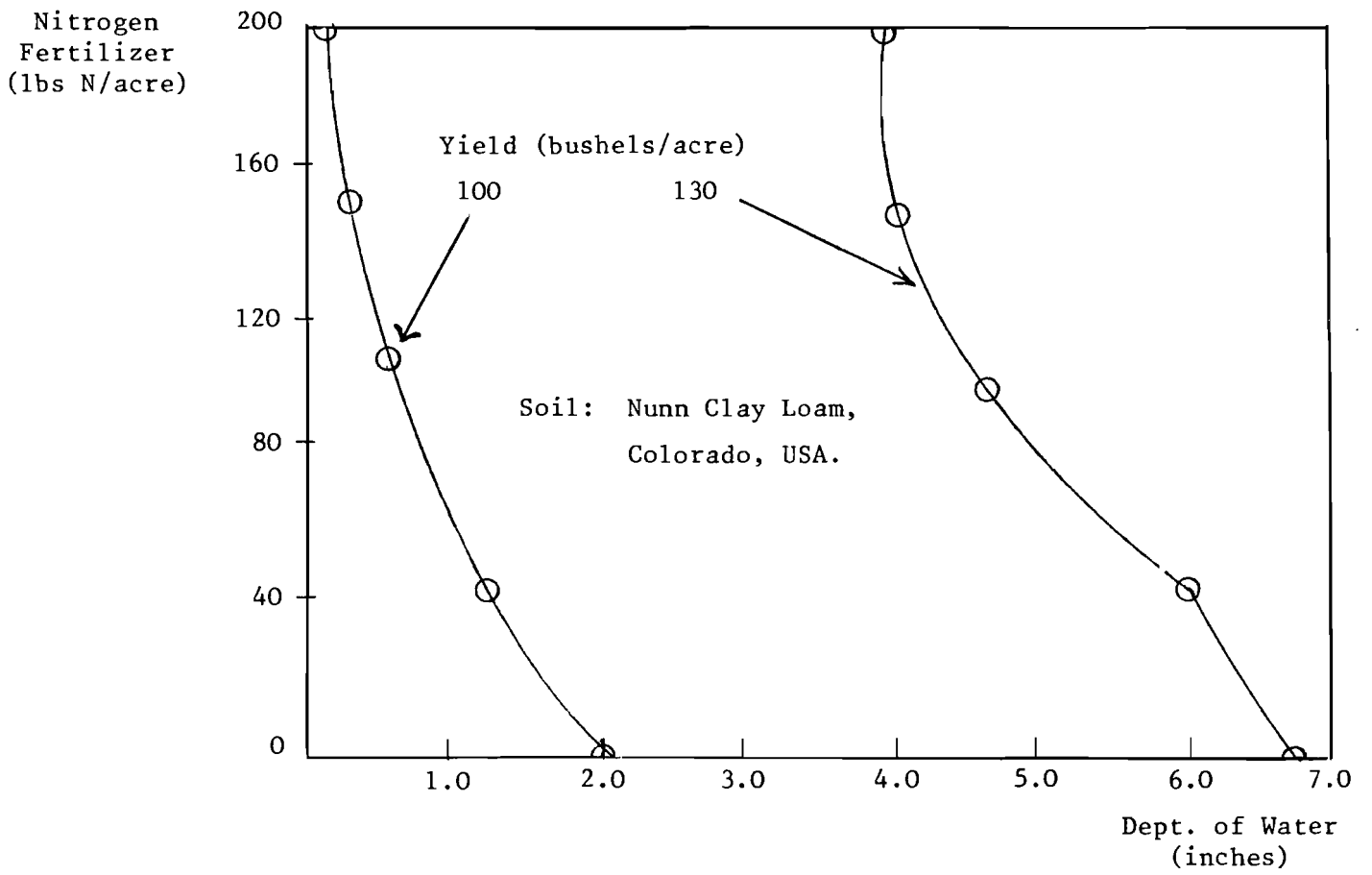

Figure 3

The Agricultural Production System

Figure 4

Nitrogen Fertilizer vs Water for Corn Production



Source: Heady et al. (1972), Table 1.4

REFERENCES

- Burdak, T.G. (1970), *Projections of Farmer Response to a Falling Groundwater Table: A Marriage of Economic and Hydrologic Models*, M.S. Thesis, Dept. of Agric. Econ., University of Arizona, Tucson, 140.
- Calloway, J.A., et al. (1974), *An Integrated Power Process Model of Water Use and Wastewater Treatment in Ammonia Production*, NTIS PB# 237;221, Springfield, Virginia, 85.
- Dean, G.W., et al. (1973), *Programming Model for Evaluating Economic and Financial Feasibility of Irrigation Projects with Extended Development Periods*, *Water Resources Research*, 9, 3, 546-555.
- Heady, E.O., et al. (1972), *Agricultural and Water Policies and the Environment: An Analysis of National Alternatives in Natural Resource Use, Food Supply Capacity and Environmental Quality*, CARD Report 40T, Iowa State University, Ames, Iowa 50011, June.
- Howe, C.W. (1976), *The Effects of Water Resource Development on Regional Growth: Factors Affecting the Relation and Insights from Case Studies*, internal paper, International Institute for Applied Systems Analysis, Laxenburg, Austria.
- Kaczmarek, Z. (1975), "Systems Analysis in Water Resources", Table 1, in *The IIASA Water Resources Project: A Status Report*, RR-76-15, International Institute for Applied Systems Analysis, Laxenburg, Austria.
- Meredith, D.D. (1973), *Bibliography on Optimization of Irrigation Systems*, Research Report No. 71 (UILU-WRC-0071), Water Resources Center, University of Illinois, Urbana, Ill. 61801.
- Nicol, K.J. and E.O. Heady (1975), *A Model for Regional Agricultural Analysis of Land and Water Use, Agricultural Structure and the Environment: A Documentation*, Center for Agricultural and Rural Development, Iowa State University, Ames, Iowa 50011, July.
- Thompson, R.G. and H.P. Young (1973), *Forecasting Water Use for Policy Making: A Review*, *Water Resources Research*, 9, 4, 792-799, August.
- United Nations (1976), *The Demand for Water: Procedures and Methodologies for Projecting Water Demands in the Context of Regional and National Planning*, U.N. Dept. of Economic and Social Affairs, Natural Resources, *Water Series*, 3.
- U.S. National Water Commission (1973), *Water Policies for the Future*, Final Report to the President and to the Congress of the United States, U.S. Government Printing Office, Washington, D.C. 20402, 11-17, June.

# REGIONAL WATER SUPPLY FUNCTIONS<sup>1</sup>

by

Ilya Gouevsky

International Institute for  
Applied Systems Analysis  
Laxenburg, Austria

## I. Introduction

The objective of this study is to elaborate a method to evaluate water supply alternatives in a region, and combine them in some appropriate fashion to meet projected *water demands*. We think this may be useful for several reasons. First, people who have to make decisions about water supply ought to know whether it is in fact feasible to meet projected future demands. Second, they ought to know the cost of doing so. What are the sacrifices required to obtain specified additional quantities of water? Third, we assume they wish to obtain these quantities in an efficient, i.e. cost-minimizing, fashion. This is what we mean by combining supply alternatives in an "appropriate" fashion.

A typical approach in past studies of water supply (see Wollman and Bonem [1971]) has been to measure relevant physical system characteristics of a region, such as precipitation and runoff, plot these annually, and then draw some inferences about how much water will be available in the region over a given future period. Because of uncertainties in precipitation and stream flow, statements about availability must ordinarily be made in probabilistic terms, e.g., "minimum flow available 98 percent of the time" (Löff and Hardison [1966]). But in any event, an important feature of this approach is that it attempts to come up with a point estimate of water supply. That is, it attempts to say exactly how much water will be available (with probability  $p$ ) at a given time and place.

A very useful extension of the physical system analysis has been the specification and estimation of what the economist calls water supply functions. The supply function for water gives the amounts of water that could be made available (within a given time frame) at various cost increments, or that would presumably be made available at the corresponding prices under a regime of decentralized, profit-maximizing suppliers<sup>2</sup>. Wollman and Bonem

---

<sup>1</sup>The author is indebted to A. Fisher for many valuable comments and suggestions made in the course of this study.

<sup>2</sup>More details about supply functions can be found in A. Fisher's paper "Demand, Supply, and Economic Efficiency" in this Proceedings.

present some good examples of the incremental cost-output relationship for surface stream flow and storage in a number of water resource regions in the U.S. Costs (and benefits) of another supply alternative, interbasin transfers of water, are studied by Howe and Easter (1971) for the U.S. and by Cummings (1974) for Mexico. What we intend to do is to take this sort of supply analysis a step further by looking at a range of alternatives for a (hypothetical) region, and developing a method that combines them in cost-minimizing fashion to generate a regional water supply curve.

## II. Water Supply Alternatives

We first consider the problem of developing a general scheme for water supply in a particular region. By a general scheme we mean one that abstracts from considerations of the location of sources, the topographical determination of stream flow, etc. Such a general scheme is represented in Figure 1.

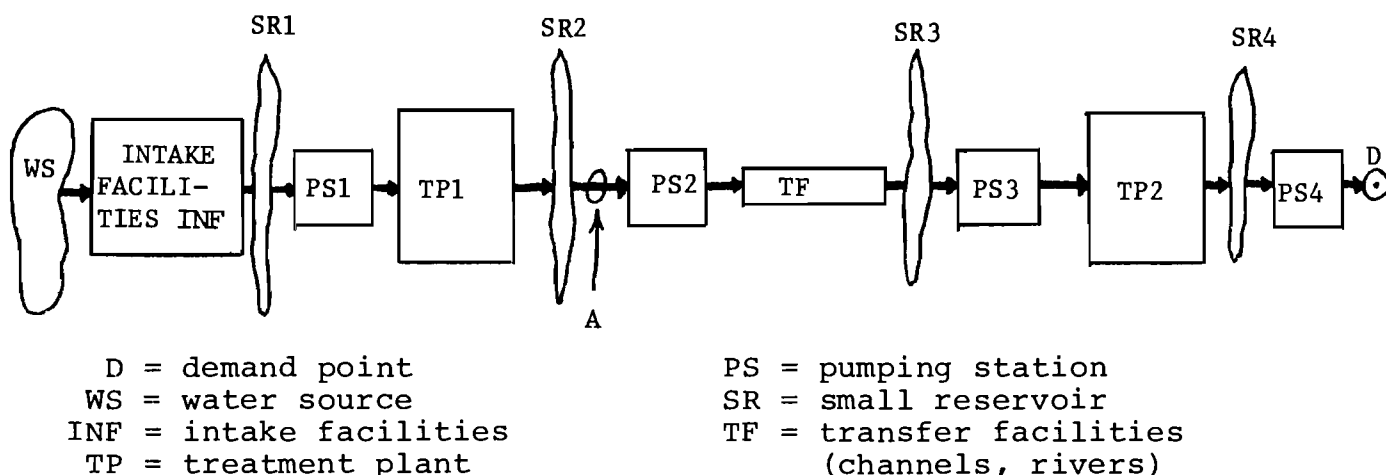

Figure 1

In this scheme a given point, D, in region R, is to be supplied with water from some water source WS. The latter requires intake facilities INF, and eventually a small (auxiliary) reservoir SR1. Before being transferred to D, the water has to be purified by the treatment plant TP1. Treatment might be desirable if, for example, at point A other users are supplied or if transfer facilities TF are used also for other purposes, such as recreation, that would require water of a standard quality. Of course, the specific location of these various facilities, and their size, will depend on the region's available water sources, its topography, and the quality and quantity of water being transferred to point D.

To derive a supply function for D we have to identify all of the feasible water sources or supply alternatives, which could be represented as in Figure 1. In contemporary water supply the following alternatives are employed:



### 1. River Water

This is probably the least cost alternative and is ordinarily the first one which is employed in a given river basin. However, there are two difficulties which prevent wider utilization of this water source: pollution (there is typically a need for intensive treatment of the water), and low dependability of flow.

### 2. Reservoir Water

This alternative is an improvement over the first in both respects. Pollution may be less due to the sedimentation of solids in the reservoirs, and the dependability of supplies increases substantially due to the possibilities for regulating the stream flow.

### 3. Groundwater

"All water that exists below the surface of the earth in the interstices of soil and rock may be called subsurface water; that part of subsurface water in interstices completely saturated with water is called groundwater" (Water Policies for the Future, [1973]). As an alternative source of water it is readily accessible in many regions, often where surface supplies are becoming difficult and costly to expand. Groundwater also has two very important characteristics: it does not require construction of dams, and it is often of good quality. However, it should be noted that overuse can lead to a deterioration in the quality of the groundwater and can also lower the water table.

### 4. Inter-Basin Transfer

This alternative provides for a substantial augmenting of supply by transferring water from one watershed to another. The region receiving water gains while the region that donates water loses. This means that in studying this alternative one should take into account problems which pertain to both regions, unless the donating region has an excess supply at a zero price for the foreseeable future.

### 5. Desalting of Sea Water

This alternative has always been a challenge to scientists and practitioners but until recently, it was not technically feasible to convert meaningful amounts of either sea water or brackish water into fresh water. Today, the technology for large-scale desalting is at hand. In fact, as of 1971, there were some 745 plants in operation in various parts of the world, producing over 300 million gallons/day ( $\approx 1.136$  million  $m^3$ /day) of water (Water Policies for the Future, [1973]). There are problems, however. Costs are still relatively high and the environmental impact can be substantial. Further cost reduction will probably come from reduction in the cost of energy used in the process, or more likely from more efficient use of the energy. One possibility here would be to combine power generation with desalination. The

environmental problem is that the volume of brine effluent from a sea water conversion plant is about 50 percent of the total volume treated. As indicated in (Water Policies for the Future, [1973]), "the effluent from a 10 m.g.d. (37854 m<sup>3</sup>/day) plant will contain 2000 tons of salt residue daily".

These are the alternatives considered in our illustrative example of a regional water supply function in section IV below. There are however a number of others such as reclamation of waste water effluent, land management, modification of precipitation, etc. which are more sophisticated and therefore require considerable investments.

### III. A Derived Supply Function: Structure and Description of the Model

The key idea in deriving a supply function for point D in region R is that different supply alternatives, and the resource inputs required for each, can be substituted for each other until the least cost combination for producing any desired amount of water is found. In this section we indicate formally how this process ought to work.

It is assumed that the regional water supply agency wishes to minimize the cost of making available a given quantity of water,  $Y_D$ , to meet projected demand at the prevailing price. Water can be supplied from any of  $n$  sources,  $X_1, X_2, \dots, X_n$ , where  $\sum_{i=1}^n X_i = Y_D$ . To get water from either source requires two kinds of production inputs,  $L_1$  and  $K_1$  for  $X_1$ ,  $L_2$  and  $K_2$  for  $X_2, \dots, L_n$  and  $K_n$  for  $X_n$ .

The inputs of  $L_i$  and  $K_i$  can be combined to yield a given quantity of  $X_i$  according to the production function  $f_i(L_i, K_i) = X_i$ . In the production function we can also readily incorporate environmental quality considerations. For example, the waste assimilative capacity of a water course might be represented as a scarce input, like  $L$  or  $K$ .

The agency's planning problem can be stated formally as,

minimize

$$C = \sum_{i=1}^n (P_L L_i + P_K K_i) \quad (1)$$

subject to the constraint

$$\sum_{i=1}^n f_i(L_i, K_i) \geq Y_D \quad (2)$$

and the non-negativity restrictions

$$L_i \geq 0; \quad K_i \geq 0; \quad i = 1, \dots, n$$

where  $P_L$  is the price of inputs of type L, and  $P_K$  is the price of inputs of type K.

The Lagrange function is

$$Z = C + \lambda [Y_D - \sum_{i=1}^n f_i(L_i, K_i)] \quad . \quad (3)$$

Assuming the production functions  $f_i(L_i, K_i)$ ,  $i = 1, \dots, n$  are concave in both arguments, the Kuhn-Tucker (K-T) conditions for this nonlinear program are necessary and sufficient for a minimum. Furthermore, assuming positive values for all the solution variables, the K-T conditions can be written

$$\frac{\partial Z}{\partial L_i} = P_L - \lambda \frac{\partial f_i}{\partial L_i} = 0 \quad i = 1, \dots, n \quad (4)$$

$$\frac{\partial Z}{\partial K_i} = P_K - \frac{\partial f_i}{\partial K_i} = 0 \quad . \quad .$$

### Input Demand and Marginal Cost

From the conditions (4) the standard formulae for input demand can be deduced, for example  $P_{L_i} = \lambda \frac{\partial f_i}{\partial L_i}$ , or  $P_{K_i} = \lambda \frac{\partial f_i}{\partial K_i}$ ,  $i = 1, \dots, n$ . These indicate simply that an input  $i$  will be purchased up to the point where its price  $P_L$  for  $L_i$ , equals the value of its marginal product,  $\lambda \frac{\partial f_i}{\partial L_i}$ . This expression is in turn the product of the shadow price of water,  $\lambda$ , and the marginal product of L,  $\frac{\partial f_i}{\partial L_i}$ .

Note also, in an optimal or cost minimizing program, the value of an input's marginal product must be the same in all alternatives because it is used in all of them to the point where its value is equal to the common input price. That is, we have for L,

$$P_L = \lambda \frac{\partial f_i}{\partial L_i} \quad , \quad i = 1, \dots, n \quad (5)$$

Further, since the shadow price of water,  $\lambda$ , is obviously the same, we have

$$\frac{\partial f_1}{\partial L_1} = \frac{\partial f_2}{\partial L_2} = \dots = \frac{\partial f_n}{\partial L_n} \quad (6)$$

This means that the marginal product is the same in all alternatives. This result will be useful in deriving the marginal cost, or supply function.

The marginal cost of supplying water from alternative  $i$  is

$$\frac{P_L}{\frac{\partial f_i}{\partial L_i}} \text{ or } \frac{P_K}{\frac{\partial f_i}{\partial K_i}}, \quad i = 1, \dots, n, \text{ (each of them = } \lambda \text{)} . \quad (7)$$

The marginal costs of each of the alternatives must be the same, for if they are not, the cost of supplying a given quantity of water can be reduced by shifting inputs from the higher cost alternative to the lower. The marginal cost of water supply is then just the marginal cost of any of the alternatives - at the total cost-minimizing solution, of course. To show that the alternative marginal costs are the same, we observe from (7) that  $P_L = P_L$  (working with  $L$ ) and

$$\frac{\partial f_1}{\partial L_1} = \frac{\partial f_2}{\partial L_2} = \dots = \frac{\partial f_n}{\partial L_n} , \quad (8)$$

so that

$$\frac{P_L}{\frac{\partial f_1}{\partial L_1}} = \frac{P_L}{\frac{\partial f_2}{\partial L_2}} = \dots = \frac{P_L}{\frac{\partial f_n}{\partial L_n}} . \quad (9)$$

The expression (9) is the marginal cost associated with a given quantity of water, say  $Y_D$ .

What has all of this to do with the derivation of a marginal cost or supply function, which is the point of this section? As explained in the Introduction, the marginal cost associated with any given level of output,  $Y_D$ , is calculated by treating  $Y_D$  as a parameter, i.e. by varying it and calculating the marginal cost

at the new levels of the solution variables. Of course, this procedure yields only a scatter of points, each representing an output, cost pair. But it is still possible to calculate slopes and elasticities at each point of the supply curve.

#### IV. The Linear Case: Specification and Economic Implications

The preceding section provides a methodological framework for deriving water supply functions through a nonlinear program. In many practical situations it is reasonable to have the application of the methodology in the form of a linear programming (LP) problem. Although the main reason for adopting this technique is its advantage in computation, note that the objective function, equation (1), is already linear. The only remaining simplifying assumption, to convert the problem described by equations (1)-(3) to an LP one, is that the production constraints should also be linear. But to represent them in linear form, it will be helpful to view them slightly differently.

Thus far we have considered how different inputs  $L_i$  and  $K_i$  are combined to produce water in a particular process, such as  $X_i$  according to the production relation  $f_i(L_i, K_i) = X_i$ . But it is also possible to consider how a single (scarce) input, say  $L$ , is used to produce water in  $n$  different ways,  $X_1, X_2, \dots, X_n$ . In general nonlinear form, the constraint might be written

$$g(L_1, L_2, \dots, L_n) \leq L' \quad (10)$$

where  $L'$  is the limited amount of  $L$  available to the regional water supply agency.

In linear form, the constraint (10) becomes

$$g(L_1, L_2, \dots, L_n) = a_{11}X_1 + a_{12}X_2 + \dots + a_{1n}X_n \quad (11)$$

where  $a_{11}$  is the amount of  $L$  used in the production of one unit of  $X_1$ ,  $a_{12}$  is the amount of  $L$  used in the production of one unit of  $X_2$ , etc. Then for constraint (2) we might substitute something like

$$a_{11}X_1 + a_{12}X_2 + \dots + a_{1n}X_n \leq L' \quad (12)$$

$$a_{21}X_1 + a_{22}X_2 + \dots + a_{2n}X_n \leq K' \quad (13)$$

and

$$\sum_{i=1}^n X_i \geq Y_D \quad (14)$$

Of course, in the general case we can have  $m$  constraints of the type (12), (13), (14) if more inputs of type  $L$  and  $K$  are considered.

The objective function is also specified a bit differently, in terms of the costs of the alternative processes, instead of the process inputs. That is, assuming  $n$  alternatives  $X_1, \dots, X_n$ , the objective is to minimize

$$C = \sum_{i=1}^n C_i X_i \quad (15)$$

where  $C_i$  is the unit cost of  $X_i$ , subject to constraints (12), (13) on inputs, (14) on outputs, and the usual nonnegativity restrictions.

Of course, it doesn't really matter whether we read the constraints "down" column activities, as before, or "across" row inputs, as in (12) and (13). But the assumption of linearity in production does matter. In economic terms, linearity means that production is subject to constant returns to scale. That is, if each input is increased by  $k$  percent, output is also increased by  $k$  percent, regardless of the size of  $k$ . This may be a realistic description of some processes, but then again it may not. In particular, some limiting factors, often overlooked in the specification of the production technology, like managerial input, will typically prevent the indefinite realization of constant returns to scale. This suggests that the way to interpret the linear format which we adopt for ease in computation is to recognize that it may be a good approximation to the workings of a process for producing water only up to some point.

Another property of the production structure specified in (12) and (13) is that the inputs  $L$  and  $K$  are combined in fixed proportions to produce water in a given alternative. This is obviously more restrictive than the production function we earlier specified, which allows for varying input proportions. But the apparent restriction need not cause any difficulties in practice, because different proportions, and even different production techniques, that might be used to supply water from a given source, say groundwater, are easily represented as separate alternatives.

The methodology described above has been applied to a hypothetical region which may be supplied with water from five alternative sources: river water, groundwater, reservoirs, interbasin transfer from the adjacent regions, and desalination (Gouevsky, Fisher, 1977). The results obtained in this study enable DM to identify various patterns of meeting the required supply  $y_D$ . This can be illustrated by the obtained supply curve shown in Fig. 2. It can be seen from the figure that in the interval  $10 \times 10^8 \leq y_D \leq 20 \times 10^8$  the elasticity of supply curve is rather small and therefore price increases would have relatively little effect on the quantity of water supplied. This sort of result can be especially useful in directing the attention of the water resource planners to

Figure 2

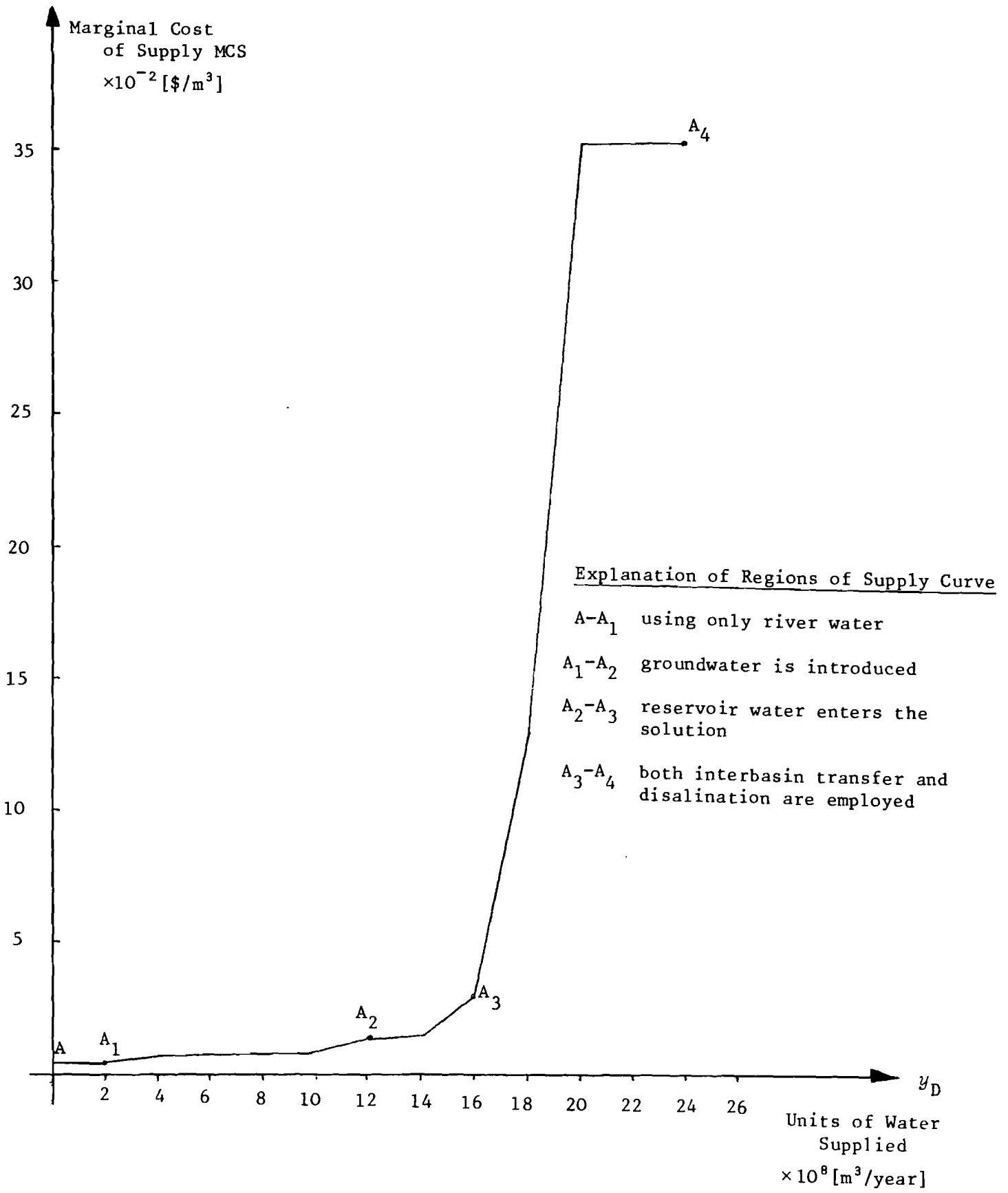

management of demand, rather than supply. That is, if it will be very costly to increase the production of water beyond some point, then measures to restrict demand, rather than augment supply, might be warranted.

It appears that work in this area could benefit from considering how to introduce nonlinearities, especially those resulting from economies of scale, in as painless a fashion as possible. The water quality dimension might also be explicitly introduced. Finally, the dynamics of water supply ought to be considered. Withdrawals from reservoirs or groundwater pools necessarily involve dynamic considerations, and the construction of supply facilities takes time.



REFERENCES

- Burt, O.R., "Groundwater Management under Quadratic Criterion Functions", *Water Resources Research*, Third Quarter 1967, 3, pp. 673-82.
- Burt, O.R., "Groundwater Storage Control under Institutional Restrictions", *Water Resources Research*, December 1970, 6(6), pp. 1540-48.
- Calloway, J.A., and Thompson, R.G., "An Integrated Industry Model of Petroleum Refining, Electric Power, and Chemicals Industries for Costing Pollution Control and Estimating Energy Prices", *Engineering and Process Economics*, 1 (1976), pp. 199-216.
- Cummings, R.G., *Interbasin Water Transfers: A Case Study in Mexico*. (Washington, D.C.: Resources for the Future, 1974).
- Gouevsky, I.V., and Fisher, A., "Economic Evaluation of Water Supply Alternatives: Derived Supply Functions, internal paper, forthcoming Research Memorandum, International Institute for Applied Systems Analysis, Laxenburg, Austria.
- Howe, C.W., and Easter, K.W., *Interbasin Transfer of Water*, (Baltimore: John Hopkins Press for Resources for the Future, 1971).
- Löf, G.O., and Hardison, C.H., "Storage Requirements for Water in the U.S.", *Water Resources Research*, (third quarter 1966), pp. 323-54.
- Thompson, R.G., and Young, H.P., "Forecasting Water Use for Policy Making: A Review", *Water Resources Research*, 9, No. 4 (August 1973), pp. 792-99.
- Water Policies for the Future*, Final Report to the President and to the Congress of the United States by the National Water Commission, Water Information Center Inc., Port Washington, N.Y., 1973.
- Wollman, N., and Bonem, G.W., *The Outlook for Water* (Baltimore: John Hopkins Press for Resources for the Future, 1971).



# REMARKS ON WATER DEMAND - SUPPLY COORDINATION

by

W. Findeisen

Institute of Automatic Control  
Technical University  
Warsaw, Poland

## 1. The overall problem

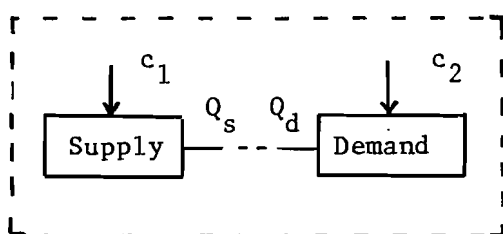

Consider system as in figure, where:

$Q_d$  water demand (water withdrawal)

$Q_s$  water supply

$c_1$  decisions determining how  $Q_s$  will be produced,  $Q_s = f(c_1)$

$c_2$  decisions determining how  $Q_d$  will be used.

Assume an overall utility function  $U$  has been agreed upon; then the task is

$$\text{maximize } U \tag{1}$$

w.r.t.  $c_1, c_2$ . An optimal value  $\hat{Q}_s = \hat{Q}_d = \hat{Q}$  results from  $\hat{c}_1, \hat{c}_2$ .

Note, that (1) could be performed in two stages

$$\max_Q \left[ \max_{c_1, c_2} U \right]$$

where  $Q$  would be a parameter for the optimization problem  $[\cdot]$ .

We are unable to separate "supply problem" from the "demand problem" unless some assumptions about the function  $U$  are made.

2. Separate "supply problem" and "demand problem" with direct coordination

Assume  $U$  can be expressed as  $U = \psi(U_1, U_2)$ , where  $U_1$  is determined by  $c_1$  and  $U_2$  is determined by  $c_2, Q_d$  and  $\psi(\cdot)$  is a strictly order-preserving function. Then

$$\text{maximize } U = \psi(U_1, U_2)$$

w.r.t.  $c_1, c_2$  can be performed as follows

$$\max_Q \left[ \max_{c_1, c_2} \psi(U_1, U_2) \right] = \max_Q \left[ \psi(\max_{c_1} U_1, \max_{c_2} U_2) \right]. \quad (3)$$

Note that  $\max_{c_2} U_2$  means maximization of demand utility  $U_2$  w.r.t.  $c_2$  with  $Q_d = Q$  given as parameter. Similarly,  $\max_{c_1} U_1$  is subject to  $Q_s = Q$ .

An optimal value  $\hat{Q}$  has to be determined by the coordinator (the overall planner). He would actually perform

$$\max_Q \psi \left( \hat{U}_1(Q), \hat{U}_2(Q) \right) \quad (4)$$

since "local" results depend on  $Q$ . We call it "direct coordination".

3. Separate "supply problem" and "demand problem" with price coordination

Assume  $U$  can be expressed as  $U = U_1 + U_2$ . Let us introduce the Lagrangian

$$L = U_1 + U_2 + p(Q_s - Q_d). \quad (5)$$

The overall problem solutions  $\hat{c}_1, \hat{c}_2, \hat{Q}_d, \hat{p}$  are known to be such, that

(i)  $\hat{c}_1, \hat{c}_2, \hat{Q}_d$  maximize  $L(\cdot)$  for any  $p$ :

$$L(\hat{c}_1, \hat{c}_2, \hat{Q}_d, p) = \max_{c_1, c_2, Q_d} L(\cdot, p) \quad (6)$$

(ii)  $\hat{p}$  is such, that

$$p = \hat{p} : \hat{Q}_s(p) - \hat{Q}_d(p) = 0 \quad (7)$$

Performing (6) can be split into two subproblems

$$\max_{c_1, c_2, Q_d} L(\cdot, p) = \max_{c_1} (U_1 + pQ_s) + \max_{c_2, Q_d} (U_2 - pQ_d) . \quad (8)$$

The first part is "optimization on the supply side"; for given  $p$  it gives an optimal value  $\hat{Q}_s$ . Varying  $p$  we get "supply function"  $\hat{Q}_s(p)$ . If reversed,  $p(\hat{Q}_s)$ , it will be the "supply law".

The second part is "optimization on the demand side"; for varying  $p$  it gives "demand function"  $\hat{Q}_d(p)$ .

Note that ultimately the price  $p$  has to be set at  $p = \hat{p}$ , the equilibrium price.

It is known, besides of (7), that (under additional assumptions connected with inequality constraints)

$$\hat{p} = \frac{\partial \hat{U}_1}{\partial Q_s} = - \frac{\partial \hat{U}_2}{\partial Q_d} \quad (9)$$

where the partial derviatives are marginal utility at water supply side and marginal utility at water demand side.

Determining  $\hat{p}$  by using (9) is the classical way.

#### 4. Pitfalls in using price coordination

- (i) You are not supposed to use price coordination if  $U$  is not  $U_1 + U_2$
- (ii) You cannot practically use price coordination if a subproblem fails to have unique solution, for example  $\hat{Q}_d$ , at  $p = \hat{p}$ . This happens very often in linear problems, where it may be that:
  - the overall, correct solution  $\hat{Q}_s, \hat{Q}_d$  is single-valued at  $p = \hat{p}$
  - but the subproblem defines optimal  $Q_d$  as  $Q_1 \leq Q_d \leq Q_2$ .

The danger is real; the subproblem decisions are lawful if they choose any  $Q_d \in (Q_1, Q_2)$ . For example the subsystem designer may require  $Q_d = Q_1$  and it will fail to be optimal from the overall point of view!

#### 5. The case of no common utility function

If no overall  $U$  can be reasonably assumed, we are bound to consider vector optimization on  $(U_1, U_2)$ . We still have  $Q_s = Q_d$  (supply has to match the demand).

The subproblems can be formulated:

$$\begin{array}{ll} \text{maximize } U_1, & \text{maximize } U_2 \\ c_1 & c_2 \end{array} \quad (10)$$

with their results depending on  $Q_s = Q_d = Q$ :

$$\hat{U}_1(Q), \hat{U}_2(Q) \quad .$$

A curve in the  $(U_1, U_2)$  plane with  $Q$  as parameter could be drawn (Pareto optimality). The choice of the ultimate value of  $Q$  is not supplied by the model and has to be made by other means.

Note that you could still formulate "demand problem" as

$$\text{maximize } [U_2 - pQ_d] \\ c_2, Q_d$$

where the price  $p$  is used merely as an instrument to induce the local decision maker to choose a value  $\hat{Q}_d(p)$ .

## 6. Conclusions relating to demand models

From the previous sections it follows that we may have two principal kinds of the demand models.

The *price models* have the form  $\hat{Q}_d(p)$  where this function results from performing  $\max [U_2 - pQ_d]$  for a given  $p$ .

In the case of price models the particular value  $\hat{p}$  set by the coordinator is expected to induce a value  $\hat{Q}_d(\hat{p})$ .

It is worth noting that if the local decision maker has a different model, he may make another choice of  $Q_d$  and disappoint the coordinator (apart from the property that solution  $\hat{Q}_d(\hat{p})$  may be non-unique, as mentioned in section 4).

The *direct models* have the form  $\hat{U}_2(Q)$  where this function results from performing  $\max U_2$  for a given  $Q$ .

In the case of these demand models the coordinator, knowing the value  $U_2$  which would result, is left the choice of allocating  $Q$  according to common utility or to other criteria (see section 5).





REVIEW REPORTS  
FROM  
THE NATIONAL MEMBER ORGANIZATIONS



A BRIEF ACCOUNT OF METHODS USED FOR ESTIMATING WATER  
REQUIREMENTS IN THE USSR

by

G.V. Voropaev and A.L. Velikanov

Institute of Water Problems  
USSR Academy of Sciences, Moscow, USSR

Development of modern society and the resulting rapid growth of industry and agriculture as well as improvement of life conditions have led to an unprecedented increase in water consumption. The problem of rational use of water resources for the benefit of man and environmental conservation has become one of the important problems of today's science and practice.

Determination of water requirements in various spheres of man's activity and for environmental conservation is one of the major components of the problem of rational use of water resources. There are three basic levels of estimating water requirements.

*The first level--planning water use when industrial enterprises and other productive systems are under operation.* Methods for estimating water requirements vary depending on the probabilistic or deterministic nature of these requirements and on the ratio between the amount of water required and the capacity of a water source. For enterprises whose water needs depend little or does not depend at all on hydro-meteorological conditions (for example, industrial enterprises), planning water use under operational conditions implies meeting water requirements estimated while designing a given enterprise.

The problem is more complicated when water requirements vary depending on different factors which are of a probabilistic nature. Here, the method of successive correction of a water-use plan is applied.

Finally, the most complicated from the methodological and practical viewpoint is water use planning when water needs cannot be fully met due to water source (supply) fluctuations. In this case, the problem of optimization of water use arises.

Optimization of water use in irrigation systems has been discussed by G.V. Voropaev (1973). The essence of the problem is the following. An irrigation system is fed from a river whose discharges vary within a wide range and in a number of cases are insufficient to meet full water requirements, estimated

for the optimal operational conditions of the irrigation system. It is necessary to find such a water use plan, which would maximize profit from the irrigation system under irregular water supply conditions depending on water source fluctuations. To solve this problem, various volumes of water which may be supplied to the irrigation system in years with different water availability are considered, and an optimal crop pattern together with the best distribution of water between separate fields are selected. A set of constraints describing various economic and social aspects of systems' operation is imposed.

G.V. Voropaev (1973) discussed the following constraints: the guaranteed targets of agricultural production, water resources constraints, labour resources constraints, and constraints associated with insufficient area for a certain crop rotation pattern. Though the G.V. Voropaev's paper is written in terms somewhat differing from the water use modelling, in fact it solves the problem of constructing a functional relationship between water use and the maximum production efficiency. In this case, dual (marginal) estimates of various resources participating in production may be obtained by solving a dual problem of linear programming.

The problem discussed above has been solved as applied to operational conditions of an existing irrigation system. However, similar problems appear also at the *second level*, namely, at the design of water resources installations and systems. At the design stage, however, parameters and above all the production capacity of water users, are not determined. There are two possible cases of water demand estimation. If a water user is located in a region where water availability does not limit the development of its production capacity, the most effective water supply pattern is selected at the design stage, and water requirements are estimated depending on the technological system adopted.

Contrary is the case when water resources in their natural state are insufficient for meeting water needs which are optimal for the irrigation system under consideration. The problem is that to establish a water resources system, an hydraulically related system of water supply sources, means for water transformation and transportation, and of the water users.

Determination of water requirements is considered to be one of the elements of the water resources system design. While designing water resources systems, water requirements in the Soviet Union are mainly estimated on the basis of the Design Standards prepared and published by the state authorities. Similar standards exist also for wastewater discharges, and they are used for the design of sewerage systems. These standards are set up for all branches of the national economy and they take into account particularities of each production branch.

Water requirements for irrigation are based on irrigation rates, that is, on the amount of water required for irrigation of one hectare of land with a certain crop rotation pattern. Irrigation rates are determined in the course of designing irrigation systems using both Design Standards and economical-mathematical models, which are being increasingly applied. Such models are discussed by G.V. Voropaev (1973) and O.P. Kisarov (1972). However, as was noted above, while designing water resources systems, the problem of determining water requirements cannot be considered separately from the water supply problem and from the problems of other water users composing a given water resources system. *This is one of the basic principles of designing integrated water resources systems in the Soviet Union.* Using such an approach, water requirements of each water user (component of a water resources system) are characterized not only by the amount of water required, but also by the reliability (in a probabilistic sense) of meeting these requirements. The reliability estimate of meeting water requirements is an index, called estimated reliability, that is the probability of supplying a given water user with not less than the amount required. The estimated reliability reflects the system of priorities employed for distribution of water resources. The estimated reliability of meeting water requirements of different water users is based on special investigations aided by economic and mathematical models, which take into account both the benefits from increasing water supply to a given water user and damage from interruption in normal water supply (Kritsky and Menkel, 1969; Velikanov, 1973).

An example of solving the problem of determination of the estimated reliability is the paper by A.L. Velikanov (1963), where an attempt is made to find the optimal capacity of a hydropower plant, a typical in-stream water user, and therefore to find its water requirements. The problem is formulated as a dynamic one; it takes into account the variability in the efficiency of water use for hydropower production. The problem formulated as a nonlinear one is solved by means of the dynamic programming.

Until recently industry has not been considered to be a major water user. However, the growth of water requirements, and in particular, the problem of wastewater disposal, called for the development of certain methods and models for optimization of water management in the individual industrial plants and in the industrial complexes. The purpose of these models is to find the relationships between the amount of water required by and wastewater discharged from in industrial plant, and the costs of constructing the necessary water supply system (Tyutkov, 1977). Similar investigations have been carried out for establishing the navigation requirements (Fedorov, 1975).

*The third level of determining water requirements is to make perspective water balances of water resources. Extended standards for water use rates and wastewater discharges (1973)*

are used for the solution of such problems. These standards are a generalization of a broad experience in designing, construction and operation of water supply systems for a whole range of industrial enterprises both in the Soviet Union and in member-states of the Council for Mutual Economic Aid.

REFERENCES

- Extended Standards for Water Rates and Wastewater Discharges per Unit Output in Various Branches of Industry, (1973), *Stroisdat Publ.*, Moscow, in Russian.
- Fedorov, B.G. (1975), *Methods for Determining the Economically Justified Guaranteed Depth and the Navigation Component of a Water Resources System*, Proceedings of the Co-ordination Conference on Hydraulic Engineering at the Vedeneev VNIIG Institute, *Energiya Publ.*, Leningrad, in Russian.
- Kisarov, O.P. (1972) Production Functions in the Problem of Locating Irrigation Structures, in *Mathematical Analysis of Economic Models*, Part III, Novosibirsk, in Russian.
- Kritsky, S.N. and M.F. Menkel (1969). *Regularities of Fluctuations of Streamflow and Requirements for its Regulation*, Sofia, in Russian.
- Tyutkov. O.V. (1976), Comprehensive Water Management System in an Industrial Region, *Vodnye Resursy*, 4, in Russian.
- Velikanov, A.L. (1963), Determining the Guaranteed Operational Capacity of a Group of Hydropower Plants with Allowance for the Development of a Power Production System, in *Problems of Hydropower Production and Streamflow Regulation*, Collected Papers, 11, AN SSSR publ., in Russian.
- Velikanov, A.L. (1973, Water Resources Systems and Estimated Reliability, *Vodnye Resursy*, 5, in Russian.
- Voropaev, G.V. (1973), *Irrigation Reserves Associated with Optimization of Water Utilization*, Nauka Publ., Moscow, in Russian.





## WATER DEMAND MODELLING--AN ECOLOGICAL PERSPECTIVE

by

Alan Chambers

Institute of Animal Resource Ecology  
University of British Columbia  
Vancouver, Canada

Because many of the presentations to this workshop have dealt with problems of the distribution of water to various user groups, problems of pollution, uncertain supplies, and techniques for reducing consumption in the industrial and urban sectors, to dwell on the Canadian experience in these areas would add little that is new or interesting. Instead, I propose to deal briefly with problems at the intake end of water supply systems, as to reinforce the importance of understanding the nature of water demand functions.

As an ecologist-resource manager, I have dealt primarily with the ecosystem as the basic production unit of a wide variety of goods and services that our society demands. Although basic productivity varies from one watershed to another, and from one ecosystem to another, each of these units is capable of providing a range of goods and services, the individual production functions for which are closely linked. For example, a decision to harvest a particular forest contains implicit decision to modify the quality and quantity of water within a watershed, and to modify the distribution of this yield of water through time. This modification to the aquatic environment, in turn may curtail or enhance the production of fish. Too, the forest harvesting operation may have a significant impact on the basic productivity of the land, it will almost certainly affect the size and distribution of animal populations, and will have a significant effect on recreational values. The point really is that *the costs of harvesting activities for any one resource are widely distributed among the users of other resources.*

Although resource managers work with systems capable of producing many goods and services, they almost invariably work within institutions instructed to deliver a single product to society be it hydro-electricity, wood, water, wildlife, recreation, or some other value. This single resource focus is in itself, a very severe constraint when attempting to identify the true cost or value of a resource, because many costs are externalized, and therefore not taken into account. Perhaps more important, however, has been the basic premise upon which such institutions have operated, namely that it is

necessary to satisfy completely unconstrained demand. The result has been to magnify resource problems considerably. By increasing the supply of hydro-electric power, for example, other values not accounted for have been pre-empted. By reducing supplies of these "other" products, their price or apparent value increases, often to the point that prompts political demonstration.

Two notions flow from this experience that I think should be of interest to this workshop. The first is that *effective--or efficient--resource management requires the ability to constrain demands for particular resources*. Whether constraints take the form of rationing, market distribution, or some other form, they are exceedingly important. While many of us have known that this information is badly required, little work has been done to identify the various policies to which demand is sensitive. The IIASA initiative is therefore both timely and of critical importance.

The second notion that flows from the experience of resource managers is perhaps best expressed in the form of a question--"optimize what?" There are existing allocations of various resources, existing patterns of use, etc. Rather than searching for the "best" solution, particularly when we know that demand patterns, as expressed in the market or elsewhere are in constant flux, we should be searching to identify those policies which can be used to manipulate those patterns of demand--to improve if you like, resource allocations from time to time.

To summarize my discussion I would like to note the following points as those most significant to managers at the "intake" end of water distribution systems:

- 1) The single product focus of most resource management institutions results in externalized costs that are not accounted for, and therefore are not reflected in market price;
- 2) The total value of resources produced from a given ecosystem may be much higher in a management framework which does not "optimize" particular resource values;
- 3) The nature of the decision process is, at least in Canada, political. Many examples may be cited. The defeat of the Texas Water Plan which Professor Thompson mentioned on the first day of our workshop is perhaps most illustrative here.
- 4) *The nature of the planning process is to articulate alternatives*. In this regard, I sense that work is progressing on the "supply" side more rapidly than it is on the "demand" side of the equation. In our event two questions emerge which IIASA might address.

The first relates to the nature of institutions for planning resource development, the second relates to the techniques that are available.

*With reference to the Canadian experience, demand for water in both the community and industrial sectors is sensitive to price, to technology, to population distribution, and cost distribution. Much work must be done, however, to document these sensitivities and others more completely. For that reason, I would encourage the IIASA water group to:*

- 1) Document those elements or policies to which water demands are sensitive in the community, industrial, and agricultural sectors.
- 2) Study the institutional structures within which water resources are managed within IIASA member countries, with particular emphasis on methods, which are used to resolve conflicts (for example, the Swedish Water Courts).
- 3) If models are to be built, they might well take the form of a series of "nested" models, since control is exercised by policies at several levels of government (local, regional, and national).

REFERENCES

- Grima, A.P. (1972), *Residential Water Demands; Alternative Choice for Management*, University of Toronto, Dept. of Geography, 200.
- Grima, A.P. (1973), *Impact of Policy Variables on Residential Water Demand and Related Investment Requirements*.
- Lee, T.R. (1972), *Approaches to Water Requirements Forecasting; a Canadian Perspective*, *Social Science Series*, 9, Canada Center for Inland Waters, Burlington, Ontario.
- Tate, D.M. and R. Robichand (1973), *Industrial Water Demand Forecasting*. *Social Science Series*, 10, Inland Waters Directorate, Water Planning and Management Branch, Environment Canada.
- Scott, A., ed. (1975), *Natural Resource Revenues; a Test of Federation*. University of B.C. Press, Vancouver.
- Anon. (1975), *Monograph on Comprehensive River Basin Planning*. Environment Canada, Ottawa, Ontario.
- Anon. (1974), *Land Use and Resource Development in the Eastern Slopes: Report and Recommendations*. Alberta Environment and Conservation Authority, 8215 112 Street, Edmonton, Alta.
- Chambers, A. (1975), In Term C.O., ed. *Man in the Boreal Forest*. Swedish Academy of Sciences, Stockholm.

## SOME REMARKS ON MODELLING OF WATER DEMANDS IN CZECHOSLOVAKIA

by

Quido Partl

Research Institute for Water Management  
Prague, CSSR

At the very beginning of my brief presentation, I would like to express my thanks to the organizers of this Workshop for having given me the opportunity to participate in these interesting and useful deliberations as a representative of Czechoslovak water managers.

The work of the International Institute for Applied Systems Analysis is highly appreciated in my country; your publications from the field of water management are followed with attention by Czechoslovak specialists.

We can constantly see that countries the world over have quite similar problems in their efforts to meet the ever increasing water demands; consequently, research coordination in this field and mutual exchange of experience appear to be extremely useful.

Now to the topic of your deliberations. I welcomed all the texts and materials sent beforehand as well as the informative letter by the Task Leader Dr. J. Kindler. These materials allowed us to get a good orientation within the problems to be dealt with. This was very important, since the solution of the task Regional Water Demand and Management is conceived in an original way.

Complying with the wish expressed in the letter of the Task Leader, I shall try to structure my contribution according to the three main objectives mentioned: Review work to be done at IIASA in light of the experiences in each of the NMO countries:

The reasons given when recommending to transfer attention from supply-oriented extensive approach to demand-oriented intensive approach are quite convincing and very useful. I firmly believe that the intensive approach could help us to reveal important water resources reserves and could save quite considerable capital investment means. During the solution of our water management problems--not at all easy due to our unfavorable hydrological and geographical conditions--*we too were excessively oriented at the extensive approach.*

I was much interested in the three enclosed studies written by R.G. Thompson, H.P. Young, J.A. Calloway and A.K. Schwartz. The application of demand functions seems to

be very promising in the perspective. The presentation of possibilities of useful analytical and programming methods application represents an important contribution as well.

Further on I was interested in the assumption that this task should be completed, in its substantial part, already during this year 1977. I think that the range of the work to be done is extremely large. It will require a highly demanding and time-consuming cooperation of technologists and economists from various industrial fields and the acquisition of economic data. To make the cooperation with foreign institutes smooth and functioning will probably also require some time. *For that reason I am rather inclined to believe that the fulfillment of the task will take a somewhat longer time.*

I would also like to express my view regarding another aspect of our problem. When solving the questions of water supply for the society we are constantly obliged to pay attention to the future, very often to quite a distant future. In some cases it is quite obvious: if we want to determine the capacity of a water reservoir to be built, say, in 10 years and to serve usefully for another dozen years, we have to solve the question of future water demands; we have also to have an idea how the human community will look like in several dozens of years. I am afraid that the procedures used up to now could give us absolutely false results. Several basic changes of a qualitative aspect can occur which we, the water managers, cannot foresee. To put it briefly, I am in favor of serious prognostic research capable of analyzing the development of society in connection with water demands. I would like to know if the water management program of IIASA will cover this problem as well.

Now to the second objective: Identify research institutions with whom we can establish collaborative ties.

Different problems of complex use of water resources and, consequently, problems of regional water demand management are studied at our Research Institute of Water Management. Department of Water Management in Prague (Czech address: Výzkumný ústav vodohospodářský, úsek Výzkum hospodaření s vodou, Praha 6, Podbabská 30). Working contacts can be established with this institute.

To characterize the work of this Institute I might add that recently this Institute has completed a very large and detailed document called the Guide-lines of Water Management Plan of the Czech Socialist Republic solving the development of our water management till the year 2000.

The interest of our Research Institute of Water Management in the problems of complex use of water resources can be documented also by the fact that the Institute organizes regular symposia on water resources systems with participation from abroad. To provide some information I have brought here the 1st volume of Proceedings from our latest symposium held in this last year.

As far as the third objective is concerned, i.e. the establishment of an international working group directly supporting in-house research at IIASA, please allow me to express my view in the course of the deliberations, when I have become better acquainted with the whole range of problems. If our cooperation appears as useful, I can assure you that from our part we are sincerely interested in it.





SOME GENERAL REMARKS ON MODELING OF WATER DEMANDS  
IN THE GERMAN DEMOCRATIC REPUBLIC

by  
Siegfried Dyck  
Technical University  
Dresden, GDR

Water Resources and Water Utilization Intensity

The run-off formed by precipitation falling on the territory of the GDR and West Berlin is for the period 1901-1970  $\bar{R} = 17,4 \text{ km}^3$  per year. If the surface run-off  $R_0$ , which mainly arises in form of flood water is separated from this potential water resource, then a baseflow of  $R_S = 8,7 \text{ km}^3$  per year is obtained, which is called real or stable water resource. The stable water resources are augmented during low water periods by means of additional water released from reservoirs and regulated lakes. The regulated water resource is approximately  $R_r = 2 \text{ km}^3$  per year.

For comparison the resulting specific water resources for the GDR including West Berlin are given:

Potential water resource (R)	: 915	$\text{m}^3$	per person and year
Stable water resource ( $R_S$ )	: 458	"	"
Regulated water resource ( $R_r$ )	: 105	"	"

Assertions about the intensity of water utilization in a territory may, however, only be derived following balances of water resources and water demands. In order to roughly derive the water utilization intensity in the course of an average year we use the

$$\text{degree of utilization} = \frac{\text{water demand}}{\text{water resources}} \cdot 100 (\%)$$

Related to the water resources given above we obtain the following degree of utilization:

$$\bar{R}: 47\%; \quad R_S: 94\%; \quad R_S + R_r: 77\%$$

If, in addition the inflow from abroad by means of the Elbe of  $R' = 10 \text{ km}^3$  per year is taken into account, then a specific potential water resource ( $\bar{R}$ ) of  $1440 \text{ m}^3$  per person and year is obtained. This corresponds to a degree of utilization of 29%.

These results indicate the GDR has limited water resources and has already attained a high intensity of water utilization. As all the figures illustrate average data they only provide a general survey. Balance computations showed for low run-off months an average degree of utilization of 200% for the whole Elbe area of the GDR and of 300-400% in the densely populated areas in which some 40% of the GDR population lives and in which 50% of GDR gross industrial production is turned out. The unfavorable balance of water resources and needs and the high level of water resource development require consequent planning and water management giving due consideration to all possibilities of water management (operational, legal, technological, etc.).

### The General Planning Process

*The assessment and modelling of water demands is done according to the political, economic and geographical conditions. In a planned economy it is part of the general planning process in which systems analysis plays a major role.*

A first concern of system analysis is to take adequate account of objective social relations, the selection of goals, and the choice of appropriate means for attaining these goals. The central decision is the choice of a strategic orientation for the development of the whole system. Its realization requires a large number of interrelated decisions. The very complicated planning and decision process is an iterative one. It has to be done on different levels in different scales or dimensions according to space and time ranging from national to local problems and for different time horizons.

The planning system that also is followed for the assessment of the water demand has the following main components:

- Forecasts of social processes, particularly socio-economic and socio-political ones, and of scientific-technical problems.
- Long-term planning that acts as strategic instrument of the State for national social development.
- Five-year planning as the main instrument for the continuous balancing of all branches of the national economy as well as of the regions.
- Annual planning that updates the five-year plan in accordance with the results of the past period and on the basis of new findings, and that serves as the direct means of realizing the objectives.
- Selection of possible solutions based on forecasts which is the cardinal problem of planning. The findings from forecasts must be transformed into statements that can be quantified, subject to national economic standards and restrictions.

Special programs are drawn up for those targets that have a high degree of economic interdependence and are of strategic importance for developing the working and living conditions of the people such as housing, assuring adequate energy fuels and raw materials, agriculture, especially irrigation and industrial livestock breeding.

These programs have a major influence on water demand and enable predictions of the water demand. The housing program (it is planned that 750 000 dwellings will be built or reconstructed in 1976 to 1980) results in an *increase of residential water demand by nearly 4% per year for the coming 10-15 years, then arriving at a saturation level.*

The irrigation program provides for doubling of the irrigated area in the coming 5 years. The resulting increase of water use has to be taken into account in regional balances and in balances of the branches of national economy. These balances are the base of economic balances from which decisions and directions result regarding the policy of water management. *One of these directions is, for instance, a 20% decrease of industrial water withdrawals by in-plant measures to be achieved during the coming 5 years. Nevertheless, the industrial water demand will increase according to the development of industry. To realize this "20% decrease direction" procedures are to be applied similar to those demonstrated yesterday with the ammonia-model.*

### Water Demand Standards and Functions

As I already mentioned in our discussion on definition of terms *our definition of the term "water demand" differs somewhat from that given in the conference material. Water demand is defined as the totality of quantitative and qualitative requirements of water by water users at definite times and sites that are acknowledged by the society. The water demand is stated by standards and functions valid for a limited period of time. That means they have to be updated continuously.*

Demand functions are relations between the water demand of different water users and factors of main influence upon that demand. *Only one of these factors is the cost or price.* The basic idea of this conception is that the development rate of several parameters of the national economy can be determined more reliably than the development of the water demand. The index figures of the water demand take into consideration the time dependence of the water demand. The influencing factors are obtained systematically by statistical and other investigations. The calculated water demand is the base of systematic technical, technological and economic investigations.

After having answered the question: what will be the evolving pattern of demand?, we have to investigate on the other side the questions:

- What resources are available to satisfy the demand?
- Which are the optimal water supply functions or *water demand-supply coordination*?

Our Water Law provides that withdrawal and release of water must be approved by the professional authorities. Approvals are given on the base of economic water balances, that means balances of water resources and demands. For compiling economic water balances for a region different methods of modelling and optimization are used. For most of our river basins we apply the dynamic approach: stochastic streamflow generation to describe the water resource and water demand for different time horizons (Monte Carlo Method). Of course, better prediction of water demand would automatically increase the accuracy in balances or in any optimization analysis and in decision making for various water resources problems.

A greater effort in collecting the appropriate data and in estimating various parameters of mathematical models of the water demand time series may provide for much better regional or national standards and more realistic prediction of future water demands.

*May I mention only that in the GDR water and wastewater charges have been introduced, different for residential and industrial water use and for surface and groundwater supply for industry. Penalties are inflicted if given standards for waste water release are violated by the water user.*

Let me now respond to the three major objectives mentioned in the invitation letter:

1. I think that we can agree in general upon the structure and content of the planned study outlined by Dr. Kindler. *Although the main goal is regional water management, plant-level case studies of an illustrative character seem useful to me. Therefore the models developed in Houston are a good starting point. As similar models have been compiled in other NMO-countries let us collect them and give them to IIASA for comparison. We would appreciate the development and collection of similar models in agriculture.*
2. The Institute for Water Resources Research is ready to cooperate in this project for modelling the water demand and to coordinate the activities within the country.
3. We are also ready to support in-house research at IIASA in the framework of an international working group.

REFERENCES

- Dyck, S. (Hrsg.), *Angewandte Hydrologie, Teil 1*, Verl. f. Bauwesen, Berlin, 1976.
- Heidorn, F., U. Schaake, *Sozialistische Intensivierung auf dem Gebiet der Betriebswasserwirtschaft, Haupt - instrument zur Durchsetzung der wirtschaftlichen Wasserverwendung, WWT 26*, 1976, H. 11.
- Koziolok, H., *The Systems Approach to Solving National Economic Problems*, IIASA Conference '76 Vol. 1, 1976.
- National Report of the German Democratic Republic to the UNESCO, WMO - Conference on Hydrological Problems in Europe*, Berlin, 1973.
- Salas-La Cruz, J., U. Yevjevich, *Stochastic Structure of Water Use Time Series*, Hydr.Pap. No. 52 - Colo. State Uni., 1972.
- Schweiger, K.H., G. Feichtinger, H. Metz, *Beitrag zur Methodik der Wasserbedarfsermittlung in Flussgebieten, WWT 22* 1972, H. 10.
- Strube, M., *Die Arbeit mit Normen und Normativen der Wasserentnahmen und des -bedarfs, WWT 26*, 1976, H. 8.



DETERMINATION OF WATER DEMANDS  
IN THE  
FEDERAL REPUBLIC OF GERMANY

by  
Wolfgang Günther  
Technical University  
Hannover, FRG

1. General situation

A forecast of water demands for the Federal Republic of Germany is given in Table 1 below:

	1974		1980		1985		2000	
	10 <sup>9</sup> m <sup>3</sup> /a	%	10 <sup>9</sup> m <sup>3</sup> /a	%	10 <sup>9</sup> m <sup>3</sup> /a	%	10 <sup>9</sup> m <sup>3</sup> /a	%
Private households	2,8	9,1	3,0	6,4	3,4	5,1	3,9	5,6
Private trade, public institutions & agencies, agricultural irrigation	1,2	3,8	1,1	2,3	1,1	1,6	1,1	1,6
Industry (without energy production for public use)	11,7	37,7	12,4	26,4	13,3	19,9	16,1	23,1
Energy production (for public use)	15,3	49,4	30,5	64,9	49,0	73,4	48,6	69,7
	31,0	100	47,0	100	66,8	100	69,7	100

Table 1

Expected development of water demands in the FRG for four user groups in the years 1974, 1980, 1985, and 2000 (Battelle-Institute, Frankfurt/Main, 1976).

It can be seen from this Table that the energy production for public use and industry are the major components of total water demands and that problems of agricultural irrigation (nearly 0.7% of the total water demands) are relatively unimportant (omitting certain regions with much agricultural production and small available water resources).

The high use of water by the energy production sector and by industry is strongly linked with the problem of water quality. Water quality is, therefore, a major problem in the FRG and it very often limits the increase of water demands. The water quality in streams is often so bad that the high costs of water treatment limit the increase of water use. Also, an important water quality factor is the heating of surface waters by cooling water discharges from power plants. There are standards for the maximum allowable temperatures of stream waters set up from the ecological and environmental point of view and these standards limit the unbounded increase of demand for cooling water. Therefore, in determining cooling water demands for energy production, questions of heating of surface waters must be considered.

## 2. Investigations in determining water demands

There are many institutions in the FRG dealing with questions of the determination of water demands. These are for instance:

- a) Governmental authorities (the Ministry of the Interior and the Ministry of Research and Technology charge certain institutions with investigations on water demands [see e)]; the activities of the Federal Council of Statistics should also be noted).
- b) Federal State Authorities (activities of the State Council of Statistics and of the water management authorities in federal states being responsible for preparation of general plans for water management).
- c) Associations and water supply works (planning of their capacities and investments).
- d) Industry (there are many activities in the individual industrial groups, e.g. in energy industry).
- e) Institutions charged and financed by governmental authorities or industrial groups to investigate various types of water demand problems. A few examples of these investigations follow.
  - The Ministry of the Interior charged *Battelle-Institut*, Frankfurt/Main, to carry out investigations for determining and forecasting water demands in the FRG. Three analyses have been completed thus far:
    1. Wasserbedarfsentwicklung in Industrie, Haushalten, Gewerbe, öffentlichen Einrichtungen und Landwirtschaft - Prognose des Wasserbedarfs in der Bundesrepublik bis zum Jahre 2000. *Battelle-Institut*, Frankfurt/Main (1972),



[Development of Water Demands in Industry, Households, Private Trade, Public Agencies and Institutions, and Agriculture - Forecast of Water Demands in the Federal Republic until 2000].

2. Prognose des Wasserbedarfs in der Bundesrepublik Deutschland bis zum Jahr 2000 - Zeitstandsbericht. Battelle-Institute, Frankfurt/Main (1976), [Forecast of Water Demands in the Federal Republic of Germany until 2000].
  3. Analyse der Einflußfaktoren des Trinkwasserbedarfs der privaten Haushalte in der Bundesrepublik Deutschland und Prognose bis zum Jahre 2000. Battelle-Institut, Frankfurt/Main (1976), [Analysis of Factors Influencing Drinking Water Demands for Private Households in the Federal Republic of Germany and Forecast until 2000].
- The Ministry of Research and Technology has charged the Institut für Wasserwirtschaft, Hydrologie und landwirtschaftlichen Wasserbau of the Technische Universität, Hannover, to write computer software for general planning of water management (project: "Computer-Oriented Water Resources Management"). This project will be finished by the end of 1977 and computer programs, including documentation, will then be available.
  - In the framework of constructing a "World-Model for Water Resources Management" many worldwide institutions work together, and among other matters, questions of water demand and forecasting are being studied. The Wasserwirtschaftsinstitut of the Technische Universität, Hannover, is supported in its work by the "Deutsche Forschungsgemeinschaft" (DFG). In these studies, questions of water demand are related to large regions, e.g. parts of continents.

### 3. Basis for determining and forecasting water demands

The basis for determining water demands are forecasts of:

- population increase;
- development of irrigation projects;
- development of industrial production; and
- development of energy production.

The first two forecasts are relatively easy to make but the two other forecasts are very difficult and usually not precise. Examples of the economic development in the last ten years demonstrate this statement effectively. The energy program of the Federal Government was, at the end of the 1960's and at the beginning of the 1970's, based on the assumption of a very high rate of energy production in the oil burning power plants. On this basis, the determination and forecast of water demands for energy production was made. In 1972-73, during the worldwide oil crisis, the Federal Government worked out a new energy program with more emphasis on energy production by nuclear power plants. The consequent determination and forecast of water demands differ strongly from the earlier forecast because the specific water demands per KWh depends on the technology of

energy production. The forecast of water demands for energy production, given in Table 1, is based on the energy program developed after the oil crisis. But now we have a new situation in the FRG; large groups of the German population are protesting against the construction of new nuclear power plants. These protests may force the Federal Government to redirect the energy program. And this would mean that the basis for determining and forecasting water demands will probably have to change again. There are similar difficulties in the determination and forecasting of water demands in all other industrial sectors, whereby questions of water treatment costs and wastewater disposal will be more and more of a decisive character.

In this connection, determination of economic water demands for improvement of water quality by low-flow augmentation is a major problem (construction and operation of reservoirs). The solutions of such problems are aided by using mathematical models (decision theory and simulation models). Several types of such models are being developed presently.

WATER RESOURCES PLANNING AND MANAGEMENT  
AND THE ROLE OF DEMAND STUDIES

by

Charles W. Howe  
University of Colorado  
Boulder, Colorado, USA

I. Recommended Strategy in the Project

A major shortcoming in the literature on water resources management is a good statement of the principles and procedures on which supply and demand elements of a river basin are to be pulled together to determine desired (or "optimal") river basin plans and operating procedures. It is really only when demand functions are placed within this longer setting that their usefulness becomes obvious.

*Therefore, it is proposed that the IIASA staff, over the next few months while the staff members are all still here, work together on a statement of principles and procedures which are adequate for assuring that river basin planning procedures take into account all relevant supply and demand factors. This statement should be at a level understandable to the professional river basin or river authority planner.*

It could take the form of a formal planning model of general applicability, but probably would be more useful if stated as a sequence of steps of data collection, analyses, and final benefit-cost comparisons which could be carried out without benefit of a formal computerized model.

*It is further recommended that case studies be contributed by the NMO's and not be attempted by the IIASA staff. Involvement in data problems would not be an efficient use of their time. Almost all case studies, I would guess, have to be drawn from past or current studies already underway--hopefully written in such a way as to emphasize the role and nature of demand studies.*

It is recommended that the work described above be comprehensive in covering (at the level of principles and procedures) agricultural, industrial, urban and in situ water used. While models are transferable with appropriate data modifications, it is not clear that they can be made "more transferable" or "more general" by anything the IIASA staff can do within the year or so. If a "library" function of program storage and documentation is desired, one well qualified staff person should be hired for that purpose.

## II. The US Arrangements for Water Resources Planning and Management of Demand Studies

### A. Planning and Management Institutions

There exists a hierarchy of water agencies in the US from federal to state levels. *At the top*, the federal Water Resources Council is charged with two major functions:

- 1) undertaking a periodic "national assessment" of water supply and demand conditions; and
- 2) coordinating water planning and management among agencies at lower levels.

*The second eschelon* of agencies consists of the river basin commissions, defined along major basin boundaries. The commissions, like the Water Resources Council above them, are charged with coordinating the actions of all agencies below them: state and local units, private industry, and the federal construction agencies which build and manage major projects-- the Bureau of Reclamation, the Corps of Engineers, and the Soil Conservation Service. The commissions are also charged with developing a "comprehensive river basin plan" in cooperation and with the consent of the states and localities in the basin.

It must be pointed out that the Water Resources Council and the River Basin Commissions have no authority to build or manage projects or systems and that their planning and coordination really rely on persuasion and cooperation rather than authority to order other agencies to undertake certain actions.

*The third level* of agencies consists of the states which control the "water rights" systems which allocate scarce water. The states also have primary responsibility for developing water quality plans under the supervision of the federal Environmental Protection Agency. While states' actions and plans are to be coordinated (in a voluntary sense) by the River Basin Commissions, the states in fact have substantial political power to initiate projects and to gain the assistance of the federal construction agencies in building the projects they want.

### B. Role of the "National Assessment" and the Comprehensive River Basin Plans

The "national assessment" is carried out periodically by the Water Resources Council with the assistance of the states and the river basin commissions. Region by region (there are 21 water resource regions compared to 8 river basins with established commissions) supply and demand conditions are

evaluated in aggregated terms, nonetheless giving fairly detailed consideration to industrial, agricultural, and metropolitan composition of the region. *Detailed demand models are not used in these studies, but trends are incorporated in the water use coefficients employed, and alternative scenarios are analyzed, especially when water demands are felt to be sensitive to possible policy changes. Information from micro studies like the ammonia model is incorporated at this point.*

The river basin commissions are required to maintain up-to-date comprehensive plans for the management and future development of the water resources of the basin. While such plans identify possible future projects and discuss possible problems of water allocation and water quality, they usually are not construed within an optimizing framework nor derived from any formal models. The use of formal optimization schemes is confined to the development and management of subareas of river basins such as sequences of dams and reservoirs which are operated for water supply and power purposes by a single agency such as the federal Bureau of Reclamation

C. An Example of the Use of Demand Studies in River Basin Management: The Colorado River Basin

The Colorado River Basin covers approximately 102,000 square miles (260,000km<sup>2</sup>) in the southwestern United States, rising in the Rocky Mountains of Colorado, then passing through mostly semi-arid land in the US and Mexico and into the Gulf of California. The annual flow of approximately  $13 \times 10^6$  acre-feet per year is fully utilized, with practically no flow reaching the Gulf of California. A legal arrangement divides the basin into an upper and a lower basin for purposes of water allocation. The lower basin was developed earlier than the upper, and is presently consuming more water than can be legally claimed. The upper basin uses large quantities of water for irrigation, and the return flows carry large quantities of salt into the river. As a result, salinity levels in the lower basin have risen to a point (850 mg/l) where damage to irrigated crops is occurring. Thus when the upper basin increases its water use, it takes water from current uses in the lower basin and adds to salinity damage there.

The river serves small municipal and industrial uses, but the greatest use is agriculture (and *in situ* power uses). Since agriculture is both the dominant water user and the economically marginal water, demand studies can concentrate on the agricultural sectors of the two basins since any reallocations should take place from marginal agriculture to higher valued uses.

These demand studies have shown that practically all agricultural uses in the upper basin have a lower marginal value than the agricultural uses in the lower basin. Thus,

for economic efficiency nearly all agricultural water should be used in the lower basin. This is in conflict with the legal allocation of water between the basins referred to earlier.

Further, there is no administrative mechanism for requiring that further developments in the upper basin take account of either the opportunity cost of the water they will consume (the net value of marginal agricultural output in the lower basin) or the additional salinity damage they will cause.

It follows that the estimated water demand functions for the upper basin, indicating the willingness to pay for water, lie above the true marginal benefits function for the system as a whole. Similarly, the estimated demand functions for the lower basin lie below the true marginal benefit functions which would exist if an optimal level of salinity were achieved in the basin. Another way of stating these observations is that if the demand functions were derived from a basin-wide optimization model, they would be below and above the currently estimated functions for the upper and lower basins respectively.

Finally, it must be observed that Mexico uses water from the river. Current treaty safeguards guarantee minimum levels of water quantity and quality to Mexico, but there is no assurance that the quantities or the techniques used to assure quality are even near the optimum from the overall international river basin viewpoint.

*These observations emphasize not only the importance of the appropriate systems setting for demand studies but also the importance of the institutional arrangements for water planning and management.*

AN  
OVERVIEW OF WATER RESOURCES MANAGEMENT  
AND WATER DEMAND PROBLEMS IN POLAND

by

Aleksander Laski

"Hydroprojekt", Consulting Engineer  
Warsaw, Poland

and

Antoni Symonowicz  
Institute of Meteorology and Water Management  
Warsaw, Poland

In order to create appropriate conditions for Poland's economic and social development after World War II, it was necessary to undertake studies (initiated in the 1950's) in the field of a comprehensive use of water resources.

The first long-term comprehensive plan of water resources development in the whole country was elaborated by the Water Resources Committee of the Polish Academy of Sciences in 1957. This plan was based on hypotheses of economic and demographic development forecasted until 1975.

The successive stages of the water planning studies were carried out between 1958 and 1962 (regional plans of water management) and between 1960 and 1963, when the second national long-term water resources development plan was completed by the Institute of Water Management, for the period up to 1980. A successive revision of this plan was prepared in 1968, extending the forecasted time horizon to 1985. It should be emphasized that water use forecasts included in these studies were based on the general economic and social development plans of the country. No special consideration was given to the establishment of interrelationships between water demands and the costs of water supply. One can say that in preparing these first water resources development plans, a typical "maximum supply" orientated approach was applied.

In recent years, Poland's water resources have been confronted with the more dynamic development of the country. Industrial and agricultural production and the growth of urban agglomerations have created a demand for a guaranteed supply of water whose quality must be suitable for individual users.

This situation, in the long run, leads to the problem of how to deal with quantitative and qualitative shortages of

water resources (water deficits), a problem which has already appeared in certain regions of Poland.

It was necessary to work out and implement in water resources planning a new methodology and advanced computational techniques, which would allow formulation of a rational investment program for water resources development, ensuring fulfillment of water management's long-term targets (time horizon 1985 - 2000).

The elaboration by "Hydroprojekt" of the studies known as the "Vistula Project" (completed in 1974) and "Odra Project" (completed in 1975) resulted in a comprehensive national water resources development plan which was approved by the Polish Government in 1976. In these studies water supplies are considered subordinate to the development of the national economy, which is the primary objective. The main tasks of water management taken into account are as follows:

- Water supply for municipal, agricultural and industrial uses;
- Assurance of the minimum acceptable flow;
- Water pollution control;
- Reduction of losses due to floods;
- Development of navigation, recreation and hydropower generation.

The analysis encompasses various engineering schemes of water supply, using a simulation model for optimization of water reservoirs operation; for water resources allocation, the system of "weights" is used. This system of "weights" describes the general priorities of water use in the system, taking into account social and economic objectives. The choice of the optimal solution is based on the economic analysis (minimization of investment and operation costs of the water management system, considering additional economic effects).

The water use rates introduced into the model are based on the special studies undertaken by several branches of the national economy. The forecasts of water use are based on a hypothesis of future socio-economic situation and the future changes in production technology. This hypothesis was elaborated with the cooperation of the National Planning Authorities.

The current works concentrate on applying the already developed methodology of water resources management planning to particular regions of Poland, where intensive economic growth creates a need for more detailed analysis which takes into account newly introduced economic factors resulting from regional development.

In these regional analyses we also try to introduce other approaches to the evaluation of future water uses and development of water resources.



One approach is the analysis of dependable water resources in the consecutive subsystems of a region. This analysis takes into account a number of hypotheses for water use and consumptive losses in all branches of the national economy and in all subsystems affecting dependable water resources in the subsystem analyzed.

The analysis is made separately for each variant or step of investment program which increasingly augments the dependable water resources.

We start with the "non-investment variant" (the use of local natural resources), and the next consecutive steps are reservoir construction, inter-basin water transfers, reclamation of wastewater by advanced treatment and in some cases recirculation of a part of river flow inside the system. This recirculation is always connected with the advanced treatment processes.

As a result of such analyses we hope to achieve an evaluation of the dependability of regional water resources as a function of alternative futures for each consecutive step of measures increasing dependable water resources.

Turning back to the main subject of this Workshop, we should say that former approach to water management in Poland was traditional and extensive. We tried to meet all water needs by increasing the water supply. However, this method became impossible in a rapidly developing country with scarce water resources. Now we are trying to force water users, especially in industry, to diminish their water demands by means of economic incentives.

The first step in this direction was taken last year when we introduced a price for water used in the industry, i.e. surface and ground water withdrawn by industry from its own intakes. *The price of water is based upon the average costs of augmenting dependable water resources.* In most developed regions where water use is high and resources scarce, the price is higher and varies from 20 to 50 groszy (1-2.5 US cents) per 1 m<sup>3</sup>. The thermal power stations pay only for the consumptive use of water.

After one year's experience *we have observed that the price is too low; it does not sufficiently decrease industrial water use.* Therefore, we are looking for another basis for pricing water. We consider two alternatives: the marginal cost based on future investment or costs of water substitution possibilities in water intensive industries. In an attempt to avoid an increase in the industry production costs, we use "shadow prices", that will be taken into account in planning and projecting technology of production and cooling systems in new or modernized plants.

In addition to the price of water, we have also introduced charges for waste discharges--not for all pollutants but only

BOD, COD and suspended solids. These charges are calculated on the basis of the average cost of removing pollutants in the waste treatment processes; charges vary according to the required water quality in the receiving streams. For example, charges for pollutants discharged into waters of first class quality (the drinking water resource) are 40 percent higher than charges for pollutants discharged into the third class waters. The aim of introducing charges was to compel water users to treat wastes and to limit the quantity of pollutants discharged into water bodies. For other pollutants (dissolved solids, phenols, ammonia, etc.) we apply penalties when the quantity of pollutants exceeds the state standards.

Another problem is *thermal pollution*. As we develop the energy resources of our country we are building typical thermal power stations with installed capacities of 3000 MW with closed or combined cooling systems. In this last system we are constructing cooling towers which sometimes operate only under extreme conditions, for instance in summer, when river flows are low and temperatures high. The reason for constructing cooling towers is due not to economic incentives, but to the official standards of the maximum acceptable temperature of water bodies.

The studies on water management and water development planning are carried out in Poland mainly by two institutions:

- 1) Hydroprojekt, Consulting Engineers Bureau;
- 2) Institute for Meteorology and Water Management.

We would like to stress, that both the above mentioned institutions will greatly appreciate further collaboration with IIASA and its National Member Organizations in the field of modelling water demands.

As an example of possible application of water demand models similar to those presented at this Workshop by the University of Houston we would like to mention the need for a detailed analysis of water demands of a chemical complex situated in southern Poland, a region where quantitative and qualitative water deficits already exist. In this case, evaluation of water demands and production costs as a function of water supply costs (connected with the increase of regional dependable water resources), could contribute greatly to the optimization of a regional water development plan.

IIASA's help in modelling economic water demands would be very useful for our water management, not only for establishing water prices and charges for waste discharges, but also for determining possible ways of decreasing water demands. The aim of water management in Poland is to cover water demands by augmenting dependable water resources and by partially decreasing water demands. In our opinion, the optimal economic solution is to minimize the total costs of increasing water supply and of diminishing water demands by substitution.

## DEMAND MODELLING IN ENGLAND AND WALES

by

Robert J. Smith

Central Water Planning Unit  
Reading, United Kingdom

In England and Wales there are, in total, ten multi-purpose Water Authorities, each responsible for water supply, conservation, drainage, recreation and effluent disposal within its area, which is either a single river basin or a group of river basins. About two fifths of the water abstracted from surface waters and aquifers is taken for distribution through the public water supply. The remaining three fifths is taken directly by the Central Electricity Generating Board, other industrial concerns or agriculture. Of the water distributed through the public water supply about one third goes to metered consumers, which are primarily industrialists but which include some hotels, schools, offices and shops. Two thirds is unmetered, and this includes virtually all domestic consumption, all leakage, some commercial use, (in hotels, schools, offices and shops etc.) and water used for mains flushing and fire fighting.

In preparing demand forecasts the industry has traditionally used very simple extrapolative techniques, and therefore *demand modelling has been confined largely to the fitting of trends to past demands*. Because of the many amalgamations of small water undertakings which took place during the 1950's many records of past consumption have been lost. Consequently it has been possible to construct a consistent series of data at the national level only since 1961.

The past trend in per capita unmetered consumption, shown in Figure 1, reveals a remarkable level of consistency. The trend is very nearly linear and the high demands in 1963 and 1975 were attributable to weather conditions. In 1975 there was a very good summer while in the early part of 1963 severe winter weather resulted in a substantial volume of water being lost because of bursts. However fitting a trend equation is not as simple as it may appear. In practice either a linear or a semi-logarithmic equation would fit the series equally well. Even where longer series of data are available it has proved no easier to determine the form of the underlying time trend. If the identification of the trend were straightforward there would still be some anxiety as to whether past trends would continue into the future. *Therefore over the past year or two attempts have been made to increase our understanding of water demands, in particular to determine which variables have the most influence on water consumption.*

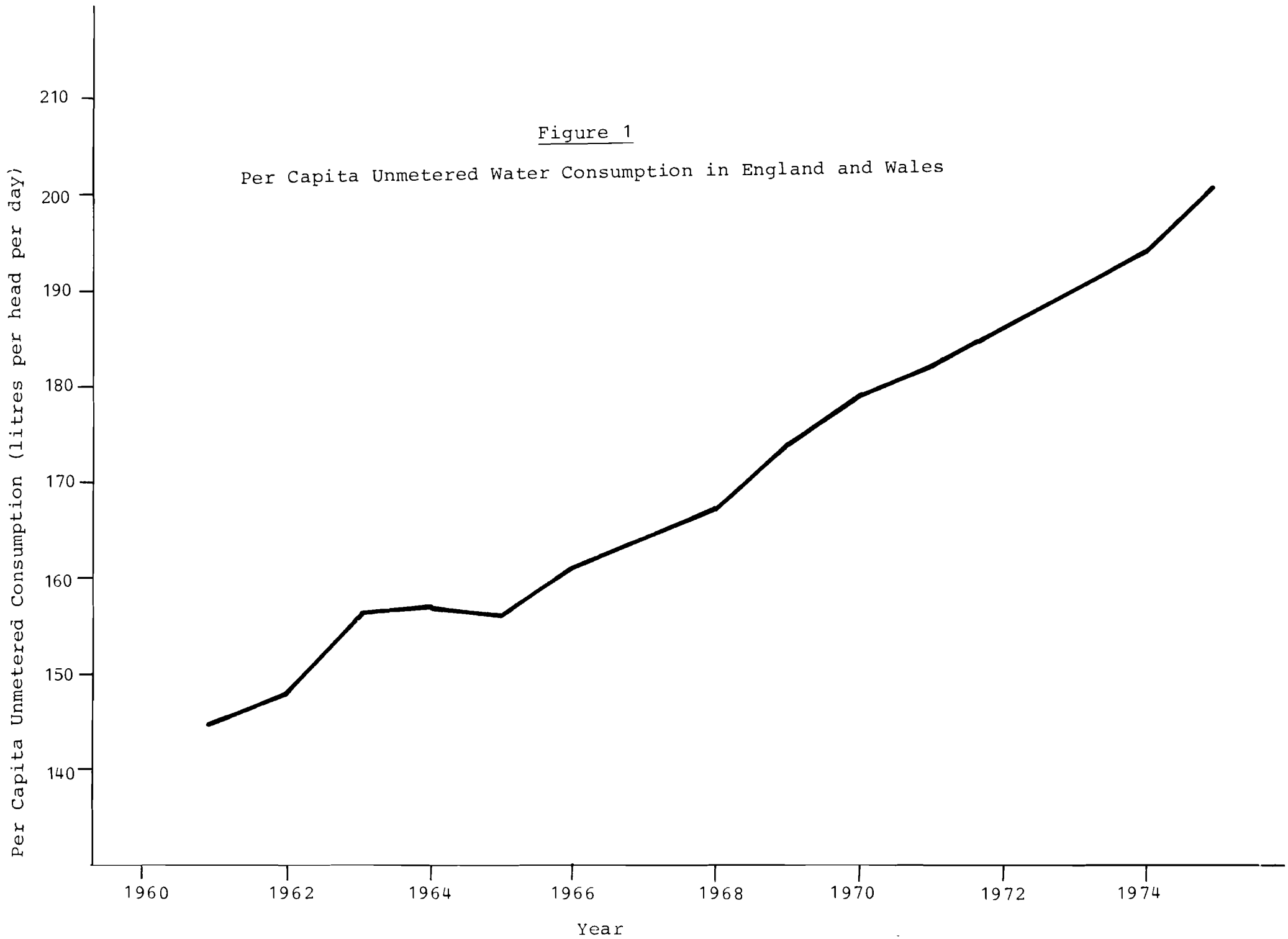

One approach has involved regression analysis to relate annual figures of per capita unmetered consumption to a number of social and economic variables. It seems that the most significant explanatory variables are average household size, summer rainfall, and the numbers employed in service industries (which frequently receive unmetered supplies). Average household size has in the past been correlated with average disposable income, and this explains why there was no income variable included in the "best" equation.

A few Water Authorities are now conducting experiments which involve metering a number of individual domestic properties, the aim being to improve our understanding of how water is used within the home at the present time. Information on annual household consumption in two small areas is available from earlier research, and regression analysis was used in an attempt to establish the relationship between household consumption and the ownership of various water using appliances and amenities. The results were not very satisfactory, because it became clear that those households with more appliances also tended to use more water for basic purposes such as washing and cleaning. In the regression analysis this additional basic use was attributed to particular appliances and amenities, such as dishwashers and motor cars. The more recent experiments therefore involve the use of diaries, in which households are requested to keep records of their water using activities. On the whole I feel that the research being undertaken on household water consumption is adequate in the light of present needs for demand forecasts.

Figure 2 shows that the trend in metered consumption has not been as consistent as that in per capita unmetered consumption. In particular, in 1975 consumption was no higher than in 1969, whereas during the 1960's consumption rose consistently. Since 1970 industrial production has not risen as fast as it did previously, but it has risen. Therefore the change in trend in metered water consumption cannot be attributed wholly to a change in trend in industrial production. Clearly trend analysis is a totally inadequate method of providing demand forecasts in this situation and therefore regression analysis was used in an attempt to explain the past trends better than did time alone. The most significant explanatory variables proved to be Gross Domestic Product and the numbers employed in service industries. However, it must be emphasized that correlation does not prove causation, and it could be mere coincidence that the trend in employment in the service sector changed in about 1970.

There is clearly a need to examine metered consumption further, for example to establish which industries account for the apparent change in trend. The need to examine which industries are the most important water users is even greater in the case of the direct abstractions because records of the volumes abstracted were not collected until the late 1960's, and there are no worthwhile statistics at the national level

Figure 2

Metered Consumption from Public Water Supplies in England and Wales

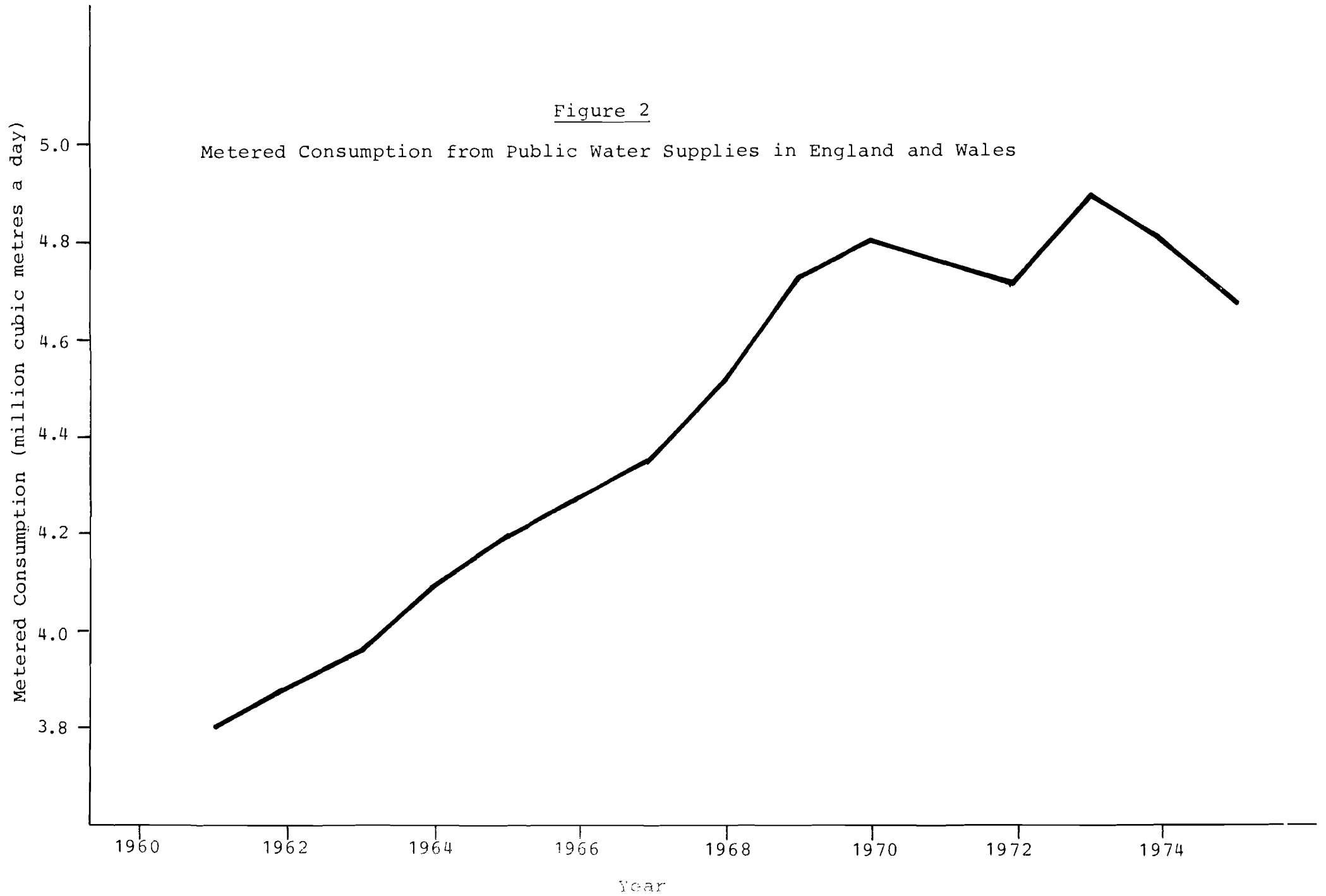

before about 1970. However, neither the direct abstractions nor the metered consumption figures are broken down into industrial groupings, and therefore we are not able to say with any precision how much water is used by particular industries. It is hoped that this deficiency will be put right within the next few years.

*It would seem that progress is most likely to be made by detailed study of water use within individual industries.* However, the only studies of this type which have been undertaken so far have not been as helpful as might have been hoped. Studies have covered textiles, food processing, and a number of industrial groupings in South East England. Regression analysis was used to try to explain why water use per ton of output differed between firms. Very little of the variation could be explained, suggesting that the differences were largely random, perhaps attributable to lack of knowledge of alternative technology or to lack of interest among management because the cost of water is so low in relation to total costs.

In view of our lack of knowledge of industrial demands it is my view that the Central Water Planning Unit would be quite interested in modelling industrial processes to determine which factors influence water demands and what their effects may be. However, I feel that the scope may be somewhat limited. Firstly, there is the problem of identifying a process. For example, in the food industry study 13 product groups were identified, with relatively few firms in each, and within each product group the manufacturing processes and technologies used were diverse. Secondly, even if a homogeneous product (e.g. ammonia) can be identified, for forecasting purposes we need to know how firms will react in the short run, (given the equipment which they are at present operating,) to such events as changes in price or effluent standards. To do this will require a good deal more data than was necessary for the Houston model, which concentrated on new plant. It is my feeling that, *given the lack of data at present, any modelling of industrial demands in the United Kingdom will take some considerable time.* Appropriate consultations will have to take place, suitable products will have to be chosen for study and the necessary data will have to be collected. I cannot foresee any results becoming available within the time period envisaged by IIASA, (i.e. 12 months or so).

In this presentation I have concentrated on explaining the modelling of water demands with a view to improving demand forecasts. This does not imply that my interest is confined to forecasting "requirements". When planning supplies within a river basin it is necessary to examine the impact of a number of policy options, and it is most important that demand models should show how the various options (e.g. different pricing policies, effluent standards, effluent charges, regional industrial policies etc.) affect the demand for water. *This will require the integration of supply and demand models.* The

first step appears to me to be the development of models describing river flows, taking into account all abstractions and discharges. As the demands in such a model are increased, in line with demand forecasts, it is possible to determine when new works are necessary to maintain an acceptably low level of risk of failing to meet demands. However, it is then essential to introduce a "feedback" mechanism into the model, to estimate the cost of meeting the increment in demand and to determine whether charges based on these costs would reduce demand and render the new works uneconomic. The estimated costs will have to include not only the costs of new works but any additional costs imposed on other abstractors. The problems of introducing all the "feedbacks" and of building a self-optimizing model, taking account not only of quantity but also of quality, are formidable when there are a large number of abstractions and discharges, but such a model must be the ultimate aim. However, this sort of inter-active model cannot be developed without *good demand models which show how consumption will change in response to various prices, regulations, technological innovations and so on.* It may be premature to think in terms of building sophisticated demand-supply models, until we have good demand models and good supply models. The former we still do not have; the supply models I am not competent to judge because of my limited knowledge of hydrology.



# METHODS OF FORECASTING WATER USE IN HUNGARY

by

Joseph C. Csuka  
National Water Authority  
Budapest, Hungary

## 1. Introduction

The prominent problem in current water management is the rapid increase of water use and the extensive pollution of water resources virtually all over the world. This trend may be observed in Hungary as well, where the natural conditions under which water management is performed are in general poorer than in the majority of European countries. The increase and concentration of water use has led to the exhaustion of local resources, focussing attention on comprehensive water management planning extending to large area units, on the evolution of complex major projects, as a consequence of which the water resources projects of ever growing areas are merged into integrated systems. These circumstances call for the concentrated and proportional development of all elements of the water resources systems, for which perspective planning is an essential prerequisite. No such planning is conceivable unless the water use and the perspective use, in particular, can be estimated.

A feature characteristic to the structure of water use in Hungary is that *determination of domestic and industrial water uses is of basic importance for proper management of the groundwater resources*. These water use categories represent almost 70 percent of the water uses relying on groundwater resources. Concerning rational allocation of surface water resources, prediction of industrial and agricultural water uses is of outstanding importance, these being responsible for 98 percent of the total water requirements to be covered from surface water resources. Consequently, attention has been concentrated on developing the methods of forecasting water uses of population, industry, and agriculture.

The forecasting is concerned with water uses arising at the level of national or regional economy and is influenced by a number of indirect factors which are difficult to trace. The factors influencing the magnitude of water use affect the individual water use categories and it is their resultant which controls water use at the level of regional or national economy. It follows therefrom that the methodological prerequisite of preparing a sound forecast is the development of an aggregation scheme of water uses in which the interrelation of parts and the whole, namely of individual consumers and of water use in the national economy, is guaranteed.

In developing the aggregation schemes of water uses, two considerations must be remembered:

- The proper relationship and harmony must be established between the forecast and the statistical data base, the forecast and water management planning categories, and further between the forecast covering different time ranges.
- Provisions must also be made for interrelating the different aggregation levels of consumers.

With regard to the foregoing considerations, development of a multi-level scheme (hierarchical organization) is desirable, in which complete aggregation between the different levels is possible.

## 2. Water Use Forecasting at the National Level

Water management lays foundations for a very broad sphere of economic activities and social functions. Water and the services related thereto form an integral part of many factors contributing to economic growth and the increase of production. Economic development thus reflects the level of water management services but it is the resultant of a large number of factors simultaneously controlling economic growth. Consequently, the methods to be applied must represent the specific influence of water management on economic growth, determining the water volumes required in terms of the economic objectives.

*The economic relationships between water management and the individual sectors of the economy can be analyzed with the help of the sectorial input-output balance. The sectorial input-output balance (AKM) displays the flow of products between the individual sectors, specifically the distribution of products produced in each sector among the other sectors, further the sectorial ratios between production, accumulation and consumption. The determination is based on input-output analysis extended to the productive sectors. In the input-output balance mutually interdependent activities are coordinated so that the analysis presents the proper basis for dimensioning the scope and extent of water management activities with regard to the interrelations with other sectorial activities.*

*In the national economy planning system, water management is an independent sector and has a corresponding statistical system. The inputs and outputs of water management can thus be incorporated into the sectorial input-output balances. On the basis of such balances available for different periods, analyses can be performed for longer periods as well, primarily concerning the production coefficients, specifically on the changes of the inverse quantities  $(E-A)^{-1}$  formed therefrom.*

In this way the impact of changes in final consumption on the outputs of the individual factors can also be estimated.

As a result of research work, *the sectorial input-output balance of water management is available in Hungary, in which water management is resolved into the following spheres of activity:*

- Production and distribution of drinking water,
- Production and distribution of industrial water,
- Removal and treatment of wastewaters,
- Agricultural water uses,
- Runoff control, including storage, flood control, and other damage aversion,
- Other water management activities.

On the basis of the national sectorial input-output balances, present research is directed at the development of regional balances for the entire country.

The problems of input-output analysis are due to the stationary character of the coefficients and especially to the great number of data needed. The later presents difficulties especially in compiling the balance of inter-regional relationships.

#### Forecasting Water Withdrawals Using a Regression Model

The use of water resources increases with economic growth. It will be perceived that in countries with a high specific water use the growth rate of total fresh water use is lower than in the countries having a small specific water use.

The relationship between water use and the main factors affecting it has been analyzed using the data from 32 countries. The regression equation is:

$$W = 2,66 \cdot \text{GNP}^{0,305} \cdot \text{PO}^{0,250} \cdot \text{IR}^{0,069}$$

where: W = total withdrawals (m<sup>3</sup> per capita/year)  
GNP = gross national product (\$ per capita, as market price of 1971)  
PO = population (thousands)  
IR = irrigated area (percentage of total arable land)

The standard deviation of the estimates of the regression coefficients will be minimal if the pairs of independent variables are uncorrelated. This, however, is but rarely satisfied in practice, where pairs of the variables are commonly correlated. The effect thereof in estimation is known as multicollinearity. Since with an increasing number of variables at a fixed number of observations, the danger of

multicollinearity increases also in the application of regression models, it appears important to select properly the number of variables. This may be accomplished by combining factor and regression analysis, from which important information may be derived concerning the reduction of the number of variables and for deciding which variables should be included in the analysis.

### Possibilities of Optimal Infrastructural Analysis

By creating specific conditions for a broad sphere of social activities, water management may be regarded as an organic part of the infrastructure.

In the interest of economic development, the infrastructure must be developed in proportion to the productive investments. This is demonstrated by the fact that in all countries infrastructural investments make up a considerable percentage of the total investment.

The close relationship between economic development and the infrastructure is demonstrated also by the fact that infrastructural standard of countries is ordered very much in accordance with their economic development.

The analysis of the optimal ratio between infrastructural and productive expenditures in water management is based on the fact that the productive and the infrastructural investments are related on a *substitutionary basis*. Concerning economy as a whole, the objective is that increasing production in the directly productive sectors should be attainable at the lowest possible cost, including the resources devoted to direct productive activities and to infrastructural purposes alike. *The aim is consequently to determine the optimal combination of productive and infrastructural investments and operating cost with due allowance for the exploratory character of infrastructural development by which favorable opportunities are created for economic activities.*

### 3. Water Use Forecasting at the Regional Level

Models applied for the regional forecasting of water use cover a broad sphere of various factors affecting direct and indirect water use and research is directed primarily at the determination of these factors. The fundamental difference between the individual models is whether the forecasting problem is related to demands of productive or non-productive character.

Research related to the forecasting of *domestic water use* is directed at the identification of factors which can be distinguished and classified according to the development level of human settlements. Analytical methods taking these factors

into account have received growing attention. *Economic problems assume significance mainly at supply levels attaining or surpassing per capita water use of 100-200 l/day, since water uses in this range are already responsive to prices.*

The water use of population is associated with settlements, whereas within each settlement different categories of water use (industrial, municipal, agricultural, etc.) may be observed simultaneously.

Concerning the simultaneous occurrence of different water use categories within a particular area, two possibilities can be distinguished:

- a. The separate forecasting of individual categories of water use and the combination thereof for the region.
- b. The identification of certain settlement types for which the ratio of the individual categories of water use or the per capita water use can be estimated.

*The determination of the supply standards corresponding to the development level of human settlements is the primary current research objective.*

The sphere of productive sectors includes industry and agriculture.

In the forecasting models of *industrial and agricultural water demands*, water is considered to be one of the important production factors and the magnitude of water demand is estimated by analyzing the optimal pattern of production factors. The studies are aimed, on the one-hand, at the determination of the water volume needed technologically, on the other at the examination of the extent to which economic units operating under different conditions convert this technologically needed water volume into water demand.

In the regional forecasting models allowance is made also for the fact that the *stochastic character of the hydro-meteorological factors introduces random variability in the water demands* and decision concerning the magnitude of these demands must incorporate the risk resulting from uncertainty.

The complicated dependence of water demands on various production factors direct attention towards systems analysis. These controlling factors are explored and the interdependence between them is determined by a regression model, by factor analysis or by the heuristic auto-organized algorithm (GMDH, Group Method of Data Handling) by A.N. Ivahnyenko.

Once the system is explored and described, a *simulation approach* is also used. One trend of research in Hungary is

directed at the formulation of a simulation model by which the expected water demand could be forecasted on the basis of economic considerations.

Another domain of research is concerned with the *analysis of production functions*, in view of the fact that water is one of the production factors needed for creating a final product and is consumed proportionately to the other production factors.

MODELLING OF WATER DEMANDS--  
A REVIEW OF SWEDISH EXPERIENCES

by

Gunnar Lindh

Department of Water Resources Engineering  
University of Lund, Sweden

1. Introduction

In view of the fact that I received an invitation to this Workshop from the Swedish Committee for IIASA rather late, it has not been possible for me to discuss the whole problem with that Committee. Moreover, I have not had the opportunity to make a complete overview of studies performed on modelling of water demands and related problems in Sweden. Therefore, my presentation here should be considered my personal opinion rather than an official Swedish view about the problem. However, before entering discussion on the needs of modelling water demands in Sweden, I think it may be appropriate to say something about Swedish water problems and the main directions of Swedish water-oriented research.

There are two facts that may serve as key words in introducing the Swedish water situation. One is that Sweden uses less than 5% of the total runoff and the other is that Sweden rather early confirmed an Environmental Protection Act. This Act is in effect since July 1, 1969 and it covers practically all kinds of environmental disturbances that may be caused by industrial, municipal, agricultural or private activities and installations. Thus, as far as water is concerned, the Act applies to the following operations:

"The discharge of water, solid matter, or gases from land, buildings or installations into water courses, lakes or other water bodies and the use of land, buildings, or installations in a manner that may otherwise cause pollution of water courses, lakes, or other water bodies".

Turning back to the rather small water use we may say that Sweden is favored by a relative degree of wealth in water in relation to its population. This is due more to the low population than to high potential resources--on the average 22.000 m<sup>3</sup> per year and per capita. This is one order of magnitude more than in most European countries. However, the main portion of water resources is located in the northern half of Sweden, whereas 80% of the population lives in the

southern one-third of the country. It is also remarkable to see how well Balcerski's categorization fits for the Swedish water conditions. According to Balcerski less than 5% water use should imply that:

"Possibilities for covering water needs are favourable. Interference for increasing natural water resources is required only at places with particularly concentrated requirements".

It just happened in southern Sweden that the transfer of water from a lake outside of the southern provinces in order to provide some cities with additional water has brought about a very active debate. This debate is caused by different opinions about the validity of the forecasts made. Without taking sides, the discussions have resulted in a demand for a thorough investigation of water resources, especially ground-water resources, which have been so far estimated very roughly only. One more thing of importance was noted during this dispute about water transfer, namely a very rapid increase of water use for irrigation. The reason for this rapid increase was a series of dry years in southern Sweden. This irrigation problem acquired a special character because farmers in these dry areas invested heavily in irrigation equipment. These farmers will certainly press for a rapid solution to this water conflict. Also entering the debate, however, is the conflicting situation in southern Sweden where in some parts the groundwater withdrawal for irrigation is of the same order of magnitude as the withdrawal for municipal use.

Because of the Environmental Protection Act an extensive development work has been going on with regard to water quality management within Swedish industry. This has resulted in a substantial reduction of the industrial water withdrawals. *Recent data show that water use by Swedish industry has been reduced by one-third in the last three years.*

Another interesting feature in the Swedish water situation is the observed fact that *future water use in urban areas will not increase in accordance with the earlier forecasts.* Studies recently made show that the increase will be much lower than originally forecasted, and that perhaps water use will approach a saturation level soon. Some of the reasons are as follows:

- a) the domestic water use will reach a saturation level because sanitary systems are more or less fully developed,
- b) the industrial water uses should not increase in proportion to the production volume since water saving and recycling processes are being developed,
- c) there are very substantial possibilities of decreasing losses in the distribution systems.



Even if the reduction of water use is taken into account, the process of on-going urbanization will increase the stress on local water resources in the southern part of the country, especially when considering the rapidly increasing use of water for irrigation. As mentioned before, this pertains to that part of the country which is less favored with regard to water availability.

By this introduction I have given a snapshot--of course extremely incomplete--of the present water situation in Sweden. The aim was only to focus on some essential and characteristic features of the Swedish situation.

## 2. Swedish Water Problems in the Perspective of the IIASA Workshop

In order to respond more precisely to the three objectives mentioned in the invitation letter by Dr. Kindler, I think it would be advisable to start by *reviewing very briefly the character of water problems being studied in Sweden*. In this description I will deliberately exclude some topics which are traditional aspects to any water problem (such as storm water runoff in urbanized areas, etc.) and deal mainly with those aspects unique to Sweden. The situation may be described in the following way.

- A. A *study of global water problems* has been going on for a considerable time. However, these studies logically direct themselves to problems connected to water shortage with special emphasis on regions where such a shortage occurs. Some of these studies were initiated as a reaction to the unjust view of global water problems taken, for instance, in the preparatory work carried out before the World Population Conference in Bucharest in 1974. For this conference the Swedish delegation prepared a special document "Impact of Water Resources on Population". It was, to some extent, based on a paper published in the international journal "Ambio", *How Can We Cope With the Water Resources Situation by the Year 2015*. Next step in this series of activities was the publication of a book, *Water for a Starving World*, issued as information for the UN Water Conference held in Mar del Plata, Argentina, this year. The report, *Resources-Needs-Problems*, was also prepared for this conference at the request of UN and IFIAS (International Federation of Institutes of Advanced Studies). It gives a global view of the water resources/water use situation and discusses the problems of today.
- B. Another project of an international scale may also be mentioned here. This is the joint scientific undertaking of UNESCO and the Department of Water Resources Engineering, University of Lund, namely preparation of

a state-of-the-art report for the Workshop on "Socio-economic Aspects of Urban Hydrology". This workshop was held in November, 1976 at the University of Lund.

- C. In order to give examples of some water studies at the national level, let me mention some projects going on at the Department of Water Resources Engineering, University of Lund, although they do not deal precisely with mathematical modelling of water demands. However, two research projects with definite links to this topic have just been started. The first project, financially supported mainly by the Committee for Future Oriented Research, is concerned with description and overview of the problems and conflicts emerging in the use of Swedish water resources (introductory phase). The study should be interdisciplinary but with main emphasis on socio-economic problems. In the next phase of this project, detailed studies will be undertaken on specific problems that are regarded as important in the overview. The project is essential in view of the increasing competition between different water uses in Sweden, especially between domestic, recreational and agricultural uses as was mentioned above. Part of the study is financed by the Swedish Agency for Research Cooperation with Developing Countries. This fact makes the study relevant not only to the situation in Sweden but also in developing countries, primarily East Africa and Southern Asia.

The second project is a study of the water resources planning in Swedish municipalities. The specific problems here concern firstly how to incorporate water planning within the overall physical planning and, secondly how to bring the municipal water planning in conformity with the planning of the whole drainage basin, i.e. who should actually be responsible for water resources utilization within the basin. The project is essentially a case study of the community of Uppsala, situated north of Stockholm in an area with intensive agriculture and thus quickly rising use of water for irrigation, i.e. an area similar to that of southern Sweden. The project is financed by the Swedish Council for Building Research.

- D. In addition to what has been said hitherto, it should be mentioned that an ad hoc working committee at the Royal Academy of Engineering Sciences has been established with the aim to consider a wide range of water problems, possibly including also the question of modelling water demands.

### 3. Cooperation With IIASA

After these introductory remarks on related research do not although, as I have already said, exactly focused on the subject of this Workshop, I would like to give the following comments. The consulting work performed for UNESCO has taught us a lot about water demands. In principle, I agree with the comments on the Workshop goals as expressed by Dr. Kindler in his introductory remarks. I especially think it could be of a certain interest to develop similar models for water-intensive industries in our country or alternatively to develop such models for agriculture and municipalities. The choice must depend on the possibility of obtaining the necessary input data. In principle, I think it will be difficult to collect such data. Apart from this fact, I think that it would be preferred to make such modelling studies on municipal and/or agricultural water demands just because of the existing competing and conflicting needs for water in many regions. But according to my opinion, and I think this is also the opinion of the Swedish Committee, such modelling should be based on better understanding and closer consideration of the social aspects of these problems. *As far as I can see, the analysis proposed here is based only on economic considerations.* In Dr. Kindler's paper we read that:

"It must be ascertained that the amount of water allocated to individual users is the least costly alternative mean for achieving certain social, environmental, and economic objectives".

Everything seems to be incorporated in this sentence but I still would like to see a much more thorough analysis of the concepts in the sentence quoted, for instance, consideration of "social well being", "quality of life" or the "good life". This is a request that moves your proposed work a little bit closer to the real society. Apart from these remarks I agree with your way of structuring the work.

One more general remark may perhaps be introduced, because this remark in some respect supports the idea of studying water demands. In Sweden there is new trend in solving water use problems which says that water use should not be related to the water resources but to the real demand. This is, of course, a philosophy emerging from the ethical view of water management implying no waste of a scarce resource.

As a consequence of what I have said, I think *Sweden may be interested in doing some sort of a national case study.* Such a study should then be performed on a regional or local basis. According to my own opinion, thereby referring to what I have said earlier, the work must be undertaken as a multi-disciplinary work including contributions from water resources engineers, economists, ecologists, sociologists with interest in water sciences, in order to guarantee that the modelling

work should be adopted by those who are really concerned with the matter. This way some sort of immediate transfer of knowledge would also be imbedded in the solution of the problem. I support the idea of holding a workshop meeting in the fall of 1977 and I suppose that Sweden wishes to be represented at that meeting.

#### 4. Swedish Research Institutes to Cooperate With

I have already told you about rather extensive work going on at the Department of Water Resources Engineering, Lund Institute of Technology at the University of Lund. In this Department there is also a special working group on mathematical models. This group mainly deals with hydrodynamic flow processes and their solutions by numerical methods. But I think the competence of this group is sufficient to start working also on some problems related to modelling of water demands.

There exists also a joint experience among the members of the Committee on Hydrology, the Swedish National Research Council in Stockholm, as well as in the ad hoc committee established by the Royal Academy of Engineering Sciences, also in Stockholm.

There are, of course, many departments at the Swedish universities working on various optimization and other related problems but according to my opinion IIASA should establish collaborative ties in Sweden with a group working primarily on water problems.

#### 5. International Working Group Supporting the IIASA In-house Research

Let me suggest that contacts will be established between IIASA and the Department of Water Resources Engineering, Lund Institute of Technology, University of Lund, Fack 725, S-220 07 Lund, Sweden.

REFERENCES

- de Mare, L., *Resources, Needs, Problems*, (An assessment of the world water situation by 2000), Department of Water Resources Engineering, University of Lund, Report No. 3002, Sweden, 1976.
- Falkenmark, M. and G. Lindh, *Impact of Water Resources on Population*, submitted by the Swedish Delegation to the UN World Population Conference, Bucharest, 19-30 August, 1974 (Stencil).
- Falkenmark, M. and G. Lindh, *Water Resources and Society in Different Regions*, (in Swedish), Committee for future oriented research, Stockholm, 1976.
- Falkenmark, M. and G. Lindh, *Water for a Starving World*, Westview Press Inc., Boulder, Colorado, 1976.
- Lindh, G., *Socio-economic Aspects of Urban Hydrology*, (A state-of-the-art report), UNESCO, 1976, (Stencil).



# MODELLING OF WATER USE IN FINLAND

by

Pentti Yletyinen

The Association of Finnish Cities  
Helsinki, Finland

## 1. Introduction

This paper gives a brief summary of research carried out in Finland concerning the forecasting of water use. The following groups are discussed: water use by agriculture, industry, and communities. Emphasis is placed upon water use by communities whereas water use by agriculture and industry are discussed very briefly.

*No comprehensive models of water demand have been developed in Finland.* However, some interesting factors worth considering in modelling of water use by communities have been found. Also some ideas about factors to include into modelling of their forecasts have been suggested. Finally, some research institutes, which are directly involved with or are able to organize or contribute to research concerning modelling of water demands are presented.

## 2. Agriculture

J. Hooli (1971) is one of the basic research publications concerning the fundamentals of irrigation water demand in Finland. In this publication, variances of yields have been analyzed with selective regression analysis. From the results, water need during growth seasons, for example, may be determined. An English summary of the investigations with some referred figures is available at IIASA. Also some efforts to determine optimal water demands have been done in Finland and other Scandinavian countries. Several institutes have been identified in the last section.

## 3. Industrial Water Use

An inventory of water consumption by industry in Finland has been done in J. Kytö (1974). The summary of this publication and some additional figures are available at IIASA.

Because of energy prices and the need for more effective environmental pollution control, *specific consumption of process*

water has been estimated to have decreased (Committee Report, 1980). Decreasing is slow, because the modernization of old processes, and building new industry is rather slow. However, total consumption of process water because of expansion of industry will perhaps increase. SITRA (Finnish National Fund for Research and Development) has estimated the maximum increase of water consumption to be 5%/year (in 1960's 9%/year) (SITRA, Series B, No. 2). This would increase present consumption up to 30 mln. m<sup>3</sup>/day in 2000. Probable total water consumption has been estimated to be 6-7 mln. m<sup>3</sup>/day in 1980, 7-8 mln. m<sup>3</sup>/day in 1990, and 8-9 mln. m<sup>3</sup>/day in 2000 (Committee Report, 1980). Forest industry will decrease its water consumption of 5.6 mill. m<sup>3</sup>/day (1970) to 4.8 mill. m<sup>3</sup>/day (1980). Cooling water consumption has been evaluated to increase at the most 4%/year. This means consumption of 5 mln. m<sup>3</sup>/day in 1980 and 7 mln. m<sup>3</sup>/day in 1990 (J. Kytö, 1974).

#### 4. Water Use by Communities

##### Hourly variations of water use

Estimates of hourly variations are needed for dimensioning water supply systems. Their modelling is of extremely great importance in controlling water supply systems.

An inventory of hourly variations in Finnish municipalities has been done in Liimatainen and Virta (1974). The summary with some additional results are available at IIASA.

The first trials of modelling hourly consumption variations are beginning in the Helsinki city waterworks. The modelling will probably be based on analysis of time-series.

##### Daily variations

Estimates of daily variations are needed mainly for dimensioning treatment plants, pipes and tunnels. Modelling of daily consumption is needed for long-term control of water supply.

Some data of inventory concerning daily variations of Finnish communities are given in the report by Liimatainen and Virta (1974).

##### Forecasts of water use

###### (a) Present water use in Finland

Some rough data about water use by communities have been given in Table 1. Increase of specific consumption has stopped during the last years, and is averaging about 330 l/inh/d. Specific consumption has been in the last years about 370 l/inh/d in towns, 280 l/inh/d in boroughs, and 250 l/inh/d in rural communities.



Table 1. General information about public water supply in Finland<sup>1</sup>

	1971	1972	1973	1974	1975
Population (1,000 inh)	4,639	4,641	4,670	4,694	4,716
Number of waterworks	648	670	705	731	761
Population served by waterworks (1,000 inh)	2,715	1,840	2,986	3,082	3,181
Population served \$	59	61	64	66	67
Specific consumption l/inh/d	315	335	333	329	328
Total consumption (m <sup>3</sup> /s)	9.9	11.0	11.5	11.8	12.1
Groundwater supplies (m <sup>3</sup> /s)	3.2	3.6	3.9	4.2	4.5
Investments (mln.Fmk) <sup>2</sup>	243	250	250	250	330

<sup>1</sup>The data will be published by the National Board of Waters.

<sup>2</sup>Investments in public waterworks, which serve more than 200 people.

(b) General aspects

Still at the beginning of 1970's forecasts of specific consumption were based on projections of past trends. This has given rather good results as far as water use was an uncontrollable commodity. However, during the last years many factors have begun to control water demands. Many waterworks and agencies have begun to give information about possibilities of reducing consumption, and *reduction of consumption by different means is a widely approved policy. This may be understood very well, because water and wastewater charges are rising rapidly as a consequence of increased energy costs, increase of labor and chemical costs, and of heavy investments needed to supply water from distant sources.* In addition to charges and information, new technical measures have also been sought and tried to reduce consumption. For these reasons when modelling water demands they should be considered highly controllable by different policies and actions of decision makers.

(c) Projections

*Projections of water use in Finland have been mainly based on simple regression time series. Perhaps most interesting is the paper of J. Lignell (1975), which describes water use as an integrated moving average time series process. The application of this method to real data is under work.*

- (d) Importance of dimensioning water use (R. Piippo, 1976 and Tsubari et al., 1974).

*Water pressure reduction* can reduce water consumption of dwellings by 1/3 to 1/2. In a study done in the city of Espoo, water pressure of a real property was reduced by 1.8 to 3.3 kp/cm<sup>2</sup> so that minimum pressure was 0.5 to 0.7 kp/cm<sup>2</sup>, and influence of this pressure reduction on water consumption of the dwellings (175 inhabitants) was measured. Water consumption was reduced by 25 to 35% (this lowered lining costs by 0.25 Fmk/m<sup>2</sup>/kk).

*Sanitary installations* are one of the main factors when considering domestic water consumption. New regulations for dimensioning these installations in Finland were issued in 1976 by the Ministry of the Interior, i.e. their dimensioning discharges have been reduced by 10 to 70% compared with previous ones. The impact of new regulations on water use was studied in the city of Vaasa. Here, research was carried out in 1972 and 1973 by comparing the consumption rate in two sets of new homes. In one set, installations were dimensioned according to the new regulations, and in the other, the dimensioning of installations were in accordance with the old regulations. Water consumption was 40% smaller in the first set of homes than in the latter (see Table 2).

Table 2. Results from Vaasa 1\*

	Specific consumption l/inh/d	
	1972	1973
Dimensioning according to new regulations	170	163
Dimensioning according to old regulations	290	293

\* Inhabitants were not informed about the possibilities of reducing consumption in either case. New regulations most probably will begin to cause reduction of water consumption as soon as their application proceeds.

## 5. Some Factors Which Should Be Considered When Forecasting Water Demand of Communities

### General

Because of many controlling features forecasts should be divided into proper sub-consumptions of total specific consumption. The main sub-consumptions could be, i.e. domestic consumption, consumption by industry supplied by public waterworks, public consumption, consumption by waterworks, and leakages.

### Sanitary installations in buildings

In addition to the increase of the number of sanitary installations changes in their dimensioning and technology also have great influence on specific water consumption. Some examples may be mentioned:

- WC flushing water can be reduced from 9 l to 5-6 l, thus reducing this type of consumption by 35 to 40%,
- conventional showering needs on an average only 20% of the water needed for a bath. Changes of shower size and dispersion of showers may reduce their water consumption very significantly,
- substituting air cooling for water cooling in dwellings.

### Washing machines and dishwashers

*An increase in the number of dishwashers and washing machines will decrease water use. It has been estimated that handwashing consumes 1.3 to 3.0 times more water as compared to water consumption of a washing machine. The relation is similar for dishwashers.*

### Dimensioning of water supply systems

The influence of water pressure on water consumption has been discussed previously. Considering the importance of pressure in forecasts is very difficult. It is still more difficult to consider possibilities of reducing pressure in homes.

### Charging policy

Water and sewage charges have become high in many industrialized countries and have begun to influence the demand for water. Their influence has been studied insufficiently so far. *Especially the following is unknown: when does the influence of a charging policy begin and what is the elasticity function between water price and water demand?*

The study of the influence of progressive charges on water consumption would be of especially high importance for charging policy decisions.

The structure of the model should allow for the inclusion of many different pricing policies, *because in many countries decisions on prices are done by politicians.*

#### Water meters

Individual metering will reduce water use by 10 to 30% compared with collective metering.

#### Number of users in consumption unit

When the number of consumers in a consumption unit (as a rule family size) increases, specific water consumption will decrease.

#### Information

Information about the possibilities of reducing water use may have significant influence on specific consumption, and thus control water use to a great degree.

#### Other factors

When temperature exceeds a certain level it begins to increase water use because of increased demand for cooling, washing, bathing, et al.

Reuse of water may have significant important on water consumption. This has been used by industry, but some possibilities exist also in homes. One possibility is to use bathroom water for WC flushing.

Careful maintenance of sanitary installations may reduce leakages. Small pipelines increase water velocity in pipes thus reducing scaling and sedimentation, and reducing the need of their washing. The latter is dependent on dimensioning principles of water supply systems.

#### Cost aspects

The following estimation about savings achieved by the reduction of water use has been given in R. Piippo (1976): (1) water use may be reduced by about 30%, which lowers the cost of water and sewer works immediately by about 5% and after a while by about 15%; (2) reduction of water use in dwellings will save immediately 0.20 to 0.40 Fmk/dwelling - m<sup>2</sup>/month.

## 6. Identification of Present Research and Possible Case Studies

Helsinki Metropolitan Area Water Company could be an extremely interesting possibility for a case study. Address: Dir. V. Saari, Nuijamiestentie 5 B, 00400 Helsinki 40, Finland.

Turku Area Water Company could be a very good case study. The area includes rapidly growing communities, which have to build a 50 km long pipeline or tunnel in the 1980's. The area includes 230,000 inhabitants and 5 communities. Address: Mr. T. Laaksonen, Halistentie 4, 20540 Turku 54.

Helsinki City Waterworks: Modelling of hourly consumption variations. Address: Dir. Dr. Seppo Priha, Pasilankatu 41, 00240 Helsinki 24.

National Board of Waters: Forecasts of water use by industry. Address: Prof. S. Mustronen, Pohj. Rautatiekatu 24, 00100 Helsinki 10.

Helsinki University of Technology: 1) Forecasts and optimal demand of irrigation in Finnish conditions; 2) Forecasts and optimal demand of irrigation in Nordic conditions; 3) Application of integrated moving average model to real forecasting problems. Addresses are as follow: 1) Prof. Jussi Hooli, Helsinki University of Technology, Dept. of Civil Engineering, 02150 Espoo 15, Finland; 2) The aforementioned or Dr. Johanson, Institute for Hydroteknik, Landbruksshögskolan, S-75007 Uppsala 7, Sweden; 3) Mr. M. Tuominen, Helsinki University of Technology, General Department, 02150 Espoo 15, Finland.

Confederation of Finnish Industries: Water demand by industries. Address: Mr. Aarno Kavonius, Eteläranta 10, 00130 Helsinki 13, Finland.

The Association of Finnish Cities: 1) Water use and demand as a controllable commodity; 2) General forecasts of water use in Finland.

## 7. International Working Group

Perhaps three sub-groups are needed:

1. Water use/demand in agriculture;
2. Water use/demand in industry;
3. Water use/demand in municipalities.

If Finnish researchers may be nominated into the sub-groups, the following persons could be suggested:

1. Prof. Jussi Hooli for sub-group 1; and
2. Mr. Rauno Piippo for sub-group 3.

The aforementioned persons could also be approached to try to organize contributing research in Finland: Prof. Hooli on irrigation and Mr. Piippo on the possibilities of controlling municipal water use/demand.

REFERENCES

- Committee on Financing of Water Pollution Control and Water Supply, Committee Report 1980: B 118.*
- Hooli, J. (1971), *Effect of Weather on Water Economy and Crop Yields*, Helsinki University of Technology, Publication 35, Helsinki, in Finnish with English Summary.
- Kytö, J. (1974), *Intake and Use of Water by Industry*, National Board of Waters, Finland, Report 71, Helsinki, in Finnish with English Summary.
- Lignell, J. (1975), *Mathematical Models in Forecasting*, Seminar Paper, Helsinki University of Technology.
- Liimatainen, J., M. Virta. (1974), *Variations of Water Consumption*, YVY-research 2, Helsinki.
- Piippo, R. (1976), *Reduction of Water Consumption-Savings in Energy and Living Costs*, LVI 2, in Finnish.
- SITRA*, Environmental Pollution and Its Control, *SITRA*, Series B, 2, in Finnish.
- Tsubari, J., et al. (1974), *Reduction of Water Consumption*, *SITRA*, YVY-preliminary research, E 10, *SITRA*.

# REVIEW OF ACTIVITIES ON WATER RESOURCES PLANNING AND WATER DEMANDS MODELLING IN THE NETHERLANDS

by

H.J. Colenbrander  
Bureau of the Committee  
for Hydrological Research, TNO  
The Hague, The Netherlands

## 1. Introduction

### 1.1 General Aspects

Living in the Delta of the rivers Rhine, Meuse, and Scheldt, from an historical perspective, nearly the only problem for the Dutch was to protect their habitat against high floods and to drain the excess water as soon as possible. Water scarcity was almost an unknown problem at that time.

In the last few decades or so the situation, however, is noticeably altered. Besides the mentioned problems, nowadays one has to be aware also of shortages of water. *In accordance with the growth of population and industry the water demands have increased considerably.*

The main water consumers are e.g., household, industry, agricultural, cattle breeding and recreation. Finally, an important and typical Dutch "consumption" must be mentioned namely, the amount of fresh water needed for combating salt water intrusion. The quantities of water involved are mentioned in Table 1. In this table also water supplies are indicated. It should be stressed that the table presents total amounts for an average year around the year 2000. In dry years the situation is far less favourable. During such periods shortages do occur in many parts of the country, particularly in agriculture. Therefore, a careful distribution of the available water is necessary. In doing so, quite a number of constraints must be taken into account. These are set by the environment (hydrobiological and terrestrial constraints), shipping, recreation, water level control in urban areas, etc.

The difficulties arise not only because there is a real shortage of water but especially because the surface waters have become heavily polluted.

From Table 1 it becomes clear how important the rivers Rhine and Meuse are for the water management in the Netherlands.

Table 1. Forecast of water needs and water supplies for an average year around the turn of the century.

Water Needs ( $10^9 \text{ m}^3$ )		Water Supplies ( $10^9 \text{ m}^3$ )	
Domestic and industrial use	6.6	River Rhine	69
Water level control and artificial water supply to agricultural lands	3.3	River Meuse	8
Flushing polder areas (water quality control)	12.2	Smaller streams	3
Combating salt intrusion on the New Waterway	9.3	Precipitation minus evatranspiration	10
Total needs	31.4	Total available fresh water	90

The water demands in the Netherlands are, however, not only met by surface water but huge quantities of ground water are also extracted to meet human needs. In 1974,  $635 \times 10^6 \text{ m}^3$  are extracted from groundwater and about  $500 \times 10^6 \text{ m}^3$  by industry.

It has meanwhile become clear that especially in high water tables as are prevailing in the Netherlands, the surface and the sub-surface water systems are closely inter-related. Any intervention in one of these may affect the other. This means that an integral plan for water resources management has to be prepared.

## 1.2 Planning of Water Resources Management

The integrated physical planning in the Netherlands dates from January 1972 when the Minister of Housing and Town and Country Planning (physical planning) charged an interministerial commission to prepare a master plan for the future town and country planning.



In this framework it becomes necessary that each section of government prepares master plans for the subjects coming under their competence in close cooperation with all the ministries concerned. The sectional plans together create the possibility for a well-founded governmental policy in economic, social and environmental respects and for the decision in what way town and country planning has to be developed as to minimize the number of conflict situations.

The master plan for future domestic and industrial water supply is one of the sectional plans and will be described afterwards. Also the plan for combating water pollution will be discussed. In the last section the institutions and services dealing with the research and preparation of these plans will be mentioned.

Until now, however, neither a master plan for agricultural water supply nor an overall plan for the total water resources management exists in the Netherlands.

## 2. Plans for Drinking and Industrial Water Supply<sup>1</sup>

### 2.1 Structural Outline Plan

The Structural Outline Plan for Drinking and Industrial Water Supply is compiled by the Ministry of Public Health and Environmental Hygiene and the National Institute for Water Supply (RID).

Nearly 100% of the population of the Netherlands is connected to public water supplies. The main problems in water supply are to be found in the execution of projects for the storage, treatment and transport of water. The importance of the Structural Outline Plan for drinking and industrial water supply is that the defining of areas for projects of the Structural Outline Plan forms a framework in which the water industry can select the right projects and execute them in a responsible way.

The Structural Outline consists mainly of:

- a forecast of future water consumption up to the year 2000;
- a survey of water resources;
- government policy regarding public water supply;
- a survey of possible future water supply projects; and
- a survey of the procedures leading to the preparation and adoption of plans on the various levels.

The estimated water consumption of population and industry (including self-production by industry) for the year 2000 is about 4000 million m<sup>3</sup> per year for an expected total population of 15.4 million.

---

<sup>1</sup>Based on the reports: Long Term Planning of Water Supply and Structural Plan for Domestic and Industrial Water Supply. The Basis for Long Term Policy (V.N. Water Conference).

For comparison, it should be mentioned that the total water consumption in 1974 was about 1700 million m<sup>3</sup> per year, of which about 100 million m<sup>3</sup> were supplied by public water suppliers. These figures do not include the use of surface water for cooling purposes. At present the total population of the Netherlands is 13.4 million.

Owing partly to the sudden economic recession and partly to the charges on industrial effluents which were introduced some years ago, *there is a tendency towards a reduced rate of industrial water consumption.*

The forecast of water consumption extends over a period of thirty years and is of a rather rough character. This is not a substantial obstacle to the purpose for which the Structural Outline Plan is compiled.

The water resources for the water supply given in the Structural Outline Plan are mainly the fresh groundwater and surface water of the Rivers Rhine and Meuse. The total available groundwater is estimated, on the basis of regional studies, at about 1900 million m<sup>3</sup> per year. At the moment, public water supplies use about 630 million m<sup>3</sup> groundwater per year. Industry uses about 500 million m<sup>3</sup> groundwater per year, half of which is used as cooling water. As far as surface water for drinking and industrial water supply is concerned, the discharge characteristics of the Rivers Rhine and Meuse and the extent of their pollution determine the scale of works which are necessary for the storage, purification and transport of water.

The essentials of the Structural Outline Plan for Drinking and Industrial Water Supply are summarized in a number of conclusions which form in their totality the policy guidelines of the Dutch Government regarding public water supply.

Some important conclusions deal with water management in general. It is stated for example that water management in the catchments of the Rivers Rhine and Meuse has to ensure the availability of water in terms of quantity and quality. *In another important conclusion it is laid down that groundwater has to be used as far as possible only for domestic water supply and certain industries for which high quality water is an essential condition.*

Other conclusions deal with the promotion of the economic use of water, the development of advanced water treatment techniques, the protection of groundwater against pollution, the distribution of different qualities of water for industry, water tariffs, the aggregation of waterwork companies in larger units and the adoption of procedures for a good and timely consideration of all interests involved.

The purpose of the Structural Outline Plan is to ensure the water supply of the Netherlands in the future. This makes

its necessary to protect certain areas which will be necessary for implementation of the future projects. The exact determination of the boundaries of such an area is not so essential during this stage. Priorities are set up in the Structural Outline Plan by making a differentiation between projects which have to be realized in the short term (up to 1980) and projects which will be realized in the longer term (1980-2000).

Finally, the Structural Outline Plan deals with procedures for the preparation and adoption of different plans. The Structural Outline Plan is subject to the statutory procedures of the so-called key planning decision. This is an extensive procedure of advice and participation of interested parties. The Structural Outline Plan is then brought into Parliament for discussion.

Furthermore, a bill concerning the adoption and realization of specific water supply projects for the catchment, storage, infiltration and transport of water in the Ten Year Plan is announced in the Structural Outline Plan.

Another aim of this law is to avoid the realization of other projects which are not in agreement with the Structural Outline Plan or the Ten Year Plan.

## 2.2 Ten Year Plan

The Ten Year Plan is the realization of the policy guidelines of the Structural Outline Plan for the next ten years. The Ten Year Plan makes a selection of projects to be actually built for catchment, storage, infiltration and transport of water. The structure of the Ten Year Plan can be compared with the Structural Outline Plan. Because of the shorter planning period the Ten Year Plan is, and has to be, formulated in a more concrete way. The forecasts of water consumption can be given more precisely and the survey of potential water supply projects in the Structural Outline Plan are replaced by a water catchment and distribution plan.

The Dutch Waterworks Association (VEWIN) has created five Regional Standing Committees for setting up the Ten Year Plan. These Regional Standing Committees include representatives of waterworks, the Dutch Waterworks Association, the National Institute for Water Supply and the Provincial Planning and Water Management Authorities.

## 2.3 The Organization of Planning

Previous sections indicated the importance of the Structural Outline Plan and the Ten Year Plan and indicated the lines along which different plans have to be prepared

and adopted. The planning process is indicated schematically in Figure 1. It is obvious that while certain aspects of physical planning and water management determine policy guidelines for public water supply planning, these aspects actually prevade the whole planning process. The schematic diagram in Figure 1 indicates the relationship between the engineers preparing the plans and the politicians and administrators who evaluate and adopt the plans. The left hand part of the scheme is mainly technically oriented, the right hand part of the scheme is purely administrative where the role of the engineer is limited to the presentation, the advocacy, and finally the adaptation of the plan.

At the origin of all activities are in fact the five Regional Standing Committees which are set up by the Dutch Waterworks Association (VEWIN) in cooperation with the National Institute for Water Supply (RID). Changes and new developments are noticed here first and communicated to other levels. The Regional Standing Committees receive data and information mainly from the previously mentioned institutions, regional water industries, and water management services. These data are used for the compilation of the Ten Year Plan and the Structural Outline Plan. In addition, one makes use of results obtained from different commissions and standing committees which are concerned with special studies. The drafts of both the Structural Outline Plan and the Ten Year Plan then follow the procedures described.

#### 2.4 Water Demand Models

The modelling of demands for drinking and industrial water is very complicated. For the Netherlands only a few attempts can be mentioned. This refers to investigations in the towns of Amsterdam and Rotterdam.

Also the Planning Division of the National Institute for Water Supply in cooperation with the Dutch Waterworks Association is active in this field. Inquiries among water consumers and interviews of the most important industries provide the data for the models. However, forecasts of population growth, public consumption, economic and technical development (i.e. recycling) are highly uncertain.

#### 3. Agricultural Water Use

The modelling of water consumption of grassland and arable crops has been given much attention. Models have been prepared simulating the relationship between crop yield, meteorological variables (rainfall, radiation, etc.), available amount of soil moisture, groundwater depth, etc. The situation is quite complicated because the type of soil and the rainfall distribution which are of great importance, are strongly variable.

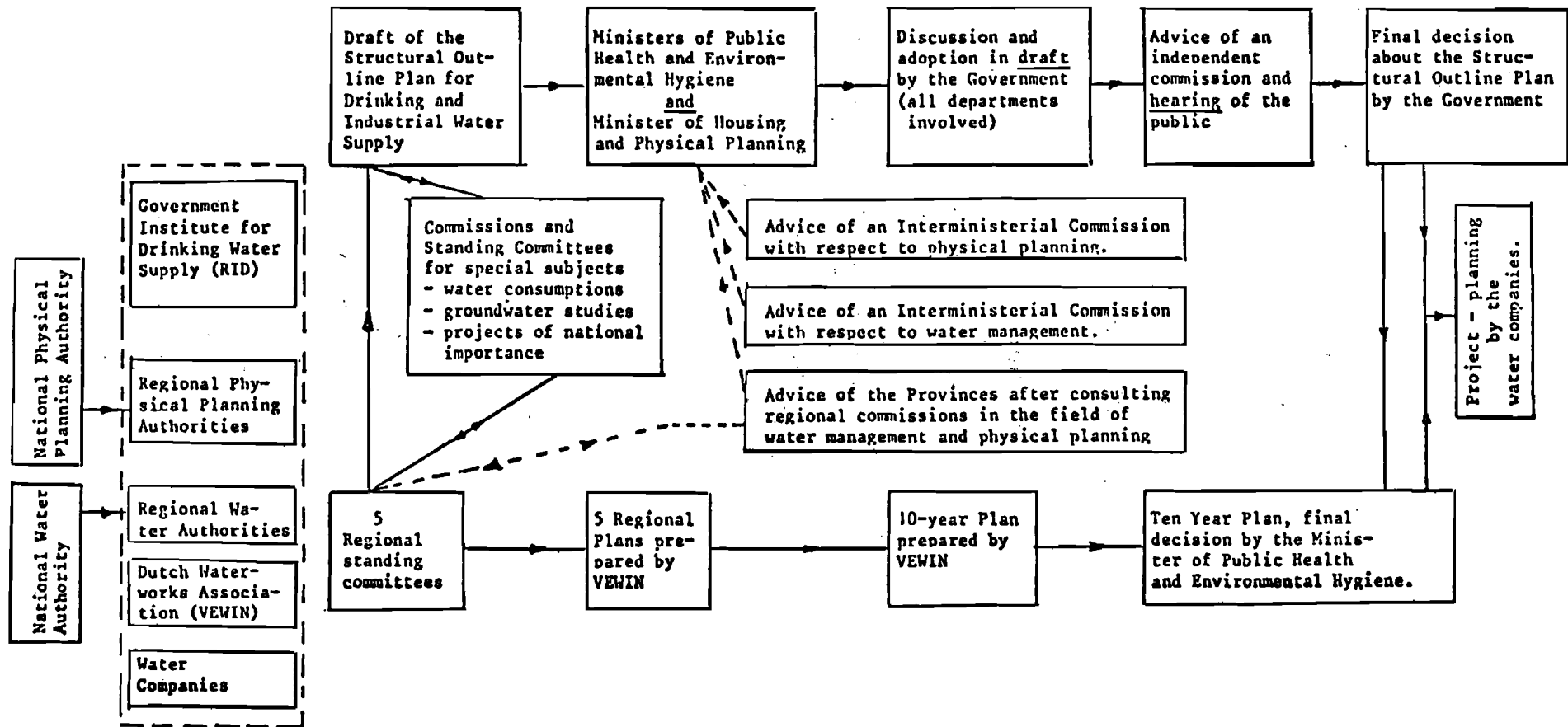

Figure 1  
 Planning activities for public water supply in the Netherlands

Also economic considerations are involved and the actual investment and management costs of various water supply systems have to be studied carefully.

Forecasts have been made on the amounts of water to be supplied artificially in years with dry spells of different magnitude and length. These forecasts, however, have not yet been put together in a national masterplan for water supply in agriculture. Besides grassland and arable crops, much water is also needed in horticulture, particularly in glass-house farming. In this respect, water quality is of an extreme importance.

#### 4. Combat Against Surface Water Pollution<sup>2</sup>

##### 4.1 Introduction

A start was made in the Netherlands some decades ago to take active steps against water pollution. The municipalities and water boards built waste treatment plants, chiefly for the treatment of domestic sewage.

With financial assistance from the government, approximately one thousand million guilders were invested in waste treatment plants during the period up to 1970. The measures taken were, however, insufficient to solve the problem of the increasing pollution of Dutch surface waters. The lack of any statutory regulations or any proper financing scheme represented a great obstacle to an effective solution.

*The Pollution of Surface Waters Act* came into force on 1 December 1970. The introduction of this legislation opened up many legitimate ways of combating water pollution. A sound financial basis was also laid for implementation of the necessary measures.

*One of the principles on which the Act is based is decentralization.* The state is responsible for the management and quality of the larger water bodies such as the rivers Rhine, Meuse and Scheldt, and Lake Yssel and Waddenzee. In principle, the provincial authorities are responsible for the remaining water bodies but they can in turn delegate this to the local authorities. In eight of the eleven provinces, implementation of the regulations became the responsibility of water boards. In the Netherlands, where water management is traditionally a separate branch of the administration, this was quite natural. This meant that in theory favorable conditions were created for linking the quantity of water supply, which had always been the job of the water boards, with the quality. The other three provincial executives have taken it upon themselves to supervise the quality of water. It may be stated that decentralized implementation of the Act has worked very well in practice. In particular, it has allowed for rapid intensification of the anti-pollution measures. However, decentralization also means

---

<sup>2</sup>Based on the report: *The Combat Against Surface Water Pollution in the Netherlands.*

that ways must be found to ensure the necessary coordination and uniformity with regard to planning, granting permits and levying charges.

The necessary organization has already been set up for this purpose. An important element in the coordination is the Five Year Plan.

#### 4.2 Five Year Plan

The Five Year plan is fixed every five years by the Minister for Transport and Public Works in consultation with the Minister for Public Health and Environmental Hygiene. It is not only concerned with policy affecting state waters but its object is to control water pollution all over the Netherlands. The first 5-Year Plan was submitted to the Parliament in February 1975. It contains a program which was drafted in consultation with the regional water authorities.

In addition, it makes recommendations and sets objectives for the control of water pollution in the future. These are intended to serve as guidelines for the local authorities for making their own plans for water pollution control.

The main instruments by which the authorities responsible for pollution control can carry into effect their policies, are:

- permits; these are required for the discharge of all pollutants or harmful substances into surface water;
- prohibitions; the discharge of certain wastes is strictly prohibited. These substances are specified by the Minister for Transport and Public Works in consultation with the Minister for Public Health and Environmental Hygiene;
- charges; *charges are set against the cost of the measures necessary for the abatement and prevention of water pollution.* They must be paid by those who are responsible for discharging pollutants. A charge is payable for the discharge of oxygen consuming wastes in any part of the Netherlands. From 1975 onwards, certain heavy metals will also be subject to a discharge levy.

#### 4.3 Regional Plans

The regional authorities in charge of pollution control are required to draw up plans which should form the basis of their water management.

The pollution control plan should indicate the functions of water in the area concerned and the uses to which it is to be put. It should be remembered that surface waters have a

country-wide character and any physical planning for the development of the area generally must be taken into account.

#### 4.4 Modelling of Water Quality

In the Netherlands, quite a lot of research is done on modelling of the reaction of surface water to different types of pollution. This reaction is mainly determined by the simultaneous occurrence of biological, chemical, physical and hydraulic processes.

The problem arises that water quality cannot be characterized by one specific variable, since various decomposable and non-composable substances finally determine water quality. The models mainly are describing the variation of the oxygen content or Biological Oxygen Demand (BOD).

Some of the institutions working on this type of models are listed in Section 6.

### 5. Water Resources Management Studies

#### 5.1 National Studies

The water demands discussed in the previous sections must be balanced in a National Master Plan for the overall management of water resources. Responsible for the preparation of this plan is the Ministry for Transport and Public Works. The Water Management Department at this Ministry is in charge of the work. At the moment only a water management model exists. This model simulates the main river system in the Netherlands e.g., the river flows, the surface water extractions and the flows at the main outlets (see Figure 2).

The Master Plan for the total water resources management in the Netherlands is still in preparation.

#### 5.2 Regional Studies

In various parts of the Netherlands regional water management studies are carried out. One of these studies is described in Th.J. Van De Nes (1975).

The large-scale and complex character of the water management system necessitates the involvement of many disciplines in the study.

On the one hand, this causes problems of communication between the various disciplines and on the other hand, problems of transfer of knowledge to the management. An attempt has been made to solve these problems with the aid of systems theory,



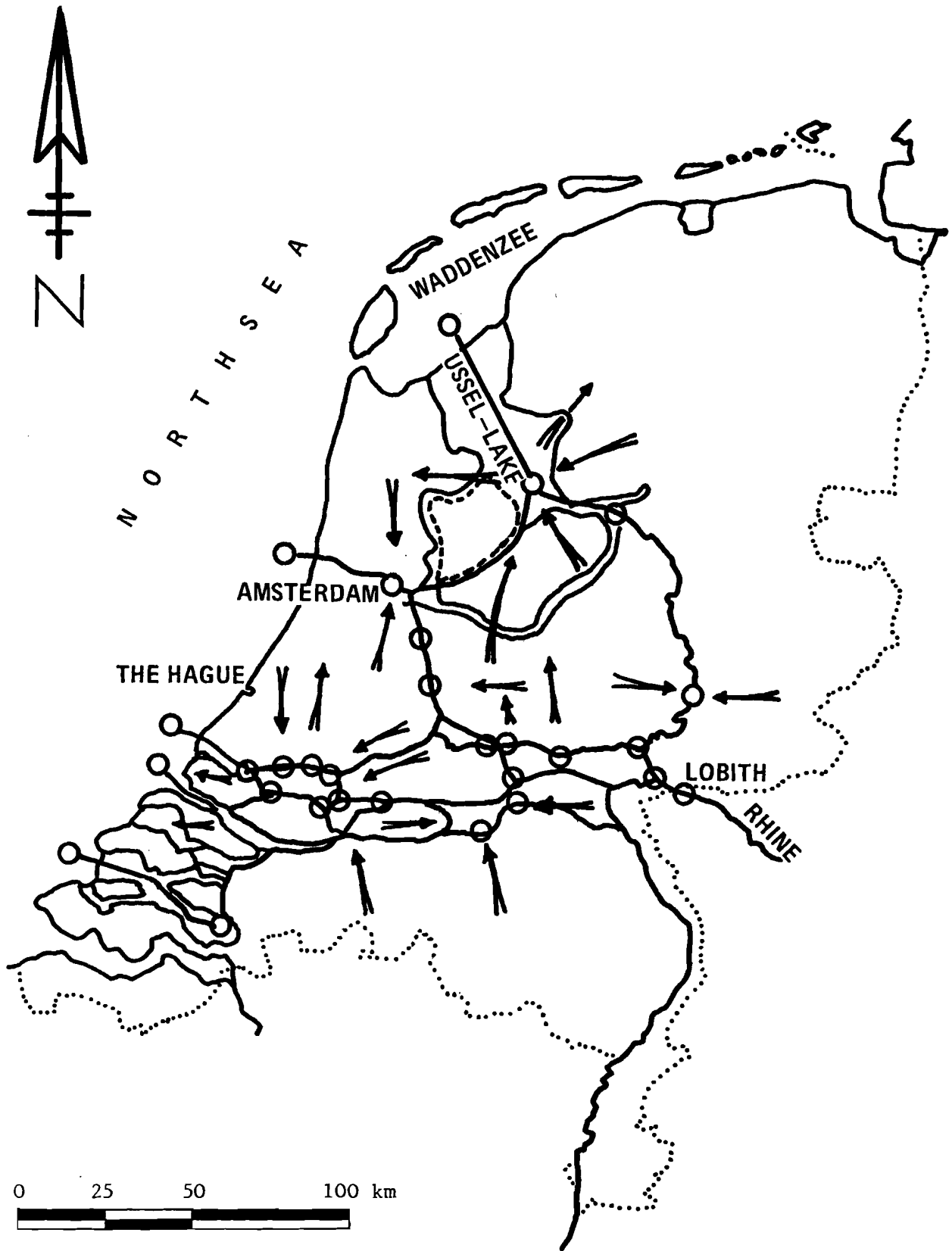

Figure 2

Network for the Water Management Model  
of the Netherlands

where the theory concerning hierarchical problems clearly offered perspectives. This approach enables a complex system to be broken down into a number of subsystems that can be studied individually, without losing sight of their mutual dependence. In this approach, the water resources management system is divided into a number of levels that are studied in different degrees of detail, with the aid of mathematical models. Thus, the complex decision process is divided between various levels, so that it can be solved better. The way in which the results can be used in the planning of water resources management yields an insight into the structure of the decision process. Three types of elements are distinguished:

- social elements (demands of water for various purposes);
- natural elements (the various natural water supplies); and
- artificial elements (technical and administrative measures).

In this research project many institutes, national and regional services are participating. The results of these investigations should also be important for national level investigations.

## 6. Discussion

With respect to the questions put forward by IIASA's Water Demand Group, the following can be said:

### (1) Work to be done at IIASA:

It seems useful that IIASA concentrates its activities on:

- the methodological aspects for balancing various interests in water use;
- the relationship between surface water treatment and the production of drinking water;
- the aspects related to the transfer of water; and
- the coordination of water demand and water supply.

Before starting the research, however, the current investigations of the NMO countries and of other international organizations should be given due attention.

### (2) Institutions with whom to collaborate<sup>3</sup>:

Many institutions and departments in the Netherlands are active in the field of Water Demand Modelling. It is likely that a couple of these will be willing to collaborate with IIASA.

The main institutions dealing with *domestic and industrial water demand* are:

---

<sup>3</sup>The listed names are certainly not complete.

- National Institute for Water Supply (RID);
- Dutch Waterworks Association (VEWIN);
- Waterworks Departments from the cities of Amsterdam and Rotterdam.

Some institutions dealing with *water quality* are:

- Governmental Institute for Wastewater Treatment (RIZA);
- National Institute for Water Supply (RID);
- Delft Hydraulics Laboratory (WL);
- Departments of the Technical University at Delft, Twente, e.o. and the Agricultural University at Wageningen;
- TNO Research Institute for Environmental Hygiene.

Dealing with *agricultural water demand* are:

- Institute for Land and Water Management (ICW);
- Departments of the Agricultural University.

Water resources studies in *general*:

- Public Works Department (Rijkswaterstaat);
- some regional research groups.

REFERENCES

- Dutch Contribution to the VN-Water Conference. (1977), *Structural Plan for Domestic and Industrial Water Supply*, March.
- Knoppert, P.L. (1976), *Long-term Planning for Water Supply*, IWSA Conference, General Report 1, September.
- Ministry for Transport and Public Works. *The Combat Against Surface Water Pollution in the Netherlands*, prospective multi-annual program 1975-1979.
- Sprong, T.A. (1976), *Water Management Model for the Netherlands*, paper presented at the Seminar on Long-term Planning of Water Management, Bulgaria, May.
- Van De Nes, T.J. (1975), *Systems Theory as an Approach to Regional Water Resources Management*, lecture presented during the Technical Meeting No. 32 of the Committee for Hydrological Research TNO, June.

**APPENDIXES**



International Institute for Applied Systems Analysis  
Schloss Laxenburg, Austria

APPENDIX I  
IIASA  
2361 Laxenburg  
Austria  
Tel. 02236-7485  
Telex: 07/9137

WORKSHOP  
ON  
MODELLING OF WATER DEMANDS  
17-21 JANUARY 1977  
LAXENBURG

---

Dear Workshop Participant,

Enclosed is the tentative agenda for our January Workshop on *Modelling of Water Demands* and some background material which fairly well represents the subject matter. There are two main reasons for sending you these publications. First, we hope that by letting you read them before the Workshop, it will be easier to initiate discussion when we meet; and second, to some extent they are representative of publications which we would like you to bring here from your country; should your publications be in your language only, we will try to translate them into English. Most important, we would like to have brief presentations (ca. 15-20 minutes) by all Workshop participants representing IIASA National Member Organizations. If possible, we would appreciate having them structured in such a way that you respond to the three major objectives mentioned in the original invitation letter of 22 October 1976. These objectives were: (1) Review work to be done at IIASA in light of the experiences in each of the NMO countries; (2) Identify research institutions with whom we can establish collaborative ties; and (3) Establish an international working group directly supporting in-house research at IIASA. Written summaries of your presentations (approximately five pages) would enable us to publish the workshop proceedings quickly. The basic idea of the Workshop is to get to know each other, to learn about the others' experiences on the subject matter, and to plan joint investigations.

Before we comment on the Workshop agenda and our plans for the months to come, let us explain briefly our interest in water demands.

Water resources management faces problems of increasing number and complexity. The scope and scale of problems has increased enormously, particularly as a result of the rapid increase in population, the expansion of industry, the growth of urbanization, and the development of new kinds of water demands, notably those in the recreation field. Irrigation may also be expected to become the key issue of water resources development on a world-wide level. Many developing countries plan to initiate or expand large-scale irrigation schemes during the coming decades to ensure the level of food production required by increasing populations. Accompanying these developments has been a very serious decline in water quality, which has had implications for water supply: although relatively large volumes of water may be available, they are often suitable for only a very limited range of uses.

Workshop Participant letter continued

The solution to these problems lies in a shift from the more or less traditional *extensive* approach to the *intensive* one.<sup>1</sup> The former is characterized by a progressive increase in the distance over which water supplies are obtained; as local sources become exhausted, a search for additional water goes further and further afield. New demands for water are met simply by tapping new sources of supply. The engineering schemes, seeking only a technical answer to the shortage problem, characterize this approach. New reservoirs and long-distance water transfer facilities are without doubt the most important methods of extending supplies; but supply extension should not be viewed as the only possible response to prospective water shortage.

The supply-oriented *extensive* approach is in contrast to the demand-oriented *intensive* approach. The objective of the latter is to make the most efficient use of existing supplies rather than to concentrate on the provision of new ones. A variety of strategies is used in this connection, including the imposition of regulations to ensure that water is allocated to its most productive uses, the adoption of water-conserving technologies (such as recycling or evaporation control), and the treatment of wastewaters. Although a number of *demand management techniques* are open to water users, we feel they are not being given sufficient consideration. There are various reasons for this state of affairs, one of them being that water still often is treated as a cheap convenience or free commodity.

In many countries the water laws provide that all major water withdrawals and waste discharges are licensed by the appropriate authorities. In some countries water and wastewater charges are being introduced; however, the efficiency of the allocation instruments is a frequent subject of discussion. Sometimes the charges to the user are not high enough and their effect in curbing water use and waste discharge is minimal. If they are set too high, there might be an unjustified increase in production costs, unnecessarily increasing the cost to the consumer of the final output.

Policies of economic allocation may differ in various countries. What is important, however, is that these policies must always minimize the costs of the bundle of goods needed to fulfill forecast requirements.

These comments are of introductory character only, but we hope they provide sufficient justification for our *demand-oriented* approach to the problem of water management.

As we see it now, the overall goal of our study is to develop a methodology with the aid of which efficient solutions in regional development of water resources can be identified. How does one reach *efficiency* and what is the meaning of this term? First of all, the level of water resource development and the consequent allocation of this resource to various users must be defined, giving due consideration to all *water-substitution* possibilities. It must be ascertained that the amount of water allocated to individual users (allocation pattern corresponding to a certain level of resource development) is the least costly alternative mean for achieving certain social, environmental, and economic (production) objectives.

---

<sup>1</sup>W.R. Derrick Sewell and Leonard Roueche, The Potential Impact of Peak Load Pricing on Urban Water Demands, Victoria, B.C., A case study in *Priorities in Water Management*, University of Victoria, B.C., Canada (1974).



Workshop Participant letter continued

In the enclosed paper by Thompson and Young, the application of demand functions seems to be very attractive for attainment of our study goals. Quoting: "The most important application of demand functions is that they allow alternative projections of water use by systematically varying the factors that influence the demand for water. A second application is that the demand function provides a basis for evaluating whether specific investments in flow regulation or interbasin transfers are justified by the demand for the water that these projects would provide."

As this is what we are interested in, we would like to structure our study in the following way:

- (1) General methodology of derivation of economic demand functions for water. Overview of work completed and some new methodological advances.
- (2) Having in mind both centrally planned and market economies, a review of the different water-using activities from the point of view of applicability of the general concepts of economic demand for water. Selection of water-intensive production processes and activities which are of a decisive character if one is concerned with the efficiency of regional water management.
- (3) Modelling of the selected processes and activities as a means of deriving water demand functions. Overview of the work already completed and if possible some new methodological advances. Plant-level case studies of an illustrative character.
- (4) Modelling water supply. Methodological developments concerning derivation of water supply functions, due regard being given to the temporal and spatial variability of water resources (both surface and groundwater). Case studies of an illustrative character.
- (5) Regional water management analysis through the use of the supply and demand functions. Methodological developments and case studies in both market and centrally planned economies.

It is quite obvious that we will not be able to do all this in-house at IIASA. But if we succeed in attracting the collaboration of you and your associates, or any other group in your country which is interested in promoting the demand-oriented approach in water management, implementation of such a program might prove to be not only feasible but also of considerable value to the IIASA member countries. After some time, it may even evolve into a more general study trying to identify the trade-offs among resource conservation, environmental quality and economic development.

The basic assumption underlying our plans for the January Workshop is that in all IIASA countries there is considerable similarity in the *public policy goals* (in some countries called *government policy goals*) concerning *water conservation and water quality*. By water conservation, we mean economic (efficient, rational) use of water resources. Following discussion of different means of accomplishing these goals, we would like to focus on basic concepts for analysis of: (1) economic demand for water; and (2) economic costs of pollution control (economic demands for waste disposal rights).

Workshop Participant letter continued

Next, we shall concentrate on the methods of analysis. Analytical methods will be illustrated by an example of the electric power generation (see the enclosed paper by Thompson and Young). The programming methods will be illustrated by the detailed presentation of the ammonia model (see the enclosed report by Calloway, Schwartz and Thompson). We would like to make it clear at this point that the ammonia model will be presented primarily as an example of the industrial model which can be used for economic analysis of mutual relationships among waste water effluent standards, costs of water withdrawals (related to supply costs), production costs, effluent taxes, energy use and water use. It will be shown how models of this type can be applied for water demand and waste water policy evaluations.

The most important part of the Workshop will be the discussions. As you can easily note from the attached publications, we have already established working relationships with the University of Houston group led by Professor Russell G. Thompson. The modelling capability developed at Houston will serve as an excellent starting point for our investigations. We want to discuss with you the possibilities of developing similar models for the most water-intensive industries in your countries. This could be done by the appropriate national organizations in collaboration with our group at IIASA. We would like very much that you react to the ideas concerning integration of these models (see the enclosed publications). It should be noted, however, that all of the models presented in the enclosed publications pertain to industrial water use and industrial waste-water effluents. We would like to discuss with you the possibilities of developing similar models for other water-use sectors, especially in agriculture and municipalities. This is necessary if we are eventually going to be concerned with regions where we often encounter a mix of different water uses. Also, the developments of the economic supply functions requires considerable methodological effort. In a number of countries (e.g. USA, Poland, the UK), the concept of the *minimum acceptable flow* is widely used. Probably this question also deserves attention in the general context of our *demand-oriented* study.

The next milestones in our investigations following the January Workshop will be the Working Meeting tentatively scheduled for September 1977 and the International Conference on *Modelling of Economic Demand for Water* to be organized at IIASA in late 1977 or early 1978. We would like very much to discuss with you our plans for these meetings. The most important topic to be discussed will be our collaborative arrangements for 1977. Your suggestions concerning integration of national-level efforts with the overall goals of our study (see the enclosed task description) will be of primary importance.

Although this letter is far from being all-inclusive, we hope it will help all of us to develop mutual understanding and to discuss in-depth the broad spectrum of questions related to our investigations.

Looking forward to seeing you in Laxenburg,

Sincerely,



Dr. Janusz Kindler  
Task Leader

JK/dp  
Encl.

## DEFINITION OF TERMS

The definitions given below are taken from a recent paper on *Forecasts and the Role of Alternative Futures* (ASCE Journal of Water Resources Planning and Management Division, WR 2, November 1976). We kindly request you to review these definitions and check if they properly reflect the definitions used in your language. Even when speaking a common language, economists, engineers, and planners frequently use and understand terminology differently. In an international setting the terminology used is even more critical and demands our special attention as to avoid unnecessary misunderstandings and misinterpretations. The definitions that follow are not expected to completely solve the semantics difficulty and some of them may of course be modified at the Workshop. However, we aim at an agreement on some terms which would enable a basic frame of reference for all Workshop participants and also be used throughout our study.

*Alternative futures* is a term adopted to define a concept that is relatively new. It represents an approach that recognizes that the amount of water used is dependent on the policies each nation chooses to adopt, as well as on socio-economic phenomena and changes in technology. Because of the interrelationships between these factors, we propose to explore uses and supplies in terms of alternative combinations of policies, life styles, socioeconomic phenomena, and changes in technology. These alternative combinations are called "alternative futures".

*Forecasts* designates the estimates of future conditions, including water uses, as well as the water resources expected to be made available to meet those uses. Estimates will be based on evaluations of these conditions in terms of the many factors that affect them. Some professions associate the word "projections" with statistical extrapolations of past trends and, therefore, prefer to use the term "forecasts" for the type of methods that we expect to use. While many workers in the water resources field do not use "projections" in the extrapolation sense, and would not be confused by its use, it seems advisable not to use a term that could be misleading to other people. Therefore, "forecasts" will be used as the general term, and the term "projections" only where it represents an extrapolation of historical trends.

*Water Use* is employed herein as a general term encompassing any use made of water by man. The term is so general that it should be described each time it is employed, such as withdrawal water use, instream water use, forecasted water use, etc. The quantity of water use is highly dependent on policies, lifestyles, socio-economic phenomena, and state of technology; therefore each "alternative future" that represents a different combination of these factors will have a different forecasted "water use". The term has often been used interchangeably with "need", "requirements", or "demand", but such use appears fallacious. The words "needs" and "requirements" are to be avoided, since they have frequently been utilized to describe quantities that people "would like to have" (if they could get it at no cost, or at a subsidized price) rather than the ordinary connotation the reader obtains from these words. "Demand" has a special meaning to economists, different from "water use", as defined later.

*Withdrawals* represent the amount of water physically diverted or withdrawn from a stream or body of water for some use.

DEFINITIONS continued

*Consumptive Use* represents the water consumed by plants, animals, industrial processes, or evaporation. It represents the difference between "withdrawals" and "return flow".

*Return Flow* is the amount of withdrawn water that returns to a stream or body of water, after consumptive uses are satisfied, and which may again be withdrawn if desired.

*Instream Uses* are those uses that may be made of a stream without withdrawing water from it, e.g., navigation, hydro-electric power production, fish and wildlife preservation, water quality management, and esthetics.

*Demand* is used by economists as the quantity of a commodity that would be purchased at a given price. A demand schedule expresses the relationship between various prices and the quantities taken at those prices at a given instant of time. This specialized use has wide currency and consequently the use of "demand" in a general sense is likely to lead to confusion. To avoid any possible confusion, it is proposed that we employ the term "demand" in only those instances in which an economist would use the term.

*Water Resource* is used in the sense of the first definition in Webster, "something that lies ready for use or can be drawn upon for aid". As we will use it, it represents the physical amount of water that is available from natural sources within a given region. Like "water use", the term is so general that it should be described each time it is employed, such as "dependable water resource, surface water resource, groundwater resource, etc."

*Dependable Water Resource* represents the portion of the available water resource that can be depended on for water development, and can be expressed either in terms of total volume or as a volume in a given period of time. Since the "water resource", as defined here, is a natural phenomena, it is highly variable, depending on the time of year as well as from year to year. The basic criteria used to determine the dependability of such "water resource" then becomes critical to any analysis of "water resource-water use" relationships. Some have used the "dependable" resource as being that available in the most critical combination of circumstances of record. Others have used it as that available 90% of the time. Still others have used it as the average amount available, less evaporation losses. Obviously, the "dependable" resource is highly variable, according to the assumptions used. Also, the amount of such resource that is dependable for use at any point in time is affected by the availability of reservoir regulation, return flow, or groundwater. Therefore, the assumption used should be defined when the term "dependable" is used.

*Augmented Sources of Supply* includes the water made available by steps taken specifically to increase the "dependable water resource". It includes such measures as desalting, modification of precipitation, reclamation of wastewater plant effluent by advanced treatment processes, forest management, and interbasin transfers of water.

*Supply* is another term frequently used differently by the economist and the engineer. To the economist it means the amount of water available for purchase at a given price, while the engineer usually uses it as being the virtual equivalent of "water resource". We propose that, when used in our study, it be used as the economist would use it.

IIASA  
WORKSHOP  
ON  
MODELLING OF WATER DEMANDS  
17-21 JANUARY 1977  
LAXENBURG

---

AGENDA

---

- 17 January  
Monday
- 09:30 Registration
- 10:00 OPENING ADDRESS by Dr. Roger E. Levien, Director of IIASA.
- 10:15 Basic concepts and overview of IIASA's research task on *Regional Water Demand & Management*, by Dr. Janusz Kindler, IIASA.
- 10:45 Discussion on Definition of Terms
- 11:15 Coffee Break
- 11:30 *Demand, Supply and Economic Efficiency*, Dr. Anthony C. Fisher, IIASA.
- 12:15 Lunch Break
- 13:30 *Economic Demand for Water and Economic Costs of Pollution Control*, Prof. R.G. Thompson, University of Houston, Texas.
- 15:00 Coffee Break
- 15:30 *Process Modelling Using Linear Programming* (illustrated by a Case Study for Ammonia Production), Dr. James A. Calloway, University of Houston, Texas.
- 18:30 Get-Together at a traditional Austrian Heuriger with dinner and wine.
- 18 January  
Tuesday
- 09:00 Continuation of the presentation by Dr. J.A. Calloway.
- 10:30 Coffee Break
- 10:45 *Systems Analysis Applied to Agricultural Water Demand*, Dr. David R. Maidment, IIASA.
- 11:30 *Regional Water Supply Functions*, Dr. Ilya Gouevsky, IIASA.
- 12:15 Lunch Break
- 14:00 Round-table discussion.
- 15:30 Coffee Break
- 16:00 Continuation of discussion.
- 19 January  
Wednesday
- 09:00 Informal Presentations by Workshop Participants representing IIASA's National Member Organizations
- 12:30 Lunch Break



WORKSHOP  
ON  
MODELLING OF WATER DEMANDS  
17-21 JANUARY 1977  
LAXENBURG

---

PARTICIPANTS

---

Dr. James A. CALLOWAY  
University of Houston  
Houston, Texas 77004  
U.S.A.

Prof. Harold A. CARTER  
IIASA

Dr. Alan CHAMBERS  
Institute of Animal &  
Resource Ecology  
University of British Columbia  
Vancouver, B.C. Canada

Mr. H.J. COLENBRANDER  
Central Organization for  
Applied Scientific Research  
in the Netherlands  
Juliana van Stolberglaan 148  
P.O. Box 297  
The Hague 2076  
The Netherlands

Dr. Joseph CSUKA  
National Water Authority  
Budapest I  
F8-u. 48-50  
Hungary

Prof. Siegfried DYCK  
Technical University  
8027 Dresden  
Mommstr. 13  
German Democratic Republic

Prof. Wladyslaw FINDEISEN  
Institute of Automatic Control  
Technical University of Warsaw  
00-665 Warsaw  
Poland

Dr. Anthony FISHER  
IIASA

Prof. Genady GOLUBEV  
IIASA

Dr. Ilya GOUEVSKY  
IIASA

Dr. Wolfgang GÜNTHER  
Institut für Wasserwirtschaft  
Universität Hannover  
Welfengarten 1  
3000 Hannover  
Federal Republic of Germany

Prof. Charles W. HOWE  
Dept. of Economics  
University of Colorado  
Boulder, Colorado 80302  
U.S.A.

Dr. Istvan IJJAS  
IIASA

Dr. Saburo IKEDA  
IIASA

Dr. Janusz KINDLER  
IIASA

Dr. Aleksander LASKI  
Hydroprojekt, Consulting Engineers  
ul. Swietokrzyska 12  
Warsaw  
Poland

Prof. Gunnar LINDH  
Dept. of Water Resources Engineering  
University of Lund  
S-220 07 Lund  
Sweden

Dr. David R. MAIDMENT  
IIASA

PARTICIPANTS continued

Ing. Quido PARTL  
c/o The Committee for IIASA of the  
Czechoslovak Socialist Republic  
Slezska 9, Vinohrady  
Prague 2  
Czechoslovakia

Prof. Sergio RINALDI  
Istituto di Elettrotecnica  
ed Elettronica  
Politecnico di Milano  
Piazza Leonardo da Vinci, 32  
20133 Milano  
Italy

Mr. Robert J. SMITH  
Central Water Planning Unit  
Reading Bridge House  
Reading RG1 8PS  
United Kingdom

Prof. Antoni SYMONOWICZ  
Institute of Meteorology and  
Water Management  
01-673 Warsaw  
ul. Podlesna 61  
Poland

Prof. Russell G. THOMPSON  
University of Houston  
Houston, Texas 77004  
U.S.A.

Mr. Anton TOIFELHARDT  
IIASA

Prof. Oleg F. VASILIEV  
IIASA

Dr. Alexander VELIKANOV  
Institute of Water Problems  
Academy of Sciences of the USSR  
Moscow  
U.S.S.R.

Prof. Grigory VOROPAEV  
Institute of Water Problems  
Academy of Sciences of the USSR  
Moscow  
U.S.S.R.

Dr. Pentti YLETYINEN  
The Association of Finnish Cities  
Eduskuntakatu 4  
00100 Helsinki 10  
Finland

Dr. H. Peyton YOUNG  
IIASA



International Institute for Applied Systems Analysis  
Resources and Environment Area  
Task No. 1 - Regional Water Demand and Management

Proposed Course of Action, as agreed upon on 21 January 1977  
by the participants in the Workshop on *Modelling of Water Demands*  
(17-21 January 1977)

1. January - October 1977

- (a) In about 2 weeks IIASA will send a letter to each NMO country requesting a report on the country's experience in estimating the different factors affecting water demands and in using these estimates for forecasting future water demands, with particular emphasis on the methods employed in actual planning studies. The letter will outline in more detail the questions which the report should answer (the questionnaire format will be used for reporting). It is expected that these reports will reach IIASA by the end of March.
- (b) Reports will be distributed to all countries of IIASA's NMOs (April).
- (c) IIASA will use these reports and further investigations of its own to prepare a survey on the state of the art, with a view to establishing where good work has already been done and where further progress is necessary. Provisional title of this survey is *Methods for Estimating Water Demands and Wastewater Discharges*. The draft of this survey should be ready by the end of July 1977. It will be distributed for review to all countries of IIASA's NMOs.
- (d) Throughout this period, IIASA will be seeking to extend the industrial methodology developed at the University of Houston with a view to its application in other interested countries and to look towards developing the methodology for integration of supplies and demands in the general framework of water resources management.
- (e) In June 1977, a small group will meet at IIASA to decide on the program of the workshop to be held in October. At that time sufficient information should be available at IIASA to permit the choice of case studies to be made, with a view toward application in two or more river basins such as the Colorado in the US and the Sirdariya in the USSR.
- (f) During this period, IIASA staff will use personal contacts already established to initiate visits and exchanges for further discussion of the subject matter with representatives of the relevant institutions in the countries of IIASA's NMOs.

2. October 17-21, The 2nd Workshop on *Modelling of Water Demands*

- (a) It is going to involve discussion of (i) the draft of the survey (see 1c), (ii) selected case studies reported by countries of IIASA's NMOs, (iii) IIASA's other contributions to the topic.

PROPOSED COURSE OF ACTION continued

- (b) It is hoped to identify areas where IIASA can further develop this methodology leading to further case studies in countries of IIASA's NMOs in 1978.
- (c) It is hoped that the October Workshop will also provide sound illustrative methodology for modelling agriculture and municipal water demands to serve as a base for a program of work on these demands at IIASA.

3. Post Workshop

- (a) The program of further investigations as well as the agenda and format for the Conference originally planned for 1977 (to be held in 1978) will be decided upon at the October Workshop. It is hoped that the national papers (see 1a), to be ready by the end of March 1977, will initiate discussion towards further planning.

International Institute for Applied Systems Analysis  
Schloss Laxenburg, Austria

IIASA  
2361 Laxenburg  
Austria  
Tel. 02236-7521\*0  
Telex: 079137

## MEMORANDUM

**To:** NMO Representatives to the  
Workshop on *Modelling of Water Demands*,  
January 17-21, 1977

**Date:** 9 February 1977

**From:** IIASA Water Demand Group 

**Subject:** Survey on Methods for Estimating Water Demands  
and Wastewater Discharges

The purpose of this memorandum is to provide a general framework for a survey on *Methods for Estimating Water Demands and Wastewater Discharges*.

Increasing demands on water resources suggest the need for better knowledge of the extent, distribution and future evolution of these demands. Following the agreement reached during the First Workshop on Water Demands held at IIASA during the week of 17-21 January 1977, we would like to request that you and your associates spend some time in the next two months to produce a report on the experience and the methods which are used in your country for water demand analysis and forecasting. We shall combine the reports, evaluate the methodologies reported, and carry out a review of the literature available to us.

To have a draft of this survey ready for distribution in July 1977, it is critical that we receive your report by April 15. Of course, we shall fully acknowledge your authorship and participation in the survey. We hope that this joint effort, to be published ultimately in the series of IIASA Collaborative Publications, will prove to be valuable to all of us engaged in water resources development planning. It should also indicate further research needs which will be discussed at the Second Workshop on Modelling of Water Demands to be held at IIASA in October 1977.

Attached is the tentative table of contents of the intended survey. It is still fairly general and if you have any suggestions or comments concerning this proposal please write us at your earliest convenience. It is important, however, that in preparing your report you try to relate explicitly its contents to the proposed contents of the survey. We are fully aware of the fact that due to your background and experience you may be interested in contributing to some selected parts of the intended survey. This is completely understandable; however, please try to invite on our behalf collaboration of other groups and individuals whose participation would broaden the scope of the survey. We would be glad to try to contact such people through your NMO, if you feel this would be desirable.

We understand that you cannot stop all of your present activities and switch to preparation of the report which we are calling for. To be realistic,

Survey Memorandum continued

first of all we would like you to provide us with publications and copies of unpublished reports dealing with the subject matter--sometimes this might be even selected chapters of reports prepared by various organizations involved at different levels in water resources planning in your country. If these materials are unavailable in English, please do not hesitate to send them written in your language. We would appreciate, however, your brief comments on these materials. Probably it is worth stressing again that we are primarily interested in receiving materials which illustrate the *approaches and methods* used in particular countries for estimating and forecasting water demands and wastewater discharges. We are more interested in the *assumptions* upon which the forecast is based and in the *methods* applied, than in the actual numbers describing future water demand in your country.

As indicated in the tentative table of contents, we envision three main sections in each of the chapters 2 to 6. The first section will deal with *methods and models* for estimating and forecasting water demands and wastewater discharges. The second section will deal with *applications* of these methods and models in case studies. The third section will be an *evaluation* of both methods and applications.

We need your help in preparing each of these sections. Specifically, we would like you to address in your report the following questions, with respect to each of the water uses shown in the table of contents.

- (1) What kind of *methods or models* do you use in your country to determine water demands? We would appreciate a brief description of each of these models (publications?).

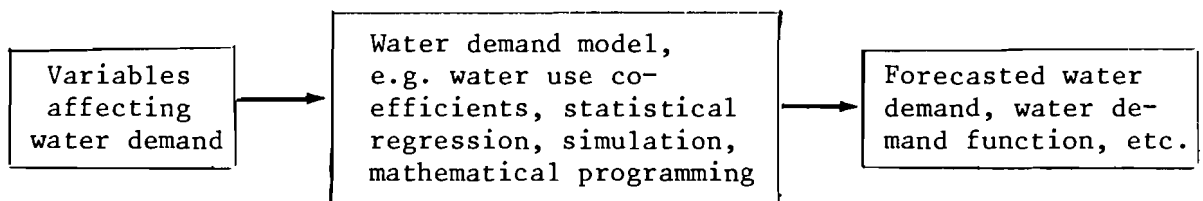

- (2) What applications of these methods and models have been made in your country? We would appreciate a brief survey of relevant case studies, at least of the more important ones.
- (3) What are the practical or theoretical limitations of these methods and models, in your judgment, for estimating water demands and wastewater discharges?

When we have received this material from you, along with copies of relevant publications, in accordance with the agreed "Course of Action" we shall prepare a draft of the survey and send it to you for your further comment and evaluation.

METHODS FOR ESTIMATING WATER DEMANDS  
AND  
WASTEWATER DISCHARGES  
(provisional title)

Table of Contents

Introduction

Chapter 1. Objectives and Scope of the Report.

Chapter 2. Municipalities.

2.1 Methods and Models.

2.2 Overview of applications and case studies.

2.3 Evaluation.

Chapter 3. Industry.

3.1 - 3.3 As above.

Chapter 4. Thermal Power Generation.

4.1 - 4.3 As above.

Chapter 5. Agriculture.

5.1 - 5.3 As above.

Chapter 6. In-stream Uses (Navigation, Hydropower, Recreation, etc.)

6.1 - 6.3 As above.

Chapter 7. Discussion and Conclusions.

